

Quantum process discrimination with restricted strategies

Kenji Nakahira

*Quantum Information Science Research Center, Quantum ICT Research Institute,
Tamagawa University, Machida, Tokyo 194-8610, Japan*

(Dated: December 15, 2021)

The discrimination of quantum processes, including quantum states, channels, and superchannels, is a fundamental topic in quantum information theory. It is often of interest to analyze the optimal performance that can be achieved when discrimination strategies are restricted to a given subset of all strategies allowed by quantum mechanics. In this paper, we present a general formulation of the task of finding the maximum success probability for discriminating quantum processes as a convex optimization problem whose Lagrange dual problem exhibits zero duality gap. The proposed formulation can be applied to any restricted strategy. We also derive necessary and sufficient conditions for an optimal restricted strategy to be optimal within the set of all strategies. We provide a simple example in which the dual problem given by our formulation can be much easier to solve than the original problem. We also show that the optimal performance of each restricted process discrimination problem can be written in terms of a certain robustness measure. This finding has the potential to provide a deeper insight into the discrimination performance of various restricted strategies.

I. INTRODUCTION

Quantum processes are fundamental building blocks of quantum information theory. The tasks of discriminating between quantum processes are of crucial importance in quantum communication, quantum metrology, quantum cryptography, etc. In many situations, it is reasonable to assume that the available discrimination strategies (also known as quantum testers) are restricted to a certain subset of all possible testers in quantum mechanics. For example, in practical situations, we are usually concerned only with discrimination strategies that are readily implementable with current technology. Another example is a setting where discrimination is performed by two or more parties whose communication is limited. In such settings, one may naturally ask how the performance of an optimal restricted tester can be evaluated. To answer this question, different individual problems of distinguishing quantum states [1–5], measurements [6–9], and channels [10–19] have been investigated.

It is known that if all quantum testers are allowed, then the problem of finding the maximum success probability of guessing which process was applied can be formalized as a semidefinite programming problem, and its Lagrange dual problem has zero duality gap [20]. Many discrimination problems of quantum states, measurements, and channels have been addressed through the analysis of their dual problems [7, 16, 19–31]. However, in a general case where the allowed testers are restricted, the problem cannot be formalized as a semidefinite programming problem.

In this paper, we provide a general method to analyze quantum process discrimination problems in which discrimination testers are restricted to given types of testers. We show that the task of finding the maximum success probability for discriminating any quantum processes can be formulated as a convex optimization problem even if the allowed testers are restricted to any subset of all testers and that its Lagrange dual problem has zero duality gap. It should be mentioned that, to our knowledge, a convex programming formulation applicable to any restricted strategy has not yet been reported even in quantum state discrimination problems. In some scenarios,

the dual problem can be much easier to solve analytically or numerically than the original problem, as we will demonstrate through a simple example. Our approach can deal with process discrimination problems in both cases with and without the restriction of testers within a common framework, which makes it easy to compare their optimal values. Note that we use the quantum mechanical notation for convenience, but since our method essentially relies only on convex analysis, our techniques are applicable to a general operational probabilistic theory (including a theory that does not obey the no-restriction hypothesis [32]).

The robustness of a resource, which is a topic closely related to discrimination problems, has been recently extensively investigated. It is known that the robustness of a process can be seen as a measure of its advantage over all resource-free processes in some discrimination task [33–40]. Conversely, we show that the optimal performance of any restricted process discrimination problem is characterized by a certain robustness measure.

II. PRELIMINARIES

A. Notation

Let N_V be the dimension of a system V . $\mathbb{0}$ stands for a zero matrix. Let \mathbb{C} and \mathbb{R}_+ be, respectively, the sets of all complex and nonnegative real numbers. Also, let Her_V , Pos_V , Den_V , Den_V^p , and Meas_V be, respectively, the sets of all Hermitian matrices, positive semidefinite matrices, states (i.e., density matrices), pure states, and measurements of a system V . Let I_V and $\mathbb{1}_V$ be, respectively, the identity matrix on V and the identity map on Her_V . We call a quantum operation, which corresponds to a completely positive map, a single-step process. Let $\text{Pos}(V, W)$ and $\text{Chn}(V, W)$ denote, respectively, the sets of all single-step processes and channels (i.e., completely positive trace-preserving maps) from a system V to a system W . In this paper, a one-dimensional system is identified with \mathbb{C} . Also, $\text{Pos}(\mathbb{C}, V)$ and $\text{Pos}(\mathbb{C}, \mathbb{C})$ are identified with Pos_V and \mathbb{R}_+ , respectively. $H_1 \geq H_2$ with Hermitian matrices H_1

and H_2 denotes that $H_1 - H_2$ is positive semidefinite. Given a set \mathcal{X} in a real Hilbert space, we denote its interior by $\text{int}(\mathcal{X})$, its closure by $\overline{\mathcal{X}}$, its convex hull by $\text{co}\mathcal{X}$, its (convex) conical hull by $\text{coni}\mathcal{X}$, and its dual cone by \mathcal{X}^* . $\overline{\text{co}\mathcal{X}}$ and $\overline{\text{coni}\mathcal{X}}$ are, respectively, denoted by $\overline{\text{co}}\mathcal{X}$ and $\overline{\text{coni}}\mathcal{X}$. x^\top denotes the transpose of a matrix x . Uni_V denotes the set of all unitary matrices on a system V . For a unitary matrix $U \in \text{Uni}_V$, let Ad_U be the unitary channel defined as $\text{Ad}_U(\rho) = U\rho U^\dagger$ ($\rho \in \text{Pos}_V$). Let $\hat{V} := W_T \otimes V_T \otimes \cdots \otimes W_1 \otimes V_1$, where T is some positive integer.

B. Processes, combs, and testers

In this paper, we often use diagrammatic representations to provide an intuitive understanding. A single-step process $\hat{f} \in \text{Pos}(V, W)$ is depicted by

$$\begin{array}{c} V \\ \boxed{\hat{f}} \\ W \end{array}. \quad (1)$$

The system \mathbb{C} is represented by ‘no wire’. For example, $\hat{\rho} \in \text{Pos}_V$ and $\hat{e} \in \text{Pos}(V, \mathbb{C})$ are diagrammatically represented as

$$\begin{array}{c} \hat{\rho} \\ \boxed{\phantom{\hat{f}}} \\ V \end{array}, \quad \begin{array}{c} V \\ \boxed{\hat{e}} \\ \end{array}. \quad (2)$$

Single-step processes can be linked sequentially or in parallel. The sequential concatenation of $\hat{f}_1 \in \text{Pos}(V_1, V_2)$ and $\hat{f}_2 \in \text{Pos}(V_2, V_3)$ is a single-step process in $\text{Pos}(V_1, V_3)$, denoted as $\hat{f}_2 \circ \hat{f}_1$. Also, the parallel concatenation of $\hat{g}_1 \in \text{Pos}(V_1, W_1)$ and $\hat{g}_2 \in \text{Pos}(V_2, W_2)$ is a single-step process in $\text{Pos}(V_1 \otimes V_2, W_1 \otimes W_2)$, denoted as $\hat{g}_1 \otimes \hat{g}_2$. In diagrammatic terms, they are depicted as

$$\begin{array}{c} V_1 \\ \boxed{\hat{f}_1} \\ V_2 \end{array} \begin{array}{c} V_2 \\ \boxed{\hat{f}_2} \\ V_3 \end{array}, \quad \begin{array}{c} V_1 \\ \boxed{\hat{g}_1} \\ W_1 \end{array} \begin{array}{c} V_2 \\ \boxed{\hat{g}_2} \\ W_2 \end{array}. \quad (3)$$

We refer to a concatenation of one or more single-step processes as a quantum process. A process represented by a concatenation of T channels is referred to as a quantum comb with T time steps [41]. States, channels, and superchannels, which are processes that transform quantum channels to quantum channels, are special cases of quantum combs. The concatenation of two single-step processes $\hat{f}_1 \in \text{Pos}(V_1, W'_1 \otimes W_1)$ and $\hat{f}_2 \in \text{Pos}(W'_1 \otimes V_2, W_2)$, denoted by the process $\hat{F} := \hat{f}_1 \otimes \hat{f}_2$ (where \otimes denotes the concatenation), is often depicted as

$$\begin{array}{c} \hat{F} \\ \boxed{\phantom{\hat{f}_1 \otimes \hat{f}_2}} \\ V_1 \quad W_1 \quad V_2 \quad W_2 \end{array} = \begin{array}{c} \boxed{\hat{f}_1} \\ W_1 \\ \boxed{\hat{f}_2} \\ W_2 \end{array}. \quad (4)$$

For a process $\hat{\mathcal{E}}$ expressed in the form

$$\begin{array}{c} \hat{\Lambda}^{(1)} \\ \boxed{\phantom{\hat{f}_1}} \\ V_1 \quad W_1 \end{array} \begin{array}{c} \hat{\Lambda}^{(2)} \\ \boxed{\phantom{\hat{f}_2}} \\ V_2 \quad W_2 \end{array} \cdots \begin{array}{c} \hat{\Lambda}^{(T)} \\ \boxed{\phantom{\hat{f}_T}} \\ V_T \quad W_T \end{array}. \quad (5)$$

with $\hat{\Lambda}^{(t)} \in \text{Pos}(W'_{t-1} \otimes V_t, W'_t \otimes W_t)$, $W'_0 := \mathbb{C}$, and $W'_T := \mathbb{C}$, its Choi-Jamiołkowski representation, which we denote by the same letter without the hat symbol, is defined as

$$\mathcal{E} := (\hat{\mathcal{E}} \otimes \mathbb{1}_{\hat{V}})(|I_{\hat{V}}\rangle\rangle\langle\langle I_{\hat{V}}|) \in \text{Pos}_{\hat{V}}, \quad (6)$$

where $|I_{\hat{V}}\rangle\rangle := \sum_n |n\rangle|n\rangle \in \hat{V} \otimes \hat{V}$. A process $\hat{\mathcal{E}}$ is uniquely specified by its Choi-Jamiołkowski representation \mathcal{E} . $\text{Comb}_{W_T, V_T, \dots, W_1, V_1}$ denotes the set of all $\tau \in \text{Pos}_{W_T \otimes V_T \otimes \dots \otimes W_1 \otimes V_1}$ such that there exists $\{\tau^{(t)} \in \text{Pos}_{W_t \otimes V_t \otimes \dots \otimes W_1 \otimes V_1}\}_{t=1}^{T-1}$ satisfying

$$\text{Tr}_{W_t} \tau^{(t)} = I_{V_t} \otimes \tau^{(t-1)}, \quad \forall 1 \leq t \leq T, \quad (7)$$

where $\tau^{(0)} := 1$ and $\tau^{(T)} := \tau$. Each element of $\text{Comb}_{W_T, V_T, \dots, W_1, V_1}$ corresponds to a comb expressed in the form of Eq. (5) with $\hat{\Lambda}^{(t)} \in \text{Chn}(W'_{t-1} \otimes V_t, W'_t \otimes W_t)$, $W'_0 := \mathbb{C}$, and $W'_T := \mathbb{C}$. For simplicity, we often refer to elements of $\text{Comb}_{W_T, V_T, \dots, W_1, V_1}$ as combs. Note that the Choi-Jamiołkowski representation, ρ , of a state $\hat{\rho}$ is equal to $\hat{\rho}$ itself.

$\text{Comb}_{\mathbb{C}, W_T, V_T, \dots, W_1, V_1, \mathbb{C}}$ is denoted by $\text{Comb}_{W_T, V_T, \dots, W_1, V_1}^*$, which is the set of all $\tau \in \text{Pos}_{W_T \otimes V_T \otimes \dots \otimes W_1 \otimes V_1}$ such that there exist $\tau^{(1)} \in \text{Den}_{V_1}$ and $\{\tau^{(t)} \in \text{Pos}_{V_t \otimes W_{t-1} \otimes V_{t-1} \otimes \dots \otimes W_1 \otimes V_1}\}_{t=2}^T$ satisfying

$$\begin{aligned} \tau &= I_{W_T} \otimes \tau^{(T)}, \\ \text{Tr}_{V_t} \tau^{(t)} &= I_{W_{t-1}} \otimes \tau^{(t-1)}, \quad \forall 2 \leq t \leq T. \end{aligned} \quad (8)$$

Let $\mathcal{C}_G := \text{Pos}_{\hat{V}}^M$ and $\mathcal{S}_G := \text{Comb}_{W_T, V_T, \dots, W_1, V_1}^*$. Each element of \mathcal{S}_G corresponds to a comb expressed in the form

$$\begin{array}{c} V_1 \\ \hat{\sigma}_1 \\ \end{array} \begin{array}{c} W_1 \\ \boxed{\hat{\sigma}_2} \\ V_2 \end{array} \cdots \begin{array}{c} W_{T-1} \\ \boxed{\hat{\sigma}_T} \\ V_T \end{array} \begin{array}{c} W_T \\ \end{array} \parallel \parallel, \quad (9)$$

where $\hat{\sigma}_1, \dots, \hat{\sigma}_T$ are channels (in particular, $\hat{\sigma}_1$ is a state) and “ \parallel ” denotes the trace. An ensemble of processes $\{\hat{\Phi}_m\}_{m=1}^M$ is referred to as a tester if $\sum_{m=1}^M \hat{\Phi}_m$ is expressed in the form of Eq. (9). For each tester element $\hat{\Phi}_m$, Φ_m denotes the Choi-Jamiołkowski representation of the process $\hat{\Phi}_m^\dagger$ (where † is the adjoint operator), i.e.,

$$\Phi_m := (\hat{\Phi}_m^\dagger \otimes \mathbb{1}_{\hat{V}})(|I_{\hat{V}}\rangle\rangle\langle\langle I_{\hat{V}}|) \in \text{Pos}_{\hat{V}}. \quad (10)$$

$\{\hat{\Phi}_m\}_{m=1}^M$ is a tester if $\{\Phi_m\}_{m=1}^M \in \mathcal{C}_G$ and $\sum_{m=1}^M \Phi_m \in \mathcal{S}_G$ hold and vice versa. We also refer to $\{\Phi_m\}_{m=1}^M$ as a tester. Let $\langle \Phi_k, \mathcal{E}_m \rangle := \text{Tr}(\Phi_k \mathcal{E}_m)$; then, we have

$$\langle \sigma, \tau \rangle = 1, \quad \forall \tau \in \text{Comb}_{W_T, V_T, \dots, W_1, V_1}, \sigma \in \mathcal{S}_G. \quad (11)$$

In our manuscript, processes corresponding to elements of \mathcal{S}_G and tester elements are diagrammatically depicted in blue.

III. QUANTUM PROCESS DISCRIMINATION

We first review quantum process discrimination problems where all possible testers are allowed. We here address the problem of discriminating M combs, $\hat{\mathcal{E}}_1, \dots, \hat{\mathcal{E}}_M$, where each

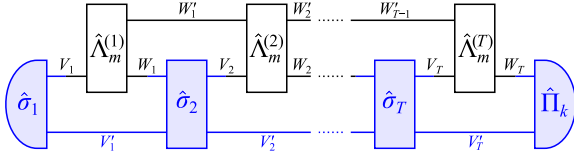

FIG. 1. General protocol for the discrimination of quantum combs $\{\hat{\mathcal{E}}_m = \hat{\Lambda}_m^{(T)} \otimes \dots \otimes \hat{\Lambda}_m^{(1)}\}_{m=1}^M$ (plotted in black) with T time steps, where W_1, \dots, W_{T-1} are ancillary systems. Any physically allowed discrimination strategy can be represented by a tester (plotted in blue), which consists of a state $\hat{\sigma}_1$, channels $\hat{\sigma}_2, \dots, \hat{\sigma}_T$, and a measurement $\{\hat{\Pi}_k\}_{k=1}^M$.

$\hat{\mathcal{E}}_m$ is the concatenation of T channels $\hat{\Lambda}_m^{(1)}, \dots, \hat{\Lambda}_m^{(T)}$ with ancillary systems (see Fig. 1). $\hat{\mathcal{E}}_m$ is expressed by $\hat{\mathcal{E}}_m = \hat{\Lambda}_m^{(T)} \otimes \dots \otimes \hat{\Lambda}_m^{(1)}$. In the particular case where, for each m , $\hat{\mathcal{E}}_m$ has no ancillary system and $\hat{\Lambda}_m^{(1)}, \dots, \hat{\Lambda}_m^{(T)}$ are the same channel, denoted by $\hat{\Lambda}_m$, the problem reduces to the problem of discriminating M channels $\hat{\Lambda}_1, \dots, \hat{\Lambda}_M$ with T uses. For simplicity, we restrict ourselves to the case where each $\hat{\mathcal{E}}_m$ is a quantum comb with $T = 2$ time steps unless otherwise mentioned, but our approach can be readily extended to the case where each $\hat{\mathcal{E}}_m$ is a more general quantum process. As shown in Fig. 1, to discriminate between given combs, we first prepare a bipartite system $V_1 \otimes V'_1$ in an initial state $\hat{\sigma}_1$. One part V_1 is sent through the channel $\hat{\Lambda}_m^{(1)}$, followed by a channel $\hat{\sigma}_2$. After that, we send the system V_2 through the channel $\hat{\Lambda}_m^{(2)}$ and perform a measurement $\{\hat{\Pi}_k\}_{k=1}^M$ on the system $W_2 \otimes V'_2$. Such a collection of $\{\hat{\sigma}_1, \hat{\sigma}_2, \{\hat{\Pi}_k\}_{k=1}^M\}$, which is expressed as $\{\hat{\Phi}_k := \hat{\Pi}_k \otimes \hat{\sigma}_2 \otimes \hat{\sigma}_1\}_{k=1}^M$, can be thought of as a tester. Any discrimination strategy, including an entanglement-assisted strategy and an adaptive strategy, can be represented by a tester¹. Let \mathcal{P}_G be the set of all such testers $\Phi := \{\Phi_k\}_{k=1}^M$, which can be written as (see [41] for details)

$$\mathcal{P}_G = \left\{ \{\Phi_m\}_{m=1}^M \in \mathcal{C}_G : \sum_{m=1}^M \Phi_m \in \mathcal{S}_G \right\}. \quad (12)$$

Note that $\tilde{V} := W_2 \otimes V_2 \otimes W_1 \otimes V_1$ and

$$\mathcal{S}_G := \{I_{W_2} \otimes \tau_2 : \tau_2 \in \text{Pos}_{V_2 \otimes W_1 \otimes V_1}, \tau_1 \in \text{Den}_{V_1}, \text{Tr}_{V_2} \tau_2 = I_{W_1} \otimes \tau_1\} \quad (13)$$

hold. The probability that a tester Φ gives the outcome k for the comb \mathcal{E}_m is given by $\langle \Phi_k, \mathcal{E}_m \rangle$. The task of finding the maximum success probability for discriminating the given quantum combs $\{\mathcal{E}_m\}_{m=1}^M$ with prior probabilities $\{p_m\}_{m=1}^M$ can be formulated as an optimization problem, namely [20]

$$\begin{aligned} & \text{maximize } P(\Phi) := \sum_{m=1}^M p_m \langle \Phi_m, \mathcal{E}_m \rangle \\ & \text{subject to } \Phi \in \mathcal{P}_G. \end{aligned} \quad (\text{P}_G)$$

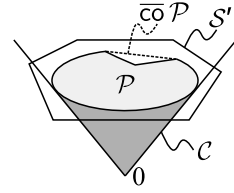

FIG. 2. Schematic diagram of the closed convex hull of \mathcal{P} , which is the intersection of a closed convex cone \mathcal{C} and a convex set $\mathcal{S}' := \{\Phi : \sum_{m=1}^M \Phi_m \in \mathcal{S}\}$.

IV. RESTRICTED DISCRIMINATION

We now consider the situation that the allowed testers are restricted to a nonempty subset \mathcal{P} of \mathcal{P}_G ; in this case, the problem is formulated as

$$\begin{aligned} & \text{maximize } P(\Phi) \\ & \text{subject to } \Phi \in \mathcal{P}. \end{aligned} \quad (\text{P})$$

Let us interpret each tester as a vector in the real vector space $\text{Her}_{\tilde{V}}^M$. This means that one can work with linear combinations of testers $\Phi^{(1)}, \Phi^{(2)}, \dots$; a tester that applies $\Phi^{(i)} := \{\Phi_k^{(i)}\}_{k=1}^M$ with probability q_i is represented as $\sum_i q_i \Phi^{(i)} = \{\sum_i q_i \Phi_k^{(i)}\}_{k=1}^M$. One can easily see that the optimal value of Problem (P) remains the same if the feasible set \mathcal{P} is replaced by $\overline{\text{co}} \mathcal{P}$. Indeed, an optimal solution, denoted by $\Phi^* \in \overline{\text{co}} \mathcal{P}$, to Problem (P) with \mathcal{P} relaxed to $\overline{\text{co}} \mathcal{P}$ can be represented as a probabilistic mixture of $\Phi^{(1)}, \Phi^{(2)}, \dots \in \mathcal{P}$, i.e., $\Phi^* = \sum_i v_i \Phi^{(i)}$ for some probability distribution $\{v_i\}$ ². Since $P(\Phi^*) \leq P[\Phi^{(i)}]$ holds for some i , $\Phi^{(i)} \in \mathcal{P}$ must be an optimal solution to the relaxed problem. Thus, Problem (P), whose objective function is convex by construction, is transformed into a convex optimization problem by relaxing \mathcal{P} to $\overline{\text{co}} \mathcal{P}$. However, this relaxed problem is often very difficult to solve directly.

We find that, for any feasible set \mathcal{P} , each tester $\Phi \in \mathcal{P}$ can be interpreted as an element in some convex cone such that the sum $\sum_{m=1}^M \Phi_m$ is in some convex set. Specifically, we can choose a closed convex cone \mathcal{C} and a closed convex set \mathcal{S} such that (see Fig. 2)

$$\overline{\text{co}} \mathcal{P} = \left\{ \Phi \in \mathcal{C} : \sum_{m=1}^M \Phi_m \in \mathcal{S} \right\}, \quad \mathcal{C} \subseteq \mathcal{C}_G, \quad \mathcal{S} \subseteq \mathcal{S}_G. \quad (14)$$

Such \mathcal{C} and \mathcal{S} always exist³. Equation (12) can be regarded as a special case of this equation with $\mathcal{P} = \mathcal{P}_G$, $\mathcal{C} = \mathcal{C}_G$, and $\mathcal{S} = \mathcal{S}_G$ (note that $\overline{\text{co}} \mathcal{P}_G = \mathcal{P}_G$ holds). Let

$$\mathcal{D}_C := \left\{ \chi \in \text{Her}_{\tilde{V}} : \sum_{m=1}^M \langle \Phi_m, \chi - p_m \mathcal{E}_m \rangle \geq 0 \ (\forall \Phi \in \mathcal{C}) \right\}; \quad (15)$$

¹ For the problem of discriminating quantum channels with multiple uses, several discrimination strategies that make use of indefinite causal order (e.g., [42–46]) are physically allowed; however, this paper does not deal with such strategies.

² Since \mathcal{P} is bounded, $\overline{\text{co}} \mathcal{P} = \text{co} \overline{\mathcal{P}}$ holds.

³ A trivial choice is $\mathcal{C} := \{t\Phi : t \in \mathbb{R}_+, \Phi \in \overline{\text{co}} \mathcal{P}\}$ and $\mathcal{S} := \{\sum_{m=1}^M \Phi_m : \Phi \in \overline{\text{co}} \mathcal{P}\}$.

then, we can easily verify that

$$D_S(\chi) := \max_{\varphi \in \mathcal{S}} \langle \varphi, \chi \rangle \geq \sum_{m=1}^M \langle \Phi_m^*, \chi \rangle \geq P(\Phi^*) \quad (16)$$

holds for any $\chi \in \mathcal{D}_C$. The first and second inequalities follow from $\sum_{m=1}^M \Phi_m^* \in \mathcal{S}$ and $\Phi^* \in \mathcal{C}$, respectively. Thus, the optimal value of the following problem

$$\begin{aligned} & \text{minimize } D_S(\chi) \\ & \text{subject to } \chi \in \mathcal{D}_C \end{aligned} \quad (\text{D})$$

is not less than that of Problem (P). We refer to a feasible solution, χ , to Problem (D) as proportional to some quantum comb if χ is expressed in the form $\chi = \lambda \tilde{\chi}$, with $\lambda \in \mathbb{R}_+$ and $\tilde{\chi} \in \text{Comb}_{W_T, V_T, \dots, W_1, V_1}$. We can see that Problem (D), which is the so-called Lagrange dual problem of Problem (P), has zero duality gap, as shown in the following theorem (proved in Appendix A):

Theorem 1 Let us arbitrarily choose a closed convex cone \mathcal{C} and a closed convex set \mathcal{S} satisfying Eq. (14); then, the optimal values of Problems (P) and (D) are the same.

V. GLOBAL OPTIMALITY

A. Necessary and sufficient conditions for global optimality

Using Theorem 1, we can easily derive necessary and sufficient conditions for an optimal restricted strategy to be optimal within the set of all strategies. Given a feasible set \mathcal{P} , we now ask the question whether the optimal values of Problems (P) and (P_G) coincide. We can derive necessary and sufficient conditions for global optimality by considering Problem (D) with $\mathcal{P} = \mathcal{P}_G$ (i.e., $\mathcal{C} = \mathcal{C}_G$ and $\mathcal{S} = \mathcal{S}_G$), which is written as

$$\begin{aligned} & \text{minimize } D_{S_G}(\chi) \\ & \text{subject to } \chi \in \mathcal{D}_{C_G}. \end{aligned} \quad (\text{D}_G)$$

Since Theorem 1 guarantees that Problems (D) and (D_G), respectively, have the same optimal values as Problems (P) and (P_G), the task is to obtain necessary and sufficient conditions for the optimal values of Problems (D) and (D_G) to coincide. To this end, we have the following statement:

Proposition 2 Let us arbitrarily choose a closed convex cone \mathcal{C} and a closed convex set \mathcal{S} satisfying Eq. (14). Then, the following statements are all equivalent.

- (1) The optimal values of Problems (P) and (P_G) are the same.
- (2) Any optimal solution to Problem (D_G) is optimal for Problem (D).
- (3) There exists an optimal solution χ^* to Problem (D) such that χ^* is in \mathcal{D}_{C_G} and is proportional to some quantum comb.
- (4) There exists an optimal solution χ^* to Problem (D) such that $\chi^* \in \mathcal{D}_{C_G}$ and $D_S(\chi^*) = D_{S_G}(\chi^*)$ hold.

Proof Let D^* and D_G^* be, respectively, the optimal values of Problems (D) and (D_G) [or, equivalently, the optimal values of Problems (P) and (P_G)]. We show (1) \Rightarrow (2), (2) \Rightarrow (3), (3) \Rightarrow (4), and (4) \Rightarrow (1).

(1) \Rightarrow (2) : Let us arbitrarily choose an optimal solution χ^* to Problem (D_G). Since $\mathcal{D}_{C_G} \subseteq \mathcal{D}_C$ holds from $\mathcal{C} \subseteq \mathcal{C}_G$, $\chi^* \in \mathcal{D}_C$ holds. Also, from $\mathcal{S} \subseteq \mathcal{S}_G$, we have $D^* \leq D_S(\chi^*) \leq D_{S_G}(\chi^*)$. Since $D^* = D_G^* = D_{S_G}(\chi^*)$ holds, we have $D^* = D_S(\chi^*)$. Thus, χ^* is optimal for Problem (D).

(2) \Rightarrow (3) : It is known that there exists an optimal solution, $\chi^* \in \mathcal{D}_{C_G}$, to Problem (D_G) such that χ^* is proportional to some quantum comb [20, 47]. From Statement (2), χ^* is optimal for Problem (D).

(3) \Rightarrow (4) : χ^* can be expressed as $\chi^* = qT$ with $q \in \mathbb{R}_+$ and a quantum comb T . Since $\langle \varphi, \chi^* \rangle = q \langle \varphi, T \rangle = q$ holds for any $\varphi \in \mathcal{S}_G$, we have $D_S(\chi^*) = D_{S_G}(\chi^*)$.

(4) \Rightarrow (1) : We have $D^* = D_S(\chi^*) = D_{S_G}(\chi^*) \geq D_G^*$. Since $D^* \leq D_G^*$ holds, $D^* = D_G^*$ must hold. ■

B. Another example of necessary and sufficient optimality conditions

In some individual cases, necessary and sufficient conditions for global optimality can also be derived from Theorem 1. To give an example, let us consider the problem of discriminating quantum channels $\{\hat{\mathcal{E}}_m\}_{m=1}^M \in \text{Chn}(V_1, W_1)$ with a single use (i.e., $T = 1$) in which a state input to the channel is restricted to be separable (see Fig. 3). Since we can assume, without loss of generality, that the input state is a pure state of the system V_1 , the optimal value P^* of Problem (P) is written as

$$P^* := \max_{\phi \in \text{Den}_{V_1}^P} \max_{\Pi \in \text{Meas}_{W_1}} \sum_{m=1}^M p_m \langle \Pi_m, \hat{\mathcal{E}}_m(\phi) \rangle. \quad (17)$$

Since the dual of the discrimination problem in which an input state is fixed to ϕ is formulated as Problem (D) with $\mathcal{C} = \mathcal{C}_G$ and $\mathcal{S} = \{I_{W_1} \otimes \phi^\top\}$, Theorem 1 gives

$$\begin{aligned} \max_{\Pi \in \text{Meas}_{W_1}} \sum_{m=1}^M p_m \langle \Pi_m, \hat{\mathcal{E}}_m(\phi) \rangle &= \min_{\chi \in \mathcal{D}_{C_G}} \langle I_{W_1} \otimes \phi^\top, \chi \rangle, \\ &\forall \phi \in \text{Den}_{V_1}^P, \end{aligned} \quad (18)$$

and thus

$$P^* = \max_{\phi' \in \text{Den}_{V_1}^P} \min_{\chi \in \mathcal{D}_{C_G}} \langle I_{W_1} \otimes \phi', \chi \rangle. \quad (19)$$

Also, the optimal value of Problem (D_G) is expressed by

$$\begin{aligned} \min_{\chi \in \mathcal{D}_{C_G}} \max_{\rho \in \text{Den}_{V_1}} \langle I_{W_1} \otimes \rho^\top, \chi \rangle &= \min_{\chi \in \mathcal{D}_{C_G}} \max_{\phi \in \text{Den}_{V_1}^P} \langle I_{W_1} \otimes \phi^\top, \chi \rangle \\ &= \min_{\chi \in \mathcal{D}_{C_G}} \max_{\phi' \in \text{Den}_{V_1}^P} \langle I_{W_1} \otimes \phi', \chi \rangle. \end{aligned} \quad (20)$$

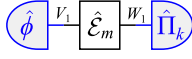

FIG. 3. Channel discrimination problems with a single use in which a state input to the channel is restricted to be separable. We can assume that the input state is a pure state of the system V_1 , i.e., a tester consists of $\hat{\phi} \in \text{Den}_{V_1}^P$ and $\{\hat{\Pi}_m\}_{m=1}^M \in \text{Meas}_{W_1}$.

Thus, globally optimal discrimination is achieved without entanglement if and only if the following max-min inequality holds as an equality:

$$\max_{\phi' \in \text{Den}_{V_1}^P} \min_{\chi \in \mathcal{D}_{CG}} \langle I_{W_1} \otimes \phi', \chi \rangle \leq \min_{\chi \in \mathcal{D}_{CG}} \max_{\phi' \in \text{Den}_{V_1}^P} \langle I_{W_1} \otimes \phi', \chi \rangle. \quad (21)$$

C. Sufficient condition for a nonadaptive tester to be globally optimal

Given a process discrimination problem that has a certain symmetry, we present a sufficient condition for a nonadaptive tester to be globally optimal. We here limit our discussion to a specific type of symmetries (see [47] for a more general case). Note that several related results in particular cases have been reported [16, 20, 48].

Let \mathcal{G} be a group with the identity element e . Let $\varpi := \{\varpi_g\}_{g \in \mathcal{G}}$ be a group action of \mathcal{G} on $\{1, \dots, M\}$, i.e., a set of maps on $\{1, \dots, M\}$ satisfying $\varpi_{gh}(m) = \varpi_g[\varpi_h(m)]$ and $\varpi_e(m) = m$ for any $g, h \in \mathcal{G}$ and $m \in \{1, \dots, M\}$. Given any natural number T , we consider a set

$$\mathcal{U} := \left\{ \mathcal{U}_g := \text{Ad}_{U_g^{(T)} \otimes \tilde{U}_g^{(T)} \otimes \dots \otimes U_g^{(1)} \otimes \tilde{U}_g^{(1)}} \right\}_{g \in \mathcal{G}}, \quad (22)$$

where, for each $t \in \{1, \dots, T\}$, $\mathcal{G} \ni g \mapsto U_g^{(t)} \in \text{Uni}_{W_t}$ and $\mathcal{G} \ni g \mapsto \tilde{U}_g^{(t)} \in \text{Uni}_{V_t}$ are projective unitary representations of \mathcal{G} . We will refer to an ensemble of M combs $\{\mathcal{E}_m\}_{m=1}^M \subset \text{Comb}_{W_T, V_T, \dots, W_1, V_1}$ as $(\mathcal{G}, \mathcal{U}, \varpi)$ -covariant if

$$\mathcal{U}_g(\mathcal{E}_m) = \mathcal{E}_{\varpi_g(m)}, \quad \forall g \in \mathcal{G} \quad (23)$$

holds.

We will call a tester each of whose output systems is one part of a bipartite system in a maximally entangled pure state (see Fig. 4) a *tester with maximally entangled pure states*. Such a tester is obviously nonadaptive. Let \mathcal{P} be the set of testers with maximally entangled pure states; then, it follows that Eq. (14) holds with

$$C := C_G, \quad S := \left\{ I_{\tilde{V}} / \prod_{i=1}^T N_{V_i} \right\}. \quad (24)$$

Note that $\overline{\text{co}} \mathcal{P} = \mathcal{P}$ holds in this case. We obtain the following proposition.

Proposition 3 Assume that, for each $t \in \{1, \dots, T\}$, there exists a group $\mathcal{G}^{(t)}$ that has a projective unitary representation

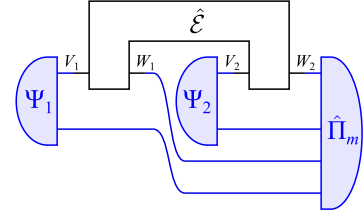

FIG. 4. Tester with maximally entangled pure states (in the case of $T = 2$), which consists of maximally entangled pure states Ψ_t and a measurement $\{\hat{\Pi}_m\}$. We can assume, without loss of generality, that each Ψ_t is a generalized Bell state $|I_{V_t}\rangle\rangle\langle\langle I_{V_t}|/N_{V_t}$.

$\mathcal{G}^{(t)} \ni g \mapsto U_g^{(t)} \in \text{Uni}_{W_t}$ and an irreducible projective unitary representation $\tilde{\mathcal{G}}^{(t)} \ni g \mapsto \tilde{U}_g^{(t)} \in \text{Uni}_{V_t}$. Let $\mathcal{G} := \mathcal{G}^{(T)} \times \mathcal{G}^{(T-1)} \times \dots \times \mathcal{G}^{(1)}$, $\mathcal{U} := \{\text{Ad}_{U_{g_T}^{(T)} \otimes \tilde{U}_{g_T}^{(T)} \otimes \dots \otimes U_{g_1}^{(1)} \otimes \tilde{U}_{g_1}^{(1)}}\}_{(g_T, \dots, g_1) \in \mathcal{G}}$, and ϖ be some group action on \mathcal{G} on $\{1, \dots, M\}$. If $\{\mathcal{E}_m\}_{m=1}^M$ is $(\mathcal{G}, \mathcal{U}, \varpi)$ -covariant, then there exists a globally optimal tester with maximally entangled pure states.

See Ref. [47] for some examples and for more general results.

VI. EXAMPLE

In several problems, Theorem 1 provides an efficient way to find the optimal value of Problem (P). Note that the difficulty of solving Problem (D) depends on the choice of C and S . In this section, we illustrate the usefulness of Theorem 1 in the following simple example.

Let us consider the problem of discriminating three qubit channels $\hat{\Lambda}_1, \hat{\Lambda}_2, \hat{\Lambda}_3$ with $T = 2$ uses, in which case V_1, W_1, V_2 , and W_2 are all qubit systems and $\hat{\mathcal{E}}_m = \hat{\Lambda}_m \otimes \hat{\Lambda}_m$ (i.e., $\mathcal{E}_m = \Lambda_m \otimes \Lambda_m$) holds. Assume that the prior probabilities are equal and that each $\hat{\Lambda}_m$ is the unitary channel represented by $\hat{\Lambda}_m(\rho) = U^m \rho U^{-m}$, where $U := \text{diag}(1, \omega)$ and $\omega := \exp(2\pi \sqrt{-1}/3)$. Then, we have

$$\Lambda_m = \begin{bmatrix} 1 & 0 & 0 & \omega^{-m} \\ 0 & 0 & 0 & 0 \\ 0 & 0 & 0 & 0 \\ \omega^m & 0 & 0 & 1 \end{bmatrix}. \quad (25)$$

We consider the case where a tester is restricted to a sequential one. The set of all sequential testers in \mathcal{P}_G , denoted by \mathcal{P}_{seq} , is (see Fig. 5 and Appendix B 1)

$$\mathcal{P}_{\text{seq}} := \left\{ \left\{ \sum_j B_m^{(j)} \otimes A_j \right\}_{m=1}^3 : \{A_j\} \in \text{Test}, \{B_m^{(j)}\}_m \in \text{Test}_3 \right\}, \quad (26)$$

where

$$\text{Test}_M := \left\{ \{B_m\}_{m=1}^M \subset \text{Pos}_4 : \sum_{m=1}^M B_m = \begin{bmatrix} 1 & 0 \\ 0 & 1 \end{bmatrix} \otimes \rho, \rho \in \text{Den}_2 \right\}, \quad (27)$$

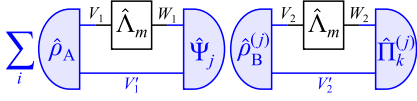

FIG. 5. Discrimination scheme for $\{\hat{\mathcal{E}}_m = \hat{\Lambda}_m \otimes \hat{\Lambda}_m\}_{m=1}^3$ with a sequential tester. Consider the task to be performed by two parties, Alice and Bob. Alice prepares a quantum state $\hat{\rho}_A \in \text{Den}_{V_1 \otimes V'_1}$, feeds the system V_1 into $\hat{\Lambda}_m$, and performs a measurement $\{\hat{\Psi}_j\}_{j \in \mathcal{J}}$ on $W_1 \otimes V'_1$, where \mathcal{J} is a set, which may contain any number of elements. According to its outcome, j , Bob prepares a state $\hat{\rho}_B^{(j)} \in \text{Den}_{V_2 \otimes V'_2}$, feeds the system V_2 into $\hat{\Lambda}_m$, and performs a measurement $\{\hat{\Pi}_k^{(j)}\}_{k=1}^3$ on $W_2 \otimes V'_2$. $\{\hat{A}_j := \hat{\Psi}_j \otimes \hat{\rho}_A\}_{j \in \mathcal{J}}$ and $\{\hat{B}_k^{(j)} := \hat{\Pi}_k^{(j)} \otimes \hat{\rho}_B^{(j)}\}_{k=1}^3$ ($\forall j \in \mathcal{J}$) are testers.

$\text{Test} := \bigcup_{M=1}^{\infty} \text{Test}_M$, and Pos_n and Den_n are, respectively, the sets of all positive semidefinite and density matrices of order n . Problem (P) with $\mathcal{P} = \mathcal{P}_{\text{seq}}$ can be written as the following non-convex programming problem:

$$\begin{aligned} & \text{maximize} \quad \frac{1}{3} \sum_{m=1}^3 \sum_j \langle B_m^{(j)}, \Lambda_m \rangle \langle A_j, \Lambda_m \rangle \\ & \text{subject to} \quad \{A_j\} \in \text{Test}, \{B_m^{(j)}\}_m \in \text{Test}_3. \end{aligned} \quad (28)$$

This problem is very hard to solve due to two main reasons: i) both $\{A_j\}$ and $\{B_m^{(j)}\}_m$ ($\forall j$) need to be optimized and ii) how many elements an optimal tester $\{A_j\}$ has is unknown.

Here, we pay attention to the fact that Eq. (14) with

$$\begin{aligned} C &:= \left\{ \left\{ \sum_j B_m^{(j)} \otimes A_j \right\}_{m=1}^3 : A_j \in \text{Pos}_4, \{B_m^{(j)}\}_m \in \text{Test}_3 \right\}, \\ \mathcal{S} &:= \mathcal{S}_G \end{aligned} \quad (29)$$

holds (see Appendix B 2). In this situation, Problem (D) is expressed as

$$\begin{aligned} & \text{minimize} \quad D_{\mathcal{S}_G}(\chi) \\ & \text{subject to} \quad \sum_{m=1}^3 \left\langle \sum_j B_m^{(j)} \otimes A_j, \chi - \frac{1}{3} \Lambda_m \otimes \Lambda_m \right\rangle \geq 0 \\ & \quad \quad \quad [\forall A_j \in \text{Pos}_4, \{B_m^{(j)}\}_m \in \text{Test}_3] \end{aligned} \quad (30)$$

with $\chi \in \text{Her}_{\hat{V}}$. After some algebra, this problem is reduced to (see Appendix B 3)

$$\begin{aligned} & \text{minimize} \quad \lambda \\ & \text{subject to} \quad \begin{bmatrix} \lambda & 0 \\ 0 & \lambda \end{bmatrix} \geq \frac{1}{3} \sum_{m=1}^3 \langle B_m, \Lambda_m \rangle \begin{bmatrix} 1 & \omega^{-m} \\ \omega^m & 1 \end{bmatrix} \\ & \quad \quad \quad (\forall \{B_m\} \in \text{Test}_3) \end{aligned} \quad (31)$$

with $\lambda \in \mathbb{R}_+$. This problem is much easier to solve than Problem (28). Also, Theorem 1 guarantees that the optimal value of Problem (31), which is numerically found to be around 0.933, is equal to the maximum success probability. Note that in the case where any physically allowed discrimination strategy can be used, we can easily see that the three channels can be perfectly distinguished with two uses (see Appendix B 4).

We restrict our discussion here to the discrimination problem for symmetric unitary qubit channels, but our method can be applied to more general combs. Other examples of different restricted strategies are shown in Appendix C.

VII. RELATIONSHIP WITH ROBUSTNESSES

In resource theory, robustness has been used as a measure of the resourcefulness of a quantum comb, such as a state, measurement, or channel. For a given closed set \mathcal{F} , called a free set, and a closed convex cone \mathcal{K} of $\text{Her}_{\hat{V}}$, the robustness of a comb $\mathcal{E} \in \text{Pos}_{\hat{V}}$ against \mathcal{K} can be defined as [49, 50]

$$R_{\mathcal{K}}^{\mathcal{F}}(\mathcal{E}) := \inf \left\{ \lambda \in \mathbb{R}_+ : \frac{\mathcal{E} + \lambda \mathcal{E}'}{1 + \lambda} \in \mathcal{F}, \mathcal{E}' \in \mathcal{K} \right\}. \quad (32)$$

$R_{\mathcal{K}}^{\mathcal{F}}(\mathcal{E})$ can be intuitively interpreted as the minimal amount, λ , of mixing with a process, $\mathcal{E}' \in \mathcal{K}$, necessary in order for the mixed and renormalized process, $(\mathcal{E} + \lambda \mathcal{E}')/(1 + \lambda)$, to be in \mathcal{F} . As already mentioned in the introduction, it has been shown that the robustness of \mathcal{E} is characterized as a measure of the advantage of \mathcal{E} over all the processes in \mathcal{F} in some discrimination problem [33–40] (see also Appendix E). Note that this problem is somewhat different from a process discrimination problem that this Letter deals with. Conversely, we show that the optimal value of Problem (P) is characterized by a robustness measure.

For the problem of discriminating quantum combs $\{\hat{\mathcal{E}}_m\}_{m=1}^M$ with prior probabilities $\{p_m\}_{m=1}^M$, let us suppose that a party, Alice, chooses a state $|m\rangle\langle m|$ with the probability p_m , where $\{|m\rangle\}$ is the standard basis of a classical system W_A , and sends the corresponding comb $\hat{\mathcal{E}}_m$ to another party, Bob. The Choi-Jamiołkowski representation of the comb shared by Alice and Bob is expressed as

$$\mathcal{E}^{\text{ex}} := \sum_{m=1}^M p_m |m\rangle\langle m| \otimes \mathcal{E}_m \in \text{Pos}_{W_A \otimes \hat{V}}. \quad (33)$$

Bob tries to infer which state Alice has. When he uses a tester $\{\Phi_m\}_m$, the success probability is written as $\sum_{m=1}^M \langle |m\rangle\langle m| \otimes \Phi_m, \mathcal{E}^{\text{ex}} \rangle = P(\Phi)$. Using Theorem 1, we can see that the optimal value of Problem (P) is characterized by a robustness measure.

Corollary 4 Let

$$\begin{aligned} \mathcal{K} &:= \left\{ Y \in \text{Her}_{W_A \otimes \hat{V}} : \sum_{m=1}^M \langle |m\rangle\langle m| \otimes \Phi_m, Y \rangle \geq 0 (\forall \Phi \in C) \right\}, \\ \mathcal{F} &:= \{I_{W_A} \otimes \chi' : \chi' \in \text{Her}_{\hat{V}}, D_S(\chi') = 1/M\}; \end{aligned} \quad (34)$$

then, the optimal value of Problem (P) is equal to $[1 + R_{\mathcal{K}}^{\mathcal{F}}(\mathcal{E}^{\text{ex}})]/M$.

Proof From Eq. (32), we have

$$\frac{1 + R_{\mathcal{K}}^{\mathcal{F}}(\mathcal{E}^{\text{ex}})}{M} = \inf \left\{ \frac{1 + \lambda}{M} : \frac{\mathcal{E}^{\text{ex}} + \delta}{1 + \lambda} = I_{W_A} \otimes \chi', \chi' \in \text{Her}_{\bar{V}}, \right. \\ \left. D_S(\chi') = \frac{1}{M}, \delta \in \mathcal{K} \right\}. \quad (35)$$

Letting $\chi := (1 + \lambda)\chi'$ and using some algebra, the right-hand side becomes

$$\inf \{ D_S(\chi) : \chi \in \text{Her}_{\bar{V}}, I_{W_A} \otimes \chi - \mathcal{E}^{\text{ex}} \in \mathcal{K} \} \\ = \inf \left\{ D_S(\chi) : \chi \in \text{Her}_{\bar{V}}, \sum_{m=1}^M |m\rangle\langle m| \otimes (\chi - p_m \mathcal{E}_m) \in \mathcal{K} \right\} \\ = \inf \{ D_S(\chi) : \chi \in \mathcal{D}_C \} = D^*, \quad (36)$$

where D^* is the optimal value of Problem (D). Thus, Theorem 1 completes the proof. ■

If \mathcal{E}^{ex} belongs to the free set \mathcal{F} , then $p_1 = \dots = p_M = 1/M$ and $\mathcal{E}_1 = \dots = \mathcal{E}_M$ must hold, which implies that \mathcal{F} can intuitively be thought of as a set that includes all \mathcal{E}^{ex} corresponding to trivial process discrimination problems. This robustness measure indicates how far \mathcal{E}^{ex} is from \mathcal{F} . This interpretation has the potential to provide a deeper insight into optimal discrimination of quantum processes with restricted testers.

VIII. CONCLUSION

We have presented a general approach for solving quantum process discrimination problems with restricted testers based on convex programming. Our analysis indicates that a dual problem exhibiting zero duality gap is obtained regardless of the set of all restricted testers. Necessary and sufficient conditions for an optimal restricted tester to be globally optimal are also derived. We have shown that the optimal value of each process discrimination problem can be written in terms of a robustness measure. In comparison to previous theoretical works, our approach would allow a unified analysis for a large class of process discrimination problems in which the allowed testers are restricted. A meaningful direction for subsequent work would be to apply our approach to practical fields, such as quantum communication and quantum metrology.

We thank for O. Hirota, T. S. Usuda, and K. Kato for insightful discussions. This work was supported by JSPS KAKENHI Grant Number JP19K03658.

Appendix A: Proof of Theorem 1

We consider the following Lagrangian associated with Problem (P):

$$L(\Phi, \varphi, \chi) := \sum_{m=1}^M \langle \Phi_m, \tilde{\mathcal{E}}_m \rangle + \left\langle \varphi - \sum_{m=1}^M \Phi_m, \chi \right\rangle \\ = \langle \varphi, \chi \rangle - \sum_{m=1}^M \langle \Phi_m, \chi - \tilde{\mathcal{E}}_m \rangle, \quad (1)$$

where $\Phi \in \mathcal{C}$, $\varphi \in \mathcal{S}$, $\chi \in \text{Her}_{\bar{V}}$, and $\tilde{\mathcal{E}}_m := p_m \mathcal{E}_m$. From Eq. (1), we have

$$\inf_{\chi} L(\Phi, \varphi, \chi) = \begin{cases} \sum_{m=1}^M \langle \Phi_m, \tilde{\mathcal{E}}_m \rangle, & \varphi = \sum_{m=1}^M \Phi_m, \\ -\infty, & \text{otherwise,} \end{cases} \\ \sup_{\Phi} L(\Phi, \varphi, \chi) = \begin{cases} \langle \varphi, \chi \rangle, & \chi \in \mathcal{D}_C, \\ \infty, & \text{otherwise.} \end{cases} \quad (2)$$

Thus, the left- and right-hand sides of the max-min inequality

$$\sup_{\Phi, \varphi} \inf_{\chi} L(\Phi, \varphi, \chi) \leq \inf_{\chi} \sup_{\Phi, \varphi} L(\Phi, \varphi, \chi) \quad (3)$$

equal the optimal values of Problems (P) and (D), respectively.

To show the strong duality, it suffices to show that there exists $\Phi^* \in \overline{\text{co}} \mathcal{P}$ such that $P(\Phi^*) \geq D^*$, where D^* is the optimal value of Problem (D). Let us consider the following set:

$$\mathcal{Z} := \left\{ \left(\{y_m + \tilde{\mathcal{E}}_m - \chi\}_{m=1}^M, D_S(\chi) - d \right) : (\chi, y, d) \in \mathcal{Z}_0 \right\} \\ \subset \text{Her}_{\bar{V}}^M \times \mathbb{R}, \quad (4)$$

where $y := \{y_m\}_{m=1}^M$ and

$$\mathcal{Z}_0 := \left\{ (\chi, y, d) \in \text{Her}_{\bar{V}} \times \mathbb{C}^* \times \mathbb{R} : d < D^* \right\}. \quad (5)$$

It is easily seen that \mathcal{Z} is a nonempty convex set. Arbitrarily choose $(\chi, y, d) \in \mathcal{Z}_0$ such that $y_m + \tilde{\mathcal{E}}_m - \chi = \mathbb{0}$ ($\forall m$); then, $D_S(\chi) \geq D^*$ holds from $\{\chi - \tilde{\mathcal{E}}_m\}_m \in \mathcal{C}^*$, which yields $D_S(\chi) - d \geq D^* - d > 0$. Thus, we have $(\{\mathbb{0}\}, 0) \notin \mathcal{Z}$. From separating hyperplane theorem [51], there exists $(\{\Psi_m\}_{m=1}^M, \alpha) \neq (\{\mathbb{0}\}, 0)$ such that

$$\sum_{m=1}^M \langle \Psi_m, y_m + \tilde{\mathcal{E}}_m - \chi \rangle + \alpha [D_S(\chi) - d] \geq 0, \quad \forall (\chi, y, d) \in \mathcal{Z}_0. \quad (6)$$

Substituting $y_m = cy'_m$ ($c \in \mathbb{R}_+$, $\{y'_m\}_m \in \mathcal{C}^*$) into Eq. (6) and taking the limit $c \rightarrow \infty$ yields $\{\Psi_m\}_m \in \mathcal{C}$. Taking the limit $d \rightarrow -\infty$ gives $\alpha \geq 0$. To show $\alpha > 0$, assume by contradiction $\alpha = 0$. Substituting $\chi = cI_{\bar{V}}$ ($c \in \mathbb{R}_+$) and taking the limit $c \rightarrow \infty$ yields $\sum_{m=1}^M \text{Tr} \Psi_m \leq 0$. From $\{\Psi_m\}_m \in \mathcal{C} \subseteq \text{Pos}_{\bar{V}}^M$, $\Psi_m = \mathbb{0}$ ($\forall m$) holds. This contradicts $(\{\Psi_m\}_m, \alpha) \neq (\{\mathbb{0}\}, 0)$, and thus $\alpha > 0$ holds. Let $\Phi_m^* := \Psi_m/\alpha$; then, Eq. (6) yields

$$\sum_{m=1}^M \langle \Phi_m^*, y_m + \tilde{\mathcal{E}}_m - \chi \rangle + D_S(\chi) - d \geq 0, \quad \forall (\chi, y, d) \in \mathcal{Z}_0. \quad (7)$$

By substituting $\chi = c\chi'$ ($c \in \mathbb{R}_+$, $\chi' \in \text{Her}_{\bar{V}}$) into Eq. (7) and taking the limit $c \rightarrow \infty$, we have $D_S(\chi') \geq \sum_{m=1}^M \langle \Phi_m^*, \chi' \rangle$ ($\forall \chi' \in \text{Her}_{\bar{V}}$). This implies $\sum_{m=1}^M \Phi_m^* \in \mathcal{S}$, i.e., $\Phi^* \in \overline{\text{co}} \mathcal{P}$. Indeed, assume by contradiction $\sum_{m=1}^M \Phi_m^* \notin \mathcal{S}$; then, since \mathcal{S} is a closed convex set, from separating hyperplane theorem, there exists $\chi' \in \text{Her}_{\bar{V}}$ such that $\langle \phi, \chi' \rangle < \langle \sum_{m=1}^M \Phi_m^*, \chi' \rangle$ ($\forall \phi \in$

S), which contradicts $D_S(\chi') \geq \sum_{m=1}^M \langle \Phi_m^*, \chi' \rangle$. Substituting $y_m = \mathbb{0}$ and $\chi = \mathbb{0}$ into Eq. (7) and taking the limit $d \rightarrow D^*$ yields $P(\Phi^*) = \sum_{m=1}^M \langle \Phi_m^*, \tilde{\mathcal{E}}_m \rangle \geq D^*$. ■

Theorem 1 can be generalized to the following corollary.

Corollary 5 Given \mathcal{P} , let us arbitrarily choose a subset C of C_G and a bounded subset S of S_G such that

$$\overline{\text{co}} \mathcal{P} = \left\{ \Phi \in \overline{\text{coni}} C : \sum_{m=1}^M \Phi_m \in \overline{\text{co}} S \right\}. \quad (8)$$

Then, the problem

$$\begin{aligned} & \text{minimize} \quad \sup_{\varphi \in S} \langle \varphi, \chi \rangle \\ & \text{subject to} \quad \chi \in \mathcal{D}_C \end{aligned} \quad (9)$$

has the same optimal value as Problem (P).

Proof From Theorem 1, the following problem

$$\begin{aligned} & \text{minimize} \quad D_{\overline{\text{co}} S}(\chi) \\ & \text{subject to} \quad \chi \in \mathcal{D}_{\overline{\text{coni}} C} \end{aligned} \quad (10)$$

has the same optimal value as Problem (P). Also, it is easily seen that $D_{\overline{\text{co}} S}(\chi) = D_{\text{co} S}(\chi) = \sup_{\varphi \in S} \langle \varphi, \chi \rangle$ and $\mathcal{D}_{\overline{\text{coni}} C} = \mathcal{D}_C$ hold. ■

Appendix B: Supplement of the example of sequential strategies

1. Formulation of \mathcal{P}_{seq}

We show that the set of all sequential testers in \mathcal{P}_G is expressed as

$$\mathcal{P}_{\text{seq}} := \left\{ \left\{ \sum_j B_m^{(j)} \otimes A_j \right\}_{m=1}^3 : \{A_j\} \in \text{Test}, \{B_m^{(j)}\}_m \in \text{Test}_3 \right\}. \quad (1)$$

From Fig. 5, $\Phi \in \mathcal{P}_{\text{seq}}$ holds if and only if $\hat{\Phi}_k$ is expressed in the form

$$\sum_i \left(\hat{\rho}_A \otimes \hat{\Psi}_j \right) \otimes \left(\hat{\rho}_B^{(j)} \otimes \hat{\Pi}_k^{(j)} \right), \quad (2)$$

where $\hat{\rho}_A \in \text{Den}_{V_1 \otimes V_1'}$, $\{\hat{\Psi}_j\}_j \in \text{Meas}_{W_1 \otimes V_1'}$, $\hat{\rho}_B^{(j)} \in \text{Den}_{V_2 \otimes V_2'}$ ($\forall j$), and $\{\hat{\Pi}_k^{(j)}\}_{m=1}^M \in \text{Meas}_{W_2 \otimes V_2'}$ ($\forall j$). It follows that $\{\hat{A}_j := \hat{\Psi}_j \otimes \hat{\rho}_A\}_{j \in \mathcal{J}}$ and $\{\hat{B}_k^{(j)} := \hat{\Pi}_k^{(j)} \otimes \hat{\rho}_B^{(j)}\}_{k=1}^3$ are testers and Eq. (2) can be rewritten as

$$\sum_j \left(\hat{A}_j \right) \otimes \left(\hat{B}_k^{(j)} \right). \quad (3)$$

This gives that $\Phi \in \mathcal{P}_{\text{seq}}$ holds if and only if Φ is expressed in the form $\Phi = \left\{ \sum_j B_m^{(j)} \otimes A_j \right\}_{m=1}^3$ with

$$\{A_j\}_{j \in \mathcal{J}} \subset \text{Pos}_{W_1 \otimes V_1}, \quad \sum_{j \in \mathcal{J}} A_j \in \text{Comb}_{W_1, V_1}^* \quad (4)$$

and

$$\{B_m^{(j)}\}_{m=1}^3 \subset \text{Pos}_{W_2 \otimes V_2}, \quad \sum_{m=1}^3 B_m^{(j)} \in \text{Comb}_{W_2, V_2}^*, \quad \forall j \in \mathcal{J}. \quad (5)$$

From Eq. (8), Eqs. (4) and (5) are, respectively, equivalent to $\{A_j\} \in \text{Test}$ and $\{B_m^{(j)}\}_m \in \text{Test}_3$.

2. Derivation of Eq. (14) with Eq. (29)

Let \mathcal{P}' be the right-hand side of Eq.(14), i.e.,

$$\mathcal{P}' := \left\{ \Phi \in C : \sum_{m=1}^M \Phi_m \in S \right\}. \quad (6)$$

Since we can easily obtain $\overline{\text{co}} \mathcal{P} = \mathcal{P}$ and $\mathcal{P} \subseteq \mathcal{P}'$ (i.e., $\Phi \in C$ and $\sum_{m=1}^M \Phi_m \in S$ hold for any $\Phi \in \mathcal{P}$), it suffices to show $\mathcal{P}' \subseteq \mathcal{P}$.

Let us consider \mathcal{P}' with Eq. (29). Arbitrarily choose $\Phi' \in \mathcal{P}'$. From $\Phi' \in C$, $\hat{\Phi}'_k$ is expressed in the form of Eq. (3) with $A_j \in \text{Pos}_{W_1 \otimes V_1}$ and $\{B_m^{(j)}\}_m \in \text{Test}_{W_2, V_2}$ ($\forall j$). Arbitrarily choose $\hat{\sigma} \in \text{Chn}(V_2, W_2)$; then, from

$$\sum_k \left(\hat{B}_k^{(j)} \right) \otimes \hat{\sigma} = 1, \quad (7)$$

we have

$$\begin{aligned} & \sum_j \sum_k \left(\hat{A}_j \right) \otimes \left(\hat{B}_k^{(j)} \right) \otimes \hat{\sigma} \\ &= \sum_j \left(\hat{A}_j \right) \otimes \hat{\sigma}. \end{aligned} \quad (8)$$

Also, from $\sum_{k=1}^M \Phi'_k \in S_G$, we have

$$\sum_j \sum_k \left(\hat{A}_j \right) \otimes \left(\hat{B}_k^{(j)} \right) \otimes \hat{\sigma} = \left(\hat{\rho}'_A \right) \otimes \hat{\sigma} \otimes \mathbb{1}. \quad (9)$$

with some $\hat{\rho}'_A \in \text{Den}_{V_1}$. Equations (8) and (9) yield that $\{\hat{A}_j\}$ is a tester. Since $\{\hat{A}_j\}$ and $\{\hat{B}_m^{(j)}\}_m$ are testers, $\hat{\Phi}'_k$ is expressed in the form of Eq. (2), i.e., $\mathcal{P}' \subseteq \mathcal{P}$.

3. Derivation of Problem (31)

There exists an optimal solution χ to Problem (30) expressed in the form $\chi = \lambda\tilde{\chi}$ with $\lambda \in \mathbb{R}_+$ and $\tilde{\chi} \in \text{Comb}_{W_2, V_2, W_1, V_1}$ (see [47]). Note that from Eq. (11), $D_S(\tilde{\chi}) = 1$ holds for any $\tilde{\chi} \in \text{Comb}_{W_2, V_2, W_1, V_1}$. Since $\tilde{\chi}$ is a comb, we can see that

$$X := \sum_{m=1}^3 \text{Tr}_{W_2 \otimes V_2} \left[\left[B_m^{(j)} \otimes I_2 \right] \tilde{\chi} \right] \in \text{Comb}_{W_1, V_1} \quad (10)$$

is independent of the measurement $\{B_m^{(j)}\}_{m=1}^3$. Conversely, for any $X \in \text{Comb}_{W_1, V_1}$, there exists $\tilde{\chi} \in \text{Comb}_{W_2, V_2, W_1, V_1}$ satisfying Eq. (10). Thus, Problem (30) is rewritable as

$$\begin{aligned} & \text{minimize } \lambda \\ & \text{subject to } \lambda X \geq \frac{1}{3} \sum_{m=1}^3 \langle B_m, \Lambda_m \rangle \Lambda_m \quad (\forall \{B_m\} \in \text{Test}_3) \end{aligned} \quad (11)$$

with $\lambda \in \mathbb{R}_+$ and $X \in \text{Comb}_{W_1, V_1}$. Due to the symmetry of

$$\Lambda_m = \begin{bmatrix} 1 & 0 & 0 & \omega^{-m} \\ 0 & 0 & 0 & 0 \\ 0 & 0 & 0 & 0 \\ \omega^m & 0 & 0 & 1 \end{bmatrix}, \quad (12)$$

we can assume without loss of generality that

$$X := \begin{bmatrix} 1 & 0 & 0 & 0 \\ 0 & 0 & 0 & 0 \\ 0 & 0 & 0 & 0 \\ 0 & 0 & 0 & 1 \end{bmatrix} \quad (13)$$

holds. This reduces Problem (11) to Problem (31).

4. Perfect distinguishability

We here show that $\{\mathcal{E}_m := \Lambda_m \otimes \Lambda_m\}_{m=1}^3$ can be perfectly distinguished if any physically allowed discrimination strategy can be performed. Assume that the prior probabilities are equal; then, the maximum success probability is equal to the optimal value of the following problem [20]:

$$\begin{aligned} & \text{minimize } \lambda \\ & \text{subject to } \lambda\tilde{\chi} \geq \mathcal{E}_m/3 \end{aligned} \quad (14)$$

with $\lambda \in \mathbb{R}_+$ and $\tilde{\chi} \in \text{Comb}_{W_2, V_2, W_1, V_1}$. Note that \mathcal{E}_m is given by

$$\mathcal{E}_m = \begin{bmatrix} 1 & 0 & 0 & \omega^{-m} & 0 & 0 & 0 & 0 & 0 & 0 & 0 & 0 & 0 & \omega^{-m} & 0 & 0 & \omega^m \\ 0 & 0 & 0 & 0 & 0 & 0 & 0 & 0 & 0 & 0 & 0 & 0 & 0 & 0 & 0 & 0 & 0 \\ 0 & 0 & 0 & 0 & 0 & 0 & 0 & 0 & 0 & 0 & 0 & 0 & 0 & 0 & 0 & 0 & 0 \\ \omega^m & 0 & 0 & 1 & 0 & 0 & 0 & 0 & 0 & 0 & 0 & 0 & 0 & 1 & 0 & 0 & \omega^{-m} \\ 0 & 0 & 0 & 0 & 0 & 0 & 0 & 0 & 0 & 0 & 0 & 0 & 0 & 0 & 0 & 0 & 0 \\ 0 & 0 & 0 & 0 & 0 & 0 & 0 & 0 & 0 & 0 & 0 & 0 & 0 & 0 & 0 & 0 & 0 \\ 0 & 0 & 0 & 0 & 0 & 0 & 0 & 0 & 0 & 0 & 0 & 0 & 0 & 0 & 0 & 0 & 0 \\ 0 & 0 & 0 & 0 & 0 & 0 & 0 & 0 & 0 & 0 & 0 & 0 & 0 & 0 & 0 & 0 & 0 \\ 0 & 0 & 0 & 0 & 0 & 0 & 0 & 0 & 0 & 0 & 0 & 0 & 0 & 0 & 0 & 0 & 0 \\ 0 & 0 & 0 & 0 & 0 & 0 & 0 & 0 & 0 & 0 & 0 & 0 & 0 & 0 & 0 & 0 & 0 \\ \omega^m & 0 & 0 & 1 & 0 & 0 & 0 & 0 & 0 & 0 & 0 & 0 & 0 & 1 & 0 & 0 & \omega^{-m} \\ 0 & 0 & 0 & 0 & 0 & 0 & 0 & 0 & 0 & 0 & 0 & 0 & 0 & 0 & 0 & 0 & 0 \\ 0 & 0 & 0 & 0 & 0 & 0 & 0 & 0 & 0 & 0 & 0 & 0 & 0 & 0 & 0 & 0 & 0 \\ \omega^{-m} & 0 & 0 & \omega^m & 0 & 0 & 0 & 0 & 0 & 0 & 0 & 0 & 0 & \omega^m & 0 & 0 & 1 \end{bmatrix}. \quad (15)$$

Due to the symmetry of \mathcal{E}_m , we can assume, without loss of generality, that $\lambda\tilde{\chi}$ is expressed in the form

$$\lambda\tilde{\chi} = \begin{bmatrix} \lambda & 0 & 0 & 0 & 0 & 0 & 0 & 0 & 0 & 0 & 0 & 0 & 0 & 0 & 0 & 0 & 0 \\ 0 & 0 & 0 & 0 & 0 & 0 & 0 & 0 & 0 & 0 & 0 & 0 & 0 & 0 & 0 & 0 & 0 \\ 0 & 0 & 0 & 0 & 0 & 0 & 0 & 0 & 0 & 0 & 0 & 0 & 0 & 0 & 0 & 0 & 0 \\ 0 & 0 & 0 & \lambda & 0 & 0 & 0 & 0 & 0 & 0 & 0 & 0 & 0 & y & 0 & 0 & 0 \\ 0 & 0 & 0 & 0 & 0 & 0 & 0 & 0 & 0 & 0 & 0 & 0 & 0 & 0 & 0 & 0 & 0 \\ 0 & 0 & 0 & 0 & 0 & 0 & 0 & 0 & 0 & 0 & 0 & 0 & 0 & 0 & 0 & 0 & 0 \\ 0 & 0 & 0 & 0 & 0 & 0 & 0 & 0 & 0 & 0 & 0 & 0 & 0 & 0 & 0 & 0 & 0 \\ 0 & 0 & 0 & 0 & 0 & 0 & 0 & 0 & 0 & 0 & 0 & 0 & 0 & 0 & 0 & 0 & 0 \\ 0 & 0 & 0 & 0 & 0 & 0 & 0 & 0 & 0 & 0 & 0 & 0 & 0 & 0 & 0 & 0 & 0 \\ 0 & 0 & 0 & 0 & 0 & 0 & 0 & 0 & 0 & 0 & 0 & 0 & 0 & 0 & 0 & 0 & 0 \\ 0 & 0 & 0 & 0 & 0 & 0 & 0 & 0 & 0 & 0 & 0 & 0 & 0 & 0 & 0 & 0 & 0 \\ 0 & 0 & 0 & y & 0 & 0 & 0 & 0 & 0 & 0 & 0 & 0 & 0 & \lambda & 0 & 0 & 0 \\ 0 & 0 & 0 & 0 & 0 & 0 & 0 & 0 & 0 & 0 & 0 & 0 & 0 & 0 & 0 & 0 & 0 \\ 0 & 0 & 0 & 0 & 0 & 0 & 0 & 0 & 0 & 0 & 0 & 0 & 0 & 0 & 0 & 0 & 0 \\ 0 & 0 & 0 & 0 & 0 & 0 & 0 & 0 & 0 & 0 & 0 & 0 & 0 & 0 & 0 & 0 & \lambda \end{bmatrix} \quad (16)$$

with $y \in \mathbb{C}$. Note that since $\mathcal{E}_m = \text{Ad}_{U^{m-n} \otimes I_2 \otimes U^{m-n} \otimes I_2}(\mathcal{E}_n)$ ($\forall m, n \in \{1, 2, 3\}$) holds, there exists an optimal solution $(\lambda, \tilde{\chi})$ to Problem (14) satisfying $\tilde{\chi} = \text{Ad}_{U^k \otimes I_2 \otimes U^k \otimes I_2}(\tilde{\chi})$ ($\forall k \in \{1, 2, 3\}$), as will be shown in Lemma 6. After some simple algebra, we can see that $\lambda\tilde{\chi} \geq \mathcal{E}_m/3$ is equivalent to

$$3\lambda^2 - 4\lambda + 3y\lambda - 2y \geq 0, \quad \lambda \geq y \geq \frac{4}{3} - 2\lambda. \quad (17)$$

We obtain the minimal λ satisfying these inequalities, which is the optimal value of Problem (14), to be 1. Thus, $\{\mathcal{E}_m := \Lambda_m \otimes \Lambda_m\}_{m=1}^3$ are perfectly distinguishable.

We here give another proof. Let us consider an ensemble of three states $\{\hat{\rho}_m\}_{m=1}^3$ expressed as

$$\hat{\rho}_m := \begin{array}{c} \text{---} W_2 \\ \text{---} \hat{\sigma}_1 \text{---} V_1 \text{---} \hat{\Lambda}_m \text{---} W_1 \text{---} \hat{\sigma}_2 \text{---} V_2 \text{---} \hat{\Lambda}_m \text{---} W_2 \\ \text{---} V_1' \text{---} \text{---} V_2' \end{array} \quad (18)$$

[i.e., $\hat{\rho}_m := (\hat{\Lambda}_m \otimes \hat{\sigma}_2 \otimes \hat{\Lambda}_m)(\hat{\sigma}_1)$] with $\hat{\sigma}_1 \in \text{Den}_{V_1 \otimes V_1'}$ and $\hat{\sigma}_2 \in \text{Chn}(W_1 \otimes V_1', V_2 \otimes W_2')$. We choose

$$\hat{\sigma}_1 := \frac{1}{2} \begin{bmatrix} 1 & 0 & 0 & 1 \\ 0 & 0 & 0 & 0 \\ 0 & 0 & 0 & 0 \\ 1 & 0 & 0 & 1 \end{bmatrix}, \quad \hat{\sigma}_2 := \text{Ad}_{U'},$$

$$U' := \frac{1}{\sqrt{3}} \begin{bmatrix} \sqrt{2} & 0 & 1 & 0 \\ 0 & \sqrt{2} & 0 & 1 \\ -1 & 0 & \sqrt{2} & 0 \\ 0 & -1 & 0 & \sqrt{2} \end{bmatrix}; \quad (19)$$

then, it is easily seen that $\{\hat{\rho}_m\}_{m=1}^3$ are orthogonal. Therefore, $\{\mathcal{E}_m\}_{m=1}^3$ are perfectly distinguishable.

Appendix C: Applications of Theorem 1

In addition to the example given in the main paper, we will provide two other examples demonstrating the utility of Theorem 1. In this section, we consider the case $T = 2$.

1. First example

The first example is the restriction to nonadaptive testers [see Fig. 6(a)]. Let

$$C := C_G,$$

$$S := \{\times_{W_1, V_2}(I_{W_2 \otimes W_1} \otimes \rho') : \rho' \in \text{Den}_{V_2 \otimes V_1'}\}, \quad (1)$$

where $\times_{W, V} \in \text{Chn}(W \otimes V, V \otimes W)$ is the channel that swaps two systems W and V , which is depicted by



$$\begin{array}{c} W \\ \diagdown \\ \diagup \\ V \end{array}. \quad (2)$$

We will show that \mathcal{P}' of Eq. (6) is equal to $\overline{\text{co}}\mathcal{P}$ [i.e., Eq. (14) holds] in the next paragraph. Substituting Eq. (1) into Problem (D) yields the following dual problem

$$\begin{aligned} & \text{minimize} && \max_{\rho' \in \text{Den}_{V_2 \otimes V_1'}} \langle \times_{W_1, V_2}(I_{W_2 \otimes W_1} \otimes \rho'), \chi \rangle \\ & \text{subject to} && \chi \in \mathcal{D}_{C_G} = \{\chi \in \text{Pos}_{\tilde{V}} : \chi \geq p_m \mathcal{E}_m (\forall m)\}. \end{aligned} \quad (3)$$

Note that although this problem is also formulated as the task of discriminating $\{\times_{V_2, W_1}(\mathcal{E}_m) \in \text{Comb}_{W_2 \otimes W_1, V_2 \otimes V_1'}\}_m$ with a single use, the expression of Problem (3) is useful for verifying the global optimality of nonadaptive testers.

We here show $\mathcal{P}' = \overline{\text{co}}\mathcal{P}$. It is easily seen $\overline{\text{co}}\mathcal{P} = \mathcal{P}$ and $\mathcal{P} \subseteq \mathcal{P}'$ (i.e., $\Phi \in C$ and $\sum_{m=1}^M \Phi_m \in S$ hold for any $\Phi \in \mathcal{P}$). Thus, it suffices to show $\mathcal{P}' \subseteq \mathcal{P}$. From Fig. 6(a), $\Phi \in \mathcal{P}$ holds if and only if $\hat{\Phi}_k$ is expressed in the form

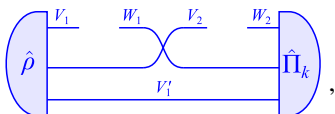

$$\begin{array}{c} V_1 \\ \diagdown \\ \diagup \\ V_1' \end{array} \begin{array}{c} W_1 \\ \diagdown \\ \diagup \\ V_2 \end{array} \begin{array}{c} W_2 \\ \diagdown \\ \diagup \\ V_1' \end{array} \begin{array}{c} \hat{\rho} \\ \diagdown \\ \diagup \\ \hat{\Pi}_k \end{array}, \quad (4)$$

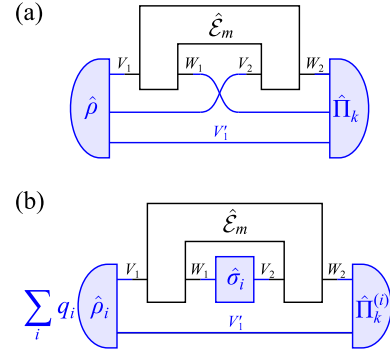
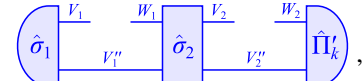

FIG. 6. Examples of two types of restricted testers. (a) A nonadaptive tester, in which first a state $\hat{\rho} \in \text{Den}_{V_1 \otimes V_2 \otimes V_1'}$ is prepared, then the parts V_1 and V_2 are transmitted through a given process $\hat{\mathcal{E}}_m$, and finally a measurement $\{\hat{\Pi}_k\}_{k=1}^M \in \text{Meas}_{W_2 \otimes W_1 \otimes V_1'}$ is performed. (b) A tester performed by two parties, Alice and Bob. In this tester, Alice first prepares a state $\hat{\rho}_i \in \text{Den}_{V_1 \otimes V_1'}$ with a probability q_i and sends its one part V_1 to a given process $\hat{\mathcal{E}}_m$. She also sends the classical information i to Bob, who performs a channel $\hat{\sigma}_i \in \text{Chn}(W_1, V_2)$ depending on i . Alice finally performs a measurement $\{\hat{\Pi}_k^{(i)}\}_{k=1}^M \in \text{Meas}_{W_2 \otimes V_1'}$. Only one-way classical communication from Alice to Bob is allowed.

where $\hat{\rho} \in \text{Den}_{V_1 \otimes V_2 \otimes V_1'}$ and $\{\hat{\Pi}_m\}_{m=1}^M \in \text{Meas}_{W_2 \otimes W_1 \otimes V_1'}$. Arbitrarily choose $\Phi' \in \mathcal{P}'$. One can easily verify $\mathcal{S} \subseteq \mathcal{S}_G$, i.e., $\mathcal{P}' \subseteq \mathcal{P}_G$. Thus, $\hat{\Phi}'_k$ is expressed in the form



$$\begin{array}{c} V_1 \\ \diagdown \\ \diagup \\ V_1'' \end{array} \begin{array}{c} W_1 \\ \diagdown \\ \diagup \\ V_2 \end{array} \begin{array}{c} W_2 \\ \diagdown \\ \diagup \\ V_2' \end{array} \begin{array}{c} \hat{\sigma}_1 \\ \diagdown \\ \diagup \\ \hat{\Pi}'_k \end{array}, \quad (5)$$

where $\hat{\sigma}_1 \in \text{Den}_{V_1 \otimes V_1''}$, $\hat{\sigma}_2 \in \text{Chn}(W_1 \otimes V_1'', V_2 \otimes V_2')$, and $\{\hat{\Pi}'_m\}_{m=1}^M \in \text{Meas}_{W_2 \otimes V_2'}$. V_1'' and V_2'' are some ancillary systems. Also, from $\sum_{m=1}^M \Phi'_m \in \mathcal{S}$, there exists $\hat{\rho}' \in \text{Den}_{V_1 \otimes V_2}$ such that

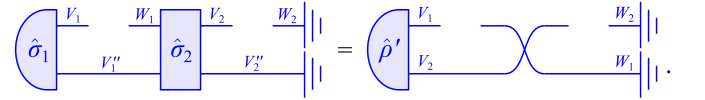

$$\begin{array}{c} V_1 \\ \diagdown \\ \diagup \\ V_1'' \end{array} \begin{array}{c} W_1 \\ \diagdown \\ \diagup \\ V_2 \end{array} \begin{array}{c} W_2 \\ \diagdown \\ \diagup \\ V_2' \end{array} \begin{array}{c} \hat{\sigma}_1 \\ \diagdown \\ \diagup \\ \hat{\Pi}'_k \end{array} = \begin{array}{c} V_1 \\ \diagdown \\ \diagup \\ V_2 \end{array} \begin{array}{c} W_2 \\ \diagdown \\ \diagup \\ V_1' \end{array} \begin{array}{c} \hat{\rho}' \\ \diagdown \\ \diagup \\ \hat{\Pi}'_k \end{array}. \quad (6)$$

Thus, $\hat{\Phi}'_k$ is expressed in the form of Eq. (4), where $\hat{\rho}$ is a purification of $\hat{\rho}'$. Therefore, $\mathcal{P}' \subseteq \mathcal{P}$ holds.

2. Second example

The second example is described in Fig. 6(b). We want to find C and S such that Problem (D) is easy to solve; however, it is hard to find such C and S satisfying Eq. (14). Instead, we consider relaxing this equation to $\overline{\text{co}}\mathcal{P} \subseteq \mathcal{P}'$. We here choose

$$C := \left\{ \left\{ \times_{V_2 \otimes W_1, W_2} \left(\sum_i \sigma_i \otimes A_m^{(i)} \right) \right\}_{m=1}^M : \right.$$

$$\left. \sigma_i \in \text{Comb}_{V_2, W_1}, A_m^{(i)} \in \text{Pos}_{W_2 \otimes V_1'} \right\} \quad (7)$$

and $\mathcal{S} := \mathcal{S}_G$. This allows Problem (D) to be rewritten in this situation as

$$\begin{aligned} & \text{minimize } D_{\mathcal{S}_G}(\chi) \\ & \text{subject to } \text{Tr}_{V_2 \otimes W_1}[\sigma(\chi - p_m \mathcal{E}_m)] \geq 0 \\ & \quad (\forall 1 \leq m \leq M, \sigma \in \text{Comb}_{V_2, W_1}) \end{aligned} \quad (8)$$

with $\chi \in \text{Her}_{\bar{V}}$. We relatively easily obtain the optimal value, denoted by D^* , of this problem. The optimal value of Problem (P) is upper bounded by D^* , since D^* coincides with the optimal value of Problem (P) where the feasible set is relaxed from \mathcal{P} to \mathcal{P}' .

Appendix D: Proof of Proposition 3

Before giving the proof, we first prove the following two lemmas.

Lemma 6 Assume that $\{\mathcal{E}_m\}_{m=1}^M$ is $(\mathcal{G}, \mathcal{U}, \varpi)$ -covariant. If

$$\begin{aligned} C &= C_G, \\ \mathcal{U}_g(\varphi) &\in \mathcal{S}, \quad \forall g \in \mathcal{G}, \varphi \in \mathcal{S} \end{aligned} \quad (1)$$

holds, then there exists an optimal solution, $\chi^* \in \text{Pos}_{\bar{V}}$, to Problem (D) such that

$$\mathcal{U}_g(\chi^*) = \chi^*, \quad \forall g \in \mathcal{G}. \quad (2)$$

Proof Let χ be an optimal solution to Problem (D). From $C = C_G$, we can easily see $\chi \in \text{Pos}_{\bar{V}}$. Also, let

$$\chi^* := \frac{1}{|\mathcal{G}|} \sum_{g \in \mathcal{G}} \mathcal{U}_g(\chi) \in \text{Pos}_{\bar{V}}, \quad (3)$$

where $|\mathcal{G}|$ is the order of \mathcal{G} . Since $\mathcal{U}_g \circ \mathcal{U}_{g'} = \mathcal{U}_{gg'}$ holds for any $g, g' \in \mathcal{G}$, one can easily see Eq. (2). We have that from Eq. (23) and $\chi \geq \mathcal{E}_m$,

$$\chi^* - \mathcal{E}_m = \frac{1}{|\mathcal{G}|} \sum_{g \in \mathcal{G}} \mathcal{U}_g(\chi - \mathcal{E}_{\varpi_g(m)}) \geq 0, \quad \forall m \in \{1, \dots, M\}, \quad (4)$$

i.e., $\chi^* \in \mathcal{D}_C$, where \bar{g} is the inverse of g . Moreover, we have

$$\begin{aligned} D_S(\chi^*) &= \max_{\varphi \in \mathcal{S}} \langle \varphi, \chi^* \rangle = \frac{1}{|\mathcal{G}|} \max_{\varphi \in \mathcal{S}} \sum_{g \in \mathcal{G}} \langle \varphi, \mathcal{U}_g(\chi) \rangle \\ &\leq \frac{1}{|\mathcal{G}|} \sum_{g \in \mathcal{G}} \max_{\varphi \in \mathcal{S}} \langle \varphi, \mathcal{U}_g(\chi) \rangle = \frac{1}{|\mathcal{G}|} \sum_{g \in \mathcal{G}} \max_{\varphi \in \mathcal{S}} \langle \mathcal{U}_{\bar{g}}(\varphi), \chi \rangle \\ &\leq \frac{1}{|\mathcal{G}|} \sum_{g \in \mathcal{G}} D_S(\chi) = D_S(\chi), \end{aligned} \quad (5)$$

where the last inequality follows from $\mathcal{U}_g(\varphi) \in \mathcal{S}$ for each $\varphi \in \mathcal{S}$ and $g \in \mathcal{G}$, which follows from the second line of Eq. (1). Therefore, χ^* is optimal for Problem (D). ■

The proof of this lemma also shows that if there exists an optimal solution that is proportional to some quantum comb, then there also exists an optimal solution, χ^* , that is proportional to some quantum comb and that satisfies Eq. (2).

Lemma 7 Assume that, for each $t \in \{1, \dots, T\}$, there exists a group $\mathcal{G}^{(t)}$ that has two projective unitary representations $\mathcal{G}^{(t)} \ni g \mapsto U_g^{(t)} \in \text{Uni}_{W_t}$ and $\mathcal{G}^{(t)} \ni g \mapsto \tilde{U}_g^{(t)} \in \text{Uni}_{V_t}$. If $g \mapsto \tilde{U}_g^{(t)}$ is irreducible for each $t \in \{1, \dots, T\}$, then any $\chi^* \in \text{Pos}_{\bar{V}}$ satisfying

$$\begin{aligned} (\mathbb{1}_{W_T \otimes V_T \otimes \dots \otimes W_{t+1} \otimes V_{t+1}} \otimes \text{Ad}_{U_g^{(t)} \otimes \tilde{U}_g^{(t)}} \otimes \mathbb{1}_{W_{t-1} \otimes V_{t-1} \otimes \dots \otimes W_1 \otimes V_1})(\chi^*) &= \chi^*, \\ \forall t \in \{1, \dots, T\}, g \in \mathcal{G}^{(t)} \end{aligned} \quad (6)$$

is proportional to some quantum comb.

Proof It suffices to show that, for each $t \in \{1, \dots, T\}$, $\text{Tr}_{W_t} \chi^*$ is expressed in the form $\text{Tr}_{W_t} \chi^* = I_{V_t} \otimes \chi_t^*$ with $\chi_t^* \in \text{Pos}_{X_t}$, where X_t is the tensor product of all $W_{t'} \otimes V_{t'}$ with $t' \in \{1, \dots, t-1, t+1, \dots, T\}$. Indeed, in this case, one can easily verify that χ^* is proportional to some quantum comb. Let us fix $t \in \{1, \dots, T\}$. Also, let $\chi_s^* := \text{Tr}_{X_t}[(I_{V_t} \otimes s) \text{Tr}_{W_t} \chi^*] \in \text{Pos}_{V_t}$, where $s \in \text{Pos}_{X_t}$ is arbitrarily chosen; then, we have

$$\text{Tr} \chi_s^* = \langle s, \chi' \rangle, \quad \chi' := \text{Tr}_{W_t \otimes V_t} \chi^*. \quad (7)$$

Equation (6) gives $\text{Ad}_{\tilde{U}_g^{(t)}}(\chi_s^*) = \chi_s^*$ [$\forall g \in \mathcal{G}^{(t)}$]. From Schur's lemma, χ_s^* must be proportional to I_{V_t} . Thus, from Eq. (7), $\chi_s^* = \langle s, \chi' \rangle I_{V_t} / N_{V_t}$ holds. We have that for any $s' \in \text{Pos}_{V_t}$,

$$\begin{aligned} \langle s' \otimes s, \text{Tr}_{W_t} \chi^* \rangle &= \langle s', \chi_s^* \rangle = \langle s, \chi' \rangle \langle s', I_{V_t} / N_{V_t} \rangle \\ &= \langle s' \otimes s, I_{V_t} \otimes \chi' / N_{V_t} \rangle. \end{aligned} \quad (8)$$

Since Eq. (8) holds for any s and s' , we have $\text{Tr}_{W_t} \chi^* = I_{V_t} \otimes \chi_t^*$ with $\chi_t^* := \chi' / N_{V_t} \in \text{Pos}_{X_t}$. ■

Now, we are ready to prove Proposition 3. Let C and \mathcal{S} be defined as Eq. (24); then, it is easily seen that Eq. (1) holds. Let e_t be the identity element of $\mathcal{G}^{(t)}$. From Lemma 6, there exists an optimal solution $\chi^* \in \text{Pos}_{\bar{V}}$ to Problem (D) satisfying Eq. (2). Thus, $\mathcal{U}_{(e_T, \dots, e_{t+1}, g_t, e_{t-1}, \dots, e_1)}(\chi^*) = \chi^*$ holds for any $t \in \{1, \dots, T\}$ and $g_t \in \mathcal{G}^{(t)}$, i.e., Eq. (6) holds, which implies from Lemma 7 that χ^* is proportional to some quantum comb. Therefore, Proposition 2 concludes the proof.

Appendix E: Relationship between robustnesses and process discrimination problems

Let us consider the robustness of $\mathcal{E} \in \text{Her}_{\bar{V}}$ defined by

$$R_{\mathcal{K}}^{\mathcal{F}}(\mathcal{E}) := \inf \left\{ \lambda \in \mathbb{R}_+ : \frac{\mathcal{E} + \lambda \mathcal{E}'}{1 + \lambda} \in \mathcal{F}, \mathcal{E}' \in \mathcal{K} \right\}, \quad \mathcal{E} \in \text{Her}_{\bar{V}}, \quad (1)$$

where \mathcal{K} ($\subset \text{Her}_{\bar{V}}$) is a proper convex cone [or, equivalently, \mathcal{K} is a closed convex cone that is pointed (i.e., $\mathcal{K} \cap -\mathcal{K} = \{0\}$) and has nonempty interior] and \mathcal{F} ($\subset \text{Her}_{\bar{V}}$) is a compact set. Assume that the set $\{\lambda Z : \lambda \in \mathbb{R}, 0 \leq \lambda \leq 1, Z \in \mathcal{F}\}$ is convex. In order for this value to be well-defined, we assume that $\mathcal{F} \cap \text{int}(\mathcal{K})$ is not empty. The so-called global (or

generalized) robustness of a state $\rho \in \text{Den}_V$ with respect to $\mathcal{F} \subseteq \text{Den}_V$, defined as [52]

$$R_{\mathcal{F}}(\rho) := \min_{\rho \in \text{Den}_V} \left\{ \lambda \in \mathbb{R}_+ : \frac{\rho + \lambda\rho'}{1 + \lambda} \in \mathcal{F}, \rho' \in \text{Den}_V \right\}, \quad (2)$$

is equal to $R_{\text{Pos}_V}^{\mathcal{F}}(\rho)$. In other words, $R_{\mathcal{F}} : \text{Den}_V \rightarrow \mathbb{R}_+$ is the same function as $R_{\text{Pos}_V}^{\mathcal{F}} : \text{Her}_V \rightarrow \mathbb{R}_+$, but is only defined on Den_V . As an example of $R_{\mathcal{F}}$, if \mathcal{F} is the set of all bipartite separable states, then $R_{\mathcal{F}}(\rho)$ can be understood as a measure of entanglement. The robustness $R_{\mathcal{F}}(\rho)$ is known to represent the maximum advantage that ρ provides in a certain subchannel discrimination problem (e.g., [37, 38]). Similarly, as will be seen in Proposition 10, $R_{\mathcal{K}}^{\mathcal{F}}(\mathcal{E})$ has a close relationship with the maximum advantage that \mathcal{E} provides in a certain discrimination problem.

By letting $Z := (\mathcal{E} + \lambda\mathcal{E}')/(1 + \lambda)$, we can rewrite $R_{\mathcal{K}}^{\mathcal{F}}(\mathcal{E})$ of Eq. (1) as

$$R_{\mathcal{K}}^{\mathcal{F}}(\mathcal{E}) = \min\{\lambda \in \mathbb{R}_+ : (1 + \lambda)Z - \mathcal{E} \in \mathcal{K}, Z \in \mathcal{F}\}. \quad (3)$$

Let

$$\mathcal{N} := \{\mathcal{E} \in \text{Her}_{\tilde{V}} : \delta Z - \mathcal{E} \notin \mathcal{K} (\forall \delta < 1, Z \in \mathcal{F})\}; \quad (4)$$

then, it follows that

$$R_{\mathcal{K}}^{\mathcal{F}}(\mathcal{E}) = \min\{\lambda \in \mathbb{R} : (1 + \lambda)Z - \mathcal{E} \in \mathcal{K}, Z \in \mathcal{F}\}, \quad \forall \mathcal{E} \in \mathcal{N}. \quad (5)$$

We first prove the following two lemmas.

Lemma 8 If $\mathcal{E} \in \mathcal{N}$ holds, then

$$1 + R_{\mathcal{K}}^{\mathcal{F}}(\mathcal{E}) = \max\{\langle \varphi, \mathcal{E} \rangle : \varphi \in \mathcal{K}^*, \langle \varphi, Z \rangle \leq 1 (\forall Z \in \mathcal{F})\} \quad (6)$$

holds.

Proof Let $\tilde{\mathcal{F}} := \text{coni } \mathcal{F}$. $\eta : \tilde{\mathcal{F}} \rightarrow \mathbb{R}_+$ denotes the gauge function of \mathcal{F} , which is defined as

$$\eta(Y) := \min\{\lambda \in \mathbb{R}_+ : Y = \lambda Z, Z \in \mathcal{F}\}, \quad Y \in \tilde{\mathcal{F}}. \quad (7)$$

Note that η is a convex function. Equation (5) gives

$$1 + R_{\mathcal{K}}^{\mathcal{F}}(\mathcal{E}) = \min\{\eta(Y) : Y - \mathcal{E} \in \mathcal{K}, Y \in \tilde{\mathcal{F}}\}. \quad (8)$$

Let us consider the following Lagrangian

$$L(Y, \varphi) := \eta(Y) - \langle \varphi, Y - \mathcal{E} \rangle = \langle \varphi, \mathcal{E} \rangle + \eta(Y) - \langle \varphi, Y \rangle \quad (9)$$

with $Y \in \tilde{\mathcal{F}}$ and $\varphi \in \mathcal{K}^*$. We can easily verify

$$\begin{aligned} \sup_{\varphi \in \mathcal{K}^*} L(Y, \varphi) &= \begin{cases} \eta(Y), & Y - \mathcal{E} \in \mathcal{K}, \\ \infty, & \text{otherwise,} \end{cases} \\ \inf_{Y \in \tilde{\mathcal{F}}} L(Y, \varphi) &= \begin{cases} \langle \varphi, \mathcal{E} \rangle, & \langle \varphi, Y' \rangle \leq \eta(Y') (\forall Y' \in \tilde{\mathcal{F}}), \\ -\infty, & \text{otherwise.} \end{cases} \end{aligned} \quad (10)$$

Thus, the max-min inequality

$$\inf_{Y \in \tilde{\mathcal{F}}} \sup_{\varphi \in \mathcal{K}^*} L(Y, \varphi) \geq \sup_{\varphi \in \mathcal{K}^*} \inf_{Y \in \tilde{\mathcal{F}}} L(Y, \varphi) \quad (11)$$

yields

$$1 + R_{\mathcal{K}}^{\mathcal{F}}(\mathcal{E}) \geq \max\{\langle \varphi, \mathcal{E} \rangle : \varphi \in \mathcal{K}^*, \langle \varphi, Y \rangle \leq \eta(Y) (\forall Y \in \tilde{\mathcal{F}})\}. \quad (12)$$

We now prove the equality of Eq. (12). To this end, it suffices to show that there exists $\varphi \in \text{int}(\mathcal{K}^*)$ such that $\langle \varphi, Y \rangle \leq \eta(Y)$ ($\forall Y \in \tilde{\mathcal{F}}$); indeed, in this case, the equality of Eq. (12) follows from Slater's condition. Arbitrarily choose $\varphi' \in \text{int}(\mathcal{K}^*)$ and let $\gamma := \sup_{Y \in \tilde{\mathcal{F}} \setminus \{0\}} [\langle \varphi', Y \rangle / \eta(Y)]$ [note that $\eta(Y) > 0$ holds for any $Y \in \tilde{\mathcal{F}} \setminus \{0\}$]. Since $\mathcal{F} \cap \text{int}(\mathcal{K})$ is not empty, there exists $Y \in \mathcal{F} \cap \text{int}(\mathcal{K})$ such that $\langle \varphi', Y \rangle > 0$, which yields $\gamma > 0$. Let $\varphi := \gamma^{-1}\varphi' \in \text{int}(\mathcal{K}^*)$; then, we can easily verify $\langle \varphi, Y \rangle \leq \eta(Y)$ ($\forall Y \in \tilde{\mathcal{F}}$).

It remains to show

$$\langle \varphi, Z \rangle \leq 1 (\forall Z \in \mathcal{F}) \Leftrightarrow \langle \varphi, Y \rangle \leq \eta(Y) (\forall Y \in \tilde{\mathcal{F}}). \quad (13)$$

We first prove “ \Rightarrow ”. Arbitrarily choose $Y \in \tilde{\mathcal{F}}$; then, from Eq. (7), there exists $Z \in \mathcal{F}$ such that $Y = \eta(Y)Z$. Thus, $\langle \varphi, Y \rangle = \eta(Y)\langle \varphi, Z \rangle \leq \eta(Y)$ holds. We next prove “ \Leftarrow ”. Arbitrarily choose $Z \in \mathcal{F}$. Since the case $\langle \varphi, Z \rangle \leq 0$ is obvious, we may assume $\langle \varphi, Z \rangle > 0$. Let $Z' := Z/\eta(Z)$; then, from $\eta(Z) \leq 1$, $Z' \in \tilde{\mathcal{F}}$, and $\eta(Z') = 1$, we have $\langle \varphi, Z \rangle \leq \langle \varphi, Z' \rangle \leq \eta(Z') = 1$. ■

Lemma 9 If $\mathcal{E} \in \mathcal{N}$ holds, then we have

$$\max_{\varphi \in \mathcal{X} \setminus \{0\}} \frac{\langle \varphi, \mathcal{E} \rangle}{\max_{Z \in \mathcal{F}} \langle \varphi, Z \rangle} = 1 + R_{\mathcal{K}}^{\mathcal{F}}(\mathcal{E}), \quad (14)$$

where \mathcal{X} is any set such that the cone generated by \mathcal{X} is \mathcal{K}^* , i.e., $\{\lambda\varphi : \lambda \in \mathbb{R}_+, \varphi \in \mathcal{X}\} = \mathcal{K}^*$.

Proof Let

$$\varphi^* := \underset{\varphi \in \mathcal{K}^*, \Gamma(\varphi) \leq 1}{\text{argmax}} \langle \varphi, \mathcal{E} \rangle, \quad \Gamma(\varphi) := \max_{Z \in \mathcal{F}} \langle \varphi, Z \rangle; \quad (15)$$

then, from Eq. (6), we have $\langle \varphi^*, \mathcal{E} \rangle = 1 + R_{\mathcal{K}}^{\mathcal{F}}(\mathcal{E})$. Since $\mathcal{F} \cap \text{int}(\mathcal{K})$ is not empty, $\Gamma(\varphi) > 0$ holds for any $\varphi \in \mathcal{K}^* \setminus \{0\}$. It follows that $\Gamma(\varphi^*) = 1$ must hold [otherwise, $\tilde{\varphi} := \varphi^*/\Gamma(\varphi^*)$ satisfies $\langle \tilde{\varphi}, \mathcal{E} \rangle > \langle \varphi^*, \mathcal{E} \rangle$, $\tilde{\varphi} \in \mathcal{K}^*$, and $\Gamma(\tilde{\varphi}) = 1$, which contradicts the definition of φ^*]. For any $\varphi \in \mathcal{X} \setminus \{0\}$, $\varphi' := \varphi/\Gamma(\varphi)$ satisfies $\langle \varphi, \mathcal{E} \rangle / \Gamma(\varphi) = \langle \varphi', \mathcal{E} \rangle$ and $\Gamma(\varphi') = 1$. Thus, we have

$$\max_{\varphi \in \mathcal{X} \setminus \{0\}} \frac{\langle \varphi, \mathcal{E} \rangle}{\Gamma(\varphi)} = \max_{\substack{\varphi' \in \mathcal{X} \setminus \{0\}, \\ \Gamma(\varphi') = 1}} \langle \varphi', \mathcal{E} \rangle = \langle \varphi^*, \mathcal{E} \rangle = 1 + R_{\mathcal{K}}^{\mathcal{F}}(\mathcal{E}). \quad (16)$$

We should note that, in practical situations, many physically interesting processes belong to \mathcal{N} . As an example, if \mathcal{F} is a subset of all combs in $\text{Her}_{\tilde{V}}$ and $\text{int}(\mathcal{K}^*) \cap \text{Comb}_{W_T, V_T, \dots, W_1, V_1}$ is not empty, then any comb in $\text{Her}_{\tilde{V}}$ belongs to \mathcal{N} . [Indeed, arbitrarily choose $\phi \in \text{int}(\mathcal{K}^*) \cap$

$\text{Comb}_{W_T, V_T, \dots, W_1, V_1}^*$ and a comb $\mathcal{E} \in \text{Her}_{\tilde{V}}$; then, from $\phi \in \text{Comb}_{W_T, V_T, \dots, W_1, V_1}^*$, $\langle \phi, Z \rangle = \langle \phi, \mathcal{E} \rangle = 1$ ($\forall Z \in \mathcal{F}$) holds. Thus, for any $\delta < 1$, $\langle \phi, \delta Z - \mathcal{E} \rangle = \delta - 1 < 0$ holds, which yields $\delta Z - \mathcal{E} \notin \mathcal{K}$. Therefore, we have $\mathcal{E} \in \mathcal{N}$.] For instance, if $\mathcal{F} \subseteq \text{Den}_V$ and $\text{Tr } x > 0$ ($\forall x \in \mathcal{K} \setminus \{0\}$) hold, then any $\rho \in \text{Den}_V$ is in \mathcal{N} . As another example, if $R_{\mathcal{K}}^{\mathcal{F}}(\mathcal{E}) > 0$ holds, then $\mathcal{E} \in \mathcal{N}$ always holds. [Indeed, by contraposition, assume $\mathcal{E} \notin \mathcal{N}$; then, there exists $\delta < 1$ and $Z \in \mathcal{F}$ such that $\delta Z - \mathcal{E} \in \mathcal{K}$. Let $\lambda^* := R_{\mathcal{K}}^{\mathcal{F}}(\mathcal{E})$. It is easily seen from $R_{\mathcal{K}}^{\mathcal{F}}(\mathcal{E}) \geq 0$ that there exists $Z^* \in \mathcal{F}$ such that $(1 + \lambda^*)Z^* - \mathcal{E} \in \mathcal{K}$. Let $p := (1 - \delta)/(\lambda^* + 1 - \delta)$ and $Z' := p(1 + \lambda^*)Z^* + (1 - p)\delta Z$; then, we have $0 \leq p \leq 1$, $Z' \in \mathcal{F}$, and $Z' - \mathcal{E} \in \mathcal{K}$. This implies $R_{\mathcal{K}}^{\mathcal{F}}(\mathcal{E}) = 0$.]

We obtain the following proposition.

Proposition 10 Let us consider $\mathcal{E} \in \mathcal{N}$. Let \tilde{V}' be an arbitrary system. We consider a set of pairs $\mathcal{L} := \{(\{\hat{\mathcal{J}}_m\}_{m=1}^M, \{\Phi_m\}_{m=1}^M)\}$, where $\{\hat{\mathcal{J}}_m : \text{Her}_{\tilde{V}} \rightarrow \text{Her}_{\tilde{V}'}\}_{m=1}^M$ is a collection of linear maps and $\Phi_1, \dots, \Phi_M \in \text{Her}_{\tilde{V}'}$. Assume that the cone generated by

$$\mathcal{X} := \left\{ \sum_{m=1}^M \hat{\mathcal{J}}_m^\dagger(\Phi_m) : (\{\hat{\mathcal{J}}_m\}, \{\Phi_m\}) \in \mathcal{L} \right\} \quad (17)$$

is \mathcal{K}^* , where $\hat{\mathcal{J}}_m^\dagger$ is the adjoint of $\hat{\mathcal{J}}_m$, which is defined as $\langle \hat{\mathcal{J}}_m^\dagger(\Phi'), \mathcal{E}' \rangle = \langle \Phi', \hat{\mathcal{J}}_m(\mathcal{E}') \rangle$ ($\forall \mathcal{E}' \in \text{Her}_{\tilde{V}}, \Phi' \in \text{Her}_{\tilde{V}'}$). Then, we have

$$\max_{(\{\hat{\mathcal{J}}_m\}, \{\Phi_m\}) \in \mathcal{L}} \frac{\sum_{m=1}^M \langle \Phi_m, \hat{\mathcal{J}}_m(\mathcal{E}) \rangle}{\max_{Z \in \mathcal{F}} \sum_{m=1}^M \langle \Phi_m, \hat{\mathcal{J}}_m(Z) \rangle} = 1 + R_{\mathcal{K}}^{\mathcal{F}}(\mathcal{E}), \quad (18)$$

where

$$\mathcal{L}' := \left\{ (\{\hat{\mathcal{J}}_m\}, \{\Phi_m\}) \in \mathcal{L} : \sum_{m=1}^M \hat{\mathcal{J}}_m^\dagger(\Phi_m) \neq \emptyset \right\}. \quad (19)$$

Proof The left-hand side of Eq. (18) is rewritten by

$$\max_{\varphi \in \mathcal{X} \setminus \{0\}} \frac{\langle \varphi, \mathcal{E} \rangle}{\max_{Z \in \mathcal{F}} \langle \varphi, Z \rangle}. \quad (20)$$

Thus, an application of Lemma 9 completes the proof. \blacksquare

The operational meaning of Eq. (18) is as follows. Suppose that $\{\hat{\mathcal{J}}_m\}_m$ is a collection of (unnormalized) processes such that $\sum_{m=1}^M \hat{\mathcal{J}}_m$ is a comb from $\text{Pos}_{\tilde{V}}$ to $\text{Pos}_{\tilde{V}'}$ and that $\{\Phi_k\}_k$ is a tester, where the pair $(\{\hat{\mathcal{J}}_m\}_m, \{\Phi_k\}_k)$ is restricted to belong to \mathcal{L} . We consider the situation that a party, Alice, applies a process $\hat{\mathcal{J}}_m$ to a comb $\mathcal{E} \in \text{Pos}_{\tilde{V}} \cap \mathcal{N}$, and then another party, Bob, applies a tester $\{\Phi_k\}_k$ to $\hat{\mathcal{J}}_m(\mathcal{E})$. The probability of Bob correctly guessing which of the processes $\hat{\mathcal{J}}_1, \dots, \hat{\mathcal{J}}_M$ Alice applies is expressed by $\sum_{m=1}^M \langle \Phi_m, \hat{\mathcal{J}}_m(\mathcal{E}) \rangle$ [note that $\sum_{k=1}^M \sum_{m=1}^M \langle \Phi_k, \hat{\mathcal{J}}_m(\mathcal{E}) \rangle = 1$ holds]. Equation (18) implies that the advantage of \mathcal{E} over all $Z \in \mathcal{F}$ in such a discrimination problem can be exactly quantified by the robustness $R_{\mathcal{K}}^{\mathcal{F}}(\mathcal{E})$. In this situation, $\mathcal{K}^* \subseteq \text{Pos}_{\tilde{V}'}$, i.e., $\mathcal{K} \supseteq \text{Pos}_{\tilde{V}}$, holds.

We give two examples of the application of Proposition 10. The first example is the case $\mathcal{K} = \text{Pos}_{\tilde{V}}$. Let us consider the case where $\sum_{m=1}^M \hat{\mathcal{J}}_m$ can be any comb from $\text{Pos}_{\tilde{V}}$ to $\text{Pos}_{\tilde{V}'}$ and $\{\Phi_k\}_k$ can be any tester. We can easily see that Eq. (18) with $\mathcal{K} = \text{Pos}_{\tilde{V}}$ holds. Note that, for example, Theorem 2 of Ref. [37] and Theorems 1 and 2 of Ref. [38] can be understood as special cases of Proposition 10 with $\mathcal{K} = \text{Pos}_{\tilde{V}}$. The second example is the case $\mathcal{K} \neq \text{Pos}_{\tilde{V}}$. For instance, for a given channel $\hat{\mathcal{E}}$ from a system V to a system W , assume that $\hat{\mathcal{J}}_m$ is the process that applies $\hat{\mathcal{E}}$ to a state $\rho_m \in \text{Den}_V$ with probability p_m [i.e., $\hat{\mathcal{J}}_m(\mathcal{E}) = p_m \text{Tr}_V[(I_W \otimes \rho_m^T)\mathcal{E}]$ holds] and $\{\Phi_k\}_k$ is a measurement of W . Then, we have $\langle \Phi_k, \hat{\mathcal{J}}_m(-) \rangle = p_m \langle \Phi_k \otimes \rho_m^T, - \rangle$. It is easily seen that Eq. (18) with $\mathcal{K}^* = \text{Sep}_{W,V}$ (or, equivalently, $\mathcal{K} = \text{Sep}_{W,V}^*$) holds, where $\text{Sep}_{W,V}$ is the set of all bipartite separable elements in $\text{Pos}_{W \otimes V}$. Note that, for a linear map $\hat{\Psi}$ from V to W , $\Psi \in \text{Sep}_{W,V}^*$ holds if and only if $\hat{\Psi}$ is a positive map.

[1] J. Walgate, A. J. Short, L. Hardy, and V. Vedral, *Phys. Rev. Lett.* **85**, 4972 (2000).
[2] M. A. P. Touzel, R. B. A. Adamson, and A. M. Steinberg, *Phys. Rev. A* **76**, 062314 (2007).
[3] E. Chitambar, M. Hsieh, and R. Duan, *IEEE Trans. Inf. Theory* **60**, 1549 (2014).
[4] S. Bandyopadhyay, A. Cosentino, N. Johnston, V. Russo, J. Watrous, and N. Yu, *IEEE Trans. Inf. Theory* **61**, 3593 (2015).
[5] K. Nakahira and T. S. Usuda, *IEEE Trans. Inf. Theory* **64**, 613 (2018).
[6] M. Sedláč and M. Ziman, *Phys. Rev. A* **90**, 052312 (2014).
[7] Z. Puchała, Ł. Paweła, A. Krawiec, and R. Kukulski, *Phys. Rev. A* **98**, 042103 (2018).
[8] A. Krawiec, Ł. Paweła, and Z. Puchała, *Quant. Inf. Proc.* **19**,

428 (2020).

[9] C. Datta, T. Biswas, D. Saha, and R. Augusiak, *New J. Phys.* **23**, 043021 (2021).
[10] A. Acin, *Phys. Rev. Lett.* **87**, 177901 (2001).
[11] M. F. Sacchi, *Phys. Rev. A* **71**, 062340 (2005).
[12] R. Duan, Y. Feng, and M. Ying, *Phys. Rev. Lett.* **98**, 100503 (2007).
[13] L. Li and D. Qiu, *J. Phys. A: Math. Theor.* **41**, 335302 (2008).
[14] A. W. Harrow, A. Hassidim, D. W. Leung, and J. Watrous, *Phys. Rev. A* **81**, 032339 (2010).
[15] W. Matthews, M. Piani, and J. Watrous, *Phys. Rev. A* **82**, 032302 (2010).
[16] A. Jeňčová and M. Plávala, *J. Math. Phys.* **57**, 122203 (2016).
[17] R. Duan, C. Guo, C.-K. Li, and Y. Li, in *Proc. IEEE Int. Symp.*

- Inf. Theory (ISIT)* (IEEE, 2016) pp. 2259–2263.
- [18] L. Li, S. Zheng, H. Situ, and D. Qiu, *Phys. Rev. A* **96**, 052327 (2017).
- [19] V. Katariya and M. M. Wilde, *arXiv preprint arXiv:2001.05376* (2020).
- [20] G. Chiribella, *New J. Phys.* **14**, 125008 (2012).
- [21] A. S. Holevo, *J. Multivar. Anal.* **3**, 337 (1973).
- [22] V. P. Belavkin, *Stochastics* **1**, 315 (1975).
- [23] M. Ježek, J. Řeháček, and J. Fiurášek, *Phys. Rev. A* **65**, 060301 (2002).
- [24] Y. C. Eldar, A. Megretski, and G. C. Verghese, *IEEE Trans. Inf. Theory* **49**, 1007 (2003).
- [25] Y. C. Eldar, A. Megretski, and G. C. Verghese, *IEEE Trans. Inf. Theory* **50**, 1198 (2004).
- [26] S. M. Barnett and S. Croke, *J. Phys. A: Math. Theor.* **42**, 062001 (2009).
- [27] M. E. Deconinck and B. M. Terhal, *Phys. Rev. A* **81**, 062304 (2010).
- [28] A. Assalini, G. Cariolaro, and G. Pierobon, *Phys. Rev. A* **81**, 012315 (2010).
- [29] D. Ha and Y. Kwon, *Phys. Rev. A* **87**, 062302 (2013).
- [30] J. Bae and W.-Y. Hwang, *Phys. Rev. A* **87**, 012334 (2013).
- [31] T. Singal, E. Kim, and S. Ghosh, *Phys. Rev. A* **99**, 052334 (2019).
- [32] P. Janotta and R. Lal, *Phys. Rev. A* **87**, 052131 (2013).
- [33] M. Piani and J. Watrous, *Phys. Rev. Lett.* **114**, 060404 (2015).
- [34] C. Napoli, T. R. Bromley, M. Cianciaruso, M. Piani, N. Johnston, and G. Adesso, *Phys. Rev. Lett.* **116**, 150502 (2016).
- [35] M. Piani, M. Cianciaruso, T. R. Bromley, C. Napoli, N. Johnston, and G. Adesso, *Phys. Rev. A* **93**, 042107 (2016).
- [36] A. Anshu, M.-H. Hsieh, and R. Jain, *Phys. Rev. Lett.* **121**, 190504 (2018).
- [37] R. Takagi, B. Regula, K. Bu, Z.-W. Liu, and G. Adesso, *Phys. Rev. Lett.* **122**, 140402 (2019).
- [38] R. Uola, T. Kraft, J. Shang, X.-D. Yu, and O. Gühne, *Phys. Rev. Lett.* **122**, 130404 (2019).
- [39] R. Takagi and B. Regula, *Phys. Rev. X* **9**, 031053 (2019).
- [40] M. Oszmaniec and T. Biswas, *Quantum* **3**, 133 (2019).
- [41] G. Chiribella, G. M. D’Ariano, and P. Perinotti, *Phys. Rev. Lett.* **101**, 060401 (2008).
- [42] O. Oreshkov, F. Costa, and Č. Brukner, *Nat. Commun.* **3**, 1 (2012).
- [43] T. Colnaghi, G. M. D’Ariano, S. Facchini, and P. Perinotti, *Phys. Lett. A* **376**, 2940 (2012).
- [44] G. Chiribella, *Phys. Rev. A* **86**, 040301 (2012).
- [45] G. Chiribella, G. M. D’Ariano, P. Perinotti, and B. Valiron, *Phys. Rev. A* **88**, 022318 (2013).
- [46] J. Bavaresco, M. Murao, and M. T. Quintino, *Phys. Rev. Lett.* **127**, 200504 (2021).
- [47] K. Nakahira and K. Kato, *Phys. Rev. A* **103**, 062606 (2021).
- [48] Q. Zhuang and S. Pirandola, *Phys. Rev. Lett.* **125**, 080505 (2020).
- [49] B. Regula, *J. Phys. A: Math. Theor.* **51**, 045303 (2017).
- [50] E. Chitambar and G. Gour, *Rev. Mod. Phys.* **91**, 025001 (2019).
- [51] A. Dhara and J. Dutta, *Optimality conditions in convex optimization: a finite-dimensional view* (CRC Press, 2011).
- [52] A. W. Harrow and M. A. Nielsen, *Phys. Rev. A* **68**, 012308 (2003).