

FIXMYPOSE: Pose Correctional Captioning and Retrieval

Hyoungun Kim*, Abhay Zala*, Graham Burri, Mohit Bansal

Department of Computer Science
University of North Carolina at Chapel Hill
{hyoungk, aszala, ghburri, mbansal}@cs.unc.edu

Abstract

Interest in physical therapy and individual exercises such as yoga/dance has increased alongside the well-being trend, and people globally enjoy such exercises at home/office via video streaming platforms. However, such exercises are hard to follow without expert guidance. Even if experts can help, it is almost impossible to give personalized feedback to every trainee remotely. Thus, automated pose correction systems are required more than ever, and we introduce a new captioning dataset named FIXMYPOSE to address this need. We collect natural language descriptions of correcting a “current” pose to look like a “target” pose. To support a multilingual setup, we collect descriptions in both English and Hindi. The collected descriptions have interesting linguistic properties such as egocentric relations to the environment objects, analogous references, etc., requiring an understanding of spatial relations and commonsense knowledge about postures. Further, to avoid ML biases, we maintain a balance across characters with diverse demographics, who perform a variety of movements in several interior environments (e.g., homes, offices). From our FIXMYPOSE dataset, we introduce two tasks: the pose-correctional-captioning task and its reverse, the target-pose-retrieval task. During the correctional-captioning task, models must generate the descriptions of how to move from the current to the target pose image, whereas in the retrieval task, models should select the correct target pose given the initial pose and the correctional description. We present strong cross-attention baseline models (uni/multimodal, RL, multilingual) and also show that our baselines are competitive with other models when evaluated on other image-difference datasets. We also propose new task-specific metrics (object-match, body-part-match, direction-match) and conduct human evaluation for more reliable evaluation, and we demonstrate a large human-model performance gap suggesting room for promising future work. Finally, to verify the sim-to-real transfer of our FIXMYPOSE dataset, we collect a set of real images and show promising performance on these images.¹

1 Introduction

As the well-being trend grows and people globally move to a new online lifestyle, interest in remotely (i.e., at home or

Copyright © 2021, Association for the Advancement of Artificial Intelligence (www.aaai.org). All rights reserved.

*Equal contribution.

¹Data/code publicly available: <https://fixmypose-unc.github.io>



Description 1 (English): slide your right foot back one step and bend your knees, bring your wrists closer to your shoulders but maintain the position of your hands, finally drop your arms at the shoulder to level your hands with your neck.

Description 2 (English): bend both of your legs. bring both of your arms down almost below your ears. your left palm should be facing towards the chair. the back of your right hand should be facing the glass table.

Description 3 (English): bend both knees away from the lamp, lower down your body towards the rug, bring both hands down above your shoulder, right palm facing front and left palm facing the chair, tilt your head back a little towards the lamp.

Description 1 (Hindi): अपने दाहिने पैर को एक कदम पीछे खिसकाएं और अपने घुटनों को मोड़ें, अपनी कलाई को अपने कंधों के करीब लाएं लेकिन अपने हाथों की स्थिति को बनाए रखें, अंत में अपनी गर्दन के साथ अपने हाथों को समतल करने के लिए अपने हाथों को कंधे पर रखें।

Figure 1: Current and target image pair and the corresponding correctional descriptions in both English and Hindi (we show only one of the three Hindi descriptions due to space).

in the office) learning health and exercise activities such as yoga, dance, and physical therapy is growing. Through advanced video streaming platforms, people can watch and follow the physical movements of experts, even without the expert being physically present (and hence scalable and less expensive). For such remote activities to be more effective, appropriate feedback systems are needed. For example, a feedback system should catch errors from the user’s movements and give proper guidance to correct their poses. Related to this line of work, many efforts have been made on human pose estimation and action recognition (Johnson and Everingham 2010, 2011; Andriluka et al. 2014; Toshev and Szedgy 2014; Wei et al. 2016; Andriluka et al. 2018; Yan, Xiong, and Lin 2018; Zhao et al. 2019; Cao et al. 2019; Sun et al. 2019; Verma et al. 2020; Rong, Shiratori, and Joo 2020). Research on describing the difference between multiple images has also been recently active (Jhamtani and Berg-Kirkpatrick 2018; Tan et al. 2019; Park, Darrell, and Rohrbach 2019; Forbes et al. 2019). However, there has been less focus on the human pose-difference captioning tasks, which require solving unique challenges such as understanding spatial relationships between multiple body parts and

their movements. Moreover, the reverse task of retrieving or generating a target pose is also less studied. Combining these two directions together can allow for more interweaving human-machine communication in future automated exercise programs.

Relatedly, interest in embodied systems for effective human-agent communication is increasing (Kim et al. 2018; Wang, Smith, and Ruiz 2019; Abbasi et al. 2019; Kim et al. 2020). Embodiment is also a desirable property when designing virtual assistants that provide feedback. For example, embodied virtual agents can show example movements to users or point at the users’ body parts that need to move. Furthermore, for effective two-way communication with embodied agents, reverse information flow (i.e., human to agents) is also needed. A user may want to describe what actions they took so that the agent can confirm whether the user moved correctly or needs to change their movement. The agent should also be able to move its body to match the pose that the user is describing to help itself understand.

Therefore, to encourage the multimodal AI research community to explore these two tasks, we introduce a new dataset on detailed pose correctional descriptions called FIXMYPOSE (फिक्समाइपोज़), which consists of image pairs (a “current” and “target” image) and corresponding correctional descriptions in both English and Hindi (Fig. 1). To understand our dataset, imagine you are in a physical therapy program following an instructor in a prerecorded video at home. Your movements and resulting pose are likely to be wrong, hence, you would like a virtual AI assistant to provide detailed verbal guidance on how you can adjust to match the pose of the instructor. In this case, your incorrect pose is in the “current” image and the pose of the instructor is in the “target” image, forming a pair. The verbal guidance from the virtual AI assistant is the correctional description.

From our FIXMYPOSE dataset, we introduce two tasks for multimodal AI/NLP models: the ‘pose-correctional-captioning’ task and the ‘target-pose-retrieval’ task. In the pose-correctional-captioning task, models are given the “current” and “target” images and should generate a correctional description. The target-pose-retrieval task is the reverse of the pose-correctional-captioning task, where models should select the correct “target” image among other distractor images, given the “current” image and description. This two-task setup will test AI capabilities for both important directions in pose correction (i.e., agents generating verbal guidance for human pose correction, and reversely predicting/generating poses given instructions), to enable two-way communication between humans and embodied agents in future research. To generate image pairs, we implement realistic 3D interior environments (see Sec. 4 for details). We also extract body joint data from characters to allow diverse tasks such as pose-generation (Fig. 4). We collect descriptions for these image pairs by asking annotators from a crowdsourcing platform to explain to the characters how to adjust their pose shown in the “current” image to the one shown in the “target” image in an instructional manner from the characters’ egocentric view (see Table 1). Furthermore, we ask them to refer to objects in the environment to create



Figure 2: Example room environments: each room has a diverse style/theme (e.g., office, bathroom, living room).

more detailed and accurate correctional descriptions, adding diversity and requiring models to understand the spatial relationships between body parts and environmental objects. The descriptions also often describe movement indirectly through implicit movement descriptions and analogous references (e.g., “like you are holding a cane”) (see Sec. 5.2), which means AI models performing this task should develop a commonsense understanding of these movements and references. To encourage multimodal AI systems to expand beyond English, we include Hindi descriptions as well (Fig. 1).

Empirically, we present both unimodal and multimodal baseline models as strong starting points for each task, where we apply multiple cross-attention layers to integrate vision, body-joints, and language features. For the pose-correctional-captioning model, we employ reinforcement learning (RL), which uses self-critical sequence training (Rennie et al. 2017), for further improvement. Also, we present the results from a multilingual training setup (English+Hindi) which uses fewer parameters by sharing model components, but shows comparable scores.

The multimodal models in both tasks show better performance than unimodal models, across both qualitative human evaluation and several of the evaluation metrics, including our new task-specific metrics: object, body-part, and direction match (details in Sec. 8.1). There is also a large human-model performance gap on the tasks, allowing useful future work on our challenging dataset. We also show balanced scores on demographic ablations, implying that our dataset is not biased toward a specific subset. Furthermore, our model performs competitively with existing works when evaluated on other image-difference datasets (Image Editing Request (Tan et al. 2019), NLVR2 (Suhr et al. 2019), and CLEVR-Change (Park, Darrell, and Rohrbach 2019)). Finally, to verify the simulator-to-real transfer of our FIXMYPOSE dataset, we collect a test-real split which consists of real-world image pairs and corresponding descriptions, and show promising performance on the real images.

Our contributions are 3-fold: (1) We introduce a new dataset, FIXMYPOSE, to encourage research on the integrated field of human pose, correctional feedback systems on feature differences with spatial relation understanding, and embodied multimodal virtual agents; (2) We collect a multilingual (English/Hindi) dataset; (3) We propose two

tasks based on our FIXMYPOSE dataset (pose-correctional-captioning and target-pose-retrieval), and present several strong baselines as useful starting points for future work (and also demonstrate sim-to-real transfer).

2 Related Work

Image Captioning. Describing image contents in natural language has been actively studied (Xu et al. 2015; Yang et al. 2016; Rennie et al. 2017; Lu et al. 2017; Anderson et al. 2018a; Melas-Kyriazi, Rush, and Han 2018; Yao et al. 2018). This progress has been encouraged by the introduction of large-scale captioning datasets (Hodosh, Young, and Hockenmaier 2013; Lin et al. 2014; Plummer et al. 2015; Krishna et al. 2017; Johnson, Karpathy, and Fei-Fei 2016; Krause et al. 2017). Recently, more diverse image captioning tasks, which consider two images and describes the difference between them, have been introduced (Jhamtani and Berg-Kirkpatrick 2018; Tan et al. 2019; Park, Darrell, and Rohrbach 2019; Forbes et al. 2019). However, to the best of our knowledge, there exists no captioning dataset about describing human pose differences. Describing pose difference or body movement requires detailed multi-focus over all body parts and understanding relations between them, introducing new challenges for AI agents. This kind of dataset is promising because of its potential real-world applications in activities such as yoga, dance, and physical therapy.

Human Pose. Human pose estimation and action recognition have been a long-standing topic in the research community (Johnson and Everingham 2010, 2011; Andriluka et al. 2014; Toshev and Szegedy 2014; Wei et al. 2016; Andriluka et al. 2018; Yan, Xiong, and Lin 2018; Zhao et al. 2019; Cao et al. 2019; Sun et al. 2019; Verma et al. 2020; Rong, Shiratori, and Joo 2020). Recently, researchers are also focusing on generation tasks which generate a body pose sequence from an input of a different type from another modality such as audio or spoken language (Shlizerman et al. 2018; Tang, Jia, and Mao 2018; Lee et al. 2019; Zhuang et al. 2020; Saunders, Camgoz, and Bowden 2020). However, there have been no research attempts on text generation based on pose correction. Thus, our novel FIXMYPOSE dataset will encourage the community to explore this new direction.

Spatial Relationships. Understanding spatial relationships between objects is an important capability for AI agents. Thus, the topic has attracted much attention from researchers (Bisk, Marcu, and Wong 2016; Wang, Liang, and Manning 2016; Li et al. 2016; Bisk et al. 2018). Our FIXMYPOSE dataset is rich in such reasoning about spatial relations with a variety of expressions (not only simple directions of left/right/up/down). Moreover, all the spatial relationships in the descriptions of the FIXMYPOSE dataset are considered from the characters’ egocentric perspective, requiring models to understand the characters’ viewpoints.

Virtual Assistants. Virtual AI assistants such as Alexa, Google Assistant, Cortana, and Siri are already ubiquitous in our lives. However, there has been an increasing demand for multimodal (i.e., vision+language) virtual AI assistants, and as robotic and virtual/augmented/mixed reality technologies grow, so does interest in embodied virtual assistants (Kim

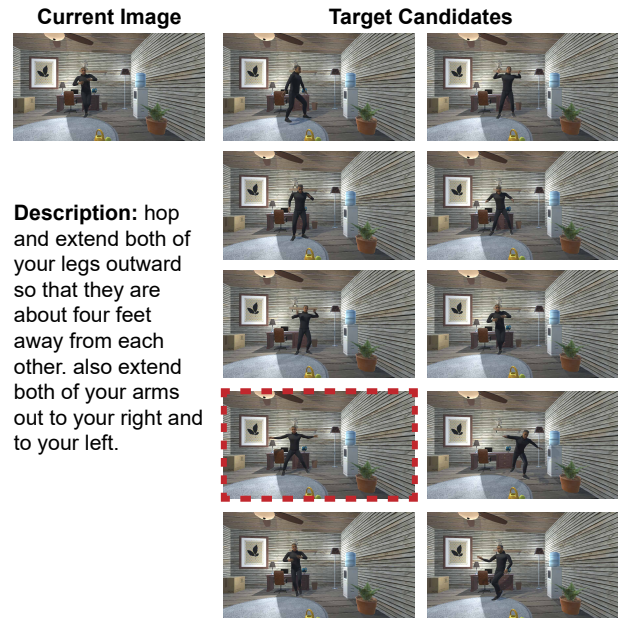

Figure 3: The target-pose-retrieval task: models have to select the correct “target” image from a set of distractors (the image with red dashed border is the ground-truth target pose), given “current” image and correctional description.

et al. 2018; Wang, Smith, and Ruiz 2019; Abbasi et al. 2019; Kim et al. 2020). Our FIXMYPOSE dataset will contribute to the evolution of embodied multimodal virtual assistants by providing a novel dataset as well as proposing a new approach on how to integrate physical movement guidance with virtual AI assistants.

3 Tasks

Pose Correctional-Captioning Task. During this task, the goal is to generate natural language (NL) correctional descriptions, considering the characters’ egocentric view, that describe to a character how they should adjust their pose shown in the “current” image to match the pose shown in the “target” image (Fig. 1). As the “current” and “target” image pairs contain various objects in realistic room environments, models should have the ability to understand the spatial relationships between the body parts of characters and the environment from the characters’ perspectives.

Target Pose Retrieval Task. Here, the goal is to select the correct “target” image among 9 incorrect distractors, given the “current” image and the corresponding correctional description (Fig. 3). For the distractor images, we only consider images that are close to the “target” pose in terms of body joints distances (see Appendix A for detailed criteria). These distractor choices discourage models from easily discerning the correct “target” image via shallow inference or shortcuts, requiring minute differences to be captured by models. The large human-model performance gap (Sec. 8.2) verifies the quality of our distractors.

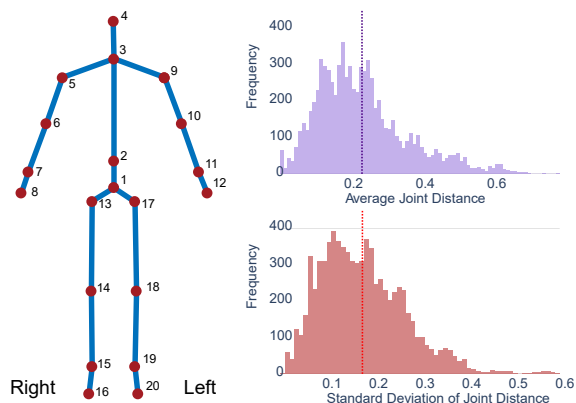

Figure 4: The 3D joint configuration of characters (left). The distribution of joint distances (meters) between poses of the “current” and “target” images (right). The Avg. of Min joint distances: 0.04 and the Avg. of Max joint distances: 0.65.

4 Dataset

Our FIXMYPOSE dataset is composed of image pairs with corresponding correctional descriptions in English/Hindi.

Image, 3D Body Joints, and Environment Generation.

We create 25 realistic 3D diverse room environments, filled with varying items (Fig. 2). To ensure diversity, we employ 6 human character avatars of different demographics across gender/race (each character is equally balanced in our dataset).² Since creating/modifying the body of characters requires 3D modeling/artistic expertise, we use pre-made character models that are publicly available (hence also copyright-free for our community’s future use) in Adobe’s Mixamo³. In the rooms, the characters perform 20 movement animations and the camera captures images on a fixed interval. We also obtain 3D positional body joint data of the character’s poses in the “current” and “target” images to provide additional useful features and allow a potential reverse pose-generation task (Fig. 4). See Appendix B.1 for more on animation examples, environment creation, body joint data, and image capturing.

Description Collection. We employ annotators from the crowdsourcing platform Amazon Mechanical Turk⁴ to collect the correctional descriptions. Workers are provided 3 images, “current”, “target” images, and a “difference” image that shows the difference between the two images, allowing them to write clear descriptions (see Appendix B for the images and collection interface). We ask them to write as if they are speaking to the characters as assistants who are

²Our task focuses on understanding body movements/angles and not demographics, but we still ensure demographic diversity and balance in our dataset for ethical/fairness purposes so as to avoid unintended biases (e.g., see the balanced demographics ablation results and Sim-to-Real Transfer results on people with different demographics with respect to the 6 character avatars in Sec. 8). We plan to further expand our dataset with other types of diversity (e.g., height, age) based on digital avatar availability.

³<https://www.mixamo.com>

⁴<https://www.mturk.com>

helping them (like “You should ...”), not calling them by the 3rd person (like “The person ...”, “They/She/He ...”). It also helps prevent accidental biased terms assuming the demographics of the characters. We collect 1 description for each image pair for the train split and 3 for all subsequent splits (i.e., val-seen/val-unseen/test-unseen) from unique workers, making the computation of automated evaluation metrics such as BLEU possible.

Description Verification. Each description and its corresponding image pair is given to a separate group of workers through a verification task. For each description, 3 different workers are asked to rank it from 1-4 based on its relevance to the image pair and its clarity, similar to previous works (Lei et al. 2020). Descriptions that 2/3 of the workers rate lower than 3 are discarded. Image pairs that are flagged with certain issues are discarded as they do not provide good data (see Appendix B.2 for the verification interface and flags).

Hindi Data Collection. To collect the translated Hindi descriptions, we present a translation task to workers. Workers are given a description that has passed the verification task and its corresponding image pair to ensure the original meaning is not lost (see Appendix B.2 for the translation interface).

Worker Qualification and Payment. We require workers completing either of the tasks to be fluent in the needed languages and to have basic MTurk qualifications. The writing task takes around 1 minute and workers are paid \$0.18 per description. To encourage workers to write more and better descriptions, an additional increasing-bonus system is implemented. See Appendix B.4 for qualification/bonus/payment details.

5 Data Analysis

We collect 7,691 image pairs and 11,127 correctional descriptions for both English and Hindi (1 per train and 3 per evaluation splits). Our dataset size is comparable to other captioning tasks/datasets such as Image Editing Request (Tan et al. 2019) (3.9K image pairs/5.7K instructions), Spot-the-Diff (Jhamtani and Berg-Kirkpatrick 2018) (13.2K image pairs/captions), and Birds-to-Words (Forbes et al. 2019) (3.3K image pairs/16K paragraphs). We plan to keep extending the dataset and add other languages in the future.

5.1 Statistics

Joint Distances. Fig. 4 shows the distribution of average joint distances (meters) between the poses in the “current” and “target” images. As indicated by the mean (0.24m), std-dev (0.18m), and min/max (0.04/0.65m) of the average distance of individual joints, models should be able to capture different movement levels simultaneously in an image pair.

Description Vocabulary and Length. The collection of descriptions in our FIXMYPOSE dataset has 4,045/4,674 unique English/Hindi words. The most common words in both languages (see Appendix C.1 for details and pie charts) relate to direction, body parts, and movement, showing that models need to have a sense of direction with respect to

Reference Frame	Freq.	Example (English)
Egocentric Relation	100%	"... rotate your left shoulder so that your hand is above your elbow ..."
Environmental Direction	52%	"... turn your left leg and right leg to the left to face the wall with the door ..."
Implicit Movement Description	58%	"... lean your body towards and slightly over your right leg ..."
Analogous Reference	18%	"... in front of you as if you are gesturing for someone to stop ..."

Table 1: Examples of linguistic properties in correctional descriptions (see Appendix C.3 for examples and image examples of implicit movement description).

body parts and objects, and also capture the differences between the poses to infer the proper movements. The average length of the multi-sentenced descriptions (49.25/52.74 words) is high, indicating that they are well detailed (see Appendix C.2 for details).

5.2 Linguistic Properties

To investigate the diverse linguistic properties in our dataset, we randomly sample 50 descriptions and manually count occurrences of traits. We found interesting traits (see Table 1 and Appendix C.3 for examples), requiring agents to deeply understand characters’ movements and express them in an applicable form (the Hindi descriptions also share these traits).

Egocentric and Environmental Direction. Descriptions in our FIXMYPOSE dataset are written considering the egocentric (first-person) view of the character. Descriptions also reference many environmental objects and their relation to the characters’ body parts, again from an egocentric view. This means models must understand spatial relations of body parts and environmental features from the egocentric view of the character rather than the view of the “camera”.

Implicit Movement Description and Analogous Reference. Implicit movement description and analogous reference are often present in descriptions. These descriptions imply movements without needing to say them. Analogous references are a more extreme form of implicit movement description, where the movement is wrapped in an analogy. Models must develop commonsense knowledge of these movements in order to understand their meaning. See Table 1 and Appendix C.3 for examples.

6 Models

We present multiple strong baselines for both the pose-correctional-captioning and target-pose-retrieval task (Fig. 5) to serve as starting points for future work.

6.1 Pose Correctional Captioning Model

We employ an encoder-decoder model for the pose-correctional-captioning task. Also, we apply reinforcement learning (RL) after training the encoder-decoder model, and present multilingual training setup which reduces the number of parameters through parameter sharing.

Encoder. We employ ResNet (He et al. 2016) to obtain visual features from images. To be specific, we extract feature maps f^c and $f^t \in \mathbb{R}^{N \times N \times 2048}$ from the “current” pose image I^c and the “target” pose image I^t , respectively: $f^c = \text{ResNet}(I^c)$; $f^t = \text{ResNet}(I^t)$. For 3D joints, $J^c, J^t \in \mathbb{R}^{20 \times 3}$, we use linear layer to encode: $\hat{J}^c = \text{PE}(W_j^\top J^c)$; $\hat{J}^t = \text{PE}(W_j^\top J^t)$; $J^d = \text{PE}(W_j^\top (J^t - J^c))$, where W_j is the trainable parameter (all W_* from this point on denote trainable parameters) and PE (Gehring et al. 2017; Vaswani et al. 2017) denotes positional encoding.

Decoder. Words from a description, $\{w_t\}_{t=1}^T$, are embedded in the embedding layer: $\hat{w}_{t-1} = \text{Embed}(w_{t-1})$, then sequentially fed to the LSTM layer (Hochreiter and Schmidhuber 1997): $h_t = \text{LSTM}(\hat{w}_{t-1}, h_{t-1})$. We employ the bidirectional attention mechanism (Seo et al. 2017) to align image features and joints features.

$$\tilde{f}^c, \tilde{J}^t, \tilde{f}^t, \tilde{J}^c = \text{CA-Stack}(f^c, \hat{J}^c, f^t, \hat{J}^t) \quad (1)$$

where CA-Stack is a cross attention stack (see Appendix D).

$$f = W_c^\top [\tilde{f}^c; \tilde{f}^t; \tilde{f}^c \odot \tilde{f}^t], J = W_c^\top [\tilde{J}^c; \tilde{J}^t; \tilde{J}^c \odot \tilde{J}^t] \quad (2)$$

$$f_t = \text{Att}(h_t, f), J_t = \text{Att}(h_t, J), J_t^d = \text{Att}(h_t, J^d) \quad (3)$$

$$k_t = W_k^\top [f_t; J_t; h_t; h_t \odot f_t; h_t \odot J_t] \quad (4)$$

$$g_t = W_s^\top [k_t; J_t^d] \quad (5)$$

where Att is general attention (see Appendix D for details). The next token is: $w_t = \text{argmax}(g_t)$, and the loss is: $L_{ML} = -\sum_t \log p(w_t^* | w_{1:t-1}^*, f, J)$, where w_t^* is the GT token.

RL Training. We apply the REINFORCE algorithm (Williams 1992) to learn a policy p_θ upon the model pre-trained with the maximum likelihood approach: $L_{RL} = -\mathbb{E}_{w^s \sim p_\theta} [r(w^s)]$; $\nabla_\theta L_{RL} \approx -(r(w^s) - b) \nabla_\theta \log p_\theta(w^s)$, where w^s is a description sampled from the model, $r(\cdot)$ is the reward function, and b is the baseline. We employ the SCST training strategy (Rennie et al. 2017) and use the reward for descriptions from the greedy decoding (i.e., $b = r(w^g)$) as the baseline. We also employ CIDER as the reward, following Rennie et al. (2017)’s observation (using CIDER as a reward improves overall metric scores). We follow the mixed loss strategy setup (Wu et al. 2016; Paulus, Xiong, and Socher 2018): $L = \gamma_1 L_{ML} + \gamma_2 L_{RL}$.

Multilingual Parameter Sharing. We implement the multilingual training setup by sharing parameters between English and Hindi models, except the parameters of word embeddings, description LSTMs, and final fully connected layers, making the total number of parameters substantially less than those needed for the separate two models summed.

6.2 Target Pose Retrieval Model

The current and target candidate images are encoded the same way as the captioning model. A bidirectional LSTM encodes the descriptions: $c = \text{BiLSTM}(\hat{w})$. Image features are aligned with description features via cross attention.

$$\tilde{c}^c, \tilde{f}^{t_i}, \tilde{c}^{t_i}, \tilde{f}^c = \text{CA-Stack}(c, f^c, c, f^{t_i}) \quad (6)$$

$$k_{1i} = \text{Self-Gate}([\tilde{c}^c; \tilde{c}^{t_i}; \tilde{c}^c \odot \tilde{c}^{t_i}]) \quad (7)$$

$$g_{1i} = \text{Self-Gate}([\tilde{f}^{t_i}; \tilde{f}^c; \tilde{f}^{t_i} \odot \tilde{f}^c]) \quad (8)$$

Language	Models	Automated Metrics				Task-Specific Metrics			Human Eval.	
		B4	C	M	R	object-match	body-part-match	direction-match	R	F/G
English	V-Only	6.90	6.41	16.78	30.09	0.04	1.01	0.05	4%	4%
	L-Only	17.74	11.42	22.14	35.16	0.08	1.22	0.15	15%	27%
	V+L	17.55	14.47	21.29	35.21	0.18	1.29	0.13	48%	45%
Hindi	V-Only	8.43	4.37	18.90	28.55	0.03	1.21	0.02	9%	10%
	L-Only	25.42	11.41	29.68	36.90	0.0	1.42	0.07	19%	26%
	V+L	18.99	8.58	29.26	34.73	0.08	1.63	0.10	51%	53%

Table 2: The performance of the unimodal and multimodal models on automated metrics, our new task-specific metrics, and human evaluation. for both English and Hindi dataset on the val-seen split (B4: BLEU-4, C: CIDEr, M: METEOR, R: ROUGE, V: Vision+Joints, L: Language, R: Relevancy, F/G: Fluency and Grammar).

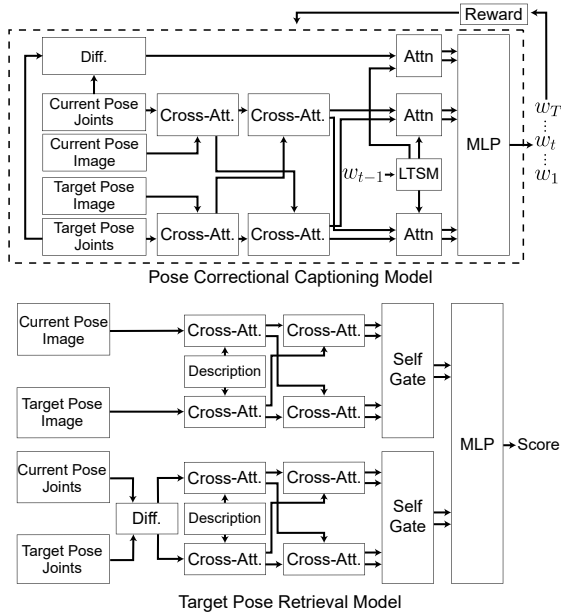

Figure 5: The pose-correctional-captioning model (top) and the target-pose-retrieval model (bottom).

where \odot is the element-wise product (see Appendix D for details of the Self-Gate). For joints feature, we calculate the difference between the two joints set: $J^{dti} = W_j^\top (J^{ti} - J^c)$; $J^{dc_i} = W_j^\top (J^c - J^{ti})$. We apply the same process that the image features go through (i.e., Eq. 6-8) to get k_{2i} and g_{2i} .

$$p_i = W_p^\top [k_{1i}; g_{1i}; k_{1i} \odot g_{1i}] \quad (9)$$

$$q_i = W_q^\top [k_{2i}; g_{2i}; k_{2i} \odot g_{2i}] \quad (10)$$

$$s_i = W_s^\top [p_i; q_i; p_i \odot q_i] \quad (11)$$

The score s_i is calculated for each target candidate and the one with the highest score is considered as the predicted one: $\hat{t} = \text{argmax}([s_0; s_1; \dots; s_9])$.

7 Experimental Setup

Data Splits. For the pose-correctional-captioning task, we split the dataset into train/val-seen/val-unseen/test-unseen following Anderson et al. (2018b). We assign separate rooms to val-unseen and test-unseen splits for evaluating



Figure 6: An example from Sim-To-Real transfer dataset.

Language	Models	B4	C	M	R
English	V+L	17.55	14.47	21.29	35.21
	(-) Joints	17.39	13.79	21.35	34.86
	(+) RL	18.69	16.04	22.35	36.18
	(+) Multi-L	19.08	15.71	22.47	36.46
Hindi	V+L	18.99	8.58	29.26	34.73
	(-) Joints	18.23	7.93	27.55	34.12
	(+) RL	18.57	9.63	28.83	34.76
	(+) Multi-L	18.67	9.77	29.05	34.74

Table 3: Model ablations on val-seen split (RL: reinforcement learning, Multi-L: multilingual).

model’s ability to generalize to unseen environments. The number of task instances for each split is 5,973/562/563/593 (train/val-seen/val-unseen/test-unseen) and the number of descriptions is 5,973/1,686/1,689/1,779. For the target-pose-retrieval task, we split the dataset into train/val-unseen/test-unseen. In this task, “unseen” means “unseen animations”. We split the dataset by animations so that the task cannot be easily done by memorizing/capturing patterns of certain animations in the image pairs. After filtering for the target candidates (see Sec. 3), we obtain 4,227/1,184/1,369 (train/val-unseen/test-unseen) instances. See Appendix E.1 for the detailed room and animation assignments.

Training Details. We use 512 as the hidden size and 256 as the word embedding dimension. We use Adam (Kingma and Ba 2015) as the optimizer. See Appendix E.3 for details.

Metrics. For the pose-correctional-captioning task, we employ automatic evaluation metrics: BLEU-4 (Papineni et al. 2002), CIDEr (Vedantam, Lawrence Zitnick, and Parikh 2015), METEOR (Banerjee and Lavie 2005), and ROUGE-L (Lin 2004). Also, motivated by previous efforts towards more reliable evaluation (Wiseman, Shieber, and Rush

Dataset	Model	B4	C	M	R
Image Editing Request Tan et al. (2019)	DRA	6.72	26.36	12.80	37.25
	Ours	7.88	27.70	12.53	37.56
NLVR2 Suhr et al. (2019)	DRA	5.00	46.41	10.37	22.94
	Ours	5.30	45.09	10.53	22.79
CLEVR-Change (SC) Park et al. (2019)	DUDA	42.9	94.6	29.7	-
	Ours	44.0	98.7	33.4	65.5

Table 4: Our baseline V+L model performs competitively on other image-difference captioning datasets (DRA: Dynamic Relation Attention (Tan et al. 2019), DUDA: Dual Dynamic Attention Model (Park, Darrell, and Rohrbach 2019); SC = Scene Change).

2017; Serban et al. 2017; Niu and Bansal 2019; Zhang et al. 2019; Sellam, Das, and Parikh 2020), we introduce new task-specific metrics to capture the important factors. Object-match counts correspondences of environment objects, body-part-match counts common body parts mentioned, and direction-match counts the (body-part, direction) pair match between the model output and the ground-truth (see Appendix E.4 for more information on direction-match). In the target-pose-retrieval task, we use the accuracy of the selection as the performance metric.

Human Evaluation Setup. We conduct human evaluation for the pose-correctional-captioning task models to compare the output of the vision-only model, the language-only model, and the full vision+language model qualitatively. We sample 100 descriptions from each model (val-seen split), then asked crowd-workers to vote for the most relevant description in terms of the image pair, and for the one best in fluency/grammar (or ‘tied’). Separately, to set the performance upper limit and to verify the effectiveness of our distractor choices for the target-pose-retrieval task, we conduct another human evaluation. We sample 50 instances from the target-pose-retrieval test-unseen split and ask an expert to perform the task for both English and Hindi samples. See Appendix E.2 for more details.

Unimodal Model Setup. We implement unimodal models (vision-/language-only) for comparison with the multimodal models. See Appendix E.5 for more details.

Other Image-Difference Datasets. We also evaluate our baseline model on other image-difference datasets to show that the baseline is strong and competitive: Image Editing Request (Tan et al. 2019), NLVR2 (Suhr et al. 2019) (the variant from Tan et al. (2019)), and CLEVR-Change (Park, Darrell, and Rohrbach 2019).

Sim-to-Real Transfer. To verify the possibility of the transfer of our simulated image dataset to real images, we collect real image pairs of current and target poses. We randomly sample 60 instances from test-unseen split (test-sim) and then the authors and their family members⁵ follow the poses in the sampled test-sim split to create the real image version (test-real). Since the environments (thus objects and their

⁵Hence covering diverse demographics, including some that are different from the simulator data splits, as well as different room environments. All participants consented to the collection of images (and additionally, we blur all faces).

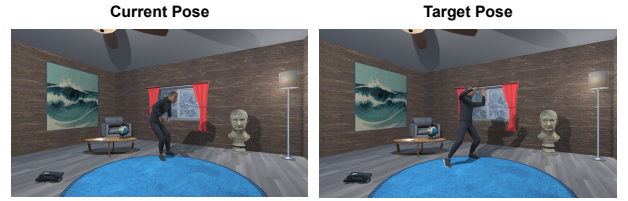

Predicted: you need to bring your right foot to the right and then finally bring your right arm up to be at shoulder height and your right hand up in front of your face
Ground Truth 1: pull your left foot in right next to your right foot extend your right foot out about 2 feet opposite the direction of the right curtain on the window lift up both hands so that they are in front of your face about a foot from each other and a foot from your face
Ground Truth 2: you need to bring your right foot to the right and have that leg slightly straightened you also need to have your back more up right. then finally bring your head to face more forwards then place both your hands up at head height but keep your elbows at the side
Ground Truth 3: move your right foot to the right towards the telephone bring your body and head back towards the coffee table and lean to the window move your hands up in front of your head.



Predicted: अपने बाएं पैर को अपने दाहिने पैर के सामने ले जाएं अपने दाहिने पैर को थोड़ा सीधा करें अपने ऊपरी शरीर को बाईं ओर थोड़ा मोड़ें अपने सिर को खिड़की से थोड़ी दूर दाईं ओर ले जाएं अपनी बांहों को नीचे लाएं और अपने हाथों को छाती के स्तर के बारे में ले जाएं।
Ground Truth 1: अपने दाहिने पैर को थोड़ा दाएं तरफ फेरें। अपने बाएं पैर को अपने दाहिने पैर के सामने रखें। अपने दोनों हाथों को लगभग 1.5 फीट नीचे कर लें। अपनी हथेलियों को जमीन की ओर रखना चाहिए।
Ground Truth 2: अपने बाएं पैर को हवा में अपने बाएं पैर के सामने दाईं ओर लाएं अपने कंधे और सिर को थोड़ा नीचे करें अपने हाथों को अपनी छाती के सामने लाएं आपका ऊपरी शरीर और सिर टेलीविजन की तरफ झुकना चाहिए।
Ground Truth 3: अपने बाएं पैर को जमीन पर रखें और इसे अपने दाहिने पैर के ऊपर से पार करें। अपने ऊपरी शरीर को बाईं ओर शीर्षक दें और अपनी बांहों को तब तक नीचे रखें जब तक वे छाती की ऊँचाई के आसपास न हों।

Figure 7: Output examples of our multimodal model in English (top) and Hindi (bottom).

layout too) and poses (though they are told to try to match as accurately as possible) have differences between the two splits (i.e., test-sim and test-real), we manually re-write a few words or phrases in the descriptions to make it more consistent with images in the test-real split (see Fig. 6).

8 Results

8.1 Pose Correctional Captioning Task

As shown in Table 2, the V+L models show better performance than V-only models. The L-only model shows higher scores on some of the automatic metrics, likely because the descriptions in our FIXMYPOSE dataset are instructional about body parts (and their movements/directions), so sim-

Character No.	B4	C	M	R
1	20.23	9.44	21.87	35.98
2	17.54	7.43	20.20	34.70
3	18.54	7.24	20.74	35.58
4	19.00	9.28	20.43	34.01
5	19.77	10.59	21.08	35.01
6	20.28	7.94	20.94	35.47

Table 5: The V+L model’s performance (English) on the individual characters’ demographics. The balanced scores indicate that our dataset is not biased towards any specific demographic.

Split	Automated Metrics				Task-Specific Metrics	
	B4	C	M	R	OM	DM
test-sim	16.93	9.91	21.79	35.08	0.04	0.20
test-real	13.01	7.12	21.40	33.05	0.07	0.11

Table 6: Sim-to-Real transfer performance. Since there is no GT joints for real images, the body-part-match metric is not available (OM: object-match, DM: direction-match).

ilar phrases are repeated and shallow metrics will only focus on such phrase-matching, not correctly reflecting human evaluations (Belz and Reiter 2006; Reiter and Belz 2009; Scott and Moore 2007; Novikova et al. 2017; Reiter 2018). Thus, we also evaluate the output of each model on our task-specific metrics that account the important factors (objects, body parts, and movement directions), and we also conduct human evaluation to check the real quality of the outputs. The V+L models show better performance on the task-specific metrics and human evaluation, meaning they capture essential information and their outputs are more relevant to the images and more fluent in the respective language. See Appendix F.2 for “unseen” split results.⁶

Ablations. As Table 3 shows, adding body joints features improves the score much, implying body joints gives additional important information to capture human movements.

RL/Multilingual Model Results. As Table 3 shows, RL training helps improve scores by directly using the evaluation metric (CIDEr) as the reward. We leave exploring more effective reward functions (e.g., the joints distance from a reverse pose generation task) for future work. Table 3 also shows that the multilingual training setup achieves comparable scores (similar observation to Wang et al. (2019)) with only 71% of the parameters of the separate training setup (13.2M vs 18.7M), promising future work on more compact and efficient multilingual models.

Other Image-Difference Datasets. Table 4 shows that our V+L baseline model beats or matches state-of-the-art models on other datasets, implying our baseline models are strong starting points for our FIXMYPOSE dataset.

Output Examples. Outputs from our V+L models are pre-

⁶We also checked for variance by running models with 3 different seeds and the stddev is small (less than/near 0.5% on CIDEr).

Models	Accuracy (%)	
	English	Hindi
Random-Selection	9.81	
V-Only	34.82	
L-Only	8.86	8.96
V+L	38.49	37.84
Human	96.00	96.00

Table 7: The scores for the target-pose-retrieval task. While the V+L models scores the highest, there is still much room for improvement when compared with human performance.

sented in Fig. 7. The English model captures the movement of the character’s legs and arms (“bring your right foot to the right” and “bring your right arm up to be at shoulder height ... right hand up in front of your face”). The Hindi model captures movement of the body parts and their spatial relationship to each other (English translation: “move your left leg in front of your right leg...”), the model can also describe movement using object referring expressions (English translation: “...move your head slightly away from the window...”). See Fig. 7 for the original Hindi and Appendix F.1 for full analysis and unimodal outputs.

Demographic Ablations. We split the dataset into subsets for each individual character avatar, and evaluate our V+L model on each subset. As shown in Table 5, scores from each subset are reasonably balanced, indicating our dataset is not skewed to favor a specific demographic or character.

Sim-to-Real Transfer. As shown in Table 6, the sim-to-real performance drop is not large, meaning information learned from our simulated FIXMYPOSE dataset can be transferred to real images reasonably well. Also, considering that the results are from a set of images of people with different demographics and different environments, there is no particular bias in the models’ output which is trained on our dataset. Since there is no GT body joints for the real images, we modify our model so it can also be trained to predict the joints during training time as well as generate descriptions (i.e., in a multi-task setup) and use the estimated joints at test time.⁷

8.2 Target Pose Retrieval Task

As shown in Table 7, V+L models show the highest scores for the target-pose-retrieval task, indicating that achieving high performance is not possible by exploiting unimodal biases. V-Only models score higher than the random-selection model, which selects an image at random, because even with our careful distractor choices (see Sec. 3 and Appendix A), the poses in the “current” and “target” images are more similar to each other than the other images. However, the human-

⁷For the simulated data results in Table 3 (English), we obtain a CIDEr score of 14.17 using predicted joints (on the val-seen split), which as expected is between the non-joint (13.79) and GT-joint (14.47) models’ results (hence showing that reasonable performance can be achieved without GT joint information at test time). The average distance between predicted and GT joints is around 0.4 meters.

model performance gap is still quite large, implying there is much room for improvement.⁸

9 Conclusion and Future Work

We introduced FIXMYPOSE, a novel pose correctional description dataset in both English and Hindi. Next, we proposed two tasks on the dataset, pose-correctional-captioning and target-pose-retrieval, both of which require models to understand diverse linguistic properties such as egocentric relation, environmental direction, implicit movement description, and analogous reference as well as capture fine visual movement presented in two images. We also presented unimodal and multimodal baselines as strong starter models. Finally, we demonstrated the possibility of transfer to real images. In future work, we plan to further expand the FIXMYPOSE dataset with more languages and even more diversity in the character pool (e.g., height, age, etc. based on digital avatar availability) and animations.

Ethics Statement

Our paper and dataset hopes to enable people to improve their health and well-being, as well as strives to follow ethical standards, e.g., we especially try to maintain balance across diverse demographics and avoid privacy concerns by collecting data from a simulated environment (but still show good transfer to real images from authors), and we also expand beyond English so as to more inclusively cover multiple languages. Similar to other image captioning tasks/models, some imperfect descriptions from models trained on our FixMyPose dataset might also lead to difficult/unnatural poses. Presenting models' confidence scores can help people ignore such unnatural pose corrections; however, most importantly, careful use is required for real-world applications (similar to all other image captioning models/tasks, e.g., the ones used for accessibility and visual assistance), and further broader discussion on developing fail-safe AI systems is needed.

Acknowledgments

We thank the reviewers and Jason Baldrige, Peter Hase, Hao Tan, and other UNC-NLP members for their helpful comments. This work was supported by NSF Award 1840131, NSF-CAREER Award 1846185, DARPA MCS Grant N66001-19-2-4031, Microsoft Investigator Fellowship, and Google Focused Award. The views contained in this article are those of the authors and not of the funding agency.

References

Abbasi, B.; Monaikul, N.; Rysbek, Z.; Di Eugenio, B.; and Žefran, M. 2019. A Multimodal Human-Robot Interaction Manager for Assistive Robots. In *IROS*, 6756–6762. IEEE.

⁸Human performance is 96% when given the full task (English), but much lower when only given lang. (38%) or only vis. (22%), further indicating that both lang.+vis. is needed to solve the task.

Anderson, P.; He, X.; Buehler, C.; Teney, D.; Johnson, M.; Gould, S.; and Zhang, L. 2018a. Bottom-up and top-down attention for image captioning and visual question answering. In *CVPR*, 6077–6086.

Anderson, P.; Wu, Q.; Teney, D.; Bruce, J.; Johnson, M.; Sünderhauf, N.; Reid, I.; Gould, S.; and van den Hengel, A. 2018b. Vision-and-language navigation: Interpreting visually-grounded navigation instructions in real environments. In *CVPR*, 3674–3683.

Andriluka; Pishchulin; Gehler; and Schiele. 2014. 2D Human Pose Estimation: New Benchmark and State of the Art Analysis. In *CVPR*.

Andriluka, M.; Iqbal, U.; Insafutdinov, E.; Pishchulin, L.; Milan, A.; Gall, J.; and Schiele, B. 2018. Posetrack: A benchmark for human pose estimation and tracking. In *CVPR*, 5167–5176.

Banerjee, S.; and Lavie, A. 2005. METEOR: An automatic metric for MT evaluation with improved correlation with human judgments. In *ACL Workshop*, 65–72.

Belz, A.; and Reiter, E. 2006. Comparing automatic and human evaluation of NLG systems. In *EACL*.

Bisk; Shih; Choi; and Marcu. 2018. Learning interpretable spatial operations in a rich 3d blocks world. In *AAAI*.

Bisk, Y.; Marcu, D.; and Wong, W. 2016. Towards a dataset for human computer communication via grounded language acquisition. In *Workshops at AAAI*.

Cao, Z.; Hidalgo Martinez, G.; Simon, T.; Wei, S.; and Sheikh, Y. A. 2019. OpenPose: Realtime Multi-Person 2D Pose Estimation using Part Affinity Fields. *TPAMI*.

Forbes, M.; Kaeser-Chen, C.; Sharma, P.; and Belongie, S. 2019. Neural Naturalist: Generating Fine-Grained Image Comparisons. In *EMNLP*. Hong Kong.

Gehring, J.; Auli, M.; Grangier, D.; Yarats, D.; and Dauphin, Y. N. 2017. Convolutional sequence to sequence learning. In *ICML*, 1243–1252.

He, K.; Zhang, X.; Ren, S.; and Sun, J. 2016. Deep residual learning for image recognition. In *CVPR*, 770–778.

Hochreiter, S.; and Schmidhuber, J. 1997. Long short-term memory. *Neural computation* 9(8): 1735–1780.

Hodosh, M.; Young, P.; and Hockenmaier, J. 2013. Framing image description as a ranking task: Data, models and evaluation metrics. *JAIR* 47: 853–899.

Jhamtani, H.; and Berg-Kirkpatrick, T. 2018. Learning to Describe Differences Between Pairs of Similar Images. In *EMNLP*, 4024–4034.

Johnson, J.; Karpathy, A.; and Fei-Fei, L. 2016. Denscap: Fully convolutional localization networks for dense captioning. In *CVPR*, 4565–4574.

Johnson, S.; and Everingham, M. 2010. Clustered Pose and Nonlinear Appearance Models for Human Pose Estimation. In *BMVC*. Doi:10.5244/C.24.12.

Johnson, S.; and Everingham, M. 2011. Learning effective human pose estimation from inaccurate annotation. In *CVPR*, 1465–1472. IEEE.

- Kim, K.; Boelling, L.; Haesler, S.; Bailenson, J.; Bruder, G.; and Welch, G. F. 2018. Does a digital assistant need a body? The influence of visual embodiment and social behavior on the perception of intelligent virtual agents in AR. In *ISMAR*, 105–114. IEEE.
- Kim, K.; de Melo, C. M.; Norouzi, N.; Bruder, G.; and Welch, G. F. 2020. Reducing Task Load with an Embodied Intelligent Virtual Assistant for Improved Performance in Collaborative Decision Making. In *2020 IEEE VR*.
- Kingma, D. P.; and Ba, J. 2015. Adam: A method for stochastic optimization. In *ICLR*.
- Krause, J.; Johnson, J.; Krishna, R.; and Fei-Fei, L. 2017. A hierarchical approach for generating descriptive image paragraphs. In *CVPR*, 317–325.
- Krishna, R.; Zhu, Y.; Groth, O.; Johnson, J.; Hata, K.; Kravitz, J.; Chen, S.; Kalantidis, Y.; Li, L.-J.; Shamma, D. A.; et al. 2017. Visual genome: Connecting language and vision using crowdsourced dense image annotations. *IJCV*.
- Lee, H.-Y.; Yang, X.; Liu, M.-Y.; Wang, T.-C.; Lu, Y.-D.; Yang, M.-H.; and Kautz, J. 2019. Dancing to Music. In *NeurIPS*, 3586–3596. Curran Associates, Inc.
- Lei, Yu; Berg; and Bansal. 2020. Tvr: A large-scale dataset for video-subtitle moment retrieval. In *ECCV*.
- Li, S.; Scalise, R.; Admoni, H.; Rosenthal, S.; and Srinivasa, S. S. 2016. Spatial references and perspective in natural language instructions for collaborative manipulation. In *RO-MAN*, 44–51. IEEE.
- Lin, C.-Y. 2004. Rouge: A package for automatic evaluation of summaries. In *Text summarization branches out*, 74–81.
- Lin, T.-Y.; Maire, M.; Belongie, S.; Hays, J.; Perona, P.; Ramanan, D.; Dollár, P.; and Zitnick, C. L. 2014. Microsoft coco: Common objects in context. In *ECCV*. Springer.
- Lu, J.; Xiong, C.; Parikh, D.; and Socher, R. 2017. Knowing when to look: Adaptive attention via a visual sentinel for image captioning. In *CVPR*, 375–383.
- Melas-Kyriazi, L.; Rush, A. M.; and Han, G. 2018. Training for diversity in image paragraph captioning. In *EMNLP*.
- Niu, T.; and Bansal, M. 2019. Automatically Learning Data Augmentation Policies for Dialogue Tasks. In *EMNLP*.
- Novikova; Dušek; Curry; and Rieser. 2017. Why We Need New Evaluation Metrics for NLG. In *EMNLP*.
- Papineni, K.; Roukos, S.; Ward, T.; and Zhu, W.-J. 2002. BLEU: a method for automatic evaluation of machine translation. In *ACL*, 311–318.
- Park, D. H.; Darrell, T.; and Rohrbach, A. 2019. Robust change captioning. In *ICCV*, 4624–4633.
- Paszke, A.; Gross, S.; Chintala, S.; Chanan, G.; Yang, E.; DeVito, Z.; Lin, Z.; Desmaison, A.; Antiga, L.; and Lerer, A. 2017. Automatic Differentiation in PyTorch. In *NIPS Autodiff Workshop*.
- Paulus, R.; Xiong, C.; and Socher, R. 2018. A Deep Reinforced Model for Abstractive Summarization. In *ICLR*.
- Plummer, B. A.; Wang, L.; Cervantes, C. M.; Caicedo, J. C.; Hockenmaier, J.; and Lazebnik, S. 2015. Flickr30k entities: Collecting region-to-phrase correspondences for richer image-to-sentence models. In *ICCV*, 2641–2649.
- Reiter, E. 2018. A Structured Review of the Validity of BLEU. *Computational Linguistics* 44(3): 393–401.
- Reiter, E.; and Belz, A. 2009. An investigation into the validity of some metrics for automatically evaluating natural language generation systems. *Computational Linguistics* 35(4).
- Rennie, S. J.; Marcheret, E.; Mroueh, Y.; Ross, J.; and Goel, V. 2017. Self-critical sequence training for image captioning. In *CVPR*, 7008–7024.
- Rong, Y.; Shiratori, T.; and Joo, H. 2020. FrankMocap: Fast Monocular 3D Hand and Body Motion Capture by Regression and Integration. *arXiv preprint arXiv:2008.08324*.
- Saunders, B.; Camgoz, N. C.; and Bowden, R. 2020. Progressive Transformers for End-to-End Sign Language Production. *ECCV 2020*.
- Scott, D.; and Moore, J. 2007. An NLG evaluation competition? eight reasons to be cautious. In *Proceedings of the Workshop on Shared Tasks and Comparative Evaluation in Natural Language Generation*, 22–23.
- Sellam, T.; Das, D.; and Parikh, A. P. 2020. BLEURT: Learning Robust Metrics for Text Generation. In *ACL*.
- Seo, M. J.; Kembhavi, A.; Farhadi, A.; and Hajishirzi, H. 2017. Bidirectional Attention Flow for Machine Comprehension. In *ICLR*.
- Serban; Sordoni; Lowe; Charlin; Pineau; Courville; and Bengio. 2017. A Hierarchical Latent Variable Encoder-Decoder Model for Generating Dialogues. In *AAAI*.
- Shlizerman, E.; Dery, L.; Schoen, H.; and Kemelmacher-Shlizerman, I. 2018. Audio to body dynamics. In *CVPR*.
- Suhr, A.; Zhou, S.; Zhang, A.; Zhang, I.; Bai, H.; and Artzi, Y. 2019. A Corpus for Reasoning about Natural Language Grounded in Photographs. In *ACL*, 6418–6428.
- Sun, K.; Xiao, B.; Liu, D.; and Wang, J. 2019. Deep high-resolution representation learning for human pose estimation. In *CVPR*, 5693–5703.
- Tan; Derroncourt; Lin; Bui; and Bansal. 2019. Expressing Visual Relationships via Language. In *ACL*.
- Tang, T.; Jia, J.; and Mao, H. 2018. Dance with melody: An LSTM-autoencoder approach to music-oriented dance synthesis. In *ACM Multimedia*.
- Toshev, A.; and Szegedy, C. 2014. DeepPose: Human Pose Estimation via Deep Neural Networks. In *CVPR*.
- Vaswani, A.; Shazeer, N.; Parmar, N.; Uszkoreit, J.; Jones, L.; Gomez, A. N.; Kaiser, Ł.; and Polosukhin, I. 2017. Attention is all you need. In *NeurIPS*, 5998–6008.
- Vedantam, R.; Lawrence Zitnick, C.; and Parikh, D. 2015. Cider: Consensus-based image description evaluation. In *CVPR*, 4566–4575.

Verma, M.; Kumawat, S.; Nakashima, Y.; and Raman, S. 2020. Yoga-82: a new dataset for fine-grained classification of human poses. In *CVPR Workshops*, 1038–1039.

Wang, I.; Smith, J.; and Ruiz, J. 2019. Exploring virtual agents for augmented reality. In *CHI*, 1–12.

Wang, S. I.; Liang, P.; and Manning, C. D. 2016. Learning Language Games through Interaction. In *ACL*, 2368–2378.

Wang, X.; Wu, J.; Chen, J.; Li, L.; Wang, Y.-F.; and Wang, W. Y. 2019. VateX: A large-scale, high-quality multilingual dataset for video-and-language research. In *ICCV*.

Wei, S.-E.; Ramakrishna, V.; Kanade, T.; and Sheikh, Y. 2016. Convolutional Pose Machines. In *CVPR*.

Williams, R. J. 1992. Simple statistical gradient-following algorithms for connectionist reinforcement learning. *Machine learning* 8(3-4): 229–256.

Wiseman, S.; Shieber, S. M.; and Rush, A. M. 2017. Challenges in Data-to-Document Generation. In *EMNLP*.

Wu; Schuster; Chen; Le; Norouzi; Macherey; Krikun; Cao; Gao; Macherey; et al. 2016. Google’s neural machine translation system: Bridging the gap between human and machine translation. *arXiv preprint arXiv:1609.08144*.

Xu; Ba; Kiros; Cho; Courville; Salakhudinov; Zemel; and Bengio. 2015. Show, attend and tell: Neural image caption generation with visual attention. In *ICML*, 2048–2057.

Yan, S.; Xiong, Y.; and Lin, D. 2018. Spatial temporal graph convolutional networks for skeleton-based action recognition. *AAAI*.

Yang, Z.; Yuan, Y.; Wu, Y.; Cohen, W. W.; and Salakhutdinov, R. R. 2016. Review networks for caption generation. In *NeurIPS*, 2361–2369.

Yao, T.; Pan, Y.; Li, Y.; and Mei, T. 2018. Exploring visual relationship for image captioning. In *ECCV*, 684–699.

Zhang, T.; Kishore, V.; Wu, F.; Weinberger, K. Q.; and Artzi, Y. 2019. BERTScore: Evaluating Text Generation with BERT. In *ICLR*.

Zhao, L.; Peng, X.; Tian, Y.; Kapadia, M.; and Metaxas, D. N. 2019. Semantic graph convolutional networks for 3D human pose regression. In *CVPR*, 3425–3435.

Zhuang, W.; Wang, Y.; Robinson, J.; Wang, C.; Shao, M.; Fu, Y.; and Xia, S. 2020. Towards 3D Dance Motion Synthesis and Control. *arXiv preprint arXiv:2006.05743*.

Appendices

A Distractor Choice Criteria

For the “target” and distractor images of the target-pose-retrieval task, we only consider images that meet these criteria: (1) the “target” pose image must have more than 10cm average joints distance from the “current” pose image, (2) each distractor has an average joints distance between 10cm and 1m from the “target” pose image, (3) each distractor must have less than 2m average joints distance from the “current” pose image, (4) the “current” pose image is included in the distractor images, and (5) all the distractor

images are from the same environment and have the same character as the one in the “target” pose image.

B Dataset

B.1 Image and Environment Generation

Environment Creation. Every object inside of each room is collected from free assets in the Unity Asset Store⁹ and various other free online resources. The first room is also collected as a free asset from the Unity Asset Store, however the rest of the rooms are manually created. In all rooms, including the first room, we manually choose and configure the arrangement of the objects.

Movement Animations. Movement animations are taken from realistic and natural body movements that people could potentially perform at home. Fig. 8 shows a few key frames of some movement animations. All characters and animations are collected from the free collection on Adobe’s Mixamo.

Image Capture. To obtain each pair of images, we run the same animation twice but the second instance of the animation is offset by 10 animation frames. The 10 frame offset helps ensure that a clear visual difference is created, but not so much that it creates two unrelated images. The image of the first instance is the “current” image and the image of the second instance is the “target” image. Fig. 9 shows an example of a “current” and “target” image as well as a “difference” image which shows the overlap of the “current” and “target” images with the pose in the “target” image shown in red. Every 20 frames, an image pair is captured.

3D Body Joint Data. We obtain the 3D positional joint data of the character’s poses from both the “current” and “target” images (see Fig. 13). The positional data is relative to the camera’s position and angle. This keeps all the data normalized regardless of which room or location in a room is chosen.

B.2 Data Collection Interface

For each of the 3 data collection tasks (writing, verification, translation), we create a separate interface. The writing task and verification task are also provided with certain flags (detailed in corresponding interface paragraphs). Upon clicking the images in any of the interfaces, the clicked image will be enlarged and an option to view the image in a separate tab is given in case the worker would like an even larger image.

Writing Task Interface. During this task, the goal is to have the workers see the 3 images (“current”, “target”, “difference”) and then write a correctional description based on those images. The interface (as shown in Fig. 10) provides the 3 images labeled and a writing area. Workers are also provided with “no clear difference” and “character is going through an object” flag. The “no clear difference” flag

⁹<https://assetstore.unity.com>



Figure 8: Examples of specific movement animations (each image is 10 frames apart). Each image sequence show a segment of the movement animation.



Figure 9: Current, target, and difference images. The target images are taken 10 frames after the current images are taken. The difference image shows the overlap of the “current” and “target” images with the pose in the “target” image shown in red.

is designed to be used in the case the difference between the poses in the “current” image and “target” image is too small to write a good description. The “character is going through an object” flag is meant to be used in the event that a character in either image has a body part going through a wall, table, or any other object.

Verification Task Interface. This task serves to filter out any descriptions that are of poor quality. To do this, workers are provided with the “current” image and the “target” image and then the correctional description that is written for that image pair. They are then asked to rank the quality of the description from 1-4, with 1 being the description is completely unrelated and 4 being the description is perfect. Then, just as for the writing task, a checkbox for the “character is going through an object” flag is provided in case the writing task workers miss it. The interface is shown in Fig. 11.

Translation Task Interface. During this task, workers are asked to translate descriptions from English into Hindi. As shown in Fig. 12, the interface provides the “current” and “target” images for context and then the English description. Then, a text field is provided where workers can write the translation.

B.3 Data Collection Filters

During the writing task, some active quality checks are put in place to ensure that descriptions are of a certain base quality before they reach the verification task. Below is the list of each active quality that is put in place.

- Each description must contain at least 30 words.
- The symbols (, [,],), &, *, ^, %, \$, #, and @ cannot be included.
- At least 50% of the words in the instruction must be unique.
- The term “image” cannot be included.
- The term “i” cannot be included.
- The term “target” cannot be included.
- The term “difference” cannot be included.

In the case that workers in writing task select the “no clear difference” checkbox on the interface, the 30-word minimum check is removed so that workers could write shorter descriptions, since there is not much difference to write about if the images are almost the same.

B.4 Worker Qualifications and Incentives

There were a total of 356, 373, and 47 unique crowd-workers who successfully passed the qualifications and completed the writing, verification, and translation tasks, respectively, at least once.¹⁰

Worker Qualifications. For all 3 tasks, crowd-workers are required to pass certain qualifications before they could begin. As both writing and verification tasks require reading (and writing in the case of the writing task) English, we require workers to be from native-speaking English countries and as the translation task requires translating to Hindi, we require that workers be from India. Crowd-workers are also required to have at least 1000 approvals from other tasks and a 95% or higher approval rating.

¹⁰We do not collect or use any private information from the workers.



- Please do not repeat phrases (i.e. 'move your right ... Then move your left ... Then move your ...'), instead try and diversify how you write (i.e. Shift your right ...Your left arm should be ...).
- Please try to use an analogy such as "move your right arm down to your side so it is like you are holding a cane" to make your descriptions more clear.

Enter Description Below (Remember: Well detailed is defined as a description that someone else can easily follow in order to convert the current image into the target image and the description covers all the position and pose changes that happen.)

You can select multiple checkboxes if necessary.

Please use the below boxes IN THE RIGHT SITUATIONS.

- The images are the same. (Please still try to write some description.)
- Character's body or body part is going through some other object (i.e. the character's leg is going through a wall or table. (in the Current or Target image))

Reminders:

- Write detailed descriptions
- Do not write unnecessary things
- Write as if you are speaking to the character in the current image
- The left/right rules. See image at the top of the page

If you are ever unsure of the checkboxes or your description, please feel free to contact us.

Figure 10: The interface of the writing task.

Worker Payment. The writing task takes around 1 minute and workers are paid \$0.18 per description. For the first 25 high-quality descriptions that a worker writes, an additional bonus of \$0.02 is given for each description and then for every subsequent 50 high-quality descriptions written, the bonus per description is increased by \$0.01 (\$0.02 bonus per description for first 25, \$0.03 bonus for the next 50, \$0.04 bonus for the next 50, and so on). With this bonus rate, workers could get more than \$0.20 quite easily since the task is not long (and hence overall reasonably higher than minimum hourly wages). Since there is no limit on how much a worker can write, they could potentially keep stacking the bonus as much as they want.

C Analysis

C.1 Most Commonly Occurring Words

The most commonly occurring words in our dataset are about direction, body parts, and movement, showing that

models need to have a sense of direction with respect to body parts and objects, and also capture the differences between the poses to infer the proper movements. Fig. 14 shows the most commonly occurring English/Hindi words in our dataset, which also primarily relate to directions, body parts, and movements.

C.2 Description Length

The average length of the multi-sentenced descriptions (49.25 English / 52.74 Hindi words) is quite high, indicating that they are well detailed. The stdev (17.28/18.88) and the gap between the min and max (20/14 vs. 188/239) is quite large, reflecting the varying degrees of difference between the poses in an image pair. This length characteristic of the FIXMYPOSE dataset requires models to generate descriptions without being redundant or insufficient in detail.

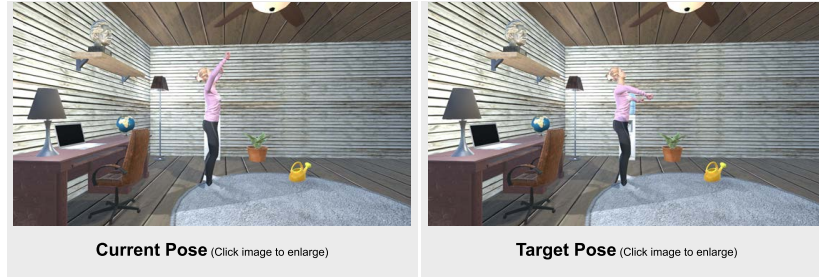

Description: move your entire body back one inch. drop both arms down to your shoulder level. bend your right elbow slightly away from your body, with your right forearm pointing at a four oclock angle.

On a scale of 1-4, how accurate is the description?

○ ————— 1

Check this box if a character in the images is going through a wall or table or something else.

Any additional comments you have regarding the images or the description accuracy.

The description was very good...The description was good but needed more details...etc...

Submit

Figure 11: The interface of the verification task.

Reference Frame	Freq.	Examples (English)
Egocentric Relation	100%	“... rotate your left shoulder so that your hand is above your elbow ...” “... put your right foot and leg forward so it is parallel with your torso ...” “... move your left leg down and put in front of your right leg ...”
Environmental Direction	52%	“... turn your left leg and right leg to the left to face the wall with the door ...” “...turn your head to look to the bed ...” “...somewhat aligning your eyes with the closest lamp ...”
Implicit Movement Description	58%	“... lean your body towards and slightly over your right leg ...” “... rotate your torso slightly to the left ...” “... then slightly lean forward ...”
Analogous Reference	18%	“... extend your right arm straight in front of you as if you are gesturing for someone to stop ...” “... twist your upper body back to your right in a golf swing motion ...” “... hold your right hand next to your body as if you are leaning on a cane ...”

Table 8: Frequencies and detailed examples of the different properties present in correctional descriptions.

C.3 Linguistic Properties

The descriptions in the FIXMYPOSE dataset contain diverse linguistic properties. These properties as well as a few additional examples are provided in Table 8. Additional examples of implicit movement description along with basic explanations are shown in Fig. 15.

D Models

Cross Attention Stack. CA-Stack is a stack of cross attentions.

$$\text{CA-Stack}(f^c, \hat{J}^c, f^t, \hat{J}^t) : \begin{cases} \bar{f}^c, \bar{J}^c = \text{CA}(f^c, \hat{J}^c) \\ \bar{f}^t, \bar{J}^t = \text{CA}(f^t, \hat{J}^t) \\ \tilde{f}^c, \tilde{J}^c = \text{CA}(\bar{f}^c, \bar{J}^t) \\ \tilde{f}^t, \tilde{J}^c = \text{CA}(\bar{f}^t, \bar{J}^c) \end{cases} \quad (12)$$

where CA is cross attention.

Cross Attention. We calculate the similarity matrix, S , between two features.

$$S_{ij} = f_i^\top g_j \quad (13)$$

From the similarity matrix, the new fused instruction feature is:

$$\hat{f} = \text{softmax}(S^\top) \cdot f \quad (14)$$

$$\bar{g} = W_g^\top [g; \hat{f}; g \odot \hat{f}] \quad (15)$$

Similarly, the new fused visual feature is:

$$\hat{g} = \text{softmax}(S) \cdot g \quad (16)$$

$$\bar{f} = W_f^\top [f; \hat{g}; f \odot \hat{g}] \quad (17)$$

where W_g and W_f are trainable parameters, \odot is the element-wise product, and \cdot is matrix multiplication.

You must be able to read English and speak/write Hindi fluently.

In this task you will read a caption that is explaining how a person in the first image can change their body to look like the second image. Then you will translate the caption (without changing the meaning) into Hindi (please use Hindi characters not English).

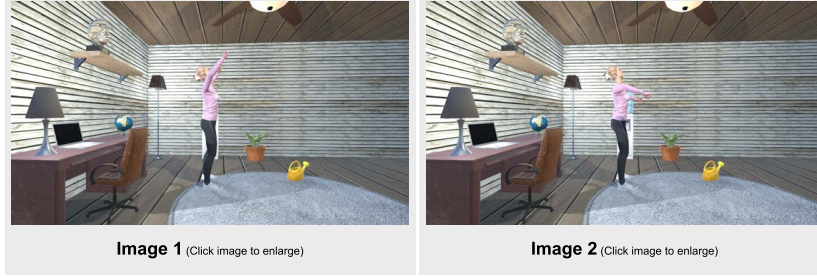

move your entire body back one inch. drop both arms down to your shoulder level. bend your right elbow slightly away from your body, with your right forearm pointing at a four o'clock angle.

Please write your translation here (make sure to write in Hindi characters and do NOT change the meaning of the English caption above):

Please write your translation here

Submit

Figure 12: The interface of the translation task.

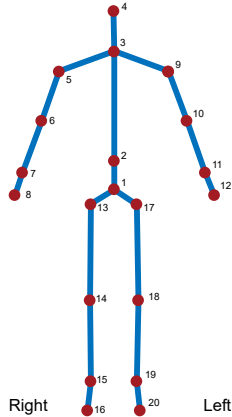

Figure 13: The 3D joint configuration of characters (from index 1 to 20: center hip, spine, neck, head, right shoulder/elbow/wrist/hand, left shoulder/elbow/wrist/hand, right hip/knee/ankle/foot, left hip/knee/ankle/foot).

General Attention. We employ a basic attention mechanism for aligning description features, h , and each of the visual and joints features.

$$A_i = f_i^\top h \quad (18)$$

$$\alpha = \text{softmax}(A) \quad (19)$$

$$\hat{f} = \alpha^\top f \quad (20)$$

Self Gate. We employ a basic attention mechanism for weighted summation of features.

$$A_i = \text{Linear}(k_i) \quad (21)$$

$$\alpha = \text{softmax}(A) \quad (22)$$

$$\hat{k} = \alpha^\top k \quad (23)$$

E Experiments

E.1 Data Splits

For the pose-correctional-captioning task, we split the dataset into train/val-seen/val-unseen/test-unseen. Since each room in our FIXMYPOSE has different visual setting (i.e., wall, floor, furniture, etc.), we assign separate rooms to val-unseen and test-unseen split. To be specific, we assign room 1 to 19, 24, and 25 to the train and val-seen splits, room 20 and 21 to the val-unseen, and room 22 and 23 to the test-unseen split. The final number of task instances for each split is 5,973/562/563/593 (train/val-seen/val-unseen/test-unseen) and the number of descriptions is 5,973/1,686/1,689/1,779. For the target-pose-retrieval task, we split the dataset into train/val-unseen/test-unseen. However, “unseen” in this task means “unseen animations”. The reason we split the dataset by animations is that, otherwise, the task would be easier by memorizing/capturing some patterns in the image pairs from certain animations. We assign animation 6 and 16 to val-unseen, 7 to test-unseen, and the rest of the animations to the train split. After filtering for the target candidates, we obtain 4,227/1,184/1,369 (train/val-unseen/test-unseen) instances.

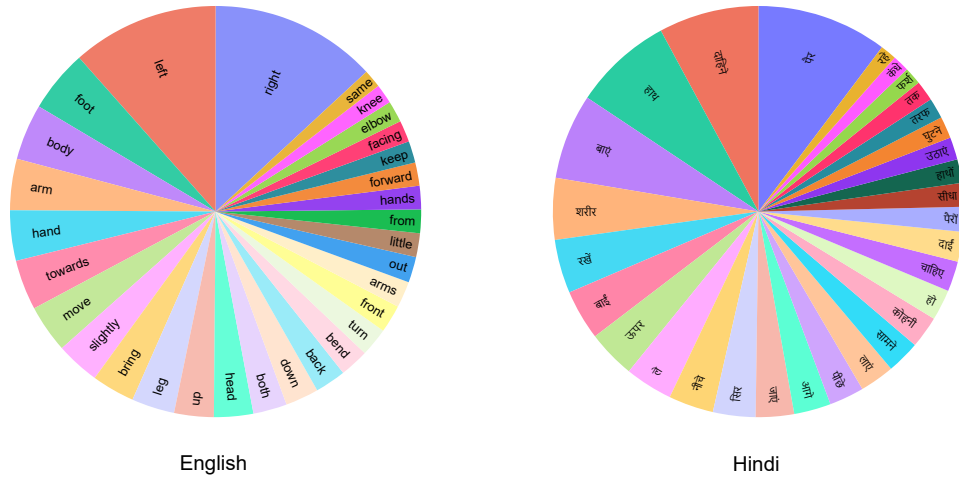

Figure 14: The 30 most common English/Hindi words in the dataset (excluding stop words). They primarily relate to directions, body parts, and movements.

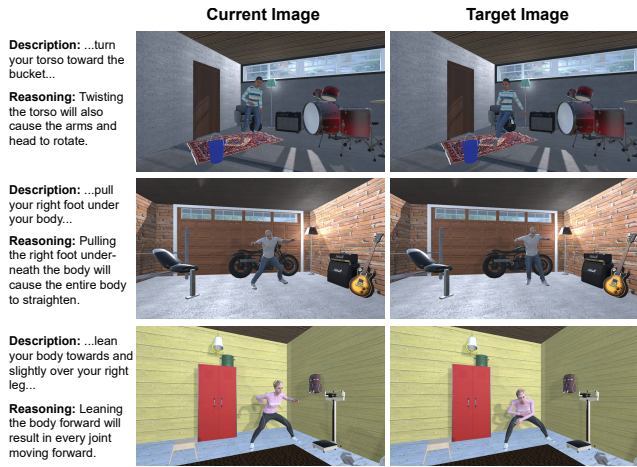

Figure 15: Examples of the ‘implicit movement description’ linguistic property.

E.2 Human Evaluation Setup

We conduct human evaluation for the pose-correctional-captioning task’s models to compare the output of the V-only (V: vision+joints) model, the L-only (L: language) model, and the full V+L model qualitatively. We randomly sample 100 generated descriptions from each model (val-seen split), then asked 3 random crowd-workers (we also applied the standard quality filters of above 95% hit success, over 1000 Hits, workers from native language-speaking countries) for each description to vote for the most relevant description in terms of the image pair, and for the one best in fluency/grammar (or ‘tied’).

Separately, to set the performance upper limit and to verify the effectiveness of our distractor choices for the target-pose-retrieval task, we conduct human evaluation. We randomly sample 50 instances from the target-pose-retrieval test-unseen split and ask an expert for the English and Hindi

samples to perform the task. Human evaluation is conducted the same way for both English and Hindi. We also ask the expert to complete the task from a unimodal perspective (i.e., only given the “current” image or only given the description) to also show that the distractor choices cannot be exploited by any unimodal biases.

E.3 Training Details (Reproducibility)

All of the experiments are run on a Ubuntu 16.04 system using the NVIDIA GeForce GTX 1080 Ti GPU and Intel Xeon CPU E5-2630. We employ PyTorch1.3 (Paszke et al. 2017) to build our models (torchvision0.4/Python3.5/numpy1.18/scipy1.4). The number of trainable parameters of the pose-correctional-captioning V+L models are 9.1M and 9.6M for English and Hindi version, respectively (V-only: 10.4M/10.9M, L-only: 2.8M/3.1M), and the number of trainable parameters of the target-pose-retrieval V+L models are 10.9M/10.9M (V-only: 4.5M, L-only: 6.7M/6.7M). For the pose-correctional-captioning task experiments, we use 9595/5555/2020 as the seed values, and run models 500 epochs and choose the best ones on val-seen/val-unseen splits. For the target-pose-retrieval task experiments, we use 5555/5556/5557 as the seed values, and run models 50 epochs and choose the best ones on the val-unseen split. In the pose-correctional-captioning task model training, at training time, the models are trained with teacher-forcing approach, and at test time, the greedy-search is employed to generate the descriptions. For the multilingual model, we freeze the shared parameters at the point at which the English score is the highest, and then fine-tune specific non-shared modules for each language with ML and RL training. We employ ResNet-101 for the visual features. We use 512 as the hidden size and 256 as the word embedding dimension for both task models. We use the visual feature map of 7×7 with 2048 channel size for the pose-correctional-captioning task models and 14×14 with 1024 channel size for the target-pose-retrieval task models. We use Adam (Kingma and Ba 2015) as the

ment of the character’s legs and arms (“bring your right foot to the right” and “bring your right arm up to be at shoulder height ... right hand up in front of your face”). The Hindi model captures movement of the body parts and their spatial relationship to each other (English translation: “move your left leg in front of your right leg...”), the model can also describe movement using object referring expressions (English translation: “...move your head slightly away from the window...”). See Fig. 16 for the original Hindi. For all of the unimodal models, the outputs perform poorly and do not accurately match the image pair. For the V-only models’ outputs, the grammar and sentence structure are also very poor.

E.2 “Unseen” Split Results

Table 9 shows our V+L models’ scores on the val-unseen and the test-unseen splits (the scores are chosen by the best performance on the val-unseen split). We suggest that model tuning/selection be done on the val-seen/unseen splits and the results from the test-unseen are reported, following the practice of Anderson et al. (2018b).