

Unitarization Through Approximate Basis

Joshua Cook

April 5, 2021

Abstract

In this paper, we introduce the problem of unitarization. Unitarization is the problem of taking several input quantum circuits that produce orthogonal states from the all 0 state, and create an output circuit implementing a unitary with its first columns as those states. We allow the resulting circuits, and even the input circuits, to use ancilla qubits initialized to 0. But ancilla qubits must always be returned to 0 for ANY input, and we are only guaranteed the input circuits returns ancilla qubits to 0 on the all 0 input.

The unitarization problem seems hard if the output states are neither orthogonal to or in the span of the computational basis vectors that need to map to them. In this work, we approximately solve this problem in the case where input circuits are given as black box oracles by probably finding an approximate basis for our states. This method may be more interesting than the application.

Specifically, we find an approximate basis in polynomial time for the following parameters. Take any natural n , $k = O\left(\frac{\ln(n)}{\ln(\ln(n))}\right)$, and $\epsilon = 2^{-O(\sqrt{\ln(n)})}$. Take any k input unit vectors, $(|\psi_i\rangle)_{i \in [k]}$ on polynomial in n qubits prepared by quantum oracles, $(V_i)_{i \in [k]}$, (that we can control call and control invert). Then there is a quantum circuit with polynomial size and access to the oracles $(V_i)_{i \in [k]}$ that with at least $1 - \epsilon$ probability, computes at most k circuits with size polynomial in n and oracle access to $(V_i)_{i \in [k]}$ that ϵ approximately computes an ϵ approximate orthonormal basis for $(|\psi_i\rangle)_{i \in [k]}$.

1 Introduction

Quantum computing is a way of performing computation that can simulate classical computation, but works in a fundamentally different way. Intuitively, quantum computers can achieve better performance from classical computers by using quantum interference. The requirements for this interference to happen place restrictions on what state can be maintained that classical computers don't have.

This often manifests in what is lovingly referred to as “entangled garbage”. Often a quantum algorithm wants a circuit that for some function $f : [n] \rightarrow [n]$ takes $|i\rangle$ to $|f(i)\rangle$. Sometimes though, we only have an algorithm that will take $|i\rangle |0^m\rangle$ to $|f(i)\rangle |g(i)\rangle$ for some function g . If the function g is not constant, then it in some way “records” the input i as entangled garbage.

In classical computation, this distinction does not matter, since the extra bits can be ignored or reset. But for quantum algorithms, this entangled garbage can prevent interference.

On the other hand, using extra qubits as working space during computation can be extremely useful. In this work I am concerned with reducing the requirements on algorithms to “clean up” after themselves and still produce results without entangled garbage.

In particular, we are concerned about never producing garbage on ANY input, and only making changes on very specific subspaces. This could be useful if you knew how to compute

a function f on a few specific states, but might cause garbage or other things you don't want on other states.

1.1 Result Overview

To solve this problem, I actually have to solve a seemingly more ambitious problem: finding an approximate basis for any set of states given a circuit to prepare them.

First, let us define approximation.

Definition 1 (Unitary Approximation). *For $\epsilon > 0$, integers n and p , unitary U on n qubits and unitary C on $n + p$ qubits, we say C ϵ approximates U if for all n qubit states $|a\rangle$ we have*

$$\|(U|a\rangle|0^p\rangle - C|a\rangle|0^p\rangle)\| \leq \epsilon.$$

The key here is that we let our circuit use ancilla qubits, as long as it ALWAYS returns them close to 0. 0 approximating means implementing U exactly, given access to auxiliary bits. A straightforward consequence of this definition is that unitary approximations can be composed

Lemma 2 (Approximate Composition). *Suppose for integer l , we have for each $i \in [l]$ a unitary V_i on n qubits, and a unitary C_i on $n + p_i$ qubits such that C_i ϵ_i approximates V_i . Let $V = \prod_{i \in [l]} V_i$, $p = \max_{i \in [l]}(p_i)$, $C = \prod_{i \in [l]} C_i \otimes I_{p-p_i}$, and $\epsilon = \sum_{i \in [l]} \epsilon_i$. Then C ϵ approximates V .*

The focus of this paper is on constructing approximate unitaries that prepare a few specific states given by oracles. Notably, we don't require the oracles be well behaved except on one specific input preparing our state. In particular, the oracles may use ancilla qubits that may leave entangled garbage for any other input, but our final circuit must still approximate a unitary without any garbage.

In all our results, we will suppress a factor of n for the number of qubits our state is on. This will simplify the analysis since most gates are controlled nots of the state being in a specific computational basis state, swaps of computational basis states, or applications of an oracle.

Our main theorem is:

Theorem 3 (Clean Unitary). *For natural k , let $(|\psi_i\rangle)_{i \in [k]}$ be orthonormal states on n qubits. Suppose for some integer m , for every $i \in [k]$ there was a unitary V_i such that $V_i|0\rangle|0^m\rangle = |\psi_i\rangle|0^m\rangle$.*

Then there is some unitary U on n qubits so that for all $i \in [k]$, $U|i\rangle = |\psi_i\rangle$ and for all states $|\phi\rangle$ orthogonal to each $(|\psi_i\rangle)_{i \in [k]}$ and $(|i\rangle)_{i \in [k]}$, $U|\phi\rangle = |\phi\rangle$.

Then for every $\epsilon > 0$, for some integer p , there is a quantum circuit, C , on $n + p$ qubits with oracle access to $(V_i)_{i \in [k]}$ that ϵ approximates U with size

$$\text{poly} \left((k + \ln(1/\epsilon))^k \left(\frac{k}{\epsilon} \right)^{\min\{k, \ln(k/\epsilon)\}} \right).$$

Perhaps the most interesting set of parameters for this is when $k = O\left(\frac{\ln(n)}{\ln(\ln(n))}\right)$ and $\epsilon = 2^{-O(\sqrt{\ln(n)})}$. This still leads to a polytime algorithm, and any larger k or smaller ϵ would not be without an improved algorithm or an improved bound, until k becomes constant, at which point ϵ can be polynomially small.

The main tool used to prove this theorem is an orthogonalization algorithm. This algorithm lets us take a circuit that only prepares one state ϵ far from computable subspace, and gives an

approximation of a unitary that computes the orthogonal direction of that state. This combined with a Gram-Schmidt like process allows us to compute an approximate orthonormal basis.

First, for notation

Definition 4 (Orthogonal Component). *For some natural k , let $(|\phi_i\rangle)_{i \in [k]}$ be some orthonormal basis. Let $|\psi\rangle$ be some state. Then for some state $|\phi\rangle$ and constants $(\alpha_i)_{i \in [k]}$,*

$$|\psi\rangle = \sum_{i \in [k]} \alpha_i |\phi_i\rangle + \left(\sqrt{1 - \sum_{i \in [k]} \|\alpha_i\|^2} \right) |\phi\rangle.$$

Then define a function Φ as

$$\Phi((|\phi_i\rangle)_{i \in [k]}, |\psi\rangle) = |\phi\rangle.$$

Similarly, define function Δ as

$$\Delta((|\phi_i\rangle)_{i \in [k]}, |\psi\rangle) = \sqrt{1 - \sum_{i \in [k]} \|\alpha_i\|^2}.$$

Then our orthogonalization lemma is:

Lemma 5 (State Orthogonalization). *Let k be natural, and $(|\phi_i\rangle)_{i \in [k]}$ be orthonormal states on n qubits. Assume for each $i \in [k]$, there is some unitary U_i that swaps $|\phi_i\rangle$ with $|0^n\rangle$ and changes no other states. Let $|\psi\rangle$ be a state with $|\phi\rangle = \Phi((|\phi_i\rangle)_{i \in [k]}, |\psi\rangle)$ and $\beta = \Delta((|\phi_i\rangle)_{i \in [k]}, |\psi\rangle)$. For some $\delta > 0$, suppose $\beta > \delta$. Suppose for some natural m and unitary V we have $V|0^n\rangle|0^m\rangle = |\psi\rangle|0^m\rangle$.*

Then there exists some unitary W such that $W|0^n\rangle = |\phi\rangle$ and for all vectors $|a\rangle$ orthogonal to both $|0^n\rangle$ and $|\phi\rangle$, we have $W|a\rangle = |a\rangle$. Further, for all $\epsilon > 0$, for some natural p there exists a circuit, C , on $n + p$ qubits using oracle calls to V and U_i that C ϵ approximates W and has size $O\left(\frac{k \ln(1/\epsilon)}{\delta^2}\right)$.

Further, C only uses $O\left(\frac{\ln(1/\epsilon)}{\delta^2}\right)$ oracle calls to V , and each U_i . Let $v \in \mathbb{C}^k$ be such that for $i \in [k]$, $v_i = \langle \phi_i | \psi \rangle$, and $\alpha = \|v\| = \sqrt{1 - \beta^2}$. Then call $|\theta\rangle = \sum_{i \in [k]} \frac{v_i}{\alpha} |i\rangle$. Then we have that C uses only $O\left(\frac{\ln(1/\epsilon)}{\delta^2}\right)$ oracle calls to a unitary, R , on k qubits so that $R|0^k\rangle = \beta|0\rangle + \alpha|\theta\rangle$.

And clever application of this gives our approximate basis theorem:

Theorem 6 (Approximate Basis). *For natural k , let $(|\psi_i\rangle)_{i \in [k]}$ be states on n qubits. Suppose for some integer m , for every $i \in [k]$ there was a unitary V_i such that $V_i|0\rangle|0^m\rangle = |\psi_i\rangle|0^m\rangle$.*

Then for every $\epsilon > 0$, $\gamma > 0$ there is an algorithm that runs in time

$$\text{poly} \left((k + \ln(1/\epsilon))^k \left(\frac{k}{\epsilon} \right)^{\min\{k, \ln(k/\epsilon)\}} \right) \ln(1/\gamma)$$

that with probability at most γ fails to find the following:

For some orthonormal basis Y containing at most k vectors so that for all $i \in [k]$, $\Delta(Y, |\psi_i\rangle) < \frac{\epsilon}{4k}$, the algorithm computes the following:

A set of circuits $X = (x_a)_{|a\rangle \in Y}$ so that for each $|a\rangle \in Y$, there is an $x_a \in X$ and $\eta_{x_a} \in \mathbb{R}$ so that $x_a \eta_{x_a}$ approximates the unitary that swaps $|a\rangle$ and $|0\rangle$ with error η_{x_a} , and

$$\sum_{x \in X} |x| \leq \text{poly} \left((k + \ln(1/\epsilon))^k \left(\frac{k}{\epsilon} \right)^{\min\{k, \ln(k/\epsilon)\}} \right),$$

and

$$\sum_{x \in |X|} \eta_x \leq \epsilon.$$

1.2 Why Isn't Unitarization Trivial

At first glance, unitarization seems easy. It looks similar to a problem any new student in quantum computation might see. The concern is that we want our circuit C to approximate U on every input, which means that the auxiliary qubits must always be returned to 0.

To show the difficulty, let us first show some failed attempts and explain how they fail. Let us work in the simple case where we just have two states $|\psi_1\rangle$ and $|\psi_2\rangle$ prepared by an n bit unitary V_1 and V_2 on $|1\rangle$ and $|2\rangle$.

First, some notation. First, we need some unitaries that swap computational basis states.

Definition 7 (Basis To Zero). *For computational basis state $|a\rangle$ let P_a be the unitary that swaps $|0\rangle$ with $|a\rangle$.*

Similarly, we will define controlled nots based on registers being in well known states.

Definition 8 (Controlled on Measurement Nots). *For basis state $|a\rangle$, define M_a so that:*

$$\begin{array}{c} |\phi\rangle \\ |b\rangle \end{array} \begin{array}{c} \text{---} \boxed{M_a} \text{---} \\ \oplus \end{array} = \begin{array}{c} |\phi\rangle \\ |b\rangle \end{array} \begin{array}{c} \text{---} \boxed{P_a^{-1}} \boxed{P_{1^n}} \bullet \text{---} \boxed{P_{1^n}^{-1}} \boxed{P_a} \text{---} \\ \oplus \end{array}$$

Similarly for $|\psi\rangle$ prepared by unitary V , define M_ψ as

$$\begin{array}{c} |\phi\rangle \\ |b\rangle \end{array} \begin{array}{c} \text{---} \boxed{M_\psi} \text{---} \\ \oplus \end{array} = \begin{array}{c} |\phi\rangle \\ |b\rangle \end{array} \begin{array}{c} \text{---} \boxed{V^{-1}} \boxed{M_0} \boxed{V} \text{---} \\ \oplus \end{array}$$

The unitary associated with a measurement should be clear from context.

Now for a noble first attempt at unitarization for the case where we have 2 states. Let C_1 be the following circuit.

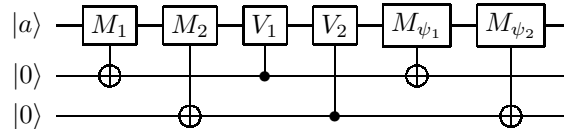

We can see that for $i \in [2]$, we indeed have $C_1 |i\rangle |0^2\rangle = |\psi_i\rangle |0^2\rangle$. And for any state orthogonal to $|1\rangle, |2\rangle, |\psi_1\rangle$, and $|\psi_2\rangle$ is unchanged by C_1 . But what about $C_1 |\psi_1\rangle |0^2\rangle$? Well, if $|\psi_1\rangle$ is in the span of $|1\rangle$ and $|2\rangle$, then we also have $C_1 |\psi_1\rangle |0^2\rangle = |a\rangle |0^2\rangle$ for some state $|a\rangle$. But if $|\psi_1\rangle$ is orthogonal to $|0\rangle$ and $|1\rangle$, then $C_1 |\psi_1\rangle = |\psi_i\rangle |10\rangle$. This leaves some entangled garbage, which we don't want!

This can be fixed in this case. Let C_2 be the following circuit:

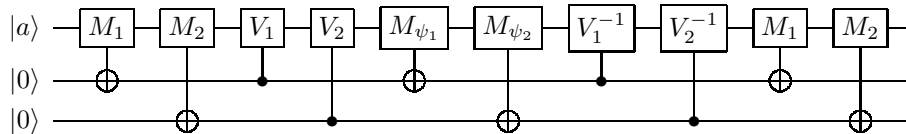

Now this works if $|\psi_1\rangle$ and $|\psi_2\rangle$ are orthogonal to $|1\rangle$ and $|2\rangle$. But if they are not, then again this will leave us with entangled garbage!

Now, we could do something like detect if $|\psi_i\rangle$ is in the subspace of $|1\rangle$ and $|2\rangle$ or orthogonal. But what if it is only partially in the subspace, such as if $|\psi_1\rangle = \frac{1}{\sqrt{2}}(|1\rangle + |3\rangle)$ and $|\psi_2\rangle = \frac{1}{\sqrt{2}}(|1\rangle - |3\rangle)$? It seems less obvious how to handle these kinds of cases in a general way.

But actually, if we know the decomposition of $|\psi_1\rangle$ and $|\psi_2\rangle$ into some orthogonal vectors $|1\rangle, |2\rangle, |\phi_1\rangle, |\phi_2\rangle$ and a clean way to compute each, then we can somewhat simply compute the transformation in a brute force way without leaving entangled garbage. It turns out, if a state is far from the subspace of $|0\rangle, |1\rangle$, then it is possible to approximate its component orthogonal to that subspace.

1.3 Proof Idea

The main lemma is the preparation of orthogonal components. The idea is simple. For a natural k , orthonormal states $(|\phi_i\rangle)_{i \in [k]}$ prepared by unitaries $(U_i)_{i \in [k]}$ and state $|\psi\rangle$ prepared by unitary V on input $|0^n\rangle|0^m\rangle$:

1. First, estimate the angles of $|\psi\rangle$ to each of $(|\phi_i\rangle)_{i \in [k]}$. This can be done simply by calculating $\langle \psi | \phi_i \rangle$ many times and measuring (along with some phase tests).

Let $|\phi\rangle$ be the unit vector in the direction of the the component of $|\psi\rangle$ orthogonal to $(|\phi_i\rangle)_{i \in [k]}$: $|\phi\rangle = \Phi(|\phi_i\rangle)_{i \in [k]}, |\psi\rangle$. This will also implicitly tell us the component of $|\psi\rangle$ along $|\phi\rangle$: $\delta = \Delta(|\phi_i\rangle)_{i \in [k]}, |\psi\rangle$. Luckily, if δ is too small, we don't have to worry about this component in our approximate basis.

2. Assume the input is $|0^n\rangle$. We will be making a subroutine A that will within ϵ take $|0^n\rangle$ to $|\phi\rangle$. A will run on a primary register and use ancilla bits. A first runs V on the primary register. Then for each $i \in [k]$, it will CNOT into ancilla bit i if the primary register is $|\phi_i\rangle$.

The part of the state that has not written into these ancilla bits is, informally, correct. For these other cases, we need to rotate the primary register back to $|0^n\rangle$ and repeat. At the end, we will need to come back and clean up these ancilla bits by rotating them back to 0, but we know what angle we need to rotate them by due to step 1.

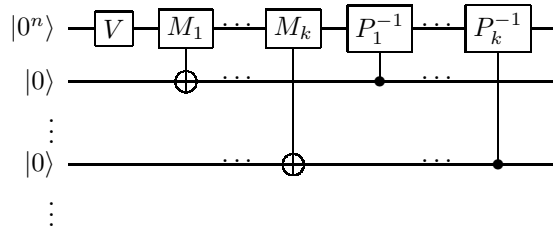

3. Then repeatedly, at step j , if any of the $[jk] \setminus [(j-1)k]$ ancilla bits are set to 1, rotate the primary register back to $|0^n\rangle$ and apply V again. Then CNOT the $jk+i$ ancilla bit to one if the register is $|\phi_i\rangle$.

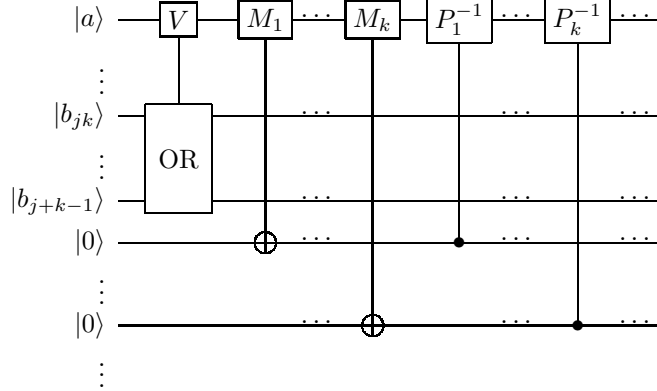

Recall δ is the inner product of $|\psi\rangle$ with $|\phi\rangle$, and let $\eta = 1 - \delta$. Then the magnitude of the current state that has some ancilla bit in $[(j + 1)k] \setminus [jk]$ set to 1 is η^j . Eventually, $\eta^j < \epsilon$ for $j = O\left(\frac{\ln(1/\epsilon)}{\delta}\right)$. And if all of the last k ancilla bits are 0, then the entangled primary register is exactly $|\phi\rangle$.

- Now we need to clean up the ancilla bits. The idea is that we are going to directly rotate them back into place. So consider the ideal state that is exactly the same, except the primary register is exactly $|\phi\rangle$. This has inner product $1 - \eta^j$ with the actual state.

Now, we fix the state by rotating the bits back as if it was exactly this ideal state. Since we know the angles from step 1, we can do this. This leaves us with the state $|\phi\rangle |0^{jk}\rangle$ on input $|0^n\rangle |0^{jk}\rangle$. Since the actual state we are acting on is only ϵ off from the one we analyzed, the final state is also within ϵ .

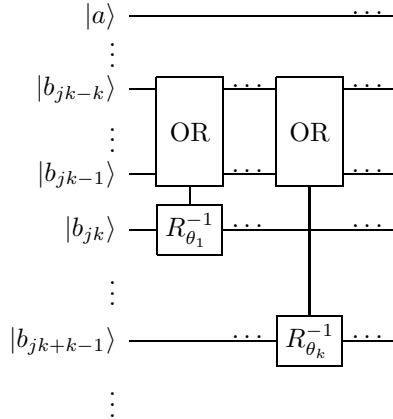

This completes subroutine A.

- Now we can control on the primary being $|0^n\rangle$ before we start to apply A. This takes us to $|\phi\rangle |1\rangle$, and we would like to clear out the control bit. But intuitively, the potential input state $|\phi\rangle |0\rangle |0^{jk}\rangle$ is in the way! We need to send it somewhere “empty”, specifically $|0^n\rangle |0\rangle |0^{jk}\rangle$.

So instead, we put into an auxiliary bit if the state is not $|0^n\rangle$. Controlled on the auxiliary bit, we run A^{-1} , moving, $|\phi\rangle$ to $|0^n\rangle$. Then we CNOT our auxiliary on our state being

$|0^n\rangle$, then controlled on it apply A . Finally, we CNOT on the state not being $|0^n\rangle$. That is, we apply the circuit:

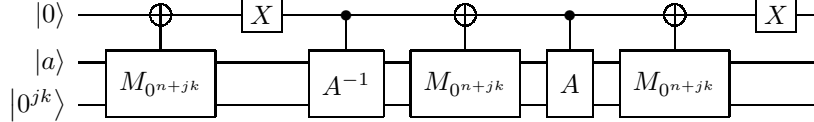

Now one can apply this inductively to get an approximate orthonormal basis. But to get good parameters, you have to be careful which order you apply this in.

1.4 Previous Work

One interesting feature of this work is that it asks questions about quantum oracles who are inherently quantum in nature and not classical. This is similar to some other work, such as [2]. This result is a refinement of ideas in [1].

1.5 Paper Layout

In section 2, we give some basic results about approximating components of a quantum vector, and basic techniques for combining rotations to create arbitrary unitaries.

In section 3, we prove lemma 5. In section 4, we go through the details required to construct our approximate basis theorem 6, which our main theorem is an immediate corollary of when combined with the results from section 2.

2 Sampling Angles and Rotations

In this section, I show how you can sample the components of a vector from an oracle computing it. Then I show how to apply any unitary on a subspace we can compute all the basis vectors of.

First, let us prove that we can estimate the components of one state along another with high probability.

Lemma 9 (Angle Approximation). *Let $|\psi\rangle$ be a unit vector on n qubits, and V unitary with $V|0^n\rangle|0^m\rangle = |\psi\rangle|0^m\rangle$. Let $|\phi\rangle$ be a unit vector on n qubits and U a unitary on n qubits with $U|0\rangle = |\phi\rangle$.*

Then for every $\epsilon, \gamma > 0$, there is a quantum circuit with size polynomial in $O\left(\frac{\ln(1/\gamma)}{\epsilon^2}\right)$ making $O\left(\frac{\ln(1/\gamma)}{\epsilon^2}\right)$ oracle calls to V and U computing complex number C with $\|C - \langle\phi|\psi\rangle\| \leq \epsilon$ with probability at least $1 - \gamma$.

Proof. We will do something similar to a swap test. First we Hadamard an ancilla bit. Then conditioned on it being one, we apply V then U^{-1} . Finally, we Hadamard the ancilla bit and measure both it and primary register.

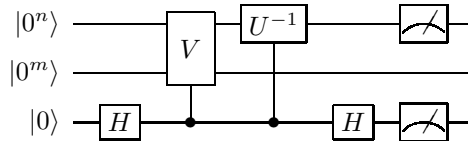

Let $C' = \langle \phi | \psi \rangle$. Then the probability of measuring a zero in the ancilla bit and $|0\rangle$ in the first register is

$$\frac{\|1 + C'\|^2}{4} = \frac{1}{4} (\text{complex}(C')^2 + (1 + \text{real}(C'))^2).$$

Similarly, the probability of measuring a one in the ancilla bit and $|0\rangle$ in the register is

$$\frac{\|1 - C'\|^2}{4} = \frac{1}{4} (\text{complex}(C')^2 + (1 - \text{real}(C'))^2).$$

Taking the difference of these probabilities directly gives us the real part of C' . By adding a phase shift by i on V , we can similarly estimate the complex component of C' .

Using Chernoff bounds, with probability at least $1 - \gamma$, we can approximate C' within ϵ using only $O\left(\frac{\ln(1/\gamma)}{\epsilon^2}\right)$ calls to V . \square

We also need a slightly stronger version of this theorem, saying that if we can approximately compute a state $|\phi\rangle$, then we can approximately compute the inner product of $|\psi\rangle$ and $|\phi\rangle$.

Lemma 10 (Robust Angle Approximation). *Let $|\psi\rangle$ be a unit vector on n qubits, and V unitary with $V|0^n\rangle|0^m\rangle = |\psi\rangle|0^m\rangle$. Let $|\phi\rangle$ be a unit vector and U be a unitary such that $\|U|0^n\rangle|0^m\rangle - |\phi\rangle|0^m\rangle\| \leq \eta$.*

Then for every $\epsilon, \gamma > 0$, there is a quantum circuit with size polynomial in $O\left(\frac{\ln(1/\gamma)}{\epsilon^2}\right)$ making $O\left(\frac{\ln(1/\gamma)}{\epsilon^2}\right)$ oracle calls to V and U computing complex number C with $\|C - \langle \phi | \psi \rangle\| \leq \epsilon + \eta$ with probability at least $1 - \gamma$.

Proof. Running lemma 9, with probability at least $1 - \gamma$, we will get a C so that

$$|C - (\langle \psi | \langle 0^m |) U |0^n\rangle |0^m\rangle| \leq \epsilon.$$

Then

$$\begin{aligned} |C - \langle \psi | \phi \rangle| &= |C - (\langle \psi | \langle 0^m |) U |0^n\rangle |0^m\rangle + (\langle \psi | \langle 0^m |) U |0^n\rangle |0^m\rangle - \langle \psi | \phi \rangle| \\ &\leq |C - (\langle \psi | \langle 0^m |) U |0^n\rangle |0^m\rangle| + |(\langle \psi | \langle 0^m |) U |0^n\rangle |0^m\rangle - \langle \psi | \langle 0^m | \rangle |\phi\rangle |0^m\rangle| \\ &\leq \epsilon + |U |0^n\rangle |0^m\rangle - |\phi\rangle |0^m\rangle| \\ &\leq \epsilon + \eta \end{aligned}$$

\square

After we have an approximate basis, the basic idea is to move the components of the input state in that basis into ancilla bits, do the local transformation on those components exactly and then move it back.

First, let us establish that we can implement the desired transformation on auxiliary bits. These are all standard facts whose proofs I omit.

Lemma 11 (Extrapolate Unitary). *Let $(v_i)_{i \in [k]}$ be orthonormal vectors with m components. Then there is a $\text{poly}(m)$ time algorithm that constructs an $m \times m$ unitary matrix whose first k columns are $(v_i)_{i \in [k]}$.*

Lemma 12 (Apply Arbitrary Unitary). *For any unitary U on $\log_2(m)$ qubits, there is a quantum circuit of size $\text{poly}(m)$ implementing U computable in polynomial time.*

Given oracles to prepare an orthogonal basis for $|\psi_i\rangle$ and the components of our $|\psi_i\rangle$ along them, we can compute the unitary from our main theorem using only a constant number of oracle calls.

Lemma 13 (Deferred Rotation). *Let $(|i\rangle)_{i \in [k]}$ be the computational basis vectors on n qubits representing i in binary. Let $(|\phi_i\rangle)_{i \in [l]}$ be l orthonormal vectors all orthogonal to $(|i\rangle)_{i \in [k]}$. Suppose that each $i \in [l]$ there is a unitary V_i that swaps $|0\rangle$ with $|\phi_i\rangle$ and does not effect orthogonal vectors.*

Consider some orthonormal $(|\psi_i\rangle)_{i \in [k]}$. Let $m = k + l$. Suppose that for each $i \in [k]$, there is an m dimensional vector v^i so that $|\psi_i\rangle = \sum_{j \in [k]} v_j^i |j\rangle + \sum_{j \in [l]} v_{k+j}^i |\phi_j\rangle$.

Then there is a circuit with size $\text{poly}(m)$ making a constant number of oracle calls to each V_i approximating a unitary, U , on n bits such that for all $i \in [k]$, $U|i\rangle = |\psi_i\rangle$ and for all $|\theta\rangle$ orthogonal to all $(|i\rangle)_{i \in [n]}$, $(|\phi_i\rangle)_{i \in [l]}$, we have $U|\theta\rangle = |\theta\rangle$.

Proof. We will use $p = \lceil \log_2(m) \rceil$ auxiliary bits to hold the $(|i\rangle)_{i \in [k]}$, $(|\phi_i\rangle)_{i \in [l]}$ subspace. Then we will perform the rotations on this subspace, then we will move it back.

Similar to definition 7, for $i \leq m$ let P_i be the permutation that swaps $|i\rangle$ and $|0\rangle$. As in definition 8, for $i \in [k]$ let M_i be the circuit that controlled on a state being i , nots another qubit. For $i \in [l]$, let $M_{|\phi_i\rangle}$ be:

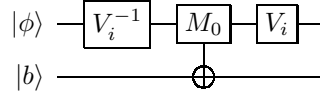

First we construct the circuit, A_1 , which puts the components of the state in the first k computational basis states into the ancilla state, and similarly for the states $(|\phi_i\rangle)_{i \in [l]}$. So A_1 is the following circuit:

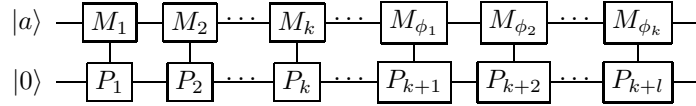

Then controlled on the ancilla state, we swap the states back.

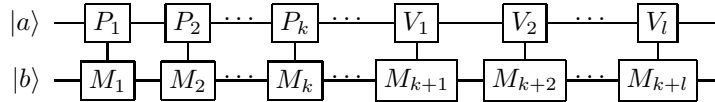

Then using lemma 11, we can get a $m \times m$ unitary, U' , who's first k column vectors are $(v_i)_{i \in [k]}$. Of course by padding U' , we can get unitary U'' on p qubits. Then using lemma 12, there is a circuit with size $O(2^p) = O(m)$ implementing U'' , call it A_3 . Then A_3 does the rotation on the auxiliary space.

Finally, we just run A_2^{-1} and A_1^{-1} to translate our results back into our main state. This leaves us with the final circuit

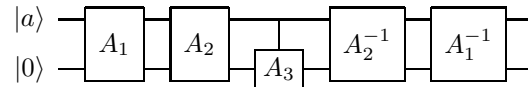

Now to see if this approximates an appropriate U , we just need to see if it gives the appropriate results on some basis.

- $i \in [k], |i\rangle$. This gives

$$\begin{aligned}
A_1 |i\rangle |0\rangle &= |i\rangle |i\rangle \\
A_2 A_1 |i\rangle |0\rangle &= |0\rangle |i\rangle \\
(I^{\otimes n} \otimes U'') A_2 A_1 |i\rangle |0\rangle &= |0\rangle \sum_{j \in [m]} v_j^i |j\rangle \\
A_2^{-1} (I^{\otimes n} \otimes U'') A_2 A_1 |i\rangle |0\rangle &= \sum_{j \in [k]} v_j^i |j\rangle |j\rangle + \sum_{j \in [l]} v_{k+j}^i |\phi_j\rangle |k+j\rangle \\
A_1^{-1} A_2^{-1} (I^{\otimes n} \otimes U'') A_2 A_1 |i\rangle |0\rangle &= \sum_{j \in [k]} v_j^i |j\rangle |0\rangle + \sum_{j \in [l]} v_{k+j}^i |\phi_j\rangle |0\rangle \\
&= |\psi_i\rangle |0\rangle.
\end{aligned}$$

As needed for U , takes $|i\rangle$ to $|\psi_i\rangle$ and leaves auxiliary bit as 0.

- $i \in [k], |\phi_i\rangle$. This gives

$$\begin{aligned}
A_1 |\phi_i\rangle |0\rangle &= |\phi_i\rangle |k+i\rangle \\
A_2 A_1 |\phi_i\rangle |0\rangle &= |0\rangle |k+i\rangle \\
(I^{\otimes n} \otimes U'') A_2 A_1 |\phi_i\rangle |0\rangle &= |0\rangle \sum_{j \in [m]} U_j''^i |j\rangle \\
A_2^{-1} (I^{\otimes n} \otimes U'') A_2 A_1 |\phi_i\rangle |0\rangle &= \sum_{j \in [k]} U_j''^{k+i} |j\rangle |j\rangle + \sum_{j \in [l]} U_{k+j}''^{k+i} |\phi_j\rangle |k+j\rangle \\
A_1^{-1} A_2^{-1} (I^{\otimes n} \otimes U'') A_2 A_1 |\phi_i\rangle |0\rangle &= \sum_{j \in [k]} U_j''^{k+i} |j\rangle |0\rangle + \sum_{j \in [l]} U_{k+j}''^{k+i} |\phi_j\rangle |0\rangle \\
&= \left(\sum_{j \in [k]} U_j''^{k+i} |j\rangle + \sum_{j \in [l]} U_{k+j}''^{k+i} |\phi_j\rangle \right) |0\rangle.
\end{aligned}$$

This leaves the auxiliary bits at 0, as required.

- $|\theta\rangle$ for any state orthogonal to all $(|i\rangle)_{i \in [k]}$ and all $(|\phi_i\rangle)_{i \in [l]}$. This gives

$$\begin{aligned}
A_1 |\theta\rangle |0\rangle &= |\theta\rangle |0\rangle \\
A_2 A_1 |\theta\rangle |0\rangle &= |\theta\rangle |0\rangle \\
(I^{\otimes n} \otimes U'') A_2 A_1 |\theta\rangle |0\rangle &= |\theta\rangle |0\rangle \\
A_2^{-1} (I^{\otimes n} \otimes U'') A_2 A_1 |\theta\rangle |0\rangle &= |\theta\rangle |0\rangle \\
A_1^{-1} A_2^{-1} (I^{\otimes n} \otimes U'') A_2 A_1 |\theta\rangle |0\rangle &= |\theta\rangle |0\rangle.
\end{aligned}$$

Which of course leaves the state unchanged.

So the circuit does the correct thing on every basis vector, so it indeed implements the appropriate operation. \square

3 How To Orthogonalize

Next let us prove the existence of our subroutine lemma 5, A , used in section 1.3. This is the subroutine that takes oracle calls preparing a state cleanly on one input, approximately to a circuit that prepares the orthogonal component of that state cleanly. After that, its a small step to make it work cleanly on any input.

Lemma 14 (Orthogonal Component Subroutine). *Let k be natural, and $(|\phi_i\rangle)_{i \in [k]}$ be orthonormal states on n qubits. Assume for each $i \in [k]$, there is some unitary U_i that swaps $|\phi_i\rangle$ with $|0^n\rangle$ and changes no other states. Let $|\psi\rangle$ be a state with $|\phi\rangle = \Phi((|\phi_i\rangle)_{i \in [k]}, |\psi\rangle)$ and $\beta = \Delta((|\phi_i\rangle)_{i \in [k]}, |\psi\rangle)$. For some $\delta > 0$, suppose $\beta > \delta$. Suppose for some natural m and unitary V we have $V|0^n\rangle|0^m\rangle = |\psi\rangle|0^m\rangle$.*

Then there exists some unitary W such that $W|0^n\rangle = |\phi\rangle$. Further, for all $\epsilon > 0$, for some natural p there exists a circuit, C , on $n + p$ qubits using oracle calls to V and U_i that C ϵ approximates W and has size $O\left(\frac{k \ln(1/\epsilon)}{\delta^2}\right)$.

Further, C only uses $O\left(\frac{\ln(1/\epsilon)}{\delta^2}\right)$ oracle calls to V , and each U_i . Let $v \in \mathbb{C}^k$ be such that for $i \in [k]$, $v_i = \langle \phi_i | \psi \rangle$, and $\alpha = \|v\| = \sqrt{1 - \beta^2}$. Then call $|\theta\rangle = \sum_{i \in [k]} \frac{v_i}{\alpha} |i\rangle$. Then we have that C uses only $O\left(\frac{\ln(1/\epsilon)}{\delta^2}\right)$ oracle calls to a unitary, R , on k qubits so that $R|0^k\rangle = \beta|0\rangle + \alpha|\theta\rangle$.

Importantly here, the circuit ONLY uses the relationship between $|\psi\rangle$ and the $|\phi_i\rangle$ in R . So if we give this a subroutine an η approximation of R , as long as β is sufficiently large, this still gives an $\eta O\left(\frac{\ln(1/\epsilon)}{\delta^2}\right)$ approximation of the appropriate unitary.

Proof. The algorithm is the same as in section 1.3 . Start with $|0\rangle$, apply V . Controlled on it being in one of the k states, set an ancilla register. Then conditioned on the ancilla register being set, rotate the state back to $|0\rangle$. Repeat until all but a small amplitude has the final ancilla bits set to 0. Then rotate the ancilla bits back to 0.

Similar to definition 7, for $i \leq m$ let P_i be the permutation that swaps $|i\rangle$ and $|0\rangle$. As in definition 8, for $i \in [k]$ let M_i be the circuit that controlled on a state being i , notes another qubit. For $i \in [l]$, let $M_{|\phi_i\rangle}$ be:

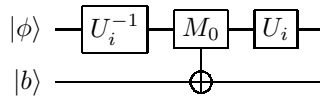

Then the circuit first does:

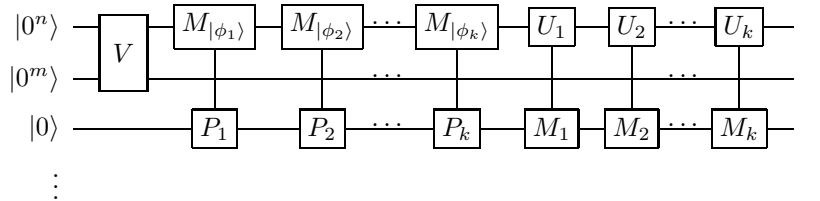

Call this A_1 .

Let $l = 4 \frac{\ln(1/\epsilon)}{\delta^2}$. Then for $j \in [l]$ (going from 1 to l), each with its own k state register, we

do

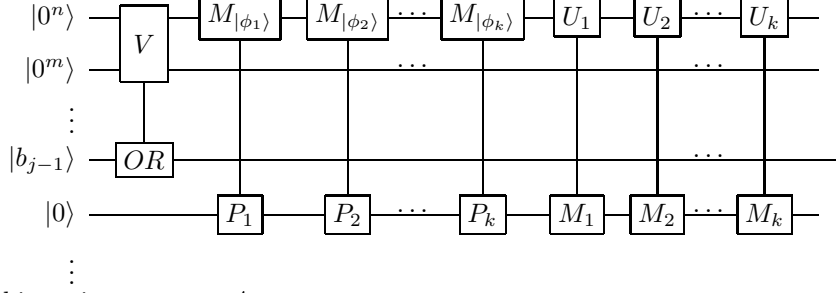

Call this entire sequence A_2 .

For $j \in [l]$ (from l to 1), we reset the auxiliary qubits.

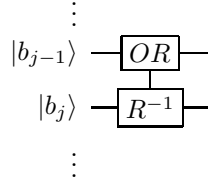

Call this entire sequence A_3 .

Finally, we just have to clean up the first set of auxiliary bits:

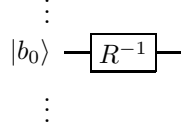

Call this A_4 .

Then $A = A_4 A_3 A_2 A_1$, and $p = m + \log_2(k)l$. First, I will show that $A_2 A_1 |0^n\rangle |0^p\rangle$ approximately prepares some state, $|a\rangle$. Then I will show that $A_4 A_3 |a\rangle = |\phi\rangle |0^p\rangle$. This implies A approximately prepares $|\phi\rangle |0^p\rangle$.

Let

$$|b\rangle = \beta \sum_{i=0}^{l-1} \alpha^i |\phi\rangle |0^m\rangle |\theta\rangle^i |0\rangle^{l-i} + \alpha^l |0^n\rangle |0^m\rangle |\theta\rangle^l$$

and

$$|a\rangle = |\phi\rangle |0^m\rangle \left(\beta \sum_{i=0}^{l-1} \alpha^i |\theta\rangle^i |0\rangle^{l-i} + \alpha^l |\theta\rangle^l \right).$$

Then see that:

$$\begin{aligned} \| |a\rangle - |b\rangle \| &\leq 2\alpha^l \\ &= 2(\alpha^2)^{2\frac{\ln(1/\epsilon)}{\delta^2}} \\ &= 2(1 - \beta^2)^{2\frac{\ln(1/\epsilon)}{\delta^2}} \\ &< 2(\epsilon)^{2\frac{\beta^2}{\delta^2}} \\ &\leq 2(\epsilon)^2 \\ &\leq \epsilon. \end{aligned}$$

In this last line, I assume $\epsilon < \frac{1}{2}$. Such an assumption only incurs constant impact on performance and thus can be ignored.

I claim $A_2 A_1 |0^n\rangle |0^p\rangle = |b\rangle$ and $A_4 A_3 |a\rangle = |\phi\rangle |0^p\rangle$. Since distances are preserved under unitary operations and $|b\rangle$ is within ϵ of $|a\rangle$, this would prove the claim.

See that

$$A_1 |0^n\rangle |0^p\rangle = \beta |\phi\rangle |0^m\rangle |0\rangle^l + \alpha |0^n\rangle |0^m\rangle |\theta\rangle |0\rangle^{l-1}.$$

Then one can show by induction after the j th step of A_2 , the state is

$$\beta \sum_{i=0}^j \alpha^i |\phi\rangle |0^m\rangle |\theta\rangle^i |0\rangle^{l-i} + \alpha^{j+1} |0^n\rangle |0^m\rangle |\theta\rangle^{j+1} |0\rangle^{l-j-1},$$

which then at the $j = l$ step gives $A_2 A_1 |0^n\rangle |0^p\rangle = |b\rangle$.

To prove $A_4 A_3 |a\rangle = |\phi\rangle |0^p\rangle$ follows by basically the same induction. See that at the j th step of A_3 , the state is

$$\begin{aligned} & |\phi\rangle |0^m\rangle \left(\beta \sum_{i=0}^j \alpha^i |\theta\rangle^i |0\rangle^{l-i} + \alpha^{j+1} |\theta\rangle^{j+1} |0\rangle^{l-j-1} \right) \\ &= |\phi\rangle |0^m\rangle \left(\beta \sum_{i=0}^{j-1} \alpha^i |\theta\rangle^i |0\rangle^{l-i} + \alpha^j \beta |\theta\rangle^j |0\rangle^{l-j} + \alpha^{j+1} |\theta\rangle^{j+1} |0\rangle^{l-j-1} \right). \\ &= |\phi\rangle |0^m\rangle \left(\beta \sum_{i=0}^{j-1} \alpha^i |\theta\rangle^i |0\rangle^{l-i} + \alpha^j |\theta\rangle^j (\beta |0\rangle + \alpha |\theta\rangle) |0\rangle^{l-j-1} \right). \end{aligned}$$

So when we apply the conditional rotation essentially undoes one rotation to give

$$|\phi\rangle |0^m\rangle \left(\beta \sum_{i=0}^{j-1} \alpha^i |\theta\rangle^i |0\rangle^{l-i} + \alpha^j |\theta\rangle^j |0\rangle^{l-j} \right).$$

And similarly A_4 does the final, non conditional step to convert

$$|\phi\rangle |0^m\rangle \left(\beta |0\rangle^l + \alpha |\theta\rangle |0\rangle^{l-1} \right)$$

into $|\phi\rangle |0^p\rangle$. Thus $A_4 A_3 |a\rangle = |\phi\rangle |0^p\rangle$.

So then

$$\begin{aligned} \|A_4 A_3 A_2 A_1 |0^n\rangle |0^p\rangle - |\phi\rangle |0^p\rangle\| &= \|A_4 A_3 |b\rangle - |\phi\rangle |0^p\rangle\| \\ &= \|A_4 A_3 |b\rangle - A_4 A_3 |a\rangle + A_4 A_3 |a\rangle - |\phi\rangle |0^p\rangle\| \\ &= \|A_4 A_3 (|b\rangle - |a\rangle)\| \\ &= \||b\rangle - |a\rangle\| \\ &\leq \epsilon. \end{aligned}$$

Finally, observe we only call V , each U_i and R $O(l)$ times. Thus proves the statement. \square

Finally, let us show how to use A to compute our orthogonal component cleanly on all inputs. Note, we use $|0\rangle$ as the state $|\phi\rangle$ is orthogonal for convenience, but this can easily be translated to any other state we can compute which we know $|\phi\rangle$ is orthogonal to.

Lemma 15 (Unitize Orthogonal Preparation). *Suppose $|\phi\rangle$ is orthogonal to $|0^n\rangle$, and for some unitary A , $A|0^n\rangle|0^m\rangle = |\phi\rangle|0^m\rangle$.*

Then there is a circuit C making 2 oracle calls to A such that $C|0^n\rangle|0^m\rangle|0\rangle = C|\phi\rangle|0^m\rangle|0\rangle$, $C|\phi\rangle|0^m\rangle|0\rangle = |0^n\rangle|0^m\rangle|0\rangle$ and for all $|a\rangle$ orthogonal to both $|\phi\rangle$ and $|0^n\rangle$ we have $C|a\rangle|0^m\rangle|0\rangle = |a\rangle|0^m\rangle|0\rangle$.

Proof. We already gave the circuit in our proof outline, and it uses standard techniques:

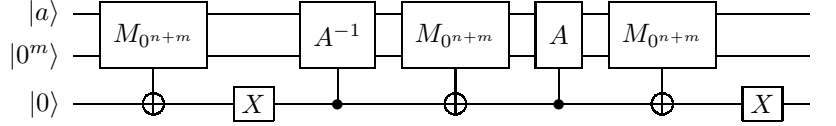

This can be checked manually on $|0^n\rangle|0^m\rangle$, $|\phi\rangle|0^m\rangle$ and any orthogonal $|\theta\rangle$ on $|\theta\rangle|0^m\rangle$. \square

Together, these trivially imply our main lemma.

Lemma 5 (State Orthogonalization). *Let k be natural, and $(|\phi_i\rangle)_{i \in [k]}$ be orthonormal states on n qubits. Assume for each $i \in [k]$, there is some unitary U_i that swaps $|\phi_i\rangle$ with $|0^n\rangle$ and changes no other states. Let $|\psi\rangle$ be a state with $|\phi\rangle = \Phi((|\phi_i\rangle)_{i \in [k]}, |\psi\rangle)$ and $\beta = \Delta((|\phi_i\rangle)_{i \in [k]}, |\psi\rangle)$. For some $\delta > 0$, suppose $\beta > \delta$. Suppose for some natural m and unitary V we have $V|0^n\rangle|0^m\rangle = |\psi\rangle|0^m\rangle$.*

Then there exists some unitary W such that $W|0^n\rangle = |\phi\rangle$ and for all vectors $|a\rangle$ orthogonal to both $|0^n\rangle$ and $|\phi\rangle$, we have $W|a\rangle = |a\rangle$. Further, for all $\epsilon > 0$, for some natural p there exists a circuit, C , on $n + p$ qubits using oracle calls to V and U_i that C ϵ approximates W and has size $O\left(\frac{k \ln(1/\epsilon)}{\delta^2}\right)$.

Further, C only uses $O\left(\frac{\ln(1/\epsilon)}{\delta^2}\right)$ oracle calls to V , and each U_i . Let $v \in \mathbb{C}^k$ be such that for $i \in [k]$, $v_i = \langle \phi_i | \psi \rangle$, and $\alpha = \|v\| = \sqrt{1 - \beta^2}$. Then call $|\theta\rangle = \sum_{i \in [k]} \frac{v_i}{\alpha} |i\rangle$. Then we have that C uses only $O\left(\frac{\ln(1/\epsilon)}{\delta^2}\right)$ oracle calls to a unitary, R , on k qubits so that $R|0^k\rangle = \beta|0\rangle + \alpha|\theta\rangle$.

Proof. Use lemma 14 with V and R to get a circuit A that $\epsilon/2$ approximately prepares $|\phi\rangle$. Then of course our unitary (on $n + m$ qubits) is within $\epsilon/2$ of some unitary (on $n + m$ qubits), B , that actually prepares $|\phi\rangle$. Then using B in lemma 15 will give a circuit, C , 0 approximation a unitary, W , on n qubits that swaps $|0\rangle$ and $|\phi\rangle$ and changes nothing else.

Then since C only calls B 2 times, swapping out B with A will only be off by twice the difference from A to B . Thus C' which uses the same circuit from lemma 15 except with A instead of B gives an ϵ approximation of W . Further, the size size is only a constant multiple of lemma 14, which satisfies our size constraints. \square

4 Computing an Approximate Orthonormal Basis

The above lemma, lemma 13, together with our main lemma, lemma 5 is enough to prove our main theorem, theorem 3. Still, the proofs are quite involved because we iteratively use approximations to find approximations and we have to be careful to make sure the errors don't accumulate in an unmanageable way.

The idea is straightforward. Iteratively find $|\phi_i\rangle$ as the component of $|\psi_i\rangle$ orthogonal to all $(|\psi_j\rangle)_{j < i}$ using lemma 5. If the length of $|\psi_i\rangle$ along $|\phi_i\rangle$ is small, then don't calculate $|\phi_i\rangle$.

For theorem 3, then it is good enough to just approximate $|\psi_i\rangle$ with the components of it in $(|\phi_j\rangle)_{j<i}$.

One of the main challenges now is making sure approximation errors don't propagate uncontrollably. First, we will quantify the error in lemma 9 algorithm when we use approximate preparation of states, and in lemma 5.

Lemma 16. *For natural k , let $(|\phi_i\rangle)_{i\in[k]}$ be orthonormal states on n qubit. Suppose for some integer m , for every $i \in [k]$ there is a unitary U_i such that $U_i|i\rangle = |\phi_i\rangle$. For each $i \in [k]$, suppose there is some $\eta_i > 0$, and there is some U'_i which is an η_i approximation of U_i . Let $\eta = \sum_{i\in[k]} \eta_i$.*

Suppose that for some unitary V and state $|\psi\rangle$, we have $V|0^n\rangle|0^m\rangle = |\psi\rangle|0^m\rangle$. Let $|\phi\rangle = \Phi((|\phi_i\rangle)_{i\in[k]}, |\psi\rangle)$. Suppose additionally that for some $\delta > 0$, $\Delta((|\phi_i\rangle)_{i\in[k]}, |\psi\rangle) \geq \delta$.

Then for $\epsilon_1 > 0$, there is a circuit with size $O(k \frac{\ln(k/\gamma)2k}{\epsilon_1^2})$ making oracle calls to the U'_i and V that outputs a C and for every $i \in [k]$ a A_i so that for

$$|\theta\rangle = \sum_{i\in k} A_i |\phi_i\rangle + C |\phi\rangle,$$

and $|\theta\rangle$ is a unit vector.

Define $\epsilon_2 \geq 0$ so that if $2(\eta + \epsilon_1) < \delta^2$,

$$\epsilon_2 = 4 \frac{\eta + \epsilon_1}{\delta},$$

and otherwise:

$$\epsilon_2 = 2\sqrt{(\eta + \epsilon_1)}.$$

We call an output good if

$$\| |\theta\rangle - |\psi\rangle \| \leq \epsilon_2.$$

Then with probability at least $1 - \gamma$, an output is good.

Let U be the unitary that swaps $|0^n\rangle$ with $|\phi\rangle$. Given good output from the first circuit, for all $\epsilon_3 > 0$, there is a circuit with size $O(k \frac{\ln(k/\epsilon_3)}{\delta^2})$ making $O(k \frac{\ln(k/\epsilon_3)}{\delta^2})$ oracle calls to V and each U'_i such that it

$$O\left(\epsilon_2 \frac{\ln(1/\epsilon_3)}{\delta^2}\right) + \epsilon_3$$

approximates U .

Proof. The idea is to take the angle estimation algorithm in lemma 10 and run it for each $i \in [k]$ to get an $\eta_i + \frac{\epsilon_1}{k}$ approximation of $\langle \phi_i | \psi \rangle = A_i$ with probability $1 - \frac{\gamma}{k}$. If all A_i are $\eta_i + \frac{\epsilon_1}{k}$ approximations, we say the output is "nice" which we will then show implies the output is good. By a union bound, the output is nice with probability at least $1 - \gamma$. Then we can calculate $|C|$ by taking it so the squares of A and C sum to one. That is, we use A to estimate C^2 and take the square root. If the sums of squares of A are greater than one, then let $C = 0$ and normalize.

Then given the output is good, we have a couple cases:

$C \neq 0$ First lets look at the calculated difference.

$$\begin{aligned}
\|\theta\rangle - |\psi\rangle\| &= \left\| \sum_{i \in k} A_i |\phi_i\rangle + C |\phi\rangle - |\psi\rangle \right\| \\
&= \sqrt{\sum_{i \in k} \|A_i - \langle \phi_i | \psi \rangle\|^2 + \|C - \langle \phi | \psi \rangle\|^2} \\
&\leq \sqrt{\sum_{i \in k} \left(\eta_i + \frac{\epsilon_1}{k}\right)^2 + |C - \langle \phi | \psi \rangle|^2} \\
&= \sqrt{(\eta + \epsilon_1)^2 + |C - \langle \phi | \psi \rangle|^2}.
\end{aligned}$$

Now we need to bound $|C - \langle \phi | \psi \rangle|^2$. First we will switch to some vector notation for simplicity. Let $u = (A_1, \dots, A_k)$ and $v = (\langle \phi_1 | \psi \rangle, \dots, \langle \phi_k | \psi \rangle)$. Then we can write

$$C = \sqrt{1 - \|u\|^2} \quad (1)$$

$$\Delta((|\phi_i\rangle)_{i \in [k]}, |\psi\rangle) = \langle \phi | \psi \rangle = \sqrt{1 - \|v\|^2} \geq \delta. \quad (2)$$

For each i , we have that $|v_i - u_i| \leq \eta_i + \frac{\epsilon_1}{k}$. By a tailor approximation for x^2 , for any $a, b \in (-1, 1)$, $|a^2 - b^2| \leq 2|a - b|$, we have $|v_i^2 - u_i^2| \leq 2(\eta_i + \frac{\epsilon_1}{k})$. By a triangle inequality, we have that

$$\| \|u\|^2 - \|v\|^2 \| \leq 2 \sum_{i \in [k]} \left(\eta_i + \frac{\epsilon_1}{k}\right) = 2(\eta + \epsilon_1). \quad (3)$$

So we really are comparing difference of square roots in terms of the differences of their arguments:

$$|C - \langle \phi | \psi \rangle| = |\sqrt{1 - \|u\|^2} - \sqrt{1 - \|v\|^2}|.$$

- First lets handle the general case with no lower bound on $\langle \phi | \psi \rangle$. Since the square root function is positive, monotone increasing, and convex, we have for all $a, b \geq 0$, $|\sqrt{b} - \sqrt{a}| \leq \sqrt{|b - a|}$. Thus

$$\begin{aligned}
|C - \langle \phi | \psi \rangle| &= |\sqrt{1 - \|u\|^2} - \sqrt{1 - \|v\|^2}| \\
&\leq \sqrt{\| \|u\|^2 - \|v\|^2 \|} \\
&\leq \sqrt{2(\eta + \epsilon_1)}.
\end{aligned}$$

If $\eta + \epsilon_1 > 1$, then trivially we have $\|\theta\rangle - |\psi\rangle\| \leq 2 \leq 2\sqrt{\eta + \epsilon_1}$. Otherwise:

$$\begin{aligned}
\|\theta\rangle - |\psi\rangle\| &= \sqrt{2(\eta + \epsilon_1)^2 + \sqrt{2(\eta + \epsilon_1)}^2} \\
&\leq \sqrt{2(\eta + \epsilon_1)^2 + 2(\eta + \epsilon_1)} \\
&\leq 2\sqrt{\eta + \epsilon_1}.
\end{aligned}$$

– Now let us assume $2(\eta + \epsilon_1) < \delta^2$. First, rewrite $\sqrt{1 - \|u\|^2}$ as

$$\begin{aligned} C &= \sqrt{1 - \|u\|^2} \\ &= \sqrt{1 - \|v\|^2 + \|v\|^2 - \|u\|^2} \\ &= \sqrt{(1 - \|v\|^2) \left(1 + \frac{\|v\|^2 - \|u\|^2}{1 - \|v\|^2}\right)} \\ &= \sqrt{1 - \|v\|^2} \sqrt{1 + \frac{\|v\|^2 - \|u\|^2}{1 - \|v\|^2}}. \end{aligned}$$

Now when $\|v\|^2 - \|u\|^2 \ll 1 - \|v\|^2$, we have $\sqrt{1 + \frac{\|v\|^2 - \|u\|^2}{1 - \|v\|^2}} \sim 1 + \frac{1}{2} \frac{\|v\|^2 - \|u\|^2}{1 - \|v\|^2}$ from a binomial approximation. In particular

$$\left| \sqrt{1 + \frac{\|v\|^2 - \|u\|^2}{1 - \|v\|^2}} - 1 - \frac{1}{2} \frac{\|v\|^2 - \|u\|^2}{1 - \|v\|^2} \right| \leq \frac{1}{4} \left(\frac{\|v\|^2 - \|u\|^2}{1 - \|v\|^2} \right)^2. \quad (4)$$

Now when we calculate the difference, we get:

$$\begin{aligned} |C - \langle \phi | \psi \rangle| &= \left| \sqrt{1 - \|u\|^2} - \sqrt{1 - \|v\|^2} \right| \\ &= \left| \sqrt{1 - \|v\|^2} \sqrt{1 + \frac{\|v\|^2 - \|u\|^2}{1 - \|v\|^2}} - \sqrt{1 - \|v\|^2} \right| \\ &= \sqrt{1 - \|v\|^2} \left| \sqrt{1 + \frac{\|v\|^2 - \|u\|^2}{1 - \|v\|^2}} - 1 \right| \\ &\leq \sqrt{1 - \|v\|^2} \left(\left| 1 + \frac{1}{2} \frac{\|v\|^2 - \|u\|^2}{1 - \|v\|^2} - 1 \right| + \frac{1}{4} \left(\frac{\|v\|^2 - \|u\|^2}{1 - \|v\|^2} \right)^2 \right) \\ &\leq \sqrt{1 - \|v\|^2} \left(\frac{1}{2} \frac{\|v\|^2 - \|u\|^2}{1 - \|v\|^2} + \frac{1}{4} \frac{\|v\|^2 - \|u\|^2}{1 - \|v\|^2} \frac{\|v\|^2 - \|u\|^2}{1 - \|v\|^2} \right) \\ &\leq \frac{\|v\|^2 - \|u\|^2}{\sqrt{1 - \|v\|^2}} \left(\frac{1}{2} + \frac{1}{4} \frac{\|v\|^2 - \|u\|^2}{1 - \|v\|^2} \right). \end{aligned}$$

Finally, recalling that that eq. (2), eq. (3) and our assumption that $2(\eta + \epsilon_1) < \delta^2$, we have

$$\begin{aligned} |C - \langle \phi | \psi \rangle| &\leq \frac{\|v\|^2 - \|u\|^2}{\sqrt{1 - \|v\|^2}} \left(\frac{1}{2} + \frac{1}{4} \frac{\|v\|^2 - \|u\|^2}{1 - \|v\|^2} \right) \\ &\leq \frac{2(\eta + \epsilon_1)}{\delta} \left(\frac{1}{2} + \frac{1}{4} \frac{2(\eta + \epsilon_1)}{\delta^2} \right) \\ &\leq \frac{2(\eta + \epsilon_1)}{\delta}. \end{aligned}$$

So together

$$\begin{aligned}
\| |\theta\rangle - |\psi\rangle \| &= \sqrt{2(\eta + \epsilon_1)^2 + |C - \langle \phi | \psi \rangle|^2} \\
&\leq \sqrt{2(\eta + \epsilon_1)^2 + \left(\frac{2(\eta + \epsilon_1)}{\delta} \right)^2} \\
&\leq 4 \frac{\eta + \epsilon_1}{\delta}.
\end{aligned}$$

So $\| |\theta\rangle - |\psi\rangle \| \leq \epsilon_2$.

$C = 0$ Following a similar proof to the last case, the unnormalized version of the formula satisfies the relation. The concern is that normalization might make the difference worse. Well suppose we have two vectors, u, v , with $\|u\| > \|v\| = 1$. We would like to show $\| \frac{u}{\|u\|} - v \| \leq \|u - v\|$. Well,

$$\begin{aligned}
\| \frac{u}{\|u\|} - v \|^2 &= \sum_i \left(\frac{u_i}{\|u\|} - v_i \right)^2 \\
&= \sum_i \frac{u_i^2}{\|u\|^2} + \sum_i v_i^2 - 2 \sum_i \frac{u_i}{\|u\|} v_i \\
&= 2 - 2 \frac{1}{\|u\|} \sum_i u_i v_i \\
&\leq 2 \|u\| - 2 \sum_i u_i v_i \\
&\leq \|u\|^2 + 1 - 2 \sum_i u_i v_i \\
&= \sum_i u_i^2 + \sum_i v_i^2 - 2 \sum_i u_i v_i \\
&= \sum_i (u_i - v_i)^2 \\
&= \|u - v\|^2.
\end{aligned}$$

That proves the claims about $|\theta\rangle$. Note, this actually gives an ϵ_2 approximation of the rotation R required for lemma 14.

Now to approximate U , we just use lemma 14 to get a circuit A . All that remains to be done is verifying the size and approximation is what we claimed. Well A has size $O\left(\frac{k \ln(1/\epsilon_3)}{\delta^2}\right)$, and would have error ϵ_3 if each U'_i and R was a 0 approximation. Instead, each U'_i is an η_i approximation and are each called $O\left(\frac{\ln(1/\epsilon_3)}{\delta^2}\right)$ times while R is an ϵ_2 approximation called

$O\left(\frac{\ln(1/\epsilon_3)}{\delta^2}\right)$ times. Thus A is an

$$\begin{aligned} & O\left(\frac{\ln(1/\epsilon_3)}{\delta^2}\right) \left(\epsilon_2 + \sum_{i \in k} \eta_i\right) + \epsilon_3 \\ = & O\left((\eta + \epsilon_2) \frac{\ln(1/\epsilon_3)}{\delta^2}\right) + \epsilon_3 \\ = & O\left(\epsilon_2 \frac{\ln(1/\epsilon_3)}{\delta^2}\right) + \epsilon_3 \end{aligned}$$

approximation. □

Now applying lemma 16 in the straightforward way gives a weak version of theorem 6. But we might get unlucky and constantly get small $\delta \sim \epsilon$. This would rule out having non constant ϵ and k at the same time for a polytime algorithm. We have to be very careful to construct our orthogonal components in an order that only has non constant δ when orthogonalizing small circuits. We achieve this in two ways.

1. We can actually orthogonalize with respect to parts of our basis at a time. So if δ is not constant, we orthogonalize with respect to the parts of the previously computed basis that have “small” circuits. Hopefully the resulting state has a large δ .
2. Every time the above procedure fails to give a state with constant δ , we reset the group of circuits we consider “small” to be all the circuits.

The key insight here is the above resetting can only occur at most $O(\ln(k/\epsilon))$ times, after which point the initial δ must be less than ϵ .

The straightforward thing is to orthogonalize each V_i in order. But this may lead having to pay the $\frac{1}{\epsilon}$ factor k times. So instead, each component we orthogonalize will proceed in two steps: orthogonalize on the small circuits, orthogonalize on the rest. To do this, we will keep track of an “orthogonalization depth” which will intuitively count the number of times we had to pay the $\frac{1}{\epsilon}$ factor. But specifically, it will maintain the number of times we added more circuits to our “small circuits”.

Now we have all the tools to prove theorem 6.

Theorem 6 (Approximate Basis). *For natural k , let $(|\psi_i\rangle)_{i \in [k]}$ be states on n qubits. Suppose for some integer m , for every $i \in [k]$ there was a unitary V_i such that $V_i |0\rangle |0^m\rangle = |\psi_i\rangle |0^m\rangle$.*

Then for every $\epsilon > 0$, $\gamma > 0$ there is an algorithm that runs in time

$$\text{poly} \left((k + \ln(1/\epsilon))^k \left(\frac{k}{\epsilon}\right)^{\min\{k, \ln(k/\epsilon)\}} \right) \ln(1/\gamma)$$

that with probability at most γ fails to find the following:

For some orthonormal basis Y containing at most k vectors so that for all $i \in [k]$, $\Delta(Y, |\psi_i\rangle) < \frac{\epsilon}{4k}$, the algorithm computes the following:

A set of circuits $X = (x_a)_{|a\rangle \in Y}$ so that for each $|a\rangle \in Y$, there is an $x_a \in X$ and $\eta_{x_a} \in \mathbb{R}$ so that $x_a \eta_{x_a}$ approximates the unitary that swaps $|a\rangle$ and $|0\rangle$ with error η_{x_a} , and

$$\sum_{x \in X} |x| \leq \text{poly} \left((k + \ln(1/\epsilon))^k \left(\frac{k}{\epsilon}\right)^{\min\{k, \ln(k/\epsilon)\}} \right),$$

and

$$\sum_{x \in |X|} \eta_x \leq \epsilon.$$

Proof. We will use $\epsilon_1 > 0$ as some constant that will be decided later which will be polynomial in the size of the circuit. Similarly, we have $\gamma' > 0$ as the chance measurement at any step fails. We will need to use lemma 16, so for book keeping, we will need constants for them.

So let A be the constant from the last line in lemma 16 for the case where $2(\eta + \epsilon_1) \leq \delta^2$. That is, when the output is good, we have an

$$A \frac{(\eta + \epsilon_1) \ln(1/\epsilon_1)}{\delta^3}$$

approximation. Similarly, the resulting U , for some constant C , makes less than

$$C \frac{\ln(k/\epsilon_1)}{\delta^2}$$

calls to each oracle.

The proof is then by induction on each added basis state and circuit to approximate it.

Base Case The proof is by induction. To start, let $X_0 = \bigcup_{i \in [k]} \{P_i\}$ be the circuits that prepare the first k computational basis states. Let $Y_0 = \bigcup_{i \in [k]} \{|i\rangle\}$ be the states prepared by X_0 . Let $Z_0 = \emptyset$, which are the oracles we have unitized.

Let $X'_0 = \emptyset$ be the initial set of "small" circuits that produce initial basis states $Y'_0 = \emptyset$. Let our orthogonalization depth be $d_o = 0$.

Assume Let $j \in \{0, \dots, k-1\}$. Then there is a set Y_j of orthonormal states including the first k computational basis states. There is a set X_j of circuits, where for $|a\rangle \in Y_j$ there is a $x_a \in X_j$ that η_{x_a} approximates a unitary preparing $|a\rangle$. Suppose so far our depth is $d_j = d$. Then we have

$$\eta = \sum_{x \in X_j} \eta_{x_a} \leq (512A \ln(1/\epsilon_1))^j \left(8192A \frac{k^3 \ln(1/\epsilon_1)}{\epsilon^3} \right)^d \epsilon_1$$

and

$$\sum_{x \in X_j} |x| \leq (64C \ln(k/\epsilon_1))^j \left(\frac{256Ck^2 \ln(k/\epsilon_1)}{\epsilon^2} \right)^d.$$

In a similar way, X'_j is a set of circuits, where for $|a\rangle \in Y'_j$ there is a $x_a \in X'_j$ that η_{x_a} approximates a unitary preparing $|a\rangle$. Then we have

$$\eta' = \sum_{x \in X'_j} \eta_{x_a} \leq (512A \ln(1/\epsilon_1))^j \left(8192A \frac{k^3 \ln(1/\epsilon_1)}{\epsilon^3} \right)^{d-1} \epsilon_1$$

and

$$\sum_{x \in X'_j} |x| \leq (64C \ln(k/\epsilon_1))^j \left(\frac{256Ck^2 \ln(k/\epsilon_1)}{\epsilon^2} \right)^{d-1}.$$

Suppose that $Z_j \subseteq [k]$ with $|Z_j| = j$ and for all $i \in Z_j$, $\Delta(Y_j, |\psi_i\rangle) \leq \frac{\epsilon}{4k}$. Further for $i \in [k] \setminus Z_j$, we have $\Delta(Y'_j, |\psi_i\rangle)^2 \leq \left(\frac{2}{3}\right)^d$.

Implies First, use lemma 16 to calculate for each $i \in [k] \setminus Z_j$ the components of $|\psi_i\rangle$ along each vector in Y_j . This will succeed with additive error at most $\eta + \frac{\epsilon_1}{k}$ with probability at least $1 - k\gamma'$. Using these components, we can approximate $\Delta(Y_j, \Phi(Y'_j, |\psi_i\rangle))$, $\Delta(Y_j, |\psi_i\rangle)$ and $\Delta(Y'_j, |\psi_i\rangle)$ directly. Distinguish the calculated components using our estimates as Δ' .

Suppose for some i

$$\Delta'(Y_j, |\psi_i\rangle) < \frac{\epsilon}{8k}.$$

Well $\Delta'(Y_j, |\psi_i\rangle)$ is off by at most $2\sqrt{\eta + \epsilon_1}$. We will choose ϵ_1 so that this is less than $\frac{\epsilon}{16k}$. Then

$$\Delta(Y_j, |\psi_i\rangle) < \frac{\epsilon}{4k},$$

so let $Z_{j+1} = Z_j \cup \{i\}$, $X_{j+1} = X_j$, $Y_{j+1} = Y_j$, $X'_{j+1} = X'_j$, $Y'_{j+1} = Y'_j$, and $d_{j+1} = d_j$. And we are done and can move onto the next j .

Otherwise, see that we also have

$$\Delta(Y'_j, |\psi_i\rangle) \geq \Delta(Y_j, |\psi_i\rangle) \geq \frac{\epsilon}{16k}.$$

Now, for each $i \in [k] \setminus Z_j$ calculate (a numerical approximation of)

$$\begin{aligned} \delta'_i &\sim \Delta(Y_j, \Phi(Y'_j, |\psi_i\rangle)) \\ &= \frac{\Delta(Y_j, |\psi_i\rangle)}{\Delta(Y'_j, |\psi_i\rangle)}. \end{aligned}$$

See that if $\sqrt{3(\eta + \epsilon_1)} < \frac{\epsilon^2}{1000k^2}$, then the error of δ will be at most $\frac{\epsilon}{16k} < \frac{1}{4}$. Again, we will later choose ϵ_1 so this is true.

Either for some i , $\delta'_i > \frac{1}{2}$, or for all it is not.

– $\exists i \in [k] \setminus Z_j : \delta'_i > \frac{1}{2}$: then take such i . Then

$$\delta_i = \Delta(Y_j, \Phi(Y'_j, |\psi_i\rangle)) > \frac{1}{4}.$$

If we have $Y'_j = \emptyset$ and $d = 0$, then just let $V'_i = V_i$ and $|\psi'_i\rangle = |\psi_i\rangle$ and move onto the next step.

Otherwise, run lemma 16 using V_i and X'_j to get circuit V'_i that approximately computes $|\psi'_i\rangle = \Phi(Y'_j, |\psi_i\rangle)$.

Then V'_i is a circuit

$$\begin{aligned} \eta'_i &\leq A \frac{(\eta' + \epsilon_1) \ln(1/\epsilon_1)}{\delta^3} \\ &\leq 8192k^3 \frac{\ln(1/\epsilon_1)}{\epsilon^3} \eta' \\ &\leq 8192k^3 \frac{\ln(1/\epsilon_1)}{\epsilon^3} (512A \ln(1/\epsilon_1))^j \left(8192A \frac{k^3 \ln(1/\epsilon_1)}{\epsilon^3} \right)^{d-1} \epsilon_1 \\ &\leq (512A \ln(1/\epsilon_1))^j \left(8192A \frac{k^3 \ln(1/\epsilon_1)}{\epsilon^3} \right)^d \epsilon_1 \end{aligned}$$

approximating $|\psi'_i\rangle$. Further, V'_i has size

$$\begin{aligned}
|V'_i| &\leq C \frac{\ln(k/\epsilon_1)}{\delta^2} \sum_{x \in X'_j} |x| \\
&\leq C 256 k^2 \frac{\ln(k/\epsilon_1)}{\epsilon^2} \sum_{x \in X'_j} |x| \\
&\leq C 256 k^2 \frac{\ln(k/\epsilon_1)}{\epsilon^2} (64C \ln(k/\epsilon_1))^j \left(\frac{256Ck^2 \ln(k/\epsilon_1)}{\epsilon^2} \right)^{d-1} \\
&\leq (64C \ln(k/\epsilon_1))^j \left(\frac{256Ck^2 \ln(k/\epsilon_1)}{\epsilon^2} \right)^d.
\end{aligned}$$

Now given V'_i approximating $|\psi'_i\rangle$, we run lemma 16 get circuit U_i which approximates $|\phi_i\rangle = \Phi(Y_j, |\psi'_i\rangle)$. Then the error on U_i , η_i , is

$$\begin{aligned}
\eta_i &\leq A \frac{(\eta + \eta'_i + \epsilon_1) \ln(1/\epsilon_1)}{\delta^3} \\
&\leq A 128 (\eta + \eta'_i) \ln(1/\epsilon_1) \\
&\leq A 256 \ln(1/\epsilon_1) (512A \ln(1/\epsilon_1))^j \left(8192A \frac{k^3 \ln(1/\epsilon_1)}{\epsilon^3} \right)^d \epsilon_1 \\
&\leq \frac{1}{2} (512A \ln(1/\epsilon_1))^{j+1} \left(8192A \frac{k^3 \ln(1/\epsilon_1)}{\epsilon^3} \right)^d \epsilon_1.
\end{aligned}$$

And for the size of U_i ,

$$\begin{aligned}
|U_i| &\leq C \frac{\ln(k/\epsilon_1)}{\delta^2} (|V'_i| + \sum_{x \in X_j} |x|) \\
&\leq C 16 \ln(k/\epsilon_1) 2 (64C \ln(k/\epsilon_1))^j \left(\frac{256Ck^2 \ln(k/\epsilon_1)}{\epsilon^2} \right)^d \\
&\leq \frac{1}{2} (64C \ln(k/\epsilon_1))^{j+1} \left(\frac{256Ck^2 \ln(k/\epsilon_1)}{\epsilon^2} \right)^d.
\end{aligned}$$

Finally, let $Y_{j+1} = Y_j \cup \{|\phi_i\rangle\}$, $X_{j+1} = X_j \cup \{U_i\}$, $Z_{j+1} = Z_j \cup \{i\}$, $X'_{j+1} = X'_j$, $Y'_{j+1} = Y'_j$ and $d_{j+1} = d_j$. One can easily verify that

$$\sum_{x \in X_{j+1}} \eta_{x_a} \leq (512A \ln(1/\epsilon_1))^{j+1} \left(8192A \frac{k^2 \ln(1/\epsilon_1)}{\epsilon_1^3} \right)^d \epsilon_1$$

and

$$\sum_{x \in X_{j+1}} |x| \leq (64C \ln(k/\epsilon_1))^{j+1} \left(\frac{256Ck^2 \ln(k/\epsilon_1)}{\epsilon^2} \right)^d.$$

The rest hold since X'_{j+1} , Y'_{j+1} and d_{j+1} have not been modified.

- $\forall i \in [k] \setminus Z_j : \delta'_i \leq \frac{1}{2}$. Then in this case, orthogonalizing with respect to Y'_j first won't help much. So just choose some arbitrary $i \in [k] \setminus Z_j$. Let $Y'_{j+1} = Y_j$, $X'_{j+1} = X_j$, $Z_{j+1} = Z_j \cup \{i\}$, and $d_{j+1} = d + 1$.

Use lemma 16 with V_i and X_j to get U_i approximating $|\phi_i\rangle = \Phi(Y_j, |\psi_i\rangle)$. The error of U_i is

$$\begin{aligned}
\eta_i &\leq A \frac{(\eta + \epsilon_1) \ln(1/\epsilon_1)}{\delta^3} \\
&\leq A 8192 k^3 \frac{\ln(1/\epsilon_1)}{\epsilon^3} \eta \\
&\leq A 8192 k^3 \frac{\ln(1/\epsilon_1)}{\epsilon^3} (512 A \ln(1/\epsilon_1))^j \left(8192 A \frac{k^3 \ln(1/\epsilon_1)}{\epsilon^3} \right)^d \epsilon_1 \\
&\leq (512 A \ln(1/\epsilon_1))^j \left(8192 A \frac{k^3 \ln(1/\epsilon_1)}{\epsilon^3} \right)^{d+1} \epsilon_1
\end{aligned}$$

and the size of U_i is

$$\begin{aligned}
|U_i| &\leq C \frac{\ln(k/\epsilon_1)}{\delta^2} \sum_{x \in X_j} |x| \\
&\leq C 256 k^2 \frac{\ln(k/\epsilon_1)}{\epsilon^2} \sum_{x \in X_j} |x| \\
&\leq C 256 k^2 \frac{\ln(k/\epsilon_1)}{\epsilon^2} (64 C \ln(k/\epsilon_1))^j \left(\frac{256 C k^2 \ln(k/\epsilon_1)}{\epsilon^2} \right)^d \\
&\leq (64 C \ln(k/\epsilon_1))^j \left(\frac{256 C k^2 \ln(k/\epsilon_1)}{\epsilon^2} \right)^{d+1}.
\end{aligned}$$

Then let $X_{j+1} = X_j \cup \{U_i\}$ and $Y_{j+1} = Y_j \cup \{|\phi_i\rangle\}$. A quick calculation shows the size and approximation assumptions are satisfied. The last thing to check is to choose an $m \in [k] \setminus Z_{j+1}$, and check that $\Delta(Y'_{j+1}, |\psi_m\rangle)^2 \leq \left(\frac{2}{3}\right)^{d+1}$.

By assumption, $\delta'_m \leq \frac{1}{2}$, so because the error is less than $\frac{\epsilon}{16k} < \frac{1}{16}$, we have

$$\frac{\Delta(Y_j, |\psi_m\rangle)}{\Delta(Y'_j, |\psi_m\rangle)} \leq \frac{2}{3}.$$

S

$$\delta_m = \Delta(Y'_{j+1}, |\psi_m\rangle) \leq \frac{2}{3}.$$

$$\begin{aligned}
\frac{\Delta(Y_j, |\psi_m\rangle)}{\Delta(Y'_j, |\psi_m\rangle)} &\leq \frac{2}{3} \\
\Delta(Y'_{j+1}, |\psi_m\rangle) &\leq \frac{2}{3} \Delta(Y'_j, |\psi_m\rangle) \\
&\leq \frac{2}{3} \left(\frac{2}{3}\right)^d \\
&\leq \left(\frac{2}{3}\right)^{d+1}.
\end{aligned}$$

Thus our inductive hypothesis holds.

We can bound the final depth, d , by the fact that for d to increase, we must not have any $i \in [k] \setminus Z_j$ with

$$\Delta(Y'_j, |\psi_i\rangle) \leq \frac{\epsilon}{16k},$$

otherwise, we would have added that to Y first. Thus

$$\begin{aligned} \left(\frac{2}{3}\right)^{d-1} &\geq \frac{\epsilon}{16k} \\ d &\leq O(\ln(k/\epsilon)). \end{aligned}$$

We also trivially have that $d \leq k$. Thus

$$d \leq O(\min\{k, \ln(k/\epsilon)\}).$$

At the end of this induction, we will have circuits X giving us the required basis with cumulative error

$$\begin{aligned} \eta &= \sum_{x \in X} \eta_x \\ &\leq (512A \ln(1/\epsilon_1))^k \left(8192A \frac{k^3 \ln(1/\epsilon_1)}{\epsilon^3}\right)^{O(\min\{k, \ln(k/\epsilon)\})} \epsilon_1 \\ &\leq \text{poly} \left(\ln(1/\epsilon_1)^k \left(\frac{k \ln(1/\epsilon_1)}{\epsilon}\right)^{\min\{k, \ln(k/\epsilon)\}} \right) \epsilon_1 \end{aligned}$$

and size

$$\begin{aligned} \sum_{x \in X} |x| &\leq (64C \ln(k/\epsilon_1))^k \left(\frac{256Ck^2 \ln(k/\epsilon_1)}{\epsilon^2}\right)^{O(\min\{k, \ln(k/\epsilon)\})} \\ &\leq \text{poly} \left((\ln(k/\epsilon_1))^k \left(\frac{k \ln(k/\epsilon_1)}{\epsilon^2}\right)^{\min\{k, \ln(k/\epsilon)\}} \right). \end{aligned}$$

This is ALMOST the claimed size. Now we want to make sure this final error has $\eta < \frac{\epsilon}{16k}$, and $\sqrt{3(\eta + \epsilon_1)} < \frac{\epsilon^2}{1000k^2}$, and inside of lemma 16, I also need $2(\eta + \epsilon_1) \leq \left(\frac{\epsilon}{16k}\right)^2$. This holds for some

$$\epsilon_1 = e^{-\text{poly}(k + \ln(1/\epsilon))}.$$

Take ϵ_1 to be such that it is still polynomial in the output circuit size.

Then the final size is

$$\sum_{x \in X} |x| \leq \text{poly} \left((k + \ln(1/\epsilon))^k \left(\frac{k}{\epsilon}\right)^{\min\{k, \ln(k/\epsilon)\}} \right).$$

Our angle approximations were all computed with polynomial sized circuits, and the total risk of failure is at most γ' times a polynomial in the size of our output circuits. The size of each angle approximation circuit is of size polynomial in $1/\epsilon_1$, which is also polynomial in the size of the output circuit, and k times $\ln(1/\gamma')$. Then the probability of any approximation failing is at most γ' times the size of the circuit, but by taking $\gamma' = \gamma / (\sum_{x \in X} |x|)$, the circuit producing circuit still has polynomial size in the circuit output times $\ln(1/\gamma)$. \square

And using standard techniques with the previous theorem gives our main result.

Theorem 3 (Clean Unitary). *For natural k , let $(|\psi_i\rangle)_{i \in [k]}$ be orthonormal states on n qubits. Suppose for some integer m , for every $i \in [k]$ there was a unitary V_i such that $V_i |0\rangle |0^m\rangle = |\psi_i\rangle |0^m\rangle$.*

Then there is some unitary U on n qubits so that for all $i \in [k]$, $U |i\rangle = |\psi_i\rangle$ and for all states $|\phi\rangle$ orthogonal to each $(|\psi_i\rangle)_{i \in [k]}$ and $(|i\rangle)_{i \in [k]}$, $U |\phi\rangle = |\phi\rangle$.

Then for every $\epsilon > 0$, for some integer p , there is a quantum circuit, C , on $n + p$ qubits with oracle access to $(V_i)_{i \in [k]}$ that ϵ approximates U with size

$$\text{poly} \left((k + \ln(1/\epsilon))^k \left(\frac{k}{\epsilon} \right)^{\min\{k, \ln(k/\epsilon)\}} \right).$$

5 Future Work

This algorithm gives a way to synthesize non unitary quantum circuits into a combined unitary operation, but it has several limitations. First, it is not an exact algorithm. Doing this exactly seems hard as previously described, but we could not rule it out. Is there an exact solution? Perhaps even one using a constant number of oracle queries?

It is relatively slow, requiring a significant polynomial overhead for in $\frac{1}{\epsilon}$ and even a k^k factor. Is this fundamental? Can a better algorithm improve this to polynomial dependence on k ? One might hope to be able to do better, to get logarithmic k or polynomially small ϵ with non constant k . Or maybe even both at the same time. One obvious direction is a more careful analysis of the preprocessing step. One may be able to get away with paying a $1/\epsilon$ factor far less often, even using the same algorithm.

More importantly, I tackled this problem largely because it seemed interesting on a conceptual level, but have no application for it. Can this be used to solve any useful problem? Studying Quantum algorithms that use inherently quantum oracles has relieved relatively little study, but I suspect this algorithm may be useful in that setting.

References

- [1] Joshua Alan Cook. “Approximating Unitary Preparations of Orthogonal Black Box States”. In: *CoRR* abs/1906.10495 (2019). arXiv: 1906.10495. URL: <http://arxiv.org/abs/1906.10495>.
- [2] William Kretschmer. *The Quantum Supremacy Tsirelson Inequality*. 2020. arXiv: 2008.08721 [cs.CC].