

# SINGULARITIES OF SPACELIKE MEAN CURVATURE ONE SURFACES IN DE SITTER SPACE

ATSUFUMI HONDA AND HIMEMI SATO

ABSTRACT. In this paper, we study the singularities of spacelike constant mean curvature one (CMC 1) surfaces in the de Sitter 3-space. We prove the duality between generalized conelike singular points and 5/2-cuspidal edges on spacelike CMC 1 surfaces. To describe the duality between  $A_{k+3}$  singularities and cuspidal  $S_k$  singularities, we introduce two invariants, called the  $\alpha$ -invariant and  $\sigma$ -invariant, of spacelike CMC 1 surfaces at their singular points. Moreover, we give a classification of non-degenerate singular points on spacelike CMC 1 surfaces.

## 1. INTRODUCTION

1.1. **Background and Motivation.** We denote by  $L^3$  the Lorentz-Minkowski 3-space  $L^3 = (\mathbf{R}^3, \langle \cdot, \cdot \rangle = dx^2 + dy^2 - dz^2)$ . A spacelike surface with zero mean curvature in  $L^3$  is called a *spacelike maximal surface*. While the local properties of spacelike maximal surfaces in  $L^3$  are similar to those of minimal surfaces in the Euclidean space  $\mathbf{R}^3$ , their global behaviors are not the same. It is known that *complete spacelike maximal surfaces must be spacelike planes* (Calabi [4]). So it is natural to investigate the spacelike maximal surfaces with singular points. Umehara-Yamada [34] introduced the notion of *maxfaces* which is the class of spacelike maximal surfaces with admissible singular points in  $L^3$ , and proved several global properties, such as the Osserman-type inequality [34, Theorem 4.11].

As in the case of minimal surfaces in  $\mathbf{R}^3$ , maxfaces in  $L^3$  have the Weierstrass-type representation formula ([34], [21]):

*Let  $D$  be a simply connected domain of  $\mathbf{C}$ , and  $(g, \omega)$  be a pair of meromorphic function  $g$ , and holomorphic 1-form  $\omega$  on  $D$  such that  $(1 + |g|^2)|\omega|^2$  is a Riemannian metric on  $D$  and  $(1 - |g|^2)$  does not vanish identically. Then  $f := \operatorname{Re} F$  defines a maxface  $f : D \rightarrow L^3$ , where  $F : D \rightarrow \mathbf{C}^3$  is given by*

$$F(z) := \int_{z_0}^z (1 + g^2, \sqrt{-1}(1 - g^2), -2g)\omega \quad (z \in D),$$

*and  $z_0 \in D$  is a base point. Conversely, any maxface is locally obtained in this manner.*

The pair  $(g, \omega)$  is called the *Weierstrass data*. As in the case of minimal surfaces in  $\mathbf{R}^3$ , the maxface  $f^\sharp : D \rightarrow L^3$  defined by  $f^\sharp := \operatorname{Im} F$  is called the *conjugate* of  $f$ . The corresponding Weierstrass data is  $(g, -\sqrt{-1}\omega)$ .

We say that maxfaces have the *duality between singular points of type X and type Y*, if the following holds: A maxface  $f$  has a singular point of type X (resp. Y) at a point  $p$  if and only if the conjugate maxface  $f^\sharp$  has a singular point of type Y (resp. X) at  $p$ . The following dualities (I)–(III) are shown in [35, 10, 19, 9, 6, 27]:

---

*Date:* May 25, 2021.

*2010 Mathematics Subject Classification.* Primary 53A10; Secondary 57R45, 53A35, 53C42, 53B30.

*Key words and phrases.* surface of constant mean curvature, CMC surface, maximal surface, singular point, duality.

The first author is supported by JSPS KAKENHI Grant Number 19K14526 and 20H01801.

- (I) The cuspidal edge singularity is self-dual. The duality between swallowtail singularity and cuspidal cross cap singularity ([35, 10]).
- (II) The duality between generalized conelike singularity and fold singularity ([19, 9, 6]).
- (III) The duality between cuspidal  $S_1^-$  singularity and cuspidal butterfly singularity ([27]).

Such a duality is also known for several classes of surfaces [11, 12, 15, 16, 33, 38].

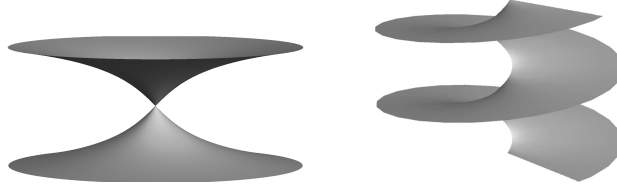

FIGURE 1. Left: maximal catenoid, which is a maxface having generalized conelike singularities. This maximal catenoid is given by the Weierstrass data  $(g, \omega) = (e^z, e^{-z}dz)$ . Right: maximal helicoid, which is the conjugate of the maximal catenoid. The maximal helicoid has fold singular points. These maxfaces verify the duality (II).

We remark that the singularities appearing in the above dualities (I)–(III) have several important properties. With respect to (I), Fujimori-Saji-Umehara-Yamada [10] proved that the singularities of maxfaces in  $L^3$  generically consist of cuspidal edges, swallowtails and cuspidal cross caps. On the duality (II), Kim-Yang [19] showed that, if a maxface admits a generalized conelike singular point, then the maxface has a point symmetry (the reflection principle, [19, Theorem 4.3]). Moreover, it is known that, if a maxface admits a fold singular point, then it can be extended to a timelike minimal surface analytically ([17, 6]). With respect to the duality (III), we remark that cuspidal edges ( $A_2$ ), swallowtails ( $A_3$ ) and cuspidal butterflies ( $A_4$ ) are in the series of the  $A_k$  singularities (cf. [31] and Section 5), and that the cuspidal cross cap is in the series of the *cuspidal  $S_k$  singularities* (cf. [29]). It is also proved that maxfaces in  $L^3$  do not admit cuspidal  $S_1^+$  singularities [27] and cuspidal  $S_k$  singularities for  $k \geq 2$  [26].

On the other hand, let  $S_1^3 = S_1^3(1)$  be the *de Sitter 3-space*, namely,  $S_1^3$  is the complete simply-connected and connected Lorentzian 3-manifold with constant sectional curvature 1. There is a Lawson-type isometric correspondence (cf. [24]) between spacelike maximal surfaces in  $L^3$  and spacelike constant mean curvature 1 (spacelike CMC 1) surfaces in  $S_1^3$ , where  $S_1^3$  is the *de Sitter 3-space* of constant sectional curvature 1. It should be remarked that, as in the relationship between spacelike maximal surfaces in  $L^3$  and minimal surfaces in  $R^3$ , spacelike CMC 1 surfaces in  $S_1^3$  correspond to CMC 1 surfaces in the hyperbolic 3-space  $H^3$  (cf. [3, 34]). As Calabi's theorem [4], it holds that *complete spacelike CMC 1 surfaces in  $S_1^3$  must be totally umbilic* (Akutagawa [1], Ramanathan [28]). So, to discuss the non-trivial global properties, we need to consider the class of spacelike CMC 1 surfaces with singular points. Fujimori [5] introduced *CMC 1 faces* in  $S_1^3$ , and gave the representation formula ([5, Theorem 1.9], [2], cf. Fact 2.1). CMC 1 faces in  $S_1^3$  can be regarded as a corresponding class of maxfaces in  $L^3$ . In [10], it is proved that the singularities of CMC 1 faces in  $S_1^3$  generically consist of cuspidal edges, swallowtails and cuspidal cross caps. Moreover, the duality of singularities for cuspidal edges, swallowtails and cuspidal cross caps on CMC 1 faces which is corresponding to (I) in [10] (see also Fact 2.4). So the following questions naturally arise: *What kind of singularities appear on CMC 1 faces in  $S_1^3$ ? Does the duality of singularities corresponding to (II) or (III) also hold in the case of CMC 1 faces in  $S_1^3$ ?*

1.2. **Results.** In this paper, we investigate the singularities of CMC 1 faces in the de Sitter 3-space  $S_1^3$ . First, we prove the criterion for 5/2-cuspidal edges on CMC 1 faces in terms of Weierstrass data (Theorem 4.3), which yields the following.

**Theorem A.** *CMC 1 faces in  $S_1^3$  have the duality between generalized conelike singularity and 5/2-cuspidal edge singularity.*

We also show that CMC 1 faces in  $S_1^3$  do not admit fold singular points (Corollary 6.2). Hence Theorem A can be regarded as the de Sitter counterpart of the duality (III).

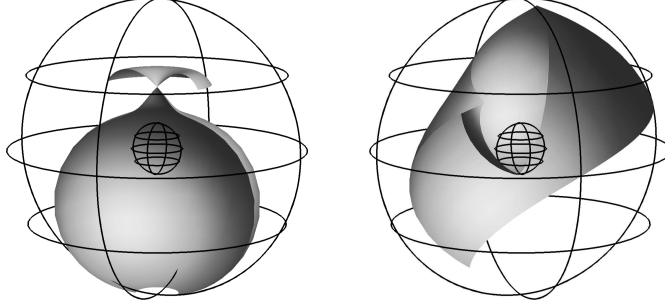

FIGURE 2. Left: a CMC 1 face  $f : C \rightarrow S_1^3$  with the Weierstrass data  $(g, \omega) = (e^z, e^{-z} dz)$ . The singular set of  $f$  consists of generalized conelike singular points. Right: the conjugate CMC 1 face  $f^\sharp$ . In Example 4.12, we see that  $f^\sharp$  has 5/2-cuspidal edge singular points. These surfaces correspond to the maximal catenoid and the maximal helicoid shown in Figure 1, respectively. To visualize the figures, we use the hollow ball model [8], cf. (2.5).

Next, we show the criteria for cuspidal  $S_k$  singularities,  $A_4$ -type and generalized  $A_k$  singularities on CMC 1 faces in terms of Weierstrass data (Theorems 5.3 and 5.7). To derive the duality between cuspidal  $S_k$  singularity and  $A_{k+3}$  singularity as in (III), we introduce two invariants of CMC 1 faces

$$\alpha = \alpha(f, p), \quad \sigma = \sigma(f, p)$$

(Definition 3.4). These  $\alpha$ - and  $\sigma$ -invariants are defined at singular points satisfying the conditions (A) and (S), respectively (cf. Definition 3.4). For example, for  $k \geq 1$ , the  $A_{k+3}$  singularities satisfies the condition (A), and the cuspidal  $S_k$  singularities satisfies the condition (S). See Theorem 3.3 for details (cf. Remark 4.11). Then we have the following.

**Theorem B.** *CMC 1 faces in  $S_1^3$  have the following dualities.*

- (1) *The duality between admissible cuspidal  $S_1$  singularity and admissible cuspidal butterfly.*
- (2) *The duality between cuspidal  $S_k$  singularity and generalized  $A_{k+3}$  singularity, where  $k$  is an integer satisfying  $k \geq 2$ .*

While the assertion (1) of Theorem B seems to correspond to the duality (III) for max-faces in  $L^3$ , but there are differences:

- The first differences is that we need to assume the *admissibility*, which is defined in terms of  $\alpha$ - and  $\sigma$ -invariants (see Definition 5.9). The reason is that, if a CMC 1 face  $f$  has a cuspidal  $S_1$  singular point  $p$ , then the  $\sigma$ -invariant  $\sigma(f, p)$  is not equal to 12 (Corollary 5.8).
- The second difference is that there are CMC 1 faces which admit cuspidal  $S_1^+$  singular points (Example 5.11, Figure 7), while maxfaces in  $L^3$  do not admit them [27].

Moreover, the assertion (2) of Theorem B have no counterparts in the case of maxfaces in  $L^3$ , since maxfaces cannot have cuspidal  $S_k$  singularities for  $k \geq 2$  [26]. See Definition 5.2 for the definition of generalized  $A_k$  singularities.

Finally, using our criteria (Theorems 4.3, 5.3 and 5.7), we obtain the classification of non-degenerate singular points on CMC 1 faces in  $S_1^3$ .

**Theorem C.** *A non-degenerate singular point on CMC 1 faces in  $S_1^3$  must be one of the followings:*

- (1) *an  $A_k$ -type singular point ( $k = 2, 3, 4$ ),*
- (2) *a generalized  $A_k$  singular point ( $k \geq 5$ ),*
- (3) *a generalized conelike singular point,*
- (4) *a cuspidal  $S_k$  singular point ( $k \geq 0$ ),*
- (5) *a singular point satisfying the condition ( $\mathbb{S}$ ) with  $\sigma = 12$ , or*
- (6) *a 5/2-cuspidal edge singular point.*

We remark that singular points of type  $A_2$  (resp.  $A_3, A_4$ ) are cuspidal edges (resp. swallowtails, cuspidal butterflies), and cuspidal  $S_0$  singular points are cuspidal cross caps. As a corollary, non-existence results for several singularities on CMC 1 faces are obtained (cf. Corollaries 6.2 and 6.3). Here, a singular point is called *non-degenerate* if the exterior derivative of the signed area density function  $\lambda$  (see (2.10)) does not vanish. While the set of non-degenerate singular points forms a regular curve in the source domain, every degenerate singular point is isolated. This is because degenerate singular points occur at the branch point of the meromorphic function  $g$  (cf. Fact 2.3). On the other hand, the images of degenerate lightlike points on zero mean curvature surfaces in  $L^3$  are lightlike line segments (so-called the *line theorem*, [20], [36], [37]).

This paper is organized as follows. First, in Section 2, we review the fundamental properties of CMC 1 faces in  $S_1^3$  and the criteria for singular points, such as cuspidal edges, swallowtails and cuspidal cross caps (Fact 2.3). Then, in Section 3, we consider the equivalence relation on Weierstrass data, which yields the  $\alpha$ - and  $\sigma$ -invariants (Definition 3.4). In Section 4, we prove Theorem A. For the proof, we use the criterion for 5/2-cuspidal edges ([13, Theorem 4.1], cf. Fact 4.4). Since the criterion is for frontals in  $R^3$ , we cannot apply it to CMC 1 faces in  $S_1^3$  directly. Hence, we use the orthogonal projection from  $S_1^3$  to the tangent spaces, see (4.7). Here we remark that a duality as in Theorem A is observed in the case of spacelike Delaunay surfaces (i.e., generalized CMC surfaces of revolution) in  $L^3$  [13, Theorem 1.2]. In Section 5, we show criteria for  $A_k$  and cuspidal  $S_k$  singularities on CMC 1 faces in terms of Weierstrass data (Theorems 5.3 and 5.7), which yield Theorem B. Finally, in Section 6, we prove Theorem C. In the appendix, we give a proof of Lemma 4.8, which is the key lemma for the proofs of our criteria.

## 2. SINGULARITIES OF CMC 1 SURFACES IN DE SITTER 3-SPACE

**2.1. Structure of de Sitter space.** We denote by  $L^4$  the Lorentz-Minkowski 4-space with the Lorentz metric

$$\langle \mathbf{x}, \mathbf{y} \rangle = -x_0y_0 + x_1y_1 + x_2y_2 + x_3y_3,$$

where  $\mathbf{x} = (x_0, x_1, x_2, x_3)^T$ ,  $\mathbf{y} = (y_0, y_1, y_2, y_3)^T$ , and  $T$  means the transpose. Then the de Sitter 3-space is given by

$$S_1^3 = S_1^3(1) = \{\mathbf{x} \in L^4; \langle \mathbf{x}, \mathbf{x} \rangle = 1\}$$

with metric induced from  $L^4$ , which is a complete simply-connected and connected Lorentzian 3-manifold with constant sectional curvature 1. We identify the set of  $2 \times 2$  Hermitian matrices  $\text{Herm}(2) = \{X^* = X\}$  ( $X^* := \bar{X}^T$ ) via

$$(2.1) \quad \Phi : \text{Herm}(2) \ni \begin{pmatrix} x_0 + x_3 & x_1 + \sqrt{-1}x_2 \\ x_1 - \sqrt{-1}x_2 & x_0 - x_3 \end{pmatrix} \longmapsto (x_0, x_1, x_2, x_3)^T \in L^4$$

with the metric

$$\langle X, Y \rangle = -\frac{1}{2} \operatorname{trace}(X \operatorname{adj}(Y)) \quad \left( \operatorname{adj} : \begin{pmatrix} a & b \\ c & d \end{pmatrix} \mapsto \begin{pmatrix} d & -b \\ -c & a \end{pmatrix} \right).$$

In particular,  $\langle X, X \rangle = -\det X$ . Under the identification (2.1), the de Sitter 3-space  $S_1^3$  is represented as

$$S_1^3 = \{X \in \operatorname{Herm}(2); \det X = -1\}.$$

Moreover, under the identification (2.1), the basis

$$(2.2) \quad e_0 = \begin{pmatrix} 1 & 0 \\ 0 & 1 \end{pmatrix}, \quad e_1 = \begin{pmatrix} 0 & 1 \\ 1 & 0 \end{pmatrix}, \quad e_2 = \begin{pmatrix} 0 & \sqrt{-1} \\ -\sqrt{-1} & 0 \end{pmatrix}, \quad e_3 = \begin{pmatrix} 1 & 0 \\ 0 & -1 \end{pmatrix}$$

of  $\operatorname{Herm}(2)$  corresponds to the canonical orthonormal basis

$$(\varepsilon_0, \varepsilon_1, \varepsilon_2, \varepsilon_3) = (\Phi e_0, \Phi e_1, \Phi e_2, \Phi e_3)$$

of  $L^4$ . The special linear group  $\operatorname{SL}(2, \mathbb{C})$  acts isometrically and transitively on  $\operatorname{Herm}(2)$  by

$$(2.3) \quad \operatorname{Herm}(2) \ni X \mapsto AXA^* \in \operatorname{Herm}(2),$$

where  $A \in \operatorname{SL}(2, \mathbb{C})$ . Since the isotropy subgroup of  $\operatorname{SL}(2, \mathbb{C})$  at  $e_3 \in S_1^3$  is  $\operatorname{SU}(1, 1)$ , we can identify

$$S_1^3 = \operatorname{SL}(2, \mathbb{C}) / \operatorname{SU}(1, 1) = \{Ae_3A^*; A \in \operatorname{SL}(2, \mathbb{C})\}.$$

Since the action (2.3) preserves the metric, orientation, and the time-orientation of  $\operatorname{Herm}(2)$ , for each  $A \in \operatorname{SL}(2, \mathbb{C})$ , there exists a unique element  $\check{A}$  of the restricted Lorentz group  $\operatorname{SO}^+(1, 3)$  such that

$$(2.4) \quad \Phi(AXA^*) = \check{A} \Phi(X) \quad (X \in \operatorname{Herm}(2))$$

holds, where  $\Phi$  is the identification (2.1). This map  $\operatorname{SL}(2, \mathbb{C}) \ni A \mapsto \check{A} \in \operatorname{SO}^+(1, 3)$  gives the universal covering of  $\operatorname{SO}^+(1, 3)$ .

To visualize the graphics of surfaces in  $S_1^3$ , we use the *hollow ball model* of  $S_1^3$  introduced in [8]. We set

$$(2.5) \quad \mathcal{H} := \{\mathbf{y} \in \mathbb{R}^3; \sqrt{2} - 1 < \|\mathbf{y}\| < \sqrt{2} + 1\} \quad \left( \|\mathbf{y}\| = \sqrt{(y_1)^2 + (y_2)^2 + (y_3)^2} \right),$$

where  $\mathbf{y} = (y_1, y_2, y_3)^T$ . We identify  $S_1^3$  and  $\mathcal{H}$  via the map:

$$S_1^3 \ni (x_0, x_1, x_2, x_3)^T \mapsto \frac{1}{x_0 + \sqrt{(x_0)^2 + (x_1)^2 + (x_2)^2 + (x_3)^2}} (x_1, x_2, x_3)^T \in \mathcal{H}.$$

The ideal boundary  $\partial\mathcal{H}$  of  $S_1^3$  consists of two components  $\partial\mathcal{H} = \partial\mathcal{H}_+ \cup \partial\mathcal{H}_-$ , where we set  $\partial\mathcal{H}_\pm := \{\mathbf{y} \in \mathbb{R}^3; \|\mathbf{y}\| = \sqrt{2} \pm 1\}$ .

**2.2. CMC 1 faces.** Let  $D$  be a Riemann surface. A holomorphic map  $F : D \rightarrow \operatorname{SL}(2, \mathbb{C})$  is called *null* if  $\det dF = 0$  holds on  $D$ . The projection (cf. (2.7)) of null holomorphic immersions gives spacelike constant mean curvature one (CMC 1, for short) surfaces with singularities, called *CMC 1 faces* in  $S_1^3$  (see [5] for details).

**Fact 2.1** ([5]). *Let  $D$  be a simply connected domain of  $\mathbb{C}$ , and  $(g, \omega)$  be a pair of meromorphic function  $g$ , and holomorphic 1-form  $\omega$  on  $D$  such that  $(1 + |g|^2)^2 |\omega|^2$  is a Riemannian metric on  $D$  and  $(1 - |g|^2)^2$  does not vanish identically. We fix a point  $p \in D$ . Take a holomorphic null immersion  $F : D \rightarrow \operatorname{SL}(2, \mathbb{C})$  satisfying*

$$(2.6) \quad F^{-1} dF = \begin{pmatrix} g & -g^2 \\ 1 & -g \end{pmatrix} \omega, \quad F(p) = e_0.$$

Then

$$(2.7) \quad f := Fe_3F^*$$

defines a CMC 1 face  $f : D \rightarrow S_1^3$ . Moreover, any CMC 1 face is locally obtained in this manner.

We call  $F$  the *holomorphic null lift* of  $f$ . We remark that  $FF^*$  gives a conformal CMC 1 immersion into the hyperbolic 3-space  $H^3$ . Moreover, conformal CMC 1 immersions are always given locally in such a manner (see [3] and [34] for details).

The pair  $(g, \omega)$  is called the *Weierstrass data* of  $f$ . It is known that  $F$  and  $(g, \omega)$  are not uniquely determined from  $f$  ([34], [5], cf. Section 3). On the other hand, the *hyperbolic Gauss map*  $G : D \rightarrow \hat{C}$  ( $\hat{C} := C \cup \{\infty\}$ ) defined by

$$G = dF_{11}/dF_{21} = dF_{12}/dF_{22}$$

is uniquely determined from  $f$ , where  $F = (F_{jl})_{j,l=1,2}$ . We denote by  $Q = \omega dg$  the Hopf differential of  $f$ . By [34, Equation (2.6)], it holds that

$$(2.8) \quad 2Q = S(g) - S(G),$$

where  $S(g)$  is the Schwarzian differential of  $g$  defined by

$$S(g) = \hat{S}(g)dz^2 \quad \left( \hat{S}(g) = \left( \frac{g_{zz}}{g_z} \right)_z - \frac{1}{2} \left( \frac{g_{zz}}{g_z} \right)^2 \right).$$

Here,  $z$  is a local complex coordinate of  $D$ , and  $g_z = dg/dz$ .

Small [32] gave the following expression:

$$(2.9) \quad F = \begin{pmatrix} G \frac{da}{dG} - a & G \frac{db}{dG} - b \\ \frac{da}{dG} & \frac{db}{dG} \end{pmatrix} \left( a = \sqrt{\frac{dG}{dg}}, \quad b = -ga \right),$$

which is called *Small's formula*. See [23] for an alternative proof.

**2.3. Generic singularities of CMC 1 faces.** Let  $D$  be a 2-manifold, and  $f : D \rightarrow M$  be a map into a 3-manifold  $M = M^3$ . A point  $p \in D$  is said to be a *singular point* if  $f$  is not an immersion at  $p$ . We denote by  $\Sigma(f) (\subset D)$  the set of singular points of  $f$ .

For  $j = 1, 2$ , let  $f_j : D_j \rightarrow M_j$  be maps having singular points  $p_j \in D_j$ . Then, the map germ  $f_1 : (D_1, p_1) \rightarrow (M_1, f(p_1))$  is  $\mathcal{A}$ -equivalent to  $f_2 : (D_2, p_2) \rightarrow (M_2, f(p_2))$  if there exist diffeomorphism germs  $\phi : (D_1, p_1) \rightarrow (D_2, p_2)$ ,  $\Phi : (M_1, f(p_1)) \rightarrow (M_2, f(p_2))$  such that  $\Phi \circ f_1 = f_2 \circ \phi$ .

A map  $f : D \rightarrow M$  is said to have a *cuspidal edge singular point* at  $p$  if the map germ  $f$  at  $p$  is  $\mathcal{A}$ -equivalent to  $f_{ce}$  at the origin, where  $f_{ce} : \mathbf{R}^2 \rightarrow \mathbf{R}^3$  is given by  $f_{ce}(u, v) = (u, v^2, v^3)$ . Similarly, if the map germ  $f$  at  $p$  is  $\mathcal{A}$ -equivalent to  $f_{sw}$  (resp.  $f_{ccr}$ ) at the origin,  $f$  is said to have a *swallowtail* (resp. *cuspidal cross cap*) singular point at  $p$ , where  $f_{sw}(u, v) = (u, -4v^3 - 2uv, 3v^4 + uv^2)$ ,  $f_{ccr}(u, v) = (u, v^2, uv^3)$ .

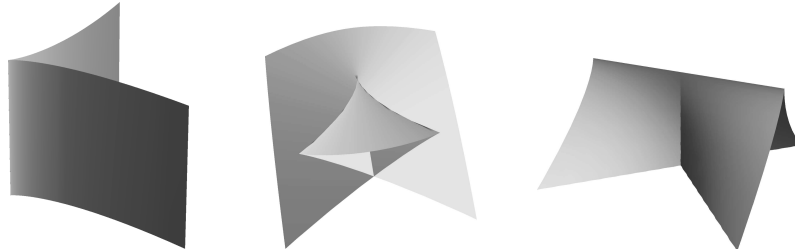

FIGURE 3. Standard cuspidal edge  $f_{ce}(u, v)$ , standard swallowtail  $f_{sw}(u, v)$ , standard cuspidal cross cap  $f_{ccr}(u, v)$ .

Such the singular points are shown to be generic singular points of CMC 1 faces in  $S^3_1$  [10]. For the proof, criteria for cuspidal edge, swallowtail, and cuspidal cross cap singularities on CMC 1 faces were shown in [10]. Here we review them briefly.



We assume that  $M$  is equipped with a Riemannian metric  $d\sigma^2$ . A map  $f : D \rightarrow M$  is said to be a *frontal* if, for each point  $p \in D$ , there exist an open neighborhood  $(D; u, v)$  of  $p$  and a unit vector field  $L$  of  $M$  along  $f$  such that

$$d\sigma^2(v, df(W)) = 0 \quad (W \in TD)$$

on  $D$ , where we set  $L = (f, v)$ . If we can choose  $L$  to be an immersion, then  $f$  is called a *wave front* (or a *front*, for short). For a front (resp. frontal)  $f$  and a diffeomorphism  $\Phi$  of  $M$ , the composition  $\Phi \circ f$  is also a front (resp. frontal), and hence the notions of frontals or fronts are independent of the choice of the Riemannian metric  $d\sigma^2$  on  $M$ . See [30] for details.

Let  $f : D \rightarrow M$  be a frontal. We denote by  $d\mu$  be the Riemannian volume form of  $(M, d\sigma^2)$ . We set a  $C^\infty$  function  $\lambda$  as

$$(2.10) \quad \lambda = d\mu(f_u, f_v, v),$$

which is called the *signed area density function*. Then  $p \in D$  is a singular point if and only if  $\lambda(p) = 0$ . If  $d\lambda(p) \neq 0$ , then  $p$  is said to be a *non-degenerate singular point*. If  $p$  is a non-degenerate singular point, the implicit function theorem yields that the singular set  $\Sigma(f)$  is a 1-dimensional submanifold of  $D$  near  $p$ . That is, there exist  $\varepsilon > 0$  and a regular curve  $\gamma : (-\varepsilon, \varepsilon) \rightarrow D$  such that the image  $\gamma((-\varepsilon, \varepsilon))$  is a subset of  $\Sigma(f)$  and  $\gamma(0) = p$ . Such the curve  $\gamma(t)$  is called a *singular curve* at  $p$ . A non-vanishing vector field  $\xi$  defined on a neighborhood of  $p$  is said to be a *singular directional vector field*, if  $\xi_{\gamma(t)}$  is parallel to the tangent vector field  $\gamma'(t)$ . On the other hand, a non-vanishing vector field  $\eta$  defined on a neighborhood of  $p$  is said to be a *null vector field*, if  $df_q(\eta) = \mathbf{0}$  for each  $q \in \Sigma(f)$ . The restriction  $\eta(t) := \eta_{\gamma(t)}$  is called a *null vector field along  $\gamma(t)$* . A non-degenerate singular point  $p \in \Sigma(f)$  is said to be *of the first kind* if  $\xi_p$  and  $\eta_p$  are linearly independent. If a front  $f : D \rightarrow M$  has a singular point of the first kind  $p \in D$ , then  $f$  has cuspidal edge at  $p$  ([22]).

**Definition 2.2.** Let  $f : D \rightarrow S_1^3$  be a CMC 1 face with Weierstrass data  $(g, \omega)$ , where  $D$  is a domain of  $\mathbf{C}$ . We set a function  $\varphi$  and a vector field  $V$  as

$$(2.11) \quad \varphi := \frac{dg}{g^2\omega}, \quad V := g \frac{d}{dg},$$

respectively. We call  $(\varphi, V)$  the *characteristic pair* associated with the Weierstrass data  $(g, \omega)$ .

The characteristic pair  $(\varphi, V)$  plays an important role in the criteria for singularities:

**Fact 2.3** ([10]). *Let  $f : D \rightarrow S_1^3$  be a CMC 1 face with Weierstrass data  $(g, \omega)$ , and let  $(\varphi, V)$  be the characteristic pair associated with  $(g, \omega)$ . Then, the singular set is given by  $\Sigma(f) = \{p \in D; |g(p)| = 1\}$ . The vector fields  $\xi, \eta$  defined by*

$$(2.12) \quad \xi := \sqrt{-1} \left( \frac{\overline{g_z}}{g} \right) \frac{\partial}{\partial z} - \sqrt{-1} \left( \frac{g_z}{g} \right) \frac{\partial}{\partial \bar{z}}, \quad \eta := \frac{\sqrt{-1}}{gh} \frac{\partial}{\partial z} - \frac{\sqrt{-1}}{\bar{g}h} \frac{\partial}{\partial \bar{z}}$$

*give a singular directional vector field and a null vector field along  $f$ , respectively. Here  $z$  is a complex coordinate of  $D$ , and  $\omega = h dz$ . Moreover,*

- (1) *a CMC 1 face  $f$  is a frontal.*
- (2) *a singular point  $p \in \Sigma(f)$  is non-degenerate if and only if  $dg(p) \neq 0$ .*
- (3)  *$f$  is a front on a neighborhood of  $p \in \Sigma(f)$  if and only if  $\operatorname{Re} \varphi(p) \neq 0$ . In particular,  $p$  is a non-degenerate singular point.*
- (4)  *$p \in \Sigma(f)$  is a singular point of the first kind if and only if  $\operatorname{Im} \varphi(p) \neq 0$ .*
- (5)  *$f$  has cuspidal edge at  $p \in \Sigma(f)$  if and only if  $\operatorname{Re} \varphi(p) \neq 0, \operatorname{Im} \varphi(p) \neq 0$ .*
- (6)  *$f$  has swallowtail at  $p \in \Sigma(f)$  if and only if  $\varphi(p) \in \mathbf{R} \setminus \{0\}, \operatorname{Re} V\varphi(p) \neq 0$ .*
- (7)  *$f$  has cuspidal cross cap at  $p \in \Sigma(f)$  if and only if  $\varphi(p) \in \sqrt{-1}\mathbf{R} \setminus \{0\}, \operatorname{Im} V\varphi(p) \neq 0$ .*

Let  $D$  be a simply connected Riemann surface and  $f : D \rightarrow S_1^3$  be a CMC 1 face with Weierstrass data  $(g, \omega)$ . Then a CMC 1 face  $f^\# : D \rightarrow S_1^3$  given by the Weierstrass data  $(g, -\sqrt{-1}\omega)$  is called the *conjugate* CMC 1 face of  $f$ .

We say that CMC 1 faces have the *duality between singular points of type X and type Y*, if the following holds: A CMC 1 face  $f$  has a singular point of type X (resp. Y) at a point  $p$  if and only if the conjugate CMC 1 face  $f^\#$  has a singular point of type Y (resp. X) at  $p$ . As in the case of maxfaces in  $L^3$  ([35, 10], cf. the duality (I) in the introduction), the following holds.

**Fact 2.4** ([10]). *The cuspidal edge singularity is self-dual on CMC 1 faces in  $S_1^3$ . Moreover, CMC 1 faces in  $S_1^3$  have the duality between swallowtail singularity and cuspidal cross cap singularity. More precisely, let  $f : D \rightarrow S_1^3$  be a CMC 1 face defined on a simply connected domain  $D$ , and  $p \in D$  be a singular point. Then  $f$  has cuspidal edge (resp. swallowtail, cuspidal cross cap) at  $p$  if and only if  $f^\#$  has cuspidal edge (resp. cuspidal cross cap, swallowtail) at  $p$ .*

### 3. INVARIANTS VIA CRITERIA

It is known that a holomorphic null lift  $F$  and Weierstrass data  $(g, \omega)$  are not uniquely determined from a CMC 1 face  $f$  ([34], [5]). In this section, by calculating quantities related to the characteristic pair  $(\varphi, V)$ , we introduce two invariants  $\alpha, \sigma$  of CMC 1 faces at their singular points (cf. Definition 3.4).

Let  $f : D \rightarrow S_1^3$  be a CMC 1 face, and let  $F : D \rightarrow \mathrm{SL}(2, \mathbb{C})$  be a holomorphic null lift of  $f$  with Weierstrass data  $(g, \omega)$ . For a constant matrix  $B \in \mathrm{SU}(1, 1)$ , the map  $\tilde{F} : D \rightarrow \mathrm{SL}(2, \mathbb{C})$  defined by  $\tilde{F} := FB$  is also a holomorphic null lift of  $f$ . The Weierstrass data  $(\tilde{g}, \tilde{\omega})$  associated with  $\tilde{F}$  is described as

$$(3.1) \quad \tilde{g} = \frac{ag + b}{\bar{b}g + \bar{a}}, \quad \tilde{\omega} = (\bar{b}g + \bar{a})^2 \omega,$$

where we set

$$(3.2) \quad B = \begin{pmatrix} \bar{a} & -b \\ -\bar{b} & a \end{pmatrix} \quad (|a|^2 - |b|^2 = 1).$$

Two Weierstrass data  $(g, \omega)$  and  $(\tilde{g}, \tilde{\omega})$  are said to be *equivalent* if they satisfy (3.1) ([34], [5]). Let  $f_1, f_2 : D \rightarrow S_1^3$  be two CMC 1 faces. We say that  $f_1$  is *congruent* to  $f_2$  if there exists a constant matrix  $A \in \mathrm{SL}(2, \mathbb{C})$  such that  $f_2 = Af_1A^*$ . If  $F$  is a holomorphic null lift of  $f_1$ , then  $AF$  is that of  $f_2$ . Since

$$(AF)^{-1}d(AF) = F^{-1}dF,$$

the Weierstrass data associated with  $F$  coincides with that of  $AF$ . Hence, the equivalence class of  $(g, \omega)$  corresponds to the congruence class of the CMC 1 face  $f$  (cf. [34]).

Let  $f : D \rightarrow S_1^3$  be a CMC 1 face with Weierstrass data  $(g, \omega)$ , and let  $(\varphi, V)$  be the characteristic pair associated with  $(g, \omega)$ . If  $(\tilde{g}, \tilde{\omega})$  is a Weierstrass data which is equivalent to  $(g, \omega)$ , then the characteristic pair  $(\tilde{\varphi}, \tilde{V})$  associated with  $(\tilde{g}, \tilde{\omega})$  is defined by

$$(3.3) \quad \tilde{\varphi} = \frac{d\tilde{g}}{\tilde{g}^2\tilde{\omega}}, \quad \tilde{V} = \tilde{g} \frac{d}{d\tilde{g}}.$$

**Lemma 3.1.** *Suppose that a Weierstrass data  $(\tilde{g}, \tilde{\omega})$  is equivalent to  $(g, \omega)$  as (3.1). Then the characteristic pair  $(\tilde{\varphi}, \tilde{V})$  associated with  $(\tilde{g}, \tilde{\omega})$  satisfies*

$$(3.4) \quad \tilde{\varphi} = \frac{1}{\Delta^2} \varphi, \quad \tilde{V} = \Delta V, \quad \text{where we set } \Delta := (ag + b) \left( \frac{\bar{a}}{g} + \bar{b} \right).$$

*Proof.* By (3.1), we have  $\tilde{g}_z = g_z / (\bar{b}g + \bar{a})^2$ , which yields (3.4).  $\square$

We have the following.



**Lemma 3.2.** Fix a non-negative integer  $m \in \mathbf{Z}$ . Let  $f : D \rightarrow S_1^3$  be a CMC 1 face with Weierstrass data  $(g, \omega)$ . We take a non-degenerate singular point  $p \in \Sigma(f)$ . Suppose that a Weierstrass data  $(\tilde{g}, \tilde{\omega})$  is equivalent to  $(g, \omega)$  as (3.1). Let  $(\varphi, V)$  and  $(\tilde{\varphi}, \tilde{V})$  be the characteristic pairs associated with  $(g, \omega)$  and  $(\tilde{g}, \tilde{\omega})$ , respectively. Then, there exist real numbers  $c_0 = 1, c_1, \dots, c_m \in \mathbf{R}$  such that

$$|a g(p) + b|^{2(m-2)} V^m \varphi(p) = \sum_{k=0}^m \sqrt{-1}^k c_k \tilde{V}^{m-k} \tilde{\varphi}(p).$$

*Proof.* By the definition of  $\varphi$  in (2.11), we have  $g_z = g^2 h \varphi$ , where  $\omega = h dz$ . For a positive integer  $\ell$ , we have

$$(3.5) \quad (V^{\ell-1} \varphi)_z = g h \varphi V^\ell \varphi,$$

since

$$V^\ell \varphi = g \frac{d}{dg} V^{\ell-1} \varphi = \frac{g}{g_z} (V^{\ell-1} \varphi)_z = \frac{1}{g h \varphi} (V^{\ell-1} \varphi)_z.$$

Similarly, by (3.4) and (3.1), we have

$$(3.6) \quad (\tilde{V}^{\ell-1} \tilde{\varphi})_z = \tilde{g} \tilde{h} \tilde{\varphi} \tilde{V}^\ell \tilde{\varphi} = \frac{g h \varphi}{\Delta} \tilde{V}^\ell \tilde{\varphi},$$

where  $\Delta$  is the function defined in Lemma 3.1. We set  $\rho, \tau$  as

$$\rho = a \bar{b} g - \frac{\bar{a} b}{g}, \quad \tau = a \bar{b} g + \frac{\bar{a} b}{g}.$$

Then, it holds that

$$(3.7) \quad \Delta_z = \tau_z = g h \varphi \rho, \quad \rho_z = g h \varphi \tau.$$

In the following, we prove, by induction, that there exist  $C_{q,r,s}^{m,k} \in \mathbf{R}$  such that

$$(3.8) \quad \Delta^{m-2} V^m \varphi = \sum_{k=0}^m P(m; k) \tilde{V}^{m-k} \tilde{\varphi},$$

$$P(m; k) = \begin{cases} 1 & (\text{if } k = 0), \\ \sum_{\substack{q+2r+s=k \\ q,r,s \geq 0}} C_{q,r,s}^{m,k} \Delta^q \rho^{2r} \tau^s & (\text{if } k \text{ is even and positive}), \\ \sum_{\substack{q+2r+s=k-1 \\ q,r,s \geq 0}} C_{q,r,s}^{m,k} \Delta^q \rho^{2r+1} \tau^s & (\text{if } k \text{ is odd}). \end{cases}$$

In the case of  $m = 0$ , Lemma 3.1 yields (3.8).

For a non-negative integer  $m$ , suppose that (3.8) holds. Taking the differentials of the both sides of (3.8), we have

$$(\Delta^{m-2})_z V^m \varphi + \Delta^{m-2} (V^m \varphi)_z = \sum_{k=0}^m \left\{ P(m; k)_z \tilde{V}^{m-k} \tilde{\varphi} + P(m; k) (\tilde{V}^{m-k} \tilde{\varphi})_z \right\}.$$

By (3.5), (3.6), (3.7), we have

$$(m-2)\rho \Delta^{m-2} V^m \varphi + \Delta^{m-1} V^{m+1} \varphi = \sum_{k=0}^m \left\{ \frac{\Delta P(m; k)_z}{g h \varphi} \tilde{V}^{m-k} \tilde{\varphi} + P(m; k) \tilde{V}^{m-k+1} \tilde{\varphi} \right\}.$$

Then (3.8) yields that

$$\Delta^{m-1} V^{m+1} \varphi = \sum_{k=0}^m \left[ \left\{ -(m-2)\rho P(m; k) + \frac{\Delta P(m; k)_z}{g h \varphi} \right\} \tilde{V}^{m-k} \tilde{\varphi} + P(m; k) \tilde{V}^{m-k+1} \tilde{\varphi} \right].$$

By  $P(m; 0) = 1$ ,

$$\begin{aligned} \Delta^{m-1} V^{m+1} \varphi &= \tilde{V}^{m+1} \tilde{\varphi} + \{P(m; 1) - (m-2)\rho\} \tilde{V}^m \tilde{\varphi} \\ &+ \sum_{k=2}^m \left\{ -(m-2)\rho P(m; k-1) + \frac{\Delta P(m; k-1)_z}{gh\varphi} + P(m; k) \right\} \tilde{V}^{m-k+1} \tilde{\varphi} \\ &+ \left\{ -(m-2)\rho P(m; m) + \frac{\Delta P(m; m)_z}{gh\varphi} \right\} \tilde{\varphi} \end{aligned}$$

holds. Hence, we have

$$(3.9) \quad \Delta^{m-1} V^{m+1} \varphi = \sum_{k=0}^{m+1} P(m+1; k) \tilde{V}^{m+1-k} \tilde{\varphi},$$

$$P(m+1; k) = \begin{cases} 1 & (\text{if } k = 0), \\ P(m; 1) - (m-2)\rho & (\text{if } k = 1), \\ -(m-2)\rho P(m; k-1) + \frac{\Delta P(m; k-1)_z}{gh\varphi} + P(m; k) & (\text{if } k = 2, \dots, m), \\ -(m-2)\rho P(m; m) + \frac{\Delta P(m; m)_z}{gh\varphi} & (\text{if } k = m+1) \end{cases}$$

• *The case of  $k = 1$ .* Since  $P(m+1; 1) = P(m; 1) - (m-2)\rho$ , we have

$$P(m+1; 1) = -\frac{1}{2}(m+1)(m-4)\rho.$$

• *The case that  $k$  is even and  $2 \leq k \leq m$ .* Since  $k-1$  is odd,  $P(m; k-1)$  is expressed as

$$P(m; k-1) = \sum_{\substack{q+2r+s=k-2 \\ q, r, s \geq 0}} C_{q, r, s}^{m, k-1} \Delta^q \rho^{2r+1} \tau^s.$$

Differentiating the both sides, we have

$$P(m; k-1)_z = gh\varphi \sum_{\substack{q+2r+s=k-2 \\ q, r, s \geq 0}} C_{q, r, s}^{m, k-1} \left\{ \begin{array}{l} q\Delta^{q-1} \rho^{2r+2} \tau^s + (2r+1)\Delta^q \rho^{2r} \tau^{s+1} \\ + s\Delta^q \rho^{2r+2} \tau^{s-1} \end{array} \right\}.$$

Hence, we obtain

$$\begin{aligned} P(m+1; k) &= \sum_{\substack{q+2r+s=k \\ q, r, s \geq 0}} C_{q, r, s}^{m, k} \Delta^q \rho^{2r} \tau^s \\ &+ \sum_{\substack{q+2r+s=k-2 \\ q, r, s \geq 0}} C_{q, r, s}^{m, k-1} \left\{ \begin{array}{l} (q-m+2)\Delta^q \rho^{2r+2} \tau^s \\ + (2r+1)\Delta^{q+1} \rho^{2r} \tau^{s+1} + s\Delta^{q+1} \rho^{2r+2} \tau^{s-1} \end{array} \right\}. \end{aligned}$$

• *The case that  $k$  is even and  $k = m+1$ .*

$$P(m+1; m+1) = \sum_{\substack{q+2r+s=m-1 \\ q, r, s \geq 0}} C_{q, r, s}^{m, m} \left\{ \begin{array}{l} (q-m+2)\Delta^q \rho^{2r+2} \tau^s \\ + (2r+1)\Delta^{q+1} \rho^{2r} \tau^{s+1} + s\Delta^{q+1} \rho^{2r+2} \tau^{s-1} \end{array} \right\}.$$

• *The case that  $k$  is odd and  $2 \leq k \leq m$ .* Since  $k - 1$  is even,  $P(m; k - 1)$  is expressed as

$$P(m; k - 1) = \sum_{\substack{q+2r+s=k-1 \\ q,r,s \geq 0}} C_{q,r,s}^{m,k-1} \Delta^q \rho^{2r} \tau^s.$$

Differentiating the both sides, we have

$$P(m; k - 1)_z = gh\varphi \sum_{\substack{q+2r+s=k-1 \\ q,r,s \geq 0}} C_{q,r,s}^{m,k-1} \begin{pmatrix} q\Delta^{q-1} \rho^{2r+1} \tau^s + 2r\Delta^q \rho^{2r-1} \tau^{s+1} \\ + s\Delta^q \rho^{2r+1} \tau^{s-1} \end{pmatrix}.$$

Hence, we obtain

$$P(m + 1; k) = \sum_{\substack{q+2r+s=k-1 \\ q,r,s \geq 0}} \left[ \begin{array}{l} \{C_{q,r,s}^{m,k-1}(q - m + 2) + C_{q,r,s}^{m,k}\} \Delta^q \rho^{2r+1} \tau^s \\ + 2r\Delta^{q+1} \rho^{2r-1} \tau^{s+1} + s\Delta^{q+1} \rho^{2r+1} \tau^{s-1} \end{array} \right].$$

• *The case that  $k$  is odd and  $k = m + 1$ .*

$$P(m + 1; m + 1) = \sum_{\substack{q+2r+s=m \\ q,r,s \geq 0}} C_{q,r,s}^{m,m} \begin{pmatrix} (q - m + 2)\Delta^q \rho^{2r} \tau^s \\ + 2r\Delta^{q+1} \rho^{2r-2} \tau^{s+1} + s\Delta^{q+1} \rho^{2r} \tau^{s-1} \end{pmatrix}.$$

Therefore, there exist real numbers  $C_{q,r,s}^{m+1,k} \in \mathbf{R}$  such that

$$\Delta^{m-1} V^{m+1} \varphi = \sum_{k=0}^{m+1} P(m + 1; k) \tilde{V}^{m+1-k} \tilde{\varphi},$$

$$P(m + 1; k) = \begin{cases} 1 & (\text{if } k = 0), \\ \sum_{\substack{q+2r+s=k \\ q,r,s \geq 0}} C_{q,r,s}^{m+1,k} \Delta^q \rho^{2r} \tau^s & (\text{if } k \text{ is even and positive}), \\ \sum_{\substack{q+2r+s=k-1 \\ q,r,s \geq 0}} C_{q,r,s}^{m+1,k} \Delta^q \rho^{2r+1} \tau^s & (\text{if } k \text{ is odd}) \end{cases},$$

and hence (3.8) holds.

At a singular point  $p \in \Sigma(f)$ , we have

$$\Delta(p) = |a g(p) + b|^2, \quad \rho(p) = 2\sqrt{-1} \operatorname{Im}(a\bar{b} g(p)), \quad \tau(p) = 2 \operatorname{Re}(a\bar{b} g(p)),$$

and hence, it holds that  $P(m; 0)(p) = 1$ ,  $P(m; k)(p) \in \mathbf{R}$  (if  $k$  is even and positive), and  $P(m; k)(p) \in \sqrt{-1}\mathbf{R}$  (if  $k$  is odd). Evaluating (3.8) at  $p$ , we have the desired result.  $\square$

**Theorem 3.3.** *Fix a positive integer  $m \in \mathbf{Z}$ . Let  $f : D \rightarrow S_1^3$  be a CMC 1 face with Weierstrass data  $(g, \omega)$ . We take a non-degenerate singular point  $p \in \Sigma(f)$ , and take another Weierstrass data  $(\tilde{g}, \tilde{\omega})$  which is equivalent to  $(g, \omega)$  as (3.1). Let  $(\varphi, V)$  and  $(\tilde{\varphi}, \tilde{V})$  be the characteristic pairs associated with  $(g, \omega)$  and  $(\tilde{g}, \tilde{\omega})$ , respectively.*

(1) *If  $\operatorname{Re}(\sqrt{-1}^k V^k \varphi)(p) = 0$  ( $k = 0, \dots, m - 1$ ), then*

$$|a g(p) + b|^{2(m-2)} \operatorname{Re}(\sqrt{-1}^m V^m \varphi)(p) = \operatorname{Re}(\sqrt{-1}^m \tilde{V}^m \tilde{\varphi})(p)$$

*holds. In particular,*

$$\begin{cases} \operatorname{Re}(\sqrt{-1}^k V^k \varphi)(p) = 0 & (k = 0, \dots, m - 1), \\ \operatorname{Re}(\sqrt{-1}^m V^m \varphi)(p) = \operatorname{Re}(\sqrt{-1}^m \tilde{V}^m \tilde{\varphi})(p) \end{cases}$$

*holds if and only if  $m = 2$ .*

(2) If  $\text{Im}(\sqrt{-1}^k V^k \varphi)(p) = 0$  ( $k = 0, \dots, m-1$ ), then

$$|a g(p) + b|^{2(m-2)} \text{Im}(\sqrt{-1}^m V^m \varphi)(p) = \text{Im}(\sqrt{-1}^m \tilde{V}^m \tilde{\varphi})(p)$$

holds. In particular,

$$\begin{cases} \text{Im}(\sqrt{-1}^k V^k \varphi)(p) = 0 & (k = 0, \dots, m-1), \\ \text{Im}(\sqrt{-1}^m V^m \varphi)(p) = \text{Im}(\sqrt{-1}^m \tilde{V}^m \tilde{\varphi})(p) \end{cases}$$

holds if and only if  $m = 2$ .

*Proof.* We set  $i = \sqrt{-1}$ . Multiplying the both sides of the identity in Lemma 3.2 by  $i^m$ , we have  $|a g(p) + b|^{2(m-2)} i^m V^m \varphi(p) = i^m \tilde{V}^m \tilde{\varphi}(p) + \sum_{j=0}^{m-1} c_{m-j} i^j \tilde{V}^j \tilde{\varphi}(p)$ . Hence,

$$|a g(p) + b|^{2(m-2)} \text{Re}(i^m V^m \varphi)(p) = \text{Re}(i^m \tilde{V}^m \tilde{\varphi})(p) + \sum_{j=0}^{m-1} c_{m-j} \text{Re}(i^j \tilde{V}^j \tilde{\varphi})(p),$$

$$|a g(p) + b|^{2(m-2)} \text{Im}(i^m V^m \varphi)(p) = \text{Im}(i^m \tilde{V}^m \tilde{\varphi})(p) + \sum_{j=0}^{m-1} c_{m-j} \text{Im}(i^j \tilde{V}^j \tilde{\varphi})(p)$$

hold, which yield the desired results.  $\square$

By Theorem 3.3, under the condition

$$(\mathbb{A}) \quad \text{Im}(\varphi(p)) = \text{Re}(V\varphi(p)) = 0,$$

$\text{Im}(V^2\varphi(p))$  does not depend on the choice of the Weierstrass data. Similarly, under the condition

$$(\mathbb{S}) \quad \text{Re}(\varphi(p)) = \text{Im}(V\varphi(p)) = 0,$$

$\text{Re}(V^2\varphi(p))$  does not depend on the choice of the Weierstrass data.

*Definition 3.4.* Let  $f : D \rightarrow S_1^3$  be a CMC 1 face,  $p \in \Sigma(f)$  be a non-degenerate singular point, and  $(\varphi, V)$  be the characteristic pair associated with a Weierstrass data  $(g, \omega)$ . If  $p$  satisfies the condition  $(\mathbb{A})$ , then

$$\alpha(f, p) := \text{Im}(V^2\varphi(p))$$

does not depend on the choice of the Weierstrass data  $(g, \omega)$ . The quantity  $\alpha(f, p)$  is called the  $\alpha$ -invariant of  $f$  at  $p \in \Sigma(f)$ . Similarly, if  $p$  satisfies the condition  $(\mathbb{S})$ , then

$$\sigma(f, p) := \text{Re}(V^2\varphi(p))$$

does not depend on the choice of the Weierstrass data  $(g, \omega)$ . The quantity  $\sigma(f, p)$  is called the  $\sigma$ -invariant of  $f$  at  $p \in \Sigma(f)$ .

Let  $k \geq 1$ . Since an  $A_{k+3}$ -type singular point satisfies the condition  $(\mathbb{A})$  by Theorem 5.3, the  $\alpha$ -invariant is defined for  $A_{k+3}$  singularities on CMC 1 faces. Similarly, a cuspidal  $S_k$  singular point satisfies the condition  $(\mathbb{S})$  by Theorem 5.7, the  $\sigma$ -invariant is defined for  $cS_k$  singularities on CMC 1 faces.

**3.1. Higher order derivatives.** For latter discussion, we will prove the following.

**Proposition 3.5.** *Let  $k$  be a positive integer,  $(\varphi, V)$  be the characteristic pair associated with a Weierstrass data  $(g, \omega)$ , and  $\xi$  be the singular directional vector field given by (2.12). Then, there exist real valued functions  $\tau_1^k, \dots, \tau_{k-1}^k, \rho_1^k, \dots, \rho_{k-1}^k$  such that*

$$(3.10) \quad \xi^k(\text{Re } \varphi) = \sum_{\ell=1}^k \tau_\ell^k \text{Re}(\sqrt{-1}^\ell V^\ell \varphi),$$

$$(3.11) \quad \xi^k(\text{Im } \varphi) = \sum_{\ell=1}^k \rho_\ell^k \text{Im}(\sqrt{-1}^\ell V^\ell \varphi),$$

and  $\tau_k^k = \rho_k^k = |gh\varphi|^{2k}$  hold, where  $\omega = h dz$ .

For the proof of Proposition 3.5, we prepare two lemmas (Lemmas 3.6 and 3.7).

**Lemma 3.6.** *Under the setting in Proposition 3.5, it holds that*

$$(3.12) \quad \xi \{ \operatorname{Re}(V^k \varphi) \} = -|gh\varphi|^2 \operatorname{Im}(V^{k+1} \varphi),$$

$$(3.13) \quad \xi \{ \operatorname{Im}(V^k \varphi) \} = |gh\varphi|^2 \operatorname{Re}(V^{k+1} \varphi).$$

*Proof.* We set  $i = \sqrt{-1}$ . Since  $\xi = i(\overline{gh\varphi})\partial/\partial z - i(gh\varphi)\partial/\partial \bar{z}$ , we have

$$\begin{aligned} \xi \{ \operatorname{Im}(V^k \varphi) \} &= i(\overline{gh\varphi}) \{ \operatorname{Im}(V^k \varphi) \}_z - i(gh\varphi) \{ \operatorname{Im}(V^k \varphi) \}_{\bar{z}} \\ &= \frac{1}{2} \{ (\overline{gh\varphi})(V^k \varphi)_z + gh\varphi(\overline{V^k \varphi})_{\bar{z}} \} = |gh\varphi|^2 \frac{V^{k+1} \varphi + \overline{V^{k+1} \varphi}}{2}, \end{aligned}$$

which yields (3.12). By a similar calculation, we have (3.13).  $\square$

**Lemma 3.7.** *Under the setting in Proposition 3.5, it holds that*

$$(3.14) \quad \xi \{ \operatorname{Re}(i^k V^k \varphi) \} = |gh\varphi|^2 \operatorname{Im}(i^{k+1} V^{k+1} \varphi),$$

$$(3.15) \quad \xi \{ \operatorname{Im}(i^k V^k \varphi) \} = |gh\varphi|^2 \operatorname{Re}(i^{k+1} V^{k+1} \varphi).$$

*Proof.* We set  $i = \sqrt{-1}$ . In the case of  $k \equiv 0 \pmod{4}$ , we have  $i^k = 1$ . By Lemma 3.6,

$$\begin{aligned} \xi \{ \operatorname{Re}(i^k V^k \varphi) \} &= \xi \{ \operatorname{Re}(V^k \varphi) \} = -|gh\varphi|^2 \operatorname{Im}(V^{k+1} \varphi) \\ &= |gh\varphi|^2 \operatorname{Re}(iV^{k+1} \varphi) = |gh\varphi|^2 \operatorname{Im}(i^{k+1} V^{k+1} \varphi) \end{aligned}$$

holds, and hence we have (3.14). In the cases of  $k \equiv 1, 2, 3 \pmod{4}$ , we can prove (3.14) in a similar way. An analogous calculation shows (3.15).  $\square$

*Proof of Proposition 3.5.* We set  $i = \sqrt{-1}$ . We prove (3.10) by induction. First, in the case of  $k = 1$ , substituting  $k = 0$  in Lemma 3.6, we have

$$\xi(\operatorname{Re} \varphi) = -|gh\varphi|^2 \operatorname{Im}(V\varphi) = |gh\varphi|^2 \operatorname{Re}(iV\varphi).$$

Next, for a positive integer  $k$ , we suppose that (3.10) holds. Since

$$\begin{aligned} \xi^{k+1}(\operatorname{Re} \varphi) &= \sum_{\ell=1}^k \xi(\tau_\ell^k) \operatorname{Re}(i^\ell V^\ell \varphi) + \sum_{\ell=1}^k \tau_\ell^k \xi \{ \operatorname{Re}(i^\ell V^\ell \varphi) \} \\ &= \sum_{\ell=1}^k \xi(\tau_\ell^k) \operatorname{Re}(i^\ell V^\ell \varphi) + \sum_{\ell=1}^k \tau_\ell^k |gh\varphi|^2 \operatorname{Re}(i^{\ell+1} V^{\ell+1} \varphi) \\ &= \xi(\tau_1^k) \operatorname{Re}(iV\varphi) + \sum_{\ell=2}^k \{ \xi(\tau_\ell^k) + \tau_{\ell-1}^k |gh\varphi|^2 \} \operatorname{Re}(i^\ell V^\ell \varphi) \\ &\quad + |gh\varphi|^{2k+2} \operatorname{Re}(i^{k+1} V^{k+1} \varphi), \end{aligned}$$

we obtain  $\xi^{k+1}(\operatorname{Re} \varphi) = \sum_{\ell=1}^{k+1} \tau_\ell^{k+1} \operatorname{Re}(i^\ell V^\ell \varphi)$ , where we set  $\tau_\ell^{k+1}$  ( $\ell = 1, \dots, k+1$ ) as

$$\tau_\ell^{k+1} = \begin{cases} \xi(\tau_1^k) & (\text{if } \ell = 1), \\ \xi(\tau_\ell^k) + \tau_{\ell-1}^k |gh\varphi|^2 & (\text{if } \ell = 2, \dots, k), \\ |gh\varphi|^{2(k+1)} & (\text{if } \ell = k+1). \end{cases}$$

We can prove (3.11) in a similar way  $\square$

#### 4. DUALITY BETWEEN CONELIKE SINGULARITIES AND 5/2-CUSPIDAL EDGES

In this section, we derive a criterion for 5/2-cuspidal edges on CMC 1 faces in  $S_1^3$  (Theorem 4.3), which yields the duality between generalized conelike singularities and 5/2-cuspidal edges (Theorem A).

**4.1. Generalized conelike singularities.** We set a smooth map  $f_{\text{cone}} : \mathbf{R}^2 \rightarrow \mathbf{R}^3$  as  $f_{\text{cone}}(u, v) := v(\cos u, \sin u, 1)$ . Let  $f : D \rightarrow M^3$  be a smooth map into a 3-manifold  $M^3$ . If the map germ  $f$  at a point  $p \in D$  is  $\mathcal{A}$ -equivalent to  $f_{\text{cone}}$  at the origin, then  $f$  is said to have a *conelike singular point* at  $p \in D$ . In such a case, the following (c<sub>1</sub>)–(c<sub>3</sub>) hold.

- (c<sub>1</sub>)  $f$  is a wave front on a neighborhood of  $p$ .
- (c<sub>2</sub>)  $p \in \Sigma(f)$  is a non-degenerate singular point.
- (c<sub>3</sub>) Let  $\gamma(t)$  ( $|t| < \varepsilon$ ) be a singular curve passing through  $p = \gamma(0)$  where  $\varepsilon > 0$ , and  $\eta(t)$  be a null vector field along  $\gamma(t)$ . Then, there exists  $\delta > 0$  such that  $\det(\gamma'(t), \eta(t)) = 0$  holds for  $t \in (-\delta, \delta)$ .

The condition (c<sub>3</sub>) implies that the image of the singular curve consists of a single point. By these conditions, we give the following definition.

*Definition 4.1.* Let  $f : D \rightarrow M^3$  be a frontal and  $p \in \Sigma(f)$  be a singular point. If the conditions (c<sub>1</sub>), (c<sub>2</sub>) and (c<sub>3</sub>) hold, then  $f$  is said to have a *generalized conelike singular point* at  $p \in \Sigma(f)$ .

**Proposition 4.2** (cf. [9, Lemma 2.3]). *Let  $f : D \rightarrow S_1^3$  be a CMC 1 face with Weierstrass data  $(g, \omega)$ , and  $p \in D$  be a singular point. We set  $\varphi = dg/(g^2\omega)$ . Then,  $f$  has a generalized conelike singular point at  $p$  if and only if  $\text{Re } \varphi(p) \neq 0$  and  $\text{Im } \varphi = 0$  holds along a singular curve passing through  $p$ .*

*Proof.* By Fact 2.3, the condition (c<sub>1</sub>) is equivalent to  $\text{Re } \varphi(p) \neq 0$ . Then the condition (c<sub>2</sub>) is automatically satisfied. Let  $\xi, \eta$  be the vector fields defined by (2.12). Then, we can choose a singular curve  $\gamma(t)$  passing through  $p = \gamma(0)$  so that  $\gamma'(t) = \xi_{\gamma(t)}$  holds along  $\gamma(t)$ . Then, we have

$$(4.1) \quad \det(\gamma'(t), \eta(t)) = \text{Im } \varphi$$

along  $\gamma(t)$  (cf. [10, Theorem 2.4]). Hence the condition (c<sub>3</sub>) holds if and only if  $\text{Im } \varphi = 0$  along  $\gamma(t)$ .  $\square$

**4.2. 5/2-cuspidal edges.** Let  $f_{\text{rce}} : \mathbf{R}^2 \rightarrow \mathbf{R}^3$  be a map defined by  $f_{\text{rce}}(u, v) := (u, v^2, v^5)$ , which we call the *standard 5/2-cuspidal edge*. Let  $f : D \rightarrow S_1^3$  be a smooth map. We say that  $f$  has *5/2-cuspidal edge* (or *rhamphoid cuspidal edge*) at  $p \in D$ , if the map germ  $f$  at  $p$  is  $\mathcal{A}$ -equivalent to  $f_{\text{rce}}$  at the origin.

We prove the following:

**Theorem 4.3.** *Let  $f : D \rightarrow S_1^3$  be a CMC 1 face with Weierstrass data  $(g, \omega)$ , and  $p \in D$  be a singular point. We set  $\varphi = dg/(g^2\omega)$ . Then,  $f$  has 5/2-cuspidal edge at  $p$  if and only if  $\text{Im } \varphi(p) \neq 0$  and  $\text{Re } \varphi = 0$  holds along a singular curve passing through  $p$ .*

For the proof of Theorem 4.3, we review the criterion for 5/2-cuspidal edge.

**Fact 4.4** (Criterion for 5/2-cuspidal edge [13, Theorem 4.1]). *Let  $f : D \rightarrow \mathbf{R}^3$  be a frontal, and  $p \in D$  be a non-degenerate singular point. We suppose that  $p$  is of the first kind, and*

$$(4.2) \quad f \text{ is not a front on a neighborhood of } p.$$

*Let  $\xi$  be a singular directional vector field on  $D$ , and  $\eta$  be a null vector field which satisfies*

$$(4.3) \quad \langle \xi f(p), \eta^2 f(p) \rangle_E = \langle \xi f(p), \eta^3 f(p) \rangle_E = 0,$$

*where  $\langle \cdot, \cdot \rangle_E$  is the canonical Euclidean inner product of  $\mathbf{R}^3$ . Then,  $f$  has 5/2-cuspidal edge at  $p$  if and only if*

$$\det(\xi f, \eta^2 f, 3\eta^5 f - 10c \eta^4 f)(p) \neq 0,$$



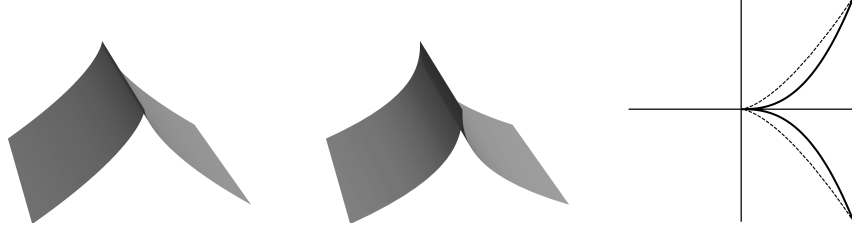

FIGURE 4. Left: the standard cuspidal edge  $f_{ce}(u, v) = (u, v^2, v^3)$ . Center: the standard 5/2-cuspidal edge  $f_{rce}(u, v) = (u, v^2, v^5)$ . Right: the images of the planar cusp  $t \mapsto (t^2, t^3)$  (the dashed curve) and the planar 5/2-cusp  $t \mapsto (t^2, t^5)$  (the bold curve). The standard cuspidal edge and standard 5/2-cuspidal edge are obtained by parallel translations of the planar cusp and the planar 5/2-cusp, respectively.

where we set  $\eta^j f = \eta(\eta^{j-1} f)$  for  $j > 1$ , and  $c \in \mathbf{R}$  is a constant such that  $\eta^3 f(p) = c \eta^2 f(p)$ .

For details, see [13, Theorem 4.1]. Since the criterion (Fact 4.4) uses the Euclidean inner product of  $\mathbf{R}^3$ , we cannot apply it to our setting directly. So, we will use the orthogonal projection, cf. (4.7).

On the other hand, since the null vector field  $\eta$  defined in (2.12) does not satisfy (4.3), we have to use another null vector field  $\zeta$  satisfying (4.3). So we set

$$(4.4) \quad \zeta = \left( \frac{\sqrt{-1}}{gh} + \kappa(1 - |g|^2)^2 \right) \frac{\partial}{\partial z} + \left( -\frac{\sqrt{-1}}{\bar{g}\bar{h}} + \bar{\kappa}(1 - |g|^2)^2 \right) \frac{\partial}{\partial \bar{z}},$$

where we set  $\kappa := -\sqrt{-1} g(p)/(2g_z(p))$ .

For a positive integer  $j$ , we set  $T_j$  so that

$$\zeta^j f = FT_j F^*.$$

In the following Lemmas 4.5, ..., 4.9, we set  $i = \sqrt{-1}$ .

**Lemma 4.5.** *We set*

$$\lambda := 1 - |g|^2, \quad \Psi := i \begin{pmatrix} 1 & -g \\ \frac{1}{g} & -1 \end{pmatrix}, \quad \Omega := \kappa h \begin{pmatrix} g & -g^2 \\ 1 & -g \end{pmatrix}.$$

Then, for  $j > 1$ , it holds that

$$T_j = U_j + (U_j)^* \left( U_j := \left( \frac{i}{gh} + \kappa \lambda^2 \right) (T_{j-1})_z + (\Psi + \lambda^2 \Omega) T_{j-1} \right).$$

*Proof.* By a direct calculation, we have

$$(4.5) \quad \zeta F = h \left( \frac{i}{gh} + \kappa \lambda^2 \right) F \begin{pmatrix} g & -g^2 \\ 1 & -g \end{pmatrix} = F (\Psi + \lambda^2 \Omega)$$

and  $\zeta F^* = (\Psi^* + \lambda^2 \Omega^*) F^*$ . Since

$$\zeta^j f = \zeta(\zeta^{j-1} f) = (\zeta F) T_{j-1} F^* + F(\zeta T_{j-1}) F^* + FT_{j-1}(\zeta F^*)$$

and  $T_j = F^{-1} \zeta^j f (F^*)^{-1}$ , we can check that  $T_j = U_j + (U_j)^*$ . □

**Lemma 4.6.** *It holds that  $T_1 = \lambda T_{1,1} + \lambda^2 T_{1,2}$ , where*

$$T_{1,1} := i \begin{pmatrix} 0 & -\frac{1}{g} \\ \frac{1}{g} & 0 \end{pmatrix}, \quad T_{1,2} := \kappa h \begin{pmatrix} g & g^2 \\ 1 & g \end{pmatrix} + \bar{\kappa} \bar{h} \begin{pmatrix} \bar{g} & 1 \\ \bar{g}^2 & \bar{g} \end{pmatrix}.$$

Moreover,

$$T_2 = \sum_{j=0}^5 \lambda^j T_{2,j} \quad (T_{2,j} := U_{2,j} + (U_{2,j})^*)$$

holds, where we set  $U_{2,0} := \varphi \begin{pmatrix} 0 & -g \\ \bar{g} & 0 \end{pmatrix}$ ,

$$\begin{aligned} U_{2,1} &:= \begin{pmatrix} 1 & \frac{1}{g} \\ \frac{1+\varphi}{g} & \frac{1}{\bar{g}g} \end{pmatrix} - 2ig\bar{g}\varphi \left\{ \kappa h \begin{pmatrix} g & g^2 \\ 1 & g \end{pmatrix} + \bar{\kappa}\bar{h} \begin{pmatrix} \bar{g} & 1 \\ \bar{g}^2 & \bar{g} \end{pmatrix} \right\} \\ U_{2,2} &:= i\kappa \left\{ gh\varphi \begin{pmatrix} 1 & 3g \\ -\bar{g} & 1 \end{pmatrix} + \frac{h_z}{h} \begin{pmatrix} 1 & g \\ \frac{1}{g} & 1 \end{pmatrix} \right\}, \\ U_{2,3} &:= i\bar{\kappa}\bar{h} \begin{pmatrix} \frac{\bar{g}}{g} & 1 \\ \frac{1}{g} & \frac{1}{g} \end{pmatrix} - \kappa h \left[ 2g^2\bar{g}\varphi \left\{ \kappa h \begin{pmatrix} g & g^2 \\ 1 & g \end{pmatrix} + \bar{\kappa}\bar{h} \begin{pmatrix} \bar{g} & 1 \\ \bar{g}^2 & \bar{g} \end{pmatrix} \right\} + i \begin{pmatrix} g & \\ 1 + \varphi & \frac{1}{g} \end{pmatrix} \right] \\ U_{2,4} &:= \kappa^2 \left\{ g^2 h^2 \varphi \begin{pmatrix} 1 & 2g \\ 0 & 1 \end{pmatrix} + h_z \begin{pmatrix} g & g^2 \\ 1 & g \end{pmatrix} \right\}, \quad U_{2,5} := \kappa\bar{\kappa}|h|^2 \begin{pmatrix} g\bar{g} & g \\ \bar{g} & 1 \end{pmatrix}. \end{aligned}$$

*Proof.* Substituting (4.5) into  $\zeta f = (\zeta F)e_3 F^* + Fe_3(\zeta F^*)$ , we have

$$\zeta f = F \left[ i\lambda \begin{pmatrix} 0 & -\frac{1}{g} \\ \frac{1}{g} & 0 \end{pmatrix} + \lambda^2 \left\{ \kappa h \begin{pmatrix} g & g^2 \\ 1 & g \end{pmatrix} + \bar{\kappa}\bar{h} \begin{pmatrix} \bar{g} & 1 \\ \bar{g}^2 & \bar{g} \end{pmatrix} \right\} \right] F^*.$$

With respect to  $T_2$ , substituting  $T_1 = \lambda T_{1,1} + \lambda^2 T_{1,2}$  into  $U_2 = (\Psi + \lambda^2 \Omega) T_1 + (\frac{i}{gh} + \kappa \lambda^2)(T_1)_z$ , we have  $U_2 = \sum_{j=0}^4 \lambda^j U_{2,j}$ , where we set  $U_2^0 = \frac{i}{gh} \lambda_z T_{1,1}$ ,

$$\begin{aligned} U_2^1 &= \frac{i}{gh} (2\lambda_z T_{1,2} + (T_{1,1})_z) + \Psi T_{1,1}, & U_2^2 &= \frac{i}{gh} (T_{1,2})_z + \kappa \lambda_z T_{1,1} + \Psi T_{1,2} \\ U_2^3 &= \kappa (2\lambda_z T_{1,2} + (T_{1,1})_z) + \Omega T_{1,1}, & U_2^4 &= \kappa (T_{1,2})_z + \Omega T_{1,2}. \end{aligned}$$

By a direct calculation, we have  $U_2^0 = U_{2,0}$ ,  $U_2^1 = U_{2,1}$ ,

$$U_2^2 = U_{2,2} + \lambda U_{2,2*}, \quad U_2^3 = U_{2,3} - U_{2,2*}, \quad U_2^4 = U_{2,4} + \lambda U_{2,5},$$

where we set  $U_{2,2*} := i\bar{\kappa}\bar{h} \begin{pmatrix} \bar{g} & 1 \\ \frac{1}{g} & \frac{1}{g} \end{pmatrix}$ . Then we can check that  $U_2 = \sum_{j=0}^5 \lambda^j U_{2,j}$  holds.

Together with  $T_2 = U_2 + (U_2)^*$  (Lemma 4.5), we obtain the desired result.  $\square$

**Lemma 4.7.** *Suppose that  $p \in \Sigma(f)$  is a non-degenerate singular point, and that  $f$  is not a front at  $p$ . Then,  $T_2(p)$  and  $T_3(p)$  are written as*

$$T_2(p) = -2i \operatorname{Im} \varphi \begin{pmatrix} 0 & g \\ -\bar{g} & 0 \end{pmatrix}, \quad T_3(p) = 2i \operatorname{Im} \varphi \operatorname{Im}(V\varphi) \begin{pmatrix} 0 & g \\ -\bar{g} & 0 \end{pmatrix},$$

where the right hand side is evaluated at  $p$ .

*Proof.* Since  $T_2(p) = T_{2,0}(p) = U_{2,0}(p) + (U_{2,0}(p))^*$ , we obtain  $T_2(p)$  by Lemma 4.6. By Lemma 4.5, we have  $T_3(p) = U_3(p) + U_3(p)^*$ , where  $U_3(p) = \frac{i}{gh}(p)(T_2)_z(p) + \Psi(p)T_2(p)$ . By Lemma 4.6,

$$\begin{aligned} (4.6) \quad U_3(p) &= \frac{i}{gh} (T_{2,0})_z + \frac{i}{gh} \lambda_z T_{2,1} + \Psi T_{2,0} \\ &= 2i(\operatorname{Im} \varphi)^2 \begin{pmatrix} 0 & 0 \\ \bar{g} & 0 \end{pmatrix} + (i(\operatorname{Im} \varphi)^2 + (\operatorname{Im} \varphi)V\varphi) \begin{pmatrix} 0 & g \\ -\bar{g} & 0 \end{pmatrix}. \end{aligned}$$

Here, the right hand sides are evaluated at  $p$ . Substituting (4.6) into  $T_3(p) = U_3(p) + U_3(p)^*$ , we obtain the desired result.  $\square$

We prove the following (Lemma 4.8) in the appendix.

**Lemma 4.8.** *Let  $f : D \rightarrow S_1^3$  be a CMC 1 face with Weierstrass data  $(g, \omega)$ , and  $(\varphi, V)$  be the characteristic pair. Suppose that  $p \in D$  is a non-degenerate singular point satisfying  $\operatorname{Re}(\varphi(p)) = \operatorname{Im}(V\varphi(p)) = 0$ . Then, there exist  $a_1, a_2, a_3 \in \mathbf{R}$  such that*

$$\zeta^5 f(p) = a_1 f + a_2 \xi f + a_3 \zeta^2 f + 4(12 - \operatorname{Re} V^2 \varphi)(\operatorname{Im} \varphi)^3 F \begin{pmatrix} 1 & -g \\ -\bar{g} & 1 \end{pmatrix} F^*,$$

where the right hand side is evaluated at  $p$ .

On the other hand, by a direct calculation, we have the following.

**Lemma 4.9.** *Let  $\xi$  be the singular directional vector field defined by (2.12), and  $p$  be a non-degenerate singular point. Then*

$$\xi f(p) = 2|h|^2 \operatorname{Im}(\varphi) F \begin{pmatrix} 1 & g \\ \bar{g} & 1 \end{pmatrix} F^*,$$

where the right hand side is evaluated at  $p$ .

*Proof of Theorem 4.3.* We set  $i = \sqrt{-1}$ . Without loss of generality, we may assume that the holomorphic null lift  $F$  satisfies  $F(p) = e_0$  by an isometry (2.3), where  $e_0$  is the identity matrix (2.2). We set

$$(4.7) \quad \operatorname{pr} : \operatorname{Herm}(2) \ni \begin{pmatrix} x_0 + x_3 & x_1 + ix_2 \\ x_1 - ix_2 & x_0 - x_3 \end{pmatrix} \mapsto (x_0, x_1, x_2)^T \in \mathbf{R}^3.$$

The restriction  $\operatorname{pr}|_{S_1^3} : S_1^3 \rightarrow \mathbf{R}^3$  gives a local diffeomorphism at  $f(p) = e_3 \in S_1^3$ . In particular,  $f : D \rightarrow S_1^3$  has 5/2-cuspidal edge at  $p \in D$  if and only if so does  $\tilde{f} := \operatorname{pr} \circ f : D \rightarrow \mathbf{R}^3$ . We apply the criteria (Fact 4.4) to  $\tilde{f}$ . By Fact 2.3,  $p \in D$  is a singular point of the first kind if and only if  $\operatorname{Im} \varphi(p) \neq 0$ . Also by Fact 2.3, the condition (4.2) holds if and only if  $\operatorname{Re} \varphi = 0$  holds along the singular curve passing through  $p$ . Thus,  $\xi^k \operatorname{Re} \varphi = 0$  for arbitrary non-positive integer  $k$ . By Proposition 3.5, we have

$$(4.8) \quad \operatorname{Re}(\varphi(p)) = \operatorname{Im}(V\varphi(p)) = \operatorname{Re}(V^2 \varphi(p)) = 0.$$

Lemmas 4.7, 4.9 yield that

$$\xi \tilde{f}(p) = 2|h(p)|^2 (\operatorname{Im} \varphi(p)) \begin{pmatrix} 1 \\ \operatorname{Re} g(p) \\ \operatorname{Im} g(p) \end{pmatrix}, \quad \zeta^2 \tilde{f}(p) = 2 \operatorname{Im} \varphi(p) \begin{pmatrix} 0 \\ \operatorname{Im} g(p) \\ -\operatorname{Re} g(p) \end{pmatrix},$$

and  $\zeta^3 \tilde{f}(p) = \mathbf{0}$ . Hence, the constant  $c$  in the criteria (Fact 4.4) is  $c = 0$ , and  $\langle \xi \tilde{f}(p), \eta^2 \tilde{f}(p) \rangle_E = \langle \xi \tilde{f}(p), \eta^3 \tilde{f}(p) \rangle_E = 0$  holds, namely,  $\zeta$  is a null vector field satisfying (4.3). By Lemma 4.8, we have

$$\zeta^5 \tilde{f}(p) = \operatorname{pr}(\zeta^5 f(p)) = a_2 \xi \tilde{f}(p) + a_3 \zeta^2 \tilde{f}(p) + 48(\operatorname{Im} \varphi(p))^3 \begin{pmatrix} 1 \\ -\operatorname{Re} g(p) \\ -\operatorname{Im} g(p) \end{pmatrix},$$

and hence  $\det(\xi \tilde{f}, \eta^2 \tilde{f}, \eta^5 \tilde{f})(p) = -384|h(p)|^2 (\operatorname{Im} \varphi(p))^5 \neq 0$ . Therefore, we have the assertion.  $\square$

Theorem A is a direct conclusion of the following.

**Theorem 4.10.** *Let  $f : D \rightarrow S_1^3$  be a CMC 1 face defined on a simply connected domain  $D$  of  $\mathbf{C}$ , and  $p \in D$  be a singular point. Then,  $f$  has generalized conelike singularity at  $p$  if and only if  $f^\#$  has 5/2-cuspidal edge at  $p$ .*

*Proof.* By Proposition 4.2 and Theorem 4.3, we have the desired result.  $\square$

*Remark 4.11.* By (4.8), every 5/2-cuspidal edge singular points satisfies the condition (S), and hence, the  $\sigma$ -invariant can be defined. However, (4.8) yields that the  $\sigma$ -invariant vanishes along 5/2-cuspidal edge singular points.

*Example 4.12.* Fix a constant  $c \in \mathbf{C} \setminus \{0\}$ . Let  $f : \mathbf{C} \rightarrow S_1^3$  be a CMC 1 face given by the Weierstrass data  $(g, \omega) = (e^z, c e^{-z} dz)$ . The singular set  $\Sigma(f)$  coincides with the imaginary axis  $\operatorname{Re} z = 0$ . Since  $\varphi = dg/(g^2\omega) = 1/c$ , a singular point  $z \in \Sigma(f)$  is

- cuspidal edge if and only if  $c \in \mathbf{C} \setminus (\mathbf{R} \cup \sqrt{-1}\mathbf{R})$  (Fact 2.3),
- a generalized conelike singular point if and only if  $c \in \mathbf{R} \setminus \{0\}$  (Proposition 4.2),
- 5/2-cuspidal edge if and only if  $c \in \sqrt{-1}\mathbf{R} \setminus \{0\}$  (Theorem 4.3).

Therefore, we can observe the duality between generalized conelike singular points and 5/2-cuspidal edge singular points as in Theorem A. See Figure 2 for the images of  $c = 1$  and  $c = -\sqrt{-1}$ . In the case of  $c \neq -1/4$ , we can find a solution of the ODE (2.6) as

$$F = \frac{1}{\sqrt{\rho - \tau}} \begin{pmatrix} \tau e^{\rho z} & \rho e^{-\tau z} \\ \rho e^{\tau z} & \tau e^{-\rho z} \end{pmatrix} \left( \rho = \frac{-1 + \sqrt{1 + 4c}}{2}, \quad \tau = \frac{-1 - \sqrt{1 + 4c}}{2} \right),$$

and hence the map  $f = Fe_3F^*$  can be explicitly written as

$$f = \frac{1}{|\rho - \tau|} \begin{pmatrix} |\tau|^2 e^{\rho z + \bar{\rho} \bar{z}} - |\rho|^2 e^{-(\tau z + \bar{\tau} \bar{z})} & \bar{\rho} \tau e^{\rho z + \bar{\tau} \bar{z}} - \rho \bar{\tau} e^{-(\tau z + \bar{\rho} \bar{z})} \\ \rho \bar{\tau} e^{\tau z + \bar{\rho} \bar{z}} - \bar{\rho} \tau e^{-(\rho z + \bar{\tau} \bar{z})} & |\rho|^2 e^{\tau z + \bar{\tau} \bar{z}} - |\tau|^2 e^{-(\rho z + \bar{\rho} \bar{z})} \end{pmatrix}.$$

## 5. DUALITY BETWEEN $A_k$ SINGULARITIES AND CUSPIDAL $S_k$ SINGULAR POINTS

**5.1. Generalized  $A_k$  singular points.** For an integer  $k (\geq 2)$ , we set  $f_{A_k} : \mathbf{R}^2 \rightarrow \mathbf{R}^3$  as  $f_{A_k}(u, v) := (u, -(k+1)v^k - 2uv, kv^{k+1} + uv^2)$ . The image of  $f_{A_k}$  coincides with the discriminant set

$$\mathcal{D}_F = \{(x, y, z) \in \mathbf{R}^3; \text{there exists } t \in \mathbf{R} \text{ s.t. } F = F_t = 0\}$$

of the function  $F(t, x, y, z) := t^{k+1} + xt^2 + yt + z$ .

Let  $f : D \rightarrow M^3$  be a smooth map defined on a 2-manifold  $D$  into a 3-manifold  $M^3$ . A singular point  $p \in \Sigma(f)$  is said to be an  $A_k$ -type singular point (or  $A_k$ -front singular point) if  $f$  at  $p$  is  $\mathcal{A}$ -equivalent to  $f_{A_k}$  at the origin.  $A_2$ - (resp.  $A_3$ -) type singular points are cuspidal edges (resp. swallowtails). An  $A_4$ -type singular point is called *cuspidal butterfly*.

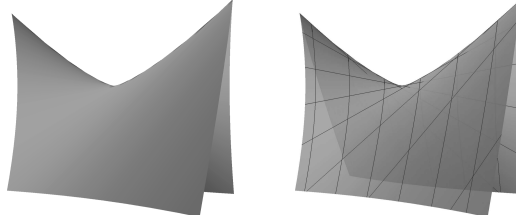

FIGURE 5. Cuspidal butterfly ( $A_4$ -type singular point).

If a smooth map  $f : D \rightarrow M^3$  admits an  $A_k$ -type singular point  $p \in D$ , then  $f$  is a front on a neighborhood of  $p$ , and  $p$  is a non-degenerate singular point. Moreover, if we take a singular curve  $\gamma(t)$  ( $|t| < \varepsilon$ ) passing through  $p = \gamma(0)$ , and a null vector field  $\eta(t)$  along  $\gamma(t)$ , it holds that

$$(5.1) \quad \delta(0) = \delta'(0) = \dots = \delta^{(k-3)}(0) = 0, \quad \delta^{(k-2)}(0) \neq 0,$$

where we set  $\delta(t) := \det(\gamma'(t), \eta(t))$ . Conversely, we have the following.

**Fact 5.1** (Criteria for  $A_k$  singularities ( $k = 2, 3, 4$ ) [22, 31, 16]). *Let  $k$  be either 2, 3, or 4. Also, let  $f : D \rightarrow M^3$  be a front, and  $p \in D$  be a non-degenerate singular point. Then,  $p$  is an  $A_k$ -type singular point if and only if (5.1) holds.*

For  $k \geq 5$ , to the best of the authors' knowledge, it is not known whether (5.1) characterizes  $A_k$ -type singular points or not. We give the following definition.

**Definition 5.2** (Generalized  $A_k$  singularity). Let  $k (\geq 2)$  be an integer. Also, let  $f : D \rightarrow M^3$  be a front, and  $p \in D$  be a non-degenerate singular point. Then,  $p$  is said to be a *generalized  $A_k$  singular point* if (5.1) holds.

By Fact 5.1, generalized  $A_k$  singular points are  $A_k$ -type singular points for  $k = 2, 3, 4$ . The following holds.

**Theorem 5.3.** Let  $f : D \rightarrow S_1^3$  be a CMC 1 face with Weierstrass data  $(g, \omega)$ , and  $p \in D$  be a singular point. For an integer  $k (> 1)$ ,  $p$  is a generalized  $A_k$  singular point if and only if  $\operatorname{Re} \varphi(p) \neq 0$  and

$$\operatorname{Im} \varphi = \operatorname{Im}(\sqrt{-1}V\varphi) = \cdots = \operatorname{Im}(\sqrt{-1}^{k-3}V^{k-3}\varphi) = 0, \quad \operatorname{Im}(\sqrt{-1}^{k-2}V^{k-2}\varphi) \neq 0$$

at  $p$ . Here  $(\varphi, V)$  is the characteristic pair associated with  $(g, \omega)$ .

*Proof.* We set  $i = \sqrt{-1}$ . By Fact 2.3,  $p \in D$  is a non-degenerate singular point and  $f$  is a front on a neighborhood of  $p$  if and only if  $\operatorname{Re} \varphi(p) \neq 0$ . As in (4.1), it holds that  $\delta = \det(\gamma', \eta) = \operatorname{Im} \varphi$ . Thus, (5.1) holds if and only if

$$(5.2) \quad \operatorname{Im} \varphi = \xi(\operatorname{Im} \varphi) = \cdots = \xi^{(k-3)}(\operatorname{Im} \varphi) \neq 0, \quad \xi^{(k-2)}(\operatorname{Im} \varphi) \neq 0$$

at  $p$ . By Proposition 3.5, we have that (5.2) is equivalent to

$$\operatorname{Im} \varphi = \operatorname{Im}(iV\varphi) = \cdots = \operatorname{Im}(i^{k-3}V^{k-3}\varphi) = 0, \quad \operatorname{Im}(i^{k-2}V^{k-2}\varphi) \neq 0$$

at  $p$ . Hence, we have the desired result.  $\square$

**5.2. Cuspidal  $S_k$  singular points.** For a non-negative integer  $k$ , we set  $f_{cs,k}^\pm : \mathbf{R}^2 \rightarrow \mathbf{R}^3$  as  $f_{cs,k}^\pm(u, v) := (u, v^2, v^3(u^{k+1} \pm v^2))$ . Let  $f : D \rightarrow M^3$  be a smooth map. If the map germ  $f$  at  $p$  is  $\mathcal{A}$ -equivalent to  $f_{cs,k}^\pm$  at the origin,  $f$  is said to have a *cuspidal  $S_k^\pm$  singular point* (or a  $cS_k^\pm$  singular point, for short) at  $p \in D$ . We refer to  $cS_k^+$  and  $cS_k^-$  singular points collectively as  $cS_k$  singular points. In the case that  $k$  is even,  $cS_k^+$  singular points are  $\mathcal{A}$ -equivalent to  $cS_k^-$ . Moreover  $cS_0$  singularity is the cuspidal cross cap.

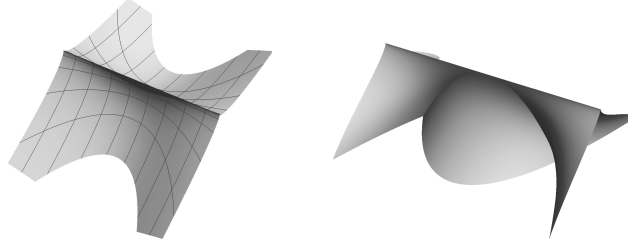

FIGURE 6. Graphics of  $cS_1$  singular points. The left figure is the image of  $f_{cs,1}^+$ , and the right one is that of  $f_{cs,1}^-$ .

The following is known:

**Fact 5.4** (Criteria for  $cS_k$  singularities [29, 27]). Let  $f : D \rightarrow \mathbf{R}^3$  be a frontal,  $p \in D$  be a non-degenerate singular point, and  $\nu_E : D \rightarrow S^2$  be a unit normal vector field along  $f$ , where  $S^2$  is the unit sphere  $S^2 = \{(x, y, z) \in \mathbf{R}^3 ; x^2 + y^2 + z^2 = 1\}$ . Also let  $\gamma(t)$  ( $|t| < \varepsilon$ ) be a singular curve passing through  $p = \gamma(0)$ , and let  $\eta$  be a null vector field on  $D$ . Set a function

$$\psi(t) := \det(\hat{\gamma}'(t), \hat{\nu}(t), d\nu(\eta(t))),$$

where  $\hat{\nu} := \nu \circ \gamma$ . Then  $f$  has  $cS_k$  singularity at  $p \in D$  if and only if

- (1)  $p$  is a singular point of the first kind,
- (2)  $\psi(0) = \psi'(0) = \cdots = \psi^{(k)}(0) = 0$ , ( $A := \psi^{(k+1)}(0) \neq 0$ ),

- (3) there exists a null vector field  $\zeta$  defined on a neighborhood of  $p$  such that  $\langle \xi f(p), \zeta^2 f(p) \rangle_E = 0$ ,  $\zeta^3 f(p) = \mathbf{0}$  and  $(B :=) \det(\xi f, \zeta^2 f, \zeta^5 f)(p) \neq 0$ , where  $\langle \cdot, \cdot \rangle_E$  is the canonical Euclidean inner product.

Moreover, in the case that  $k$  is odd,  $f$  has  $cS_k^\pm$  singularity at  $p \in D$  if and only if  $\pm AB > 0$ .

Applying this criteria, we prove the following.

**Proposition 5.5.** *Let  $f : D \rightarrow S_1^3$  be a CMC 1 face with Weierstrass data  $(g, \omega)$ , and  $p \in D$  be a singular point. Let us take an integer  $k (> 1)$ . Then,*

- $f$  has a  $cS_1^\pm$  singular point at  $p$  if and only if

$$\operatorname{Im} \varphi \neq 0, \quad \operatorname{Re} \varphi = \operatorname{Im}(V\varphi) = 0, \quad \pm \operatorname{Re}(V^2\varphi) (12 - \operatorname{Re}(V^2\varphi)) > 0$$

hold at  $p$ ,

- $f$  has a  $cS_{2\ell}$  singular point ( $\ell \geq 1$ ) at  $p$  if and only if

$$\operatorname{Im} \varphi \neq 0, \quad \operatorname{Re} \varphi = \operatorname{Im}(V\varphi) = \dots = \operatorname{Im}(V^{2\ell-1}\varphi) = \operatorname{Re}(V^{2\ell}\varphi) = 0,$$

and  $\operatorname{Im}(V^{2\ell+1}\varphi) \neq 0$  hold at  $p$ ,

- $f$  has a  $cS_{2\ell+1}^\pm$  singular point ( $\ell \geq 1$ ) at  $p$  if and only if

$$\operatorname{Im} \varphi \neq 0, \quad \operatorname{Re} \varphi = \operatorname{Im}(V\varphi) = \dots = \operatorname{Re}(V^{2\ell}\varphi) = \operatorname{Im}(V^{2\ell+1}\varphi) = 0,$$

and  $\pm(-1)^\ell \operatorname{Re}(V^{2\ell+2}\varphi) > 0$  hold at  $p$ .

Here  $(\varphi, V)$  is the characteristic pair associated with  $(g, \omega)$ .

In the proof of [25, Proposition 3.11], the following assertion is proved.

**Fact 5.6** ([25]). *Let  $f : D \rightarrow \mathbf{R}^3$  be a frontal,  $\gamma(t)$  ( $|t| < \varepsilon$ ) be a singular curve passing through a non-degenerate singular point  $p \in D$ , and let  $\eta$  be a null vector field on  $D$ . Then, there exists a positive valued function  $\alpha(t)$  such that*

$$\det(\xi f, \eta^2 f, \eta^3 f)(\gamma(t)) = \alpha(t)\psi(t)$$

holds on the singular set  $\Sigma(f)$  near  $p$ .

In particular, by Lemma 5.6,  $\psi(0) = \psi'(0) = \dots = \psi^{(k)}(0) = 0$ ,  $\psi^{(k+1)}(0) \neq 0$  holds if and only if

$$\xi^\ell \det(\xi f, \eta^2 f, \eta^3 f)(p) = 0 \quad (\ell = 0, \dots, k), \quad \xi^{k+1} \det(\xi f, \eta^2 f, \eta^3 f)(p) \neq 0.$$

Moreover, then  $\operatorname{sgn}(\psi^{(k+1)}(0)) = \operatorname{sgn}(\xi^{k+1} \det(\xi f, \eta^2 f, \eta^3 f)(p))$  holds.

*Proof of Proposition 5.5.* Let  $F : D \rightarrow S_1^3$  be a holomorphic null lift of  $f$  which satisfies (2.6) with  $F(p) = e_0$ . As in the proof of Theorem 4.3, we use the orthogonal projection (4.7). Since the restriction  $\operatorname{pr}|_{S_1^3} : S_1^3 \rightarrow \mathbf{R}^3$  is a local diffeomorphism at  $f(p) = e_3$ , the CMC 1 face  $f : D \rightarrow S_1^3$  has a  $cS_k^\pm$  singular point at  $p$  if and only if so does  $\tilde{f} := \operatorname{pr} \circ f : D \rightarrow \mathbf{R}^3$ . With respect to the condition (1), Fact 2.3 yields that  $p$  is a singular point of the first kind if and only if  $\operatorname{Im} \varphi(p) \neq 0$ . Next, we consider the condition (2). Let  $\xi$  be the singular direction vector field, and  $\eta$  be the null vector field given by (2.12). Since

$$\det(\xi \tilde{f}, \eta^2 \tilde{f}, \eta^3 \tilde{f}) = \det(\operatorname{pr}(\xi f), \operatorname{pr}(\eta^2 f), \operatorname{pr}(\eta^3 f)) = -\det(\varepsilon_3, \Phi(\xi f), \Phi(\eta^2 f), \Phi(\eta^3 f)),$$

we calculate  $\xi f$ ,  $\eta^2 f$  and  $\eta^3 f$  along the singular set  $\Sigma(f)$ , where  $\varepsilon_3 = (0, 0, 0, 1)^T$ . By Lemma 4.9, we have

$$\xi f(\gamma(t)) = 2|h|^2(\operatorname{Im} \varphi) F \begin{pmatrix} 1 & g \\ \bar{g} & 1 \end{pmatrix} F^*,$$

where the right hand side is evaluated at  $\gamma(t)$ . On the other hand, a direct calculation yields that

$$\eta^2 f(\gamma(t)) = 2(\operatorname{Im} \varphi) F \begin{pmatrix} 0 & -\sqrt{-1}g \\ \sqrt{-1}\bar{g} & 0 \end{pmatrix} F^*,$$



$$\eta^3 f(\gamma(t)) = a(t)\xi f + b(t)\eta^2 f + 4(\operatorname{Im} \varphi)(\operatorname{Re} \varphi)F \begin{pmatrix} 0 & g \\ \bar{g} & 0 \end{pmatrix} F^*,$$

where the right hand sides are evaluated at  $\gamma(t)$ , and  $a(t)$ ,  $b(t)$  are some functions. Let  $\check{F} : D \rightarrow \operatorname{SO}^+(1, 3)$  be the map defined by the holomorphic null lift  $F$  via (2.4). Under the identification  $\Phi$  as in (2.1), we have

$$\Phi(\xi(\gamma(t))) = 2|h|^2(\operatorname{Im} \varphi)\check{F} \begin{pmatrix} 1 \\ \operatorname{Re} g \\ \operatorname{Im} g \\ 0 \end{pmatrix}, \quad \Phi(\eta^2 f(\gamma(t))) = 2(\operatorname{Im} \varphi)\check{F} \begin{pmatrix} 0 \\ \operatorname{Im} g \\ -\operatorname{Re} g \\ 0 \end{pmatrix},$$

$$\Phi(\eta^3 f(\gamma(t))) = a(t)\Phi(\xi f) + b(t)\Phi(\eta^2 f) + 4(\operatorname{Im} \varphi)(\operatorname{Re} \varphi)\check{F} \begin{pmatrix} 0 \\ \operatorname{Re} g \\ \operatorname{Im} g \\ 0 \end{pmatrix}.$$

Since  $\det \check{F} = 1$ , we have

$$\begin{aligned} -\det(\varepsilon_3, \Phi(\xi f), \Phi(\eta^2 f), \Phi(\eta^3 f)) &= -16|h|^2(\operatorname{Im} \varphi)^3(\operatorname{Re} \varphi) \det \begin{pmatrix} \check{F}^{14} & 1 & 0 & 0 \\ \check{F}^{24} & \operatorname{Re} g & \operatorname{Im} g & \operatorname{Re} g \\ \check{F}^{34} & \operatorname{Im} g & -\operatorname{Re} g & \operatorname{Im} g \\ \check{F}^{44} & 0 & 0 & 0 \end{pmatrix} \\ &= 16|h|^2(\operatorname{Im} \varphi)^3 \check{F}^{44}(\operatorname{Re} \varphi) \end{aligned}$$

along  $\gamma(t)$ . Since  $\check{F}(p)$  is the identity matrix,  $\check{F}^{44}(p) = 1$ , where  $\check{F}^{-1} = (\check{F}^{jk})_{j,k=1,2,3,4}$ . In particular,  $\check{F}^{44} > 0$  holds on a neighborhood of  $p$ . Hence, there exists a positive valued function  $\rho(t)$  such that

$$(5.3) \quad \det(\xi \check{f}, \eta^2 \check{f}, \eta^3 \check{f})(\gamma(t)) = \operatorname{sgn}(\operatorname{Im} \varphi) \rho(t) (\operatorname{Re} \varphi)(\gamma(t)).$$

By Proposition 3.5, the condition (2) is equivalent to

$$(5.4) \quad \operatorname{Re} \varphi = \cdots = \operatorname{Re}(i^k V^k \varphi) = 0, \quad (A :=) \operatorname{sgn}(\operatorname{Im} \varphi) \operatorname{Re}(i^{k+1} V^{k+1} \varphi) \neq 0$$

at  $p$ , where we set  $i = \sqrt{-1}$ . In particular, since  $k \geq 1$ ,  $\operatorname{Re} \varphi(p) = \operatorname{Im}(V\varphi(p)) = 0$  holds.

Finally we consider the condition (3). If we set  $\zeta$  as in (4.4), Lemma 4.7 yields that

$$\zeta^2 f(p) = 2(\operatorname{Im} \varphi) \begin{pmatrix} 0 & -ig \\ i\bar{g} & 0 \end{pmatrix}, \quad \zeta^3 f(p) = O.$$

Moreover, by Lemma 4.8, there exist  $a_1, a_2, a_3 \in \mathbf{R}$  such that

$$\zeta^5 f(p) = a_1 f(p) + a_2 \xi f(p) + a_3 \zeta^2 f(p) + 4(12 - \operatorname{Re} V^2 \varphi)(\operatorname{Im} \varphi)^3 \begin{pmatrix} 1 & -g \\ -\bar{g} & 1 \end{pmatrix}.$$

Hence, we obtain

$$\begin{aligned} B &= \det(\xi \check{f}, \zeta^2 \check{f}, \zeta^5 \check{f})(p) \\ &= -\det(\Phi(f), \Phi(\xi f), \Phi(\zeta^2 f), \Phi(\zeta^5 f))(p) \\ &= 16|h|^2(\operatorname{Im} \varphi)^5(12 - \operatorname{Re} V^2 \varphi) \det \begin{pmatrix} 0 & 1 & 0 & 1 \\ 0 & \operatorname{Re} g & \operatorname{Im} g & -\operatorname{Re} g \\ 0 & \operatorname{Im} g & -\operatorname{Re} g & -\operatorname{Im} g \\ 1 & 0 & 0 & 0 \end{pmatrix} \\ &= -32|h|^2(\operatorname{Im} \varphi)^5(12 - \operatorname{Re} V^2 \varphi)(p). \end{aligned}$$

If  $k \geq 2$ , we have  $\operatorname{Re} V^2 \varphi(p) = 0$  by (5.4), and hence  $B = -384|h|^2(\operatorname{Im} \varphi)^5(p) \neq 0$ , which yields the condition (3). Then,  $AB = -384|h|^2 |\operatorname{Im} \varphi|^5 \operatorname{Re}(i^{k+1} V^{k+1} \varphi)(p)$  holds. If  $k = 1$ , we have

$$AB = 32|h|^2 |\operatorname{Im} \varphi|^5 (\operatorname{Re} V^2 \varphi)(12 - \operatorname{Re} V^2 \varphi)(p),$$

which yields the desired result.  $\square$

As a direct conclusion of Proposition 5.5, we have the following.

**Theorem 5.7.** *Let  $f : D \rightarrow S_1^3$  be a CMC 1 face with Weierstrass data  $(g, \omega)$ , and  $p \in D$  be a singular point. Let us take an integer  $k (> 1)$ . Then,*

- (1)  *$f$  has a  $cS_1$  singular point at  $p$  if and only if*

$$\operatorname{Im} \varphi \neq 0, \quad \operatorname{Re} \varphi = \operatorname{Im}(V\varphi) = 0, \quad \operatorname{Re}(V^2\varphi) \neq 0, 12$$

*hold at  $p$ ,*

- (2)  *$f$  has a  $cS_k$  singular point at  $p$  if and only if  $\operatorname{Im} \varphi \neq 0$  and*

$$\operatorname{Re} \varphi = \operatorname{Re}(\sqrt{-1}V\varphi) = \cdots = \operatorname{Re}(\sqrt{-1}^k V^k \varphi) = 0, \quad \operatorname{Re}(\sqrt{-1}^{k+1} V^{k+1} \varphi) \neq 0$$

*hold at  $p$ .*

*Here  $(\varphi, V)$  is the characteristic pair associated with  $(g, \omega)$ .*

By Theorem 5.3, if a CMC 1 face  $f$  has a  $cS_1$  singular point at  $p$ , then the condition  $(\mathbb{S})$ , i.e.,  $\operatorname{Re} \varphi = \operatorname{Im} V\varphi = 0$  at  $p$ , holds. Hence, the  $\sigma$ -invariant  $\sigma(f, p)$  can be defined (cf. Definition 3.4). As a corollary of Theorem 5.3, we have the following.

**Corollary 5.8.** *Let  $f : D \rightarrow S_1^3$  be a CMC 1 face. Suppose that  $f$  has a  $cS_1$  singular point at  $p$ . Then the  $\sigma$ -invariant  $\sigma(f, p)$  can be defined and  $\sigma(f, p) \neq 12$  holds.*

By Theorem 5.3, if a CMC 1 face  $f$  has cuspidal butterfly ( $A_4$ -type singularity) at  $p$ , then the condition  $(\mathbb{A})$ , i.e.,  $\operatorname{Im} \varphi = \operatorname{Re} V\varphi = 0$  at  $p$ , holds. Hence, the  $\alpha$ -invariant  $\alpha(f, p)$  can be defined (cf. Definition 3.4).

**Definition 5.9 (Admissibility).** Suppose that a CMC 1 face  $f$  has cuspidal butterfly at  $p \in D$ . If  $|\alpha(f, p)| \neq 12$ , then  $p$  is called an *admissible* cuspidal butterfly. On the other hand, if a CMC 1 face  $f$  has  $cS_1$  singularity at  $p \in D$  such that  $\sigma(f, p) \neq -12$ , then  $p$  is called an *admissible*  $cS_1$  singularity.

By Corollary 5.8, a CMC 1 face  $f$  has an admissible  $cS_1$  singular point  $p \in D$  if and only if  $|\sigma(f, p)| \neq 12$ . Theorem B is a direct conclusion of the following.

**Theorem 5.10.** *Let  $f : D \rightarrow S_1^3$  be a CMC 1 face defined on a simply connected domain  $D$  of  $\mathbb{C}$ , and  $p \in D$  be a singular point. Then, we have the following.*

- (1) *The CMC 1 face  $f$  has cuspidal  $S_1$  singularity at  $p$  if and only if the conjugate  $f^\#$  has admissible cuspidal butterfly at  $p$ .*
- (2) *For  $k \geq 2$ , the CMC 1 face  $f$  has cuspidal  $S_k$  singularity at  $p$  if and only if the conjugate  $f^\#$  has generalized  $A_{k+3}$  singularity at  $p$ .*

*Proof.* By Theorems 5.3 and 5.7, we have the desired result.  $\square$

**Example 5.11.** Fix a constant  $c \in \mathbb{C} \setminus \{0\}$ . Let  $f : \mathbb{C} \rightarrow S_1^3$  be a CMC 1 face given by the Weierstrass data  $(g, \omega) = (-e^z + 1/\sqrt{2}, ce^{-z}dz)$ . Then,  $z_0 = (-\log 2 + \sqrt{-1}\pi)/2$  is a singular point of  $f$ . Since

$$\varphi(z_0) = \frac{\sqrt{-1}}{2c}, \quad V\varphi(z_0) = -\frac{1}{c}, \quad V^2\varphi(z_0) = \frac{1 - \sqrt{-1}}{c},$$

it holds that

- $f$  has  $cS_1^+$  (resp.  $cS_1^-$ ) singularity at  $z_0$  if and only if  $c \in \mathbb{R}$  and  $c > 1/12$  (resp.  $k \in \mathbb{R} \setminus \{0\}$  and  $c < 1/12$ ). In particular,  $z_0 \in \Sigma(f)$  is an admissible  $cS_1$  singular point if and only if  $c \in \mathbb{R} \setminus \{0\}$  and  $c \neq \pm 1/12$ ,
- $f$  has cuspidal butterfly if and only if  $c \in \sqrt{-1}\mathbb{R} \setminus \{0\}$ . In particular,  $z_0 \in \Sigma(f)$  is an admissible cuspidal butterfly singular point if and only if  $c \in \sqrt{-1}\mathbb{R} \setminus \{0\}$  and  $c \neq \pm \sqrt{-1}/12$ .

Therefore, we can observe the duality between admissible  $cS_1$  singularity and admissible cuspidal butterfly as in Theorem B.

To visualize the figure of the surface, we use Small's formula (2.9). Let us set  $G(z) = \tan\left(\frac{z}{2}\sqrt{4c-1}\right)$ . Then  $G, g$ , and the Hopf differential  $Q = \omega dg$  satisfy (2.8). Substituting  $G, g, \omega$  into Small's formula (2.9), we can write down  $F$  and  $f = Fe_3F^*$ , explicitly. See Figures 7, 8, 9 for  $c = 1, c = -1/50$  and  $c = -\sqrt{-1}$ .

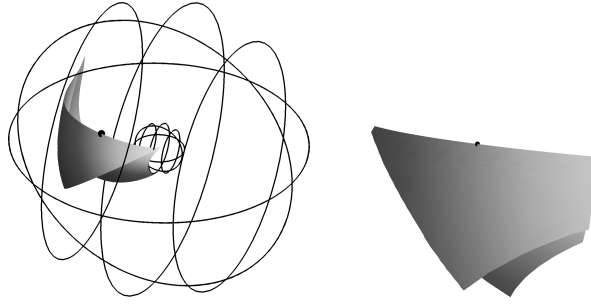

FIGURE 7. A CMC 1 face with  $cS_1^+$  singular point given in Example 5.11 with  $c = 1$ .

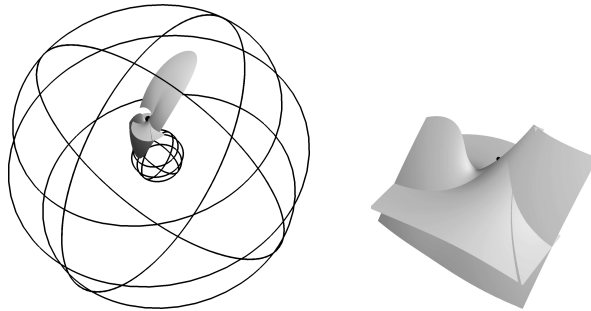

FIGURE 8. A CMC 1 face with  $cS_1^-$  singular point given in Example 5.11 with  $c = -1/50$ .

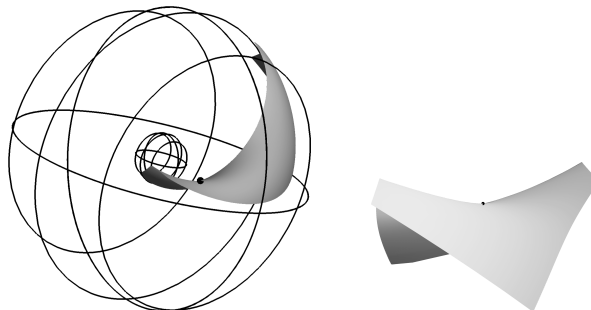

FIGURE 9. A CMC 1 face with cuspidal butterfly given in Example 5.11 with  $c = -\sqrt{-1}$ . This is the conjugate of the CMC 1 face given in Figure 7.

## 6. NON-DEGENERATE SINGULAR POINTS ON CMC 1 FACES

We obtained the criteria for several singular points, such as 5/2-cuspidal edge singularities (Theorem 4.3), cuspidal butterfly and generalized  $A_k$  singularities (Theorem 5.3), and cuspidal  $S_k$  singularities (Theorem 5.7), on CMC 1 faces in the de Sitter 3-space  $S_1^3$  in terms of the Weierstrass data. These criteria yield Theorems A and B. To summarize, we conclude that CMC 1 faces in  $S_1^3$  have the following dualities:

- (i) The cuspidal edge singularity is self-dual. The duality between swallowtail singularity and cuspidal cross cap singularity ([10]).
- (ii) The duality between generalized conelike singularity and 5/2-cuspidal edge singularity (Theorem A).
- (iii) The duality between admissible cuspidal butterfly singularity and admissible cuspidal  $S_1$  singularity (Theorem B, (1)). The duality between generalized  $A_{k+3}$  singularity and cuspidal  $S_k$  singularity, where  $k (\geq 2)$  is an integer (Theorem B, (2)).

These dualities (i)–(iii) yield that CMC 1 faces in  $S_1^3$  and maxfaces in the Lorentz-Minkowski 3-space  $L^3$  have the different behavior at singular points.

Furthermore, as a corollary of Theorems 4.3, 5.3 and 5.7, we give a classification of non-degenerate singular points on CMC 1 faces in  $S_1^3$  (Theorem C). For the proof of Theorem C, we prepare the following.

**Lemma 6.1.** *Let  $f : D \rightarrow S_1^3$  be a CMC 1 face. Suppose that  $f$  is a wave front at a singular point  $p \in D$ . Then  $p$  is either cuspidal edge, swallowtail, cuspidal butterfly, a generalized  $A_k$  singular point ( $k \geq 5$ ), or a generalized conelike singular point.*

*Proof.* Let  $(g, \omega)$  be a Weierstrass data of  $f$ , and  $(\varphi, V)$  be the characteristic pair associated with  $(g, \omega)$ . We denote by  $\xi$  the singular directional vector field given by (2.12). By Fact 2.3, we have  $\operatorname{Re} \varphi(p) \neq 0$ . In particular,  $p$  is a non-degenerate singular point. We consider the function  $\operatorname{Im} \varphi$  along the singular set  $\Sigma(f)$  near  $p$ . If  $\operatorname{Im} \varphi(p) \neq 0$ , then  $p$  must be a cuspidal edge by Fact 2.3. If  $\operatorname{Im} \varphi$  is identically zero along  $\Sigma(f)$ , then  $p$  must be a generalized conelike singular point by Proposition 4.2. Now we assume that  $\operatorname{Im} \varphi$  has an isolated zero at  $p$ . Then there exists an integer  $k (\geq 3)$  such that  $\xi^\ell(\operatorname{Im} \varphi)(p) = 0$  ( $\ell = 0, \dots, k-3$ ) and  $\xi^{k-2}(\operatorname{Im} \varphi)(p) \neq 0$ . By Proposition 3.5,

$$\operatorname{Im}(\sqrt{-1}^\ell V^\ell \varphi) = 0 \text{ for } \ell = 0, \dots, k, \quad \text{and} \quad \operatorname{Im}(\sqrt{-1}^{k+1} V^{k+1} \varphi) \neq 0$$

holds at  $p$ . If  $k = 3$ , then  $p$  must be a swallowtail singular point by Fact 2.3. If  $k = 4$ , then  $p$  must be a cuspidal butterfly singular point by Theorem 5.3. If  $k \geq 5$ , Theorem 5.3 yields that  $p$  must be a generalized  $A_k$  singular point.  $\square$

*Proof of Theorem C.* Let  $f : D \rightarrow S_1^3$  be a CMC 1 face with Weierstrass data  $(g, \omega)$ , and  $p \in D$  be a non-degenerate singular point. We denote by  $(\varphi, V)$  the characteristic pair associated with  $(g, \omega)$ , and let  $\xi$  be the singular directional vector field given by (2.12). Since we have treated the case that  $f$  is a wave front at  $p$  in Lemma 6.1, we assume that  $f$  is not a wave front at  $p$ . Fact 2.3 yields  $\operatorname{Re} \varphi(p) = 0$ . Since  $p \in D$  is a non-degenerate singular point, Fact 2.3 yields that  $\operatorname{Im} \varphi(p) \neq 0$ , and hence  $p$  is of the first kind. If  $\operatorname{Re} \varphi$  is identically 0 along a singular curve passing through  $p$ , then Theorem 4.3 yields that  $p$  must be a 5/2-cuspidal edge singular point. Now we assume that  $\operatorname{Re} \varphi$  has an isolated zero at  $p$ . Then there exists a non-negative integer  $k$  such that  $\xi^\ell(\operatorname{Re} \varphi)(p) = 0$  ( $\ell = 0, \dots, k$ ) and  $\xi^{k+1}(\operatorname{Re} \varphi)(p) \neq 0$ . By Proposition 3.5,

$$\operatorname{Re}(\sqrt{-1}^\ell V^\ell \varphi) = 0 \text{ for } \ell = 0, \dots, k, \quad \text{and} \quad \operatorname{Re}(\sqrt{-1}^{k+1} V^{k+1} \varphi) \neq 0$$

holds at  $p$ . If  $k = 0$ , then  $p$  must be a cuspidal cross cap singular point by Fact 2.3. If  $k \geq 2$ , Theorem 5.7 yields that  $p$  must be a cuspidal  $S_k$  singular point. If  $k = 1$ , Theorem 5.7 yields that  $p$  must be either a cuspidal  $S_1$  singular point (if  $\sigma(f, p) \neq 12$ ), or a singular point satisfying the condition (S) and  $\sigma(f, p) = 12$ .  $\square$

In the case of zero mean curvature surfaces (ZMC surfaces, for short) in  $L^3$ , degenerate lightlike points are shown to be lying on lightlike lines ([20], [36], [37]). However, in our case, degenerate singular points are isolated, since they occur at the branch points of the meromorphic function  $g$  (cf. Fact 2.3).

We set a smooth map  $f_{\text{fold}} : \mathbf{R}^2 \rightarrow \mathbf{R}^3$  as  $f_{\text{fold}}(u, v) := (u, v^2, 0)$ . Let  $f : D \rightarrow M^3$  be a smooth map into a 3-manifold  $M^3$ . If the map germ  $f$  at a point  $p \in D$  is  $\mathcal{A}$ -equivalent to  $f_{\text{fold}}$  at the origin, then  $f$  is said to have a *fold singular point* at  $p \in D$ . If a maxface in  $L^3$  admits fold singular points, it can be extended to a timelike minimal surface analytically ([17, 6]). The resulting surface is a zero mean curvature surface of mixed type. See [7] for details. However, in the case of CMC 1 faces in  $S_1^3$ , the following holds.

**Corollary 6.2.** *CMC 1 faces in  $S_1^3$  do not admit fold singular points.*

In [13, Theorem 1.1], a similar statement is proved in the case of generalized spacelike CMC surfaces in  $L^3$ . While their statements are similar, our proof of Corollary 6.2 is different from that of [13, Theorem 1.1].

On the other hand, We set a smooth map  $f_{(2k+1)/2} : \mathbf{R}^2 \rightarrow \mathbf{R}^3$  as  $f_{(2k+1)/2}(u, v) := (u, v^2, v^{2k+1})$ . Let  $f : D \rightarrow M^3$  be a smooth map into a 3-manifold  $M^3$ . If the map germ  $f$  at a point  $p \in D$  is  $\mathcal{A}$ -equivalent to  $f_{\text{fold}}$  at the origin, then  $f$  is said to have a *fold singular point* at  $p \in D$ . In [13, Remark 4.9], it was pointed out that maxfaces in  $L^3$  do not admit  $5/2$ -cuspidal edge. By an argument similar to that of [13, Remark 4.9], the following holds:

*Maxfaces in  $L^3$  do not admit  $(2k+1)/2$ -cuspidal edges, other than cuspidal edges (i.e.,  $k=1$ ).*

In the case of CMC 1 faces in  $S_1^3$ , the following holds.

**Corollary 6.3.** *CMC 1 faces in  $S_1^3$  do not admit  $(2k+1)/2$ -cuspidal edges, other than cuspidal edges (i.e.,  $k=1$ ) and  $5/2$ -cuspidal edges (i.e.,  $k=2$ ).*

*Proofs for Corollaries 6.2 and 6.3.* Since fold singular points and  $(2k+1)/2$ -cuspidal edges are non-degenerate, Theorem C yields the desired results.  $\square$

#### APPENDIX A. CALCULATION OF $\zeta^5 f$ (PROOF OF LEMMA 4.8)

In this appendix, we give a proof of Lemma 4.8. Let us fix the notations. We set  $i = \sqrt{-1}$ . Let  $f : D \rightarrow S_1^3$  be a CMC 1 face with Weierstrass data  $(g, \omega)$ , and  $(\varphi, V)$  be the characteristic pair. Suppose that  $p \in D$  is a non-degenerate singular point satisfying the condition  $(\mathbb{S})$ , i.e.,  $\text{Re}(\varphi(p)) = \text{Im}(V\varphi(p)) = 0$ . Then, there exist  $c_1, c_2 \in \mathbf{R}$  and  $\beta \in \mathbf{C}$ , such that  $c_1 \neq 0$  and

$$\varphi(p) = ic_1, \quad V\varphi(p) = c_2, \quad V^2\varphi(p) = \beta.$$

Also, we set

$$\lambda := 1 - g\bar{g}, \quad \theta := \frac{i}{gh} + \kappa \lambda^2,$$

cf. (4.4). By a direct calculation, we have the following.

**Lemma A.1.** *It holds that*

$$\begin{aligned} \varphi_z &= gh\varphi V\varphi, & \varphi_{zz} &= g^2 h^2 \varphi^2 V^2 \varphi + g\varphi V\varphi \{gh^2(\varphi + V\varphi) + h_z\}, \\ g_z &= g^2 h\varphi, & g_{zz} &= g^2 \varphi \{gh^2(V\varphi + 2\varphi) + h_z\}, \\ g_{zzz} &= g^2 \varphi \left[ g^2 h^3 \{ \varphi(V^2 \varphi + 6\varphi) + V\varphi(V\varphi + 7\varphi) \} + 3gh(V\varphi + 2\varphi)h_z + h_{zz} \right]. \end{aligned}$$

In particular, at the singular point  $p$ , we have

$$\begin{aligned}\varphi_z(p) &= ic_1c_2gh, & \varphi_{zz}(p) &= c_1g \left[ gh^2 \{-c_1(c_2 + \beta) + ic_2^2\} + ic_2h_z \right], \\ g_z(p) &= ic_1g^2h, & g_{zz}(p) &= c_1g^2 \{-2c_1 - ic_2\}gh^2 + ih_z\}, \\ g_{zzz}(p) &= c_1g^2 \left\{ (-c_1\beta - 7c_1c_2 + i(-6c_1^2 + c_2^2))g^2h^3 - 3g(2c_1 - ic_2)hh_z + ih_{zz} \right\},\end{aligned}$$

where the right hand sides are evaluated at  $p$ . Moreover, the derivatives of  $\lambda$  and  $\theta$  are given by

$$\begin{aligned}\lambda_z(p) &= -ic_1gh, & \lambda_{zz}(p) &= c_1g \{(2c_1 - ic_2)gh^2 - ih_z\}, & \lambda_{z\bar{z}}(p) &= -c_1^2|h|^2, \\ \lambda_{zzz}(p) &= c_1g \left[ \{c_1(7c_2 + \beta) + i(6c_1^2 - c_2^2)\}g^2h^3 + 3gh(2c_1 - ic_2)h_z - ih_{zz} \right], \\ \lambda_{zz\bar{z}}(p) &= c_1^2\bar{h} \{-c_2 + 2ic_1\}gh^2 - h_z\}, \\ \theta_z(p) &= c_1 - i\frac{h_z}{gh^2}, & \theta_{\bar{z}}(p) &= 0, & \theta_{zz}(p) &= -c_1\frac{\bar{h}}{g}, & \theta_{z\bar{z}}(p) &= c_1\frac{\bar{h}^2}{g^3h} \\ \theta_{zz}(p) &= c_1 \left\{ (c_2 + 1)gh - \frac{h_z}{h} \right\} + \frac{i}{gh^3} (2h_z^2 - hh_{zz}),\end{aligned}$$

where the right hand sides are evaluated at  $p$ .

Let  $\mathcal{E}$  be the 3-dimensional real subspace of  $\text{Herm}(2)$  given by  $\mathcal{E} := \text{Span}_{\mathbf{R}}\{E_0, E_1, E_2\}$ , where

$$E_0 := \begin{pmatrix} 1 & 0 \\ 0 & -1 \end{pmatrix}, \quad E_1 := \begin{pmatrix} 1 & g(p) \\ g(p) & 1 \end{pmatrix}, \quad E_2 := i \begin{pmatrix} 0 & g(p) \\ -g(p) & 0 \end{pmatrix}.$$

For  $X_1, X_2 \in \text{Herm}(2)$ , we define

$$X_1 \equiv X_2 \iff X_1 - X_2 \in \mathcal{E}.$$

If we set

$$E_3 := \begin{pmatrix} 1 & -g(p) \\ -g(p) & 1 \end{pmatrix}, \quad Y := \begin{pmatrix} 0 & g(p) \\ g(p) & 0 \end{pmatrix},$$

$E_3 \equiv -2Y$  since  $E_3 + 2Y = E_1$ . Moreover  $\text{Span}_{\mathbf{R}}\{E_0, E_1, E_2, E_3\} = \text{Herm}(2)$ . The complexification  $\mathcal{E}^{\mathbf{C}} = \text{Span}_{\mathbf{C}}\{E_0, E_1, E_2\}$  of  $\mathcal{E}$  is a 3-dimensional complex subspace of  $M_2(\mathbf{C})$ . For  $X_1, X_2 \in M_2(\mathbf{C})$ , we define

$$X_1 \sim X_2 \iff X_1 - X_2 \in \mathcal{E}^{\mathbf{C}}.$$

We also denote by  $\sim$  the equivalence relation ‘ $\equiv$ ’. We set a complex linear map  $\mu : M_2(\mathbf{C}) \rightarrow \mathbf{C}$  as

$$\mu(X) := \frac{1}{2} \left( \overline{g(p)}b + g(p)c - a - d \right) \quad \left( X = \begin{pmatrix} a & b \\ c & d \end{pmatrix} \in M_2(\mathbf{C}) \right).$$

Then, we have  $\mu(X^*) = \overline{\mu(X)}$ . Moreover, for arbitrary  $X \in M_2(\mathbf{C})$ ,

$$X = \frac{a-d}{2}E_0 + \frac{a+d}{2}E_1 + \frac{1}{2i} \left( \overline{g(p)}b - g(p)c \right) E_2 + \mu(X) Y$$

holds, which implies the following.

**Lemma A.2.** For  $X \in M_2(\mathbf{C})$ , it holds that  $X \equiv \mu(X) Y$ .

Let  $T_{2,j}$  ( $j = 0, 1, 2, 3, 4, 5$ ) be the matrices defined in Lemma 4.6. Setting  $\mu_j := \mu(T_{2,j})$ , we have

$$\mu(T_2) = \mu_0 + \lambda\mu_1 + \lambda^2\mu_2 + \lambda^3\mu_3 + \lambda^4\mu_4 + \lambda^5\mu_5.$$



**Lemma A.3.** *It holds that  $\mu_1(p) = \mu_2(p) = 0$ ,  $\mu_3(p) = -1/2$ , and*

$$\begin{aligned}(\mu_0)_z(p) &= c_1^2 gh, & (\mu_1)_z(p) &= \frac{1}{2} c_1 (c_1 + ic_2) gh, & (\mu_2)_z(p) &= \frac{1}{2} ic_1 gh, \\(\mu_0)_{z\bar{z}}(p) &= c_1^2 c_2 |h|^2, & (\mu_1)_{z\bar{z}}(p) &= -c_1^2 |h|^2, \\(\mu_0)_{zz}(p) &= c_1^2 g \{2(c_2 + ic_1) gh^2 + h_z\}, \\(\mu_1)_{zz}(p) &= \frac{1}{2} c_1 g \left[ \{c_1(2c_2 + 4 - \beta) + ic_2^2\} gh^2 + (c_1 + ic_2) h_z \right], \\(\mu_0)_{zz\bar{z}}(p) &= \frac{1}{2} c_1^2 \bar{h} \left[ \{2c_2^2 + ic_1(\beta + 3c_2)\} gh^2 + 2c_2 h_z \right], \\(\mu_0)_{zzz}(p) &= \frac{1}{2} c_1^2 g \left[ \{-12c_1^2 + 8c_2^2 + ic_1(5\beta + 23c_2)\} g^2 h^3 + 12(c_2 + ic_1) gh h_z + 2h_{zz} \right],\end{aligned}$$

where the right hand sides are evaluated at  $p$ .

*Proof.* First of all, we have  $\mu_j = \mu(T_{2,k}) = \mu(U_{2,k}) + \mu((U_{2,k})^*) = \mu(U_{2,k}) + \overline{\mu(U_{2,k})}$ . By Lemma 4.6, we obtain

$$\begin{aligned}\mu(U_{2,3}) &= -\kappa g^2 \bar{g} h \varphi \left\{ \kappa h (\overline{g(p)} g^2 - 2g + g(p)) + \bar{\kappa} \bar{h} (\overline{g(p)} - 2\bar{g} + g(p) \bar{g}^2) \right\} \\ &\quad - \frac{ikh}{2} \left( g(p)(\varphi + 1) - g + \frac{\overline{g(p)}g - 1}{\bar{g}} \right) + \frac{i\bar{\kappa}\bar{h}}{2} \left( \overline{g(p)} - \bar{g} + \frac{g(p)\bar{g} - 1}{g} \right).\end{aligned}$$

Thus we have  $\mu(U_{2,3})(p) = -1/4$ , and hence  $\mu_3(p) = 2 \operatorname{Re} \mu(U_{2,3}) = -1/2$  holds. Next, Lemma 4.6 yields  $\mu(U_{2,0}) = \frac{1}{2}(g(p)\bar{g} - \overline{g(p)}g)\varphi$ ,

$$\begin{aligned}\mu(U_{2,1}) &= -ig\bar{g}\varphi \left\{ \kappa h (\overline{g(p)} g^2 - 2g + g(p)) + \bar{\kappa} \bar{h} (\overline{g(p)} - 2\bar{g} + g(p) \bar{g}^2) \right\} \\ &\quad + \frac{1}{2} \left( \frac{\overline{g(p)}}{\bar{g}} + \frac{g(p)(\varphi + 1)}{g} - 1 - \frac{1}{g\bar{g}} \right), \\ \mu(U_{2,2}) &= \frac{ik}{2} \left\{ gh\varphi (3\overline{g(p)}g - g(p)\bar{g} - 2) + \frac{h_z}{h} \left( \overline{g(p)}g + \frac{g(p)}{g} - 2 \right) \right\}.\end{aligned}$$

Hence,  $\mu_0 = \frac{1}{2}(g(p)\bar{g} - \overline{g(p)}g)(\varphi - \bar{\varphi})$ ,

$$\begin{aligned}\mu_1 &= -ig\bar{g}(\varphi - \bar{\varphi}) \left\{ \kappa h (\overline{g(p)} g^2 - 2g + g(p)) + \bar{\kappa} \bar{h} (\overline{g(p)} - 2\bar{g} + g(p) \bar{g}^2) \right\} \\ &\quad + \frac{\overline{g(p)}}{\bar{g}} + \frac{g(p)}{g} - 1 - \frac{1}{g\bar{g}} + \frac{1}{2} \left( \frac{g(p)\varphi}{g} + \frac{\overline{g(p)}\bar{\varphi}}{\bar{g}} \right) \\ \mu_2 &= \frac{ik}{2} \left\{ gh\varphi (3\overline{g(p)}g - g(p)\bar{g} - 2) + \frac{h_z}{h} \left( \overline{g(p)}g + \frac{g(p)}{g} - 2 \right) \right\} \\ &\quad - \frac{i\bar{\kappa}}{2} \left\{ \bar{g}\bar{h}\bar{\varphi} (3g(p)\bar{g} - \overline{g(p)}g - 2) + \frac{\bar{h}_z}{\bar{h}} \left( g(p)\bar{g} + \frac{\overline{g(p)}}{\bar{g}} - 2 \right) \right\}.\end{aligned}$$

A straightforward calculation, we have the desired results.  $\square$

**Lemma A.4.** *The derivatives of  $T_2$  satisfies*

$$\begin{aligned}(T_2)_z(p) &\equiv c_1^2 ghY, & (T_2)_{zz}(p) &\equiv c_1^2 g \{gh^2(3c_2 + ic_1) + h_z\} Y, & (T_2)_{z\bar{z}}(p) &\equiv 0 \\ (T_2)_{zzz}(p) &\equiv c_1^2 g \left[ g^2 h^3 \{-3c_1^2 + 7c_2^2 + 2ic_1(5c_2 - 6 + 2\beta)\} + 3gh(3c_2 + ic_1)h_z + h_{zz} \right] Y,\end{aligned}$$

and  $(T_2)_{zz\bar{z}}(p) \equiv 10ic_1^3 |h|^2 hg Y$ , where the right hand sides are evaluated at  $p$ .

*Proof.* By Lemma A.2,  $\frac{\partial^{k+l}}{\partial z^k \partial \bar{z}^l}(T_2)(p) \equiv \mu \left( \frac{\partial^{k+l}}{\partial z^k \partial \bar{z}^l}(T_2)(p) \right) Y$ . Hence it suffices to calculate  $\mu((T_2)_z(p))$ ,  $\mu((T_2)_{zz}(p))$ ,  $\mu((T_2)_{z\bar{z}}(p))$ ,  $\mu((T_2)_{zzz}(p))$ ,  $\mu((T_2)_{zz\bar{z}}(p))$ . Since  $\mu \left( \frac{\partial^{k+l}}{\partial z^k \partial \bar{z}^l} T_2 \right) =$

$\frac{\partial^{k+l}}{\partial z^l \partial \bar{z}^k} \mu(T_2)$ , we have  $\mu((T_2)_z(p)) = (\mu_0)_z + \lambda_z \mu_1$ ,

$$\begin{aligned} \mu((T_2)_{zz}(p)) &= (\mu_0)_{zz} + \lambda_{zz} \mu_1 + 2\lambda_z(\mu_1)_z + 2(\lambda_z)^2 \mu_2 \\ \mu((T_2)_{z\bar{z}}(p)) &= (\mu_0)_{z\bar{z}} + \lambda_{z\bar{z}} \mu_1 + \lambda_z(\mu_1)_{\bar{z}} + \lambda_{\bar{z}}(\mu_1)_z + 2\lambda_z \lambda_{\bar{z}} \mu_2 \\ \mu((T_2)_{zzz}(p)) &= (\mu_0)_{zzz} + \lambda_{zzz} \mu_1 + 3\lambda_{zz}(\mu_1)_z + 3\lambda_z(\mu_1)_{zz} + 6\lambda_z \lambda_{zz} \mu_2 + 6(\lambda_z)^2 (\mu_2)_z + 6(\lambda_z)^3 \mu_3 \\ \mu((T_2)_{zz\bar{z}}(p)) &= (\mu_0)_{zz\bar{z}} + \lambda_{zz\bar{z}} \mu_1 + \lambda_{zz}(\mu_1)_{\bar{z}} + 2\{\lambda_{z\bar{z}}(\mu_1)_z + \lambda_z(\mu_1)_{z\bar{z}}\} \\ &\quad + 2(2\lambda_z \lambda_{z\bar{z}} + \lambda_{\bar{z}} \lambda_{zz}) \mu_2 + 2(\lambda_z)^2 (\mu_2)_{\bar{z}} + 4\lambda_z \lambda_{\bar{z}} (\mu_2)_z + 6(\lambda_z)^2 \lambda_{\bar{z}} \mu_3 + \lambda_{\bar{z}} (\mu_1)_{zz}, \end{aligned}$$

where the right hand sides are evaluated at  $p$ . Substituting the results of Lemmas A.1, A.3 into the above, we obtain the assertion.  $\square$

**Lemma A.5.** *Let  $\Psi, \Omega$  be the matrices as in Lemma 4.5. We have the following.*

- (1)  $\Psi(p)M_2(C) \subset \mathcal{E}^C$ ,
- (2)  $\Psi_z(p)\mathcal{E}^C \subset \mathcal{E}^C$ ,
- (3)  $\Psi_z(p)Y \equiv -c_1 g(p)h(p)Y$ ,
- (4)  $\Omega(p)E_2 \equiv O$ ,  $\Psi_{zz}(p)E_2 \equiv -c_1^2 g(p)^2 h(p)^2 Y$ .

*Proof.* For any  $X \in M_2(C)$ , a direct calculation shows that  $\mu(\Psi(p)X) = 0$ , and hence (1) holds. Since  $\mu(\Psi_z(p)E_0) = \mu(\Psi_z(p)E_1) = \mu(\Psi_z(p)E_2) = 0$ , we have (2). By  $\mu(\Psi_z(p)Y) = -c_1 g(p)h(p)$ , (3) holds. Finally, since  $\mu(\Omega(p)E_2) = 0$ ,  $\mu(\Psi_{zz}(p)E_2) = -c_1^2 g(p)^2 h(p)^2$ , we obtain (4).  $\square$

**Lemma A.6.** *The derivatives of  $T_3$  satisfies*

$$\begin{aligned} (T_3)_z(p) &\equiv 3ic_1^2 c_2 ghY, \\ (T_3)_{zz}(p) &\equiv c_1^2 g \{gh^2(-3c_1 c_2 + 24c_1 - 4c_1 \beta + i(-c_1^2 + 7c_2^2)) + 3ic_2 h_z\} Y, \\ (T_3)_{z\bar{z}}(p) &\equiv -24c_1^3 |h|^2 Y, \end{aligned}$$

where the right hand sides are evaluated at  $p$ .

*Proof.* Lemma 4.5 yields that  $T_3 = (\Psi + \lambda^2 \Omega)T_2 + \theta(T_2)_z + \bar{\theta}(T_2)_{\bar{z}} + T_2(\Psi^* + \lambda^2 \Omega^*)$ . By a direct calculation, we obtain

$$\begin{aligned} (T_3)_z &= (\Psi + \lambda^2 \Omega)_z T_2 + (\Psi + \lambda^2 \Omega)(T_2)_z + \theta_z(T_2)_z + \theta(T_2)_{zz} \\ &\quad + \bar{\theta}_z(T_2)_{\bar{z}} + \bar{\theta}(T_2)_{z\bar{z}} + (T_2)_z(\Psi^* + \lambda^2 \Omega^*), \\ (T_3)_{zz} &= (\Psi + \lambda^2 \Omega)_{zz} T_2 + 2(\Psi + \lambda^2 \Omega)_z (T_2)_z + (\Psi + \lambda^2 \Omega)(T_2)_{zz} \\ &\quad + \theta_{zz}(T_2)_z + 2\theta_z(T_2)_{zz} + \theta(T_2)_{zzz} + \bar{\theta}_{zz}(T_2)_{\bar{z}} \\ &\quad + 2\bar{\theta}_z(T_2)_{z\bar{z}} + \bar{\theta}(T_2)_{z\bar{z}\bar{z}} + (T_2)_{zz}(\Psi^* + \lambda^2 \Omega^*), \\ (T_3)_{z\bar{z}} &= (\Psi + \lambda^2 \Omega)_z (T_2)_{\bar{z}} + (\Psi + \lambda^2 \Omega)(T_2)_{z\bar{z}} + \theta_{z\bar{z}}(T_2)_z + \theta_z(T_2)_{z\bar{z}} \\ &\quad + \theta_z(T_2)_{zz} + \theta(T_2)_{zz\bar{z}} + \bar{\theta}_{z\bar{z}}(T_2)_{\bar{z}} + \bar{\theta}_z(T_2)_{z\bar{z}} \\ &\quad + \bar{\theta}_z(T_2)_{z\bar{z}} + \bar{\theta}(T_2)_{z\bar{z}\bar{z}} + (T_2)_{z\bar{z}}(\Psi^* + \lambda^2 \Omega^*) + (T_2)_z(\Psi^* + \lambda^2 \Omega^*)_{\bar{z}}. \end{aligned}$$

Substituting the results of Lemmas A.1, A.4, A.5 into the above, and evaluating this at  $p$ , we obtain the assertion.  $\square$

Now, Lemma 4.8 is a direct conclusion of the following.

**Proposition A.7.** *It holds that  $T_5(p) \equiv 4(12 - \operatorname{Re} \beta)c_1^3 E_3$ .*

*Proof.* By Lemma 4.5, we have

$$U_5 = (\Psi + \lambda^2 \Omega)T_4 + \theta(T_4)_z, \quad U_5(p) = \Psi(p)T_4(p) + \frac{i}{g(p)h(p)}(T_4)_z(p).$$

Lemma A.5 yields that  $U_5(p) \equiv \frac{i}{g(p)h(p)}(T_4)_z(p)$ . With respect to  $(T_4)_z(p)$ , Lemma 4.5 implies  $T_4 = (\Psi + \lambda^2\Omega)T_3 + \theta(T_3)_z + \bar{\theta}(T_3)_{\bar{z}} + T_3(\Psi^* + \lambda^2\Omega^*)$ . Substituting the results of Lemmas A.1, A.5 and  $T_3(p) = O$  into

$$(T_4)_z = (\Psi + \lambda^2\Omega)_z T_3 + (\Psi + \lambda^2\Omega)(T_3)_z + \theta_z(T_3)_z + \theta(T_3)_{zz} \\ + \bar{\theta}_z(T_3)_{\bar{z}} + \bar{\theta}(T_3)_{z\bar{z}} + (T_3)_z(\Psi^* + \lambda^2\Omega^*),$$

we have

$$(A.1) \quad (T_4)_z(p) \equiv \theta_z(p)(T_3)_z(p) + \theta(p)(T_3)_{zz}(p) + \bar{\theta}(p)(T_3)_{z\bar{z}}(p).$$

Hence by Lemmas A.1 and A.6, it holds that

$$(T_4)_z(p) = -ic_1^2 g(p)h(p) \{4c_1(\beta - 12) + i(c_1^2 - 7c_2^2)\} Y.$$

Therefore we obtain  $T_5(p) \equiv 8(-12 + \operatorname{Re}\beta)c_1^3 Y \equiv 4(12 - \operatorname{Re}\beta)c_1^3 E_3$ .  $\square$

*Acknowledgements.* The authors would like to thank Shintaro Akamine, Kentaro Saji, Yuta Ogata, Keisuke Teramoto, Masaaki Umehara and Kotaro Yamada for helpful comments.

#### REFERENCES

- [1] K. Akutagawa, *On spacelike hypersurfaces with constant mean curvature in the de Sitter space*, Math. Z. **196** (1987), 13–19.
- [2] R. Aiyama, K. Akutagawa, *Kenmotsu-Bryant type representation formulas for constant mean curvature surfaces in  $\mathbb{H}^3(-c^2)$  and  $\mathbb{S}_1^3(c^2)$* , Ann. Global Anal. Geom. **17** (1999), 49–75.
- [3] R. L. Bryant, *Surfaces of mean curvature one in hyperbolic space*, Théorie des variétés minimales et applications, Sémin. Palaiseau/France, 1983/1984, Astérisque 154-155, 321–347 (1988).
- [4] E. Calabi, *Examples of Bernstein problems for some nonlinear equations*, Global Analysis, Proc. Sympos. Pure Math. **15**, 223–230 (1970).
- [5] S. Fujimori, *Spacelike CMC 1 surfaces with elliptic ends in de Sitter 3-space*, Hokkaido Math. J. **35** (2006), 289–320.
- [6] S. Fujimori, Y.W. Kim, S.-E. Koh, W. Rossman, H. Shin, M. Umehara, K. Yamada and S.-D. Yang, *Zero mean curvature surfaces in Lorentz-Minkowski 3-space and 2-dimensional fluid mechanics*, Math. J. Okayama Univ. **57** (2015), 173–200.
- [7] S. Fujimori, Y. Kawakami, M. Kokubu, W. Rossman, M. Umehara and K. Yamada, *Entire zero-mean curvature graphs of mixed type in Lorentz-Minkowski 3-space*, Quart. J. Math. **67** (2016), 801–837.
- [8] S. Fujimori, M. Noro, K. Saji, T. Sasaki and M. Yoshida, *Schwarz maps for the hypergeometric differential equation*, Int. J. Math. **26** (2015), 1541002.
- [9] S. Fujimori, W. Rossman, M. Umehara, K. Yamada and S.-D. Yang, *New maximal surfaces in Minkowski 3-space with arbitrary genus and their cousins in de Sitter 3-space*, Result. Math. **56** (2009), 41–82.
- [10] S. Fujimori, K. Saji, M. Umehara and K. Yamada, *Singularities of maximal surfaces*, Math. Z. **259** (2008), 827–848.
- [11] A. Honda, *Duality of singularities for spacelike CMC surfaces*, Kobe J. Math. **34** (2017), 1–11.
- [12] A. Honda, *Duality of singularities for flat surfaces in Euclidean space*, J. Singul. **21** (2020), 132–148.
- [13] A. Honda, M. Koiso, and K. Saji, *Fold singularities on spacelike CMC surfaces in Lorentz-Minkowski space*, Hokkaido Math. J. **47** (2018), 245–267.
- [14] A. Honda, K. Naokawa, K. Saji, M. Umehara and K. Yamada, *Duality on generalized cuspidal edges preserving singular set images and first fundamental forms*, J. Singul. **22** (2020), 59–91.
- [15] S. Izumiya, T. Nagai and K. Saji, *Great circular surfaces in the three-sphere*, Differ. Geom. Appl. **29** (2011), 409–425.
- [16] S. Izumiya and K. Saji, *The mandala of Legendrian dualities for pseudo-spheres in Lorentz-Minkowski space and “flat” spacelike surfaces*, J. Singul. **2** (2010), 92–127.
- [17] Y.W. Kim, S.-E. Koh, H. Shin and S.-D. Yang, *Spacelike maximal surfaces, timelike minimal surfaces, and Björling representation formulae*, J. Korean Math. Soc. **48** (2011), 1083–1100.
- [18] Y.W. Kim and S.-D. Yang, *A family of maximal surfaces in Lorentz-Minkowski three-space*, Proc. Amer. Math. Soc. **134** (2006), 3379–3390.
- [19] Y.W. Kim and S.-D. Yang, *Prescribing singularities of maximal surfaces via a singular Björling representation formula*, J. Geom. Phys. **57** (2007), 2167–2177.
- [20] V.A. Klyachin, *Surfaces of zero mean curvature of mixed type in Minkowski space*, Izv. Math. **67** (2003), 209–224.
- [21] O. Kobayashi, *Maximal surfaces in the 3-dimensional Minkowski space  $L^3$* , Tokyo J. Math. **6** (1983), 297–309.

- [22] M. Kokubu, W. Rossman, K. Saji, M. Umehara, and K. Yamada, *Singularities of flat fronts in hyperbolic 3-space*, Pacific J. Math. **221** (2005), 303–351; addendum **294** (2018), 505–509.
- [23] M. Kokubu, M. Umehara, and K. Yamada, *An elementary proof of Small’s formula for null curves in  $PSL(2, \mathbb{C})$  and an analogue for Legendrian curves in  $PSL(2, \mathbb{C})$* , Osaka J. Math. **40** (2003), 697–715.
- [24] B. Lawson, *Complete minimal surfaces in  $S^3$* , Ann. of Math. (2) **92** (1970), 335–374.
- [25] L.F. Martins, K. Saji, M. Umehara and K. Yamada, *Behavior of Gaussian curvature and mean curvature near non-degenerate singular points on wave fronts*, Geometry and Topology of Manifold, Springer Proc. in Math. & Stat. **154**, 2016, Springer, 247–282.
- [26] Y. Matsushita, T. Nakashima and K. Teramoto, *Geometric properties near singular points of surfaces given by certain representation formulae*, preprint (arXiv:2003.10635).
- [27] Y. Ogata, and K. Teramoto, *Duality between cuspidal butterflies and cuspidal  $S_1^-$  singularities on maximal surfaces*, Note Mat. **38** (2018), 115–130.
- [28] J. Ramanathan, *Complete spacelike hypersurfaces of constant mean curvature in de Sitter space*, Indiana Univ. Math. J. (2) **36** (1987), 349–359.
- [29] K. Saji, *Criteria for cuspidal  $S_k$  singularities and their applications*, J. Gökova Geom. Topol. GGT **4** (2010), 67–81.
- [30] K. Saji, M. Umehara and K. Yamada, *The geometry of fronts*, Ann. Math. (2) **169** (2009), 491–529.
- [31] K. Saji, M. Umehara and K. Yamada,  *$A_k$  singularities of wave fronts*, Math. Proc. Cambridge Philos. Soc. **146** (2009), 731–746.
- [32] A.J. Small, *Surfaces of constant curvature 1 in  $H^3$  and algebraic curves on a quadric*, Proc. Amer. Math. Soc. **122** (1994), 1211–1220.
- [33] H. Takahashi, *Timelike minimal surfaces with singularities in three-dimensional spacetime* (Japanese), Master thesis, Osaka University, 2012.
- [34] M. Umehara and K. Yamada, *Complete surfaces of constant mean curvature 1 in the hyperbolic 3-space*, Ann. of Math. (2) **137** (1993), 611–638.
- [35] M. Umehara and K. Yamada, *Maximal surfaces with singularities in Minkowski space*, Hokkaido Math. J. **35** (2006), 13–40.
- [36] M. Umehara and K. Yamada, *Hypersurfaces with light-like points in a Lorentzian manifold*, J. Geom. Anal. **29** (2019), 3405–3437.
- [37] M. Umehara and K. Yamada, *Hypersurfaces with light-like points in a Lorentzian manifold II*, Kodai Math. J. **44** (2021), 69–76.
- [38] M. Yasumoto, *Weierstrass-type representations for timelike surfaces*, Singularities in generic geometry, 449–469, Adv. Stud. Pure Math., 78, Math. Soc. Japan, Tokyo, 2018.

DEPARTMENT OF APPLIED MATHEMATICS, YOKOHAMA NATIONAL UNIVERSITY, YOKOHAMA 240-8501, JAPAN  
 Email address: honda-atsufumi-kp@ynu.ac.jp

GRADUATE SCHOOL OF ENGINEERING SCIENCE, YOKOHAMA NATIONAL UNIVERSITY, YOKOHAMA 240-8501, JAPAN  
 Email address: sato-himemi-hr@ynu.jp  
 Current address: Asahi Mutual Life Insurance Company, Tokyo 160-8570, Japan