

Power Modeling for Effective Datacenter Planning and Compute Management

Ana Radovanovic, Bokan Chen, Saurav Talukdar, Binz Roy, Alexandre Duarte, and Mahya Shahbazi

Abstract—Datacenter power demand has been continuously growing and is the key driver of its cost. An accurate mapping of compute resources (CPU, RAM, etc.) and hardware types (servers, accelerators, etc.) to power consumption has emerged as a critical requirement for major Web and cloud service providers. With the global growth in datacenter capacity and associated power consumption, such models are essential for important decisions around datacenter design and operation. In this paper, we discuss two classes of statistical power models designed and validated to be accurate, simple, interpretable and applicable to all hardware configurations and workloads across hyperscale datacenters of Google fleet. To the best of our knowledge, this is the largest scale power modeling study of this kind, in both the scope of diverse datacenter planning and real-time management use cases, as well as the variety of hardware configurations and workload types used for modeling and validation. We demonstrate that the proposed statistical modeling techniques, while simple and scalable, predict power with less than 5% Mean Absolute Percent Error (MAPE) for more than 95% diverse Power Distribution Units (more than 2000) using only 4 features. This performance matches the reported accuracy of the previous started-of-the-art methods, while using significantly less features and covering a wider range of use cases.

Index Terms—Power Model, Datacenter, Big Data, Machine Learning, Load Management.

I. INTRODUCTION

Datacenters are large warehouse-sized computing systems that operate around the clock to support large-scale Internet services worldwide, while enabling fast growth of the IT industry and transformation of the economy. Consequently, the demand for computing resources and datacenter power worldwide has been continuously growing, contributing to approximately 1% of the total electricity usage [1]. Hyperscale datacenters are known to consume tens of thousands megawatt hours of electricity per day (for comparison, the entire city of San Francisco consumes 20000MWh per day [2]). Furthermore, new datacenter machine upgrades are planned based on the peak critical power (power for computing equipment only, excluding cooling and other ancillary loads [3]), and the overall infrastructure costs are highly dependent on resource (e.g. CPU) utilization [3], [4]. Given the fact that only between 2010 and 2018, the global datacenter workloads and compute instances had increased more than sixfold, and continue to grow [1], new methodologies for increasing datacenter power and energy efficiency solutions have been essential due to the

high economic, environmental and performance impacts (see [5] for more discussion).

A critical step to enable more efficient datacenter planning and compute load management is development of universally accurate power models. In this paper, two classes of accurate and light-weight power models are proposed to characterize power consumption based on workload CPU usage for several use cases: 1) Accurate models enable real-time estimation of datacenter power consumption and, consequently, its electricity-based carbon footprint ([6], [7]) using the monitored and logged resource usage across all clusters in the fleet; 2) Understanding the mapping between cluster level CPU usage and its power usage enables near-term (intraday and day-ahead) cost and carbon optimizing control of workload, including software-controlled power capping [3] and grid level demand response [6], [8]–[10]; and 3) The models can help address questions on power provisioning and rightsizing of future machine upgrades given monthly, quarterly or yearly planned or provisioned resource usage trends. For example, if datacenter planners can accurately provision cluster level peak power usage and evaluate the gap to the nameplate power (capacity), they can support more machines and increase utilization of the power infrastructure overall (see [3] for more discussion).

Even though power consumption in hyperscale datacenters is mainly driven by IT equipment (i.e., servers, storage and network) [1], quantifying the impact of the above mentioned use cases on the overall datacenter campus power requires understanding its relationship to the lower level, typically metered, power domains called Power Distribution Units (PDUs), which encapsulate all servers, networking equipment and storage. The goal of this paper is to accurately relate PDU’s workload resource consumption to its power at 5-minute time granularity. Using the vast amount of data across all datacenter PDUs (thousands of them) with varying hardware configurations, machine platforms and workload types, we propose two classes of light-weight statistical power models that predict PDU’s power consumption as a function of workload resource usage and static hardware characteristics. The first class of the models, called Per-PDU model, is piecewise linear in CPU usage and is retrained daily for each PDU. The second class, unified power model, is trained using the Random Forest regressor for two cases: 1) to predict a single machine’s power, which is then aggregated across all machines within a PDU to estimate its power consumption (Unified Machine Model), and 2) to directly predict PDU’s power without using machine level data (Unified PDU Model). The unified power models utilize Random Forest regression in order to capture the nonlinear dependence between machine/PDU’s power consumption and

The authors are with Google, Inc. Mountain View, CA, 94043 (Email: anaradovanovic@google.com, bokanchen@google.com, stalukdar@google.com, binzroy@google.com, alexandredu@google.com, mahyash@google.com) .

its workload resource (CPU) usage and other properties, as well as machine/PDU’s hardware characteristics. These models are trained to capture any machine/PDU’s configuration type deployed within Google’s datacenter fleet. Note that all other machine- and PDU-related hardware and workload properties, including effects of task scheduling, CPU and voltage frequency scaling, etc., get implicitly incorporated in the proposed models.

The proposed models are trained using a common modeling pipeline, running daily in an automated and parallelized manner, capturing data from all power domains across Google’s datacenter fleet. While the proposed models ensure high and mutually comparable accuracy when predicting PDUs’ power consumption in steady state, each model shows advantages in addressing specific use cases. High accuracy of the Per-PDU model across all CPU/power operating states and its piecewise linearity in CPU usage make it an ideal candidate for evaluating the impact of changes in resource usage on power consumption. Such changes in resource usage can happen when the flexible workload is shifted across time and space (more details given in Subsection III-A). On the other hand, the Random Forest regression models (Subsection III-B) are best suited for quantifying effects of: 1) more significant compute load migrations across compute clusters, 2) perturbations caused by maintenance and demand response events, and 3) machine upgrades. Rightsizing of future datacenters is also another application of the proposed models, which has been discussed in Section IV.

The proposed models have been validated extensively and rigorously for all power domains across Google’s datacenters and over more than five-month-long time horizon. Their high accuracy is demonstrated irrespective of the heterogeneity in different machine configurations (e.g., CPU-based general purpose server platforms, accelerator or GPU-based platforms), workload types (e.g., mail, video processing and streaming, distributed computing, etc.), and power architectures. The main metric used to evaluate performance across all use cases introduced earlier is Mean Absolute Percent Error (MAPE). In addition, the prediction error is characterized accurately in scenarios where the measured PDU’s power is larger than its prediction (i.e., for instances with underprediction error). This is a critical requirement for risk-aware control of PDU’s peak CPU usage, where the goal is to protect breaker limits or avoid exceeding a given power usage threshold (commonly referred to as power capping limit). Details of the performance analysis for different use cases is discussed in Section IV.

Although out of scope of this paper, it is important to note that PDUs’ power consumption estimates can be used directly to evaluate the impact of compute load shaping on the total campus power and energy consumption [8]–[10]. While datacenter campus typically encompasses some auxiliary loads (e.g., office HVAC) that are not powered by PDU’s power supply, our analysis shows that the total campus power can be accurately expressed as the sum of its PDUs’ power measurements inflated by a small, easy to estimate, overhead percentage.

A vast amount of literature has focused on provisioning power consumption at a component, circuit, server, PDU and all the way to datacenter level [5]. While component

level power models (e.g., at a processor level) are typically designed to capture relationships between control signals and component states (see examples in [4], [5], [11], [12]), they are usually designed for specific types of hardware (e.g., Intel Xeon-based server platforms) and are not straightforward to generalize for power provisioning in hyperscale datacenters, which are highly heterogeneous in: 1) workload types (e.g., mail, video processing and streaming, distributed computation, search, etc.), 2) platform families (e.g., Intel Cascade Lake, IBM Power8, GPU based servers, etc.), and 3) platform level control mechanisms (Turbo Boost, DVFS, etc.) [13].

Earlier studies, conducted using a limited scope of workload and platform types, recognized the potentially high accuracy of light-weight statistical models in provisioning power at machine, rack, PDU, cluster and datacenter levels [3], [14], [15]. While this paper shares some insights from the previously published work, its main contributions are summarized below:

- **Use-case-driven design:** The approach for model design and feature selection is strongly impacted by a wide range of targeted use cases, oriented toward more efficient, carbon-effective and dynamic management of compute load, as well as longer-term planning and rightsizing of future datacenters.
- **Largest scale validation:** This is the largest reported power modeling and validation pipeline, incorporating thousands of PDUs across all of Google’s datacenter fleet, with heterogeneous hardware configurations, as well as workload types. It is demonstrated that the generality and effectiveness in provisioning PDU’s power is achievable using only basic hardware and resource usage characteristics (such as CPU usage and CPU utilization, i.e., CPU usage divided by the total CPU capacity).
- **High accuracy:** While the proposed models use significantly fewer features, they are generalizable, and their performance is well aligned with the reported accuracy of the related state-of-the-art methods ([14], [15]): 1) throughout the dynamic operating range; and 2) despite the fact that they do not utilize any performance-related metrics, which were previously reported to be critical for effective predictions.
- **Random Forest-based models for predicting PDU’s power:** To the best of our knowledge, this paper is the first to introduce Random Forest regression in the context of datacenter power modeling for efficient and generalizable learning, while effectively capturing heterogeneity in workload and platform types, as well as the nonlinearity in resource utilization.

The rest of the paper is organized as follows: Section II describes the overall architecture of a datacenter, including the available power telemetry systems necessary for model verification. Section III presents the training pipeline for the power models, along with a discussion on feature selection and model structure. Performance of the proposed models and their applicability to different use cases are discussed in Section IV. Finally, Section V concludes the paper.

II. DATACENTER POWER ARCHITECTURES

Figure 1 shows a simplified view of power architecture of a typical Google datacenter [16]. Every datacenter is connected to the electricity grid via several medium voltage feeders (about 30kV), each supporting about 30MW of power demand. Each medium voltage distribution line is transformed to supply low voltage PDUs, operating at about 400V. PDUs support about 3MW of power demand, and are typically connected to 3 BUS ducts. The BUS ducts supply power to the IT equipment, fan coils (about 5kW each, used for cooling) on the datacenter floor, and off-floor cooling equipment (e.g. chillers) for some of the three variants of Google’s datacenter architectures.

The IT equipment on the datacenter floor comprises compute, storage, and networking racks, about 30 kW each. A single PDU typically has a few thousand machines, and a handful of PDUs (typically around 10) comprise a cluster. The PDUs in each cluster belong to a single job-scheduling domain, i.e., a common real-time scheduler that assigns computing tasks to its feasible machines. Generator backup is available to keep the datacenter running in the event of a grid power outage. Depending on the architecture, the PDUs in a cluster are either connected to a separate backup generators, or to a common backup generator that supports the medium voltage line.

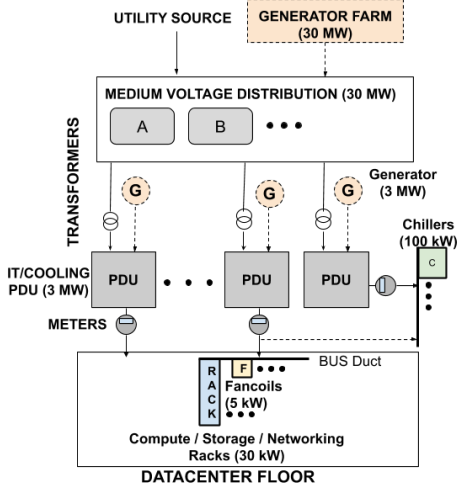

Fig. 1. A simplified representation of datacenter power distribution hierarchy.

III. THE POWER MODELING PIPELINE

A power modeling pipeline is used for data extraction, processing and training of two classes of models to predict power consumption across Google’s datacenter fleet at 5-minute granularity. The models are: 1) a piecewise linear model with PDU’s CPU usage as the only feature. The model is called Per-PDU model, and is trained for each PDU separately, and 2) two unified Random Forest regression models for predicting power at machine and PDU levels. The fleetwide scope of the unified models is achieved by explicitly adding hardware features related to machine platforms, networking, and cooling captured within power domains (PDUs). The pipeline, shown in Figure 2, consists of several components that:

DAILY MODELING PIPELINE

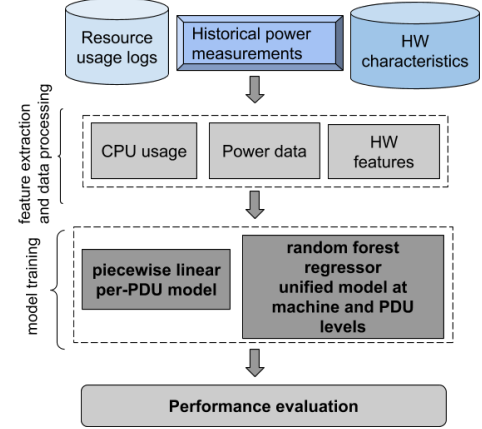

Fig. 2. Data processing and training pipeline.

- 1) read historical resource and power usage data at 5-minute granularity, as well as hardware characteristics of each machine/PDU,
- 2) process raw data to detect and remove outliers,
- 3) train models in a highly parallelized manner, and
- 4) evaluate performance of the models with rigorous validation procedures adapted to match the targeted use cases.

Before training the models, outliers in the collected historical data are detected and removed. These outliers mainly correspond to atypical regimes in resource usage and power measurements caused by rare maintenance events, anomalies, losses in stored data, etc. For example, rare and short losses in the stored usage data are handled using linear interpolation of the time series. Other heuristics applied to automatically detect and remove typical outliers include:

- Smoothing using Exponentially Weighted Moving Average (EWMA) in case of a significant (and hardly possible) change in resource usage, e.g., more than 30% from one 5-minute time interval to the next;
- Removing data instances for which changes in power measurements cannot physically match the corresponding change in resource usage from one 5-minute interval to the next. For example, data instances with $\Delta|\text{power usage}| > 20\Delta|\text{resource usage}|$ for any two consecutive 5-minute measurements are excluded. This type of anomaly is most likely caused by erroneous power meter readings;
- Filtering data instances with PDU’s power measurements smaller than 80% of its daily median. It is observed that these power drops are extremely rare and coincide with 1-2 hour-long maintenance events.

Finally, the models are trained on the filtered data set after removing the outliers. Also, the model training and validation use the actual power measurements collected for each PDU (from AC power meters) and machine (from DC machine power supply) across the datacenter fleet.

While a datacenter infrastructure planning and real-time workload management are typically driven by trends in workload resource usage (CPU, RAM, disk usage), the analysis in this paper demonstrates that PDU’s power consumption can be

accurately estimated using only its CPU usage as a resource usage feature. The general conclusion holds irrespective of the diversity in machine types, e.g., compute, storage, accelerators (TPU or GPU), etc. This might appear surprising for storage and accelerator machines where CPU usage is not the predominant driver of the power usage. However, storage machines are well known to have a narrow dynamic range of power [5]. In case of accelerators with weak CPU-power correlation, we also observed a narrow dynamic range. This narrow dynamic range results in a smaller impact on the power fluctuations when aggregated at PDU level. As it will be discussed in Section IV, our proposed models are able to estimate the aggregate power at PDU level accurately irrespective of the PDU’s diversity in machine types.

The following subsections discuss the two classes of power models.

A. Per-PDU’s power model

Extensive analysis of average 5-minute PDU’s power usage as a function of its average CPU usage aggregated across all of its machines indicates three distinct usage regimes (see Figure 3). More specifically, the higher the aggregated CPU usage, the higher the overall power consumption of the PDU.

Linear models are trained for *low*, *medium* and *high* CPU usage regimes, as defined below:

$$\begin{cases} \text{low,} & \text{if } \text{cpu_usage}_t^{\text{PDU}} \leq \text{cpu}_-^{\text{PDU}} + \text{seg_length} \\ \text{medium,} & \text{if } \text{cpu_usage}_t^{\text{PDU}} \in [\text{cpu}_-^{\text{PDU}} + \text{seg_length}, \\ & \text{cpu}_-^{\text{PDU}} + 2\text{seg_length}) \\ \text{high,} & \text{if } \text{cpu_usage}_t^{\text{PDU}} \geq \text{cpu}_+^{\text{PDU}} - \text{seg_length}. \end{cases}$$

PDU’s minimum and maximum CPU usage, i.e., $\text{cpu}_-^{\text{PDU}} \equiv \min_t\{\text{cpu_usage}_t^{\text{PDU}}\}$ and $\text{cpu}_+^{\text{PDU}} \equiv \max_t\{\text{cpu_usage}_t^{\text{PDU}}\}$ are measured historically. The three segments are also assumed to be of equal lengths, defined as $\text{seg_length} = \frac{\text{cpu}_+^{\text{PDU}} - \text{cpu}_-^{\text{PDU}}}{3}$. This assumption was made after carefully evaluating the data and observing a similar trend.

Each Per-PDU model is obtained by computing the parameters of the piecewise linear segments such that the weighted sum of squared errors is minimized. The impact of data batches is assigned based on their recency (i.e., higher weights are assigned to more recent data) to ensure proper adaption to systematic changes in the fleet (such as hardware upgrades and new deployments). In particular, the pipeline uses $\frac{1}{1+\text{days_ago}}$ to weigh data instances within $[\text{days_ago}, \text{days_ago}+1)$ from the training time. The Per-PDU models are trained and evaluated daily. The training pipeline uses the most recent 7 days of PDU’s power and CPU usage data. Also, Per-PDU model’s performance is evaluated daily using next day’s power/CPU usage data, which is discussed in more detail in Section IV.

It is observed that the Per-PDU model is able to adapt to sporadic changes in workload properties and hardware infrastructure. Typically, the coefficients of a Per-PDU model change very slowly in time, unless a PDU goes through upgrades, such as deploying or decommissioning machines or other equipment. In case of such upgrades, it is observed

that the model adapts to the changes in at most two days. The Per-PDU model implicitly incorporates effects from real-time scheduling and frequency scaling within a PDU, and is proved to be accurate in predicting near-term (e.g., day-ahead) power and energy usage of PDUs.

The piecewise linear model (including the second-order interaction terms between the features) in the context of machine and cluster level power estimation was previously proposed in [15], where the Multivariate Adaptive Regression Splines (MARS) [17] algorithm was used to automatically learn the regime switching points (called knots) and second-order interactions between the used features (mainly ~ 50 performance counters logged by the Windows operating system). Our proposed model, however, can simply rely on the three segments corresponding to low, medium, and high usage regimes, while achieving a desirable accuracy for the use cases of interest.

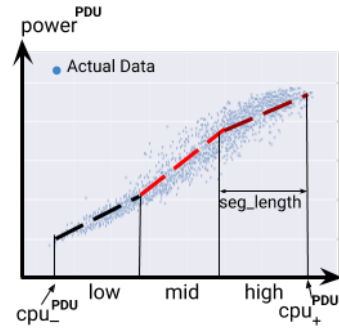

Fig. 3. Structure of the piecewise linear model.

B. Unified Machine and PDU Models

The Random Forest [18] is used to model nonlinear relationships between CPU usage/utilization, hardware characteristics, workload types, and power consumption of any machine (machine model) and PDU (PDU model) across Google’s fleet. Random Forest is a powerful regression model and has been widely used to learn nonlinear relationships between variables in various research areas (e.g. [19]). Specifically, Random Forest can handle high dimensional data, which may include both continuous and discrete variables. The abundance of power consumption and resource usage data for all machines and PDUs across Google’s datacenter fleet makes this class of models a good candidate for predicting power and energy consumption.

To train the Random Forest regressor, Sklearn [20] package is used with the default values for most of the hyperparameters, and the Mean Squared Error as the minimization objective. Hyperparameters such as number of trees, maximum tree depth and minimum number of samples in each leaf node are manually tuned so that the training and validation errors attain convergence with the selected number of samples and show no further improvement. We randomly select one week of data for training. Selecting any different set of training data, as long as it contains data instances across all CPU usage levels results in almost identical predictive performance. The following subsections discuss the two unified models, Unified Machine and PDU Models, in more detail.

1) Unified Machine Model

Unified Machine Model estimates power consumed by all machines deployed in a PDU, which are then added up to predict the PDU’s power. To predict machine level power consumption, the industry has been mainly using the approach in [3], which interpolates power usage based on a straight line connecting machine’s idle power (corresponding to 0 CPU usage) and maximum power (corresponding to the maximum CPU usage). The unified machine level model, however, learns the nonlinear relationship between power and CPU usage instead.

The training data instances include the following features:

- Machine configuration (*mc*): incorporates a detailed description of machine’s motherboard family, CPU type and size, memory quantity \times size, SSD quantity \times size, disk quantity \times size, etc. (e.g., Xeon machine with n_{CPU} CPUs, $n_{RAM} \times 32GB$ memory, and $n_{disk} \times 1TB$ disk). This information is modeled using one-hot encoded categorical features.
- Maximum (*mp*) and Idle (*ip*) powers: maximum and idle power usage of a machine with a given configuration.
- Dedicated label (*dl*): indicates if a machine is shared by various applications (i.e., workloads), or is dedicated for a specific purpose (e.g., Google search). This feature is one-hot encoded.
- CPU usage (*cpu_usage*): machine’s CPU usage.

The objective is to develop a mapping $f(\cdot)$ between the above-described features and machine’s power consumption, expressed as $\hat{p} = f(mc, mp, ip, dl, cpu_usage)$, where \hat{p} is the predicted power consumption.

To reduce the computational complexity of the training phase, we randomly sample 30000 5-minute data instances across all machines with a specific machine configuration and dedicated label from a randomly selected week of data. To make sure that the model accurately predicts power across the entire CPU usage regime, stratified sampling [21] is used, i.e., machine’s CPU utilization range is split into 10 equally spaced buckets, after which the data is sampled randomly from each bucket.

The total PDU’s machine power, say \hat{P}_{IT} , is obtained by summing up its machines’ power predictions, i.e.,

$$\hat{P}_{IT} = \sum_{i=1}^N \hat{p}_i = \sum_{i=1}^N f(mc_i, mp_i, ip_i, dl_i, cpu_usage_i),$$

where, \hat{p}_i is the predicted power consumption of i th machine and N is the total number of machines within the PDU. The total PDU’s power prediction, \hat{P}_{PDU} , is computed by adding power usage of its networking and cooling equipment, $\hat{P}_o = \hat{P}_{PDU} - \hat{P}_{IT}$, to the total estimated machines’ power \hat{P}_{IT} . Since \hat{P}_o exhibits small variations across time, and is significantly smaller than PDU’s total power consumption, it is estimated using its average measurement from the previous day.

For the rest of the paper, we will refer to this prediction as the Unified Machine Model’s prediction. The high accuracy of this model, as discussed in Section IV, is partially attributed to the large number (e.g., thousands) of machines in a typical PDU, whose prediction errors cancel out, reducing the overall PDU level prediction error.

2) Unified PDU Model

Unified PDU Model estimates PDU’s power consumption \hat{P}_{PDU} directly, using PDU level hardware and resource usage features:

- Total Idle Power (*IP*): sum of the idle powers across all machines in a PDU.
- Total Maximum Power (*MP*): sum of the maximum powers across all machines in a PDU.
- Platform count per platform family (N_{F_i}): total number of machines per platform family. For example, all computing machines with Intel CPU belong to the platform family named Intel. Another category of machines is storage which, depending on the type of storage (e.g., SSD), has a few different platform families. Overall, there are 10 platform families across Google’s datacenter fleet, say F_1, \dots, F_{10} , with the corresponding number of machines within a given PDU denoted as $N_{F_1}, \dots, N_{F_{10}}$, which are used as features.
- CPU usage per platform family (*cpu_usage $_{F_i}$*): sum of CPU usage of all machines per platform family in a PDU, that is, $cpu_usage_{F_i} := \sum_{i \in F_i} cpu_usage_i, i = 1, \dots, 10$, are used as the resource usage features.
- Networking power (*NP*): Power drawn by the networking equipment within a PDU is not metered separately, and we use its maximum value as a proxy. A small dynamic range of network-related power consumption justifies the approximation (also previously observed in [3], [5]).
- Cooling power (*CP*): Similar to *NP*, maximum power drawn by the cooling equipment within a PDU is used as a proxy for its power.
- Power architecture (*PA*): Finally, a categorical feature is used to identify the type of each PDU’s power architecture from the three available types, and is one-hot encoded.

The objective is to develop a mapping $g(\cdot)$ between the above described features and PDU’s power consumption, expressed as

$$\hat{P}_{PDU} = g(IP, MP, \{N_{F_i}\}_{i=1}^{10}, \{cpu_usage_{F_i}\}_{i=1}^{10}, NP, CP, PA).$$

Here, \hat{P}_{PDU} is the estimated PDU’s power using the Unified PDU Model. The model is trained using 1 million instances of PDU level CPU and power usage measurements at 5-minute granularity, and across all PDUs within Google’s fleet.

Both unified models (Machine and PDU) are trained using the same week of data to provide a consistent baseline for models’ comparisons. The Unified PDU Model’s prediction accuracy significantly depends on the distribution of the platform family mix and CPU usage regimes captured by the training data. This will be discussed in more detail in Section IV-B1.

IV. PERFORMANCE EVALUATION THROUGH TARGETED USE CASES

The previously discussed power models are rigorously validated for all PDUs across Google’s datacenter fleet. The predictive performance of the models is analyzed while taking into consideration the use cases of interest:

- 1) near-term power estimation and, consequently, carbon accounting ([6], [7]);
- 2) near-term load shaping, which includes peak power shaving ([3]), load drop experiments (e.g., grid level demand response [8]), as well as carbon- and cost-aware load shifting ([6], [9], [10]);
- 3) long-term planning and rightsizing of future datacenter infrastructure, including upgrades and deployments.

For the majority of the use cases listed above, the main goal is to accurately predict PDU's power consumption as a function of its CPU usage (or utilization), hardware and workload properties. There are different performance metrics that could be used to quantify prediction's deviation from the actual power measurements. The metrics should provide a reasonable comparison across different PDUs regardless of their maximum power capacities. To that end, Mean Absolute Percent Error (MAPE) is chosen to evaluate performance of the power models, and is defined as

$$MAPE^{PDU}(d) = \frac{100}{T} \sum_{t=1}^{T=288} \frac{|predicted_t^{PDU} - actual_t^{PDU}|}{actual_t^{PDU}}, \quad (1)$$

where $T = 288$ equals to the number of 5-minute time intervals within day d . It should be noted that all the performance results in this section are computed using data instances outside of the training data set.

A. Use case #1: near-term power estimation

To test 5-minute power prediction accuracy across all PDUs fleetwide, the proposed models are trained with seven days of historical data, and their performance (as defined in (1)) is evaluated using the actual PDUs' resource and power usage, and other collected features from the next day.

To compare the performance across all 3 proposed models, a 2-step evaluation analysis is conducted: 1) For a randomly selected week, each PDU and model, average daily MAPE is computed as $\overline{MAPE}^{PDU} := \frac{1}{7} \sum_{d \in week} MAPE^{PDU}(d)$. Then,

as shown in Figure 4, we capture the fraction of the total number of PDUs with the average daily MAPE smaller than a given percent value; and 2) To test the uniformity of the evaluated performance across time, daily MAPEs are calculated across a year-long time horizon, i.e., $\{MAPE^{PDU}(d)\}_{d \in year}$. Both the Unified PDU and Unified Machine Models are inherently time invariant since their training data covers the full range of values of the features. On the other hand, to evaluate the temporal insensitivity of the Per-PDU model, 50th and 99th percentiles of daily MAPEs are computed. Similarly as before, we compute the fraction of PDUs with their daily MAPE median (50th percentile) and 99th percentile smaller than any given percentage value. As shown in Figure 5, the Per-PDU's overall performance exhibits some performance deviations across time.

As can be observed in Figure 4, all three models have similar performance, with MAPE smaller than 5% for more than 90% PDUs, and MAPE smaller than 10% for more than 99% of PDUs. The uniformly low MAPE across all models makes them good candidates for short-term estimation and forecasting

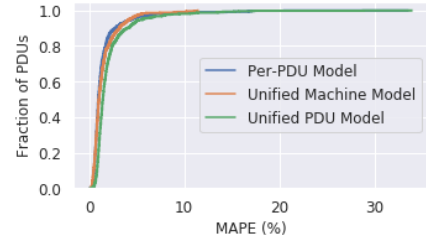

Fig. 4. Fraction of the total number of PDUs with average daily MAPE less than a given value.

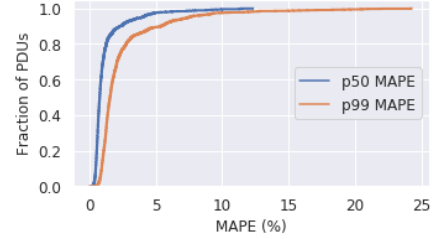

Fig. 5. Fraction of the total number of PDUs with the median and 99th percentile of daily Per-PDU's MAPEs less than a given value.

of PDUs's average power, which is then aggregated to obtain clusters' and campuses' power predictions.

The power estimates, in conjunction with the carbon intensity of the local grid, can be directly used for monitoring electricity-based carbon footprint of the datacenter. Furthermore, these models can be particularly useful when power measurements are delayed or power meters are broken. Note, however, that the sensitivity of the Unified PDU Model to its platform mix and CPU utilization, makes it less generalizable than the other two models.

B. Use case #2: load shaping

While the proposed models exhibit small performance differences in steady state, this is not any more the case if the goal is to use a datacenter compute load to (i) drop its power consumption and respond to grid level demand response events, or (ii) shape intraday datacenter power usage to reduce its peak or optimize for its daily electricity-based carbon footprint. The Per-PDU's piecewise linearity provides a suitable framework to evaluate the impact of changes in CPU usage on power usage, which can then be easily integrated into cost and carbon-aware optimizations designed to shape compute load by shifting computing tasks in time and space, across datacenter clusters ([8], [9],[10]).

Next, the proposed models are evaluated based on their ability to predict the variation in power consumption caused by significant changes in compute load. Then, we discuss the methodology and importance of accurate power modeling and its error characterization for controlling PDU's peak power consumption.

1) Power drop experiments

There are several applications in which the model's capability to accurately extrapolate power usage estimation outside the

previously seen regimes of compute load is critical. Examples of such applications are: 1) Risk-aware planning of large workload migration across different clusters; and 2) Significant, planned drops in compute load to respond to grid level demands. To evaluate the applicability of the proposed approaches to such scenarios, power drop experiments were conducted in 8 clusters spanning all types of power architectures across Google’s datacenter fleet. The planned usage drop was performed between 3:50 pm and 5:25 pm on a given day by progressively terminating non-critical tasks based on their priority (starting with the lowest priority). Performance of the proposed models was evaluated within the testing interval. Figure 6 shows an example of the actual power and CPU usage of an experimental PDU, along with the corresponding predictions of the three models.

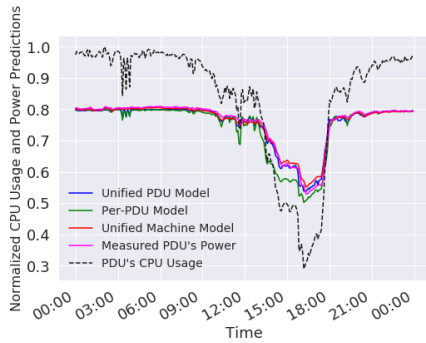

Fig. 6. Example of a significant load drop in one of the experimental PDUs.

To evaluate performance of the power models, average MAPE is computed across all PDUs within a given cluster and using the data instances within the testing interval, i.e., $\frac{\sum_{PDU \in cluster} MAPE^{PDU}(\text{testing interval})}{\# \text{ of PDUs in cluster}}$. The experimental results in Figure 7 demonstrate that the Unified Machine Model has the best predictive performance during the power drop events, with an average MAPE of less than 6% across all the test clusters. However, there are cases where the Per-PDU and Unified PDU models perform comparably well. Clusters 3 and 6 in Figure 6 are two examples where both the Per-PDU and Unified PDU models generate accurate predictions. This is not surprising given that the dropped, experimental, CPU usage is captured in the training data. There are, however, scenarios, where the Per-PDU model’s MAPE is less than 5% even when the low CPU usage regime is not present in its training data

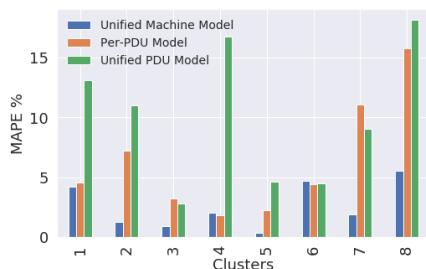

Fig. 7. Cluster level performance of the proposed models for eight experimental clusters during the planned power drop event.

(e.g., see clusters 1, 4 and 5 in Figure 6), which implies that the extrapolated, low-usage-regime segment of the Per-PDU model could still be an effective predictor of PDU’s power.

2) Power capping

As discussed in the Introduction, another benefit of accurate power models is software-controlled power capping, used to limit maximum power usage of a PDU by controlling its CPU usage. To achieve this goal in a risk-aware manner, characterizing model’s underprediction error (i.e., when predictions are lower than the actual power measurements) is critical to ensure that the target power usage threshold of a PDU is respected by properly setting its CPU usage limits. To that end, the worst (largest) 90-day underprediction percent error is computed daily across time instances that correspond to PDU’s high CPU utilization (and, therefore, high power utilization) regime:

$$WUPE^{PDU}(d) = 100 \cdot \max_{\substack{cpu_usage^{PDU}(t) \in high \\ t \in [d-1, d-90] \text{ days}}} \frac{(actual_t^{PDU} - predicted_t^{PDU})}{actual_t^{PDU}}. \quad (2)$$

To avoid tripping a PDU’s circuit breakers, the power capping system typically responds by throttling low priority compute tasks, which reduces CPU (and, thereby, power) usage of the PDU. Therefore, statistical properties of the underprediction error of the models can be used to define user-facing service level objectives (SLOs) of the power capping system. SLOs are designed to set user-perceived expectations during unexpected workload spikes and therefore, inevitable power capping events.

For each PDU, maximum $WUPE^{PDU}(\cdot)$ of a Per-PDU model is computed over a 5-month time horizon, i.e., $\max_{d \in 5 \text{ month horizon}} WUPE^{PDU}(d)$. The maximum of the worst underprediction errors across all PDUs are then used to obtain the fraction of the total number of PDUs with the corresponding maximums less than a given value. The analysis shows that for 99% of PDUs, the worst underprediction error is less than 9.3%. It is observed that larger underprediction errors in some PDUs typically happen due to the unpredicted machine upgrades, to which the Per-PDU model typically adjusts within 2-3 days.

C. Use case #3: rightsizing infrastructure upgrades

The structure and accuracy of the Unified Machine Model make it suitable for cost- and performance-aware infrastructure planning, commonly referred to as rightsizing. Typical planning scenarios require: 1) provisioning power consumption after deployments/decommissioning of machines, 2) analysis of the long-term impact of platform mix in a power domain on its power consumption, and 3) studying the effect of large workload migrations across a datacenter fleet on its power consumption. Such scenarios require long-term forecasting (monthly, quarterly, etc.), where PDU’s power and resource usage data are either unavailable, or the predicted operating regime is different from the historically observed pattern. Among the proposed models, the inherent nature of the Unified Machine Model makes it an ideal candidate for mapping long-term compute infrastructure plans and workload trends to power

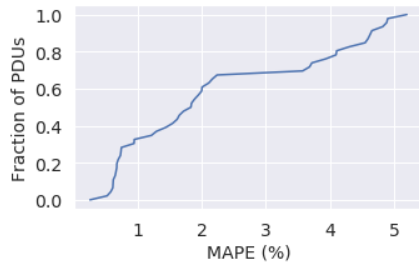

Fig. 8. Fraction of the hold-out PDUs with $MAPE^{PDU}$ smaller than a given percent error.

consumption forecasts. The Unified Machine Model estimates power consumption of a PDU by aggregating its machine level predictions, where machine level training instances capture the full dynamic range of CPU utilization (see Subsection III-B for more details). This enables the model to predict power consumption at various operating regimes with higher accuracy.

To evaluate Unified Machine Model’s performance in predicting power consumption of new (future) PDUs, 47 PDUs across all power architectures are randomly selected and removed from the training dataset. The Unified Machine Model is then retrained on the reduced training dataset, and used to predict PDU level power for each of the hold-out PDUs at 5-minute time granularity. The model is tested on a week of data outside the time period used in the training dataset. For each hold-out PDU, $MAPE^{PDU}$ is computed using all data instances within the test week/dataset. When averaged across all tested PDUs, the computed MAPE is 2.23%, while PDU level MAPEs are below 5% for the majority of the tested domains (see Figure 8). This is consistent with the prediction accuracy for PDUs included in the training dataset, and indicates the Unified Machine Model’s ability to provision power of unseen PDU configurations.

V. CONCLUDING REMARKS

In this paper, three statistical power models were proposed to predict power consumption of PDUs across Google’s datacenter fleet: 1) Per-PDU, which is a piecewise linear model with PDU’s CPU usage as its only feature; 2) Unified Machine Model; and 3) Unified PDU Model. The unified models are based on Random Forest regressors with a feature set consisting of: CPU usage/utilization, workload, and hardware characteristics of machines and PDUs. Common properties of the proposed models are their simplicity in design and very few predictive features. Extensive validations were conducted for all PDUs within Google’s fleet of hyperscale datacenters, and it was shown that the proposed models are able to effectively capture (i) the nonlinearity of PDU’s power consumption in its CPU usage, and (ii) the impact of hardware and workload characteristics on PDU’s power and energy consumption.

Simplicity, accuracy, portability, and dependence of the models on CPU usage as the sole resource usage feature, make them applicable to various decision-making scenarios that datacenter planners and compute providers face today.

Such decisions and planning include: reducing carbon footprint, reducing energy costs, increasing utilization of existing infrastructure, rightsizing future datacenter design, etc. Furthermore, the developed models enable building intelligent computing systems capable of shifting computing tasks in time and space, which is an effective way to reduce datacenter power peaks and electricity-based carbon footprint [7], [10].

REFERENCES

- [1] E. Masanet, A. Shehabi, N. Lei, S. Smith, and J. Koomey, “Recalibrating global data center energy-use estimates,” *Science*, vol. 367, no. 6481, pp. 984–986, 2020.
- [2] California Energy Commission. [Online]. Available: <https://ecdms.energy.ca.gov/elecbycounty.aspx>
- [3] X. Fan, W.-D. Weber, and L. A. Barroso, “Power provisioning for a warehouse-sized computer,” *ACM SIGARCH computer architecture news*, vol. 35, no. 2, pp. 13–23, 2007.
- [4] J. Choi, S. Govindan, B. Urgaonkar, and A. Sivasubramaniam, “Profiling, prediction, and capping of power consumption in consolidated environments,” in *2008 IEEE International Symposium on Modeling, Analysis and Simulation of Computers and Telecommunication Systems*. IEEE, 2008, pp. 1–10.
- [5] M. Dayarathna, Y. Wen, and R. Fan, “Data center energy consumption modeling: A survey,” *IEEE Communications Surveys & Tutorials*, vol. 18, no. 1, pp. 732–794, 2015.
- [6] Distributed Energy, “Data center demand response,” 2019. [Online]. Available: <https://www.distributedenergy.com/home/article/13036367/data-center-demand-response>
- [7] Green, ICT, “IEEE standard for a method to calculate near real-time emissions of information and communication technology infrastructure.”
- [8] Z. Liu, Y. Chen, C. Bash, A. Wierman, D. Gmach, Z. Wang, M. Marwah, and C. Hyser, “Renewable and cooling aware workload management for sustainable data centers,” *ACM SIGMETRICS Performance Evaluation Review*, vol. 40, no. 1, pp. 175–186, 2012.
- [9] X. Liu and F. Kong, “Datacenter power management in smart grids,” *Foundations and Trends in Electronic Design Automation*, vol. 9, no. 1, pp. 1–98, 2015.
- [10] A. Radovanovic, “Our data centers now work harder when the sun shines and wind blows,” 2020. [Online]. Available: <https://blog.google/inside-google/infrastructure/data-centers-work-harder-sun-shines-wind-blows>
- [11] Y. Chen, A. Das, W. Qin, A. Sivasubramaniam, Q. Wang, and N. Gautam, “Managing server energy and operational costs in hosting centers,” in *Proceedings of the 2005 ACM SIGMETRICS international conference on Measurement and modeling of computer systems*, 2005, pp. 303–314.
- [12] Y. Liu, G. Cox, Q. Deng, S. C. Draper, and R. Bianchini, “Fastcap: An efficient and fair algorithm for power capping in many-core systems,” in *2016 IEEE International Symposium on Performance Analysis of Systems and Software (ISPASS)*. IEEE, 2016, pp. 57–68.
- [13] S. Dev, D. Lo, L. Cheng, and P. Ranganathan, “Autonomous warehouse-scale computers,” in *Proceedings of DAC 2020*, accepted.
- [14] S. Rivoire, P. Ranganathan, and C. Kozyrakis, “A comparison of high-level full-system power models,” *HotPower*, vol. 8, no. 2, pp. 32–39, 2008.
- [15] J. D. Davis, S. Rivoire, M. Goldszmidt, and E. K. Ardestani, “No hardware required: building and validating composable highly accurate os-based power models,” *Microsoft Technical Report*, 2011.
- [16] L. A. Barroso, U. Hölzle, and P. Ranganathan, “The datacenter as a computer: Designing warehouse-scale machines,” *Synthesis Lectures on Computer Architecture*, vol. 13, no. 3, pp. i–189, 2018.
- [17] J. H. Friedman, “Multivariate adaptive regression splines,” *The annals of statistics*, pp. 1–67, 1991.
- [18] A. Liaw, M. Wiener *et al.*, “Classification and regression by randomforest,” *R news*, vol. 2, no. 3, pp. 18–22, 2002.
- [19] O. Mutanga, E. Adam, and M. A. Cho, “High density biomass estimation for wetland vegetation using worldview-2 imagery and random forest regression algorithm,” *International Journal of Applied Earth Observation and Geoinformation*, vol. 18, pp. 399–406, 2012.
- [20] “Scikit-learn: machine learning in python.” [Online]. Available: <https://scikit-learn.org/stable/>
- [21] J. Neyman, “On the two different aspects of the representative method: the method of stratified sampling and the method of purposive selection,” in *Breakthroughs in Statistics*. Springer, 1992, pp. 123–150.