

# Kochen-Specker Contextuality

Costantino Budroni,<sup>1,2,3,\*</sup> Adán Cabello,<sup>4,5</sup> Otfried Gühne,<sup>6</sup> Matthias Kleinmann,<sup>6</sup> and Jan-Åke Larsson<sup>7</sup>

<sup>1</sup>*Department of Physics 'E. Fermi' University of Pisa, Largo B. Pontecorvo 3, I-56127 Pisa, Italy*

<sup>2</sup>*Faculty of Physics, University of Vienna, Boltzmannngasse 5, 1090 Vienna, Austria*

<sup>3</sup>*Institute for Quantum Optics and Quantum Information (IQOQI), Austrian Academy of Sciences, Boltzmannngasse 3, 1090 Vienna, Austria*

<sup>4</sup>*Departamento de Física Aplicada II, Universidad de Sevilla, 41012 Sevilla, Spain*

<sup>5</sup>*Instituto Carlos I de Física Teórica y Computacional, Universidad de Sevilla, 41012 Sevilla, Spain*

<sup>6</sup>*Naturwissenschaftlich-Technische Fakultät, Universität Siegen, Walter-Flex-Straße 3, 57068 Siegen, Germany*

<sup>7</sup>*Institutionen för Systemteknik och Matematiska Institutionen, Linköpings Universitet, 58183 Linköping, Sweden*

(Dated: January 10, 2023)

A central result in the foundations of quantum mechanics is the Kochen-Specker theorem. In short, it states that quantum mechanics is in conflict with classical models in which the result of a measurement does not depend on which other compatible measurements are jointly performed. Here compatible measurements are those that can be implemented simultaneously or, more generally, those that are jointly measurable. This conflict is generically called quantum contextuality. In this review, an introduction to this subject and its current status is presented. Several proofs of the Kochen-Specker theorem and different notions of contextuality are reviewed. How to experimentally test some of these notions is explained and connections between contextuality and nonlocality or graph theory are discussed. Finally, some applications of contextuality in quantum information processing are reviewed.

## Contents

<b>I. Introduction</b>	2	5. Maximally noncontextual models	22
<b>II. Quantum contextuality in a nutshell</b>	3	D. Experimental realizations	24
A. A first example	3	1. Early experiments	24
B. A second look	3	2. A test of the Peres-Mermin inequality with trapped ions	24
<b>III. The Kochen-Specker theorem</b>	5	3. A test of the Peres-Mermin inequality with photons	26
A. Kochen-Specker sets	5	4. A test of the KCBS inequality with photons	26
B. Generalized Kochen-Specker-type arguments	8	5. Final considerations on KS contextuality experiments	26
1. The magic square and the magic pentagram	8	E. A different notion of contextuality: Spekkens's approach	28
2. Yu and Oh's set	8	1. Spekkens's definition of noncontextuality	28
C. A special instance of Gleason's theorem	9	2. Inequalities for Spekkens' noncontextuality	30
<b>IV. Contextuality as a property of nature</b>	10	3. Experimental tests of Spekkens' contextuality	30
A. Noncontextuality inequalities	10	4. Relation with different notions of hidden-variable models	31
1. Mathematical structure of noncontextual hidden-variable models	10	<b>V. Advanced topics and methods</b>	32
2. State-dependent contextuality	11	A. The noncontextuality polytope	32
3. State-independent contextuality	12	1. The simplest example	32
4. Logical and strong contextuality	12	2. Basics of convex polytopes, affine geometry, and linear programming	33
5. Other approaches to noncontextual hidden-variable models	13	3. Noncontextuality inequalities	33
B. Operational definitions and physical assumptions: ideal measurements	14	B. Graph theory and contextuality	35
1. Two perspectives: Observables and effects	14	1. Basic notions	35
2. Operational definitions of contexts: OP	15	2. Graphs, hypergraphs, and marginal scenarios	35
3. Operational definitions of contexts: EP	18	3. Exclusivity graphs and their independence, Lovász, and fractional packing numbers	37
C. Modeling experimental imperfections	19	4. The graph approach and the quest for a principle for quantum correlations	40
1. Quantifying disturbance in sequential measurements	19	5. Chromatic and fractional chromatic numbers	41
2. Context-independent time evolution	20	C. Connections between the Kochen-Specker and Bell's theorems	42
3. First proposals of experimentally testable inequalities	21	D. Classical simulation of quantum contextuality	43
4. Approximate quantum models	22	1. Simulation with Mealy machines	43
		2. Simulation with $\varepsilon$ transducers	44
		3. Other related results	45
		E. Resource theory of contextuality	46
		F. The so-called nullifications of the Kochen-Specker theorem	46
		1. Meyer's "nullification" of the KS theorem	47

\*Electronic address: [costantino.budroni@unipi.it](mailto:costantino.budroni@unipi.it)

2. Clifton and Kent's nullification of the KS theorem	47
<b>VI. Applications of quantum contextuality</b>	48
A. Contextuality and quantum computation	48
1. Contextuality and magic states	49
2. Contextuality and shallow quantum circuits	50
B. Contextuality and quantum cryptography	51
1. Svozil's quantum key distribution protocol	51
2. Contextuality offers device-independent security	51
C. Random number generation	52
D. Further applications	53
1. Zero-error channel capacities	53
2. Dimension witnesses	53
3. Self-testing	53
4. Applications of Spekkens' contextuality	54
5. Further applications on the horizon	55
<b>VII. Summary and outlook</b>	55
<b>Acknowledgments</b>	56
<b>A. Quantum contextuality from a historical perspective</b>	56
1. The problem of hidden variables	56
2. The Kochen-Specker theorem	57
3. The origin of the word contextuality	58
4. The relation between the KS and Bell theorems and the need for a theory-independent notion of noncontextuality	58
5. Noncontextuality for ideal measurements	59
6. The hidden history of noncontextuality inequalities	60
<b>References</b>	60

## I. INTRODUCTION

In the realm of classical physics, it is possible to consistently assume the existence of values for intrinsic properties (such as the length) of a physical object, and that nondeterministic measurement outcomes are caused by imperfect preparation or measurement procedures. Quantum theory fundamentally challenges such a point of view: It admits situations in which any assignment of a value to the result of the measurement of a physical property must depend on the *measurement context*, namely, on what other properties are simultaneously measured with it. Quantum contextuality then, as the name suggests, refers to the impossibility of such context-independent classical description of the predictions of quantum theory, which originated in the work of Specker (1960) and Kochen and Specker (1967).

Quantum contextuality is a phenomenon that combines many of the interesting aspects of quantum theory in a single framework, from *measurement incompatibility*, as the impossibility of performing simultaneous measurements of arbitrary observables, to *Bell nonlocality* and *entanglement*, when the system examined is composed of several spatially separated parts. The adopted perspective is that of observed statistics, which allows for an analysis of the experimental results that is independent of quantum mechanics. On the one hand, quantum contextuality generated an intense debate on the foundations of quantum mechanics and stimulated the search for

physical principles explaining why quantum theory is the way it is. On the other hand, the nonclassical properties of contextual correlations have been directly connected to quantum information processing applications such as quantum computation.

The central role of quantum contextuality in quantum theory, from both a fundamental and an applied perspective, is what provided motivation this review. The difficulty is that there is broad variety of perspectives from which to approach quantum contextuality, ranging from physics to mathematics, computer science, and philosophy, to mention a few, and consequently a vast literature. It is impossible to review all the literature and, at the same time, it would not be useful for the reader. We are thus forced to make a selection of topics to be presented. We decided to focus on *Kochen-Specker contextuality* (Kochen and Specker, 1967; Specker, 1960), which we often refer to simply as contextuality. A different notion of nonclassicality proposed in Spekkens (2005) is only briefly covered to highlight the differences with the notion of contextuality reviewed here.

Our goal with this review is to provide an introduction to contextuality that covers all the most important topics. In particular, we address the following questions:

- (a) What is the structure of noncontextual hidden-variable models?
- (b) What are the physical assumptions involved in the definition of contextuality and how to operationally define contexts?
- (c) How does one perform experimental tests? What are the assumptions, the loopholes, and the methods to deal with them?
- (d) What are the applications of quantum contextuality in quantum information processing?

These can be summarized as follows: What is quantum contextuality, how do we test it, what is it useful for, and what do we learn from it?

This review aims to reach a broad audience, from people with little or no experience with quantum contextuality, to experts working in the field, both on the theoretical and experimental side. As a consequence, it can be read in different ways and some parts can be skipped by readers with some experience in contextuality.

The content of this review can be outlined as follows. Section II contains a brief introduction to the basic concepts involved in quantum contextuality, such as compatible measurements, contexts and noncontextuality inequalities. Section III contains the statement and proof of the original Kochen-Specker theorem and further simplifications and related arguments. Section IV addresses the main question of this review: What is the mathematical structure of noncontextual hidden-variable theories, and how can we put these theories to test in an experiment? This includes questions such as the operational

identification of contexts, the problem involving imperfect experimental realizations, and experimental tests performed thus far. In Sec. V, we present a collection of advanced topics associated with quantum contextuality, from the definition of the noncontextuality polytope and the computation of noncontextuality inequalities, to the relations between contextuality and graph theory and the connection between quantum contextuality and Bell nonlocality. Finally, in Sec. VI information-theoretical applications of quantum contextuality, such as quantum computation and random number generation, are discussed. The Appendix A puts the results presented in the review into a historical perspective.

## II. QUANTUM CONTEXTUALITY IN A NUTSHELL

In this section, we explain the essence of the Kochen-Specker theorem and the modern view on Kochen-Specker contextuality. This is intended to be a simple explanation for introducing the topic to readers with little or no experience in the topic of quantum contextuality. Many of the subtleties and open problems, particularly those connected to the definition of contexts and compatible measurements, are discussed in more detail in the subsequent sections.

### A. A first example

Arguably the simplest example of Kochen-Specker contextuality, in which state preparation plays no role, is provided by the so-called Peres-Mermin (PM) square, (Mermin, 1990b, 1993; Peres, 1990, 1991, 1992, 1993) a construction of nine measurements arranged in a square:

$$\begin{bmatrix} A & B & C \\ a & b & c \\ \alpha & \beta & \gamma \end{bmatrix}. \quad (1)$$

Each measurement is dichotomic, i.e., it has only two possible outcomes, in this case labeled as +1 and -1. If we think in classical terms, there could be nine properties of an object and performing a measurement reveals whether the property is present (+1) or absent (-1).

In the following, it is assumed that the three measurements in each column and row form a ‘‘context,’’ i.e., a set of measurements whose values could in principle be jointly measured. We write  $ABC$  to denote the product of the values of the measurements  $A$ ,  $B$ , and  $C$  for a single object. Similarly we use  $abc$ ,  $Aa\alpha$ , etc. In a classical model describing the object, each of the nine measurements has a definite value, regardless of which context the measurement is contained in. Such a value assignment is then said to be *noncontextual*. Thus, for the set  $\{ABC, abc, \alpha\beta\gamma, Aa\alpha, Bb\beta, Cc\gamma\}$  there can be only an even number of products with the assigned value +1. This holds since assigning +1 to all measurements

gives six positive products and changing the value assigned to any measurement changes the value of two of the products, since each measurement appears in two of them.

Defining the expectation value

$$\langle ABC \rangle \equiv \text{Prob}[ABC = +1] - \text{Prob}[ABC = -1], \quad (2)$$

we have thus shown the validity of the inequality (Cabello, 2008)

$$\langle \text{PM} \rangle \equiv \langle ABC \rangle + \langle abc \rangle + \langle \alpha\beta\gamma \rangle + \langle Aa\alpha \rangle + \langle Bb\beta \rangle - \langle Cc\gamma \rangle \leq 4. \quad (3)$$

The significance of this inequality comes from the fact that it can be violated by a quantum system. The quantum example works for a system composed of two spin-1/2 particles. If we denote the Pauli operators  $\sigma_x$ ,  $\sigma_y$ , and  $\sigma_z$ , the observables are

$$\begin{bmatrix} A & B & C \\ a & b & c \\ \alpha & \beta & \gamma \end{bmatrix} = \begin{bmatrix} \sigma_z \otimes \mathbb{1} & \mathbb{1} \otimes \sigma_z & \sigma_z \otimes \sigma_z \\ \mathbb{1} \otimes \sigma_x & \sigma_x \otimes \mathbb{1} & \sigma_x \otimes \sigma_x \\ \sigma_z \otimes \sigma_x & \sigma_x \otimes \sigma_z & \sigma_y \otimes \sigma_y \end{bmatrix}. \quad (4)$$

Notice that the observables within one row or one column mutually commute, which allows one to simultaneously measure them and make sense of the expectation value for the product of outcomes, e.g.,  $ABC$ . One verifies that for a system in the state  $|\psi\rangle$ , such an expectation value is given by  $\langle ABC \rangle = \langle \psi | ABC | \psi \rangle$ . In fact, for the value of the terms in  $\langle \text{PM} \rangle$  the state  $|\psi\rangle$  does not play any role, since  $ABC = \mathbb{1}$  and we thus have  $\langle ABC \rangle = +1$ , and likewise for all products except  $Cc\gamma = -\mathbb{1}$ , which gives  $\langle Cc\gamma \rangle = -1$ . Summing these we obtain  $\langle \text{PM} \rangle = 6$  in clear contradiction to Eq. (3) (Cabello, 2008). Since we derived Eq. (3) under the assumption that it is possible to consistently assign a value to the nine observables of the object, the violation of Eq. (3) implies either that there is no value assignment or that the value-assignment must depend on which context the observable appears in. This phenomenon is known as *quantum contextuality*.

### B. A second look

At this point, we preview why quantum contextuality is a more subtle topic than it may seem from the argument presented thus far. As an entry point, one might wonder why we chose the particular form of the previously mentioned inequality instead of a simpler form like

$$\langle ABC \ abc \ \alpha\beta\gamma \ Aa\alpha \ Bb\beta \ Cc\gamma \rangle = +1. \quad (5)$$

The reason is that, in the quantum example, in order to violate inequality (3), we have to choose the observables in such a way that they are not all jointly measurable; i.e., they do not all mutually commute as in the rhs of Eq. (4). In such a case, according to quantum mechanics there is no measurement able to reveal the value of those observables on the same object consistently. For example, there is no common eigenstate of the previously defined observables  $A$  and  $b$ . Hence, to experimentally test

the expression in Eq. (5), one would need to perform a joint measurement of incompatible observables.

Another common misconception, associated with the particular realization of the PM square as two-qubit observables in Eq. (5), is that the measurements of each observable in the last row and last column can be performed as two single-qubit local measurements (with four outcomes) instead of a global (dichotomic) measurement. By doing so, however, one has in the last row a measurement of six incompatible single-qubit observables, which cannot form a context. The use of single-qubit measurements, therefore, is at variance with the assumption that the last row and last column form a context and hence removes the contradiction. Performing coherent global measurements on the two qubits can indeed be a crucial challenge in experiments, see also Sec. IV.D.

A third source of confusion, diametrically opposed to the previous one, is to consider the measurement of each row and column as a single global and fundamental measurement. In this view, one has six measurements, corresponding to the three rows and columns, that simulate the nine measurements  $A, \dots, \gamma$ . Each of these six global measurements has four outcomes, corresponding to the outcomes of the three simulated measurements under the constraint that their product equals  $+1$  (or  $-1$  for the last column). Thus, one may be surprised that none of the  $2^9$  joint assignments of outcomes to the measurements  $A, \dots, \gamma$  are logically possible. For the original formulation of the PM square, however, only the nine dichotomic measurements  $A, \dots, \gamma$  are fundamental entities and an evaluation of, for instance,  $\langle Cc\gamma \rangle$  entails a product of three numbers, which experimentally is by no means guaranteed to be  $-1$ , see also Fig. 11 in Sec. IV.D. Interpreting the PM square in terms of the six previously defined global measurements, however, possible in the framework of Spekkens contextuality (Krishna *et al.*, 2017), see also Section IV.E.

Finally, returning to the discussion after Eq. (5), we note that incompatibility does not immediately rule out a classical description: One can imagine a classical theory where values of all physical properties are simultaneously defined, but the classical measurement procedure of a property introduces some disturbance in the system and modifies the value of other physical properties. We revisit this problem in Sec. IV.

There is a price that we have to pay to see a violation of the inequality in Eq. (3): The current status of research is that it is impossible to conceive a quantum experiment featuring contextual behavior without additional assumptions. The basic reason is that we accepted that there are sets of observables the value of which cannot be revealed on the same object. But how can we ensure that a specific measurement in two different contexts does reveal the value of the same physical property?

This question brings us to the notion of compatibility. Intuitively, this corresponds to some notion of simultaneous measurability and nondisturbance among quantum measurements. In textbook quantum mechanics, an ob-

servable corresponds to an Hermitian operator, i.e.,  $A = A^\dagger$ , with outcomes identified with its eigenvalues, i.e.,  $A = \sum_i \lambda_i P_i$  and the spectral projections  $P_i$  identified with the measurement effects, i.e.,  $\text{Prob}(\lambda_i) = \text{tr}(\rho P_i)$ . Two observables  $A$  and  $B$  are said to be compatible if they commute, i.e.,  $[A, B] = 0$ . This type of measurements is called projective, ideal, or sharp, depending on which property one wants to emphasize. Commutativity is a strong property that implies several other properties for these measurements. In fact, if  $[A, B] = 0$ , then there is another observable  $C$  such that the spectral projections of  $A$  and  $B$  are a coarse graining of those of  $C$  and thus measuring  $C$  allows one to infer the result of both  $A$  and  $B$ , a property called *joint measurability*. At this point, we remark that joint measurability is the minimal requirement to define some notion of a context. Nevertheless, we highlight here some other properties of commuting projective measurements that will turn out to provide useful intuition for an operational definition of contexts presented in Sec. IV.B and used to deal with imperfect measurements in experimental tests of contextuality; See Sec. IV.C and Sec. IV.D). More precisely, notice that from the state-update rule  $\rho \mapsto P_i \rho P_i$ , one can see that, if  $[A, B] = 0$ , the outcomes of  $A$  are not disturbed by a subsequent measurement of  $B$  and are repeated by a later measurement of  $A$ , such as in the sequence  $ABA$ . This is the property of *outcome repeatability*. Conversely, projective measurements that satisfy one of the previously mentioned properties are necessarily commuting (Heinosaari and Wolf, 2010).

This is no longer true in the case of generalized measurements, which may be nonprojective (or, nonideal, unsharp). In this case, notions such as commutativity, nondisturbance, and joint measurability are no longer equivalent (Heinosaari and Wolf, 2010), and the term “incompatibility” usually denotes the lack of joint measurability (Heinosaari *et al.*, 2016). Different notions, corresponding to stronger or weaker assumptions, are also possible.

For the moment, we do not enter into this problem. Consider the case of ideal measurements, where these ambiguities do not arise and which were the focus of most contextuality arguments until recent times (such as all arguments based on the examples presented in Sec. III and IV.A). Notice, however, that in this case the conclusions of the tests of contextuality must take into account imperfections, and techniques hence need to be developed for analyzing the experimental data; see Sec. IV.C and IV.D).

A different notion of classicality for the case of non-ideal measurements is presented in Sec. IV.E, namely, Spekkens contextuality (Spekkens, 2005). We provide an account of Spekkens contextuality in Sec. IV.E in order to clarify the distinctions between his approach and the one presented here.

Finally, there are two other related research directions that introduce some notion of contextuality that we do not cover in this review. One was developed by

Grangier (2021), Auffèves and Grangier (2020); Auffèves and Grangier (2022) and the other was developed by Griffiths (2017, 2019, 2020). Despite the similar terminology and motivation, i.e., the analysis of Bell- and Kochen-Specker-type arguments and experiments, these approaches discuss a different notion of contextuality with respect to the one presented in this review. We refer the interested reader to the corresponding literature.

### III. THE KOCHEN-SPECKER THEOREM

This section is devoted to the Kochen-Specker theorem, which can be considered the starting point of the research in quantum contextuality. It states that non-contextual models conflict with quantum theory. Understanding this theorem, as well as the several variants presented in the following, is important for understanding quantum contextuality and the further developments in this research line.

#### A. Kochen-Specker sets

The example presented in Sec. II is based on the violation of an inequality that is satisfied by any noncontextual value assignment (or convex combinations thereof). This is a “modern” tool to witness quantum contextuality. In contrast, the original argument by Kochen and Specker (1967) was designed as a logical impossibility proof for value assignments. In the following, we explain the original argument and some of its simplifications.

The Kochen-Specker (KS) theorem (Kochen and Specker, 1967) deals with assignments of truth values to potential measurement results. In quantum mechanics, such measurement results are, for ideal measurements, described by projectors. Each projector defines a subspace of the Hilbert space, namely, the subspace that is left invariant under the action of the projector. If this subspace is one dimensional, then this subspace is a ray spanned by a single vector. The KS theorem can be seen as a statement about the impossibility of certain assignments to sets of vectors or, equivalently to sets of rank-1 projectors.

We first fix the framework for the theorem. In a  $d$ -dimensional Hilbert space  $\mathcal{H}$  consider  $d$  rank-1 projectors  $P_1, P_2, \dots, P_d$  associated with  $d$  orthogonal vectors in  $\mathcal{H}$ . They satisfy the following relations

$$(O) \quad P_i P_j = 0 \text{ for any } i \neq j \text{ (orthogonality).}$$

$$(C) \quad \sum_{i=1}^d P_i = \mathbb{1} \text{ or, equivalently, using (O),} \\ \prod_{i=1}^d (\mathbb{1} - P_i) = 0 \text{ (completeness).}$$

Such relations can be interpreted in terms of yes-no questions (or true-false propositions)  $Q_1, \dots, Q_d$  as follows:

$$(O') \quad Q_i \text{ and } Q_j \text{ are exclusive; i.e., they cannot be simultaneously “true” for } i \neq j.$$

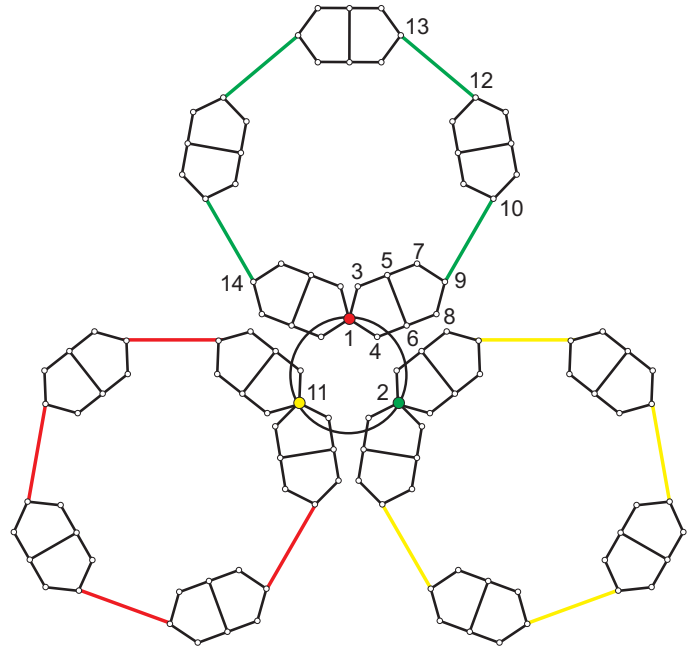

FIG. 1 The set in the original proof of KS has 117 vectors and 118 contexts. Each node represents a vector. Nodes in the same straight line or circumference represent mutually orthogonal vectors. The red node is orthogonal to all nodes connected to the red edge. We proceed similarly with the green and yellow nodes. A proof of the KS theorem can be obtained as follows. One of the nodes 1, 2 and 11 has to be true. The symmetry of the graph allows us to assume without loss of generality that it is node 1. Therefore, node 9 must be false, because of the “bug” subgraph (see Fig. 2) between node 1 and node 9. Thus, since nodes 2, 9, and 10 are mutually orthogonal and node 2 is connected to node 1, node 10 must be true. Applying the same argument, node 12 must be false and node 13 must be true since nodes 12, 13, and 2 form a basis. When this is repeated twice, node 14 must be true. However, nodes 1 and 14 cannot both be true. This concludes the proof. This figure improves the representation in the work of Kochen and Specker (1967), where the 117 vectors are represented by 120 nodes using two nodes each for 3 of the 117 vectors.

$$(C') \quad Q_1, \dots, Q_d \text{ cannot be simultaneously “false”; one of them has to be true.}$$

Note that while the relation (O') was already used by Kochen and Specker (1967), use of the name exclusive is modern, see Cabello *et al.* (2014) and Acín *et al.* (2015).

For an arbitrary set of rank-1 projectors in dimension  $d$ , only certain subsets may obey conditions (O) and (C) and, analogously, for an arbitrary set of propositions and a fixed  $d$ , certain subsets can be subject to conditions (O') and (C'). A set of  $d$  mutually exclusive propositions is a context. We use two different graphical representations for the relations (C'), (O') in a set of propositions, as in Figs. 1 and 2. In one representation, sets of mutually exclusive propositions are nodes in the same straight or smooth line; see Fig. 2 (a) as well as Figs. 1, 3, and 4. In the other representation in Fig. 2 (b), edges sim-

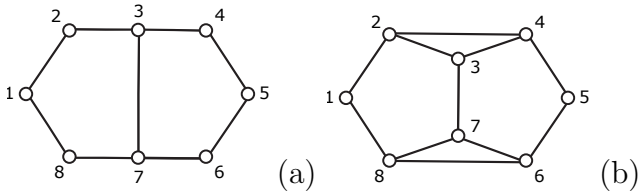

FIG. 2 Different representation of the same orthogonality relations. (a) Vectors are represented by nodes, contexts are represented by straight lines (or, more generally, by smooth lines). Three vectors in the same straight line are mutually orthogonal. This graph is also called a Greechie diagram; see Greechie (1971); (b) Vectors are represented by nodes and orthogonal vectors are connected by edges. In particular, triples of mutually orthogonal vectors form triangles, e.g., nodes 2, 3, and 4. An example of vectors realizing such relations is given by:  $v_1 = (1, -1, 1)$ ,  $v_2 = (1, 1, 0)$ ,  $v_3 = (0, 0, 1)$ ,  $v_4 = (1, -1, 0)$ ,  $v_5 = (1, 1, -1)$ ,  $v_6 = (1, 0, 1)$ ,  $v_7 = (0, 1, 0)$ ,  $v_8 = (1, 0, -1)$ . This graph is called the bug (Specker, 1999) and it has the property that, for  $d = 3$ , an assignment of true to node 1 implies a false assignment for node 5. In fact, if nodes 1 and 5 are both true, then nodes 2, 4, 6, and 8 must be false (they are connected), which implies nodes 3 and 7 are true (they are the remaining nodes of two triples), which gives a contradiction since nodes 3 and 7 are connected. As can be seen in Fig. 1, they are the building block of the original proof of the KS theorem.

ply connect exclusive propositions; see also Figs. 7 and 5. The constraints  $(\mathbf{O}')$  and  $(\mathbf{C}')$  can be translated into rules for coloring the vertices of the graph with two colors (e.g., green for true and red for false), namely, such that each two exclusive nodes cannot be both green, condition  $(\mathbf{O}')$ , and each set of  $d$  mutually exclusive propositions must contain a green node, condition  $(\mathbf{C}')$ ; see also Fig. 5. The problem of finding a coloring with two colors according to the previously stated rules is referred to as the *KS colorability problem* (Belinfante, 1973). We see in Sec. IV.A.5 how the conditions  $(\mathbf{O}')$  and  $(\mathbf{C}')$  can be relaxed in modern approaches to contextuality.

Kochen and Specker provided a physical interpretation of certain rank-1 projectors in  $d = 3$  as spin operators for a spin-1 particle. More precisely, the spin operator along one direction, say  $S_x$  along the direction  $x$  in the Euclidean three-dimensional space, has the eigenvalues  $-1, 0, +1$ . Hence, the operator  $S_x^2$  is a projector on the two-dimensional space corresponding to the eigenvalues  $\pm 1$ . Moreover, such spin operators have the property that for each triple of orthogonal directions, say  $x, y$ , and  $z$ , the operators commute, i.e.,  $[S_x^2, S_y^2] = [S_x^2, S_z^2] = [S_y^2, S_z^2] = 0$ . In this way, directions in the Euclidean space correspond to spin measurements and can be identified with directions in the Hilbert space. For a given direction  $\vec{v}$ , the one-dimensional projector  $P_{\vec{v}} = \mathbb{1} - S_{\vec{v}}^2$  can be interpreted as the measurement outcome 0 of a spin measurement in direction  $\vec{v}$ . For this reason, in the context of the KS theorem one often considers vectors  $\vec{v} \in \mathbb{R}^3$  in the place of rank-1 projectors  $P$  in a three-dimensional Hilbert space.

It is then straightforward to show that a joint measurement of the dichotomic observables  $P_{\vec{u}}, P_{\vec{v}}$ , and  $P_{\vec{w}}$  for three orthogonal vectors  $\vec{u}, \vec{v}$ , and  $\vec{w}$  can be obtained as a single trichotomic measurement having as effects precisely  $\{P_{\vec{u}}, P_{\vec{v}}, P_{\vec{w}}\}$ , i.e., a measurement in a given orthogonal basis. With the usual convention for truth assignments, i.e., 1 for true and 0 for false, the previously mentioned assignments can be formulated as a map from a (finite) set of vectors  $S \subset \mathbb{R}^3$  to 0 and 1 such that for any orthogonal basis contained in the set  $S$  one and only one of the vectors is mapped to the value 1. The set  $S$  consists of several bases, possibly with intersection; i.e., one vector may be part of several bases in  $S$ . Kochen and Specker then proved the following:

**Theorem. (Kochen-Specker, 1967)** There is a finite set  $S \subset \mathbb{R}^3$  such that there is no function  $f : S \rightarrow \{0, 1\}$  satisfying

$$f(\vec{u}) + f(\vec{v}) + f(\vec{w}) = 1 \quad (6)$$

for all triples  $(\vec{u}, \vec{v}, \vec{w})$  of mutually orthogonal vectors in  $S$ .

In general, a KS set  $\mathcal{S}$  in dimension  $d$  is defined as a set  $S$  of vectors in a  $d$ -dimensional Hilbert space, with the property that there is no map  $f : \mathcal{S} \rightarrow \{0, 1\}$  satisfying  $\sum_{|\psi\rangle \in \mathcal{B}} f(|\psi\rangle) = 1$ , for any subset  $\mathcal{B} \subset \mathcal{S}$  of  $d$  orthogonal vectors. Since any such set provides a proof of the KS theorem in dimension  $d$ , these sets are also called a “proof of the KS theorem.” That there is no KS set for  $d = 2$  follows from the fact that one can construct explicit noncontextual assignments for all projectors in  $\mathbb{C}^2$ ; see e.g., (Kochen and Specker, 1967).

The original proof of the KS theorem consists of a set of 117 vectors that realize the graph in Fig. 1 for which it is impossible to assign values true and false such that two adjacent nodes cannot be both true [condition  $(\mathbf{O}')$ ] and each set of three mutually exclusive nodes must contain a value true [condition  $(\mathbf{C}')$ ]. For any two vectors that are orthogonal but do not participate in a basis one can readily add a vector to complete the pair to a basis. This enlarges the 117 vectors to 192 vectors and those 192 vectors form then the set  $S$  in the KS theorem.

The original KS proof is long and complicated, given the high number of vectors necessary to obtain a contradiction. Some worked on the problem and simplified it by finding KS sets with an increasingly small number of vectors in different dimensions. For example, in dimension 3 (Alda, 1980; Belinfante, 1973; Bub, 1996; Conway and Kochen, 2000; de Obaldia *et al.*, 1988; Peres, 1991, 1993; Peres and Ron, 1988), in dimension 4 (Cabello *et al.*, 1996a; Kernaghan, 1994; Penrose, 2000; Peres, 1991; Zimba and Penrose, 1993), in dimension 6 (Lisoněk *et al.*, 2014), and in dimension 8 (Kernaghan and Peres, 1995; Toh, 2013a,b). Subsequent works have identified many other examples of KS sets in different dimensions (Aravind and Lee-Elkin, 1998; Arends *et al.*, 2011; Cabello, 1994; Gould and Aravind, 2010; Megill *et al.*, 2011;

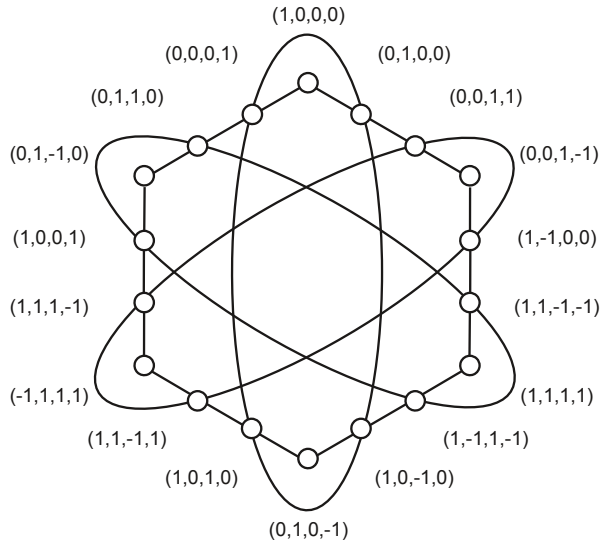

$v_{12} = (1, 0, 0, 0)$	$v_{16} = (0, 0, 1, \bar{1})$	$v_{17} = (0, 0, 1, 1)$	$v_{18} = (0, 1, 0, 0)$
$v_{12} = (1, 0, 0, 0)$	$v_{23} = (0, 1, \bar{1}, 0)$	$v_{28} = (0, 0, 0, 1)$	$v_{29} = (0, 1, 1, 0)$
$v_{23} = (0, 1, \bar{1}, 0)$	$v_{34} = (\bar{1}, 1, 1, 1)$	$v_{37} = (1, 1, 1, \bar{1})$	$v_{39} = (1, 0, 0, 1)$
$v_{34} = (\bar{1}, 1, 1, 1)$	$v_{45} = (0, 1, 0, \bar{1})$	$v_{47} = (1, 1, \bar{1}, 1)$	$v_{48} = (1, 0, 1, 0)$
$v_{45} = (0, 1, 0, \bar{1})$	$v_{56} = (1, 1, 1, 1)$	$v_{58} = (1, 0, \bar{1}, 0)$	$v_{59} = (1, \bar{1}, 1, \bar{1})$
$v_{16} = (0, 0, 1, \bar{1})$	$v_{56} = (1, 1, 1, 1)$	$v_{67} = (1, \bar{1}, 0, 0)$	$v_{69} = (1, 1, \bar{1}, \bar{1})$
$v_{17} = (0, 0, 1, 1)$	$v_{37} = (1, 1, 1, \bar{1})$	$v_{47} = (1, 1, \bar{1}, 1)$	$v_{67} = (1, \bar{1}, 0, 0)$
$v_{18} = (0, 1, 0, 0)$	$v_{28} = (0, 0, 0, 1)$	$v_{48} = (1, 0, 1, 0)$	$v_{58} = (1, 0, \bar{1}, 0)$
$v_{29} = (0, 1, 1, 0)$	$v_{39} = (1, 0, 0, 1)$	$v_{59} = (1, \bar{1}, 1, \bar{1})$	$v_{69} = (1, 1, \bar{1}, \bar{1})$

FIG. 3 Graphical representation of the 18-vector KS set by Cabello *et al.* (1996a). Each node represents a vector. For simplicity, vectors are unnormalized. Each smooth line, i.e., every straight line or ellipse, represents a context. Vectors in each context are mutually orthogonal. Each vector appears in exactly two contexts e.g.,  $v_{12}$  appears both in context 1 and 2, etc. As a consequence, by assigning a noncontextual “true” to some vectors, one obtains an even number of true, whereas one should get exactly nine true propositions, one for each context. Therefore, the set is not KS colorable. Notice that there are additional relations of orthogonality not shown in the graph and not used to prove the contradiction. Vectors are also listed in the table, where each row represent a context. For simplicity, we denote  $-1$  as  $\bar{1}$ .

Pavičić, 2006; Pavičić *et al.*, 2011, 2005; Ruuge, 2012; Waegell and Aravind, 2010, 2011a,b, 2012, 2013b, 2015, 2017; Waegell *et al.*, 2011). The method used by Kochen and Specker (1967) can be extended to construct KS sets in any dimension  $d > 3$  (Cabello and García-Alcaine, 1996). Other methods for obtaining KS sets in  $d > 3$  were proposed in Cabello *et al.* (2005); Matsumo (2007); Pavičić *et al.* (2005); Ruuge (2007); Zimba and Penrose (1993). KS sets with a continuum of vectors in dimension 3 were presented by Galindo (1975); Gill and Keane (1996). A way to further reduce the number of vectors was discussed by Cabello *et al.* (1996b).

The smallest KS set in terms of vectors is the 18-vector (nine-context) set in dimension 4 introduced by Cabello *et al.* (1996a) and shown in Fig. 3. A proof of the mini-

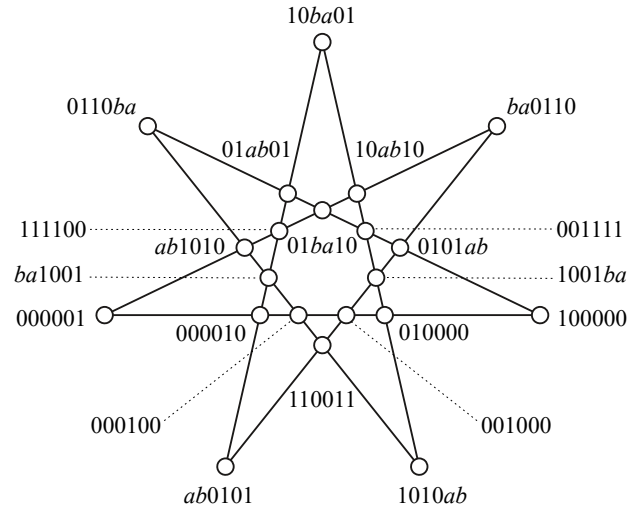

FIG. 4 Orthogonality relations between the vectors of the 21-vector, seven-context KS set given by Lisoněk *et al.* (2014). Vectors are represented by nodes and contexts by straight lines.  $1010ab$  denotes the vector  $(1, 0, 1, 0, a, b)$ , where  $a = e^{2\pi i/3}$  and  $b = a^2$ . For simplicity, normalization factors are omitted. Contexts contain mutually orthogonal vectors. The set has 21 vectors and each vector is in two contexts. To map one and only one of the vectors in each context to 1 and preserve the latter property, one would need to associate 1 with  $21/2$  vectors, which is not an integer. This makes the mapping impossible and proves that the set is a KS set.

mality was presented by Xu *et al.* (2020). The impossibility of an assignment satisfying the conditions (O) and (C) is proven by a parity argument: since there are nine contexts, one must assign true exactly nine times. However, this is not possible, since each vector appears in two contexts.

The smallest KS set known in terms of contexts is the 21-vector seven-context set in dimension 6 introduced by Lisoněk *et al.* (2014) and shown in Fig. 4. This KS set has also been proven to be the one with the smallest number of contexts, thereby, allowing for a symmetric parity proof of the KS theorem (Lisoněk *et al.*, 2014).

The first step in the proof in Kochen and Specker (1967) consists of identifying a set of eight vectors whose relations of orthogonality are represented by the eight-node graph in Fig. 5. Specker called this graph the bug (Specker, 1999). It has the peculiarity that, whenever  $A$  is true, then  $B$  must be false. This is at the basis of several KS-type contradictions, such as the ones by Stairs (1983) and Clifton (1993). They provide a realization of the bug as orthogonality relations of a set of rank-1 projectors  $P_A, \dots, P_B$  such that  $P_A = |\psi\rangle\langle\psi|$ , with  $\langle\psi|P_A|\psi\rangle = 1$  and  $\langle\psi|P_B|\psi\rangle > 0$ , which contradict the KS assignment rules; see Fig 2. The bug is the simplest example (Cabello *et al.*, 2018b) of other “true-implies-false” structures; see Cabello and García-Alcaine (1995). Hardy’s proof (Hardy, 1993) can be recast as a true-implies-false proof (Cabello *et al.*, 1996a) in which the initial truth corresponds to being in a particular entan-

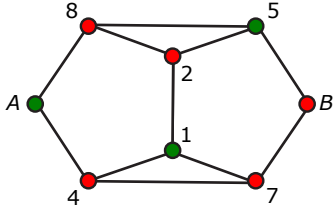

FIG. 5 Subgraph of the Yu-Oh graph given by the vertices  $\{A, B, 1, 2, 4, 5, 7, 8\}$ , corresponding to a basic block of the original KS graph (the bug), with a valid coloring, i.e., green=true, red=false. As discussed in Sec. III.A (Fig. 2),  $A$  and  $B$  must be exclusive events.

gled state. Similarly, one can construct proofs in which the initial and final propositions are product states (Cabello, 1997).

## B. Generalized Kochen-Specker-type arguments

A different approach to the Kochen-Specker contradiction has been undertaken using other types of algebraic relations instead of **(O)** and **(C)**. Important examples are the PM magic square (Mermin, 1990b, 1993; Peres, 1990), the Mermin magic pentagram, and the scenario of Yu and Oh (Bengtsson *et al.*, 2012; Kleinmann *et al.*, 2012; Yu and Oh, 2012).

### 1. The magic square and the magic pentagram

The PM square (Mermin, 1990b, 1993; Peres, 1990) introduced in Sec. II is a proof of the Kochen-Specker theorem even though it does not explicitly use a KS set of vectors. The difference resides in the fact that instead of imposing **(O)** and **(C)** relations on rank-1 projectors they impose analogous algebraic relations on  $\pm 1$  observables. Consider, again, the square of observables

$$\begin{bmatrix} A & B & C \\ a & b & c \\ \alpha & \beta & \gamma \end{bmatrix} = \begin{bmatrix} \sigma_z \otimes \mathbb{1} & \mathbb{1} \otimes \sigma_z & \sigma_z \otimes \sigma_z \\ \mathbb{1} \otimes \sigma_x & \sigma_x \otimes \mathbb{1} & \sigma_x \otimes \sigma_x \\ \sigma_z \otimes \sigma_x & \sigma_x \otimes \sigma_z & \sigma_y \otimes \sigma_y \end{bmatrix}. \quad (7)$$

Each row and column contains a set of commuting observables. In addition, we have the product of observables along the rows and column being  $+1$ , with the exception of the last column, where it is  $-1$ . The logical relations **(O')** and **(C')** are substituted here with the algebraic relations

$$\begin{aligned} v(A)v(B)v(C) &= v(a)v(b)v(c) = \\ &= \dots = -v(C)v(c)v(\gamma) = +1, \end{aligned} \quad (8)$$

where with  $v(A)$  we denoted the value  $\pm 1$  assigned to the measurements  $A$ , etc. It is then clear that Eq. (8) can never be satisfied, since it would imply

$$\begin{aligned} [v(A)v(B)v(C)][v(a)v(b)v(c)] \dots [v(C)v(c)v(\gamma)] \\ = 1 \times 1 \times \dots \times (-1) = -1. \end{aligned} \quad (9)$$

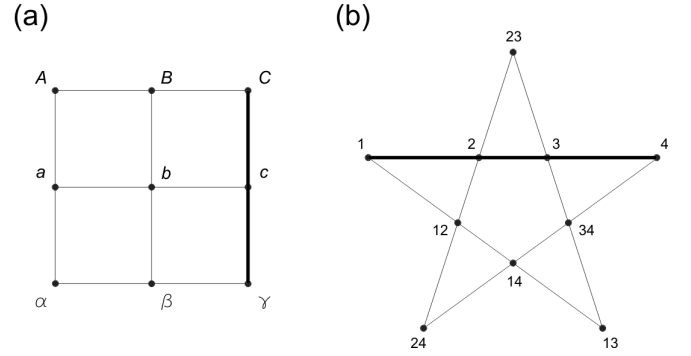

FIG. 6 (a) PM magic square and (b) Mermin's magic pentagram. Each dot represents an observable with possible outcome  $-1$  or  $1$ . Each line contains mutually compatible observables. For each line, the product of the corresponding observables is the identity, except for the bold lines, where it is minus the identity. A possible choice of observables satisfying the conditions in (a) is given in Eq. (7). A possible choice of observables satisfying the conditions in (b) is the following:  $O_1 = \sigma_z^{(1)} \otimes \sigma_x^{(2)} \otimes \sigma_x^{(3)}$ ,  $O_2 = \sigma_x^{(1)} \otimes \sigma_z^{(2)} \otimes \sigma_x^{(3)}$ ,  $O_3 = \sigma_x^{(1)} \otimes \sigma_x^{(2)} \otimes \sigma_z^{(3)}$ ,  $O_4 = \sigma_z^{(1)} \otimes \sigma_z^{(2)} \otimes \sigma_z^{(3)}$ ,  $O_{12} = \sigma_x^{(3)}$ ,  $O_{13} = \sigma_x^{(2)}$ ,  $O_{14} = \sigma_z^{(1)}$ ,  $O_{24} = \sigma_z^{(2)}$ , and  $O_{34} = \sigma_z^{(3)}$ .

But, on the other hand, as in Eq. (5),

$$\begin{aligned} v(A)v(B)v(C)v(a)v(b)v(c)v(\alpha)v(\beta)v(\gamma) \\ = v(A)^2v(B)^2v(C)^2 \dots v(\gamma)^2 = 1, \end{aligned} \quad (10)$$

which gives a contradiction. The magic square can be converted into a standard proof of the KS theorem with vectors (Peres, 1991).

There is a similar compact proof of the KS theorem with Pauli operators for three qubits found by Mermin (1990b, 1993). It is based on ten observables that can be arranged as shown in Fig. 6 (b), a construction that is sometimes called the magic pentagram.

The PM magic square and Mermin's magic pentagram have the minimum number of Pauli observables required for proving the KS theorem for two and three qubits, respectively. There are several similar proofs of the KS theorem with Pauli observables for more than three qubits (Planat, 2012, 2013; Saniga and Planat, 2012; Waegell, 2014; Waegell and Aravind, 2013a,b). A result by Arkhipov (2012) showed that all critical (i.e., the contradiction disappears by removing one observable) parity proofs (i.e., based on a parity argument, as described before, see Sec. III.A) of the KS theorem for more than three qubits with Pauli observables, where each observable is in exactly two contexts, can be reduced to the magic square or the magic pentagram. This is not true if each observable is in an even number of contexts larger than two (Trandafir *et al.*, 2022).

### 2. Yu and Oh's set

Yu and Oh's argument (Yu and Oh, 2012) does not provide a proof of the Kochen-Specker theorem. However, it



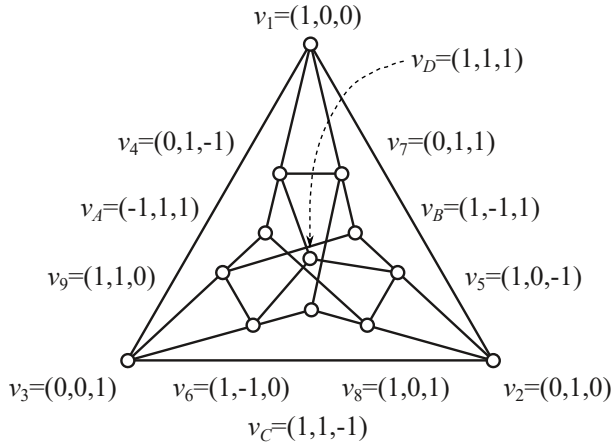

FIG. 7 Graph of orthogonality between the vectors of the Yu and Oh set (Yu and Oh, 2012). Adjacent nodes represent orthogonal vectors. For simplicity, vectors are unnormalized. See the text for further details.

fits in the more general framework of *state-independent contextuality* (SI-C)<sup>1</sup>, namely, it is a contextuality argument that depends not on the choice of a particular quantum state, but rather on the properties of the observables alone. Like KS proofs, Yu and Oh’s argument is based on a set of rank-1 projectors. However, contrary to KS proofs, the corresponding vectors admit a value assignment that is consistent with the conditions  $(\mathbf{O}')$  and  $(\mathbf{C}')$ . The contextuality argument arises from the fact that every probability distribution that is consistent with those assignments, i.e., that comes from a convex mixture of them, is in contradiction with the probabilities that can be obtained using the 13 projectors, for all quantum states.

The basic elements are 13 vectors in  $\mathbb{C}^3$ , listed in Fig. 7, and the corresponding set of projectors  $|v\rangle\langle v|$ . The orthogonality relations of such vectors are depicted in Fig. 7. The projectors associated with nodes  $A, B, C$ , and  $D$  sum up to a multiple of the identity, namely,

$$|v_A\rangle\langle v_A| + |v_B\rangle\langle v_B| + |v_C\rangle\langle v_C| + |v_D\rangle\langle v_D| = \frac{4}{3}\mathbb{1}. \quad (11)$$

Thus, for any quantum state the sum of their probabilities is  $4/3 > 1$ . On the other hand, the orthogonality relations among the vectors  $\{v_i\}$ , which correspond to the exclusivity of the respective propositions, imply that the propositions associated with nodes  $A, B, C$ , and  $D$  are also exclusive, i.e., they cannot be simultaneously true. This exclusivity implies that the sum of probabili-

ties  $\text{Prob}(A) + \text{Prob}(B) + \text{Prob}(C) + \text{Prob}(D) \leq 1$  in any noncontextual hidden-variable model.

This can be easily proven by identifying subgraphs containing two of the vertices  $\{A, B, C, D\}$  and two of the triangles  $\{1, 4, 7\}$ ,  $\{2, 5, 8\}$ ,  $\{3, 6, 9\}$  as the basic blocks of the original KS proof, i.e., the bug, depicted in Fig. 2; for instance, the subgraph  $\{A, B, 1, 2, 4, 5, 7, 8\}$  depicted in Fig. 5, implies that  $B$  and  $C$  are exclusive. By symmetry the same argument applies to any two vertices in  $\{A, B, C, D\}$ .

To summarize, even if the nodes  $A, B, C$ , and  $D$  are not connected in the graph in Fig. 7, their relations with other compatible elements imply that such elements correspond to exclusive propositions. Thus the sum of their probabilities is bounded by 1, whereas in quantum mechanics (QM) such a bound can be violated. We see in Sec. IV.A.3 how one can demonstrate this contradiction via a state-independent violation of a noncontextuality inequality. It has been proven that the Yu-Oh set is the SI-C set with the smallest number of vectors in any dimension (Cabello *et al.*, 2016b).

### C. A special instance of Gleason’s theorem

In the following, we outline the connection between Gleason’s theorem (Gleason, 1957) and the Kochen-Specker theorem. It is helpful to recall the result underlying Gleason’s theorem.

**Theorem.** (Gleason, 1957) Let  $f : S^2 \rightarrow \mathbb{R}$  be a non-negative function on the real sphere  $S^2 \subset \mathbb{R}^3$ , such that all orthonormal bases  $(\vec{u}, \vec{v}, \vec{w})$  in  $S^2$  obey

$$f(\vec{u}) + f(\vec{v}) + f(\vec{w}) = 1. \quad (12)$$

Thus, there is a positive semidefinite matrix  $R$  with  $\text{tr}(R) = 1$ , such that

$$f(\vec{v}) = \vec{v}^\top R \vec{v}. \quad (13)$$

It is evident that an assignment of values 0, 1 according to  $(\mathbf{O}')$  to all the orthonormal bases in  $\mathbb{C}^3$  satisfies the assumptions of the theorem; hence, it must be given by a density matrix, according to Eq. (13). On the other hand, there is no density matrix providing 0, 1 assignments to all orthonormal bases in  $\mathbb{R}^3$  (hence the contradiction (Kochen and Specker, 1967)). In contrast, Kochen and Specker obtain a contradiction using only a finite set of vectors.

A similar argument, connecting Gleason’s theorem to the impossibility of a noncontextual hidden-variable assignment, was provided by Bell (1966). He showed that given a function  $f$  satisfying Eq. (12), two vectors  $\vec{v}$  and  $\vec{w}$  such that  $f(\vec{v}) = 1$  and  $f(\vec{w}) = 0$  cannot be arbitrary close. This, in turn, is in contradiction to the possibility of assigning 0, 1 values to all orthonormal bases while obeying the rules in Eq. (12), since there would be arbitrary close pairs with different assignments. Such a minimal angle between vectors has been quantified as

<sup>1</sup> The acronym “SIC” could generate some confusion, as it is often used in the quantum foundations and information community to denote *symmetric informationally complete* sets. That is not the case here. Following the notation of Cabello *et al.* (2015), we use SI-C to denote state-independent contextuality and distinguish it from symmetric informationally complete.

$\tan^{-1}(1/2) \approx 0.464$ , and the argument was further refined by Mermin (1993), who noticed that the previous reasoning can be easily extended to an argument that uses only a finite set of vectors, such as the original KS argument.

#### IV. CONTEXTUALITY AS A PROPERTY OF NATURE

The Kochen-Specker theorem, originally presented as a logical impossibility proof, did not involve any statistical argument but rather was based on perfect assignments of 0 (false) or 1 (true) to a set of quantum propositions. This caused a debate on the role of finite precision measurements (see Sec. V.F) that also stimulated the development of statistical versions of the Kochen-Specker contradiction. The results of this effort were *noncontextuality inequalities*, which, under certain assumptions, are able to experimentally detect the phenomenon of quantum contextuality. In the following, we introduce the basic notions and open problems associated with noncontextuality inequalities and contextuality tests. We present the definition of noncontextual hidden variable models and noncontextuality inequalities in Sec. IV.A, the operational definition of contexts in Sec. IV.B, the problem of noise and imperfections in Sec. IV.C, and finally experimental tests of contextuality in Sec. IV.D. In Sec. IV.E, we review a different notion of contextuality introduced by Spekkens (2005).

##### A. Noncontextuality inequalities

Noncontextuality inequalities provide bounds obeyed by noncontextual hidden-variable models, in analogy to Bell inequalities that provide bounds for local-hidden variable models (Bell, 1964; Brunner *et al.*, 2014). The first proposals of Kochen-Specker-type inequalities were made by Simon *et al.* (2001) and Larsson (2002), but these require stronger assumptions than later noncontextuality inequalities (Cabello, 2008; Klyachko *et al.*, 2008), as we later discuss.

We start by introducing the mathematical formulation of noncontextual hidden variable models. We then discuss basic examples of noncontextuality inequalities such as the the Klyachko-Can-Binicioğlu-Shumovsky (KCBS) (Klyachko *et al.*, 2008) and the Yu-Oh inequalities (Yu and Oh, 2012), exhibiting, respectively, state-dependent and state-independent quantum violations. Finally, we compare these constructions with other related approaches to noncontextual hidden-variable models.

##### 1. Mathematical structure of noncontextual hidden-variable models

Different definitions of noncontextual hidden-variable (NCHV) models are present in the literature that despite

their substantial equivalence, use different terminology and different mathematical structures, from the marginal problem definition in the work of KCBS (Chaves and Fritz, 2012; Fritz and Chaves, 2013; Klyachko *et al.*, 2008), the equivalent definition of the noncontextuality polytope (Kleinmann *et al.*, 2012), to the sheaf-theoretical approach (Abramsky and Brandenburger, 2011), the graph-theoretical approach by Cabello *et al.* (2014), and the hypergraph-theoretical approach by Acín *et al.* (2015) (see also the book by Amaral and Terra Cunha, 2018). Here we adopt what we consider a minimal mathematical structure based on the noncontextuality polytope and the marginal problem characterization of NCHV. Further properties of NCHV models related to graphs and hypergraphs are discussed in Sec. V.

Given a set of observables  $\mathcal{G} = \{A_1, \dots, A_n\}$ , a collection of contexts is a subset  $\mathcal{M}$  of the power set of  $\mathcal{G}$ , i.e.,  $\mathcal{M} \subset 2^{\mathcal{G}}$ ;  $\mathcal{M}$  is sometimes called the *marginal scenario* (Chaves and Fritz, 2012). The idea behind this name is that the observed data from measurements in each context arise as a marginal of a global probability distribution on all observables. For each context  $\{A_i\}_{i \in \mathcal{C}} \in \mathcal{M}$ , i.e., with  $\mathcal{C} \subset \{1, \dots, n\}$ , we have a distribution  $p_{\mathcal{C}}$  of the outcomes over it. A necessary but not sufficient condition for the existence of a global distribution is for these marginals to be locally consistent. In other words, for each  $\mathcal{C}$  and  $\mathcal{C}'$  we have that

$$p_{\mathcal{C}|\mathcal{C} \cap \mathcal{C}'} = p_{\mathcal{C}'|\mathcal{C} \cap \mathcal{C}'}, \quad (14)$$

where  $|\mathcal{C} \cap \mathcal{C}'$  denotes the restriction of the distribution to observables in the intersection of the two contexts, obtained simply by marginalization, i.e., by summing over the variables not in  $\mathcal{C} \cap \mathcal{C}'$ . This consistency condition of the marginals is sometimes called the sheaf condition (Abramsky and Brandenburger, 2011) and, in Bell scenarios, it is equivalent to the nonsignaling condition of Popescu and Rohrlich (1994). In a contextuality scenario this condition on probability distributions has also been called *nondisturbance* (Ramanathan *et al.*, 2012).

In a NCHV model, we assume the existence of a hidden variable that determines the outcomes of each observable regardless of the context. For each context, given by the observables  $\{A_i\}_{i \in \mathcal{C}}$  and  $\mathcal{C} \subset \{1, \dots, n\}$  and the outcomes  $\{a_i\}_{i \in \mathcal{C}}$ , this corresponds to

$$p_{\mathcal{C}}(\{a_i\}_{i \in \mathcal{C}}) = \sum_{\lambda} p(\lambda) \prod_{i \in \mathcal{C}} p(a_i|\lambda), \quad (15)$$

with  $p(\lambda) \geq 0$ ,  $\sum_{\lambda} p(\lambda) = 1$ ,  $p(a_i|\lambda) \geq 0$ ,  $\sum_{a_i} p(a_i|\lambda) = 1$ , for  $i \in \mathcal{C}$ . Notice that the outcomes  $a_s$  are arbitrary at this level. In most cases, we consider either  $a_s \in \{0, 1\}$  or  $a_s \in \{-1, 1\}$ .

Equation (15) implies that each outcome depends only on the hidden variable  $\lambda$ , not on the specific context in which the observable is measured. Given the factorization properties of the distribution in Eq. (15), i.e., in the marginal problem approach, it can easily be proven that the response functions  $p(a_s|\lambda)$  that are not deterministic

(i.e.,  $\neq 0, 1$ ) can always be transformed into deterministic functions of a new hidden variable  $\lambda'$ . This is due to the fact that all probability measures on a finite set of events (finite set of measurements and outcomes) are a convex mixture of  $\{0, 1\}$ -valued measures, i.e., deterministic assignments. At the same time, using that  $\{0, 1\}$ -valued measures are multiplicative, i.e.,  $\delta(a_i, a_j) = \delta(a_i)\delta(a_j)$ , one finds that a global probability distribution over all variables, which can be written as a convex mixture of global deterministic assignments, factorizes in a way similar to Eq. (15).

By further developing this intuition, one can show that Eq. (15) is equivalent to the existence of a global probability distribution over all observables  $A_1, \dots, A_n$ , such that  $P(\{a_i\}_{i \in \mathcal{C}})$  is obtained by summing over all possible outcomes for the other observables, namely,

$$p_{\mathcal{C}}(\{a_i\}_{i \in \mathcal{C}}) = \sum_{a_s: s \notin \mathcal{C}} p_{\mathcal{G}}(a_1, \dots, a_n). \quad (16)$$

This general argument is known in the literature as Fine's theorem (Fine, 1982a), although Fine stated it only in the case of the Clauser, Horne, Shimony, and Holt (CHSH 1969) Bell scenario and a complete proof appeared as a straightforward corollary of the *theorem of common causes* by Suppes and Zanotti (1981), published one year earlier. Even though it must have been quite well known, as it was used more or less explicitly in several works on Bell inequalities (see, e.g., Froissart, 1981, the paragraph below Eq. (2)), a proof in the language of contextuality has appeared in the literature only relatively recently, in connection with the sheaf-theoretical framework of Abramsky and Brandenburger (2011).

Starting from the previously mentioned definition, noncontextuality inequalities can be derived with the same methods used for Bell inequalities, namely with the *correlation polytope* method (Pitowsky, 1989). Like Bell inequalities, noncontextuality inequalities are satisfied by NCHV models, and their violation by data collected in a quantum experiment demonstrates quantum contextuality. We discuss general methods to derive them in Sec. V.A.1 and Sec. V.A.2.

## 2. State-dependent contextuality

We can now proceed to discuss noncontextuality inequalities in the state-dependent scenario. The minimal dimension to witness contextuality is  $d = 3$  and the KCBS scenario (Klyachko *et al.*, 2008) is the simplest scenario where qutrits produce contextuality. The scenario is defined by five measurements  $A_0, \dots, A_4$ , with outcomes  $a_i \in \{-1, 1\}$  such that  $A_i$ , and  $A_{i+1}$ , with sum modulo 5, are compatible [i.e., they have a marginal scenario  $\mathcal{M} = \{(A_i, A_{i+1})\}_{i=0}^4$ ]; see Fig. 8. KCBS proposed the following inequality as being valid for NCHV models

$$\langle A_0 A_1 \rangle + \langle A_1 A_2 \rangle + \langle A_2 A_3 \rangle + \langle A_3 A_4 \rangle + \langle A_4 A_0 \rangle \geq -3, \quad (17)$$

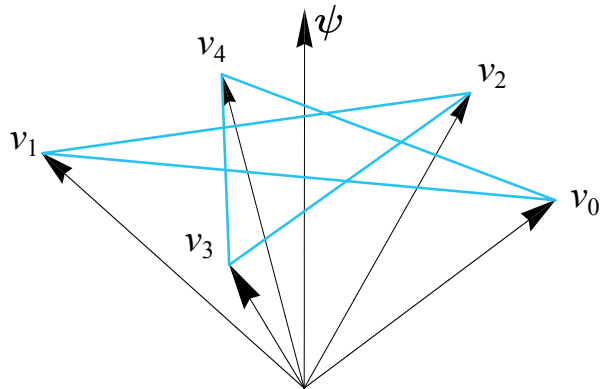

FIG. 8 The set of vectors  $v_j \in \mathbb{R}^3$  giving the dichotomic observables  $A_j = 2|v_j\rangle\langle v_j| - \mathbb{1}$  providing the maximum violation of the KCBS inequality form a regular pentagram, with orthogonal vectors connected by a blue line. The state  $\psi$  is directed along its symmetry axis. A realization is  $|\psi\rangle = (1, 0, 0)^\top$  and  $|v_k\rangle = (\cos \theta, \sin \theta \cos \varphi_k, \sin \theta \sin \varphi_k)^\top$ , with  $\cos \theta = 1/\sqrt[3]{5}$ ,  $\varphi_k = 2\pi k/5$ , and  $k = (2j + 1) \bmod 5$ .

where  $\langle A_i A_j \rangle := \sum_{a_i, a_j} a_i a_j p(a_i, a_j)$ . According to the discussion in Sec. IV.A.1 and by convexity arguments, the noncontextual bound  $-3$  can be proven by trying all possible  $\pm 1$  noncontextual assignments to the observables  $A_i$ . All other noncontextuality inequalities for this scenario can be obtained by relabeling the outcomes, i.e., by mapping  $A_i \mapsto -A_i$ . For instance, with the transformations  $A_1 \mapsto -A_1$  and  $A_3 \mapsto -A_3$ , we obtain the inequality

$$\langle A_0 A_1 \rangle + \langle A_1 A_2 \rangle + \langle A_2 A_3 \rangle + \langle A_3 A_4 \rangle - \langle A_4 A_0 \rangle \leq 3. \quad (18)$$

In contrast to Bell inequalities, here there is no bipartition of the set of observables such that every observable in one part is compatible with every observable of the other. Consequently, Eq. (17) cannot be interpreted as a Bell inequality: The measurements must be performed on a single system.

On a three-level system Eq. (17) can be violated up to  $5 - 4\sqrt{5} \approx -3.94$  with the state  $|\psi\rangle = (1, 0, 0)$  and measurement settings  $A_j = 2|v_j\rangle\langle v_j| - \mathbb{1}$  and  $|v_j\rangle = (\cos \theta, \sin \theta \cos[j\pi/5], \sin \theta \sin[j\pi/5])$  with  $\cos^2 \theta = \cos(\pi/5)/[1 + \cos(\pi/5)]$ , see Fig. 8. One can straightforwardly verify that  $\langle v_i | v_{i+1} \rangle = 0$  and, thus,  $[A_i, A_{i+1}] = 0$ , where the sum is  $\bmod 5$ . The KCBS inequality has been violated in several experiments, see Sec. IV.D for more details.

The KCBS inequality, together with the inequality by Clauser, Horne, Shimony, and Holt (CHSH 1969), is part of a general family of noncontextuality inequalities associated with compatibility structures forming an  $n$ -cycle, for  $n = 5$  and 4 respectively. As a result of Vorob'ev's theorem (Vorob'ev, 1962) (see also the discussion in Sec. V.B.2) cycles of length strictly greater than 3 are necessary to witness contextuality. Other types of cycles inequalities were investigated by Bengtsson (2009)

for  $n = 7$  and by Cabello *et al.* (2010) for arbitrary  $n$ . The general form of the KCBS-like inequality for odd cycles of length  $\geq 5$  was introduced by Cabello *et al.* (2010) and by Liang *et al.* (2011). The  $n$ -cycle inequalities were proven to be tight (see Sec. V.A for a formal definition) for any  $n$ -cycle contextuality scenario for  $n \geq 5$  by Araújo *et al.* (2013). The case  $n = 4$  (CHSH) was already proven by Fine (1982a). More generally, for even  $n$  with  $n > 4$ , the NC inequalities can also be interpreted as Bell inequalities, the *chained* inequalities (Braunstein and Caves, 1990), but they are not tight in the Bell scenario.

### 3. State-independent contextuality

State-independent contextuality is directly related to proofs of the KS theorem. In fact, Badziąg *et al.* (2009) proved that each KS set can be converted into an inequality showing SI-C, and Yu *et al.* (2015) developed a similar method for proofs of the KS theorem based on more general algebraic conditions, as is the case for the PM square.

Yu and Oh (2012) proved a stronger statement, which was already partially discussed here. They provided a set of projectors admitting a  $\{0, 1\}$ -assignment, according to the constraints  $(\mathbf{O}')$  and  $(\mathbf{C}')$ , but that nevertheless demonstrates SI-C. From the set of vectors  $\{|v_i\rangle\}_i$  listed in Fig. 7, one constructs the observables  $A_i \equiv 2|v_i\rangle\langle v_i| - \mathbb{1}$ . The compatibility relations among the observables  $A_i$  follow from the orthogonality relations of the corresponding vectors, and are again summarized in the graph in Fig. 7. Each pair of observables  $A_i A_j$  such that  $(i, j)$  is an edge of the graph is compatible. One can thus write the following NC inequality

$$\sum_i \langle A_i \rangle - \frac{1}{2} \sum_{\text{edges}} \langle A_i A_j \rangle \leq 8, \quad (19)$$

where the NCHV bound 8 is simply computed by trying all possible  $2^{13}$  noncontextual value assignments for  $\{A_i\}_i$ . However, using the vectors in Fig. 7 one can easily compute the quantum value for the operator

$$L = \sum_i A_i - \frac{1}{2} \sum_{\text{edges}} A_i A_j = \frac{25}{3} \mathbb{1}, \quad (20)$$

giving

$$\langle L \rangle_\rho = \frac{25}{3} > 8, \quad (21)$$

for any quantum state  $\rho$ . The inequality associated with the Yu-Oh set has been further improved to maximize the gap between NCHV and the quantum values (Kleinmann *et al.*, 2012).

Subsequently, several other SI-C sets that are not KS proofs have been proposed (Bengtsson *et al.*, 2012; Xu *et al.*, 2015) and a systematic construction of

state-independent contextuality inequality based on anti-distinguishable sets of vectors was proposed by Leifer and Duarte (2020). Graph-theoretical methods allow for an exhaustive search of SI-C sets (Cabello *et al.*, 2015, 2016b; Ramanathan and Horodecki, 2014) that is discussed in more detail in Sec. V.B.

### 4. Logical and strong contextuality

In the previous discussion, we distinguished between two types of statistical contextuality arguments: state dependent and state independent. A different classification has been proposed by Abramsky and Brandenburger (2011) was instead based on the existence of an extension of certain classical models and was independent of possible quantum violation of noncontextuality inequalities. More precisely, this classification adds to the standard notion of contextuality, two other stronger ones, namely, *logical contextuality* and *strong contextuality*. The notion of contextuality coincides with the one previously defined: the impossibility of a NCHV [see Eqs. (15) and (16)], namely, the impossibility of interpreting a given set of marginals in terms of a global distribution.

To define logical and strong contextuality, we need the notion of possibilistic collapse of a probability distribution: Given a probability distribution associated with a marginal scenario  $\mathcal{G}$ , we replace every nonzero entry by 1. In simple terms, a possibilistic collapse only distinguishes between possible (associated with 1) and impossible (associated with 0) events, without assigning a probability to them. Still, one is able to obtain contextuality for possibilistic models. A typical example of this type of contradiction was given by Hardy (1993), who obtained a contradiction between quantum predictions and local hidden-variable models by simply looking at possible and impossible events. Abramsky and Brandenburger (2011) defined this type of arguments *logical contextuality*, and showed that, in some sense, it is a stronger form of contextuality with respect to the standard one. In fact, the impossibility of a noncontextual description of a possibilistic assignment, in particular, implies the impossibility of a noncontextual description of the original probabilistic assignment; (see Abramsky and Brandenburger, 2011, Proposition 4.4.).

The possibilistic collapse of a distribution naturally introduces the notion of *support* of a distribution, namely, the possible events. Abramsky and Brandenburger (2011) defined *strong contextuality* as the impossibility of any deterministic assignment that is *consistent* with the support of a distribution. To be more precise, by *consistent* we mean that whenever an event is not in the support, we assign the value 0 to it, when it is in the support, we may assign 0 or 1. The simplest example of strong contextuality is given by the Popescu-Rohrlich (PR) box (Popescu and Rohrlich, 1994): a distribution between four variables  $A_1, A_2, B_1$ , and  $B_2$  in a Bell scenario, i.e., with contexts  $\{A_i, B_j\}$ , such that all pairs are

perfectly correlated except one that is perfectly anticorrelated, i.e.,  $\langle A_1 B_1 \rangle = \langle A_1 B_2 \rangle = \langle A_2 B_1 \rangle = -\langle A_2 B_2 \rangle = 1$ . A perfect correlation (anticorrelation) means that only the events for which  $a_i = b_j$  ( $a_i \neq b_j$ ) are in the support of the distribution. It is then clear that there is no deterministic assignment satisfying these constraints. PR-box correlations are beyond what is possible in quantum mechanics; however, for two parties with three or more settings and for three or more parties strong contextuality is possible with correlations realized in quantum mechanics. This is the case of Greenberger, Horne, and Zeilinger (GHZ 1989)-type arguments and more generally the so-called all-versus-nothing arguments (Cabello, 2001a, 2005; Mermin, 1990a).

Another notion, closely related but based on the convex structure of noncontextual models, is that of *maximal contextuality*. Any probabilistic model  $p$  satisfying the nondisturbance condition in Eq. (14) can be decomposed as

$$p = \alpha p_{\text{NC}} + (1 - \alpha) p_{\text{ND}} \quad (22)$$

for some  $0 \leq \alpha \leq 1$ , where  $p_{\text{NC}}$  is a noncontextual distribution whereas  $p_{\text{ND}}$  is a generic nondisturbing one; see Eq. (14). The maximal  $\alpha$  such that this decomposition exists is called the *noncontextual fraction* of  $p$  (Abramsky and Brandenburger, 2011; Amselem *et al.*, 2012), in analogy with the *local fraction* in Bell nonlocality (Elitzur *et al.*, 1992); see also Aolita *et al.* (2012); Barrett *et al.* (2006). To a maximal  $\alpha$ , i.e., the noncontextual fraction, it corresponds a minimal  $(1 - \alpha)$ , which is called the *contextual fraction*. A model is *maximally contextual* if  $\alpha = 0$ . Abramsky and Brandenburger (2011) showed that a probabilistic model is strongly contextual if and only if it is maximally contextual.

Note that a similar classification, based on Hardy-type (or “definite prediction sets”), GHZ-type (or “partially noncolorable sets”), and KS-type contextuality was introduced by Cabello and García-Alcaine (1996) and used by Xu *et al.* (2020). This hierarchy presents some analogies with the one by Abramsky and Brandenburger (2011). All these classifications, however, can be considered in some sense incomplete as they take into account only classical models and thus fail to recognize the importance of contextuality arguments such as the one by Yu and Oh (2012).

We see in Sec. V.A how the contextual fraction is connected to noncontextuality inequalities and the polytope description of noncontextual correlations. Moreover, its connection to the resource theory of contextuality and advantages in quantum computation are discussed in Secs. V.E and VI.A, respectively. Finally, we remark that the sheaf-theoretical approach of Abramsky and Brandenburger (2011) has inspired several lines of research connecting quantum contextuality to topological and algebraic topological methods (Abramsky *et al.*, 2015, 2012; Beer and Osborne, 2018; Carù, 2017; Okay and Raussendorf, 2020; Raussendorf, 2019).

## 5. Other approaches to noncontextual hidden-variable models

The previously discussed definitions represent the minimal requirements for a model where outcomes have a context-independent assignment. Closer to the original formulation of the KS theorem, one can add *exclusivity*, arising from the condition ( $\mathbf{O}'$ ), or *completeness*, arising from the condition ( $\mathbf{C}'$ ) in Sec. III.A. Noncontextuality inequalities derived using both these two assumptions were usually called *Kochen-Specker inequalities* by Larsson (2002), and a similar argument was presented by Simon *et al.* (2001). More recent results do not use these extra conditions but they often appear in parallel with a derivation of general NC inequalities as given by KCBS (Klyachko *et al.*, 2008) and Yu and Oh (2012), and in several subsequent works. It is thus worth mentioning such approaches to contextuality and emphasizing the difference and connection to the previously mentioned one.

A typical example is the following. Given a set of rank-1 projectors  $\{|v_i\rangle\langle v_i|\}_i$  in dimension  $d$ , the relations of compatibility (i.e., joint measurability) between the observables that they represent in quantum mechanics correspond to orthogonality relations; i.e.,  $\{|v_i\rangle\langle v_i|, \mathbb{1} - |v_i\rangle\langle v_i|\}$  is compatible with  $\{|v_j\rangle\langle v_j|, \mathbb{1} - |v_j\rangle\langle v_j|\}$  if and only if  $|\langle v_i | v_j \rangle| \in \{0, 1\}$ . If we denote  $a_i = 1, 0$  as the classical value associated with the positive operator valued measure (POVM)  $\{|v_i\rangle\langle v_i|, \mathbb{1} - |v_i\rangle\langle v_i|\}$  in the NCHV model, then the assumptions of exclusivity and completeness correspond, respectively, to  $p(a_i = a_j = 1 | \lambda) = 0$  whenever  $\langle v_i | v_j \rangle = 0$ , and to  $\sum_{i \in I} p(a_i = 1 | \lambda) = 1$  whenever  $\langle v_i | v_j \rangle = 0$  for all  $i, j \in I, i \neq j$  and  $\sum_{i \in I} |v_i\rangle\langle v_i| = \mathbb{1}$ .

Any inequality valid for a NCHV model is also valid for an NCHV model with the previously mentioned extra assumptions. Conversely, an inequality valid for a NCHV model with such extra assumptions can be transformed into an inequality valid for NCHV models with the extra assumptions by adding extra terms, as we discuss in the following for the case of the extra assumption of exclusivity. A similar argument can be constructed for the case in which the completeness condition ( $\mathbf{C}'$ ) is also assumed. However, this does not necessarily mean that the bound is preserved. An example was provided by Bengtsson *et al.* (2012), who presented a noncontextuality inequality with a bound of  $63/5$  under the assumption of noncontextuality, but only  $61/5$  if one adds the requirements of exclusivity and completeness.

By assuming exclusivity, we obtain an inequality of the form

$$\sum_{i \in I} \mu_i p(a_i = 1) \stackrel{\text{NCHV+E}}{\leq} \Omega, \quad (23)$$

with the superscript indicating that it holds when the extra exclusivity assumption is made. We can then add on the lhs pairwise correlation terms  $-\mu_{ij} p(a_i = 1, a_j = 1)$  with appropriately chosen weights  $\mu_{ij} \geq 0$ , such that the

total value of the expression decreases when the exclusivity condition is violated. For suitably chosen weights we have

$$\sum_{i \in \mathcal{I}} \mu_i p(a_i = 1) - \sum_{(i,j) \in \mathcal{I}'} \mu_{ij} p(a_i = 1, a_j = 1) \stackrel{\text{NCHV}}{\leq} \Omega, \quad (24)$$

making Eq. (24) valid also for general NCHV models.

It is straightforward to use this conversion in the KCBS inequality (Klyachko *et al.*, 2008)

$$\sum_{i=0}^4 p(a_i = 1) \stackrel{\text{NCHV+E}}{\leq} 2, \quad (25)$$

transforming it into an inequality valid for general NCHV models, namely

$$\begin{aligned} \sum_{i=0}^4 p(a_i = 1) - \sum_{i=0}^4 p(a_i = 1, a_{i+1} = 1) \\ = \sum_{i=0}^4 p(a_i = 1, a_{i+1} = -1) \stackrel{\text{NCHV}}{\leq} 2, \end{aligned} \quad (26)$$

where the sum in  $a_{i+1}$  is modulo 5 and we simplify the expression by using the marginal condition in Eq. (16). Not only does this transformation not change the classical bound, it also does not modify the quantum value obtained from the quantum observables  $A_j = 2|v_j\rangle\langle v_j| - \mathbb{1}$  discussed in Sec. IV.A.2, since it satisfies by construction  $\langle v_i | v_{i+1} \rangle = 0$  giving  $p(a_i = 1, a_{i+1} = 1) = 0$ . This idea was exploited in several works (Asadian *et al.*, 2015; Cabello *et al.*, 2015; Yu and Oh, 2012), and a completely general treatment of the problem was presented by Cabello (2016); Yu and Tong (2014). Experimental tests of contextuality are challenging, so it is useful to reduce the set of assumptions to an absolute minimum when designing such tests. Finally, a construction of further noncontextuality inequalities that use extra exclusivity assumptions can be obtained using the graph-theoretical approach to quantum contextuality; see Sec. V.B.

## B. Operational definitions and physical assumptions: ideal measurements

In the previous sections, an abstract notion of a context was enough to introduce the mathematical structures of NCHV models and the Kochen-Specker theorem; only some intuition on its physical meaning was provided. This is no longer sufficient when discussing possible experimental tests. In particular, the physical implications of a violation of a noncontextuality inequality actually depend on the physical assumptions at the basis of the chosen notions of context, the type of measurements considered, the details of their experimental implementation, etc. All these details must be verified to check their consistency with the notion of the NCHV

model one wants to test. Consider the CHSH inequality. If the measurements appearing in it are performed on distant particles, such that the input generation on one side and the outcome generation on the other side are spacelike separated events, then one can interpret its violation as a disproof of local hidden-variable models. In contrast, if the measurements are performed on the same system, the interpretation of the violation will have a different meaning, depending on the notion of context chosen. Are the measurements sharp? Are they commuting? These and similar questions must be addressed and their answers motivated by the terms of the actual experimental setup.

In the following, we address questions such as the following: What assumptions must be fulfilled by this implementation, in order to make an experiment a reasonable test of contextual behavior? What models can be disproved by such experiments? To achieve this, we proceed in two steps. First, we need an operational definition of contexts that allows us to identify them with certain experimental joint measurements. More precisely, we focus on the notion of disturbance for sequential measurements. This is done in the framework of ideal measurements, where properties such as perfect nondisturbance are achievable. Second, we extend the notion of noncontextuality to the case of nonideal measurements. We show in Sec. IV.C how this can be achieved via an explicit quantification of the disturbance.

### 1. Two perspectives: Observables and effects

To describe experimental realizations of contextuality tests, we adopt as much as possible a “black-box” description of the measurements. Such a description does not presuppose the validity of quantum mechanics, even though the design of the operations carried out to obtain the measurement results (such as which laser pulses to use in ion experiments and where to put beam splitters and polarizers in photonic experiments) may be motivated by a quantum mechanical description. Each measurement apparatus is seen as a box that takes as input a physical system in a certain state and return a classical output and, possibly, the physical system in a new state. We are not interested in the details of the functioning of the apparatus, however, we still need some physical assumptions on how to combine the different experimental apparatuses to observe joint probability distributions. In fact, a prerequisite for contextuality, in the sense of the previously derived inequalities, is the possibility of performing two or more measurements together, corresponding to nontrivial marginal scenarios.

Note that different notions of contextuality exist in the literature. To clarify the origin and relation between the different notions of contextuality, it is helpful to return to the original discussion by Kochen and Specker (1967). The starting point of their argument is that it is always possible to construct a hidden-variable model for a set

of observables, if such a theory does not need to satisfy functional relations among them. At the same time, they were dissatisfied by the impossibility proof by von Neumann (1931, 1932), which used linear relations among incompatible observables. In contrast, they chose an intermediate perspective inspired by Gleason’s approach (Gleason, 1957), where functional relations are assumed only among compatible measurements since they can be experimentally tested in a joint measurement. As a notion of compatibility, they define the notion of *commensurability*, meaning that the statistics of a set of observables  $\{A_i\}_i$  can be recovered as a function of a single measurement  $B$ . In particular, for ideal measurements, this notion was shown to be equivalent to pairwise commutativity (Kochen and Specker, 1967). Using more modern terminology, we may identify this idea with the notion of *joint measurability* (Busch *et al.*, 2014, 1996, 2016), which is valid for more general measurement. A generalized measurement is represented by a POVM: a collection of effect operators  $\{E_i\}_i$  such that  $E_i \geq 0$  and  $\sum_i E_i = \mathbb{1}$  with the computation of probabilities via  $\text{Prob}(i) = \text{tr}(\rho E_i)$ , and quantum instruments  $\{\mathcal{I}_i\}_i$  for the computation of the state-update rule, i.e.,  $\rho \mapsto \mathcal{I}_i(\rho)$ , where  $\mathcal{I}_i$  is a completely positive map. That is,  $\text{id}_{\mathbb{C}^k} \otimes \mathcal{I}_i$  is a positive map for each  $k$ , where  $\text{id}_{\mathbb{C}^k}$  is the identity map on the Hilbert space  $\mathbb{C}^k$ , and  $\sum_i \mathcal{I}_i$  is a trace-preserving map, i.e.,  $\text{tr}[\sum_i \mathcal{I}_i(\rho)] = \text{tr}(\rho)$  for all  $\rho \geq 0$ , also known as a quantum channel; see, e.g., Heinosaari and Ziman (2012) for an introduction. Two POVMs  $A$  and  $B$  with effects  $A_i$  and  $B_j$  are called *jointly measurable*, if there is a third POVM  $G$  with effects  $\{G_{ij}\}_{ij}$ , such that  $A_i = \sum_j G_{ij}$  and  $B_j = \sum_i G_{ij}$ . Equivalently, one can substitute the sum over one index with a more general classical postprocessing (Ali *et al.*, 2009). The equivalence between joint measurability and commutativity is no longer true for nonideal measurements, this point plays an important role in the discussion of experimental tests.

One may summarize here by saying that the basic elements of the KS theorem are dichotomic observables, i.e., the  $\{P_i\}_i$  of Sec. III.A with values  $\{0, 1\}$  or  $\{\text{false}, \text{true}\}$ , and contexts are defined as sets of commensurable observables. On the other hand, as discussed by Kochen and Specker (1967), the simplest way of performing a joint measurement of three observables, belonging to a context, is given by a single trichotomic measurement, where the three orthogonal projectors  $P_i, P_j$ , and  $P_k$  are interpreted as its effects. Thus, the KS theorem can equivalently be analyzed from the *observable perspective* (OP) or from the *effect perspective* (EP), namely,

OP The basic objects of contextuality are observables and their compatibility (joint-measurability) relations. A context is defined by a set of compatible observables. A noncontextual hidden-variable model is one that assigns values to each observable regardless of which joint measurement they appear in.

EP The basic objects of contextuality are effects and their relation of being part of the same generalized measurement. A context is defined by a single measurement. A noncontextual hidden-variable model is one that assigns values to each effect regardless of which measurement they appear in.

Note that this distinction between OP and EP has been introduced here to clarify and separate different ideas and different approaches to contextuality. In some older works on contextuality this distinction was not so sharp and the two perspectives were often interchanged. A typical example was given by (Klyachko *et al.*, 2008), who derived noncontextuality inequalities for both joint measurement and single effects. Moreover, we remark that OP should not be confused with the *Observable-based approach* discussed by Acín *et al.* (2015).

If one wants to pass from the scenario with idealized measurements to actual experimental tests the two perspectives present different challenges. Several questions arise, such as: What happens if the measurements are noisy? How can we operationally identify contexts in an experimental scenario? Possible ways of generalizing these two different perspectives to deal with actual experiments gave rise to different notions of contextuality. The OP is the the perspective we primarily consider in this review. The EP was the most common in the initial works on the KS theorem; see e.g., the discussion in Sec. III.A in terms of value assignments to triples of orthogonal vectors. In more recent times, (Spekkens, 2005, 2014) analyzed this approach to the Kochen-Specker theorem and contextuality, challenging the assumption of determinism and arguing against the possibility of applicability of such notions to unsharp measurements. Such ideas have led to, among other things, a definition of contextuality and an approach to contextuality tests unlike from the one presented thus far.

For completeness, we want to clarify the difference between OP, the most common alternative EP, and the Spekkens definition of contextuality in some detail. We discuss EP in Sec. IV.B.3. In particular, we discuss Spekkens’ criticism of the latter perspective. In Sec. IV.E, we provide a more detailed discussion of Spekkens’s approach to contextuality.

## 2. Operational definitions of contexts: OP

Given the two discussed perspectives, a natural question is how to translate such notions into experimental procedures in the lab. For instance, an observable can be identified with an experimental measurement procedure (such as a sequence of laser pulses and detection for an ion-trap experiment, or optical elements and detection for a photonic one) and an effect can be connected to the probability of a certain outcome in a measurement. How can we say that we implement the “same mathematical object” in “different experimental contexts”? The mathematical object in question is an observable in OP or an

effect in EP.

We start with OP. In this case, it is easy to identify the basic objects, i.e., the observables, whereas a harder task is to identify contexts and compatible observables. The minimal requirement for a context is to be given by a joint measurement. In fact, a large fraction of theoretical works on contextuality simply discuss joint measurements, without entering into the details of their experimental realization; see, e.g., [Abramsky and Brandenburger \(2011\)](#); [Acín \*et al.\* \(2015\)](#); [Cabello \*et al.\* \(2014\)](#). If one goes the lab and perform a test of contextuality, however, different options arise. A possible way to perform joint measurements is simply to perform the measurements in a sequence. This is the perspective adopted in several contextuality experiments ([Amselem \*et al.\*, 2009](#); [Kirchmair \*et al.\*, 2009](#); [Lapkiewicz \*et al.\*, 2011](#)), and the one we present in the following from a theoretical point of view. An analysis of such experiments and similar ones is presented in [Sec. IV.D](#). Other approaches that do not use sequential measurement are possible, including that of [Zhan \*et al.\* \(2017\)](#), which we review in the following.

In a sequential implementation of a joint measurement, it is clear how to identify the “same observable” in “different contexts”, since an observable is given by a specific set of measurement procedures (laser pulses, beam splitters, etc.). One simply has to repeat the same procedures in different sequences. What, then, are the joint measurements in a sequential implementation? The simple act of performing one measurement after the other is not enough to consider it a joint measurement. Intuitively, one would need some notion of nondisturbance, in the sense that the physical property revealed by a measurement  $B$  is not altered if  $A$  is measured first, and the same if the order is exchanged. This intuition is particularly clear when one considers a Bell scenario: the choice of measurement performed by one party (say, Alice) cannot have any influence on the measurement outcome of the other party (say, Bob) since these events are assumed to happen in spacelike separated regions. Special relativity guarantees that no “influence” or “disturbance” could propagate from one space-time region to the other. Bell nonlocality can be considered a particular form of contextuality where the assumption of context-independence is identified with the locality assumption; Alice’s outcome is independent of what measurement Bob is performing. One may relax such a constraint by assuming that two measurements are performed on two systems few meters apart in the same lab and still do not disturb each other, or even measurements on different degrees of freedom on the same system, etc. This motivates us to further develop this idea to identify contexts as sets of measurements that are in some sense nondisturbing, and to deal with experimental imperfection from this perspective, as we discuss in [Sec. IV.C](#). Similar ideas of classical hidden-variable models based on the notion of nondisturbance among measurements were developed by [Leggett and Garg in the category of \*macrorealist models\* \(Emary \*et al.\*, 2014; Leggett and Garg, 1985\)](#).

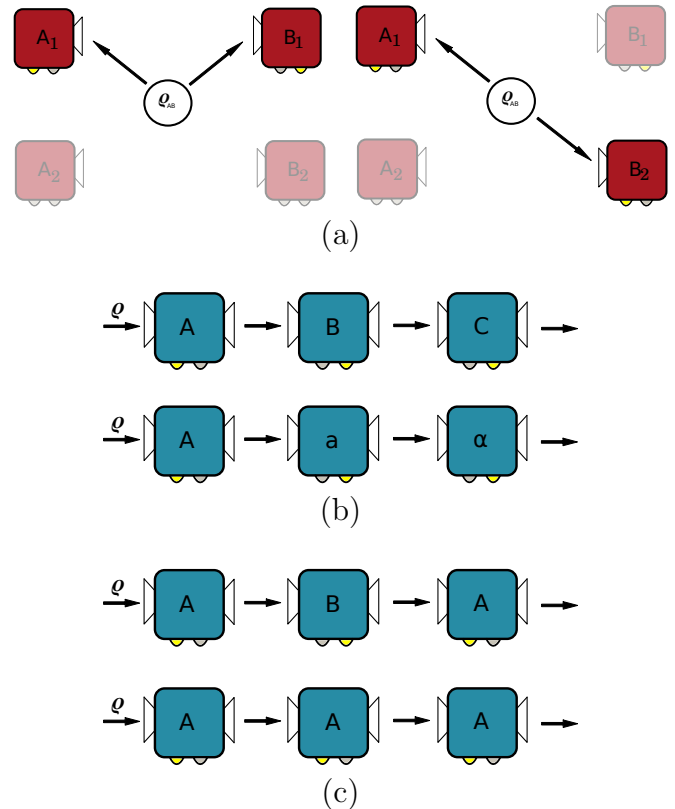

FIG. 9 Different experimental procedures in Bell and more general noncontextuality scenarios. (a) Two contexts in Bell scenario: The same measurement  $A_1$  is performed in two different contexts, either with  $B_1$  or with  $B_2$ . (b) Two contexts in the PM scenario: The measurement of  $A$  is performed in two contexts, either with  $B$  and  $C$  or with  $a$  and  $\alpha$ . As in the Bell scenario, the same measurement procedure, represented by the box with label  $A$ , is repeated in different contexts. (c) Additional measurements to quantify experimental imperfections. The measurement of  $A$  is repeated alone or together with  $B$ . Subsequent measurements of  $A$  must confirm the same outcome, represented by the yellow light on the bottom of the device.

Before defining a notion of nondisturbance, we clarify which type of measurements are relevant. A wide range of measurement are possible in quantum mechanics, from sharp measurement to the trivial POVM  $\{\mathbb{1}/2, \mathbb{1}/2\}$ , always giving one of two outcomes with equal probability. We want the observables to represent the measurement of a property rather than a random coin flip. A possible condition is that of *self-repeatability*: namely, if we perform the same measurement twice, we obtain the same outcome. This is a prerequisite for speaking about nondisturbance for single runs of an experiment. In fact, if the outcome changes randomly when repeating a measurement, as in the case of the previously mentioned trivial POVM, it does not make sense to speak about the outcome not being disturbed. Notice that this notion of disturbance for POVMs, which was introduced by [Heinosaari and Wolf \(2010\)](#) should not



be confused with the notion of disturbance at the level of the probability distributions [see Ramanathan *et al.* (2012)], which does not presuppose the sequential realization of the joint measurement. To better understand this point, we consider the notion of nondisturbance for quantum sequential measurements (Heinosaari and Wolf, 2010):  $A$  does not disturb  $B$ , if it is impossible to detect through a measurement of  $B$  whether or not  $A$  was measured (and its outcome discarded) before  $B$ . However, this property does not imply that  $A$  has no effect on  $B$ . For instance, imagine that we perform the sequence of measurements  $BAB$ . If we obtain the outcome  $+1$  for the first measurement of  $B$  and  $-1$  for the second, we may conclude that  $A$  “disturbed”  $B$ . This notion makes sense only if  $B$  is self-repeatable. A given set of observables  $\{A, B, C, \dots\}$  satisfy the *outcome repeatability* property if for any sequence of them, in any possible order and with each observable appearing multiple times, the outcome of their first appearance is always repeated in all subsequent measurements. Hence, in the sequential measurement implementation of joint measurements, a set of observables that satisfy outcome repeatability, and in addition the statistical nondisturbance conditions of Heinosaari and Wolf (2010) and their generalization to arbitrary sequences [see Uola *et al.* (2019)] is what we call a *context* (in OP).

The previous definition was inspired by the quantum mechanical notion of projective measurements. In fact, for projective measurements all properties capturing some idea of simultaneous measurability, i.e., joint measurability, nondisturbance, outcome repeatability, etc., are equivalent to the commutativity of observables. This notion is the basis of the NCHV models presented in Sec. IV.A.1, such as Eq. (15), since one requires the single outcomes, i.e., the corresponding deterministic response functions, not to be disturbed.

In summary, in OP, combined with the sequential realization of joint measurements, observables are given by experimental measurement procedures, contexts are defined by sequential measurements of outcome-repeatable observables, and each single-measurement procedure is repeated in an identical way in each sequence of measurements. The different steps in the realization of a contextuality test can be listed as follows

- S.1 Define experimental measurement procedures and associate with each one a classical random variable with the same values as the possible outcomes.
- S.2 Identify contexts in terms of outcome-repeatable and statistical-nondisturbing measurements.
- S.3 Perform measurements in different sequences, according to the defined contexts. For each measurement the same procedure is repeated in different contexts.
- S.4 Compare the observed statistics for contexts (sequences) with the one predicted using the NCHV for the corresponding classical variables.

This is the perspective explicitly adopted by Gühne *et al.* (2010); Kirchmair *et al.* (2009) and Larsson *et al.* (2011) among others. These steps are defined for ideal measurements. In actual experiments, the outcome repeatability property is never exactly satisfied due to unavoidable errors and imprecision in the experimental implementations. Nevertheless, having this theoretical framework in mind, one can devise practical methods to deal with experimental imperfections. In real experiments, then, we need an additional step

- S.5 Perform additional experimental runs to quantify deviations from ideal (outcome-repeatable and nondisturbing) measurements and compare them to the classical models accordingly.

See Fig. 9 for some examples of the different measurement procedures. The problem of quantifying deviations from ideal measurements and the comparison to the classical models is discussed in Sec. IV.C.

Before concluding this section, we comment on the possibility of simply using the notion of joint measurability, as in the original work by Kochen and Specker (1967), by extending it to nonideal measurements. Larsson *et al.* (2011) extensively argued in favor of using sequential measurements for contextuality tests. The main motivations can be summarized as follows. For joint measurement devices, a change of context corresponds to a physically entirely different setup even if one of the settings within the context remains unchanged. It is difficult to argue that the outcome of the unchanged setting is unchanged from physical principles, as already noted by Bell (1966, 1982); see also the discussion by Cabello (2009). In the previously outlined black-box scenario, one can always decide whether one performs a measurement alone or in sequence with other measurements. The existence of “contextless” devices, associated with the single-measurement setting and then combined in the sequential measurement setup, is then the argument for noncontextual behavior. In a sequential measurement one uses the same observables for which one wants to verify the contextual behavior. This allows for a direct identification of the single observables in each context and a change of the context occurs by substituting only some observables in the sequence. This is in contrast to the joint measurement scenario where the entire device changes and other means of identifying observables have to be applied. Still, it is possible to identify observables in a joint measurement, without sequential measurements, in terms of their statistics, namely, if they provide the same distribution of outcomes for any state preparation. This approach presents different challenges, such as making sense of the expression “for any state preparation”. Further details are provided later.

Finally, an argument against the use of joint measurability *alone* to define contexts for nonideal measurements can be formulated by applying a construction by Fritz (2012) to the contextuality scenario. Even though the original argument dealt with a different problem related

to nonlocality, one can straightforwardly adapt it to contextuality. We present the main idea in the following, by considering the CHSH scenario as a contextuality scenario. We denote the measurements effects as  $\{A_a^x\}$  and  $\{B_b^y\}$ , where  $a$  and  $b$  are the outputs and  $x$  and  $y$  are the measurement settings, and define contexts as set of jointly measurable observables. In the CHSH scenario, each context consists of a pair  $\{A^x, B^y\}$ . If we assume that contexts are defined by jointly measurable observables, this implies that there is a joint measurement  $G_{ab}^{xy}$  for each pair of settings  $x$  and  $y$ . The joint-measurability conditions amounts to

$$A_a^x = \sum_b G_{ab}^{xy}, \quad B_b^y = \sum_a G_{ab}^{xy}, \quad \text{for all } a, b, x, y. \quad (27)$$

Notice that such operators automatically give rise to a nonsignaling distribution  $p(ab|xy)$  (Popescu and Rohrlich, 1994): namely, it satisfies  $\sum_b p(ab|xy) = \sum_b p(ab|xy')$  for all  $a, x, y, y'$ , and  $\sum_a p(ab|xy) = \sum_a p(ab|x'y)$  for all  $b, x, x', y$ . On the other hand, for any given nonsignaling distribution  $\{p(ab|xy)\}_{abxy}$ , we can construct such joint measurements simply as

$$G_{ab}^{xy} := p(ab|xy)\mathbb{1}, \quad A_a^x := \sum_b G_{ab}^{xy}, \quad B_b^y := \sum_a G_{ab}^{xy}. \quad (28)$$

Since all operators are a multiple of the identity, one can simply take a one-dimensional Hilbert space. At the level of correlations, the conditions of nonsignaling precisely amounts to the condition of joint-measurability for one-dimensional quantum systems.

This construction implies that by defining contexts simply in terms of jointly measurable observables all nonsignaling correlations (Popescu and Rohrlich, 1994) can be obtained using one-dimensional quantum systems. The argument extends straightforwardly to any arbitrary contextuality scenario, where the counterparts of the nonsignaling correlations are the *nondisturbing* (Ramanathan *et al.*, 2012) or the *nonsignaling-in-time* (Kofler and Brukner, 2013) correlations. In other words, by defining contexts simply in terms of joint measurability, all maximally contextual correlations, defined as the extreme point of the *nondisturbing polytope* (Ramanathan *et al.*, 2012), can be reached using one-dimensional (and hence classical simulable) quantum systems.

Intuitively, this argument shows that when one uses too broad of a notion of contexts, i.e., joint-measurability alone, contextuality becomes a trivial property. This is the necessary conclusion if one adopts the definition of NCHV given in Sec. IV.A, where Fine's theorem allows any distribution to be decomposed in terms of deterministic ones. For a different perspective on the problem of trivial POVMs that does not necessarily support the previous conclusions, see Henson and Sainz (2015) and Kunjwal (2019).

This does not mean that the possibility of defining contexts through joint measurability and applying this

definition to experimental implementations has not been explored and that other approaches are not possible. For instance, the notion of joint measurability was used as a definition of context for nonideal measurements by Liang *et al.* (2011). Notice that Liang *et al.* (2011) discussed both the framework of Kochen-Specker contextuality and Spekkens contextuality. They avoid the problem of trivial POVMs by introducing a *sharpness parameter* and a consequent modification of noncontextual bounds for correlations. Observables proportional to the identity, as in the example of Eq. (28), are then maximally unsharp, and the modified bound of the considered noncontextuality inequality then becomes the algebraic maximum (Liang *et al.*, 2011). This approach was further investigated by Kunjwal (2015); Kunjwal and Ghosh (2014) and the corresponding inequality was experimentally tested by Zhan *et al.* (2017).

### 3. Operational definitions of contexts: EP

Different problems arise in the EP. Here, a context is easily identifiable operationally, as it consists simply of a single measurement. The difficult part is to identify the same effect in different measurements. A solution is an identification of effects based on the observed statistics. As an example, we can consider Spekkens's approach, first proposed in 2005 (Spekkens, 2005) and further clarified in 2014 (Spekkens, 2014), which was based on the notion of statistical indistinguishability. In simple terms, one identifies the effect associated with the outcome  $k$  of the measurement  $M$  with the effect associated with the outcome  $k'$  of the measurement  $M'$  if

$$p(k|P, M) = p(k'|P, M') \quad \text{for all preparations } P, \quad (29)$$

where  $p(k|P, M)$  denotes the probability of the outcome  $k$  of the measurement  $M$  given the preparation  $P$ . This idea of statistical identification of effects has appeared in the literature; see Fuchs (2002). Here, however, it is explicitly used to constrain possible hidden-variable models. If two effects have the same statistics, they must be represented by the same mathematical object in the hidden-variable model.

In this framework, a hidden-variable model, or an ontological model according to the terminology of Spekkens (2005) [see also the extensive discussion by Harrigan and Spekkens (2010)], describes the observed probabilities for a given preparation  $P$  and measurement  $M$  with an outcome  $k$  as

$$p(k|P, M) = \sum_{\lambda} \mu_P(\lambda) \xi_{M,k}(\lambda), \quad (30)$$

where  $\mu_P(\lambda)$  represents the probability distribution of the space of the hidden variable  $\lambda$  associated with the preparation  $P$ , satisfying  $\mu_P(\lambda) \geq 0$  and  $\sum_{\lambda} \mu_P(\lambda) = 1$ , and  $\xi_{M,k}(\lambda)$  represents the response function associated with the outcome  $k$  of the measurement  $M$ , satisfying

$\xi_{M,k}(\lambda) \geq 0$  and  $\sum_k \xi_{M,k}(\lambda) = 1$  for all  $\lambda$ . Noncontextuality, then, amounts to the assumption that  $\xi_{M,k} = \xi_{M',k'}$  if the condition (29) is satisfied. One can then compare these assumptions with the usual assumptions of Kochen-Specker theorem (Kunjwal and Spekkens, 2015; Leifer and Maroney, 2013; Spekkens, 2005).

We saw in Sec. IV.A.1 [Eq. (15)] that the nondeterministic response functions can always be transformed into deterministic ones by extending the space of the hidden variable. However, if one assumes that two effects with the same statistics are represented by the same object in the hidden-variable model, one can no longer transform the nondeterministic response functions  $\xi_{M,k}(\lambda)$  into deterministic ones, if the measurement is not sharp. A proof of this fact was given by Spekkens (2014). The intuition at the basis of the proof could be summarized as follows. For a given effect  $E$  of an unsharp measurement, take its spectral decomposition  $\sum_i \lambda_i \Pi_i$ , which has all eigenvalues in  $[0, 1]$ . The projectors  $\{\Pi_i\}_i$  then constitute a projective measurement that gives  $E$  via some postprocessing. Since  $E$  is statistically indistinguishable from the previously constructed postprocessing of a projective measurement, the corresponding response functions in the ontological model must be identical. Hence, the response function associated with  $E$  must also arise from the same postprocessing; i.e., they are not deterministic.

This observation together with the practical impossibility of obtaining perfect projective measurements in actual experimental implementations led to the development of a different notion of noncontextuality inequalities (Krishna *et al.*, 2017; Kunjwal and Spekkens, 2015, 2018; Mazurek *et al.*, 2016; Pusey, 2018; Schmid *et al.*, 2018; Spekkens *et al.*, 2009; Xu *et al.*, 2016) based on the identification of measurement effects according to Eq. (29) and an analogous notion for preparations called preparation noncontextuality (Spekkens, 2005). We review the approach based on the latter perspective in Sec. IV.E.

### C. Modeling experimental imperfections

Starting from the operational definition of contexts and compatibility provided Sec. IV.B.2 for ideal projective measurements, we further develop these ideas in order to deal with imperfect and noisy measurements typical of any experimental implementation of a contextuality test. We emphasize that there is no general recipe that can be applied to all experiments. On the contrary, for every experimental realization it is necessary to make some assumptions on the hidden-variable model describing the type of noise present. Typically, it is necessary to perform additional measurements to quantify the amount of noise and check its consistency with the previously mentioned assumptions, and possibly to modify the noncontextuality inequality accordingly. Several approaches have been proposed and implemented in experimental tests of con-

textuality. In the following, we discuss the theoretical work presented by Gühne *et al.* (2010); Kirchmair *et al.* (2009), by Szangolies (2015); Szangolies *et al.* (2013), and by Kujala *et al.* (2015); Larsson (2002); Simon *et al.* (2001); Winter (2014).

#### 1. Quantifying disturbance in sequential measurements

To deal with actual experiments, we need to relax the assumption of perfectly compatible measurements by admitting measurements that produce a (certain type of) disturbance on subsequent measurements, and then trying to quantify such a disturbance. This was the approach proposed by Kirchmair *et al.* (2009) and further developed by Gühne *et al.* (2010); we mostly follow the latter. Such an approach can be summarized as follows. Probabilities associated to perfectly compatible measurements are still described by NCHV models; however, we admit the possibility of incompatible measurements that introduce disturbance and change the outcomes of subsequent measurements in a sequence, giving rise to context-dependent outcomes. The amount of disturbance is then estimated experimentally, under the physical assumption that the amount of noise introduced by the measurements is cumulative; i.e., it does not cancel out by performing more measurements.

To keep the notation simple, we consider only the case of  $\pm 1$ -valued observables, a generalization to arbitrary (finite) outcomes is straightforward. Consider a hidden-variable model describing the probabilities for all possible sequences  $\mathcal{S}_{AB} = \{A, B, AA, AB, BA, BB, AAA, \dots\}$  of two  $\pm 1$ -valued observables  $A$  and  $B$ . We denote the outcome probabilities for single measurements as  $p[\pm|A], p[\pm|B]$  and, similarly, for sequences  $p[\pm \pm |AA], p[\pm \pm |AB], \dots$  for, respectively, measurement of the sequence  $AA$  and  $AB$ , where the temporal ordering of the sequence is from left to right. We admit the possibility of a discarded outcome such as  $p[+ \bullet - |BAB]$ , which denotes the probability for the outcomes  $+$  for the first measurement of  $B$ , a discarded outcome ( $\bullet$ ) for the measurement of  $A$  and  $-$  for the final measurement of  $B$ .

As anticipated, our model departs from the NCHV model discussed in Sec. IV.A.1. If  $A$  and  $B$  are compatible observables, it must necessarily be that  $p[+ \bullet - |BAB] = 0$ , as it follows immediately from Eq. (15). Consider now the case where  $A$  and  $B$  are not compatible. Terms that are not experimentally accessible are still well defined in this model, such as  $p[(+|A) \& (+|B)]$ , namely, the probability that the first measurement gives the outcome  $+1$ , in the case both of a measurement of  $A$  and of a measurement of  $B$ . However, the outcome probability  $p[+ + |AB]$  for their sequential measurement does not correspond to the previously mentioned one, and it is, in fact, not included in the description given by the NCHV model. In this sense, the present discussion extends the NCHV framework to a new hidden-variable model that includes the description of sequences

of incompatible measurements, and in which certain outcomes are allowed to depend on the particular sequence of measurements, if such a sequence involves incompatible measurements. This is a central point common to all analyses of experimental imperfections.

For measurements that are assumed to be compatible, say  $A$  and  $B$ , the hidden-variable model satisfies the usual noncontextuality conditions:

$$\begin{aligned} v(A_1|S_1, \lambda) &= v(A_2|S_2, \lambda), \text{ for all } \lambda, \\ \text{for sequences } S_1 &= \{A\}, S_2 = \{BA\}, \end{aligned} \quad (31)$$

where  $v(A_i|S, \lambda)$  denotes the value assigned by the hidden variable model to the observable  $A$  in position  $i$  in the sequence  $S$  for a given  $\lambda$ . Notice that Eq. (31) is a condition on the hidden-variable model that is not directly experimentally testable, hence, it cannot be taken as an operational definition of compatibility. How can we quantify the disturbance introduced by a measurement in this model? The first observation is that for this model the following inequality holds

$$p[(+|A)\&( +|B)] \leq p[+ + |AB] + p[(+|A)\&(\bullet - |AB)]. \quad (32)$$

Intuitively, given a specific value  $\lambda$  of the hidden variable such that it contributes to the lhs, either the value of  $B$  either stays the same, i.e.,  $\lambda$  contributes to  $p[+ + |AB]$ , or the value of  $B$  is flipped by the measure of  $A$ , i.e.,  $\lambda$  contributes to  $p[(+|A)\&(\bullet - |AB)]$ .

The correlator  $\langle AB \rangle = \sum_{ab=\pm 1} ab p[(a|A)\&(b|B)]$ , representing the correlation between  $A$  and  $B$  assigned by the hidden-variable model, can be written as

$$\langle AB \rangle = 1 - 2p[(+|A)\&(-|B)] - 2p[(-|A)\&( +|B)]. \quad (33)$$

In contrast, the correlation between  $A$  and  $B$  observed in an experiment where we measure the sequence  $S = \{AB\}$  denoted by  $\langle A_1B_2 \rangle$ , is given by  $\langle A_1B_2 \rangle = \sum_{ab=\pm 1} ab p[ab|AB]$ . In general,  $\langle A_1B_2 \rangle \neq \langle AB \rangle$  if  $A$  and  $B$  are incompatible.

By defining  $p^{\text{flip}}[AB]$  as the probability that the outcome of  $B$  is flipped by the measurement of  $A$ , namely,

$$p^{\text{flip}}[AB] := p[(+|B)\&(\bullet - |AB)] + p[(-|B)\&(\bullet + |AB)], \quad (34)$$

and using Eq. (32), we can bound  $\langle AB \rangle$  with the experimentally observable correlator  $\langle A_1B_2 \rangle$  as follows:

$$\langle A_1B_2 \rangle - 2p^{\text{flip}}[AB] \leq \langle AB \rangle \leq \langle A_1B_2 \rangle + 2p^{\text{flip}}[AB]. \quad (35)$$

From Eq. (31),  $p^{\text{flip}}[AB] = 0$  for compatible measurements.

Applying this reasoning to the CHSH inequality (Clauser *et al.*, 1969),

$$\langle AB \rangle + \langle BC \rangle + \langle CD \rangle - \langle AD \rangle \leq 2. \quad (36)$$

We have the corresponding expression for the case of sequential measurements (Gühne *et al.*, 2010)

$$\begin{aligned} \langle \chi_{\text{CHSH}}^{\text{seq}} \rangle &:= \langle A_1B_2 \rangle + \langle C_1B_2 \rangle + \langle C_1D_2 \rangle - \langle A_1D_2 \rangle \\ &\leq 2(1 + p^{\text{flip}}[AB] + p^{\text{flip}}[CB] + p^{\text{flip}}[CD] + p^{\text{flip}}[AD]). \end{aligned} \quad (37)$$

What is left is to bound the unobservable quantity  $p^{\text{flip}}$ . We introduce

$$p^{\text{err}}[BAB] := p[+ \bullet - |BAB] + p[- \bullet + |BAB], \quad (38)$$

corresponding to the probability of flipping the value of  $B$  in a sequence of three measurements with an intermediate measurement of  $A$ . In contrast to  $p^{\text{flip}}[AB]$ ,  $p^{\text{err}}[BAB]$  is experimentally measurable.

At this point, one needs an assumption on the hidden-variable (HV) model describing the experimental noise, namely

(CN) Cumulative noise assumption:

$$\begin{aligned} p[(\pm|B) \text{ and } (\bullet \mp |AB)] &\leq p[(\pm|B) \text{ and } (\pm \bullet \mp |BAB)] \\ &= p[\pm \bullet \mp |BAB]. \end{aligned} \quad (39)$$

Notice that Eq. (39) is not directly testable as it contains some inaccessible correlations that are defined only at the level of the HV model. Nevertheless, one can have a physical intuition of what this means. In fact, this assumption corresponds to the idea of a *cumulative noise*, i.e., the noise always increases with additional measurements. It is more likely to flip the outcome of  $B$  if we perform a measurement of both  $B$  and  $A$  than it is if we perform only a measurement of  $A$ . This seems to be a reasonable assumption if we want to model experimental imperfections, where the measurements are not supposed to “collude” to cancel out the noise when arranged in specific sequences. Similar ideas were explored by Wilde and Mizel in their discussion of the so-called *clumsiness loophole* for Leggett-Garg inequalities (Wilde and Mizel, 2012).

Equation (39) then directly implies  $p^{\text{flip}}[AB] \leq p^{\text{err}}[BAB]$ , and allows us to rewrite Eq. (37) as

$$\begin{aligned} \langle \chi_{\text{CHSH}}^{\text{seq}} \rangle - 2(p^{\text{err}}[BAB] + p^{\text{err}}[BCB] \\ + p^{\text{err}}[DCD] + p^{\text{err}}[DAD]) \leq 2, \end{aligned} \quad (40)$$

which involves only experimentally testable quantities. Kirchmair *et al.* (2009) reported an experimental violation of Eq. (40) for a sequential measurement of the CHSH expression with the value

$$\begin{aligned} \langle \chi_{\text{CHSH}}^{\text{seq}} \rangle - 2(p^{\text{err}}[BAB] + p^{\text{err}}[BCB] + p^{\text{err}}[DCD] \\ + p^{\text{err}}[DAD]) = 2.23(5). \end{aligned} \quad (41)$$

A similar analysis was performed in the experiment by Jerger *et al.* (2016).

## 2. Context-independent time evolution

An implicit assumption hidden in the definition of the previous model is that the hidden variable  $\lambda$  is static, i.e., not evolving during the time passing between one measurement and the subsequent one. Szangolies *et al.* (2013) and Szangolies (2015) proposed a relaxation of

such conditions admitting a hidden variable changing in time, but with an evolution that is still context-independent, in the sense that it does not depend on the specific measurements performed. This investigation led to modified noncontextuality inequalities satisfied by such an extended set of noncontextual correlations, thus, able to demonstrate quantum contextuality in a broader framework.

The notion of *noncontextual evolution* has been formalized as follows (Szangolies, 2015): The system evolves according to a sequence of hidden variable states  $\lambda_i \rightarrow \lambda_j \rightarrow \lambda_k \rightarrow \dots$  that is independent of the measurements performed. To understand this notion, it is helpful to consider a simple example of a noncontextuality inequality that can be maximally violated by such models. Consider the CHSH inequality, but now evaluated according to the following sequential measurement scheme:

$$\langle A_1 B_2 \rangle + \langle B_1 C_2 \rangle + \langle C_1 D_2 \rangle - \langle D_1 A_2 \rangle \leq 2, \quad (42)$$

where, as in Sec. IV.C.1, we denote via the symbol  $\langle A_1 B_2 \rangle$  the fact that we perform the measurement  $A$  first, then the measurement  $B$ , and take the expectation value of the product of their outcome. Szangolies *et al.* (2013) constructed the following noncontextual model with evolution. The hidden variable  $\lambda$  evolves from an initial state  $\lambda_1$  to  $\lambda_2$ , regardless of the measurement performed at the initial time. The measurements are chosen such that  $A, B, C$  and  $D$  always give the outcome  $+1$  on the state  $\lambda_1$  and likewise for  $\lambda_2$ , with the only exception being  $A$ , which gives the value  $-1$  on  $\lambda_2$ . It is then straightforward to verify that Eq. (42) can be violated up to the algebraic maximum 4. On the other hand, forcing the measurements to always appear in the same order, namely

$$\langle A_1 B_2 \rangle + \langle B_1 C_2 \rangle + \langle C_1 D_2 \rangle - \langle A_1 D_2 \rangle \leq 2, \quad (43)$$

restores the classical bound 2. Intuitively, since observables are forced to appear always in the same position in the sequence, they are always drawn from the same distribution for  $\lambda = \lambda_1$  or  $\lambda_2$ , hence, they are not affected by the evolution of  $\lambda$ . This behavior is analogous to what happens in Leggett-Garg tests (Emary *et al.*, 2014; Leggett and Garg, 1985), where the hidden variable  $\lambda$  is allowed to evolve freely in time.

Analogous reasoning can be applied to different noncontextuality inequalities (Szangolies *et al.*, 2013), such as the PM inequality seen in Eq. (3)

$$\langle A_1 B_2 C_3 \rangle + \langle c_1 a_2 b_3 \rangle + \langle \beta_1 \gamma_2 \alpha_3 \rangle + \langle A_1 a_2 \alpha_3 \rangle + \langle \beta_1 B_2 b_3 \rangle - \langle c_1 \gamma_2 C_3 \rangle \leq 4, \quad (44)$$

where the observables are always forced to appear in the same position in each sequence of measurements:  $A$  always appears first,  $a$  always appears second,  $\alpha$  always appears third, etc. The same inequality has also been investigated from the perspective of dimension witnesses based on quantum contextuality (Gühne *et al.*, 2014) and

for a comparison between the spatial and temporal scenario (Xu and Cabello, 2017).

Moreover, similar ideas can even be applied to noncontextuality inequalities where observables cannot be forced to always be in the same position, such as KCBS inequality (Szangolies *et al.*, 2013, cf. Eq. (17))

$$\langle A_1 B_2 \rangle + \langle B_1 C_2 \rangle + \langle C_1 D_2 \rangle + \langle D_1 E_2 \rangle + \langle E_1 A_2 \rangle - \langle A_1 A_2 \rangle \geq -4, \quad (45)$$

where the extra term  $\langle A_1 A_2 \rangle$  is designed to give a “penalty” whenever the value  $A$  changes with a change in  $\lambda$ . In summary, this approach provides a simple method of dealing with context-independent time evolution of the hidden variable, which can be easily combined with the one presented in Sec. IV.C.1

### 3. First proposals of experimentally testable inequalities

The first attempts to derive experimentally testable noncontextuality inequalities were made in the early 2000’s by Larsson (2002) and Simon *et al.* (2001). They relaxed Kochen-Specker assumptions by requiring that the noncontextuality assumption and the completeness condition ( $\mathbf{C}'$ ) of Sec. III.A are only approximately satisfied. More precisely, the model proposed by Simon *et al.* (2001) considered a relaxation of ( $\mathbf{C}'$ ), whereas Larsson (2002) considered a relaxation of both ( $\mathbf{C}'$ ) and the noncontextual value assignment. In the following, we discuss the approach of Larsson (2002).

For any pair of intersecting contexts appearing in a KS set, i.e., triples of vectors  $(a, b, c)$  and  $(a, b', c')$ , we make the assumption that the value assignment is approximately context-independent, i.e.,

$$p[v_{(a,b,c)}(a) \neq v_{(a,b',c')}(a)] \leq \varepsilon, \quad (46)$$

where  $v_{(a,b,c)}(a)$  denotes the value assigned to  $a$  in the context  $(a, b, c)$ .

Models that obey the previous assumption were called  $\varepsilon$ -ontologically faithful noncontextual ( $\varepsilon$ -ONC) models by Winter (2014). A formal statement of the second assumption is that the value assignments on any given context approximately satisfy the condition ( $\mathbf{C}'$ ), i.e.,

$$p\left(\sum_{i=a,b,c} v_{(a,b,c)}(i) \neq 1\right) \leq \varepsilon'. \quad (47)$$

We now write  $M$  for the number of interconnections between contexts [such as  $M = 1$  for the single shared vector between  $(a, b, c)$  and  $(a, b', c')$ ], and  $N$  for the number of contexts. A Kochen-Specker proof consists of a set of vectors for which it is impossible to assign a noncontextual value satisfying all logical relations. In the previous language, this implies the impossibility of an assignment with  $\varepsilon = \varepsilon' = 0$ . This is also expected to hold for small disturbances. This intuition can be made quantitative,

with the following inequality derived by Larsson (2002) from the previous assumptions:

$$M\varepsilon + N\varepsilon' \geq 1, \quad (48)$$

implying that if the errors in the logical relations ( $\varepsilon'$ ) are small, noncontextuality must often fail ( $\varepsilon$  must be large). The presence of the logical relations associated with the KS-theorem makes it a KS-inequality such as those discussed in Sec. IV.A.5.

Using experimental estimates of the probability of failure of the logical relations, one can draw conclusions on how far from noncontextual the data are. For the Kochen-Specker proofs available at the time, the numbers  $M$  (interconnections) and  $N$  (contexts) were high, so even small values of  $\varepsilon$  and  $\varepsilon'$  would give a value on the left-hand side of Eq. (48) that is larger than 1; see the numbers listed in Table I. An experiment to violate one of these inequalities would be challenging, given that errors in the directions would translate to an increased probability of failure of noncontextuality, and would therefore lower the bound on  $\varepsilon'$ . However, there is no direct connection between directional accuracy and  $\varepsilon$ , the probability of failure of noncontextuality, and no immediate way to estimate this failure probability from experimentally measurable quantities.

#### 4. Approximate quantum models

An attempt to use the quantum description of the system and measurements for the estimate of the failure probability of Sec. IV.C.3 was presented by Winter (2014). Winter considered quantum effects  $Q_i$  that are  $\varepsilon$  close in the operator norm to the ideal projectors  $P_i$  associated with each direction  $i$ , such that

$$\|Q_i - P_i\| \leq \varepsilon. \quad (49)$$

Winter (2014) called this  $\varepsilon$ -precise quantum ( $\varepsilon$ -PQ) model. Note that in principle  $\varepsilon$  can be estimated through a tomographic characterization of the measurement. It is now tempting to equate the  $\varepsilon$  from the  $\varepsilon$ -ONC model (as previously defined) with the  $\varepsilon$  from the  $\varepsilon$ -precise quantum model, the reason being that they each constitute a distance measure in their respective realms. In the following, we review how this identification can play a role in contextuality tests according to Winter (2014).

We consider an  $\varepsilon$ -ONC model consisting of a set of  $\{0, 1\}$ -valued classical random variables  $X_i^C$ , each associated with a rank-1 projector  $P_i$  and a context  $C$ , such that

$$\begin{aligned} \sum_{i \in C} X_i &\leq 1, \text{ for all contexts } C, \\ \text{Prob}(X_i^C \neq X_i^{C'}) &\leq \varepsilon, \text{ for all } i, C, C', \\ &\text{such that } i \in C \cap C'. \end{aligned} \quad (50)$$

In other words, the model is explicitly contextual; i.e., for each  $i$  and each context  $C$ , we have a different random

variable  $X_i^C$ , but  $X_i^C$  and  $X_i^{C'}$  take different values at most with probability  $\varepsilon$ . The case  $\varepsilon = 0$  clearly coincides with the usual NCHV model.

From the previously mentioned explicitly contextual model one can define context-independent variables  $Y_i$  as

$$Y_i := \prod_C X_i^C. \quad (51)$$

From Eq. (51) it is clear that the probability that  $Y_i$  is different from  $X_i^C$  for some  $C$  is equal to the probability that  $X_i^C$  are not all equal for different  $C$ ; hence, it is smaller than  $(k_i - 1)\varepsilon$ , where  $k_i$  is the number of contexts in which  $i$  appears. We thus have

$$\langle X_i^C \rangle \leq \langle Y_i \rangle + (k_i - 1)\varepsilon, \quad (52)$$

which corresponds to the modified bound for  $\varepsilon$ -ONC models

$$\sum_i \lambda_i \langle P_i \rangle \leq \beta_{\varepsilon\text{-ONC}} := \beta_{0\text{-ONC}} + \varepsilon \sum_i \lambda_i (k_i - 1), \quad (53)$$

where  $\beta_{0\text{-ONC}}$  denotes the usual NCHV bound and  $\beta_{\varepsilon\text{-ONC}}$  represents the modified bound for a  $\varepsilon$ -ONC model.

For a given violation  $\beta_q$  of the NCHV bound  $\beta_{0\text{-ONC}}$  we can have a contradiction up to the precision  $\varepsilon_0 = (\beta_q - \beta_{0\text{-ONC}}) / [\sum_i \lambda_i (k_i - 1)]$ , i.e., the violation cannot be explained using a model with imprecision  $\varepsilon \leq \varepsilon_0$ . Winter (2014) also provided some estimates of the  $\varepsilon_0$  associated with maximal quantum violation of different noncontextuality inequalities, such as the KCBS inequality with  $\varepsilon_0^{\text{KCBS}} < 0.047$  and the PM-square inequality with  $\varepsilon_0^{\text{PM}} < 0.0138$ .

By equating the  $\varepsilon$  of the  $\varepsilon$ -ONC model with the  $\varepsilon$  of the  $\varepsilon$ -PQ model, e.g., with the latter extracted via a tomography of the quantum effects, one could use the previous argument to disprove noncontextuality for imprecise measurements. However, there is no direct connection between the two as both definitions (of an approximate quantum model and of an ontologically faithful noncontextual classical model) are independent. In fact, the measures arise in different domains and measure distances between different conceptual object types: in one case the operator-norm distance between an ideal measurement ( $P_i$ ) and the realized effect ( $Q_i$ ), and in the other case the statistical distance between an outcome assignment in one context [ $v_{(a,b,c)}(a)$  in the previous example] and the corresponding outcome assignment in another context [ $v_{(a,b',c')}(a)$ ].

#### 5. Maximally noncontextual models

Another approach to the quantification of measurement disturbance in contextuality tests was proposed by Kujala *et al.* (2015), via the notion of *maximal noncontextuality*. They relaxed the definition of a NCHV model

	$d$	$n$	$N$	$M$	$\varepsilon' (\varepsilon = 0)$	$\varepsilon' (\varepsilon = 0.01)$
Peres (1993)	3	57 (33)	40	96	0.0250	0.0010
Kochen and Conway (Peres, 1993)	3	51 (31)	37	91	0.0270	0.0024
Schütte (Bub, 1997)	3	49 (33)	36	87	0.0278	0.0036
Kernaghan and Peres (1995)	8	36	11	72	0.0909	0.0255
Kernaghan (1994)	4	20	11	30	0.0909	0.0636
Cabello <i>et al.</i> (1996a)	4	18	9	18	0.1111	0.0911
Lisoněk <i>et al.</i> (2014)	6	21	7	21	0.1429	0.1129

TABLE I Various Kochen-Specker proofs: the dimension  $d$ , the number of projectors  $n$  (the number inside parantheses is the number used in the contradiction, while number outside them counts all vectors when completing the bases), the number of contexts  $N$ , and the number of context changes  $M$ . The final two columns are lower bounds for the probability of failure of the logic relation  $\varepsilon'$  given a noncontextual model ( $\varepsilon = 0$ ), and when there is a small probability of failure of noncontextuality from experimental causes (such as  $\varepsilon = 0.01$ ).

by allowing for some disturbance in the measurements, not necessarily seen as sequential measurements, leading to an apparent context-dependence, namely, the observation of different marginal distributions for the measurement of the same observable in different contexts. In this way, they obtained an explicitly contextual classical model, in which observables in different contexts were represented by different classical random variables.

It is instructive to show a simple example. Consider the KCBS scenario discussed in Sec. IV.A.2: five  $\{+1, -1\}$ -valued observables  $A_0, \dots, A_4$  with compatible pairs  $A_i, A_{i+1}$ , with the sum modulo 5. Consider the following version of the KCBS inequality

$$\sum_{i=0}^3 \langle A_i A_{i+1} \rangle - \langle A_0 A_4 \rangle \leq 3, \quad (54)$$

where addition in the indices is interpreted modulo 5. The NCHV model was extended by Kujala *et al.* (2015) by taking a copy of each classical variable for each context. In this case, there are five contexts  $\{A_i, A_{i+1}\}$  for  $i = 0, \dots, 4$  and each  $A_i$  appears twice, i.e., in the  $i$ -th and the  $(i+1)$ -th contexts. They constructed an explicitly contextual model by taking context-dependent copies, i.e.,  $A_i^{(i)}$  and  $A_i^{(i+1)}$ , where the superscript indicates the context. This construction of a contextual model is similar to that discussed in Sec. IV.C.1, where the value assignment of an observable explicitly depends on the sequence it appears in, see Eq. (31). However, to facilitate an easier comparison with the original paper, we follow the notation by Kujala *et al.* (2015).

As in the previous cases, in order to interpret experimental results one needs to make an assumption regarding the type of disturbance present. The authors choose to introduce the notion of *maximally noncontextual* model. A rigorous definition was provided by Kujala *et al.* (2015). Here, we may reformulate it in simple terms as follows: variables representing observables in different contexts are equal to each other with the maximum probability allowed by the observed marginals. Intuitively, this notion states that there is no disturbance other than that observed in the marginals. In a man-

ner similar to that discussed in Sec. IV.C.1, it is reasonable to apply this model if the noise is supposed to arise from some clumsiness of the measurements; i.e., the measurement apparatuses are not colluding to cancel out the noise when combined in a certain way.

Kujala *et al.* (2015) derived a class of inequalities valid for maximally noncontextual models, for what they called *cyclic systems*, also referred to as the  $n$ -cycle scenario (Araújo *et al.*, 2013), namely, a collection of  $\{+1, -1\}$ -valued observables  $A_0, \dots, A_{n-1}$  with compatible pairs  $A_i, A_{i+1}$ , with the sum modulo  $n$ . This scenario includes the Leggett-Garg inequality (Leggett and Garg, 1985), the CHSH inequality (Clauser *et al.*, 1969), and the KCBS inequality (Klyachko *et al.*, 2008), corresponding to, respectively,  $n = 3, 4, 5$ . The KCBS inequality in Eq. (54) becomes

$$\sum_{i=0}^3 \langle A_i^{(i)} A_{i+1}^{(i)} \rangle - \langle A_0^{(4)} A_4^{(4)} \rangle - \sum_{i=0}^4 |\langle A_i^{(i)} \rangle - \langle A_i^{(i-1)} \rangle| \leq 3. \quad (55)$$

Such inequalities can be derived using methods similar to those associated with standard noncontextuality inequalities (see Sec. V.A): under the assumption of a joint probability distribution over all variables  $\{A_i^{(c)}\}_{i,c}$ , one computes the projection of the corresponding probability simplex onto the space of observable marginals [in this case, the correlators  $\{\langle A_i^{(i)} A_{i+1}^{(i)} \rangle\}_i$  and expectation values (marginals)  $\{\langle A_i^{(c)} \rangle\}_{i,c=i,i+1}$ ]. A rigorous derivation of Eq. (55) can be found in Kujala *et al.* (2015).

In contrast to the proposal in Sec. IV.C.1, the present method does not require one to perform additional measurements, as the experimental data obtained for the usual test of the KCBS inequality already contains all the information necessary to evaluate the lhs of Eq. (55). In fact, Kujala *et al.* (2015) compared this expression with the experimental results for the test of the KCBS inequality given by Łapkiewicz *et al.* (2011) by computing a 99.99999999% confidence interval for the lhs of Eq. (55) and obtaining the interval  $[3.127, 4.062]$ , thereby confirming a violation of the inequality. This result can then be interpreted as a disproof of maximally noncon-

textual models. [Amaral and Duarte \(2019\)](#); [Amaral et al. \(2018b\)](#) investigated general methods to derive inequalities such as Eq. (55) for arbitrary scenarios.

#### D. Experimental realizations

In this section, we discuss some experimental tests of quantum contextuality. We cannot give a detailed description of the experimental techniques. Instead, we explain some typical experiments and their underlying assumptions.

##### 1. Early experiments

We first mention some of the early experiments aiming at a test of quantum contextuality ([Bartosik et al., 2009](#); [Hasegawa et al., 2006](#); [Huang et al., 2003](#); [Michler et al., 2000](#)). These early experiments were characterized by the fact that they did not measure one of the contextuality inequalities from Sec. IV.A. Instead, some predictions of quantum mechanics are assumed to be correct in order to interpret the observations as a refutation of noncontextuality.

As an example, we discuss the experiment by [Bartosik et al. \(2009\)](#) in some detail. We consider the following six observables on a two-qubit system,

$$\begin{aligned} A &= \sigma_x \otimes \mathbb{1}, & B &= \mathbb{1} \otimes \sigma_x, & a &= \sigma_y \otimes \mathbb{1}, \\ b &= \mathbb{1} \otimes \sigma_y, & G &= \sigma_x \otimes \sigma_y, & g &= \sigma_y \otimes \sigma_x \end{aligned} \quad (56)$$

Thus, for any noncontextual model the inequality

$$\langle \Theta \rangle = -\langle AB \rangle - \langle ab \rangle + \langle GAb \rangle + \langle gaB \rangle - \langle Gg \rangle \leq 3 \quad (57)$$

holds. This can be directly checked by considering all the  $\pm 1$  assignments to the measurements. For a two-qubit Bell state in an appropriate basis, one can reach the value  $\langle \Theta \rangle = 5$ , as the Bell state can be a common eigenstate of  $G$  and  $g$  with eigenvalue  $-1$ .

As our observables are defined locally, one can assume the relation  $\langle GAb \rangle = \langle gaB \rangle = 1$ . Note, however, that this assumption is justified only for the given definition of observables, it does not necessarily hold if the measurements are considered to be black boxes. But in that case the inequality simplifies to

$$\langle \theta \rangle = -\langle AB \rangle - \langle ab \rangle - \langle Gg \rangle \leq 1. \quad (58)$$

For testing this inequality, [Bartosik et al. \(2009\)](#) used neutron interferometry. Here the two qubits are represented by the spin and the path of a neutron in an interferometer. These 2 degrees of freedom are independently accessible, and the terms  $\langle AB \rangle$  and  $\langle ab \rangle$  can be measured directly.

Under the assumption of the validity of quantum mechanics, the term  $\langle Gg \rangle$  can be measured by performing a Bell measurement (i.e., a measurement in the basis of

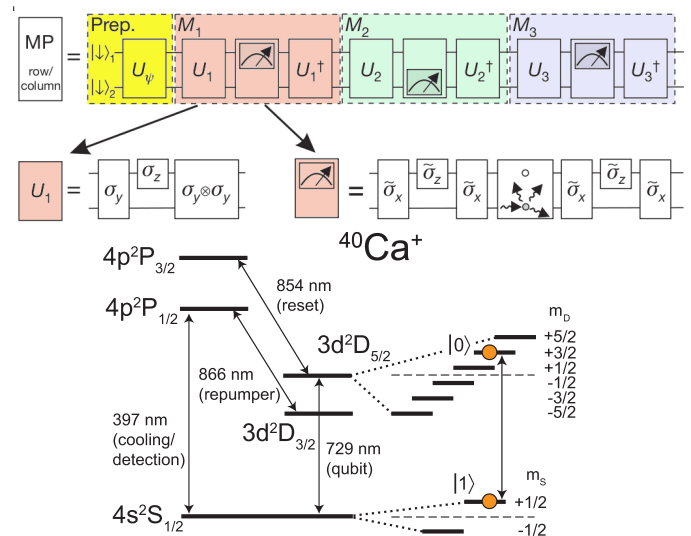

FIG. 10 Upper panel: level scheme of a single  $^{40}\text{Ca}^+$  ion, highlighting the electronic levels used for the qubit.

Lower panel: Implementation of the measurement sequence of one column or row. To retrieve only 1 bit of information, a measurement is implemented by first performing a nonlocal unitary transformation, then only one qubit is read out, and finally the unitary transformation is reversed. From [Gühne et al. \(2010\)](#).

all the four Bell states) on the two qubits. This also allows one to reconstruct the values of  $G$  and  $g$  separately. Typically, such a Bell measurement is nonlocal and therefore difficult, but since the two qubits are encoded on a single neutron, this is feasible here. Finally, a value of  $\langle \theta \rangle = 2.291 \pm 0.008$  was found, resulting in a clear violation of Eq. (58).

##### 2. A test of the Peres-Mermin inequality with trapped ions

One of the first experiments testing contextuality inequalities was performed with ion traps ([Kirchmair et al., 2009](#)) and it can be considered the prototypical example from which the general description in Sec. IV.B has been developed, as well as the basis for many other subsequent experiments. This experiment aimed at an implementation of the inequality coming from the PM square, see Eq. (3).

We start by describing the experimental setup: A pair of  $^{40}\text{Ca}^+$  ions in a Paul trap was used to model the four-dimensional Hilbert space. For each ion, the qubit is represented by the states  $|1\rangle = |S_{1/2}, m_S = 1/2\rangle$  and  $|0\rangle = |D_{5/2}, m_D = 3/2\rangle$ , see also Fig. 10. Manipulating and reading out this single system can be done using laser pulses with high fidelity. For performing nonlocal gates, a Mølmer-Sørensen gate was used where both ions were illuminated with the same laser. This allows one to perform nonlocal gates even if the ion-crystal is not in the thermal ground state. This is important, as the later



measurements require state detection of one ion, which can excite the motional quantum number.

A crucial point of the experiment is the appropriate implementation of the measurements of the PM square. Here, it is important that these are global measurements on a four-dimensional system with only two outcomes ( $\pm 1$ ). This means that a measurement like  $C = \sigma_z \otimes \sigma_z$  cannot be implemented by measuring  $\sigma_z$  on both particles separately, as this would give four different results and destroy the coherence in the subspaces corresponding to the eigenvalues of  $\sigma_z \otimes \sigma_z$ , as discussed in our first presentation of the PM square in Sec. II. To circumvent this, one can write  $C$  and any other observable in the PM square as

$$C = \sigma_z \otimes \sigma_z = U_C^\dagger [\sigma_z \otimes \mathbb{1}] U_C, \quad (59)$$

where  $U_C$  is some nonlocal unitary gate. Physically, this allows one to implement  $C$  by first applying the  $U_C$  to the state, then reading out only the first ion, and finally undoing the transformation  $U_C$  again. In the experiment, the internal state of the second ion was in addition transferred to a different level during the readout of the first ion, in order to protect it from fluorescence light during the detection process.

In this way, all the nonlocal measurements on the PM square can be implemented, but note that the measurement of the third row and the third column requires the implementation of six nonlocal gates within the sequence. Consequently, the fidelity of a single nonlocal gate must be high (in the experiment it was around 98%) in order to observe the desired results. For the interpretation of the experiment, the details of the decomposition of  $C = U_C^\dagger [\sigma_z \otimes \mathbb{1}] U_C$  are not relevant: A measurement like  $C$  is seen as a black box, where a state is subjected to certain measurement procedures and a result  $\pm 1$  is obtained. The details of the decomposition are inside the black box (see also Fig. 10). One has to determine in the experiment whether these black boxes represent repeatable and nondisturbing measurements; this has also been done as later discussed.

With these measurements, one can start to test the noncontextuality inequality. Performing a sequence of measurements, one obtains eight possible results, since any of the measurements results in a  $\pm 1$  outcome; see also Fig. 11. Multiplying the results gives the total value, which is then used for computing the total expectation value of an inequality. As a first result, if one takes a two-qubit singlet state as an input state, a violation of

$$\langle \text{PM} \rangle = 5.46 \pm 0.04 > 4 \quad (60)$$

has been found, displaying a clear violation. A further central prediction of quantum mechanics is the state independence of the violation. For that, ten different states have been tested, including mixed states and separable states. In all cases, a violation has been found with values of  $\langle \text{PM} \rangle$  ranging from  $5.23 \pm 0.05$  to  $5.46 \pm 0.04$ .

For it to be a complete contextuality test, some more issues have to be discussed. One first has to test and

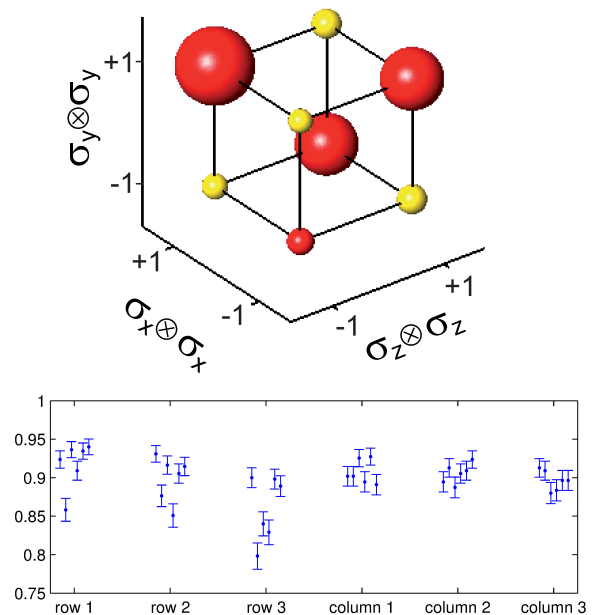

FIG. 11 Upper panel: measurement correlations for a sequence of measurements for a partially entangled input state. The color choice indicate whether the product of the three results gives  $+1$  (yellow) or  $-1$  (red). The volume of a sphere is proportional to the likelihood of finding the corresponding measurement outcome.

Lower panel: permutations of the observables within the rows and columns can serve as a test of the compatibility of the measurements. The measured absolute values of the products of observables for all the six possible permutations are shown. For each permutation, 1100 copies of the singlet state were used. From Kirchmair *et al.* (2009).

quantify the degree to which the implemented measurements are indeed compatible. Closely related to that is the question as to why the observed violation was not the one expected from quantum mechanics. All this allows one to finally exclude hidden-variable models, albeit with additional assumptions besides noncontextuality.

Concerning the compatibility of the measurements within one row or column, the experiment by Kirchmair *et al.* (2009) made several tests. First, for compatible measurements the order of the measurements within one row or column should not matter. This was tested (see Fig. 11) and confirmed. Second, for compatible measurements the values within a sequence of measurements should not change. For that, one can consider the measurement  $A = \sigma_z \otimes \mathbb{1}$  and a sequence of measurements  $A_1 A_2 A_3 \dots$  of it, where we again use the notation of Sec. IV.C.1, with  $A_i$  denoting the measurement of  $A$  in the sequence position  $i$  (to avoid confusion, this notation is not used in the following sections). The question is whether the results of  $A_i$  and  $A_j$  are the same, this can

be quantified by the mean value  $\langle A_i A_j \rangle$ . Here, values from  $\langle A_1 A_2 \rangle = 0.97 \pm 0.01$  to  $\langle A_1 A_5 \rangle = 0.95 \pm 0.01$  have been reported (Gühne *et al.*, 2010). For a nonlocal measurement such as  $c = \sigma_x \otimes \sigma_x$  the imperfections are larger and one finds, for instance  $\langle c_1 c_3 \rangle = 0.88 \pm 0.01$ . In addition, measurement sequences like  $c_1 C_2 c_3$  can be tested in order to test the compatibility of  $C$  and  $c$ . Here, values of  $\langle c_1 c_3 \rangle = 0.83 \pm 0.02$  have been found.

The observations confirm that the implemented measurements are to a certain extent repeatable and compatible. The question remains as to whether this is sufficient to rule out hidden-variable models with some extra assumptions. For that, Kirchmair *et al.* (2009) used a model where certain error probabilities for short sequences are assumed to be bounded by the error probabilities of longer sequences; see Sec. IV.C.1 and Gühne *et al.* (2010) for a detailed discussion. With that, the inequality

$$\langle \chi \rangle = \langle BC \rangle + \langle bc \rangle + \langle Bb \rangle - \langle Cc \rangle - 2p^{\text{err}}[CBC] - 2p^{\text{err}}[cbc] - 2p^{\text{err}}[bBb] - 2p^{\text{err}}[cCc] \leq 2 \quad (61)$$

can be derived. In Eq. (61)  $p^{\text{err}}[CBC]$  denotes the probability that the value of  $C$  is flipped, if the sequence  $C_1 B_2 C_3$  is measured. Experimentally, a value of  $\langle \chi \rangle = 2.23 \pm 0.05$  was found, ruling out this type of hidden-variable model.

### 3. A test of the Peres-Mermin inequality with photons

A further test of the PM square was performed with photons (Amselem *et al.*, 2009). A single photon was used there to carry two qubits: One qubit was encoded in the polarization, and a second one was encoded in the path of the photon; see also Fig. 12.

Given this two-qubit system, one has to implement the nine measurements  $A, \dots, \gamma$  from the PM square. Note that a standard measurement of the polarization or path with photon detectors is not suitable, as then the photon is absorbed and no further sequence of measurements can be carried out. Amselem *et al.* (2009) did this by constructing an interferometric setup for each measurement, where the result of the measurement was encoded in the output port of the interferometer; see Fig. 12 (c). For instance,  $A = \sigma_z^s$  on the spatial qubit is effectively an empty interferometer: the photon leaves the setup in direct correspondence to the input. The polarization measurement  $B = \sigma_z^p$  can be implemented with a polarizing beam splitter, which makes the output port dependent on the input polarization. These are only simple examples; certain other measurements essentially require an entangled Bell measurement for their implementation.

For measuring a sequence like  $CAB$  one has to concatenate these interferometers, see Fig. 12 (b). Here one needs to build 2 times the setup for measuring  $A$ , one for each possible output port of  $C$ . Moreover, one needs 4 times the setup for  $B$ , as  $CA$  can have four possible results, i.e., the photon may be in four different paths.

Finally, the result of the entire sequence is measured by a click in one of eight detectors. The inequality was checked for 20 different input states. On average, a value of

$$\langle \text{PM} \rangle = 5.4550 \pm 0.0006 > 4 \quad (62)$$

was found.

### 4. A test of the KCBS inequality with photons

The KCBS inequality from Sec. IV.A was first tested in an experiment using photons (Łapkiewicz *et al.*, 2011). Here, the three basis states of the Hilbert space were given by three possible paths of a photon in an interferometer; see also Fig. 13.

A single photon is first coherently distributed over the three paths via beam splitters, thus preparing the initial state. A measurement is done by detection in a possible path (result  $-1$ ), and if no photon is detected the measured value is  $+1$ . A pair of observables from the KCBS inequality is measured simultaneously by marking two paths. If the photon is in such a path, the product is assigned the value  $-1$ ; no detection corresponds to the value  $+1$ . For example,  $A_1 A_2$  can be directly be measured [Fig. 13(b)], but for the next term in the inequality, optical elements are used to manipulate the two paths which are not needed for the measurement of  $A_2$ . The two paths are then used for  $A_3$  and the next term in the inequality (Fig. 13(c)).

The setup has to ensure, for instance, that the observable  $A_2$  that is measured both in the term  $A_1 A_2$  and in the term  $A_2 A_3$  corresponds exactly to the same experimental setup. In the experiment this problem was solved by a careful design of a measurement sequence; see the right-hand side of Fig. 13. However, in the last correlation one does not measure  $A_5 A_1$ , but instead  $A_5 A'_1$  where  $A'_1$  has a different structure than the measurement  $A_1$  in the correlation  $A_1 A_2$ . One can, however, compare the properties of  $A_1$  and  $A'_1$  and then argue that it is effectively the same measurement. In the experiment there was a small deviation between  $A_1$  and  $A'_1$ , but it was suggested to take this into account with a correction term in the KCBS inequality, leading to a modified classical bound of  $-3.081 \pm 0.002$ . For the KCBS correlation, there is a value of

$$\langle A_1 A_2 \rangle + \langle A_2 A_3 \rangle + \langle A_3 A_4 \rangle + \langle A_4 A_5 \rangle + \langle A_5 A'_1 \rangle = -3.893 \pm 0.006, \quad (63)$$

which violates the contextuality inequality by 120 standard deviations.

### 5. Final considerations on KS contextuality experiments

To conclude this section, we first mention some other experimental tests of contextuality inequalities. The contextuality inequality from the PM square has also been

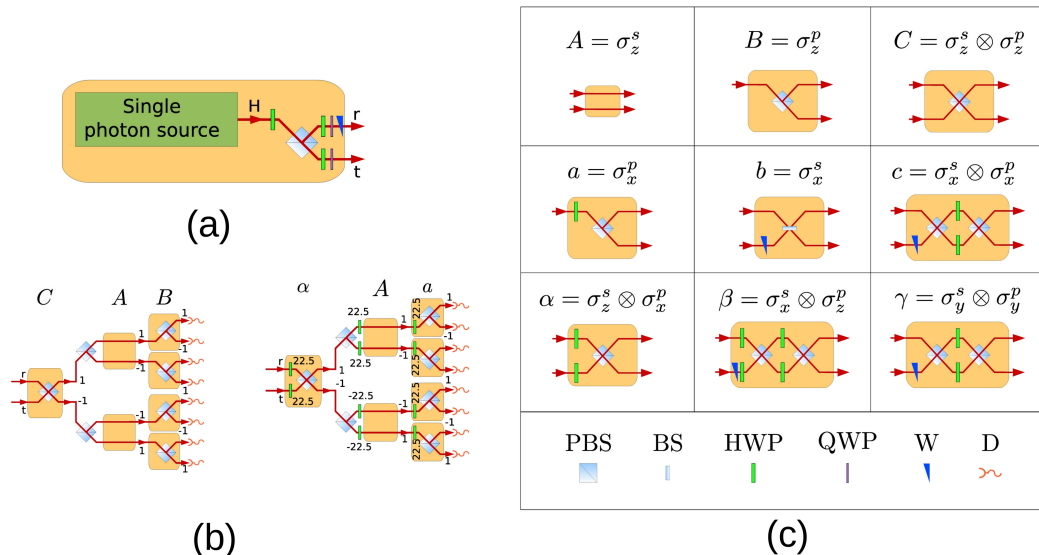

FIG. 12 (a) Encoding of two qubits in one photon. A tunable polarizing beam splitter distributes the photon over two spatial modes, resulting in the spatial qubit. The polarization qubit is adjusted by half- and quarter-wave plates. (b) A row or column of the PM square is measured by a sequence of interferometers. After the sequence, the photon can be in one of eight different outputs, representing the eight outcomes of the sequence of measurements. (c) Detailed interferometric setups for all nine measurements in the PM square. From Amselem *et al.* (2009).

tested using nuclear magnetic resonance (Moussa *et al.*, 2010), with photons in its entropic version (Qu *et al.*, 2020), a similar inequality has been tested with photons (Liu *et al.*, 2009), and the Mermin star inequality has been tested with nitrogen-vacancy centers in diamond (van Dam *et al.*, 2019). The KCBS inequality and its generalizations have been tested with superconducting qubits (Jerger *et al.*, 2016), photons (Arias *et al.*, 2015; Borges *et al.*, 2014), and ions (Malinowski *et al.*, 2018), and Um *et al.* (2013, 2020) explored the connection to randomness generation.

The inequality of Yu and Oh was first tested with photons by Zu *et al.* (2012); see also the discussion given by Amselem *et al.* (2013); Zu *et al.* (2013). Further tests have been implemented with a single trapped ion (Zhang *et al.*, 2013) and nitrogen-vacancy centers in diamond (Kong *et al.*, 2012, 2016). In a more recent experiment with a trapped ion, the compatibility relations of the observables were studied in detail (Leupold *et al.*, 2018). Finally, there are experimental works that aim at an observation of contextuality effects in classical systems (Frustaglia *et al.*, 2016; Li *et al.*, 2017; Zhang *et al.*, 2019); see also the discussion given by Markiewicz *et al.* (2019).

In all the previously listed experiments, several different approaches have been proposed to test contextuality. It is important to separate them into three different main categories. In Secs. IV.B and IV.C, we argued in favor of the use of sequential measurements, such as the experiments by Kirchmair *et al.* (2009) discussed in this section. The alternative is that of joint measurements. Some experiments adopted this approach, such as the one by

Lapkiewicz *et al.* (2011) described in this section. Even in the joint measurement approach, effort has been put into the identification of which part of the device corresponds to each single measurement, as well as the quantification of experimental imperfections and their consequences on the noncontextual bound, in a similar spirit to the approaches discussed in Sec. IV.C. Finally, there are other experiments where the single measurements in each context are not as well characterized and are sometimes even implemented in different ways in different contexts, making the experimental procedure itself context dependent. This can lead to discussions about the interpretation of the experiment (Amselem *et al.*, 2013; Zu *et al.*, 2012, 2013).

The experiments chosen as examples are simply representatives of a broad range of different experiments with analogies and differences. The variability of the different approaches is arguably due to the lack of a clear and comprehensive theoretical description of a quantum contextuality experiment. This review aims to fill the gap.

Finally, there are two types of experiments we have not mentioned thus far, namely, experiments of Spekkens's contextuality, which are covered in Sec. IV.E, and the Liang-Spekkens-Wiseman approach (Liang *et al.*, 2011), which was tested by Zhan *et al.* (2017) and which we do not cover in this review.

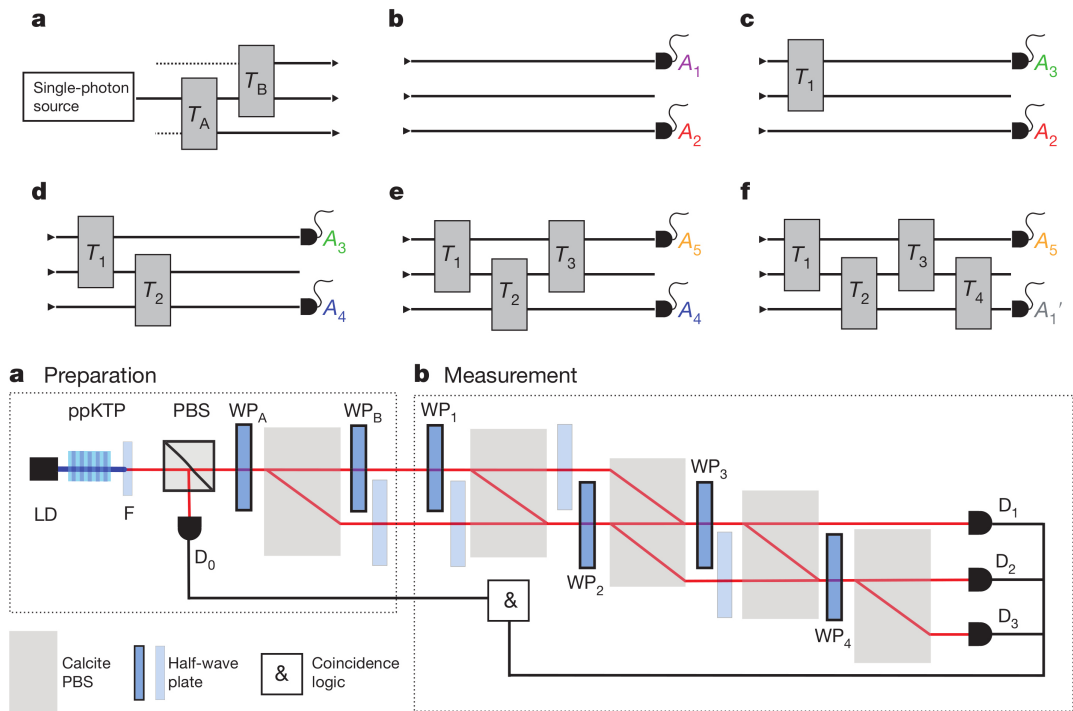

FIG. 13 Left panels: etup for the measurement of the correlations  $\langle A_i A_j \rangle$  in the KCBS inequality in Eq. (63). The measurement  $A_i$  has the result  $-1$  if the corresponding detector clicks; otherwise, the value  $+1$  is assigned. Consequently, the product  $A_i A_j$  has the value  $+1$  if both or no detectors register a photon, otherwise, the value is  $-1$ . Right panels: concrete experimental setup. The transformations  $T_i$  are implemented via insertion of the half-wave plates  $WP_i$ , which in combination with polarizing beam splitters distribute the photons across the modes. From Lapkiewicz *et al.* (2011).

## E. A different notion of contextuality: Spekkens's approach

### 1. Spekkens's definition of noncontextuality

A different notion of contextuality was introduced by Spekkens (2005) and further explored and developed in subsequent papers (Kunjwal, 2020; Kunjwal and Spekkens, 2015, 2018; Mazurek *et al.*, 2016; Pusey, 2018; Schmid *et al.*, 2020b, 2021, 2018; Spekkens, 2014; Xu *et al.*, 2016). The starting point is an operational interpretation of a physical theory, namely, a construction where the primitive elements are preparation, transformation, and measurement procedures. Such procedures are intended as a list of instructions for “operations” that can be performed in a laboratory. For the case of a prepare-and-measure scenario (i.e., ignoring for the moment transformation procedures), the basic elements are preparations and measurement effects together with rules for calculating probabilities [i.e.,  $p(k|P, M)$ ], representing the probability of obtaining the outcome  $k$  for the measurement  $M$  given the preparation procedure  $P$ .

The notion of a noncontextual operational theory is based on the idea of the statistical indistinguishability of procedures. In simple terms, one may call *operationally equivalent* those procedures that give rise to the same statistics and may require that they should be repre-

sented by the same elements of the theory. Consequently, Spekkens defines equivalence classes of preparations and measurements as follows:

$$P \sim P' \iff p(k|P, M) = p(k|P', M) \quad (64)$$

for all measurements and outcomes  $k, M$ ,

$$(M, k) \sim (M', k') \iff p(k|P, M) = p(k'|P, M') \quad (65)$$

for all preparations  $P$ ,

where the symbol  $\sim$  denotes operational equivalence. If one applies the equivalence in Eq. (64) to experimental procedures described according to quantum mechanics, one obtains that each equivalence class  $[P]$  is associated with a quantum state  $\rho$  since there is no way to distinguish via a quantum measurement two preparations that give rise to the same state  $\rho$ . A typical example is that of a spin-1/2 particle: it is not possible to distinguish the preparation of an equal mixture of states polarized along  $z$ , corresponding to the quantum state  $\rho = (|0\rangle\langle 0| + |1\rangle\langle 1|)/2$ , from the preparation of an equal mixture of states polarized along  $x$ , corresponding to the quantum state  $\rho = (|+\rangle\langle +| + |-\rangle\langle -|)/2$ . Similarly for Eq. (65) each measurement  $M$  is associated with a POVM  $\{E_k\}_k$  and each outcome  $k$  is associated with a single element  $E_k$ , with  $E_k \geq 0$  and  $\sum_k E_k = \mathbb{1}$ , regardless of the particulars of the experimental implementa-

tions of the measurement.

A hidden-variable description of preparations and measurement procedures is given by an *ontological model* that plays a role similar to that of a NCHV in Sec. IV.A.1. A crucial difference, however, is that such procedures involve only a preparation and a measurement. In fact, we restrict ourselves to the prepare-and-measure scenario to keep the presentation simple and concise. Notice, however, that the original formulation of Spekkens (Spekkens, 2005) also considered transformations and that recent developments of Spekkens contextuality included also the case of, e.g., sequential measurements, or more complex compositions of operations (Schmid *et al.*, 2020a). An ontological model for the probability  $p(k|P, M)$  is then given by

$$p(k|P, M) = \int d\lambda \mu_P(\lambda) \xi_{M,k}(\lambda), \quad (66)$$

where  $\mu_P : \Omega \rightarrow [0, 1]$  is the probability density associated with the preparation procedure  $P$ , i.e.,  $\int d\lambda \mu_P(\lambda) = 1$ , and  $\xi_{M,k} : \Omega \rightarrow [0, 1]$  represent the indicator function associated with the outcome  $k$  of  $M$ , satisfying  $\sum_k \xi_{M,k}(\lambda) = 1$ , for all  $\lambda \in \Omega$ .

Equation (66) is reminiscent of the expression for joint measurements or local hidden state models arising in the context of quantum steering (Uola *et al.*, 2020). In fact, some formal equivalence between Spekkens's preparation contextuality and these two phenomena has been shown (Tavakoli and Uola, 2020). This is no longer true if the set of states under consideration does not include all quantum states or if one also considers measurement noncontextuality, in addition to preparation noncontextuality; see Selby *et al.* (2021) for further details. Finally, we recall that another notion of steering, based on the original argument by Schrödinger (1935), was shown to hold for a Spekkens-noncontextual toy theory by Spekkens (2007). This notion of steering, however, does not coincide with the one introduced by Wiseman *et al.* (2007) and used by (Tavakoli and Uola, 2020).

The condition of noncontextuality, then, amounts to the requirement that the same description in the ontological model corresponds to each equivalence class in the operational model. In other words, if  $P \sim P'$  then  $\mu_P = \mu_{P'}$ , (condition of preparation noncontextuality) and if  $(M, k) \sim (M', k')$ , then  $\xi_{M,k} = \xi_{M',k'}$  (condition of *measurement noncontextuality*). It is then possible to obtain a contradiction between the previously stated assumptions and the predictions of quantum mechanics, hence, showing the impossibility of a noncontextual ontological model.

In the simplest example of the impossibility of a preparation-noncontextual ontological model, Spekkens (2005) wrote the maximally mixed state of a qubit, i.e.,  $\frac{1}{2}\mathbb{1}$ , as a convex combination of different rank-1 projec-

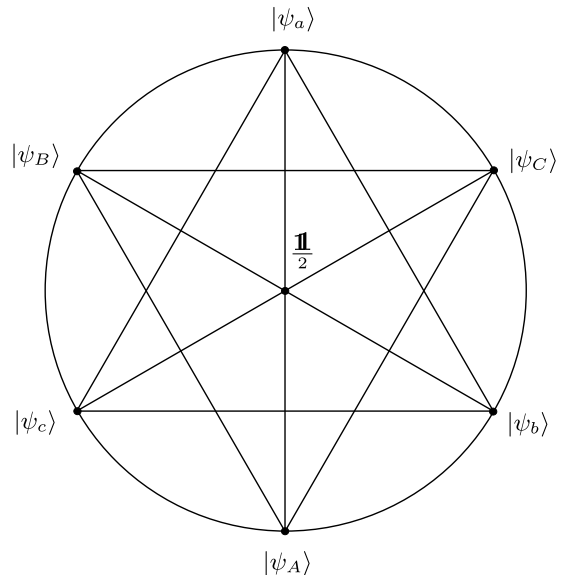

FIG. 14 Different decomposition of the maximally mixed state  $\frac{1}{2}\mathbb{1}$ , represented in the  $(x, z)$  plane of the Bloch sphere, in terms of the pairs along opposite lines, (such as  $|\psi_a\rangle, |\psi_A\rangle$ ), or triples in the same triangle (such as  $|\psi_a\rangle, |\psi_b\rangle, |\psi_c\rangle$ ).

tors, namely,

$$\begin{aligned} \frac{\mathbb{1}}{2} &= \frac{1}{2}(|\psi_a\rangle\langle\psi_a| + |\psi_A\rangle\langle\psi_A|) \\ &= \frac{1}{2}(|\psi_b\rangle\langle\psi_b| + |\psi_B\rangle\langle\psi_B|) = \frac{1}{2}(|\psi_c\rangle\langle\psi_c| + |\psi_C\rangle\langle\psi_C|) \\ &= \frac{1}{3}(|\psi_a\rangle\langle\psi_a| + |\psi_b\rangle\langle\psi_b| + |\psi_c\rangle\langle\psi_c|) \\ &= \frac{1}{3}(|\psi_A\rangle\langle\psi_A| + |\psi_B\rangle\langle\psi_B| + |\psi_C\rangle\langle\psi_C|), \end{aligned} \quad (67)$$

where the vectors (depicted in Fig. 14 in the Bloch representation) are defined as

$$\begin{aligned} |\psi_a\rangle &= (1, 0), \quad |\psi_A\rangle = (0, 1), \\ |\psi_b\rangle &= \frac{1}{2}(1, \sqrt{3}), \quad |\psi_B\rangle = \frac{1}{2}(\sqrt{3}, -1), \\ |\psi_c\rangle &= \frac{1}{2}(1, -\sqrt{3}), \quad |\psi_C\rangle = \frac{1}{2}(\sqrt{3}, 1). \end{aligned} \quad (68)$$

Under the assumption of preparation noncontextuality, the corresponding probability measures in the ontological models must coincide.

$$\begin{aligned} \frac{\mu_a(\lambda) + \mu_A(\lambda)}{2} &= \frac{\mu_b(\lambda) + \mu_B(\lambda)}{2} = \frac{\mu_c(\lambda) + \mu_C(\lambda)}{2} \\ &= \frac{\mu_a(\lambda) + \mu_b(\lambda) + \mu_c(\lambda)}{3} = \frac{\mu_A(\lambda) + \mu_B(\lambda) + \mu_C(\lambda)}{3}. \end{aligned} \quad (69)$$

Moreover, owing to the orthogonality conditions, i.e.,  $\langle\psi_a|\psi_A\rangle = \langle\psi_b|\psi_B\rangle = \langle\psi_c|\psi_C\rangle = 0$ , the corresponding distributions in the ontological model should not overlap, namely,

$$\mu_a(\lambda)\mu_A(\lambda) = \mu_b(\lambda)\mu_B(\lambda) = \mu_c(\lambda)\mu_C(\lambda) = 0 \text{ for all } \lambda, \quad (70)$$

since they can be distinguished with certainty with a single-shot measurement. By checking all possible assignments of null values according to the previously mentioned product conditions, one immediately realizes that the only possible solution to Eqs. (69) and (70) is  $\mu_a(\lambda) = \mu_A(\lambda) = \mu_b(\lambda) = \mu_B(\lambda) = \mu_c(\lambda) = \mu_C(\lambda) = 0$ . The same argument can be extended to show preparation contextuality of any mixed state (Banik *et al.*, 2014). The above ideas have been further elaborated on to devise experimental tests of Spekkens's contextuality, as we discuss in Sec. IV.E.2.

## 2. Inequalities for Spekkens' noncontextuality

Spekkens' notion of noncontextuality was tested experimentally by Anwer *et al.* (2019); Hameedi *et al.* (2017); Mazurek *et al.* (2016); Spekkens *et al.* (2009). To do so, it is first necessary to derive noncontextuality inequalities that are testable against the observed statistics. This was done in several works (Krishna *et al.*, 2017; Kunjwal and Spekkens, 2015, 2018; Mazurek *et al.*, 2016; Pusey, 2018; Schmid *et al.*, 2018; Spekkens *et al.*, 2009; Xu *et al.*, 2016). In the following, we present the results by Mazurek *et al.* (2016), on both the theoretical and experimental sides, as they managed to overcome some difficulties present in the first experiment (Spekkens *et al.*, 2009), particularly, in relation to the operational equivalence of preparations and measurements. The noncontextuality inequality by Mazurek *et al.* (2016), based on both preparation and measurement noncontextuality, is presented in the following. One first needs to introduce six preparations  $P_{t,b}$ , for  $t = 1, 2, 3$  and  $b = 0, 1$ , such that

$$P_* := \frac{1}{2}(P_{t,0} + P_{t,1}) = \frac{1}{2}(P_{t',0} + P_{t',1}) \text{ for all } t, t' = 1, 2, 3, \quad (71)$$

and three dichotomic measurements  $M_t$  for  $t = 1, 2, 3$ , such that the average measurement is the "fair coin flip" measurement, i.e.,

$$M_* := \frac{1}{3} \sum_t M_t, \text{ with } p(b|M_*, P) = \frac{1}{2} \forall P \text{ and } b = 0, 1, \quad (72)$$

where, as usual,  $p(b|M, P)$  denotes the probability of an output  $b$  given the preparation  $P$  and the measurement  $M$ . The noncontextuality inequality reads

$$A = \frac{1}{6} \sum_{t=1,2,3} \sum_{b=0,1} p(b|M_t, P_{t,b}) \leq \frac{5}{6}. \quad (73)$$

This upper bound can be computed in terms of the ontological model as follows

$$\begin{aligned} & \frac{1}{6} \sum_{t=1,2,3} \sum_{b=0,1} \sum_{\lambda} \xi(b|M_t, \lambda) \mu(\lambda|P_{t,b}) \\ & \leq \frac{1}{3} \sum_{t=1,2,3} \sum_{\lambda} \eta(M_t, \lambda) \left( \frac{1}{2} \sum_{b=0,1} \mu(\lambda|P_{t,b}) \right) \\ & = \sum_{\lambda} \mu(\lambda|P_*) \left( \frac{1}{3} \sum_{t=1,2,3} \eta(M_t, \lambda) \right) \\ & \leq \max_{\lambda} \left( \frac{1}{3} \sum_{t=1,2,3} \eta(M_t, \lambda) \right), \end{aligned} \quad (74)$$

where  $\eta(M_t, \lambda) := \max_{b=0,1} \xi(b|M_t, \lambda)$ . The assumption that  $M_*$  is the fair coin flip, implies that  $1/3 \sum_t \xi(b|M_t, \lambda) = \xi(b|M_*, \lambda) = 1/2$  for  $b = 0, 1$ , which constrains the three-dimensional vector  $(\xi(0|M_t, \lambda))_{t=1,2,3}$  on a two-dimensional polytope inside the  $[0, 1]^3$  cube, whose extremal points are given by  $(1, 1/2, 0)$  and the coordinate permutations. Taking the outcome maximization defining  $\eta$ , i.e., flipping one or more outcomes, one obtains at most the assignments  $(1, 1/2, 1)$ , and permutations, which give the upper bound  $5/6$ . Notice that the derivation of Eq. (73) uses both preparation noncontextuality  $[\sum_b \mu(\lambda|P_{t,b})/2 = \mu(\lambda|P_*)]$  and measurement noncontextuality  $[\sum_t \xi(b|M_t, \lambda)/3 = \xi(b|M_*, \lambda)]$ . In fact, the inequality can be violated by models that violate at least one of the constraints, as shown by Mazurek *et al.* (2016). Moreover, quantum theory can violate it up to the algebraic maximum 1. This is done using as  $P_{t,b}$  the six preparations in Fig. 14, with the pairs  $b = 0, 1$ , for fixed  $t$ , associated with antipodal points (i.e.,  $|\psi_a\rangle, |\psi_A\rangle$  etc.), and as measurements the three  $M_t$  projective measurements with two outcomes, rotated by  $2\pi/3$  on the Bloch sphere: where the three effects, each for the 0 outcome of  $M_t$  for  $t = 1, 2, 3$ , form the triangle  $|\psi_a\rangle, |\psi_b\rangle, |\psi_c\rangle$ . General methods for computing maximal violations of such noncontextuality inequalities have been developed (Chaturvedi *et al.*, 2021; Tavakoli *et al.*, 2021).

## 3. Experimental tests of Spekkens' contextuality

In the derivation of Eq. (73), the assumptions of both preparation and measurement noncontextuality enter. Notice that, without further assumptions, to infer operationally indistinguishability one needs to perform all possible measurements as in Eq. (65). To avoid this problem, a minimal set of measurements is assumed to be necessary to infer that two preparation procedures are operationally indistinguishable. This minimal set is said to be *tomographically complete*. Similarly, a tomographically complete set of preparations is assumed to exist, in order to infer that two measurements are operationally indistinguishable. To characterize this with minimal assumptions, Mazurek *et al.* (2016) first analyzed the dimension

needed to describe the state preparations and measurements of a single polarized photon. In the experiment, four measurements on eight input states were performed, but then it was found that the experimental data can be described by assuming three independent measurements and a state space given by a four-dimensional hyperplane, in the sense that assuming more independent parameters does not allow for a more accurate description of the experimental data. Given this observation, one can avoid testing the operational equivalence over infinitely many preparations and measurements. The observed numbers of parameters are the same that quantum mechanics uses to describe qubit systems.

A second problem arises, namely that due to experimental imperfections, it is not possible to find pairs of preparations  $\{P_{t,b}\}_b$  with the same average preparation  $P_*$  and a triple of measurements with the same average measurement  $M_*$  corresponding to a fair coin flip. This problem was addressed by Mazurek *et al.* (2016) by constructing the so-called *secondary* preparations and measurements, as convex mixtures of the primary ones (eight state preparations and four measurements), which were those directly implemented in the experiment. In other words, from the primary preparations and measurements performed, one can infer what would have been the value of their convex combinations. Among the secondary operations, one can select those that are the closest to the primary ones and at the same time satisfy exactly the conditions in Eqs. (71) and (72). To avoid any reference to quantum theory, secondary preparations and measurements are described in terms of a generalized probability theory, with the above assumption of tomographical completeness for three measurements and four preparations. The experiment was performed by preparing and measuring the polarization degree of freedom of a single photon, as depicted in Fig. 15. An experimental value of  $A = 0.99709 \pm 0.00007$  for the parameter  $A$  in Eq. (73) is then observed, based on the inferred values of the secondary preparations and measurements, violating the noncontextual bound  $5/6$ .

#### 4. Relation with different notions of hidden-variable models

In Spekkens' notion of contextuality, a fundamental role is played by two properties, namely, the existence of a nonunique decomposition of quantum mechanical mixed states into pure states, and the requirement that the indistinguishability present at the operational level, identified here with quantum mechanical predictions, is satisfied at the level of the ontological model. In contrast, if one assumes a classical model (specifically a measurement contextual hidden-variable model), then each mixed state is a probability distribution and hence has a unique convex decomposition into deterministic assignments, which take here the role of pure states. It follows that hidden-variable models for two-level quantum systems, such as

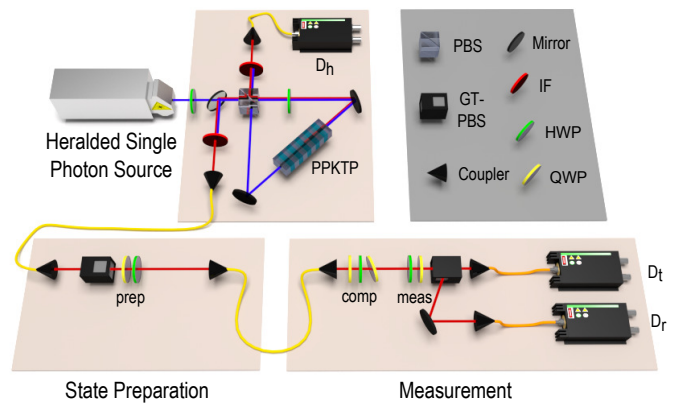

FIG. 15 Experimental setup used by Mazurek *et al.* (2016). The quantum system consists of a single photon in which a specific polarization is prepared via a polarizer and two waveplates (preparation  $P_{t,b}$ ) and then measured via two waveplates, a polarized beamsplitter and two detectors (measurement  $M_t$ ). From Mazurek *et al.* (2016).

the models by Bell (1966) and by Kochen and Specker (1967), turn out to be preparation contextual (Leifer and Maroney, 2013). In these models, in fact, if we were able to directly measure the hidden variable  $\lambda$ , we could distinguish between an equal mixture of  $|0\rangle$  and  $|1\rangle$  and an equal mixture of  $|+\rangle$  and  $|-\rangle$ , even though both mixtures give rise to same quantum state  $\rho = \mathbb{1}/2$ . This is an explicit example of preparation contextuality. According to the hidden-variable model such preparations are indeed different, even though the theory does not contain measurements that are able to distinguish them.

(Spekkens, 2005) defined a noncontextual ontological model of an operational theory as one where any two procedures that are operationally equivalent (in the theory) have identical representations in the ontological model. This definition is defended by appealing to a methodological principle, referred to as Leibniz's principle of the ontological identity of empirical indiscernibles (Spekkens, 2019), which can be stated as follows: If an operational theory predicts that two procedures are indistinguishable but, in the theory, they have distinct representations, then the theory should be discarded and replaced by a new theory relative to which the two procedures have identical representation.

For a defense of this methodological principle for constructing physical theories, the reader is referred to (Spekkens, 2019). For a discussion on how this methodological principle is used to motivate the notion of non-contextual ontological model, see (Spekkens, 2005). The program of hidden-variable theories for quantum mechanics (Belinfante, 1973) provides examples of theories that do not adhere to this methodological principle. Note that it is still under debate as to whether some proposed hidden-variable theories predict deviations from quantum mechanics and, if they do, whether these deviations are observable. The former is an open problem

in Bohmian mechanics, in relation to Bell experiments (Correggi and Morchio, 2002; Kiukas and Werner, 2010) and tunneling times (Hauge and Støvneng, 1989; Landauer and Martin, 1994; Stomphorst, 2002), and in some classes of hidden-variable models analyzed from a thermodynamical perspective (Cabello *et al.*, 2016a), whereas the latter is an open problem in collapse models (Bassi *et al.*, 2013). For a criticism of the notion of preparation contextuality, see Ballentine (2014).

## V. ADVANCED TOPICS AND METHODS

In this section, we discuss more advanced topics and methods associated with quantum contextuality. We address questions such as how to compute noncontextuality inequalities for a given scenario, what the corresponding maximal quantum violation is, which scenarios give rise to contextuality and to state-independent contextuality, how contextuality is related to nonlocality, etc.

Here, since we discuss mostly theoretical results where no direct connection with experimental procedures is made, no additional assumptions on the measurements, such as nondisturbance and repeatability, are necessary. In most cases, it is enough to think about collections of joint measurements, regardless of the way they may be implemented in the lab. Similarly, the distinction between the OP and the EP is mostly irrelevant here, and we often shift between the two points of view, sometimes privileging observables and sometimes privileging effects. Finally, in some sections, such as Sec. V.B.3, V.B.5, V.C and V.F, we explicitly consider projective measurements.

The section is organized as follows. In Sec. V.A, we introduce the noncontextuality polytope, which describes noncontextual correlations associated with a given scenario, i.e., a fixed set of measurements and contexts, and allows one to compute noncontextuality inequalities. In Sec. V.B, we discuss the connection between graph theory and noncontextuality: since contexts can be represented as graphs, or more generally hypergraphs, several properties of contextuality scenarios can be investigated in terms of graph theoretical properties. In Sec. V.C, we discuss the connection between Bell nonlocality and contextuality. In Sec. V.D, we discuss different approaches to the classical simulation of contextual correlations. In Sec. V.E, we present the debate on the nullification of the KS theorem.

### A. The noncontextuality polytope

The set of correlations that can be achieved within a noncontextual theory forms a polytope in the space of probability assignments. Analogously to the case of Bell nonlocality, the study of these polytopes plays a fundamental role in the investigation of noncontextuality inequalities. We introduce the basic notions and discuss some results that have been achieved using this approach.

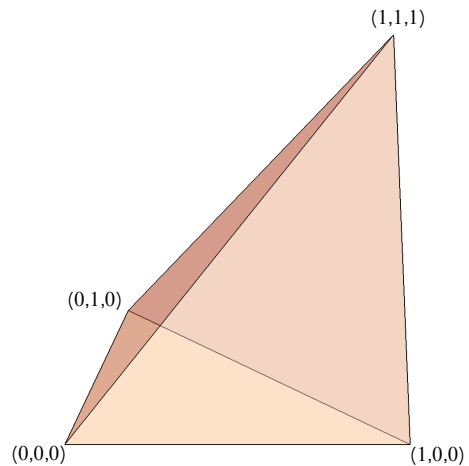

FIG. 16 Polytope associated with two measurements  $A_1$  and  $A_2$ . The four vertices are the deterministic assignments, with corresponding coordinate labeling. Equations (75) are associated with the four faces of the tetrahedron, for instance  $p_{12} = 0$  is the plane tangent to vertices  $(0, 0, 0)$ ,  $(1, 0, 0)$ ,  $(0, 1, 0)$ , etc.

Correlation polytopes were introduced in the study of Bell inequalities by Froissart (1981), Garg and Mermin (1984), and Pitowsky (1986); see also the book Pitowsky (1989), which has been the most widely used reference. Horn and Tarski (1948) had already provided a solution to the marginal problem many years earlier, which turned out to be equivalent to the correlation polytope approach; see De Simone and Pták (2015). In the context of noncontextuality inequalities, the first researchers to systematically use these notions were Klyachko *et al.* (2008), and Kleinmann *et al.* (2012).

#### 1. The simplest example

In this section, we introduce, in basic terms and by means of the simplest example, the notion of the correlation polytope. In Sec. V.A.2, we discuss their basic mathematical properties.

In the case of a finite number of measurement settings and outcomes, a probability distribution is described by some positive numbers  $p_i \geq 0$ ,  $i = 1, \dots, n$  such that  $\sum_i p_i = 1$ . We can interpret them geometrically as the set  $\mathcal{S}_n = \{\mathbf{p} \in \mathbb{R}^n | p_i \geq 0, \sum_i p_i = 1\}$ , also known as a *simplex*: a  $n - 1$ -dimensional polyhedron with  $n$  facets and  $n$  extremal points, i.e., the generalization of the triangle, tetrahedron, etc. Equivalently, it can be seen as the set of convex combinations of the elements of the canonical basis of  $\mathbb{R}^n$ ,  $\{\mathbf{e}_i\}_{i=1}^n$ , namely  $\mathcal{S}_n = \{\sum_i p_i \mathbf{e}_i | p_i \geq 0, \sum_i p_i = 1\} =: \text{conv}(\{\mathbf{e}_i\}_i)$ . Each extremal point  $\mathbf{e}_i$  can be interpreted as a probability assignment of 1 to the  $i$ -th *event* and 0 to the others.

Ultimately, we want to represent probabilities of outcomes for a certain set of measurements, hence, each single event  $i$  is associated with a specific sequence of



outcomes. For instance, we may have the case of two measurements  $A_1$  and  $A_2$  with values 0, or 1. We then define events as  $\{00, 01, 10, 11\}$  and their probabilities as  $p_{00} := \text{Prob}(A_1 = 0, A_2 = 0)$ ,  $p_{01} := \text{Prob}(A_1 = 0, A_2 = 1)$ ,  $p_{10} := \text{Prob}(A_1 = 1, A_2 = 0)$  and  $p_{11} := \text{Prob}(A_1 = 1, A_2 = 1)$ . It is straightforward to verify that the corresponding polytope has dimension 3 since there is an equality constraint (normalization of probability). We can then perform a linear transformation  $(p_{00}, p_{01}, p_{10}, p_{11}) \mapsto (p_1, p_2, p_{12})$ , by computing the marginals, i.e., as  $p_i = \text{Prob}(A_i = 1)$  and  $p_{12} = \text{Prob}(A_1 = A_2 = 1)$ . The four vertices of the polytope are then the four vectors  $p = (\varepsilon_1, \varepsilon_2, \varepsilon_1 \varepsilon_2)$  for  $\varepsilon_1, \varepsilon_2 = 0, 1$ , corresponding to the deterministic assignments of values to  $A_1$  and  $A_2$ . These vectors form the tetrahedron plotted in Fig. 16. It is straightforward to verify that the faces of the tetrahedron are given by the following inequalities

$$\begin{aligned} p_{12} &\geq 0, \\ p_1 - p_{12} &\geq 0, \\ p_2 - p_{12} &\geq 0, \\ 1 - p_1 - p_2 + p_{12} &\geq 0, \end{aligned} \tag{75}$$

which simply represent the constraints of positivity of the four probabilities  $\text{Prob}(A_1 = x, A_2 = y)$  for  $x, y = 0, 1$  rewritten in terms of the marginals  $p_1, p_2$  and  $p_{12}$ .

## 2. Basics of convex polytopes, affine geometry, and linear programming

The general case of an arbitrary number of events is not far from the previous simple one. Before proceeding, we first recall some basic notions about convex polytopes; for a more detailed exposition, see Grünbaum (2003). A convex polytope can be defined in two different ways. In the vertex representation, one specifies the extremal points of the polytope, i.e., the vertices. If the set of vertices is finite, then the convex hull of those points is a convex polytope. The other way to specify a polytope is as the intersection of a finite family of closed half-spaces  $H_i = \{\mathbf{x} \mid \mathbf{m}_i \cdot \mathbf{x} \leq b_i\}$ . If the resulting set is bounded, it is also a convex polytope, otherwise, it is simply called a polyhedron, or a polyhedral set. An intersection of a polytope with an affine subspace (a section) and the image of a polytope under an affine map (such as a projection) both again yield a polytope.

A family of vectors  $(\mathbf{x}_1, \mathbf{x}_2, \dots)$  is affinely independent if there is only a trivial solution to the equations  $\sum_k \lambda_k \mathbf{x}_k = \mathbf{0}$  and  $\sum_k \lambda_k = 1$ . Accordingly, the affine dimension of a family of vectors is  $d = n - 1$  if  $n$  is the maximal number of affinely independent vectors from the family. A facet  $F$  of a  $d$ -dimensional polytope is the intersection of an affine  $(d - 1)$ -dimensional hyperplane with the polytope, so one of the open half-spaces defined by the hyperplane does not contain any part of the polytope. If the polytope is specified by a minimal set of closed half-spaces  $\{H_i\}_i$ , then these hyperplanes are  $H_i \cap -H_i$ . A

facet is a  $(d - 1)$  polytope and the extremal points of the facet are exactly those extremal points of the polytope that belong to the facet. Pitowsky's construction (Pitowsky, 1989) makes use of these facts: The intersection of a half-space  $H$  with a  $d$  polytope  $P$  is a facet of that polytope if and only if the extremal points of  $P$  within  $H$  span a  $(d - 1)$ -dimensional affine subspace.

For the theory of Bell inequalities or noncontextuality inequalities the theory of linear optimization is central. A *linear program* (LP) is an optimization problem of the type "minimize  $\mathbf{c} \cdot \mathbf{x}$  over  $\mathbf{x} \in K$ " where  $\mathbf{c}$  is a constant vector and  $K$  is a polyhedral set, i.e., a finite intersection of closed half-spaces. The set of optimal solutions again forms a polyhedral set or, if the set  $K$  is a polytope, is again a polytope. If  $K$  is specified by the vertices, then solving the program is simple, since the optimum is attained at one of the vertices. The most important insight about linear programs is that, even if  $K$  is specified as an intersection of half-spaces, the optimization can be solved by numerical means efficiently and with a certificate of optimality (Boyd and Vandenberghe, 2004).

## 3. Noncontextuality inequalities

In the following, we present an explicit construction of the correlation polytope based on the work of Pitowsky (1989). Different, but ultimately equivalent, constructions are possible; see e.g., Abramsky *et al.* (2012) and Acín *et al.* (2015). Given a set of observables  $\{A_i\}_{i=1}^N$ , we denote their possible value assignments as  $\mathcal{V} = \mathcal{V}_1 \times \mathcal{V}_2 \times \dots \times \mathcal{V}_N$ , where  $\mathcal{V}_k$  is the set of possible values that the observable  $A_k$  can assume; for instance,  $\mathcal{V}_1 = \{0, 1\}$  when  $A_1$  is a dichotomic observable. The corresponding probability simplex is the convex hull of all assignments on the set  $\mathcal{V}$ , i.e.,  $\{\mathbf{p} \in \mathbb{R}^{|\mathcal{V}|} \mid p_v \geq 0, \sum_v p_v = 1\}$ , where  $v = (v_1, \dots, v_n) \in \mathcal{V}$  and  $p_v = \text{Prob}(A_1 = v_1, \dots, A_n = v_n)$ .

The set of all possible contexts of  $\{A_i\}_{i=1}^N$  defines the marginal scenario  $\mathcal{M}$ , i.e., the set of marginals that can be experimentally accessible, such as the pairs  $\{A_i, A_{i+1}\}$  in the KCBS scenario (Klyachko *et al.*, 2008). The correlation polytope, therefore, is the projection of the probability simplex onto the coordinates corresponding to observable probabilities. To do so, we first need a change of coordinates. The new coordinates are obtained by considering the marginals  $P(A_1 = v_1), \dots, P(A_i = v_i, A_j = v_j), \dots$ . Alternatively, one can choose any affine transformation (such as representations in terms of expectation values, correlators, etc.). An invertible affine transformation guarantees that the obtained conditions are still necessary and sufficient for a probability vector to have a noncontextual hidden-variable model. If the transformation is not invertible, one obtains only necessary conditions. Notice that not all coordinates of  $\mathbf{p}$  are independent, due to normalization ( $\sum_v p_v = 1$ ) and nondisturbing conditions (Ramanathan *et al.*, 2012); hence, invertibility must be checked with respect to this

subspace. Moreover, such linear constraints together with the positivity of probability  $p_v \geq 0$  for all  $v$ , define a new polytope, called the *nondisturbing polytope* (Ramanathan *et al.*, 2012), which contains the noncontextuality polytope.

For instance, in the case of  $V_i = \{0, 1\}$  for all  $i$ , the correlation polytope associated with a marginal scenario  $\mathcal{M}$  is the convex hull of vectors

$$\mathbf{u}_\varepsilon = (\varepsilon_1, \dots, \varepsilon_N, \dots, \varepsilon_i \varepsilon_j, \dots, \varepsilon_{i_1} \varepsilon_{i_2} \dots \varepsilon_{i_m}, \dots), \quad (76)$$

where  $\varepsilon = (\varepsilon_1, \dots, \varepsilon_n) \in \{0, 1\}^N$  and  $\varepsilon_i$  represents a  $\{0, 1\}$ -valued assignment to  $p(A_i) := \text{Prob}(A_i = 1)$ , and the marginals  $p(A_i, A_j), \dots$  are those appearing in the marginal scenario  $\mathcal{M}$ . These extreme points are precisely the projection of the extreme points of the simplex onto the subspace of observable probabilities.

Once these extreme points are defined, the corresponding noncontextuality inequalities can be obtained by computing the half-space representation of the polytope. There are several algorithms for performing this transformation and several implementations of them, such as those given by Avis (2018); Christof and Loebel (2015); Fukuda (2018); Lörwald and Reinelt (2015).

A noncontextuality inequality is of the form  $\boldsymbol{\lambda} \cdot \mathbf{p} \leq \eta$ , where the inequality holds true for any  $\mathbf{p}$  in the noncontextuality polytope. That is, a noncontextuality inequality is a half-space containing the noncontextuality polytope. This inequality is useful only, if it can be violated by a quantum system. We write  $\mathbf{\Pi}$  for the vector of projectors  $\mathbf{\Pi} := (P_1, \dots, P_N, \dots, P_i P_j, \dots, P_{i_1} P_{i_2} \dots P_{i_m}, \dots)$ , in analogy with Eq. (76), such that the  $i$ th entry of the probability vector  $\mathbf{p}$  can be computed from the  $i$ th entry of  $\mathbf{\Pi}$  as  $p_i = \text{tr}(\varrho \mathbf{\Pi}_i)$ . In particular, this analogy requires that each projector (or product of projectors) is associated with an observable (or set of compatible observables), such that the structure of compatibility relations defined by the marginal scenario is reproduced by the projectors  $P_1, \dots, P_N$ . For a nontrivial noncontextuality inequality we have  $\boldsymbol{\lambda} \cdot \text{tr}(\varrho \mathbf{\Pi}) > \eta$ .

The violation of an inequality for a fixed  $\mathbf{\Pi}$  is defined as

$$\Gamma(\boldsymbol{\lambda}) = \frac{\max \{ \boldsymbol{\lambda} \cdot \text{tr}(\varrho \mathbf{\Pi}) \mid \varrho \text{ quantum state} \}}{\max \{ \boldsymbol{\lambda} \cdot \mathbf{p} \mid \mathbf{p} \text{ in NC polytope} \}} - 1. \quad (77)$$

Hence  $\Gamma = 0$  corresponds to the situation where the inequality does not have a violation for the projectors  $\mathbf{\Pi}$ . Note, that both maximizations may be restricted to the extremal points, i.e., the maximization for the quantum value can be performed over the pure states, while for the noncontextuality polytope, it is sufficient to consider all extremal points of the polytope. As a consequence, the validity of a noncontextuality inequality  $\mathbf{m} \cdot \mathbf{x} \leq b$  can be checked by verifying that it is not violated by any vertex of the polytope, for the vertex representation  $\text{conv}(v_1, \dots, v_k)$ , and by linear programming if the description of the polytope is given in terms of half-spaces  $\{\mathbf{x} \mid \mathbf{A}\mathbf{x} \leq \mathbf{b}\}$ , i.e., as  $\max_{\mathbf{x}} \mathbf{m} \cdot \mathbf{x}$  subject to  $\mathbf{A}\mathbf{x} \leq \mathbf{b}$ .

Similarly, given a probability vector  $\mathbf{p}$ , one can check to see if it belongs to a given noncontextuality polytope via a LP. If not, this LP provides, via its dual formulation, a noncontextuality inequality violated by  $\mathbf{p}$ . One example of this is given by the *contextual fraction* (CF) LP (Abramsky *et al.*, 2017; Abramsky and Brandenburger, 2011; Amselem *et al.*, 2012), which we encountered in Sec. IV.A.4 in connection with the notion of *strong contextuality*. It is instructive to repeat its definition here, in order to directly connect it to the noncontextual polytope. In simple terms, the noncontextual fraction (NCF = 1 - CF) is the maximum  $\alpha \in [0, 1]$  such that  $\mathbf{p}$  can be decomposed as  $\mathbf{p} = \alpha \mathbf{p}_{\text{NC}} + (1 - \alpha) \mathbf{p}_{\text{C}}$ , where  $\mathbf{p}_{\text{NC}}$  is a vector belonging to the noncontextuality polytope and  $\mathbf{p}_{\text{C}}$  a vector belonging to the nondisturbing polytope. Since both  $\mathbf{p}_{\text{NC}}$  and  $\mathbf{p}_{\text{C}}$  can be characterized in terms of LP, that the noncontextual fraction can be computed as a LP. The contextual fraction can also be interpreted as a geometric quantification of contextuality. In Sec. V.E, we discuss its role in the resource theory of contextuality. Several related questions are addressed in the following sections, such as the identification of the interesting contextuality scenarios, i.e., giving rise to some  $\Gamma > 0$ , or even SI-C scenarios, the computation of quantum bounds, etc.

An analogous approach, based on ideas on convex optimization, polyhedral sets and linear programming, can be developed for the analysis of entropy, rather than probability. Following the idea initially developed by Braunstein and Caves (1988), Chaves (2013); Chaves and Fritz (2012); Durucan and Grinbaum (2020); Fritz and Chaves (2013); Kurzyński *et al.* (2012); Raesi *et al.* (2015) investigated entropic noncontextuality inequalities. In particular, Chaves and Fritz (2012) and Fritz and Chaves (2013) developed a systematic method to derive noncontextuality inequalities for an arbitrary marginal scenario, which can be described as follows. In the entropic approach, one can derive the entropic inequalities by projecting the entropic cone, describing the joint entropies over all variables, onto the variables corresponding to the observed marginals, in analogy with the projection of the previously described probability simplex. A complete characterization of the entropy cone is not known for more than three variables. However, an outer approximation in terms of the so-called Shannon inequalities is known; see Yeung (2008) for an introduction. In contrast to the probability case, entropic inequalities provide only a necessary condition for noncontextuality, except in some special cases (Chaves, 2013).

Finally, a case not covered in the correlation polytope approach is the continuous-variable (CV) case. The first proposal of a CV contextuality test was presented by Plastino and Cabello (2010) for a CV version of the PM square based on modular variables. The argument was further improved by (Asadian *et al.*, 2015), removing one assumption from the NCHV model (classical complex variables of modulo 1). The same scenario was further explored by (Laversanne-Finot *et al.*, 2017), who considered

more general observables. More recently, Soares Barbosa *et al.* (2019) presented a general framework for the investigation of CV contextuality.

## B. Graph theory and contextuality

Since the original paper of Kochen and Specker (1967), graphs have played a central role in contextuality arguments. In the following, we discuss the connection between contextuality and graph theory, with particular emphasis on two types of graphs, namely, *compatibility graphs* and *exclusivity graphs*. We review several problems that can be formulated in terms of graph properties and graph-theoretic results. This comprises the following questions: Which compatibility structures always admit a noncontextual hidden-variable model? Or, equivalently, which structures are interesting for contextuality? How can we derive noncontextuality inequalities and compute the corresponding quantum bound efficiently? Which scenarios give rise to state-independent contextuality?

### 1. Basic notions

We start by introducing basic notions and definitions in graph theory. Extensive discussions of this topic were given by in Beeri *et al.* (1983); Bretto (2013); Diestel (2018); Lauritzen (1996). A *graph* is a pair  $G = (V, E)$  where  $V$  is the set of vertices, or nodes, and  $E$  is the set of edges, i.e., unordered pairs  $(i, j)$  for some  $i, j \in V$ . Two vertices  $i, j \in V$  of a graph are *adjacent*, or *connected*, if  $(i, j) \in E$ . A set of mutually connected vertices is called a *clique* of the graph. A set of vertices such that no two of them are connected is called an *independent set*. A *path* is a sequence of distinct vertices  $v_0, \dots, v_n$  such that  $v_i$  is connected to  $v_{i+1}$ , for  $i = 0, \dots, n-1$ . A *cycle* is defined in the same way, but with  $v_0 = v_n$ . A graph is an *acyclic*, or a *tree*, graph, if it contains no cycle. A graph is *triangulated*, or *chordal*, if every cycle of length  $n \geq 4$  contains a *chord*, i.e., an edge connecting  $(v_i, v_{i+2})$ . The *complement* of a graph  $G = (V, E)$  is a graph  $\bar{G} = (V, \bar{E})$  where  $\bar{E} = \{(i, j) | i, j \in V\} \setminus E$ , i.e., every pair of connected vertices in  $G$  is disconnected in  $\bar{G}$  and vice versa.

A *hypergraph* is a generalization of the above idea obtained by allowing edges to connect more than two vertices, namely, a pair  $H = (V, E)$ , where  $V$  is the set of vertices and  $E$  the set of hyperedges, i.e.,  $E \subset 2^V$ , with  $2^V$  the power set of  $V$ . Hypergraphs can also arise from graphs; for instance, the clique hypergraph  $H$  of a graph  $G$  is defined by the same set of vertices and has as hyperedges the cliques of  $G$ . If a hypergraph contains only maximal hyperedges, i.e., for each hyperedge  $E$  there is no hyperedge  $E'$  such that  $E' \subset E$ , the graph is said to be *reduced*. Given a hypergraph  $H$ , we say that  $H'$  is the *reduced hypergraph* of  $H$  if it is obtained from  $H$  by

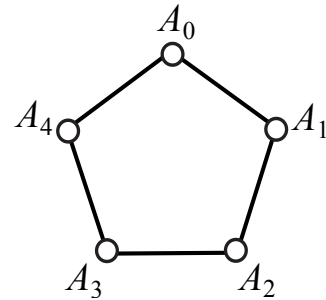

FIG. 17 Compatibility graph associated with the observables of the KCBS scenario corresponding to the marginal scenario  $\{(A_i, A_{i+1})\}_{i=0}^4$ . This graph can also be used to illustrate the basic notions of path, cycles, and independent sets. A path is given by any sequence of sequentially connected vertices, such as  $(A_i, A_{i+1}, A_{i+2})$ , for any  $i$  and with sum modulo 5. A cycle is a closed path such as  $(A_0, A_1, \dots, A_4, A_0)$ . An independent set is a set of disconnected vertices such as  $(A_i, A_{i+2})$ . The pentagon contains independent sets of at most size 2. One can easily show that the complement of a pentagon is again a pentagon with edges  $(A_i, A_{i+2})$ , for  $i = 0, \dots, 4$  and sum modulo 5.

removing all nonmaximal hyperedges.

As opposed to the case of graphs, different notions of acyclicity are possible for hypergraphs. The relevant one for us is given by the following two equivalent definitions. First, a hypergraph is acyclic if it has the *running intersection property*, i.e., if there exists an ordering of the hyperedges,  $E_1, \dots, E_n$ , such that

$$E_i \cap (E_1 \cup \dots \cup E_{i-1}) \subset E_j, \text{ with } j < i, \text{ for all } i. \quad (78)$$

Namely, there exists an ordering such that the intersection with any new hyperedge is completely contained in one of the previous hyperedges. Second, an equivalent definition is that a hypergraph is acyclic if it is the clique hypergraph of a triangulated graph.

Their equivalence is not obvious, see Beeri *et al.* (1983); Lauritzen (1996); however, one can easily verify that these definitions coincide in the case of hyperedges of cardinality 2 with that of trees for graphs. We see here that the running intersection property plays a central role in the construction of NCHV models. This notion is usually called  $\alpha$  *acyclicity* in the literature (Beeri *et al.*, 1983; Lauritzen, 1996). In the following, we refer to it simply as acyclicity.

### 2. Graphs, hypergraphs, and marginal scenarios

In the abstract formulation of NCHV in Sec. IV.A.1, we defined a marginal scenario  $\mathcal{M}$  as the set of all contexts for a given set of measurements  $A_1, \dots, A_n$ . A natural representation of a marginal scenario is given by a hypergraph  $H$ : vertices represent measurements, whereas hyperedges represent contexts; see also Acín *et al.* (2015); Amaral and Terra Cunha (2018). Here we

consider the most general structure possible without entering into the details of the specific way of realizing such contexts in practice, as discussed in Sec. IV.B. Given its relevance, we often discuss the specific case of sharp measurements. For sharp measurements in quantum mechanics, *Specker's principle* applies (Cabello, 2012; Kochen and Specker, 1967; Specker, 1960), namely that pairwise compatibility is equivalent to global compatibility. For this reason for sharp measurements it is enough to represent the marginal scenario as a graph, interpreting edges as pairwise compatibility relations and cliques as contexts. For the case of sharp measurements, we call such graphs *compatibility graphs*. It is interesting to notice that any graph can be interpreted as such a compatibility graph for sharp measurements, in the sense that these compatibility relations can be realized by a set of sharp observables on a Hilbert space (Heunen *et al.*, 2014). Similarly, if one considers contexts simply as sets of jointly measurable observables, then every hypergraph can be interpreted as a set of joint-measurability relations for a given set of POVMs (Kunjwal *et al.*, 2014). We recall that we discussed in Sec. IV.B the problems associated with possible definitions of contexts requiring joint-measurability alone.

Notice that the previous notion of compatibility hypergraph should not be confused with the hypergraph approach of Acín *et al.* (2015), who instead represented effects as nodes and some results, such as the identification of cliques with contexts in the case of sharp measurements, do not hold. An example of a compatibility graph is given in Fig. 17 for the KCBS scenario. Each vertex represents a measurement setting  $A_0, \dots, A_4$ , and edges connect vertices corresponding to two joint measurement  $\langle A_i A_{i+1} \rangle$  appearing in the KCBS inequality (Klyachko *et al.*, 2008).

Budroni and Morchio (2010); Kurzyński *et al.* (2012); Ramanathan *et al.* (2012) investigated graph-theoretical properties of the marginal scenario hypergraph (or the compatibility graph for sharp measurements) that directly imply the existence of a NCHV regardless of the value of the observed correlations. These represent special cases of a general result for marginal scenario hypergraphs that follows from a theorem by Vorob'ev (or Vorob'yev, depending on the transliteration from the Cyrillic alphabet used), which can be stated in our terminology as follows:

**Theorem (Vorob'ev, 1962).** Any marginal scenario represented by an acyclic hypergraph admits a joint probability distribution.

The theorem was originally stated by Vorob'ev (1959) [translate into English as Vorob'yev (1967)] and later proven by Vorob'ev (1962); see also Vorob'ev (1963). The same result was also independently proven by Kellerer (1964a,b); Malvestuto (1988).

The Vorob'ev theorem says that, given a set of probabilities associated with a marginal scenario and coinciding on their intersection, if their structure is repre-

sented by an acyclic hypergraph, then there is always a probability distribution for which they are the marginals. Intuitively, Vorob'ev's result can be understood as the construction of a global probability by “gluing together” probability distributions on their intersection, a notion referred to as “adhesivity” (Matúš, 2007a). The acyclicity property of hypergraphs, particularly the running intersection property, guarantees that such a construction can always be made in a consistent way. It is instructive to illustrate this idea with the simplest example, which follows. Consider three variables  $A, B$  and  $C$  and two distributions  $p_1(a, b)$  and  $p_2(b, c)$ , such that  $\sum_a p_1(a, b) = \sum_c p_2(b, c) =: p(b)$ . This corresponds to a marginal scenario described by a line graph  $A - B - C$ , which is acyclic. One can explicitly construct a joint distribution on  $A, B$  and  $C$  by “gluing” the distributions on their intersection, namely

$$p(a, b, c) := \frac{p_1(a, b)p_2(b, c)}{p(b)} = p_1(a|b)p_2(c|b)p(b), \quad (79)$$

with the convention that  $p(a, b, c) := 0$  if  $p(b) = 0$ . This is precisely the construction used by Fine (1982a) to prove that CHSH inequalities are necessary and sufficient conditions for the existence of local hidden-variable models in the case of two inputs and two outputs.

Vorob'ev's result has been discussed in relation to contextuality (Soares Barbosa, 2014, 2015; Xu and Cabello, 2019) and causal discovery methods (Budroni *et al.*, 2016). This result has implication for the computation of correlation polytopes and entropic cones associated with noncontextuality scenarios (Araújo *et al.*, 2013; Budroni and Cabello, 2012; Kujala *et al.*, 2015) and more general causal structures (Budroni *et al.*, 2016; Chaves *et al.*, 2014). Notice that such a result is also at the basis of the derivation of non-Shannon inequalities in classical information theory (Matúš, 2007b; Zhang, 2003).

For the case of compatibility graphs, it is sufficient to verify that the graph is triangulated, since the corresponding hypergraph of contexts, the clique hypergraph, is acyclic according to the previous definition; see the discussion given by Xu and Cabello (2019) for additional details. The previous result has allowed for the identification of the simplest noncontextuality scenarios. The argument presented by Kurzyński *et al.* (2012) can be summarized as follows. The simplest compatibility graph giving rise to contextual correlations must contain a cycle with a length larger than 3; i.e., it is a square corresponding to the CHSH scenario (Clauser *et al.*, 1969). For sharp measurements, such a graph can be obtained only in dimension  $d = 4$ . For  $d = 3$ , one needs at least a pentagon, which precisely corresponds to the KCBS scenario (Klyachko *et al.*, 2008). This can be seen as follows: A nontrivial sharp measurement in  $d = 3$  is represented by the POVM  $\{|v\rangle\langle v|, \mathbb{1} - |v\rangle\langle v|\}$  since it cannot be the identity and it cannot be nondegenerate, otherwise compatibility becomes a transitive relation (Correggi and Morchio, 2002), giving rise only to a collection of fully connected graphs, hence, always admitting a

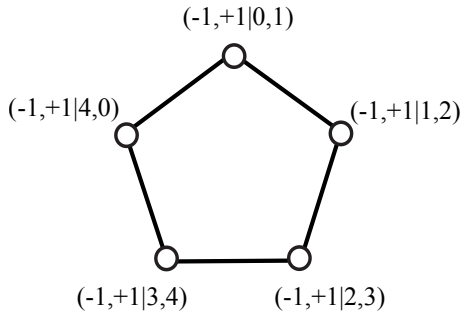

FIG. 18 Exclusivity graph associated with the five events appearing in the inequality (80). The notation  $(-1,+1|0,1)$  refers to the event of outcome  $-1$  for the measurement of  $A_0$  and outcome  $+1$  for the measurement of  $A_1$ , etc.

NCHV. The compatibility of two measurements, with associated rank-1 projectors  $|v\rangle\langle v|$  and  $|w\rangle\langle w|$ , corresponds to  $\langle v|w\rangle = 0$ . Since two nonorthogonal vectors in  $d = 3$  have a unique orthogonal subspace, it is impossible to get a square compatibility graph with four different measurements.

### 3. Exclusivity graphs and their independence, Lovász, and fractional packing numbers

In this section, we introduce the notion of an exclusivity graph (namely a graph where connected vertices represent mutually exclusive events), and discuss the significance of associated graph-theoretical quantities such as the *independence number*, *Lovász number*, and *fractional packing number*, following the discussion presented by Cabello, Severini, and Winter (CSW, 2014).

Given a measurement context, denoted by compatible settings  $(s_1, \dots, s_n)$ , an *event* corresponds to a given set of joint outcomes  $(o_1, \dots, o_n | s_1, \dots, s_n)$ . Two events  $(o_1, \dots, o_n | s_1, \dots, s_n)$  and  $(o'_1, \dots, o'_n | s'_1, \dots, s'_n)$  are said to be *exclusive* if there are  $i$  and  $j$  such that  $s_i = s'_j$  but  $o_i \neq o'_j$ . In other words, two events are exclusive if at least one pair of measurement settings coincides, but they have different outcomes.

It is helpful to consider in detail a simple example given by the graph in Fig 18: each vertex represents two possible outcomes for two settings, and two vertices are connected by an edge if the corresponding events are mutually exclusive. Such a graph represents a version of the KCBS noncontextuality, namely Eq. (26) (discussed in Sec. IV.A.5),

$$S_{\text{KCBS}} = \sum_{i=0}^4 p(-1,+1|i,i+1) \stackrel{\text{NCHV}}{\leq} 2, \quad (80)$$

where  $p(-1,+1|i,i+1) \equiv \text{Prob}(A_i = -1, A_{i+1} = 1)$  and the sum is taken modulo 5.

For the specific choice of quantum observables in the KCBS scenario discussed in Sec. IV.A.2, such events

are represented by projectors, such as  $(-1,+1|i,i+1) \mapsto Q_i$  and  $p(-1,+1|i,i+1) = \text{tr}(\rho Q_i)$ , where  $Q_i := \Pi_i^+ \Pi_{i+1}^-$  and  $\Pi_i^\pm$  is the projector associated with the outcome  $\pm 1$  of  $A_i$ . Mutually exclusive events correspond to orthogonal projectors, such as  $Q_i Q_{i+1} = (\Pi_i^+ \Pi_{i+1}^-)(\Pi_{i+1}^+ \Pi_{i+2}^-) = 0$ .

Cabello *et al.* (2014) noticed the similarity between Eq. (80) and the definition of the Lovász number of a graph. The Lovász number was introduced by Lovász (1979) as an upper bound on the Shannon capacity of a graph (Shannon, 1956). It is a well-studied object in graph theory, and it can be efficiently computed via semidefinite programming (Lovász, 2009). For a graph  $G = (V, E)$  its Lovász number  $\vartheta$  is given by

$$\vartheta(G) = \max_{v_i, \psi} \sum_{i \in V} |\langle \psi | v_i \rangle|^2, \quad (81)$$

where the maximum is taken over all vectors  $|\psi\rangle$  and over all vectors  $|v_i\rangle$  such that  $\langle v_i | v_j \rangle = 0$  whenever  $i, j \in V$  are adjacent vertices. This set of vectors is also called an *orthogonal representation* (OR) of  $\bar{G}$ , the complement of  $G$ . Notice that the OR of a graph is defined by the fact that nonadjacent nodes are associated with vectors that are orthogonal (Lovász, 2009), which is why we consider the complement graph  $\bar{G}$  to define the OR entering Eq. (81). This seemingly counterintuitive convention might be due to the original definition of Shannon capacity of a confusability graph (Shannon, 1956), see Sec. VI.D.1 for more details, where nodes represent symbols of an alphabet and edges their “confusability”, whereas in our case edges represent exclusivity. For this reason, some researchers prefer instead to work directly with the complement graph, i.e., the nonorthogonality graph (Acín *et al.*, 2015).

The maximum of the expression  $S_{\text{KCBS}}$  in QM can in fact be written as

$$\max_{\rho, Q_i} \sum_i \text{tr}(\rho Q_i) = \max_{v_i, \psi} \sum_{i \in V} |\langle \psi | v_i \rangle|^2 = \vartheta(G), \quad (82)$$

where each vertex of the graph  $G = (V, E)$  corresponds to a projector appearing on the lhs of (82) and two vertices are adjacent if the corresponding projectors are orthogonal. Notice that with the previous definition of the Lovász number, the quantum maximum of  $S_{\text{KCBS}}$  is given by the Lovász number of the exclusivity graph. Moreover, the use of a pure state  $|\psi\rangle$  instead of  $\rho$  is no restriction since, by a convexity argument, the maximum of  $S_{\text{KCBS}}$  is always achieved by pure states. Similarly, the use of one-dimensional projectors  $|v_i\rangle\langle v_i|$  is no restriction, since for an arbitrary projector  $Q_i$ , we have  $\langle \psi | Q_i | \psi \rangle = |\langle \psi | v_i \rangle|^2$  where  $|v_i\rangle := Q_i |\psi\rangle / \sqrt{\langle \psi | Q_i | \psi \rangle}$ .

In addition to the Lovász number, two other graph-theoretical quantities are central to the discussion on correlation bounds in different theories: the independence number  $\alpha$  and the fractional packing number  $\alpha^*$ . The former is defined as the cardinality of the maximal independent set of a graph, which can be interpreted as

the maximum number of 1's, i.e., as logically true, that can be assigned to a set of vertices without violating the exclusivity condition, namely

$$\alpha(G) = \max_{c_i} \sum_{i \in V} c_i, \quad (83)$$

such that  $c_i = 0, 1$ ,  $c_i c_j = 0$  if  $(i, j) \in E$ .

In terms of the NCHV models with additional exclusivity constraints (NCHV+E) discussed in Sec. IV.A.5,  $\alpha$  can be interpreted as the maximum of deterministic assignments that respects the exclusivity condition, namely, that two adjacent vertices cannot both be assigned the value 1.

The fractional packing number is a linear program relaxation of the independence number, namely, the maximum sum of weights such that in every clique the sum of weights is 1,

$$\begin{aligned} \alpha^*(G) &= \max_{p_i} \sum_{i \in V} p_i, \text{ such that } p_i \geq 0, \\ &\text{and } \sum_{i \in C} p_i \leq 1 \text{ for all cliques } C. \end{aligned} \quad (84)$$

The interpretation is as follows. Probabilities for single events are identified regardless of the context and the sum of probabilities of exclusive events within each context is less than or equal to 1. This can be interpreted as a bound for *generalized probability theories* (GPTs) that still respect some notion of exclusivity within each context, i.e., sum of probabilities below one. We return to this notion of exclusivity later.

In summary, the different graph-theoretical quantities, i.e.,  $\alpha$ ,  $\vartheta$ , and  $\alpha^*$ , provide information on the bounds on correlations for different theories, classical, quantum, and generalized probability theories, respectively. For the expression  $S_{\text{KCBS}}$  in Eq. (80), we know that the Lovász number provides a tight bound, i.e., it can be achieved in quantum mechanics. More precisely, in the KCBS case there are sharp measurements  $A_0, \dots, A_4$ , with  $A_i = \{\Pi_i^+, \Pi_i^-\}$  such that the events  $(+1, -1|i, i+1)$  are exclusive and the rank-1 projectors  $|v_i\rangle\langle v_i|$  maximizing Eq. (81) are given by  $|v_i\rangle\langle v_i| = \Pi_i^+ \Pi_{i+1}^-$ , as discussed in Sec. IV.A.2.

Depending on the specific assumptions on the measurement scenario, however, the bounds obtained by the Lovász number may not be tight. A typical example is the pentagon (Sadiq *et al.*, 2013), which is interpreted as the exclusivity graph of a subset of events in the CHSH scenario, i.e., of the form  $(a, b|x, y)$ , with  $x$  the setting of Alice and  $y$  of Bob. The reason why this bound is not tight is that in order to interpret these events in the CHSH scenario, we need additional compatibility constraints on the measurements, in order for them to be distributed between two parties. In other words, Alice's observables are compatible with Bob's, a condition that is not encoded in the exclusivity graph. A possible extension of the exclusivity graph approach to nonlocality

scenarios via multigraphs, encoding the separation into different parties, was proposed by Rabelo *et al.* (2014).

This situation, however, is not specific to Bell scenarios, but happens also for contextuality scenarios if additional assumptions on the compatibility relations among measurements are made. In other words, the situation occurs if one wants to reconstruct not only the effect operators but also the original observables and their compatibility relations. This is similar to what happens in the Navascués-Pironio-Acín (NPA) characterization of multipartite quantum correlations (Navascués *et al.*, 2007, 2008), and this is the reason why one needs to define a hierarchy of SDP conditions rather than a single one. In fact, even if the single operators  $|v_i\rangle\langle v_i|$  can be reconstructed by the Lovász number SDP, it is not clear that one can reconstruct the observables, such as  $\{A_{a|x}\}_{a,x}$  and  $\{B_{b|y}\}_{b,y}$  associated with the events  $(a, b|x, y)$  in a Bell scenario, of which they are assumed to be effects, with the correct compatibility (in this case, commutativity) relations among them.

An alternative approach involves taking the notion of observables and contexts as our starting point and developing from there the exclusivity relations: given the observables  $\{A_{o|s}\}_{o,s}$ , one constructs all possible events, i.e., for each context  $C$  all the events  $p(o_1, \dots, o_{|C|} | s_1, \dots, s_{|C|})$ , constituting the nodes of the hypergraph, whereas the hyperedges are defined using the previously mentioned exclusivity relations (at least two identical settings with different associated outcomes). The hypergraph-theoretic approach to contextuality introduced and extensively investigated by Acín, Fritz, Leverrier, and Sainz (AFLS, 2015) describes sets of exclusive events precisely keeping track of this structure. More precisely, in the AFLS approach, the hypergraph of effects (nodes) and exclusivity relations (hyperedges) keeps information on which collection of effects correspond to the measurements performed in the specific physical situation considered. In contrast, in the CSW approach, one starts from the effects (nodes) and their exclusivity relations (edges) and tries to construct a general noncontextuality inequality, as we later explain.

We now discuss how one can find noncontextuality inequalities in the graph approach. Here, one starts from an exclusivity graph, such as one for which it is known that  $\alpha(G) < \vartheta(G)$ , and interprets it as a compatibility graph, i.e. promotes each single event to a measurement. An associated noncontextuality inequality can be constructed such that the classical and quantum bounds correspond to the independence and Lovász number, respectively. A general method was presented in the original paper (Cabello *et al.*, 2014), however, here we discuss a slightly different (and arguably simpler) approach since we already encountered it in the KCBS example in Sec. IV.A.5. This approach is based on a general method to transform KS inequalities into NC inequalities; see Cabello (2016); Yu and Tong (2014) for additional details.

We assume that we have a graph  $G$  such that  $\alpha(G) < \vartheta(G)$  and want to construct a noncontextuality inequality

ity and provide a state and sharp quantum observables, with the correct compatibility relations, able to show a violation of the inequality. To construct the NC model, with each node of the graph  $G = (V, E)$  we associate a classical variable  $P_i$  with values in  $0, 1$ . We write  $\text{Prob}(P_i = 1) =: \langle P_i \rangle$  and the joint probability  $\text{Prob}(P_i = 1, P_j = 1) =: \langle P_i P_j \rangle$ . From the independence number we can derive the following bound for NCHV models with the additional exclusivity assumption among connected events (see Sec. IV.A.5), namely,

$$\sum_{i \in V} \langle P_i \rangle \stackrel{\text{NCHV+E}}{\leq} \alpha(G). \quad (85)$$

The meaning of Eq. (85) is that the bound of  $\alpha(G)$  is valid only in NCHV models where events satisfy additional exclusivity relations, corresponding to those encoded in the graph  $G$ , namely, connected nodes cannot both be assigned the value 1. Following the discussion in Sec. IV.A.5, we transform the Eq. (85) into a general noncontextuality inequality as follows

$$\sum_{i \in V} \langle P_i \rangle - \sum_{(i,j) \in E} \langle P_i P_j \rangle \stackrel{\text{NCHV}}{\leq} \alpha(G). \quad (86)$$

Intuitively, whenever the noncontextual assignments do not respect the exclusivity condition the lhs gets a penalty that keeps the noncontextual bound the same. We denote by  $\mathcal{A} \subset \{P_i\}_i$  the subset of variable to which 1 is assigned. It can be divided into an assignment to a maximal independent set  $\mathcal{I}$  plus some extra variables  $\mathcal{E}$ , i.e.,  $\mathcal{A} = \mathcal{I} \cup \mathcal{E}$ . Each variable  $P_i \in \mathcal{E}$ , however, must violate at least one exclusivity constraint involving an element of  $\mathcal{I}$  since  $\mathcal{I}$  is a maximal independent set by definition, thus giving a factor  $+1$  for the first term and a factor  $\leq -1$  for the second term on the lhs of Eq. (86). The quantum model can be constructed from the OR of  $\overline{G}$  as in Eq. (81), namely, vectors  $\{|v_i\rangle\}_i$  and a state  $|\psi\rangle$  such that  $\langle v_i | v_j \rangle = 0$  if  $(i, j) \in E$  and

$$\sum_i |\langle \psi | v_i \rangle|^2 = \vartheta(G). \quad (87)$$

By constructing the POVMs  $\tilde{P}_i = \{|v_i\rangle\langle v_i|, \mathbb{1} - |v_i\rangle\langle v_i|\}$  and considering the initial state  $\rho = |\psi\rangle\langle\psi|$ , one obtains  $\langle \tilde{P}_i \rangle_\rho = |\langle \psi | v_i \rangle|^2$  and  $\langle \tilde{P}_i \tilde{P}_j \rangle_\rho = \langle \psi | \tilde{P}_i \tilde{P}_j | \psi \rangle = 0$ , whenever  $(i, j) \in E$ . As a consequence, one obtains

$$\sum_{i \in V} \langle \tilde{P}_i \rangle - \sum_{(i,j) \in E} \langle \tilde{P}_i \tilde{P}_j \rangle_\rho = \sum_i |\langle \psi | v_i \rangle|^2 = \vartheta(G) > \alpha(G), \quad (88)$$

giving a violation of the noncontextuality inequality in Eq. (86).

In addition to classical, quantum and GPT bounds for a given expression, the exclusivity graph approach also allows for the definition of the set of their correlations through the notions of stable set polytope  $\text{STAB}(G)$ , theta body  $\text{TH}(G)$ , and clique constrained stable set

polytope  $\text{QSTAB}(G)$  of a given exclusivity graph  $G$ ; see Amaral and Terra Cunha (2018); Cabello *et al.* (2014) for a detailed discussion. These sets are closely related to the previously defined quantities  $\alpha, \vartheta$  and  $\alpha^*$ :

$$\begin{aligned} \text{STAB}(G) &= \text{conv} \left\{ x \in \{0, 1\}^{|V|} \mid x_i x_j = 0 \text{ if } (i, j) \in E \right\}, \\ \text{TH}(G) &= \left\{ p \in \mathbb{R}_+^{|V|} \mid p_i = |\langle \psi | v_i \rangle|^2, \{ |v_i\rangle \}_i \text{ OR of } \overline{G} \right\}, \\ \text{QSTAB}(G) &= \left\{ p \in \mathbb{R}_+^{|V|} \mid \sum_{i \in C} p_i \leq 1, \forall \text{ cliques } C \right\}. \end{aligned} \quad (89)$$

In other words,  $\text{STAB}(G)$  is given by the probability vectors in the convex hull of the deterministic assignments respecting exclusivity, i.e., of 1 to all the elements of an independent (or stable) set and 0 to the other elements, as in Eq. (83);  $\text{TH}(G)$  is given by the assignment coming from a vector  $|\psi\rangle$  and the vectors of an orthogonal representation of  $\overline{G}$ , as in Eq. (81); and  $\text{QSTAB}(G)$  is the set of probability assignments such that the sum of probability on each clique is bounded by 1 as in Eq. (84). These sets can also be characterized in terms of the quantities  $\alpha, \vartheta$  and  $\alpha^*$ , but in reverse order with respect to what we have seen (Acín *et al.*, 2015), arising from a dual approach in their description (Grötschel *et al.*, 1993; Knuth, 1994).

The notion of the stable set polytope  $\text{STAB}(G)$  and the theta body  $\text{TH}(G)$  also allowed the minimal Greenberger-Horne-Zeilinger-like proof of contextuality to be found. This was then shown to imply that the 18 vectors found by Cabello *et al.* (1996a), see also Fig. (3), is the minimal Kochen-Specker set (Xu *et al.*, 2020).

The set  $\text{QSTAB}(G)$  encodes the condition that the probability of mutually exclusive events (represented by a clique in  $G$ ) is bounded by 1, a condition that was introduced under the name consistent exclusivity principle for contextuality (Cabello, 2012) [see also (Acín *et al.*, 2015; Henson, 2012)], or  $E$ -principle (Cabello, 2013)), and *local orthogonality* for Bell nonlocality (Fritz *et al.*, 2013). This condition has been extensively investigated as a possible principle that bounds contextual and nonlocal correlations in QM (Acín *et al.*, 2015; Amaral *et al.*, 2014; Cabello, 2013, 2015; Fritz *et al.*, 2013; Henson, 2015; Yan, 2013).

In the hypergraph approach, Acín *et al.* (2015) showed that consistent exclusivity cannot bound the set of quantum correlations, even in the limit of an infinite number of copies of the original hypergraph, with the following argument. They showed that the set of probability vectors, i.e., with the normalization condition  $\sum_i p_i = 1$ , obtained in this limit is the one characterized to the Shannon capacity of a graph (Shannon, 1956), which includes the set  $\text{TH}(G) \cap \{\sum_i p_i = 1\}$ , i.e., the theta body with extra normalization constraints. As discussed above for the CHSH case, when the scenario constraints are imposed, i.e. each event is associated to a collection of outcomes for a joint measurement, the Lovász number provides only an upper bound to quantum correlations. Moreover, Acín

*et al.* (2015) show that the set  $\text{TH}(G) \cap \{\sum_i p_i = 1\}$  corresponds to the first level of a NPA-type hierarchy associated with the hypergraph; see also Navascués *et al.* (2015).

By not fixing the measurement scenario and simply discussing events and their exclusivity relations, the graph approach provides a different perspective on the derivation of quantum bounds on correlations. The results of this research direction are summarized in Sec. V.B.4.

#### 4. The graph approach and the quest for a principle for quantum correlations

In the context of the program initiated by Cirel'son (1980) [or Tsirelson depending on the transliteration; see also Tsirelson (1993)] for finding simple characterizations of the sets of quantum correlations for Bell scenarios, Popescu and Rohrlich (1994) asked the following question: Why are correlations in nature not more nonlocal? Principles such as nontrivial communication complexity (van Dam, 1999), information causality (Pawłowski *et al.*, 2009), macroscopic locality (Navascués and Wunderlich, 2010), and local orthogonality (Fritz *et al.*, 2013) managed to exclude some nonquantum nonlocal correlations. However, none of them managed to single out even the set of quantum correlations for the simplest Bell scenario (Navascués *et al.*, 2015).

A different approach to the problem of finding a principle for quantum correlations is the observation that quantum theory, understood as the abstract probability theory behind quantum mechanics by Chiribella *et al.* (2010); Hardy (2001); Masanes and Müller (2011), can be seen as a probability theory for events produced by ideal measurements. This follows from two observations.

On the one hand, not only is a self-adjoint operator a tool to compute the probabilities of an observable, it also represents an ideal measurement of the observable, i.e., a measurement that does not disturb any compatible observable and yields the same result when repeated (Chiribella and Yuan, 2014, 2016; Kleinmann, 2014).

On the other hand, Naimark's (or Neumark's, depending on the transliteration) dilation theorem (Neumark, 1940a,b, 1943), shows that any POVM can be obtained from a projective measurement on a larger Hilbert space. This implies that in a Bell scenario nonideal measurements cannot produce correlations that cannot be attained with ideal measurements.

The first observation points out the special role of ideal measurements in quantum theory. The second observation suggests that, to find a principle for quantum correlations (in Bell scenarios and, in the process, in KS scenarios with ideal measurements), an interesting question is as follows: Why are correlations between ideal measurements in nature not more contextual (Cabello *et al.*, 2010)?

The graph-theoretical approach introduced in Cabello *et al.* (2010, 2014) substantially departs from previous

approaches to principles for quantum correlations. While the standard approach investigates principles explaining correlations once the measurement scenario is fixed, the graph-theoretic approach addresses the question of principles able to explain correlations once the graph of exclusivity relations is fixed.

Given  $n$  events  $\{e_j\}_{j=1}^n$  produced by a set of measurements  $\{M_i\}$  (that also defines a measurement scenario) and an initial state  $\rho$ , one can represent the relations of mutual exclusivity between these events by a an  $n$ -vertex graph in which each event is represented by a vertex (node) and mutually exclusive events are connected by an edge. Recall that two events are mutually exclusive if there is a measurement that produces both of them, with each of them associated with a different outcome.

Given an  $n$ -vertex graph  $G$ , there are infinitely many measurement scenarios producing events whose graph of exclusivity is  $G$ . We consider all pairs  $(\rho, \{M_i\})$ , where  $\rho$  is an initial state and  $\{M_i\}$  is a set of *ideal* measurements, that produce  $n$  events  $\{e_j\}_{j=1}^n$  whose graph of exclusivity is  $G$ . For each pair, there is a set of probabilities  $\{p(e_j)\}_{j=1}^n$ . We denote by  $\mathcal{P}(G)$  the set of all sets  $\{p(e_j)\}_{j=1}^n$ .

Cabello *et al.* (2014) showed that, for any  $G$ , in quantum mechanics  $\mathcal{P}(G) = \text{TH}(G)$ . The fact that this physical set has a simple mathematical characterization suggests the following question: Why in quantum theory does  $\mathcal{P}(G) = \text{TH}(G)$  for any  $G$ ?

We define ideal measurements as those that (i) yield the same result when repeated, (ii) do not disturb any compatible observable, and (iii) can be implemented with all its coarse grainings satisfying (i) and (ii). The events produced by ideal measurements then satisfy the exclusivity principle. Given a set of events such that every pair of them is mutually exclusive, the sum of the probabilities of all of them is bounded by 1 (Cabello, 2019b; Chiribella *et al.*, 2020; Chiribella and Yuan, 2014).

For theories allowing for statistically independent copies of any set  $\{p(e_j)\}_{j=1}^n$  and events satisfying the exclusivity principle (as those originated from ideal measurements), the largest possible  $\mathcal{P}(G)$  is  $\text{TH}(G)$  for any  $G$  (Cabello, 2019b).

Given a Bell or KS scenario with ideal measurements with  $G$  as the graph of exclusivity, the set  $\mathcal{P}(G) = \text{TH}(G)$  is not the set of quantum correlations for this scenario. However, the subset of  $\text{TH}(G)$  obtained after applying the constraints associated with that scenario is the quantum set of correlations for that scenario (Cabello, 2019b). These constraints are: normalization, nondisturbance, and the requirement that the probability of each event must only be a function of the state and measurement outcomes that define it. Cabello (2019a) argued that this suggests a principle for quantum correlations: the totalitarian principle stating that anything not forbidden is compulsory, which is related to the principle of plenitude (Lovejoy, 1936), according to which the Universe should contain all possible forms of existence.



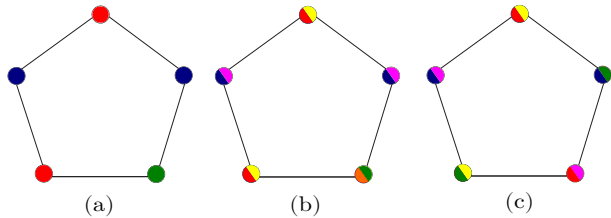

FIG. 19 Different  $a : b$  coloring of the pentagon, i.e.,  $b$  colors associated with each vertex out of  $a$  total colors. (a)  $3 : 1$  coloring of the pentagon, i.e., three colors, one for each vertex, giving a chromatic number  $\chi = 3$ . (b)  $6 : 2$  coloring of the pentagon obtained by doubling the colors for each vertex. (c) One color from the  $6 : 2$  coloring can be removed, giving a  $5 : 2$  coloring corresponding to a fractional chromatic number  $\chi_f = 5/2$  for the pentagon.

## 5. Chromatic and fractional chromatic numbers

The chromatic and fractional chromatic numbers of a graph are also graph-theoretical quantities that play an important role in quantum contextuality, more precisely, in SI-C. In the following, we recall their definition and discuss their relation with contextuality, following the work of Cabello (2011), Ramanathan and Horodecki (2014) and Cabello *et al.* (2015). A  $k$  coloring of a graph  $G$  is an assignment of one out of  $k$  colors to each vertex of a graph such that adjacent vertices are assigned different colors. The minimal number  $k$  such that this coloring is possible is called the *chromatic number* of the graph and is denoted as  $\chi(G)$ . Equivalently, the chromatic number can be understood as the minimal number of partitions of the graph into independent sets. Similarly, the *fractional chromatic number*  $\chi_f(G)$  is the minimum of  $a/b$  such that vertices have  $b$  associated colors, out of  $a$  colors, where again vertices connected by an edge have associated disjoint sets of colors. As a consequence, we have  $\chi_f(G) \leq \chi(G)$ . A simple example of chromatic and fractional chromatic number for the pentagon is given in Fig. 19.

The chromatic number of a graph is in general a difficult quantity to compute. It is nondeterministic polynomial-time-complete to decide whether a graph admits a  $k$  coloring, except for  $k = 0, 1, 2$  and it is NP hard to compute the chromatic number (Garey and Johnson, 2002). The fractional chromatic number can be defined as a LP relaxation of the chromatic number; hence, it may seem easier to compute. However, computing the fractional chromatic number of a graph is NP hard (Lund and Yannakakis, 1994). Intuitively, this comes from the fact that the LP definition of the fractional chromatic number involves the knowledge of all independent sets of a graph, i.e., all sets of mutually disconnected vertices.

To discuss the connection between SI-C and the chromatic and fractional chromatic numbers, we first need to recall some basic definitions. We call a state-independent noncontextuality (SI-NC) inequality an inequality that,

for a fixed set of measurements, is violated by any initial state. A set of elementary tests that can be used to violate such inequality, is called a SI-C set. A typical example is the Yu-Oh inequality in Eq. (19) and the Yu-Oh set in Fig. 7. A related notion is that of SI-C-graph introduced by Ramanathan and Horodecki (2014). A SI-C-graph is a graph that for any fixed quantum state has a realization in terms of orthogonal projectors; i.e., a projector is associated to each vertex and two projectors are orthogonal if the corresponding vertices in the graph are connected, such that the given state violates a NC inequality. A SI-C set gives rise to a SI-C graph, but the converse is not always true. A typical example (Cabello *et al.*, 2015) is obtained from the Yu-Oh set by increasing the dimension by 1, i.e.,  $v_i \mapsto (v_i, 0)$ , and adding an extra vector orthogonally to all the others, i.e.,  $v_E = (0, 0, 0, 1)$ . The set is no longer a SI-C set, since by preparing the initial state  $|v_E\rangle$ , one would obtain a noncontextual value assignment to all variables, namely, all zero except  $|v_E\rangle\langle v_E|$ . On the other hand, for any pure initial state  $|\psi\rangle$ , one can find a realization of the graph such that the Yu-Oh NC inequality of Eq. (19) is violated. It is sufficient to choose a realization for which  $\langle\psi|v_E\rangle = 0$ . According to Ramanathan and Horodecki (2014), a realization can also be found for any mixed state.

The connection between graph coloring and SI-C has been discussed in the specific case of rank-1 projectors  $\{\Pi_i\}$  with corresponding dichotomic measurements given by  $\{\Pi_i, \mathbb{1} - \Pi_i\}$ . The compatibility graph and the exclusivity graph then coincide, i.e., the projectors are compatible if and only if they are orthogonal, ignoring the trivial case of identical projectors. One can call the corresponding graph the orthogonality graph of  $\{\Pi_i\}$ . We then have the following results proven by (i) Ramanathan and Horodecki (2014) and (ii) Cabello (2011):

**Theorem** (Cabello, 2011; Cabello *et al.*, 2015; Ramanathan and Horodecki, 2014). For a set of rank-1 projectors  $\{\Pi_i\}$  in dimension  $d$ , the conditions (i)  $\chi_f(G) > d$  and (ii)  $\chi(G) > d$ , for the orthogonality graph  $G$ , are necessary for SI-C.

Notice that since  $\chi_f(G) \leq \chi(G)$ , condition (ii) is actually weaker than condition (i). However, condition (ii) has the advantage of being solvable exactly by simple integer arithmetic, while condition (i) is the solution to a linear program.

The condition  $\chi(G) > d$  can be intuitively understood as necessary, since any coloring of the graph with  $d$  different colors assigns different values to each set of  $d$  orthogonal rank-1 projectors (forming a basis in dimension  $d$ ), in particular, it is a consistent assignment of 0 and 1. The appearance of the fractional chromatic number is more puzzling, but it can be more or less straightforwardly derived by transforming the SDP a defining SI-C set  $S = \{\Pi_i\}_i$  (for rank-1 projectors) into a LP by fixing the quantum state to be the maximally mixed one (Cabello *et al.*, 2015). From this LP, one can extract the

weights  $w$  and construct the following SI-NC inequality

$$\sum_i w_i \langle \Pi_i \rangle_\rho - \sum_i w_i \sum_{j \in \mathcal{N}(i)} \langle \Pi_i \Pi_j \rangle_\rho \stackrel{\text{NCHV}}{\leq} 1, \quad (90)$$

which has the property that the maximal NCHV assignment is one respecting exclusivity relations and it is violated by the maximally mixed state with a value  $\chi_f(G)/d > 1$ .

Notwithstanding the computational complexity of such problems, explicit calculations are still possible for small enough graphs. Using this result, it has been proven that Yu-Oh set is the minimal SI-C set in  $d = 3$  (Cabello *et al.*, 2015), namely, that there are no other SI-C-graphs with fewer than 13 vertices in dimension 3. This result was further extended by proving that any SI-C set must contain at least 13 projectors, regardless of the dimension (Cabello *et al.*, 2016b). The previous results are valid under the assumption of rank-1 projectors, however, they have been extended to the case of uniform (i.e., all projectors of the same rank) rank 2 and rank 3 by Xu *et al.* (2021), who were also able to exclude the case of eight arbitrary projectors or fewer.

### C. Connections between the Kochen-Specker and Bell's theorems

The connection between the proofs of the KS theorem and Bell nonlocality arguments has been extensively investigated since the 1970s (Brown and Svetlichny, 1990; Clifton, 1993; Elby, 1990a,b; Elby and Jones, 1992; Kernaghan and Peres, 1995; Krips, 1987; Mermin, 1990b; Redhead, 1987; Stairs, 1978, 1983). On the one hand, any Bell inequality can be interpreted as a noncontextuality inequality and there are methods to convert some noncontextuality inequalities into Bell inequalities violated by quantum theory, see, e.g., Aolita *et al.* (2012); Cabello *et al.* (2012).

Historically, the first results related to this question are those on the so-called KS with locality theorem (Brown and Svetlichny, 1990; Heywood and Redhead, 1983; Kochen, 1970; Redhead, 1987; Stairs, 1983), which later gave rise to the so-called free will theorem (Conway and Kochen, 2006, 2009). Common to all these results is that the KS proof for a single spin-1 particle is expanded into related algebraic proof involving the KS set and a maximally entangled state of two spin-1 particles.

The second wave of results connecting the KS and Bell's proofs were motivated by the GHZ proof of Bell's theorem (Greenberger, Horne, and Zeilinger, 1989). First, it is Mermin's observation that GHZ can be converted into a tripartite Bell inequality (Mermin, 1990a) and a state-independent proof of the KS theorem (Mermin, 1990b, 1993). Second, the observation that Hardy's proof of Bell's theorem (Hardy, 1992, 1993) can be seen as state-dependent version of a KS proof (Cabello *et al.*, 1996a). Finally, it is the GHZ-like proof for

two parties sharing qubits (Cabello, 2001b), which can be seen as originating from the PM KS proof (Mermin, 1990b; Peres, 1990) and which can be converted into a bipartite Bell inequality (Cabello, 2001a) as explained later. Around all these tools, there is an extensive literature adopting different perspectives and names: "all-versus-nothing" proofs (Cabello, 2001a), "nonlocal games" (Cleve *et al.*, 2004), and "quantum pseudotelepathy" (Brassard *et al.*, 2005; Renner and Wolf, 2004).

More recently other methods have been introduced to transform inequalities associated with SI-C scenarios to Bell inequalities (Aolita *et al.*, 2012; Cabello, 2021; Cabello *et al.*, 2012). The simplest approach to the problem is arguably to map single measurements and two-time sequential measurements on a single system into bipartite measurements on a maximally entangled state. Here we approximately follow the discussion given by Cabello (2021) but with a different class of NC inequalities, namely those discussed in Sec. V.B.5. To understand this method, we start with the basic observation that, for the state  $|\Psi\rangle = 1/\sqrt{d} \sum_k |kk\rangle$ ,

$$\langle \Psi | A \otimes B^t | \Psi \rangle = \text{tr}(AB)/d, \quad (91)$$

where the superscript  $t$  represents the transposition with respect to the basis  $\{|k\rangle\}_k$ . In other words, expectation values of bipartite operators on the maximally entangled state are equal (up to a transposition) to the expectation value of their product on the maximally mixed (one party) state  $\mathbb{1}/d$ . Using the fact that in any SI-C scenario the noncontextuality inequality is violated even by the maximally mixed state, we can transform the SI-C scenario into a bipartite Bell inequality. This idea is general and can be applied to a wide variety of scenarios and inequalities. To make a concrete example, we discuss the specific case of noncontextuality inequalities arising from the fractional chromatic number of a SIC-graph from Sec. V.B.5. Given a SI-C set  $\{\Pi_i\}_i$ , we consider the associated SI-NC inequality presented in Eq. (90),

$$\sum_i w_i p(\Pi_i = 1) - \sum_i w_i \sum_{j \in \mathcal{N}(i)} p(\Pi_i = \Pi_j = 1) \leq 1, \quad (92)$$

such that the optimal classical assignment corresponds to one satisfying the exclusivity relations, and violated by the maximally mixed state, with a value  $\chi_f(G)/d > 1$ . This inequality can be transformed into the Bell inequality

$$\begin{aligned} & \sum_i w_i p(\Pi_i^A = \Pi_i^B = 1) - \frac{1}{2} \sum_i w_i \times \\ & \times \sum_{j \in \mathcal{N}(i)} \left[ p(\Pi_i^A = \Pi_j^B = 1) + p(\Pi_i^B = \Pi_j^A = 1) \right] \leq 1 \end{aligned} \quad (93)$$

by distributing a copy of all projectors  $\{\Pi_i\}_i$  to both Alice and Bob, i.e.,  $\Pi_i^A = \Pi_i$  and  $\Pi_i^B = \Pi_i^t$ , where on Bob's projectors the previously mentioned transposition has been applied.

By Eq. (91), we have the value on  $|\Psi\rangle$ ,

$$\begin{aligned}\langle\psi|\Pi_i\otimes\Pi_i^t|\psi\rangle &= \text{tr}(\Pi_i\Pi_i)/d = \text{tr}(\Pi_i)/d, \\ \langle\psi|\Pi_i\otimes\Pi_j^t|\psi\rangle &= \text{tr}(\Pi_i\Pi_j)/d = 0,\end{aligned}\quad (94)$$

if  $i, j$  appear as a correlator in Eq. (92), is the same as that of the lhs of Eq. (92) on the maximally mixed state  $\mathbb{1}/d$ , namely,  $\chi_f(G)/d > 1$ .

For the local hidden-variable bound, one can have an argument similar to that presented by [Cabello \*et al.\* \(2015\)](#) for Eq. (92). The main idea is that the weights  $w_i$  are chosen such that the maximum deterministic value assignment is one that respects the orthogonality conditions among the projectors, i.e., if  $\Pi_i\Pi_j = 0$ , to the corresponding classical variables. We denote them by  $\pi_i$  and  $\pi_j$ , which are assigned one 0 and one 1. Every time that we violate one of these constraints for just one of the parties, say on Alice's side, by flipping the value of  $\Pi_i^A$  we get a factor  $-w_i/2 \sum_{j\in\mathcal{N}(i)} \pi_j^B$ , which decreases the total value (assuming we are violating an orthogonality constraint, so at least one of the  $\pi_j^B$  is not 0). Similarly, if we violate one orthogonality for both  $\Pi_i^A$  and  $\Pi_i^B$ , we get a factor  $w_i - w_i/2 \sum_{j\in\mathcal{N}(i)} (\pi_j^A + \pi_j^B)$ , which is again negative. We therefore find that optimal classical assignments are those respecting the orthogonality relations on both Alice and Bob's side.

The previous construction is a simple one, but other constructions are possible (see the aforementioned corresponding references). In particular, we highlight the fact that some of these constructions, such as that in [Aolita \*et al.\* \(2012\)](#) also enable one to construct Bell inequalities where the quantum and nonsignaling bounds coincide.

The first experiments on what is now called Peres-Mermin Bell inequality were based on the encoding proposed in [Chen \*et al.\* \(2003\)](#) and carried out in [Cinelli \*et al.\* \(2005\)](#); [Yang \*et al.\* \(2005\)](#), and subsequently repeated by the group in Rome, Italy, to improve the violation and fix a conceptual problem with the first experiment ([Barbieri \*et al.\*, 2005, 2007](#)). [Aolita \*et al.\* \(2012\)](#) also reported the results of an improved experiment in Rome. On the basis of the proposal made by [Cabello \(2010\)](#), an experiment with sequential measurements on entangled photons was performed ([Liu \*et al.\*, 2016](#)).

#### D. Classical simulation of quantum contextuality

The fact that quantum mechanics results in different predictions than noncontextual theories leads to the question regarding which contextual theories can simulate the quantum mechanical behavior. More precisely, one can ask, which classical resources are needed in order to classically simulate the quantum behavior in a contextuality experiment.

This question has some precedent in the analysis of Bell scenarios. There, one may ask how much communication between the two parties is needed in order achieve a maximal violation of a Bell inequality. For the case

of the simplest Clauser-Horne-Shimony-Holt inequality, this has been discussed in detail and optimized simulation schemes have been designed ([Cerf \*et al.\*, 2005](#); [Toner and Bacon, 2003](#)).

Concerning contextuality, several contextual models have been designed, such as the PM square ([Blasiak, 2015](#); [La Cour, 2009](#)). In addition, there are general approaches for simulating quantum mechanics with classical models, including contextuality ([van Enk, 2007](#); [Larsson, 2012](#); [Spekkens, 2007](#)). These models, however, were not constructed to be resource efficient, and they do not allow for a clear estimate of the minimal necessary classical resources.

In the following, we discuss models to simulate quantum contextuality in sequential measurements. Such contextual models require some memory to work: For instance, for obtaining the maximal value  $\langle\text{PM}\rangle = 6$  in Eq. (3) one needs to remember the previous measurements in the measurement sequence. Thus, the question arises as to what minimal memory is needed for the simulation. This depends on the underlying computational model and the quantum mechanical correlations that should be simulated. In the following, we first discuss two concrete models and then we mention some more general approaches for simulating temporal correlations.

#### 1. Simulation with Mealy machines

A simple attempt to simulate contextual behavior in sequential measurements is the following ([Kleinmann \*et al.\*, 2011](#)). One assumes a classical automaton with  $k$  internal states. For a given internal state one can ask a certain question (or, in physical terms, perform a certain measurement) and obtains an answer (or, result). After providing the result, the automaton changes its internal state, depending on the measurement that was performed. Therefore, in this model, each internal state is characterized by two discrete functions: One function determines the output, depending on the measurement, and the other function determines the update of the internal state, again in dependence on the measurement.

Such a model is called a Mealy machine ([Mealy, 1955](#)). Given this class of models, one can easily define the memory cost required for a simulation as the minimal number of internal states that is required for a simulation.

This concept is best explained with an example. We focus on the PM square as in Eq. (1). For a simulation, we assume that the automaton has three internal states  $S_1, S_2$ , and  $S_3$ . For each state, we define the automaton

via the tables

$$\begin{aligned}
 S_1: & \begin{bmatrix} + & + & (+, 2) \\ + & + & (+, 3) \\ + & + & + \end{bmatrix}, & S_2: & \begin{bmatrix} + & (+, 1) & + \\ - & + & - \\ - & (-, 3) & + \end{bmatrix}, \\
 S_3: & \begin{bmatrix} + & - & - \\ (+, 1) & + & + \\ (-, 2) & - & + \end{bmatrix}. & & (95)
 \end{aligned}$$

This defines the automaton as follows: Assume that the Mealy machine is in state  $S_1$  and we measure the observable  $\gamma$  of Eq. (1). We then consider the first table at the position of  $\gamma$  (i.e., the last entry in the third row). The simple plus sign at this position indicates that the measurement result will be  $+1$ , while the system stays in state  $S_1$ . If we continue and measure  $C$ , we encounter the entry  $(+, 2)$  which indicates the measurement result  $+1$  and a subsequent change to the internal state  $S_2$ . Being in state  $S_2$ , the second table defines the behavior for the next measurement: For instance a measurement of  $c$  now yields the result  $-1$ , and the system stays in state  $S_2$ .

Thus, starting in  $S_1$  the measurement results for the sequence  $\gamma C c$  are  $+1, +1, -1$ , so the product is  $-1$  in accordance with the quantum prediction. It is straightforward to verify that this model yields  $\langle \text{PM} \rangle = 6$ . In addition, the observables within each context (defined by a column or row) are compatible in the sense that in sequences of the form  $A_1 A_2$ ,  $A_1 B_2 A_3$ , or  $A_1 \alpha_2 a_3 A_4$  (here, the subindices indicate the temporal ordering in the measurement sequence) the first and last measurements of  $A$  yield the same output.

One can show that this automaton is the smallest automation to reproduce these predictions; that is, Mealy machines with two internal states cannot do that (Kleinmann *et al.*, 2011). In this example, however, one has to be careful about the correlations that one wants to simulate. For instance, while the previously mentioned Mealy machine reaches  $\langle \text{PM} \rangle = 6$ , it does not reproduce all deterministic quantum predictions: Starting in  $S_1$ , the sequence  $B_1 C_2 \beta_3 B_4$  yields the sequence of results  $(+1, +1, -1, -1)$ , i.e.,  $B$  changes its value. This is in contrast to quantum mechanics, since  $C$  and  $\beta$  are both compatible with  $B$ . Thus, while this machine reproduces compatibility constraints within one column or row, it does not reproduce all compatibility conditions. For incorporating more compatibility constraints one needs four internal states (Kleinmann *et al.*, 2011).

In this example, Mealy machines were used only to simulate some outcomes of quantum mechanics in a deterministic manner. However, no quantum state gives deterministic outcomes for all measurements of the PM square. For this, one can consider probabilistic mixtures of different Mealy machines. For instance, Fagundes and Kleinmann (2017) considered a class of variations of the automaton in Eq. (95), and then probabilistic mixtures of these. They then showed that the predictions for any quantum state can be reproduced as long as only com-

patibility relations within the columns and rows are considered. In an extension of this research line, it was also shown that a Mealy-type machine with a single qubit cannot simulate contextual correlations (Budroni *et al.*, 2019). In a significantly different approach, the problem of determining the initial state of a Mealy or More machine was connected to quantum logic (Dvurečenskij *et al.*, 1995; Schaller and Svozil, 1996).

## 2. Simulation with $\varepsilon$ transducers

A different approach to simulate contextuality or temporal correlations comes from the analysis of time series and can also be used to quantify the memory needed for a simulation. Before starting the explanation of  $\varepsilon$  transducers, it is useful to recall the notions of hidden Markov models (HMMs, Rabiner, 1989) and  $\varepsilon$  machines (Crutchfield, 1994).

HMMs are probabilistic automata to simulate time series. The automaton contains a set of internal states  $S_k$ , and for each internal state, there is a probability distribution  $P_k$  of the outcomes and a probability distribution  $T_k$  of the transitions. If the automaton is in a given state  $S_k$ , it will output an outcome drawn from  $P_k$  and move to another state, chosen according to  $T_k$ . For a description of a given time series the HMM does not have to be in a definite state, instead one has a probability distribution over all internal states. Two examples of HMMs are given in Fig. 20.

$\varepsilon$  machines can be seen as a special instance of HMMs. Consider an infinite time series  $\overleftarrow{\mathcal{X}} = \{\dots, X_{-2}, X_{-1}, X_0, X_1, X_2, \dots\}$  where the  $X_i$  are random variables over some alphabet. One can split it into a past and a future,

$$\begin{aligned}
 \overleftarrow{\mathcal{X}} &= \{\dots, X_{-3}, X_{-2}, X_{-1}\}, \\
 \overrightarrow{\mathcal{X}} &= \{X_0, X_1, X_2, \dots\}. & (96)
 \end{aligned}$$

One can then define an equivalence relation on the set of all possible pasts, by calling two pasts equivalent if they both predict the same future. Mathematically, one defines  $\overleftarrow{x} \sim \overleftarrow{x}'$  if and only if  $P(\overrightarrow{\mathcal{X}}|\overleftarrow{x}) = P(\overrightarrow{\mathcal{X}}|\overleftarrow{x}')$ . The equivalence classes of this relation are then called the causal states  $\{S_k\}$ . The causal state contains all information from the past that is relevant for the future; knowledge of the precise history does not add anything to it.

Given a causal state, one obtains a  $x_0$  as a new output. This additional output defines a new history, belonging to a potentially different causal state and, consequently, the output  $x_0$  defines a transition to a new causal state. Note that in a general HMM the output does not determine the transition. Finally, one can consider the probability distribution of the causal states and its entropy,  $H = -\sum_k p(S_k) \log[p(S_k)]$ . This is the statistical complexity of the process and can be used to quantify the memory needed for a simulation. Recently it was shown that in

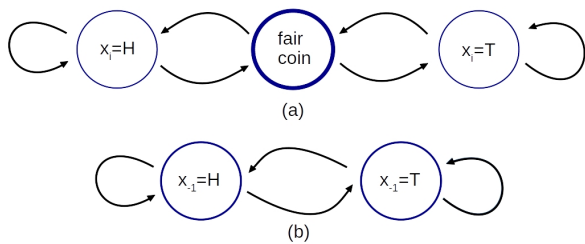

FIG. 20 Examples of a HMM and an  $\varepsilon$ -machine for the simulation of a biased coin flip (also called a perturbed coin). The process is given by a coin, which flips with a certain probability, as given by  $P(x_i = H) = P(x_i = T) = 1/2$  and  $P(x_i = T|x_{i-1} = H) = 1/2 - \delta$  and  $P(x_i = H|x_{i-1} = T) = 1/2 - \delta$ . This can be seen as a fair coin ( $\delta = 0$ ) that is disturbed toward a constant process. Detailed descriptions of this and the following models were given by Löhner and Ay (2009). (a) A general HMM could simulate this with three internal states, corresponding to a fair coin and two maximally biased coins, which always give heads or tails. The fact that the biased coin flip tends to reproduce the previous result is modeled by the rule that the automaton acts most of the times as a fair coin, but sometimes this is replaced by a deterministic coin. (b) When constructing the  $\varepsilon$  machine, one first observes that only the last output matters, so this defines the causal states. Since the two outputs are equally probable, the statistical entropy of the process is 1 bit. The HMM in (a) requires less memory, but it contains oracular information: If one knows that the automaton is in a state corresponding to a maximally biased coin, the next output is foreseeable.

this context quantum mechanics can help to reduce the memory required for a simulation of a time series (Gu *et al.*, 2012; Palsson *et al.*, 2017).

Before discussing the application to contextuality, it is useful to explain in more detail the difference between an  $\varepsilon$  machine and general HMMs. In a HMM (or a Mealy machine) the simulation automaton may contain information about the future that cannot be derived from the past. Consider Alice and Bob, where Alice knows only the current internal state of the automaton and Bob knows only the past sequence of results. If the simulation works properly, Alice can predict the future as well as Bob. It is possible, however, that Alice could predict the future better than Bob, such as if the given internal state  $S_k$  predicts a deterministic outcome for the next measurement that cannot be deduced from the past. This difference is also illustrated in Fig. 20. Physically, such general HMMs with oracular information may be excluded due to the demand that only the past observations should be used for simulating the future. This then leads to  $\varepsilon$  machines.

For simulating contextuality, one still has to extend the scheme a bit, as different measurements in each time step are possible. This, however, can easily be done by combining the sequence of measurement choices  $\overleftarrow{\mathcal{Q}}$  and the sequence of results  $\overleftarrow{\mathcal{A}}$  to a single variable,  $\overleftarrow{\mathcal{X}} =$

$(\overleftarrow{\mathcal{Q}}, \overleftarrow{\mathcal{A}})$ . The corresponding  $\varepsilon$ -machine is then called the  $\varepsilon$ -transducer (Barnett and Crutchfield, 2015).

The simulation of the PM square with  $\varepsilon$ -transducers was considered by Cabello *et al.* (2018a), who found that the causal states are effectively the 24 eigenstates occurring in the observables of the square. They occur with equal probability, so the required memory is  $H = \log(24) \approx 4.585$  bits. For the Yu and Oh scenario, the causal states are more difficult to identify, but at least  $H \approx 5.740$  bits are required for a simulation. Although the Yu-Oh scenario is more difficult to simulate, the scenario has a smaller degree of contextuality according to several contextuality measures (Abramsky and Brandenburger, 2011; Grudka *et al.*, 2014; Kleinmann *et al.*, 2012).

### 3. Other related results

Contextuality is relevant for quantum computation (see also Sec. VI.A), so the simulation of both phenomena is connected. In quantum computation, the so-called stabilizer operations contain an important class, that is, however, not sufficient for universal computation. Recently, Hindlycke and Larsson (2022) provided a model where the correlations of all Pauli-stabilizer states, Clifford transformations, and Pauli-tensor-product measurements can be simulated in time and space quadratic in the number of qubits. Thus this contextual hidden-variable model gives an efficient simulation of the stabilizer subtheory of quantum mechanics including its complete contextual behavior.

For making stabilizer operations universal, so-called magic states need to be added and an explicitly contextual (but not efficient) hidden-variable model for these was found by Zurek *et al.* (2020). Similarly, explicitly contextual classical models that simulate quantum contextuality were investigated by Bravyi *et al.* (2018, 2020). In this case, the cost of the classical simulation of contextual correlations is quantified in terms of the circuit depth, which increases with the input size for classical models that use gates with bounded fan-in, but remains constant for any input size for quantum models.

The previous results lead to the question as to how general temporal quantum correlations can be simulated in a classical manner. If the dimension of the underlying quantum system is not bounded, the space of all correlations forms a polytope (Abbott *et al.*, 2016; Hoffmann *et al.*, 2018), while the correlation space becomes nonconvex for fixed dimension (Mao *et al.*, 2020). Mealy machines have been used to characterize the memory cost for simulating correlations (Budroni *et al.*, 2019, 2021; Vieira and Budroni, 2022), and the minimal dimensions for reaching certain correlations have been characterized (Mao *et al.*, 2020; Spee *et al.*, 2020).

## E. Resource theory of contextuality

The connection between quantum contextuality and practical applications in quantum information processing, most notably quantum computation (see Sec. VI), stimulated the development of various proposals for a resource theory of quantum contextuality, which we review in the following. In simple terms, the basic elements of a resource theory are the resourceful and resourceless objects, as well as the operations that do not increase the resource, i.e., the *free operations*, and finally a quantifier of the resource, which should be monotonic with respect to the free operations (Coecke *et al.*, 2016). The first works in this area were the one by Grudka *et al.* (2014) and the follow-up paper by Horodecki *et al.* (2015). They proposed a measure of contextuality, called *relative entropy of contextuality*, together with an abstract characterization of the axiomatic structure of the resource theory. The monotonicity of their measure, however, was proven only for a restricted set of operations, while a general characterization of the free operations was not provided. This gap was filled by Amaral *et al.* (2018a), who provided a characterization of free operations, the so-called *noncontextual wirings*, and showed that the relative entropy of contextuality is indeed a monotone. In simple terms, noncontextual wirings can be understood as a preprocessing and postprocessing of each joint measurement associated with a context, regardless of the particulars of its experimental implementation (such as joint or sequential measurement). The preprocessing affects the choice of the inputs, i.e., the sequence to be measured, whereas the postprocessing, which may also depend on the preprocessing operation, affects the measurement outputs. Preprocessing and postprocessing cannot be arbitrary, but they obey constraints that make their application consistent: restricting the measurements only to contexts, etc.

Similarly, Abramsky *et al.* (2017) explored the properties *contextual fraction*, which was introduced by Abramsky and Brandenburger (2011) and Amselem *et al.* (2012) as a contextuality monotone. There, however, they proved the monotonicity with respect to a restricted set of operations, namely, a translation of measurements and coarse graining of outcomes. This work was then further expanded by Abramsky *et al.* (2019) and Soares Barbosa *et al.* (2021). In particular, Abramsky *et al.* (2019) introduced a new operation in the resource theory called *conditioning on a measurement*, namely, the possibility of choosing the current measurement to perform in a temporal sequence on the basis of the outcomes of the previously performed (compatible) measurements [i.e., a measurement protocol according to the definition of Acín *et al.* (2015)]. The contextual fraction has been proven to be a monotone both for this extended set of operations (Abramsky *et al.*, 2019) and for the noncontextual wirings (Amaral *et al.*, 2018a). One can show that the extended set of operation given by Abramsky *et al.* (2019) is strictly larger than the noncontextual wirings

of (Amaral *et al.*, 2018a). This is achieved (Karvonen, 2022) by showing that any noncontextual wiring can be reproduced by the operations of Abramsky *et al.* (2019) and then providing a transformation, protocol 1 of Barrett *et al.* (2005b), that can be expressed in the resource theory of Abramsky *et al.* (2019), but not as a noncontextual wiring.

Finally, within the framework of Abramsky *et al.* (2019), Karvonen (2021) proved that the resource theory of contextuality does not admit catalysis, meaning that there are no resources (in this case, correlations) that can enable an otherwise impossible resource conversion and still be recovered afterward.

## F. The so-called nullifications of the Kochen-Specker theorem

The KS theorem was developed in the framework of ideal measurements and, as we saw in Sec. IV.B and IV.C, several problems arise when one tries to map those ideal measurements to actual experimental implementations. Some of the first criticisms regarding the physical implications of the KS theorem precisely involved this transition from ideal to actual measurements, in particular the impossibility of arbitrarily precise measurements, and were raised by Meyer (1999), Kent (1999), Clifton and Kent (2000), and Barrett and Kent (2004). These works played a fundamental role in the development of the modern approach to contextuality by stimulating the extension of the KS notion of contextuality from a logical to a probabilistic framework. In fact, they motivated the derivation of the KS inequalities, which appeared in those years (Larsson, 2002; Simon *et al.*, 2001). This transition from the logical to the probabilistic perspective in Kochen-Specker’s contextuality, and in particular the subsequent theoretical and experimental effort in testing contextuality on physical systems, is the most interesting outcome of this debate. Notwithstanding the value of both the criticisms of Meyer, Kent, Clifton, and Barrett and the responses that they received (Appleby, 2000, 2001, 2002, 2005; Cabello, 1999; Havlicek *et al.*, 2001; Larsson, 2002; Mermin, 1999; Peres, 2003; Simon *et al.*, 2001), we decided in the interest of brevity not to present them in detail here. Instead, after presenting the arguments by Meyer (1999), Kent (1999) and the one by Clifton and Kent (2000), we compare them to the broader perspective of probabilistic approaches to contextuality discussed in previous sections and, in particular, the problem of designing and implementing valid experimental tests of contextuality (Secs. IV.B and IV.C). These results provide the strongest argument against any possible claim of “nullification” of Kochen and Specker’s contextuality.

## 1. Meyer's "nullification" of the KS theorem

What if not all sharp measurements are physically realizable? Meyer (1999) suggested an explicit way in which this can happen while being undetectable due to the unavoidable finite precision of actual measurements. Each direction in the three-dimensional Euclidean space can be represented by a unit vector

$$\langle v_j | = \frac{1}{\sqrt{x_j^2 + y_j^2 + z_j^2}}(x_j, y_j, z_j), \quad (97)$$

with

$$\frac{x_j}{\sqrt{x_j^2 + y_j^2 + z_j^2}}, \frac{y_j}{\sqrt{x_j^2 + y_j^2 + z_j^2}}, \frac{z_j}{\sqrt{x_j^2 + y_j^2 + z_j^2}} \in \mathbb{R}.$$

According to quantum theory, each direction in the three-dimensional Euclidean space corresponds to a sharp measurement on a three-dimensional quantum system. The corresponding  $\pm 1$ -valued observable is represented in quantum theory by the self-adjoint operator constructed from

$$A_j = 2|v_j\rangle\langle v_j| - \mathbf{1}, \quad (98)$$

where  $\mathbf{1}$  is the  $3 \times 3$  identity matrix. The possible outcomes are the eigenvalues of  $A_j$ :  $-1$  (doubly degenerate) and  $1$  (nondegenerate).

If all directions  $|v_j\rangle$  correspond to physically realizable sharp measurements, then at least four colors are needed to color every  $|v_j\rangle$  respecting that orthogonal  $|v_j\rangle$ 's are colored differently (Hales and Straus, 1982). However, if

$$\frac{x_j}{\sqrt{x_j^2 + y_j^2 + z_j^2}}, \frac{y_j}{\sqrt{x_j^2 + y_j^2 + z_j^2}}, \frac{z_j}{\sqrt{x_j^2 + y_j^2 + z_j^2}} \in \mathbb{Q}, \quad (99)$$

then only three colors are needed (Godsil and Zaks, 1988). This implies that noncontextual assignments of  $-1$  and  $1$  respecting the fact that, for each orthogonal trio,  $1$  is assigned to only one vector are possible (Meyer, 1999). In fact, it is enough to take the three colors and assign the value  $0$  to two of them and the value  $1$  to the remaining one to obtain a valid KS assignment. Moreover, the rational unit sphere is dense in the real unit sphere and thus there is no experimental way to distinguish between the two spheres. This result was derived by Pitowsky (1985) several years earlier. Using just the continuum hypothesis, but a version with a weaker assumption (Martin's axiom), Pitowsky provided an assignment  $s$  of values  $\{-1, 0, 1\}$  to all triples of orthogonal vectors in the unit sphere  $S^2$  such that the condition  $s^2(x) + s^2(y) + s^2(z) = 2$  is satisfied by all orthogonal triples  $x, y$  and  $z$  except for a countable number of them. In other words, Pitowsky found a valid value assignment for almost all triples of orthogonal vectors in  $S^2$ ; see also the discussion in (Fuchs, 2011) p. 503.

According to Meyer, this shows that, despite the KS theorem, NCHV models can simulate the predictions of quantum theory within any fixed finite experimental precision. Kent (1999) generalized Meyer's result and showed a construction of KS colorable dense sets of projectors onto vectors with rational components in complex Hilbert spaces of arbitrary finite dimension. Kent (1999) claimed that this shows that "noncontextual hidden variable theories cannot be excluded by theoretical arguments of the KS type once the imprecision in real world experiments is taken into account".

A simple counterargument to Meyer's and Kent's NCHV models is given by the fact that their models cannot reproduce the probabilistic predictions of quantum theory. The following example is taken from Cabello and Larsson (2010). Consider  $d = 3$  and the initial state

$$\langle \psi | = \frac{1}{527}(354, 357, -158) \quad (100)$$

and the sharp measurements associated with

$$\langle v_1 | = (1, 0, 0), \quad (101a)$$

$$\langle v_2 | = (0, 1, 0), \quad (101b)$$

$$\langle v_3 | = \frac{1}{73}(48, 0, -55), \quad (101c)$$

$$\langle v_4 | = \frac{1}{3277}(1925, 2052, 1680), \quad (101d)$$

$$\langle v_5 | = \frac{1}{221}(0, 140, -171). \quad (101e)$$

This state and all these ideal measurements are allowed according to Meyer. For this state and these measurements, quantum theory predicts

$$\kappa = 3.941 \quad (102)$$

for

$$\kappa = -\langle A_1 A_2 \rangle - \langle A_2 A_3 \rangle - \langle A_3 A_4 \rangle - \langle A_4 A_5 \rangle - \langle A_5 A_1 \rangle. \quad (103)$$

However, for any NCHV model (Klyachko, 2007; Klyachko *et al.*, 2008),

$$\kappa \leq 3. \quad (104)$$

Therefore, Meyer's NCHV models fail to simulate the predictions of quantum theory. Notice that the set of inequalities of the form of (104) with  $\kappa$  of the form of Eq. (103) with an odd number of minus signs [such as Eq. 103, which has five minus signs] provides a necessary and sufficient condition for the existence of a NCHV model (Araújo *et al.*, 2013).

## 2. Clifton and Kent's nullification of the KS theorem

Clifton and Kent (2000), starting with similar ideas, adopted a different approach. They asked the following question: What if every sharp measurement belongs

only to one context? They showed that there is a set of directions in the three-dimensional Euclidean space that is dense in the real unit sphere and consists of directions such that none of them are orthogonal to any of the others. Therefore, one can assign any predetermined outcome to any of these directions (Clifton and Kent, 2000). In other words, they substituted the measurements defining the set of contexts (compatible ideal measurements) with other measurements for which contexts consist of a single measurement; i.e., all measurements are mutually incompatible. In this way, as noted by Kochen and Specker (1967), no constraint is imposed on the NCHV model except the reproduction of single-measurement marginals, hence a NCHV model can be constructed as a product of all single-measurement distributions.

This can be formulated as a problem of imperfect compatibility, in analogy with the one addressed by Larsson (2002), Winter (2014), and Kujala *et al.* (2015). Possible solutions to this problem within the probabilistic framework of contextuality and involving modifications to the standard NC inequalities were extensively discussed in Sec. IV.C; see that section for further details.

We now comment on the relation among Bell nonlocality, contextuality, and imperfect compatibility. It is true, as Barrett and Kent (2004) claimed, that the original KS contextuality and Bell nonlocality are logically independent concepts. However, in the probabilistic framework for contextuality, developed precisely after the entire nullification debate, Bell nonlocality can be seen as a special case of contextuality. We have a notion of contexts, compatible measurements, and the goal of reproducing observed correlations, associated with single contexts, from a global probability distribution; see Sec. IV.B. In a Bell scenario, however, perfect compatibility is always guaranteed by the spacelike separation of measurement events. Hence, by the locality condition of special relativity no disturbance is allowed between them. Moreover, imperfect measurements can always be “diluted” to projective measurements using Neumark’s theorem (Holevo, 1982; Neumark, 1940a,b, 1943; Peres, 1993).

Finally, imperfect measurements seem to forbid contextuality by another mechanism, namely, the transformation of degenerate observables into nondegenerate ones. The degeneracy property of quantum observables is fundamental in creating a nontrivial structure of measurement contexts (see the discussion of Vorob’ev’s theorem in Sec. V.B). In fact, for nondegenerate observables, commutativity becomes a transitive property (i.e.,  $[A, B] = [B, C] = 0$  implies that  $[A, C] = 0$ ), which guarantees the existence of a NCHV model (Correggi and Morchio, 2002). In our jargon, the compatibility graph is a collection of disconnected cliques; see Sec. V.B. For physically relevant observables of a single system, the degeneracy is a consequence of some symmetry of the system (consider the rotational symmetry of the hydrogen atom) that is removed when the symmetry is no longer exact (consider the level splitting due to a small electric

or magnetic field). Arguably, this is the case of imperfect experimental realization (for instance, it is impossible to completely remove any electric and magnetic field). In contrast, the symmetries related to the space-time structure are robust, i.e., never removed by small imperfections, and thus preserve the degeneracy of the relevant physical observables (for instance, consider observables of the form  $A_x \otimes \mathbb{1}$  and  $\mathbb{1} \otimes B_y$  for a bipartite system). This problem can be analyzed from the perspective of experimental imperfections presented in Sec. IV.B.

## VI. APPLICATIONS OF QUANTUM CONTEXTUALITY

Since contextuality is a fundamental phenomenon of quantum mechanics, it is not surprising that some studied its applications and its relevance to quantum information processing. In the following, we discuss three examples: First, the role of contextuality in quantum computation; second, potential applications in quantum cryptography; and third, an application of contextuality in randomness generation. Finally, we mention some further connections to information processing.

### A. Contextuality and quantum computation

The first works to investigate the relation between quantum contextuality and computation appeared in the framework of measurement-based quantum computation (MBQC, Briegel *et al.*, 2009; Raussendorf and Briegel, 2001), where computation is performed by adaptively measuring single qubits prepared in a large entangled state. Thus, in each experimental run a set of compatible measurements (i.e., measurements on different qubits) are performed. It is natural to interpret the entire experiment as a contextuality experiment (notice that it cannot be interpreted as a Bell experiment since the systems are not far apart) and ask whether the computational power arises as a consequence of quantum contextuality. The first result in this direction was presented by Anders and Browne (2009) who showed that GHZ-type correlations enable the deterministic computation of the NAND gate, effectively promoting a classical parity computer into a universal (classical) one; see also the non-adaptive case by Hoban *et al.* (2011). Starting with this observation, Raussendorf (2013) proved that all MBQC with mod 2 linear classical processing that compute a nonlinear Boolean function with a sufficiently high success probability are contextual. Raussendorf’s result was then further generalized. Specifically, Abramsky *et al.* (2017) provided an explicit lower bound to the failure probability in terms of the noncontextual fraction and the distance from the set of linear functions. Oestereich and Galvão (2017) extended the result to include reliable computation, i.e., with success probability strictly greater than 1/2; and Frembs *et al.* (2018) considered the case beyond qubits.



A fundamental result showing a strong interplay between contextuality and computation was that of Howard *et al.* (2014). More precisely, the result connected contextuality in the framework of NCHV models with additional exclusivity (see Sec. IV.A.5), and quantum computation in the framework of quantum computation via magic state distillation for qudit systems with  $d$  as an odd prime number. Finally, another important result is the one obtained by Bravyi *et al.* (2018, 2020), who showed an example of a problem that can be solved with quantum circuits of constant depth, regardless of the input size (shallow circuits), but requires classical circuits to increase in depth logarithmically with the input size. This result can be directly connected to the problem of classical simulation of contextual correlations.

Given the relevance of such results in the quantum information community and their direct connection with topics discussed in this review, namely, the graph-theoretical approach to contextuality presented in Sec. V.B.3 for Howard *et al.* (2014) and the cost of classical simulation of contextuality presented in Sec. V.D for Bravyi *et al.* (2018, 2020), we summarize these two results in the following.

### 1. Contextuality and magic states

One of the basic building blocks of the paradigm of computation via magic state distillation is stabilizer codes, which provide a fault-tolerant implementation of a subset of preparations, measurements, and unitary transformations. This subset of operations, however, is not only not-universal for computation, but also efficiently classically simulable, as shown by the Gottesman-Knill theorem (Gottesman, 1997). An additional resource that provides universal quantum computation is nonstabilizer states, called *magic states*, possibly provided in a noisy form, but distillable to some target magic state (Bravyi and Kitaev, 2005). With these states non-Clifford gates, such as the  $\pi/8$  gate or its qudit generalization, can be implemented, thus promoting stabilizer computation to universal quantum computation. Not all magic states are useful, as a large class of them cannot be distilled to pure states and some can even be efficiently classically simulable (Aaronson and Gottesman, 2004; Mari and Eisert, 2012; Veitch *et al.*, 2012, 2014).

Howard *et al.* (2014) showed that a state is contextual, with respect to stabilizer measurements, if and only if the state is outside the polytope of efficiently simulable states  $\mathcal{P}_{\text{sim}}$ . They proved the statement for qudits with  $d$  being an odd prime and for the special case of qubits. This result identified contextuality as a necessary condition for universal quantum computation via magic state distillation. The proof of the sufficiency requires one to show that any state  $\rho \notin \mathcal{P}_{\text{sim}}$  can be distilled to a sufficiently pure magic state.

In the following, we explain the stabilizer formalism and how the set of efficiently simulable states can be

identified with the noncontextual states, with respect to stabilizer measurements, defined as all projective measurements consisting of rank-1 projectors onto stabilizer states. We consider a system of dimension  $p$ , where  $p$  is an odd prime. The qubit case has also been discussed by Howard *et al.* (2014).

We first recall the following definition of the displacement operators in the discrete phase space (Gibbons *et al.*, 2004; Gross, 2006; Vourdas, 2004)

$$D_{l,m} := \omega^{2^{-1}lm} X^l Z^m, \quad (105)$$

where the generalized  $X$  and  $Z$  are defined in the computational basis by  $Z|k\rangle = \omega^k|k\rangle$ ,  $X|k\rangle = |k+1\rangle$ , and  $\omega := e^{i2\pi/p}$ , and  $2^{-1}$  is the multiplicative inverse of 2 in the field  $\mathbb{Z}_p$ , i.e.,  $\omega^{2^{-1}} = e^{i\pi/p}$ .

In analogy with the continuous-variable case, the discrete Wigner function of a state  $\rho$  can then be defined as the expectation values of displacement operators on it. Since the dimension is finite and some of the displacement operators commute (since  $D_{l,m}D_{l',m'} = \omega^{2^{-1}(lm' - l'm)}D_{l+l',m+m'}$ ), it is sufficient to consider only  $p+1$  of them, for instance,  $L = \{D_{0,1}, D_{1,0}, D_{1,1}, D_{1,2}, \dots, D_{1,p-1}\}$ , as their eigenvectors form a complete set of mutually unbiased bases (Appleby *et al.*, 2008). Now denote by  $\Pi_j^{q_j}$  the projector onto the eigenvector with eigenvalue  $\omega^{q_j}$  for the  $j$ -th operator in  $L$ . For a vector  $\mathbf{q} \in \mathbb{Z}_p^{p+1}$  define the operator  $A^{\mathbf{q}} := -\mathbb{1} + \sum_{j=1}^{p+1} \Pi_j^{q_j}$  and finally the discrete Wigner function as (Gibbons *et al.*, 2004; Gross, 2006)

$$W_\rho(\mathbf{q}) = \text{tr}(\rho A^{\mathbf{q}}). \quad (106)$$

Following Mari and Eisert (2012); Veitch *et al.* (2012), the efficiently simulable states are identified with those with a positive Wigner function, namely

$$\mathcal{P}_{\text{sim}} := \{\rho \mid \text{tr}(\rho A^{x\mathbf{a}+z\mathbf{b}}) \geq 0, x, z \in \mathbb{Z}_p\}, \quad (107)$$

with  $\mathbf{a} := (1, 0, 1, \dots, p-1)$  and  $\mathbf{b} := -(0, 1, 1, \dots, 1)$ . The connection between simulability and contextuality was then obtained by associating an exclusivity graph to a collection of projectors [specifically, those entering into the definition of  $A^{x\mathbf{a}+z\mathbf{b}}$  in Eq. (107)], computing its independence number (i.e., the noncontextual bound) and showing that the condition  $\text{tr}(\rho A^{x\mathbf{a}+z\mathbf{b}}) < 0$  amounts to a violation of the noncontextual bound. More precisely, for a two-qudit system, with the appropriately chosen set of projectors  $\{\Pi_j^{s_j}\}$  and their sum  $\Sigma^{\mathbf{r}}$ , they showed that

$$\text{tr}[\Sigma^{\mathbf{r}}(\rho \otimes \sigma)] \leq p^3 \Leftrightarrow \text{tr}(\rho A^{\mathbf{r}}) \geq 0 \quad (108)$$

for any state  $\sigma$  on the second qudit. Finally, the bound  $p^3$  was proven to be the independence number of the graph  $\Gamma^{\mathbf{r}}$  associated with the set of projectors appearing in  $\Sigma^{\mathbf{r}}$ , i.e.,  $\alpha(\Gamma^{\mathbf{r}}) = p^3$ , showing that the contextual states ( $\rho \otimes \sigma$  for all  $\sigma$ ) are precisely those associated with a negative Wigner function for  $\rho$ . This connection between contextual states and the negativity of their Wigner function

has been proven to be general (Delfosse *et al.*, 2017) for  $n$ -qudit systems with  $n > 1$  and  $d$  an odd prime, without requiring the construction of the tensor product  $\rho \otimes \sigma$  as in Eq. (108).

The result obtained by Howard *et al.* (2014) was then extended to rebits, i.e., a restriction of qubits to real-valued density matrices and operators (Delfosse *et al.*, 2015), and finally to qubits (Bermejo-Vega *et al.*, 2017; Raussendorf *et al.*, 2017). Finally, a different notion of contextuality, called sequential contextuality has been investigated from the perspective of computation (Mansfield and Kashefi, 2018) and quantum information processing tasks such as quantum random access codes for systems with bounded memory (Emeriau *et al.*, 2020).

## 2. Contextuality and shallow quantum circuits

The name *shallow circuit* refers to circuits that are of constant depth, regardless of the input size. Constant depth implies that the corresponding operations can be run in a constant time, as operations on different sets of qubits can be run in parallel.

As a starting point, Bravyi *et al.* (2018) showed that there are problems that can be solved by a quantum algorithm with certainty and in constant time for any input size, i.e., with a shallow circuit, but require a time logarithmic in the length of the input for any classical circuit that solves them with a sufficiently high probability. This work was further extended Bravyi *et al.* (2020) to account for what happens if noise is explicitly modeled. Bravyi *et al.* (2020) presented an alternative, and arguably simpler, argument to show the gap between quantum and classical shallow circuits.

Note that the arguments presented by Bravyi *et al.* (2018, 2020) do not use the oracular paradigm. This is important, since a speedup proven in the oracular paradigm may not translate into a real-world advantage, as a classical algorithm may take advantage of the internal structure of the oracle to solve the problem more efficiently (Johansson and Larsson, 2017, 2019).

Two different arguments were presented by Bravyi *et al.* (2018) and Bravyi *et al.* (2020), but they are based on similar reasoning. An intuitive understanding of them, based on nonlocal games, can be obtained as follows. We first consider the case of a circuit that is fed with a fixed entangled state plus classical bits as input, but implements only local (such as single-qubit) operations. This means that each gate has only a wire coming in and one coming out. Recall that the number of wires coming in each gate, not necessarily among nearest neighbors, is called the *degree* or *fan-in* of the gate. If the input-output relation of the circuit is modeled after that of a nonlocal game, then the observation of a probability of success for the correct output above a certain threshold can be interpreted as the violation of a Bell inequality. Now imagine we allow for fan-in 2 with nearest-neighbor interactions. Thus, in the analogy of the nonlocal game,

any two parties can collaborate to win, but only if their distance is less than  $2^D$ , where  $D$  is the circuit depth. To visualize this, one can imagine that each output of the circuit has some “past lightcone” indicating the initial inputs that could have influenced it.

The number of parties in the game corresponds to the input size of the circuit, hence, to allow for a collaboration among distant parties, the depth of the circuit must grow logarithmically with the input size. In other words, to win with the aforementioned classical communication strategy, the depth of the circuit must grow (logarithmically) with the input size. The argument is then extended to the case of gates of fan-in  $K$ , with  $K$  arbitrary but fixed for all possible input sizes and the condition of a nearest-neighbor interaction removed. Finally, the nonlocal game is chosen such that it can be won by quantum players without any communication, corresponding to a fixed depth circuit necessary to prepare the correct initial entangled state. Notice that even if the number of operations needed for preparing this entangled state grows with the input, they can be performed in parallel; hence, the depth of the circuit remains constant.

A more detailed description can be provided by explicitly considering the game given by Bravyi *et al.* (2020), which is based on the PM-square (Mermin, 1990b; Peres, 1990) nonlocal game (Aravind, 2004; Cabello, 2001a; Cleve *et al.*, 2004), and called the 1D magic square problem. Bravyi *et al.* (2018) used a similar game based on a GHZ-type contradiction, but the proof is more elaborate as the game is based on a two-dimensional qubit architecture. Bravyi *et al.* (2020) had the  $N$  input wires of the circuit represent the  $N$  players and additional classical inputs were provided to specify the game. In each round, only two of them play the PM-square game, whereas the other players collaborate to create the right correlations. The different roles are assigned at random at the beginning of each round, such that a perfect winning (classical) strategy would necessarily require a collaboration between any pair of players.

The nonlocal game can be straightforwardly translated into an abstract *relation problem*: a relation is simply a set of valid input-output pairs,  $(z_{\text{in}}, z_{\text{out}})$ , defined by a function  $R(z_{\text{in}}, z_{\text{out}})$  taking value 0 or 1. A circuit is said to solve the relation problem  $R$  if for each input  $z_{\text{in}}$  it produces an output  $z_{\text{out}}$  such that  $R(z_{\text{in}}, z_{\text{out}})$  equals 1. The pairs  $(z_{\text{in}}, z_{\text{out}})$  can then be derived from the input-output pairs of the nonlocal game. The problem is said to have  $n$  input-output bits if  $|z_{\text{in}}| + |z_{\text{out}}| = n$ .

We can then summarize the result by Bravyi *et al.* (2020) as follows. They showed that for each  $n$  there is a relation problem  $R$  with  $n$  input-output bits and a set of inputs  $S$ , with  $|S| = \text{poly}(n)$  such that (i)  $R$  can be solved for all inputs with a constant-depth quantum circuit and (ii) any classical circuit with constant fan-in that solves  $R$  with probability  $p_{\text{success}} \geq 90\%$ , for  $S$  uniformly distributed, has a depth growing at least as fast as  $\log(n)$ .

Bravyi *et al.* (2020) generalized the result to the case

of quantum circuits with local stochastic noise, namely, a random Pauli error is applied at each time step to the ideal quantum circuit. More precisely, they showed that a constant-depth noisy quantum circuit, this time with a 3D geometric structure, can solve the  $n$ -bit problem  $R$  with high probability ( $p_{\text{success}} \geq 99\%$ ), whereas any classical noiseless circuit that solves it with  $p_{\text{success}} \geq 90\%$  has depth growing at least as fast as  $\log(n)/\log[\log(n)]$ .

Beyond the technical details of the results and from a contextuality perspective, an interesting observation is the following. The quantum circuit can solve the problem with a constant depth due to its ability to generate contextual correlations. In fact, any classical simulation of these contextual correlations requires communication among the parties, which in turn requires the depth of the circuit to grow with the number of parties (or inputs of the game). The results obtained by Bravyi *et al.* (2018) and Bravyi *et al.* (2020) can therefore be interpreted in the framework of *memory cost* (or, *communication cost*) for the classical simulation of quantum contextuality (see Sec. V.D). Finally, notice that even if we are discussing nonlocal games and Bell inequalities, in any realization of the considered circuit the single measurements are not far apart. It is therefore more appropriate to identify the corresponding phenomenon as quantum contextuality than as Bell nonlocality.

## B. Contextuality and quantum cryptography

### 1. Svozil's quantum key distribution protocol

The possibilities of contextuality for quantum key distribution (QKD) were first devised by Bechmann-Pasquinucci and Peres (2000). Here, we review a QKD scheme introduced by Svozil (2010), which provides a good example of how contextuality adds features beyond those provided by measurement incompatibility. Specifically, it shows how contextuality can be used to counteract a possible attack [described by Svozil (2006)] that may be used to attack the standard BB84 QKD protocol (Bennett and Brassard, 1984).

Recall how the BB84 protocol works. There are two separate parties Alice and Bob who want to obtain a shared secret key (i.e., a sequence of bits known only to them). For that, they send physical systems from Alice to Bob and share classical information over a public channel. The protocol goes as follows: (i) Alice randomly picks one from two basis of qubit states (the computational basis and the Hadamard basis) and sends Bob over a public and authenticated quantum channel a randomly chosen state of that basis. (ii) Bob picks a basis at random from the two and measures in this basis the system received from Alice. (iii) Over a public channel, Bob announces his bases and Alice announces those events in which the state sent belongs to the measured basis. (iv) Alice and Bob repeat steps (i)-(iii) many times and, from the bits where both Alice and Bob used the same basis, Alice

randomly chooses half of them and discloses her choices over the public channel. Both Alice and Bob announce these bits publicly and run a check to see whether more than a certain number of them agree. If this check passes, then Alice and Bob use the remaining undisclosed bits to create a shared secret key via additional techniques like error correction and privacy amplification.

We now describe Svozil's attack to the BB84 protocol (Svozil, 2006). The adversary replaces the preparations and measurements of quantum states by classical preparations and measurements. Thus, in step (i), Alice is actually picking one of two differently colored eyeglasses (instead of one of the two bases) and picking a ball from an urn (instead of picking one quantum state) with two color symbols in it (corresponding to the basis that the state belongs to). Each one of the two differently colored eyeglasses allows her to see only one of the two colors. Svozil observed that the adversary can mimic the quantum predictions if: (a) each of the balls has one symbol  $S_i \in \{0, 1\}$  written in two different colors chosen from the two possible pairs. Her choice of eyeglasses decides which symbols Alice can see. (b) All colors are equally probable, and for a given color the two symbols are equally probable. Therefore, in step (ii) Bob is actually picking one of two differently colored eyeglasses and reading the corresponding symbol. Since the requirements (a) and (b) can be satisfied simultaneously, the strategy can successfully imitate the quantum statistics of the BB84 protocol. Therefore, if the replacement remains unnoticed to Alice and Bob, just by checking the statistics they cannot realize that the adversary may have full knowledge of their "secret" key.

However, Svozil (2010) also noticed that if one replaces the quantum states and basis of the BB84 protocol by those used in a proof of the KS theorem, then in the classical attack requirements (a) and (b) cannot be satisfied simultaneously and the adversary cannot simulate the quantum statistics. Specifically, Svozil's protocol uses the 9-basis 18-state KS proof in dimension 4 in Fig. 3. In step (i), Alice randomly picks a basis from the nine bases in Fig. 3 and sends Bob a randomly chosen state of that basis. (ii) Bob picks a basis at random from the nine and measures the system received from Alice. The remaining steps are as in BB84, but one notices that each measurement now has four outcomes (rather than two).

### 2. Contextuality offers device-independent security

The core idea behind BB84 is that information gain for one quantum observable must cause a disturbance to another incompatible observable. This does not require entanglement or composite systems. However, there is a second generation of QKD protocols, offering much higher levels of security that relies on nonlocality. These protocols were initiated by Ekert (1991), were advanced through the work of Barrett, Hardy, and Kent (2005a),

and lead to the schemes for device-independent QKD (Acín *et al.*, 2007). Security in the protocols is verified solely through the statistics of the measurement outcomes, with no assumptions about the inner working of the devices (except those that are standard in cryptography). Since nonlocality can be seen as contextuality produced by local measurements on composite systems, all these schemes may be considered as applications of contextuality. However, in most of them the exact role of contextuality is difficult to follow.

Here we review a result and a corresponding QKD scheme presented by Horodecki *et al.* (2010), in which local contextuality plays a crucial role. The result can be summarized as follows: if two parties share systems that, locally, show a KS contradiction and, in addition, exhibit perfect correlations, then they can use them to extract a secure key in a device-independent manner. As an application, they introduced a QKD protocol exploiting the properties of the PM magic square; see Sec. III.B.1. Here we do not provide the details of the QKD protocol: we instead simply describe the resources used and the steps to prove device-independent security.

A distributed PM box (shared by Alice and Bob) is defined as follows (Aravind, 2004; Cabello, 2001a; Cleve *et al.*, 2004). Both Alice and Bob have a PM set of observables. Alice measures columns of the PM magic square, while Bob measures rows, as first proposed by (Cabello, 2001a). That is, a distributed PM box is a set of nine conditional distributions  $p(a, b|x, y)$ , where  $x$  labels the columns of the PM table,  $y$  labels the rows, and  $a = (a_1, a_2, a_3)$  and  $b = (b_1, b_2, b_3)$  are the outcomes of the joint measurement of the three observables in the respective column or row, where  $a_i, b_j \in \{+1, -1\}$ . The outcomes are assumed to satisfy the corresponding quantum predictions. That is,  $a_1 a_2 a_3 = +1$  for all columns of the PM table except the last one (for which  $a_1 a_2 a_3 = -1$ ), and  $b_1 b_2 b_3 = +1$  for all rows. In addition, there are perfect correlations between the outcomes of the same observables on Alice's side and Bob's side. Finally, nonsignaling holds. That is, Alice's (Bob's) local distributions do not depend on the choice of measurement by Bob (Alice). In quantum mechanics, such a distributed PM box can be realized, if both parties share two singlet states.

Consider a PM distributed box such that the parties do not know how it is implemented, i.e., what observables are measured and in which quantum state. However, if they assume the validity of quantum mechanics, as is usually done in the device-independent paradigm (Acín *et al.*, 2007), it can be shown (Horodecki *et al.*, 2010) that the outcomes of a fixed row or column possess about 0.44 bits of intrinsic randomness, and hence that the correlations offer security. It can also be proven (Horodecki *et al.*, 2010) that a secure key can be obtained both in the noiseless case and when assuming a small amount of noise in the state.

### C. Random number generation

The inherent randomness of quantum mechanics together with the impossibility of a classical simulation of some of its aspects suggests the possibility of using it for the generation of random numbers. For instance, protocols of randomness expansion based on Bell nonlocality and with minimal assumptions on the measuring devices have been proposed (Colbeck, 2006).

In the following, we review a protocol of *randomness generation* based on quantum contextuality proposed by Abbott *et al.* (2012). The main idea is to exploit a Kochen-Specker-type contradiction, namely, the impossibility of a preassigned value for certain quantum properties of a system to claim that the outcomes generated by the measurement of such properties are genuinely random. In contrast to previous approaches, Abbott *et al.* (2012) not only used the impossibility of a simultaneous assignment to *all* variables (NCHV) but also precisely localized which variable cannot have a definite value. The intuition is similar to the one at the basis of the bug graph in Fig. 5 on Pag. 8: if  $A$  is assigned the value 1, then  $B$  must be assigned the value 0. Abbott *et al.* (2012) extended this idea by proving a stronger result: they found a graph in  $d = 3$  such that, whenever  $A$  is assigned the value 1, the assignments  $B = 0$  and  $B = 1$  both generate some contradiction. In this case  $B$  is said to be value indefinite. Moreover, they showed that this graph can be constructed for any two projectors  $P_A = |a\rangle\langle a|$  and  $P_B = |b\rangle\langle b|$  such that  $\sqrt{5/14} \leq |\langle a|b\rangle| \leq 3/\sqrt{14}$ . These numbers were subsequently improved by Abbott *et al.* (2015), to the general condition  $0 < |\langle a|b\rangle| < 1$ . This construction relies on the assumption that value assignments respect QM predictions for one-dimensional projectors, in particular orthogonality ( $\mathbf{O}'$ ) and completeness ( $\mathbf{C}'$ ) for an orthogonal basis; see Sec. III.A. Moreover, the assumption of a definite value for  $P_A$  is translated, through the *eigenstate assumption* (Abbott *et al.*, 2012), to the assumption of the preparation of an eigenstate of  $P_A$ .

This argument can be translated to a practical random number generation protocol that consists of preparing a three-level quantum system in the pure state  $|\psi\rangle$  and then measuring it in a basis containing vectors  $|\phi_+\rangle, |\phi_-\rangle$  such that  $0 < |\langle \psi|\phi_\pm\rangle| < 1$ . An explicit implementation is given in terms of the spin operators for a spin-1 system with  $|\psi\rangle = |S_z = 0\rangle$  and  $|\phi_\pm\rangle = |S_x = \pm 1\rangle$ . In other words, the system is prepared in the eigenstate associated with 0 for the spin along the  $z$  direction, and a measurement in the  $S_x$  basis is performed. By the geometry of the problem  $\langle S_z = 0|S_x = 0\rangle = 0$  and  $\langle S_z = 0|S_x = \pm 1\rangle = 1/\sqrt{2}$ , which implies that the outcome 0 never appears in the measurement of  $S_x$  and that the two value indefinite outcomes  $\pm 1$  appear with equal probability. In addition to the realization with spin-1 systems, Abbott *et al.* discussed an implementation based on photon interferometry.

This approach was explored experimentally by Kulikov *et al.* (2017), and the quality of the randomness produced

in the experiment has been further analyzed by [Abbott \*et al.\* \(2019\)](#). See also ([Abbott \*et al.\*, 2014](#); [Agüero Trejo and Calude, 2021](#)) for more recent theoretical developments. Experimental random number generation based on contextuality was also explored by [Um \*et al.\* \(2013, 2020\)](#), but not in the framework developed by [Abbott \*et al.\* \(2012\)](#).

#### D. Further applications

Finally, we want to mention some other applications where contextuality has proven useful.

##### 1. Zero-error channel capacities

In general, a classical channel  $\mathcal{N}$  transforms inputs  $x \in X$  on Alice's side to outputs  $y \in Y$  on Bob's side, so it can be considered a conditional probability distribution  $p(y|x)$ . If only a single use of the channel is allowed, Bob may not be able to uniquely determine Alice's input from his output. One may therefore ask what the largest subset of inputs is that can be perfectly distinguished. This is also called the one-shot, zero-error capacity  $c_0(\mathcal{N})$  of the channel.

This quantity can be interpreted in a graph-theoretical manner, using the so-called confusability graph  $G(\mathcal{N})$ . The vertices of this graph are the input symbols  $x \in X$  and two vertices  $x_1$  and  $x_2$  are connected if and only if the probability distributions  $p(y|x_1)$  and  $p(y|x_2)$  overlap. This means that there is a possible output  $y$  that may originate from the two  $x_i$ , so these two inputs are confusable. In other words, the one-shot zero-error capacity  $c_0(\mathcal{N})$  corresponds to the maximum independent set of the confusability graph. In this jargon, Bob's perspective can be described as follows: He receives an output  $y$  that may originate from several  $x_i$ . Any two of these  $x_i$  are confusable, so the possible inputs  $x_i$  form a clique in the confusability graph.

How does the capacity of a channel change if Alice and Bob also have some access to additional resources such as shared randomness or entangled states? [Cubitt \*et al.\* \(2010, 2011\)](#) showed that from any Kochen-Specker set of vectors one can construct an example of a channel, where the one-shot zero-error capacity in the presence of a shared entangled state, denoted by  $c_E(\mathcal{N})$ , is strictly larger than the capacity without shared entanglement  $c_0(\mathcal{N})$ .

This connection is best explained with an example. Consider the nine orthogonal bases in four-dimensional space, which came out of the 18-vector proof in [Fig. 3](#) in [Sec. III.A](#). The 36 overall vectors can be organized in a  $9 \times 4$  array  $|\psi_{ij}\rangle$  and the indices  $(ij)$  constitute the input space  $X$  of the channel  $\mathcal{N}$ . One then constructs the channel such that two inputs  $(ij)$  and  $(kl)$  are confusable if the vectors  $|\psi_{ij}\rangle$  and  $|\psi_{kl}\rangle$  are orthogonal. This can be achieved in different ways: for instance one can simply

take  $Y = X$  as an output space and start with  $p(y|x) = \delta_{xy}$ . Small disturbances are added in order to build the desired confusability graph.

The resulting channel has  $c_0(\mathcal{N}) \leq 8$ . To see this, assume that  $c_0(\mathcal{N}) = 9$  (or larger). The nine distinguishable  $x_m$  have to belong to the nine different bases (or rows in the array) since inputs within a row are by construction not perfectly distinguishable by Bob. Moreover, if the same vector appears on two positions in the array ( $|\psi_{ij}\rangle = |\psi_{kl}\rangle$ ) and  $(ij)$  belongs to the set  $\{x_m\}$ , then  $(kl)$  also belongs to the set since  $|\psi_{ij}\rangle$  is orthogonal to all other vectors in the row  $k$ . Therefore, one arrives at an assignment of values to the 36 vectors that obeys the rules of noncontextuality, and this is by construction not possible.

On the other hand, it is evident that with the help of entanglement  $c_E(\mathcal{N}) \geq 9$ . Assume that Alice and Bob share a maximally entangled state in a  $4 \times 4$ -system. To send the row index  $i$  to Bob, Alice then simply performs a projective measurement of the corresponding basis on her part of the state. She obtains the random result  $j$  and sends  $(ij)$  through the channel. From the channel output  $y$ , Bob can identify a clique of four possible inputs  $(kl)$ . The corresponding states  $|\psi_{kl}\rangle$  are orthogonal, so he can identify Alice's input by performing a projective measurement on his reduced state, which is given by  $|\psi_{ij}\rangle$ .

##### 2. Dimension witnesses

As mentioned in [Sec. III.A](#), the Kochen-Specker theorem requires at least a three-dimensional Hilbert space. It is therefore natural to connect the violation of contextuality inequalities to the dimension.

For the case of the PM square, this was done by [Gühne \*et al.\* \(2014\)](#). They considered, the contextuality inequality found in [Eq. \(43\)](#) and studied how the violation depends on the underlying dimension. It has been shown that

$$\langle \text{PM} \rangle \stackrel{2\text{D, com.}}{\leq} 2 \stackrel{3\text{D, com.}}{\leq} 4(\sqrt{5} - 1) \approx 4.94, \quad (109)$$

where the bounds hold for the respective dimensions under the assumption that the measurements are projective and obey the compatibility (or commutation) relations of the PM square. These bounds can be generalized to certain POVMs and also to the KCBS inequality ([Gühne \*et al.\*, 2014](#)). More recently a general method on dimension witnesses using the graph-theoretic approach was introduced ([Ray \*et al.\*, 2021](#)).

##### 3. Self-testing

Quantum self-testing ([Mayers and Yao, 2004](#)) is the art of certifying quantum states, quantum measurements,

and other quantum features from the input-output statistics of measurement experiments and some minimal assumptions, which do not include assumptions about the quantum system. The method is based on the observation that some input-output statistics corresponding to extremal points in the corresponding sets of quantum correlations can be achieved, up to isometries, only with specific states and measurements. The idea was initially used for self-testing quantum states and measurements in Bell scenarios (Mayers and Yao, 2004), then extended to other features and scenarios. Here we review its application for self-testing states and measurements in contextuality experiments with sequences of ideal measurements (Bharti *et al.*, 2019a,b) and for self-testing states and measurements in Bell scenarios by exploiting the connection between quantum contextuality and graph invariants (Bharti *et al.*, 2021).

In the first case, the distinctive assumption is that measurements are ideal. Under this assumption, it was proven (Bharti *et al.*, 2019b) that the quantum violations of the KCBS inequality and all the tight inequalities for the odd  $n$ -cycle scenarios (with  $n \geq 5$ ) (Araújo *et al.*, 2013) allow for self-testing. It was also proven (Bharti *et al.*, 2019a) that the quantum violations of the antihole noncontextuality inequalities (Cabello *et al.*, 2013) allow for self-testing. The interest in the latter result relies on the fact that it allows for self-testing quantum states and measurements of any odd dimension  $d \geq 3$ .

(Bharti *et al.*, 2021) showed that the connection between quantum contextuality and graph invariants permits one to simplify the proofs of self-testability of certain Bell nonlocal correlations that were known to allow for self-testing, identify new Bell nonlocal correlations that allow for self-testing, and prove a conjecture about the closed form expression of the Lovász theta number for a family of graphs.

#### 4. Applications of Spekkens' contextuality

**Parity-oblivious multiplexing.** This is an information processing task for two parties, where preparation contextuality, as explained in Sec. IV.E, is useful (Spekkens *et al.*, 2009). We first describe the problem. Consider a two-party system where Alice receives a bit string  $x \in \{0, 1\}^n$  of length  $n$ . Bob receives a number  $y \in \{1, \dots, n\}$  and has to predict the bit  $x_y$  of Alice's string. To succeed, Alice can send Bob some information about her string. Thus far, this is a general scenario that also occurs in random access codes (Ambainis *et al.*, 2002). The interesting point is to put constraints on the information Alice is allowed to send to Bob and then investigate the physical consequences.

In the scenario considered by Spekkens *et al.* (2009) one adds the constraint that the information that Alice is allowed to send to Bob should not give any information about the parity of her string on any subset containing two or more bits. Using a mathematical formulation,

let  $s \in \{0, 1\}^n$  be an arbitrary bit string with at least two entries 1. No information on  $\sum_i x_i s_i$  should then be revealed, where addition is modulo 2. This constraint makes the information transmission from Alice to Bob "parity oblivious."

One can first ask what the optimal classical success probability is for this game. In a classical system, the constraint effectively ensures that Alice can transfer only one single bit of the string  $x$ ; without losing generality one can assume that this is the first bit. Bob can then predict the bit correctly for  $y = 1$ , and he has to guess for all other values of  $y$ . This leads to a success probability of  $p(b = x_y) = 1/n + 1/2 \times (n - 1)/n = (n + 1)/2n$ . In ontological models obeying the constraint of preparation contextuality, one also cannot exceed this value. The reason is that in these models parity obliviousness at the level of Alice's preparations and Bob's measurements already implies the parity obliviousness at the level of hidden variables; see (Spekkens *et al.*, 2009) for a detailed argumentation.

In quantum mechanics, however, this bound does not hold. Consider the case  $n = 2$ . The four possible strings for Alice can be encoded in four single-qubit states with the Bloch vectors lying in the  $x$ - $y$  plane via  $\vec{r}_{x_1, x_2} = ((-1)^{x_1}, (-1)^{x_2}, 0)/\sqrt{2}$ , and the states are  $\varrho_{x_1, x_2} = (\mathbb{1} + \vec{r}_{x_1, x_2} \vec{\sigma})/2$ . Since  $\varrho_{11} + \varrho_{00} = \varrho_{10} + \varrho_{01}$ , no quantum measurement can give information on the parity of  $x$ . If Bob wants to know  $x_1$  he measures  $\sigma_x$  and for predicting  $x_2$  he measures  $\sigma_y$ . This gives the right bit with probability  $\cos^2(\pi/8) \approx 0.8536$ , which is larger than the classical optimum of  $3/4$ .

The choice of the signal states is closely related to the examples of inequalities for preparation noncontextuality; see Eq. (67) in Sec. IV.E. The connection of parity-oblivious communication with preparation contextuality has been further generalized in several directions (Ambainis *et al.*, 2019; Banik *et al.*, 2015; Chailloux *et al.*, 2016; Ghorai and Pan, 2018; Hameedi *et al.*, 2017; Saha and Chaturvedi, 2019; Saha *et al.*, 2019).

**State discrimination.** The task of minimum error state discrimination has been a well-studied problem since the early days of quantum information processing; see (Barnett and Croke, 2009) for review. In the simplest scenario, two nonorthogonal states  $|\psi\rangle$  and  $|\phi\rangle$  are given with equal probability. The task is then to make a measurement and identify the state. As the states are nonorthogonal this cannot be done perfectly, so the task is to minimize the error probability of the guess. Note that there is also a different notion of unambiguous state discrimination in which no error is allowed, but it is possible to pass as a third option.

This can be connected to preparation noncontextuality, as shown by Schmid and Spekkens (2018). Consider two single-qubit states  $|\psi\rangle$  and  $|\phi\rangle$  with overlap  $c = |\langle\psi|\phi\rangle|^2$ . We can assume without losing generality that their Bloch vectors are of the form  $\vec{r}_{\psi/\phi} = (\cos(\alpha), 0, \pm \sin(\alpha))$ . The optimal measurement is then given by  $\sigma_z$ , leading to a success probability of  $s =$

$(1 + \sqrt{1-c})/2$ . One can consider in addition the orthogonal vectors  $|\psi^\perp\rangle$  and  $|\phi^\perp\rangle$  with the Bloch vectors  $\vec{r}_{\psi^\perp/\phi^\perp} = (-\cos(\alpha), 0, \mp \sin(\alpha))$ . They lead to essentially the same state discrimination problem, with the same success probability.

From the perspective of preparation contextuality it is important that  $|\psi\rangle\langle\psi| + |\psi^\perp\rangle\langle\psi^\perp| = |\phi\rangle\langle\phi| + |\phi^\perp\rangle\langle\phi^\perp| = \mathbb{1}$ . This puts constraints on the hidden-variable distributions describing these four states in preparation-noncontextual theories, see also Eqs. (67 and 69). Under these constraints and under the assumption that the relations and symmetries between the four states are preserved, one can prove that the success probability for the two-state problem given by  $|\psi\rangle$  and  $|\phi\rangle$  is bounded by  $s \leq 1 - c/2$ . For any  $c$  this is strictly lower than the quantum mechanical value previously provided (Schmid and Spekkens, 2018). This result can also be shown to hold for states affected by noise.

## 5. Further applications on the horizon

Recently, other works considered potential applications of contextuality, but it is currently difficult to predict the future impact of these research lines. The novel applications contain machine learning (Gao *et al.*, 2022), post-selected metrology (Arvidsson-Shukur *et al.*, 2020), and state-dependent cloning (Lostaglio and Senno, 2020).

## VII. SUMMARY AND OUTLOOK

Since the discovery of quantum contextuality more than 50 years ago, the topic has received increasing attention, with the largest number of significant contributions occurring only during the last decade. This development parallels the increased interest in Bell nonlocality and has been partially driven by the fast-growing community of quantum information scientists. A key breakthrough for quantum contextuality was the transformation of the logical contradiction that underlies the original theorem by Kochen and Specker (1967) to experimentally accessible noncontextuality inequalities; see Sec. IV. A recent key development has been the establishment of the connection between computational resources and the presence of contextuality; see Sec. VI. As the field of quantum contextuality is evolving faster than ever before, we identify three key topics that are essential for the consolidation of our current understanding of quantum contextuality and the further development of the field.

First, the mathematical structure of quantum contextuality has not yet been fully revealed, despite the numerous seminal results. For example, the smallest scenario for state-independent contextuality is not known. It is likely that it will be the scenario by Yu and Oh (2012), but a conclusive proof has not yet been provided. In addition, scenarios that are maximally contextual in certain ways have yet to be identified. For example, it is known

Amaral *et al.* (2015) that the quotient  $\vartheta(G)/\alpha(G)$  for an exclusivity graph  $G$  tends to the number of vertices of  $G$ , but a family of graphs with this property is not yet known.

Second, although there are a large number of convincing experiments that have confirmed quantum contextuality in physical systems (see Sec. IV.D) the handling of experimental imperfections, or “loopholes,” has not reached the thoroughness that has been achieved for Bell nonlocality (Brunner *et al.*, 2014; Larsson, 2014). There are several (partially competing) methods to handle experimental imperfections (see Sec. IV.C) but a comprehensive description in a unified framework is missing. Even if a truly loophole-free experiment might be fundamentally impossible, this does not lessen the need for comprehensive treatment. Some of these difficulties can be traced back to the fact that quantum contextuality (with the notable exception of Spekkens’s notion of contextuality, see Sec. IV.E) is based on the notion of ideal measurements and, in the case of implementations with sequential measurements, on the role of Lüders rule for ideal measurements. Our understanding of both concepts within the foundations of quantum theory is not fully developed and might be a source of our struggle with the design of loophole-free contextuality experiments. See Wang *et al.* (2022) for recent developments in this direction.

Finally, we mention the role of contextuality in quantum computation and communication; see also Sec. VI. There are still no strong methods that would allow one to quantify the memory cost of quantum contextuality. Specifically, it is not known whether there is a quantum advantage regarding the cost when simulating a sequential implementation of quantum contextuality by means of a classical finite state machine. Current affirmative results (see Sec. IV.B) are based on sequences of incompatible observables, which is an alien concept to quantum contextuality. Much broader and more general questions regard whether and how quantum contextuality plays a role in universal quantum computation. To date this has been answered in the case of measurement-based quantum computation, quantum computation via magic states, and shallow quantum circuits; see Sec. VI.A. But whether and in what sense contextuality plays a role in the circuit model are widely open questions. Besides those more specific questions, we expect various new key applications of contextuality in quantum information science to emerge in the near future.

In conclusion, quantum contextuality plays a central role in quantum theory, encompassing both *measurement incompatibility* at a fundamental level and *Bell nonlocality* and *entanglement* when subsystems are spatially separated. It is also strongly connected to new developments in quantum technology. Quantum contextuality is at the heart of the matter, more so than quantum uncertainty or quantum interference. Both of them could in principle be present in a classical model, whereas quantum contextuality cannot, as shown by Kochen and Specker (1967).

Paraphrasing their conclusion “This way of viewing the results [presented here] seems to us to display a new feature of quantum mechanics in its departure from classical mechanics.” Quantum contextuality is what makes quantum theory fundamentally nonclassical, and will undoubtedly play an important role in future developments of quantum physics.

## Acknowledgments

We thank Samson Abramsky, Antonio Acín, Evelyn Acuña, Joseba Alonso, Bárbara Amaral, Elias Amselem, Leandro Aolita, Marcus Appleby, Mateus Araújo, Mauricio Arias, Ali Asadian, Flavio Baccari, Guido Bacciagaluppi, Piotr Badziąg, José P. Baltanás, Johanna F. Barra, Hannes Bartosik, Ingemar Bengtsson, Marco Bentivegna, Kishor Bharti, Kate Blanchfield, Rainer Blatt, Naresh Goud Boddu, Gilberto Borges, Mohamed Bourenmane, Harvey Brown, Časlav Brukner, Jeffrey Bub, Gustavo Cañas, Jaime Cariñe, Gonzalo Carvacho, Marcos Carvalho, Daniel Cavalcanti, Rafel Chaves, Jiang-Shan Chen, Jing-Ling Chen, Giulio Chiribella, Andrea Chiuri, Sujit K. Choudhary, Rob Clifton, Andrea CRESPI, Jin-Ming Cui, Vincenzo D’Ambrosio, Lars E. Danielsen, Pierre-Louis de Assis, Dong-Ling Deng, Ehtibar Dhazafarov, Cristhiano Duarte, Joseph Emerson, Paul Erker, José M. Estebarez, Sebastián Etcheverry, Gabriel Fagundes, Armando Fernández Prieto, José Ferraz, Stefan Filipp, Manuel J. Freire, Tobias Fritz, Diego Frustaglia, Chris Fuchs, Rodrigo Gallego, Ernesto Galvão, René Gerritsma, Robert B. Griffiths, Philippe Grangier, Helena Granström, Esteban S. Gómez, Mile Gu, Guang-Can Guo, Yong-Jian Han, Lucien Hardy, Yuji Hasegawa, Teiko Heinosaari, Joe Henson, Isabelle Herbauts, Jonathan P. Home, Michael Horne, Pawel Horodecki, Mark Howard, Xiao-Min Hu, Yun-Feng Huang, Greg Jaeger, Martti Karvonen, Dagomir Kaszlikowski, Adrian Kent, Michael Kernaghan, Andreii Khrennikov, Kihwan Kim, Gerhard Kirchmair, Jürgen Klepp, Alexander Klyachko, Simon Kochen, Ravi Kunjwal, Pawel Kurzyński, Leong-Chuan Kwek, Brian La Cour, Raymond Laflamme, Radek Łapkiewicz, Matthew Leifer, Florian M. Leupold, Gustavo Lima, Chuan-Feng Li, Qiang Li, Petr Lisoněk, Bi-Heng Liu, Zheng-Hao Liu, Antonio J. López Tarrida, Vicente Losada, Aintzane Lujambio, Maciej Malinowski, Shane Mansfield, Breno Marques, Paolo Mattoni, Hui-Xian Meng, David Mermin, David A. Meyer, Giovanni Morchio, Osama Moussa, Eleonora Nagali, Miguel Navascués, Mohamed Nawareg, Vlad Negnevitsky, Choo Hiap Oh, Roberto Osellame, Sebastião Pádua, Jian-Wei Pan, Mladen Pavičić, Marcin Pawłowski, Asher Peres, Itamar Pitowsky, Ioannis Pitsios, Michel Planat, Ángel R. Plastino, Davide Poderini, José R. Portillo, Matt Pusey, Marco Túlio Quintino, Rafael Rabelo, Magnus Rådmark, Ravishankar Ramanathan, Helmut Rauch, Robert Raussendorf, Maharshi Ray, Renato Renner,

Rolf Riklund, Christian Roos, Davide Rusca, Carlos Saavedra, Muhammad Sadiq, Debashis Saha, Ana Belén Sainz, Emilio Santos, Valerio Scarani, Rüdiger Schack, Claus Schmitzer, Fabio Sciarrino, Simone Severini, Abner Shimony, Rui Soares Barbosa, Alberto Solís, Adrian Specker, Ernst Specker, Susan Specker, Rob Spekkens, Stephan Sponar, Allen Stairs, Hong-Yi Su, Kai Sun, Karl Svozil, Jochen Szangolies, Marcelo Terra Cunha, Stefan Trandafir, Giuseppe Vallone, Antonios Varvitsiotis, María C. Velázquez Ahumada, Giuseppe Vitagliano, Mordecai Waegell, Naqeeb Ahmad Warsi, Harald Weinfurter, Marcin Wieśniak, Andreas Winter, Elie Wolfe, Chunfeng Wu, Guilherme B. Xavier, Ya Xiao, Jin-Shi Xu, Zhen-Peng Xu, Bin Yan, Sheng Ye, Sixia Yu, Xiaodong Yu, Florian Zähringer, Anton Zeilinger, Chi Zhang, Jie Zhou, Zong-Quan Zhou, Marek Żukowski, and Wojciech Żurek for interesting discussions on quantum contextuality over the years. We also thank Alastair Abbott, Manik Banik, Kishor Bharti, Cris Calude, Hyppolite Dourdent, Pierre-Emmanuel Emeriau, Robert B. Griffiths, Alexei Grinbaum, Martti Karvonen, Zheng-Hao Liu, Shane Mansfield, Gaël Massé, Karl Svozil, Armin Tavakoli, and three anonymous referees for helpful comments on the manuscript. This work has been supported by Project Qdisc (Project No. US-15097) with FEDER funds, Project No. FIS2017-89609-P (MINECO, Spain) with FEDER funds, QuantERA grant SECRET, by MINECO (Project No. PCI2019-111885-2), the Deutsche Forschungsgemeinschaft (DFG, German Research Foundation, Project No. 447948357 and No. 440958198), the FQXi Fund (Silicon Valley Community Foundation) through the projects “The Nature of Information in Sequential Quantum Measurements” and “The Observer Observed: A Bayesian Route to the Reconstruction of Quantum Theory”, the Sino-German Center for Research Promotion (Project M-0294), the Austrian Science Fund (FWF) through Projects No. ZK 3 (Zukunftskolleg) and No. F7113 (BeyondC), and the ERC (Consolidator Grant 683107/TempoQ).

## Appendix A: Quantum contextuality from a historical perspective

Here we present a historical introduction to quantum contextuality from its origins to the time when the basis for experimentally testing Kochen-Specker contextuality was settled. The aim of this section is to frame the results presented in the review within a historical context and trace the connections between them that may help us to understand the evolution and ramifications of the field.

### 1. The problem of hidden variables

The discussion, in the late 1920s, of whether quantum mechanics can be supplemented by “hidden variables” was motivated by two results: Born’s probabilistic interpretation of Schrödinger’s wave function (Born, 1926a,b),



which expresses the fundamentally probabilistic character of the predictions of quantum mechanics, and Heisenberg's uncertainty principle (Heisenberg, 1927), which asserts a fundamental limit to the precision with which the values of position and momentum can be predicted in quantum mechanics. While Heisenberg, Born, Pauli, and, notably, Bohr made strong claims that quantum mechanics provides a complete framework for physics and manifested their skepticism about the possibility of completing it with hidden variables, Schrödinger, de Broglie, and especially Einstein hoped to recover quantum mechanics from a deeper nonprobabilistic theory and viewed the quantum state as an incomplete description in need of supplementation by hidden variables (Fine, 1990; Lorentz, 1928).

At the Solvay Conference in 1927, de Broglie presented an explicit hidden-variable theory (Lorentz, 1928). However, the criticisms received, particularly those from Pauli (Lorentz, 1928), persuaded de Broglie to abandon his theory.

In 1931, the skepticism of Bohr received support from a proof of impossibility of hidden variables presented by von Neumann (1931) and included in his book (von Neumann, 1932, see Sec. IV. 2). This proof was soon after shown to be inconclusive by Hermann (1935), but her work was mostly ignored for many years (Mermin and Schack, 2018). The influence of von Neumann's book, then, strongly discouraged any discussion of hidden-variable theories for decades.

Paradoxically, at that time, Wigner (1932) found something that could have been used against hidden variables: when attempting to link Schrödinger's wave function to a distribution on phase space (which would be the analog in quantum mechanics to the distribution function of classical statistical mechanics), Wigner found that such a distribution has negative values and cannot be made non-negative. The importance of this discovery was not recognized until much later.

In 1935, Einstein, Podolsky, and Rosen (EPR) showed that quantum mechanics is incomplete, in the sense that it does not assign definite outcomes to measurements whose results can be predicted with certainty from the outcomes of spacelike separated measurements. Several years later Bell (1964) showed that EPR's hidden variable-theories collide with quantum mechanics, but at that time the EPR argument reinforced the resistance of Einstein (and many others) toward accepting quantum mechanics as a final theory.

Meanwhile, von Neumann observed that the two-valued observables, represented in quantum mechanics by projection operators, constitute a sort of "logic" of experimental propositions and, together with Birkhoff (Birkhoff and von Neumann, 1936), developed a "quantum logic", a set of algebraic rules governing operations to combine, and predicates to relate propositions associated with physical events. This logic would eventually provide a new basis for discussing the problem of hidden variables.

In 1952, Bohm (1952a,b) presented a hidden-variable theory that is a further elaboration of de Broglie's theory of 1927. Bohm's theory is deterministic and explicitly nonlocal at the level of hidden variables.

In parallel, Mackey (1957) asked whether every measure on the lattice of projections of a Hilbert space can be defined by a positive operator with unit trace. A positive answer would show that the Born rule follows from a particular set of axioms (framing a generalized probability theory) for quantum mechanics (Mackey, 1957, 1963). Although Kadison (Chernoff, 2009) [and later Bell (1966) and Kochen and Specker (1967)] proved that this was false for two-dimensional Hilbert spaces, Gleason (1957) showed it to be true for higher dimensions. Gleason's theorem is going to play a crucial role in the discussion of hidden variables. Mackey's program (Mackey, 1957) was further developed in several directions by Foulis and Randall (1972, 1974); Ludwig (1964, 1967, 1968, 1972); Piron (1964, 1976); Randall and Foulis (1970, 1973). All these works provided the basis of what is now called the framework of generalized probabilistic theories; see (Chiribella *et al.*, 2010; Hardy, 2001), which views quantum probability theory as one possibility in a landscape of probability theories and asks what is special about it.

## 2. The Kochen-Specker theorem

In 1960, Specker, a mathematician with theological concerns who inspired by "the question whether the omniscience of God also extends to events that would have occurred in case something would have happened that did not happen" (Specker, 1960) and by the logic of Birkhoff and von Neumann, reformulated the question of hidden variables as follows: "Is it possible to extend the description of a quantum mechanical system through the introduction of supplementary —fictitious— propositions in such a way that in the extended domain the classical propositional logic holds?" Specker found that "the answer to this question is negative, except in the case of Hilbert spaces of dimension 1 and 2" as "an elementary geometrical argument shows" (Specker, 1960) [quotation from the English translation of Seevinck (2011)].

In fact, according to Specker (Meon, 1990), "the basic theorem of the paper was proved shortly [after a seminar on the foundations of quantum theory]," a seminar that probably took place during the summer semester of 1948; see (Enz *et al.*, 1997). The geometrical argument was not fully presented until the collaborative paper of 1967 with Kochen (Kochen and Specker, 1967), although the fundamental building block for it discussed by Kochen and Specker (1965b) (Fig. 1, p. 182; see also Kochen and Specker, 1965a). The Kochen-Specker (KS) theorem shows the incompatibility between some predictions of quantum mechanics and a type of hidden variables that later came to be called noncontextual.

In 1963 (although it was not published until 1966) Bell developed a similar geometrical argument but one using

a more complex building block (Bell, 1966). Bell also used an infinite set of quantum observables. In contrast, Kochen and Specker managed to prove their theorem using 117 observables by concatenating their building block 15 times. In his paper, Bell seemed to have found this geometrical argument after Jauch draw his attention to the consequences of Gleason’s theorem to the problem of hidden variables (Bell, 1966). In fact, Bell later referred to this proof as “observed by Jauch” (Bell, 1971) and “subsequently set out by S. Kochen and E. P. Specker” (Bell, 1971) and even later Bell wrote that he “was told of it by J. M. Jauch in 1963” (Bell, 1982) and that “the idea was later rediscovered by Kochen and Specker” (Bell, 1982). As we pointed out, the idea was already in print in 1960.

Notably, Bell was not convinced that the proof was compelling. His source of discomfort was the observation that measuring the same observable in different contexts “require[s] different experimental arrangements; [and thus] there is no *a priori* reason to believe that the results . . . should be the same” (Bell, 1966). Bell added: “The result of observation may reasonably depend not only on the state of the system (including hidden variables) but also on the complete disposition of the apparatus” (Bell, 1966). Both Kochen and Specker (1967, see p. 73) and Bell (1966, see p. 451) seemed to believe that the only way to measure the same observable in two contexts is by measuring two maximal (and incompatible) quantum observables, one for each context. They did not consider the possibility, also offered by quantum mechanics, of measuring each observable using the same apparatus such that in each context one measures sequentially the observables of the context, as is done in modern sequential contextuality experiments (e.g., Kirchmair *et al.*, 2009).

In addition, Bell noticed the nonlocality in Bohm’s theory of 1952 [he writes, “[I]n this theory an explicitly causal mechanism exists whereby the disposition of one piece of apparatus affects the results obtained with a distant piece,” Bell, 1966] and how this is an unwanted feature, as it solves the EPR paradox “in the way Einstein would have liked least” (Bell, 1966). Finally, Bell pointed out that “there is no *proof* that *any* hidden variable account of quantum mechanics *must* have this extraordinary character. It would therefore be interesting . . . to pursue some further ‘impossibility proofs,’ replacing the arbitrary axioms objected to above by some condition of locality, or separability, of distant systems” (Bell, 1966). This led to Bell’s famous proof of impossibility of “local” hidden variables (Bell, 1964).

### 3. The origin of the word contextuality

The term contextuality in association with quantum mechanics derives (Jaeger, 2019; Shimony, 2009) from the term introduced by Shimony (Shimony, 1971) to designate the hidden-variable theories “in which the value of an observable  $O$  is allowed to depend not only upon the

hidden state  $\lambda$ , but also upon the set  $C$  of compatible observables measured along with  $O$ ” (Shimony, 1971). Shimony called them “contextualistic” hidden-variable theories. The shortening to “contextual” was made by Beltrametti and Cassinelli (1981) and then adopted by Shimony and others. In the 1990s, “Contextuality” became the title of a chapter of Peres’s influential book on quantum theory (Peres, 1993).

### 4. The relation between the KS and Bell theorems and the need for a theory-independent notion of noncontextuality

While Bell’s theorem gained prominence among physicists and the general public after the experiment of Freedman and Clauser (1972), Clauser (1976a,b), Aspect *et al.* (1982), and others and its applications to cryptography (Ekert, 1991) and quantum information, the KS theorem was for a long time a subject that interested primarily philosophers of science and a few physicists concerned about the foundations of quantum mechanics.

The situation began to change in the 1990s. On the one hand, Peres (1990, 1991, 1992, 1993) and Mermin (1990b, 1993) simplified the proof of the KS theorem using a small number of two- and three-qubit observables, making the KS theorem accessible to a wider audience. On the other hand, Mermin’s Bell inequality (Mermin, 1990a) and his “unified form for the major no-hidden-variables theorems” (Mermin, 1990b, 1993) connected the proof of Greenberger, Horne, and Zeilinger (GHZ, 1989) to the Bell inequalities and the KS theorem, respectively. Similar connections between the Bell and KS theorems had been found before by Kochen in a private communication with Shimony (Heywood and Redhead, 1983; Stairs, 1983); Stairs (1983), to whom Mermin acknowledges input (Mermin, 1993), and Heywood and Redhead (1983); see also Brown and Svetlichny (1990).

There was still something that blocked unification of the KS theorem and Bell’s theorem of impossibility of local hidden-variable theories. While Bell’s theorem leads to experimental tests of whether the world can be explained with theories that can be defined without any reference to quantum mechanics, the KS theorem is deeply attached to quantum mechanics. This attachment is triple.

First, the KS theorem does not refer to general measurements, but to those that are represented in quantum mechanics by the spectral projectors of a self-adjoint operator. What does this restriction mean from a theory-independent point of view? Moreover, in quantum mechanics there are measurements that are not represented by projective measurements but by POVMs.

Second, the proof of the KS theorem includes constraints that are specific to quantum systems. Examples of these constraints are that the values of the squared spin components of spin-1 particles for any orthogonal triad  $\{x, y, z\}$  should satisfy the equation  $v(S_x^2) + v(S_y^2) + v(S_z^2) = 2$  (Kochen and Specker, 1967) and that the val-

ues for the Pauli observables of two spin-1/2 particles should satisfy the equation  $v(\sigma_x^{(1)})v(\sigma_x^{(2)})v(\sigma_x^{(1)} \otimes \sigma_x^{(2)}) = 1$  (Mermin, 1990b; Peres, 1990). Third, the experimental translation of the KS theorem (as proposed by KS and Bell) assumes quantum mechanics, as it is assumed that coarse grainings of two different (and incompatible) measurements represent the same observable based on the fact that in quantum mechanics both yield the same outcome statistics.

Therefore, the problem was how to translate the KS theorem into experimental tests of contextuality in nature (Cabello and García-Alcaine, 1998). For that, what was needed was a theory-independent notion of contextuality that removes all the quantum constraints, includes a theory-independent definition of the type of measurements for which the assumption of outcome noncontextuality is made (similar to Bell’s theorem’s focus on local measurements), of the sets of measurements (contexts) whose correlations are considered (similar to Bell’s theorem’s focus on spatially separated local measurements), and a physical motivation for assuming outcome noncontextuality for these measurements and contexts (that plays the same role as the impossibility of communication between spacelike separated events in Bell’s theorem).

Nevertheless, the lack of such a formal framework did not impede experimental progress and the first “experiments towards falsification of noncontextual hidden variable theories” on single systems (Michler *et al.*, 2000), which took advantage of the analogy between two two-dimensional separated subsystems and 2 dichotomic degrees of freedom of a single photon and tested the violation of the single-particle equivalent of the Clauser-Horne-Shimony-Holt extension of the Bell inequality (Clauser *et al.*, 1969); see also Hasegawa *et al.*, 2003 for a similar experiment with neutrons.

However, it was the criticisms of Meyer (1999), Kent (1999), and Clifton and Kent (2000) toward the idea of giving the KS theorem a similar experimental status as Bell’s theorem (Cabello and García-Alcaine, 1998) that gave a definitive push to the transformation of contextuality into an experimentally testable property with no reference to quantum mechanics. These criticisms boosted vivid discussions (Appleby, 2000, 2001, 2002, 2005; Barrett and Kent, 2004; Cabello, 1999, 2002; Havlicek *et al.*, 2001; Mermin, 1999; Peres, 2003) and stimulated new developments. On the one hand, they stimulated the attempt to obtain experimentally testable “KS inequalities” (Larsson, 2002; Simon *et al.*, 2001). However, these first inequalities still made assumptions that hold only in quantum mechanics.

On the other hand, they stimulated a new notion of noncontextuality (Spekkens, 2005). This notion implicitly assumes that the hidden variables (or ontological models) merely provide a classical description of the same operations as those allowed in quantum mechanics, without any possibility of predictions deviating from those of quantum mechanics or even redundancy in the description, i.e., a different description at the level of the for-

malism for physically equivalent situations, as it happens for gauge symmetries.

## 5. Noncontextuality for ideal measurements

The final boost for a general theory-independent framework for contextuality rooted in the notion of noncontextuality used by KS (but free of the assumptions that hold only in quantum mechanics) was the discovery of the quantum violation of the KCBS inequality (Klyachko *et al.*, 2008) by single qutrits in a specific quantum state, followed by the discovery of similar inequalities that are violated by any quantum state (of a given dimension) (Badziąg *et al.*, 2009; Cabello, 2008). Unlike previous inequalities, the bounds of these inequalities are derived only from the assumption of outcome noncontextuality, without extra constraints inspired by quantum mechanics.

The KCBS inequality was introduced in an earlier paper (Klyachko, 2007) as a way of showing that single spin-1 particles can exhibit a form of “single-particle entanglement,” defined as maximal uncertainty of a set of observables associated with a Lie algebra. This led to the question: For what type of measurements and contexts is there an “*a priori* reason to believe that the results for should be the same” (Bell, 1966)? One possible answer is, for those measurements that yield the same result when performed repeatedly on the same physical system and do not produce any change in the outcomes of any jointly measurable observable, and for contexts made of compatible sets of them. These measurements are called ideal (Cabello, 2019b) or sharp (Chiribella and Yuan, 2016). Intuitively, ideal measurements reveal preexisting context-independent “properties” of the measured system that are preserved after the act of measuring. However, in general, this may not be the case.

The focus on contexts made of compatible ideal measurements allows us to formulate a notion of contextuality in the operational framework of generalized probabilistic theories without any reference to quantum mechanics. This theory-independent notion of contextuality is referred to as contextuality for ideal measurements or KS contextuality, as it is inspired by the work of Kochen and Specker. This notion allows us to replace or remove the two assumptions of the KS theorem that refer to quantum mechanics. Namely, (I) that measurements represented in quantum theory by self-adjoint operators reveal preexisting values that are independent of the “context,” where context meant set of measurements represented by mutually commuting self-adjoint operators, and (II) that measurement outcomes must satisfy the same functional relations that quantum mechanics predicts for commuting measurements on quantum systems of a given dimension. Instead of that, in KS contextuality, (I) is replaced by the assumption of outcome noncontextuality for ideal measurements and (II) is completely removed. Notably, the new notion provides a ba-

sis for experimentally testing KS contextuality in nature.

## 6. The hidden history of noncontextuality inequalities

The mathematical tools needed for studying contextuality were developed independently of physics and long before quantum mechanics. We call a contextuality scenario a set of abstract ideal measurements, each of them having a number of possible outcomes, and their relations of compatibility. For example, the scenario considered by KCBS (Klyachko *et al.*, 2008) has five measurements  $M_i$ ,  $i = 0, \dots, 4$ , each of which has two possible outcomes, and such that  $M_i$  and  $M_{i+1}$  (with the sum modulo 5) are compatible. Therefore, in the KCBS contextuality scenario there are five contexts. For each contextuality scenario, a “matrix of correlation,” “behavior,” or simply “correlation” is a set of probabilities for all possible combination of outcomes in each of the contexts. One obtains one of these correlations using a specific initial state and measurements. Probabilities have to satisfy the corresponding normalization and nondisturbance (or nonsignaling) constraints.

Like what happens in Bell scenarios (Fine, 1982a,b; Froissart, 1981; Garg and Mermin, 1984; Pitowsky, 1986, 1989, 1991; Suppes and Zanotti, 1981), in any KS scenario the set of correlations satisfying outcome noncontextuality is a polytope. Here it is called the noncontextual polytope of the scenario. Correlations outside this set are contextual and violate one of the linear inequalities (in the probabilities) that define the facets of the noncontextuality polytope. Each of these facets corresponds to a inequality that is necessary for noncontextuality and is called a tight noncontextuality inequality. These inequalities were introduced long before quantum mechanics.

In 1990, during a symposium in Jerusalem and Tel Aviv coincidentally entitled “Einstein in context,” Pitowsky distributed among the participants a draft [later published as (Pitowsky, 1994)] where he pointed out that Boole (1862), one of the fathers of modern logic, had developed a set of equalities and inequalities he called “conditions of possible experience” (Boole, 1862) and that the Bell inequalities violated by quantum mechanics were a subset of them.

This observation leads to the following questions: (i) Which of Boole’s inequalities can be violated? (ii) What is the largest set of correlations possible for a given scenario? (iii) How does this set compare to the one in quantum theory? Answering these questions would have helped to answer the central question Pitowsky asked: “WHY is [it] that microphysical phenomena and classical phenomena differ in the way they do?” (Pitowsky, 1994).

The answer to question (i) was known in the 1960s. A theorem introduced by Vorob’ev (1962, 1959); Vorob’ev (1967) showed that a violation of Boole’s inequalities can occur only for scenarios in which the graph of compati-

bility contains an induced cyclic path with a size larger than 3 (i.e., following the path along some edges of the graph one obtains a square, a pentagon, a hexagon, etc). The graph of compatibility is the one in which compatible measurements are represented by adjacent vertices. Otherwise, there is always a joint probability distribution, and therefore a noncontextual model. Bell inequalities violated by quantum mechanics correspond to scenarios with this property.

The CHSH scenario (Clauser *et al.*, 1970), with four dichotomic measurements whose graph of compatibility is a square, is therefore the one with the smallest number of ideal measurements that allow for contextual correlations. In fact, the CHSH inequality is the only nontrivial tight noncontextuality inequality for the CHSH scenario (Fine, 1982a,b).

Both Bell (1966) and Kochen and Specker (1967) noticed that the statistics of ideal measurements on a two-dimensional quantum system (or qubit) can be reproduced with noncontextual models. Therefore, interesting questions are as follows: in which scenario does a three-dimensional quantum system (or qutrit) violate noncontextuality inequalities with ideal measurements? What are these inequalities? The answer to the first question is the KCBS scenario (Klyachko *et al.*, 2008). The KCBS inequality is the only tight noncontextuality inequality for the KCBS scenario (Araújo *et al.*, 2013). The KCBS scenario, which was previously considered in some papers on quantum logic (Gerelle *et al.*, 1974; Wright, 1978), is also the scenario with the smallest number of ideal measurements whose relations of compatibility (and incompatibility) cannot occur in a Bell scenario. All these features made the KCBS inequality a key to the world of KS contextuality.

## References

- Aaronson, S., and D. Gottesman (2004), *Phys. Rev. A* **70**, 052328.
- Abbott, A. A., C. S. Calude, J. Conder, and K. Svovil (2012), *Phys. Rev. A* **86**, 062109.
- Abbott, A. A., C. S. Calude, M. J. Dinneen, and N. Huang (2019), *Physica Scripta* **94**, 045103.
- Abbott, A. A., C. S. Calude, and K. Svovil (2014), *Math. Struct. Comput. Sci.* **24**, e240303.
- Abbott, A. A., C. S. Calude, and K. Svovil (2015), *J. Math. Phys.* **56** (10), 102201.
- Abbott, A. A., C. Giarmatzi, F. Costa, and C. Branciard (2016), *Phys. Rev. A* **94**, 032131.
- Abramsky, S., R. S. Barbosa, M. Karvonen, and S. Mansfield (2019), in *2019 34th Annual ACM/IEEE Symposium on Logic in Computer Science (LICS)*.
- Abramsky, S., R. S. Barbosa, K. Kishida, R. Lal, and S. Mansfield (2015), in *24th EACSL Annual Conference on Computer Science Logic (CSL 2015)*, Leibniz International Proceedings in Informatics (LIPIcs), Vol. 41, edited by S. Kreutzer (Schloss Dagstuhl–Leibniz-Zentrum fuer Informatik, Dagstuhl, Germany) pp. 211–228.

- Abramsky, S., R. S. Barbosa, and S. Mansfield (2017), *Phys. Rev. Lett.* **119**, 050504.
- Abramsky, S., and A. Brandenburger (2011), *New J. Phys.* **13**, 113036.
- Abramsky, S., S. Mansfield, and R. S. Barbosa (2012), in *Proc. 8th International Workshop on Quantum Physics and Logic*, Vol. 95, edited by B. Jacobs, P. Selinger, and B. Spitters, pp. 1–14.
- Acín, A., N. Brunner, N. Gisin, S. Massar, S. Pironio, and V. Scarani (2007), *Phys. Rev. Lett.* **98**, 230501.
- Acín, A., T. Fritz, A. Leverrier, and A. B. Sainz (2015), *Commun. Math. Phys.* **334**, 533.
- Agüero Trejo, J. M., and C. S. Calude (2021), *Theoretical Computer Science* **862**, 3, a Fascinating Rainbow of Computation – Honoring Gheorghe Păun on the Occasion of His 70th Birthday.
- Alda, V. (1980), *Aplikace Matematiky* **25**, 373.
- Ali, S. T., C. Carmeli, T. Heinosaari, and A. Toigo (2009), *Found. Phys.* **39**, 593.
- Amaral, B., A. Cabello, M. T. Cunha, and L. Aolita (2018a), *Phys. Rev. Lett.* **120**, 130403.
- Amaral, B., M. T. Cunha, and A. Cabello (2015), *Phys. Rev. A* **92**, 062125.
- Amaral, B., and C. Duarte (2019), *Phys. Rev. A* **100**, 062103.
- Amaral, B., C. Duarte, and R. I. Oliveira (2018b), *J. Math. Phys.* **59**, 072202.
- Amaral, B., and M. Terra Cunha (2018), *On Graph Approaches to Contextuality and Their Role in Quantum Theory* (Springer).
- Amaral, B., M. Terra Cunha, and A. Cabello (2014), *Phys. Rev. A* **89**, 030101.
- Ambainis, A., M. Banik, A. Chaturvedi, D. Kravchenko, and A. Rai (2019), *Quant. Inf. Process.* **18**, 1.
- Ambainis, A., A. Nayak, A. Ta-Shma, and U. Vazirani (2002), *J. ACM* **49**, 496.
- Amselem, E., M. Bourennane, C. Budroni, A. Cabello, O. Gühne, M. Kleinmann, J.-Å. Larsson, and M. Wieśniak (2013), *Phys. Rev. Lett.* **110**, 078901.
- Amselem, E., L. E. Danielsen, A. J. López-Tarrida, J. R. Portillo, M. Bourennane, and A. Cabello (2012), *Phys. Rev. Lett.* **108**, 200405.
- Amselem, E., M. Rådmark, M. Bourennane, and A. Cabello (2009), *Phys. Rev. Lett.* **103**, 160405.
- Anders, J., and D. E. Browne (2009), *Phys. Rev. Lett.* **102**, 050502.
- Anwer, H., N. Wilson, R. Silva, S. Muhammad, A. Tavakoli, and M. Bourennane (2019), [arXiv:1904.09766 \[quant-ph\]](https://arxiv.org/abs/1904.09766).
- Aolita, L., R. Gallego, A. Acín, A. Chiuri, G. Vallone, P. Mataloni, and A. Cabello (2012), *Phys. Rev. A* **85**, 032107.
- Appleby, D. M. (2000), [arXiv:quant-ph/0005010 \[quant-ph\]](https://arxiv.org/abs/quant-ph/0005010).
- Appleby, D. M. (2001), [arXiv:quant-ph/0109034 \[quant-ph\]](https://arxiv.org/abs/quant-ph/0109034).
- Appleby, D. M. (2002), *Phys. Rev. A* **65**, 022105.
- Appleby, D. M. (2005), *Stud. Hist. Philos. Sci. B* **36**, 1.
- Appleby, D. M., I. Bengtsson, and S. Chaturvedi (2008), *J. Math. Phys.* **49**, 012102.
- Araújo, M., M. T. Quintino, C. Budroni, M. Terra Cunha, and A. Cabello (2013), *Phys. Rev. A* **88**, 022118.
- Aravind, P. K. (2004), *Am. J. Phys.* **72**, 1303.
- Aravind, P. K., and F. Lee-Elkin (1998), *J. Phys. A* **31**, 9829.
- Arends, F., J. Ouaknine, and C. W. Wampler (2011), in *Graph-Theoretic Concepts in Computer Science*, edited by P. Kolman and J. Kratochvíl (Springer, New York) pp. 23–34.
- Arias, M., G. Cañas, E. S. Gómez, J. F. Barra, G. B. Xavier, G. Lima, V. D’Ambrosio, F. Baccari, F. Sciarrino, and A. Cabello (2015), *Phys. Rev. A* **92**, 032126.
- Arkhipov, A. (2012), [arXiv:1209.3819 \[quant-ph\]](https://arxiv.org/abs/1209.3819).
- Arvidsson-Shukur, D. R. M., N. Yunger Halpern, H. V. Lepage, A. A. Lasek, C. H. W. Barnes, and S. Lloyd (2020), *Nat. Commun.* **11**, 3775.
- Asadian, A., C. Budroni, F. E. S. Steinhoff, P. Rabl, and O. Gühne (2015), *Phys. Rev. Lett.* **114**, 250403.
- Aspect, A., J. Dalibard, and G. Roger (1982), *Phys. Rev. Lett.* **49**, 1804.
- Auffèves, A., and P. Grangier (2020), *Found. Phys.* **50** (12), 1781.
- Auffèves, A., and P. Grangier (2022), *Entropy* **24** (2), 199.
- Avis, D. (2018), “lrs <http://cgm.cs.mcgill.ca/~avis/C/lrs.html>,”.
- Badziąg, P., I. Bengtsson, A. Cabello, and I. Pitowsky (2009), *Phys. Rev. Lett.* **103**, 050401.
- Ballentine, L. (2014), [arXiv:1402.5689 \[quant-ph\]](https://arxiv.org/abs/1402.5689).
- Banik, M., S. S. Bhattacharya, S. K. Choudhary, A. Mukherjee, and A. Roy (2014), *Foundations of Physics* **44**, 1230.
- Banik, M., S. S. Bhattacharya, A. Mukherjee, A. Roy, A. Ambainis, and A. Rai (2015), *Phys. Rev. A* **92**, 030103.
- Barbieri, M., C. Cinelli, P. Mataloni, and F. De Martini (2005), *Phys. Rev. A* **72**, 052110.
- Barbieri, M., G. Vallone, F. De Martini, and P. Mataloni (2007), *Opt. Spectrosc.* **103**, 129.
- Barnett, N., and J. P. Crutchfield (2015), *J. Stat. Phys.* **161**, 404.
- Barnett, S. M., and S. Croke (2009), *Adv. Opt. Photonics* **1**, 238.
- Barrett, J., L. Hardy, and A. Kent (2005a), *Phys. Rev. Lett.* **95**, 010503.
- Barrett, J., and A. Kent (2004), *Stud. Hist. Philos. Sci. B* **35**, 151.
- Barrett, J., A. Kent, and S. Pironio (2006), *Phys. Rev. Lett.* **97**, 170409.
- Barrett, J., N. Linden, S. Massar, S. Pironio, S. Popescu, and D. Roberts (2005b), *Phys. Rev. A* **71**, 022101.
- Bartosik, H., J. Klepp, C. Schmitzer, S. Sponar, A. Cabello, H. Rauch, and Y. Hasegawa (2009), *Phys. Rev. Lett.* **103**, 040403.
- Bassi, A., K. Lochan, S. Satin, T. P. Singh, and H. Ulbricht (2013), *Rev. Mod. Phys.* **85**, 471.
- Bechmann-Pasquinucci, H., and A. Peres (2000), *Phys. Rev. Lett.* **85**, 3313.
- Beer, K., and T. J. Osborne (2018), *Phys. Rev. A* **98**, 052124.
- Beeri, C., R. Fagin, D. Maier, and M. Yannakakis (1983), *J. ACM* **30**, 479.
- Belinfante, F. J. (1973), *A Survey of Hidden-Variables Theories*, 1st ed., Monographs in Natural Philosophy (Elsevier Ltd, Pergamon Press, New York).
- Bell, J. S. (1964), *Physics* **1**, 195.
- Bell, J. S. (1966), *Rev. Mod. Phys.* **38**, 447.
- Bell, J. S. (1971), in *Foundations of Quantum Mechanics*, Proceedings of the International School of Physics ‘Enrico Fermi’, Vol. II, edited by B. D’Espagnat (Academic Press, New York) pp. 171–181.
- Bell, J. S. (1982), *Found. Phys.* **12**, 989.
- Beltrametti, E. G., and C. Cassinelli (1981), *The Logic of Quantum Mechanics* (Addison-Wesley, Reading, MA).
- Bengtsson, I. (2009), *AIP Conf. Proc.* **1101**, 241.
- Bengtsson, I., K. Blanchfield, and A. Cabello (2012), *Phys. Lett. A* **376**, 374.
- Bennett, C. H., and G. Brassard (1984), in *Proceedings of*

- IEEE International Conference on Computers, Systems & Signal Processing, Bangalore, India* (IEEE, New York) pp. 175–179.
- Bermejo-Vega, J., N. Delfosse, D. E. Browne, C. Okay, and R. Raussendorf (2017), *Phys. Rev. Lett.* **119**, 120505.
- Bertlmann, R. A., and A. Zeilinger (2013), *Quantum (un)speakables: from bell to quantum information* (Springer Science & Business Media).
- Bharti, K., M. Ray, A. Varvitsiotis, A. Cabello, and L.-C. Kwek (2019a), arXiv:1911.09448 [quant-ph] .
- Bharti, K., M. Ray, A. Varvitsiotis, N. A. Warsi, A. Cabello, and L.-C. Kwek (2019b), *Phys. Rev. Lett.* **122**, 250403.
- Bharti, K., M. Ray, Z.-P. Xu, M. Hayashi, L.-C. Kwek, and A. Cabello (2021), arXiv:2104.13035 [quant-ph] .
- Birkhoff, G., and J. von Neumann (1936), *Ann. Math.* **37**, 823.
- Blasiak, P. (2015), *Ann. Phys.* **353**, 326.
- Bohm, D. (1952a), *Phys. Rev.* **85**, 166.
- Bohm, D. (1952b), *Phys. Rev.* **85**, 180.
- Boole, G. (1862), *Philos. Trans. R. Soc. Lond.* **152**, 225.
- Borges, G., M. Carvalho, P.-L. de Assis, J. Ferraz, M. Araújo, A. Cabello, M. Terra Cunha, and S. Pádua (2014), *Phys. Rev. A* **89**, 052106.
- Born, M. (1926a), *Z. Physik* **38**, 803.
- Born, M. (1926b), *Z. Physik* **37**, 863.
- Boyd, S., and L. Vandenberghe (2004), *Convex optimization* (Cambridge University Press, Cambridge).
- Brassard, G., A. Broadbent, and A. Tapp (2005), *Found. Phys.* **35**, 1877.
- Braunstein, S. L., and C. M. Caves (1988), *Phys. Rev. Lett.* **61**, 662.
- Braunstein, S. L., and C. M. Caves (1990), *Ann. Phys.* **202**, 22.
- Bravyi, S., D. Gosset, and R. König (2018), *Science* **362**, 308.
- Bravyi, S., D. Gosset, R. König, and M. Tomamichel (2020), *Nat. Phys.* **16**, 1040.
- Bravyi, S., and A. Kitaev (2005), *Phys. Rev. A* **71**, 022316.
- Bretto, A. (2013), *Hypergraph theory* (Springer, Heidelberg).
- Briegel, H. J., D. E. Browne, W. Dür, R. Raussendorf, and M. Van den Nest (2009), *Nat. Phys.* **5**, 19.
- Brown, H. R., and G. Svetlichny (1990), *Found. Phys.* **20**, 1379.
- Brunner, N., D. Cavalcanti, S. Pironio, V. Scarani, and S. Wehner (2014), *Rev. Mod. Phys.* **86**, 419.
- Bub, J. (1996), *Found. Phys.* **26**, 787.
- Bub, J. (1997), *Interpreting the Quantum World* (Cambridge University Press, Cambridge).
- Budroni, C., and A. Cabello (2012), *J. Phys. A: Math. Theor.* **45**, 385304.
- Budroni, C., G. Fagundes, and M. Kleinmann (2019), *New J. Phys.* **21**, 093018.
- Budroni, C., N. Miklin, and R. Chaves (2016), *Phys. Rev. A* **94**, 042127.
- Budroni, C., and G. Morchio (2010), *J. Math. Phys.* **51**, 122205.
- Budroni, C., G. Vitagliano, and M. P. Woods (2021), *Phys. Rev. Research* **3**, 033051.
- Busch, P., P. Lahti, and R. F. Werner (2014), *Rev. Mod. Phys.* **86**, 1261.
- Busch, P., P. J. Lahti, and P. Mittelstaedt (1996), *The Quantum Theory of Measurement*, 2nd ed., Lecture Notes in Physics Monographs, Vol. 2 (Springer-Verlag Berlin Heidelberg).
- Busch, P., P. J. Lahti, J.-P. Pellonpää, and K. Ylänen (2016), *Quantum measurement*, Vol. 890 (Springer).
- Cabello, A. (1994), *Eur. J. Phys.* **15**, 179.
- Cabello, A. (1997), *Phys. Rev. A* **55**, 4109.
- Cabello, A. (1999), arXiv:quant-ph/9911024 [quant-ph] .
- Cabello, A. (2001a), *Phys. Rev. Lett.* **87**, 010403.
- Cabello, A. (2001b), *Phys. Rev. Lett.* **86**, 1911.
- Cabello, A. (2002), *Phys. Rev. A* **65**, 052101.
- Cabello, A. (2005), *Phys. Rev. Lett.* **95**, 210401.
- Cabello, A. (2008), *Phys. Rev. Lett.* **101**, 210401.
- Cabello, A. (2009), in *Foundations of Probability and Physics - 5 (Värjö, Sweden, 24–27 August 2008)*, edited by L. Accardi, G. Adenier, C. Fuchs, G. Jaeger, A. Y. Khrennikov, J.-Å. Larsson, and S. Stenholm (American Institute of Physics, New York) pp. 246–254.
- Cabello, A. (2010), *Phys. Rev. Lett.* **104**, 220401.
- Cabello, A. (2011), arXiv:1112.5149 [quant-ph] .
- Cabello, A. (2012), arXiv:1212.1756 [quant-ph] .
- Cabello, A. (2013), *Phys. Rev. Lett.* **110**, 060402.
- Cabello, A. (2015), *Phys. Rev. Lett.* **114**, 220402.
- Cabello, A. (2016), *Phys. Rev. A* **93**, 032102.
- Cabello, A. (2019a), *Philos. Trans. R. Soc. A* **377**, 20190136.
- Cabello, A. (2019b), *Phys. Rev. A* **100**, 032120.
- Cabello, A. (2021), *Phys. Rev. Lett.* **127**, 070401.
- Cabello, A., E. Amsalem, K. Blanchfield, M. Bourennane, and I. Bengtsson (2012), *Phys. Rev. A* **85**, 032108.
- Cabello, A., L. E. Danielsen, A. J. López-Tarrida, and J. R. Portillo (2013), *Phys. Rev. A* **88**, 032104.
- Cabello, A., J. M. Estebarez, and G. García-Alcaine (1996a), *Phys. Lett. A* **212**, 183.
- Cabello, A., J. M. Estebarez, and G. García-Alcaine (1996b), *Phys. Lett. A* **218**, 115.
- Cabello, A., J. M. Estebarez, and G. García-Alcaine (2005), *Phys. Lett. A* **339**, 425.
- Cabello, A., and G. García-Alcaine (1995), *J. Phys. A: Math. Gen.* **28**, 3719.
- Cabello, A., and G. García-Alcaine (1996), *J. Phys. A: Math. Gen.* **29**, 1025.
- Cabello, A., and G. García-Alcaine (1998), *Phys. Rev. Lett.* **80**, 1797.
- Cabello, A., M. Gu, O. Gühne, J.-Å. Larsson, and K. Wiesner (2016a), *Phys. Rev. A* **94**, 052127.
- Cabello, A., M. Gu, O. Gühne, and Z.-P. Xu (2018a), *Phys. Rev. Lett.* **120**, 130401.
- Cabello, A., M. Kleinmann, and C. Budroni (2015), *Phys. Rev. Lett.* **114**, 250402.
- Cabello, A., M. Kleinmann, and J. R. Portillo (2016b), *J. Phys. A: Math. Theor.* **49**, 38LT01.
- Cabello, A., and J.-Å. Larsson (2010), *Phys. Lett. A* **375**, 99.
- Cabello, A., J. R. Portillo, A. Solís, and K. Svoboda (2018b), *Phys. Rev. A* **98**, 012106.
- Cabello, A., S. Severini, and A. Winter (2010), arXiv:1010.2163 [quant-ph] .
- Cabello, A., S. Severini, and A. Winter (2014), *Phys. Rev. Lett.* **112**, 040401.
- Carù, G. (2017), in *Proc. 13th International Workshop on Quantum Physics and Logic*, Vol. 236, edited by R. Duncan and C. Heunen, pp. 21–39.
- Cerf, N. J., N. Gisin, S. Massar, and S. Popescu (2005), *Phys. Rev. Lett.* **94**, 220403.
- Chailloux, A., I. Kerenidis, S. Kundu, and J. Sikora (2016), *New J. Phys.* **18**, 045003.
- Chaturvedi, A., M. Farkas, and V. J. Wright (2021), “Characterising and bounding the set of quantum behaviours in

- contextuality scenarios,” .
- Chaves, R. (2013), *Phys. Rev. A* **87**, 022102.
- Chaves, R., and T. Fritz (2012), *Phys. Rev. A* **85**, 032113.
- Chaves, R., L. Luft, and D. Gross (2014), *New J. Phys.* **16**, 043001.
- Chen, Z.-B., J.-W. Pan, Y.-D. Zhang, Č. Brukner, and A. Zeilinger (2003), *Phys. Rev. Lett.* **90**, 160408.
- Chernoff, P. R. (2009), *Not. AMS* **87**, 1253.
- Chiribella, G., A. Cabello, M. Kleinmann, and M. P. Müller (2020), *Phys. Rev. Res.* **2**, 042001.
- Chiribella, G., G. M. D’Ariano, and P. Perinotti (2010), *Phys. Rev. A* **81**, 062348.
- Chiribella, G., and X. Yuan (2014), [arXiv:1404.3348 \[quant-ph\]](https://arxiv.org/abs/1404.3348) .
- Chiribella, G., and X. Yuan (2016), *Inf. Comput.* **250**, 15.
- Christof, T., and A. Loebel (2015), “Porta <http://porta.zib.de/>,” .
- Cinelli, C., M. Barbieri, R. Perris, P. Mataloni, and F. De Martini (2005), *Phys. Rev. Lett.* **95**, 240405.
- Cirel’son, B. S. (1980), *Lett. Math. Phys.* **4:2**, 93.
- Clauser, J. F. (1976a), *Phys. Rev. Lett.* **36**, 1223.
- Clauser, J. F. (1976b), *Nuovo Cimento B* **33**, 740.
- Clauser, J. F., M. A. Horne, A. Shimony, and R. A. Holt (1969), *Phys. Rev. Lett.* **23**, 880.
- Clauser, J. F., M. A. Horne, A. Shimony, and R. A. Holt (1970), *Phys. Rev. Lett.* **24**, 549, (Erratum).
- Cleve, R., P. Hoyer, B. Toner, and J. Watrous (2004), in *Proceedings. 19th IEEE Annual Conference on Computational Complexity*, pp. 236–249.
- Clifton, R. K. (1993), *Am. J. Phys.* **61**, 443.
- Clifton, R. K., and A. Kent (2000), *Proc. R. Soc. Lond. A* **456**, 2101.
- Coecke, B., T. Fritz, and R. W. Spekkens (2016), *Information and Computation* **250**, 59.
- Colbeck, R. (2006), *Quantum and Relativistic Protocols for Secure Multi-Party Computation*, Ph.D. thesis (University of Cambridge), [arXiv:0911.3814 \[quant-ph\]](https://arxiv.org/abs/0911.3814) .
- Conway, J., and S. Kochen (2006), *Found. Phys.* **36**, 1441.
- Conway, J., and S. Kochen (2009), *Not. AMS* **56**, 226.
- Conway, J. H., and S. Kochen (2000), “Reported in (Peres, 1993) and as a letter “The geometry of quantum paradoxes” in (Bertlmann and Zeilinger, 2013),” .
- Correggi, M., and G. Morchio (2002), *Ann. Phys.* **296**, 371.
- Crutchfield, J. P. (1994), *Phys. D: Nonlinear Phenom.* **75**, 11.
- Cubitt, T. S., D. Leung, W. Matthews, and A. Winter (2010), *Phys. Rev. Lett.* **104**, 230503.
- Cubitt, T. S., D. Leung, W. Matthews, and A. Winter (2011), *IEEE Trans. Inf. Theory* **57**, 5509.
- van Dam, S. B., J. Cramer, T. H. Taminiau, and R. Hanson (2019), *Phys. Rev. Lett.* **123**, 050401.
- van Dam, W. (1999), *Nonlocality & Communication Complexity*, Ph.D. thesis (University of Oxford), chapter 9.
- De Simone, A., and P. Pták (2015), *Linear Algebra and its Applications* **481**, 243.
- Delfosse, N., P. Allard Guerin, J. Bian, and R. Raussendorf (2015), *Phys. Rev. X* **5**, 021003.
- Delfosse, N., C. Okay, J. Bermejo-Vega, D. E. Browne, and R. Raussendorf (2017), *New J. Phys.* **19**, 123024.
- Diestel, R. (2018), *Graph theory* (Springer Publishing Company, Incorporated).
- Durucan, S., and A. Grinbaum (2020), [arXiv:2007.03450 \[quant-ph\]](https://arxiv.org/abs/2007.03450) .
- Dvurečenskij, A., S. Pulmannová, and K. Svoboda (1995), *Helv. Phys. Acta* **68**, 407.
- Einstein, A., B. Podolsky, and N. Rosen (1935), *Phys. Rev.* **47**, 777.
- Ekert, A. K. (1991), *Phys. Rev. Lett.* **67**, 661.
- Elby, A. (1990a), *Found. Phys.* **20**, 1389.
- Elby, A. (1990b), *Found. Phys. Lett.* **3**, 239.
- Elby, A., and M. R. Jones (1992), *Phys. Lett. A* **171**, 11.
- Elitzur, A. C., S. Popescu, and D. Rohrlich (1992), *Phys. Lett. A* **162**, 25.
- Emary, C., N. Lambert, and F. Nori (2014), *Rep. Prog. Phys.* **77**, 016001.
- Emeriau, P.-E., M. Howard, and S. Mansfield (2020), [arXiv:2007.15643 \[quant-ph\]](https://arxiv.org/abs/2007.15643) .
- van Enk, S. J. (2007), *Found. Phys.* **37**, 1447.
- Enz, C. P., B. Glaus, and G. Oberkofler (1997), *Wolfgang Pauli und sein Wirken an der ETH Zürich* (vdf Hochschulverlag AG an der ETH Zürich).
- Fagundes, G., and M. Kleinmann (2017), *J. Phys. A: Math. Theor.* **50**, 325302.
- Fine, A. (1982a), *Phys. Rev. Lett.* **48**, 291.
- Fine, A. (1990), *Found. Phys.* **20** (8), 967.
- Fine, A. I. (1982b), *J. Math. Phys.* **23**, 1306.
- Foulis, D. J., and C. H. Randall (1972), *J. Math. Phys.* **13**, 1667.
- Foulis, D. J., and C. H. Randall (1974), *Synthese* **29**, 81.
- Freedman, S. J., and J. F. Clauser (1972), *Phys. Rev. Lett.* **28**, 938.
- Frembs, M., S. Roberts, and S. D. Bartlett (2018), *New J. Phys.* **20**, 103011.
- Fritz, T. (2012), *Rev. Math. Phys.* **24**, 1250012.
- Fritz, T., and R. Chaves (2013), *IEEE Trans. Inf. Theory* **59**, 803.
- Fritz, T., A. B. Sainz, R. Augusiak, J. B. Brask, R. Chaves, A. Leverrier, and A. Acín (2013), *Nat. Commun.* **4**, 1.
- Froissart, M. (1981), *Nuovo Cimento B* **64**, 241.
- Frustaglia, D., J. P. Baltanás, M. C. Velázquez-Ahumada, A. Fernández-Prieto, A. Lujambio, V. Losada, M. J. Freire, and A. Cabello (2016), *Phys. Rev. Lett.* **116**, 250404.
- Fuchs, C. A. (2002), [arXiv:quant-ph/0205039 \[quant-ph\]](https://arxiv.org/abs/quant-ph/0205039) .
- Fuchs, C. A. (2011), *Coming of Age With Quantum Information: Notes on a Paulian Idea* (Cambridge University Press).
- Fukuda, K. (2018), “cdd [https://people.inf.ethz.ch/fukudak/cdd\\_home/](https://people.inf.ethz.ch/fukudak/cdd_home/),” .
- Galindo, A. (1975), in *Algunas Cuestiones de Física Teórica* (G. I. F. T., Zaragoza) pp. 3–9.
- Gao, X., E. R. Anschuetz, S.-T. Wang, J. I. Cirac, and M. D. Lukin (2022), *Phys. Rev. X* **12**, 021037.
- Garey, M. R., and D. S. Johnson (2002), *Computers and intractability*, Vol. 29 (W. H. Freeman, New York, NY).
- Garg, A., and N. D. Mermin (1984), *Found. Phys.* **14**, 1.
- Gerelle, E. R., R. J. Greechie, and F. R. Miller (1974), in *Physical Reality & Mathematical Description* (Reidel, Dordrecht, Holland) pp. 169–192.
- Ghorai, S., and A. K. Pan (2018), *Phys. Rev. A* **98**, 032110.
- Gibbons, K. S., M. J. Hoffman, and W. K. Wootters (2004), *Phys. Rev. A* **70**, 062101.
- Gill, R. D., and M. Keane (1996), *J. Phys. A* **29**, L289.
- Gleason, A. M. (1957), *J. Math. Mech.* **6**, 885.
- Godsil, C. D., and J. Zaks (1988), University of Waterloo Research Report No. CORR 88-12 [arXiv:1201.0486 \[math.CO\]](https://arxiv.org/abs/1201.0486) .
- Gottesman, D. (1997), *Stabilizer codes and quantum error correction*, phdthesis (California Institute of Technology), [arXiv:quant-ph/9705052 \[quant-ph\]](https://arxiv.org/abs/quant-ph/9705052) .

- Gould, E., and P. K. Aravind (2010), *Found. Phys.* **40**, 1096.
- Grangier, P. (2021), *Entropy* **23** (12), 1660.
- Greechie, R. J. (1971), *Journal of Combinatorial Theory, Series A* **10** (2), 119.
- Greenberger, D. M., M. A. Horne, and A. Zeilinger (1989), in *Bell's theorem, quantum theory and conceptions of the universe* (Springer) pp. 69–72.
- Grötschel, M., L. Lovász, and A. Schrijver (1993), *Geometric algorithms and combinatorial optimization: Algorithms and Combinatorics* (Springer-Verlag, Berlin).
- Griffiths, R. B. (2017), *Phys. Rev. A* **96**, 032110.
- Griffiths, R. B. (2019), *Philosophical Transactions of the Royal Society A: Mathematical, Physical and Engineering Sciences* **377** (2157), 20190033.
- Griffiths, R. B. (2020), *Phys. Rev. A* **101**, 022117.
- Gross, D. (2006), *J. Math. Phys.* **47**, 122107.
- Grudka, A., K. Horodecki, M. Horodecki, P. Horodecki, R. Horodecki, P. Joshi, W. Kłobus, and A. Wójcik (2014), *Phys. Rev. Lett.* **112**, 120401.
- Grünbaum, B. (2003), *Convex polytopes*, 2nd ed. (Springer, New York).
- Gu, M., K. Wiesner, E. Rieper, and V. Vedral (2012), *Nat. Commun.* **3**, 762.
- Gühne, O., C. Budroni, A. Cabello, M. Kleinmann, and J.-Å. Larsson (2014), *Phys. Rev. A* **89**, 062107.
- Gühne, O., M. Kleinmann, A. Cabello, J.-Å. Larsson, G. Kirchmair, F. Zähringer, R. Gerritsma, and C. F. Roos (2010), *Phys. Rev. A* **81**, 022121.
- Hales, A. W., and E. G. Straus (1982), *Pac. J. Math.* **99**, 31.
- Hameedi, A., A. Tavakoli, B. Marques, and M. Bourennane (2017), *Phys. Rev. Lett.* **119**, 220402.
- Hardy, L. (1992), *Phys. Rev. Lett.* **68**, 2981.
- Hardy, L. (1993), *Phys. Rev. Lett.* **71**, 1665.
- Hardy, L. (2001), arXiv:quant-ph/0101012 [quant-ph] .
- Harrigan, N., and R. W. Spekkens (2010), *Found. Phys.* **40**, 125.
- Hasegawa, Y., R. Loidl, G. Badurek, M. Baron, and H. Rauch (2003), *Nature (London)* **425**, 45.
- Hasegawa, Y., R. Loidl, G. Badurek, M. Baron, and H. Rauch (2006), *Phys. Rev. Lett.* **97**, 230401.
- Hauge, E. H., and J. A. Støvneng (1989), *Rev. Mod. Phys.* **61**, 917.
- Havlicek, H., G. Krenn, J. Summhammer, and K. Svozil (2001), *J. Phys. A* **34**, 3071.
- Heinosaari, T., T. Miyadera, and M. Ziman (2016), *J. Phys. A: Math. Theor.* **49**, 123001.
- Heinosaari, T., and M. M. Wolf (2010), *J. Math. Phys.* **51**, 092201.
- Heinosaari, T., and M. Ziman (2012), *The mathematical language of quantum theory: from uncertainty to entanglement* (Cambridge University Press, Cambridge, New York).
- Heisenberg, W. (1927), *Z. Physik* **43**, 172.
- Henson, J. (2012), arXiv:1210.5978 [quant-ph] .
- Henson, J. (2015), *Phys. Rev. Lett.* **114**, 220403.
- Henson, J., and A. B. Sainz (2015), *Phys. Rev. A* **91**, 042114.
- Hermann, G. (1935), *Abhandlungen der Fries'schen Schule* **6**, 75, reprinted in (Herrmann, 2019).
- Herrmann, K. (2019), *Grete Henry-Herrmann: Philosophie–Mathematik–Quantenmechanik* (Springer).
- Heunen, C., T. Fritz, and M. L. Reyes (2014), *Phys. Rev. A* **89**, 032121.
- Heywood, P., and M. L. G. Redhead (1983), *Found. Phys.* **13**, 481.
- Hindlycke, C., and J.-A. Larsson (2022), *Phys. Rev. Lett.* **129**, 130401.
- Hoban, M. J., E. T. Campbell, K. Loukopoulos, and D. E. Browne (2011), *New J. Phys.* **13**, 023014.
- Hoffmann, J., C. Spee, O. Gühne, and C. Budroni (2018), *New J. Phys.* **20**, 102001.
- Holevo, A. S. (1982), *Probabilistic and Statistical Aspects of Quantum Theory* (North-Holland, Amsterdam).
- Horn, A., and A. Tarski (1948), *Transactions of the American Mathematical Society* **64**, 467.
- Horodecki, K., A. Grudka, P. Joshi, W. Kłobus, and J. Lodyga (2015), *Phys. Rev. A* **92**, 032104.
- Horodecki, K., M. Horodecki, P. Horodecki, R. Horodecki, M. Pawłowski, and M. Bourennane (2010), arXiv:1006.0468 [quant-ph] .
- Howard, M., J. Wallman, V. Veitch, and J. Emerson (2014), *Nature (London)* **510**, 351.
- Huang, Y.-F., C.-F. Li, Y.-S. Zhang, J.-W. Pan, and G.-C. Guo (2003), *Phys. Rev. Lett.* **90**, 250401.
- Jaeger, G. (2019), *Philos. Trans. R. Soc. A* **377**, 20190025.
- Jäger, G., H. Läuchli, B. Scarpellini, and V. Strassen (1990), *Ernst Specker Selecta* (Birkhäuser Verlag Basel).
- Jerger, M., Y. Reshitnyk, M. Oppliger, A. Potočnik, M. Mondal, A. Wallraff, K. Goodenough, S. Wehner, K. Juliusson, N. K. Langford, and A. Fedoro (2016), *Nat. Commun.* **7**, 12930.
- Johansson, N., and J.-Å. Larsson (2017), *Quant. Inf. Process.* **16**, 233.
- Johansson, N., and J.-Å. Larsson (2019), *Entropy* **21**, 800.
- Karvonen, M. (2021), *Phys. Rev. Lett.* **127**, 160402.
- Karvonen, M. (2022), “Private communication.” .
- Kellerer, H. G. (1964a), *Math. Ann.* **153**, 168.
- Kellerer, H. G. (1964b), *Zeitschrift für Wahrscheinlichkeitstheorie und Verwandte Gebiete* **3**, 247.
- Kent, A. (1999), *Phys. Rev. Lett.* **83**, 3755.
- Kernaghan, M. (1994), *J. Phys. A* **27**, L829.
- Kernaghan, M., and A. Peres (1995), *Phys. Lett. A* **198**, 1.
- Kirchmair, G., F. Zähringer, R. Gerritsma, M. Kleinmann, O. Gühne, A. Cabello, R. Blatt, and C. F. Roos (2009), *Nature (London)* **460**, 494.
- Kiukas, J., and R. F. Werner (2010), *J. Math. Phys.* **51**, 072105.
- Kleinmann, M. (2014), *J. Phys. A: Math. Theor.* **47**, 455304.
- Kleinmann, M., C. Budroni, J.-Å. Larsson, O. Gühne, and A. Cabello (2012), *Phys. Rev. Lett.* **109**, 250402.
- Kleinmann, M., O. Gühne, J. R. Portillo, J.-Å. Larsson, and A. Cabello (2011), *New J. Phys.* **13**, 113011.
- Klyachko, A. A. (2007), in *Physics and Theoretical Computer Science: From Numbers and Languages to (Quantum) Cryptography*, edited by J.-P. Gazeau, J. Nešetřil, and B. Rován (IOP Press, London) pp. 25–54.
- Klyachko, A. A., M. A. Can, S. Binicioğlu, and A. S. Shumovsky (2008), *Phys. Rev. Lett.* **101**, 020403.
- Knuth, D. E. (1994), *Electron. J. Comb.* **1**, A1.
- Kochen, S. (1970), “letter to A. Shimony, early in the 1970s, reported in (Stairs, 1983) and in (Heywood and Redhead, 1983),” .
- Kochen, S., and E. P. Specker (1965a), in *Proceedings of the 1964 International Congress for Logic, Methodology and Philosophy of Science, Jerusalem*, edited by Y. Bar-Hillel (North-Holland, Amsterdam) pp. 45–57.
- Kochen, S., and E. P. Specker (1965b), in *Symposium on the Theory of Models: Proceedings of the 1963 International Symposium at Berkeley*, edited by J. W. Addison, L. Henkin, and A. Tarski (North-Holland, Amsterdam)



- pp. 177–189.
- Kochen, S., and E. P. Specker (1967), *J. Math. Mech.* **17**, 59.
- Kofler, J., and Č. Brukner (2013), *Phys. Rev. A* **87**, 052115.
- Kong, X., M. Shi, F. Shi, P. Wang, P. Huang, Q. Zhang, C. Ju, C. Duan, S. Yu, and J. Du (2012), [arXiv:1210.0961 \[quant-ph\]](#).
- Kong, X., M. Shi, M. Wang, F. Shi, P. Wang, F. Kong, P. Huang, Q. Zhang, W. Ma, H. Chen, C. Ju, M. Tian, C. Duan, S. Yu, and J. Du (2016), [arXiv:1602.02455 \[quant-ph\]](#).
- Krips, H. (1987), *The Metaphysics of Quantum Theory* (Clarendon Press, Oxford).
- Krishna, A., R. W. Spekkens, and E. Wolfe (2017), *New J. Phys.* **19**, 123031.
- Kujala, J. V., E. N. Dzhafarov, and J.-Å. Larsson (2015), *Phys. Rev. Lett.* **115**, 150401.
- Kulikov, A., M. Jerger, A. Potočník, A. Wallraff, and A. Fedorov (2017), *Phys. Rev. Lett.* **119**, 240501.
- Kunjwal, R. (2015), *Phys. Rev. A* **91**, 022108.
- Kunjwal, R. (2019), *Quantum* **3**, 184.
- Kunjwal, R. (2020), *Quantum* **4**, 219.
- Kunjwal, R., and S. Ghosh (2014), *Phys. Rev. A* **89**, 042118.
- Kunjwal, R., C. Heunen, and T. Fritz (2014), *Phys. Rev. A* **89**, 052126.
- Kunjwal, R., and R. W. Spekkens (2015), *Phys. Rev. Lett.* **115**, 110403.
- Kunjwal, R., and R. W. Spekkens (2018), *Phys. Rev. A* **97**, 052110.
- Kurzyński, P., R. Ramanathan, and D. Kaszlikowski (2012), *Phys. Rev. Lett.* **109**, 020404.
- La Cour, B. R. (2009), *Phys. Rev. A* **79**, 012102.
- Landauer, R., and T. Martin (1994), *Rev. Mod. Phys.* **66**, 217.
- Lapkiewicz, R., P. Li, C. Schaeff, N. Langford, S. Ramelow, M. Wieśniak, and A. Zeilinger (2011), *Nature (London)* **474**, 490.
- Larsson, J.-Å. (2002), *Europhys. Lett.* **58**, 799.
- Larsson, J.-Å. (2012), *AIP Conf. Proc.* **1424**, 211.
- Larsson, J.-Å. (2014), *J. Phys. A* **47**, 424003.
- Larsson, J.-Å., M. Kleinmann, O. Gühne, and A. Cabello (2011), in *Advances in Quantum Theory (Vaxjö, Sweden, 14–17 June 2010)*, edited by G. Jaeger, A. Y. Khrennikov, M. Schlosshauer, and G. Weihs (American Institute of Physics, New York) pp. 401–409.
- Lauritzen, S. L. (1996), *Graphical models* (Clarendon Press).
- Laversanne-Finot, A., A. Ketterer, M. R. Barros, S. P. Walborn, T. Coudreau, A. Keller, and P. Milman (2017), *J. Phys. A: Math. Gen.* **50**, 155304.
- Leggett, A. J., and A. Garg (1985), *Phys. Rev. Lett.* **54**, 857.
- Leifer, M., and C. Duarte (2020), *Phys. Rev. A* **101**, 062113.
- Leifer, M. S., and O. J. E. Maroney (2013), *Phys. Rev. Lett.* **110**, 120401.
- Leupold, F. M., M. Malinowski, C. Zhang, V. Negnevitsky, A. Cabello, J. Alonso, and J. P. Home (2018), *Phys. Rev. Lett.* **120**, 180401.
- Li, T., Q. Zeng, X. Song, and X. Zhang (2017), *Sci. Rep.* **7**, 44467.
- Liang, Y.-C., R. W. Spekkens, and H. M. Wiseman (2011), *Phys. Rep.* **506**, 1.
- Lisoněk, P., P. Badziąg, J. R. Portillo, and A. Cabello (2014), *Phys. Rev. A* **89**, 042101.
- Liu, B.-H., X.-M. Hu, J.-S. Chen, Y.-F. Huang, Y.-J. Han, C.-F. Li, G.-C. Guo, and A. Cabello (2016), *Phys. Rev. Lett.* **117**, 220402.
- Liu, B. H., Y. F. Huang, Y. X. Gong, F. W. Sun, Y. S. Zhang, C. F. Li, and G. C. Guo (2009), *Phys. Rev. A* **80**, 044101.
- Löhr, W., and N. Ay (2009), in *International Conference on Complex Sciences, Shanghai*, edited by J. Zhou (Springer, New York) pp. 265–276.
- Lorentz, H. A. (1928), *Électrons et Photons—Rapports et Discussions du Cinquième Conseil de Physique tenu à Bruxelles du 24 au 29 Octobre 1927 sous les Auspices de L’Institut International de Physique Solvay* (Gauthier-Villars, Paris).
- Lörwald, S., and G. Reinelt (2015), *EURO J. Comput. Optim.* **3**, 297.
- Lostaglio, M., and G. Senno (2020), *Quantum* **4**, 258.
- Lovász, L. (1979), *IEEE Trans. Inf. Theory* **25**, 1.
- Lovász, L. (2009), *Geometric representations of graphs* (Lecture notes).
- Lovejoy, A. O. (1936), *The Great Chain of Being: A Study of the History of an Idea* (Harvard University Press).
- Ludwig, G. (1964), *Z. Physik* **181**, 233.
- Ludwig, G. (1967), *Commun. Math. Phys.* **4**, 331.
- Ludwig, G. (1968), *Commun. Math. Phys.* **9**, 1.
- Ludwig, G. (1972), *Commun. Math. Phys.* **26**, 78.
- Lund, C., and M. Yannakakis (1994), *J. ACM* **41**, 960.
- Mackey, G. W. (1957), *Am. Math. Mon.* **64**, 45.
- Mackey, G. W. (1963), *Mathematical Foundations of Quantum Mechanics* (Benjamin, New York).
- Malinowski, M., C. Zhang, F. M. Leupold, A. Cabello, J. Alonso, and J. P. Home (2018), *Phys. Rev. A* **98**, 050102.
- Malvestuto, F. M. (1988), *Discrete Math.* **69**, 61.
- Mansfield, S., and E. Kashefi (2018), *Phys. Rev. Lett.* **121**, 230401.
- Mao, Y., C. Spee, Z.-P. Xu, and O. Gühne (2020), [arXiv:2005.13964 \[quant-ph\]](#).
- Mari, A., and J. Eisert (2012), *Phys. Rev. Lett.* **109**, 230503.
- Markiewicz, M., D. Kaszlikowski, P. Kurzyński, and A. Wójcik (2019), *npj Quant. Inf.* **5**, 1.
- Masanes, L., and M. P. Müller (2011), *New J. Phys.* **13**, 063001.
- Matsuno, S. (2007), *J. Phys. A: Math. Theor.* **40**, 9507.
- Matúš, F. (2007a), *Discrete Math.* **307**, 2464.
- Matúš, F. (2007b), in *Information Theory, 2007. ISIT 2007. IEEE International Symposium on* (IEEE) pp. 41–44.
- Mayers, D., and A. Yao (2004), *Quant. Inf. Comput.* **4**, 273.
- Mazurek, M. D., M. F. Pusey, R. Kunjwal, K. J. Resch, and R. W. Spekkens (2016), *Nat. Commun.* **7**, ncomms11780.
- Mealy, G. H. (1955), *Bell Syst. Tech. J.* **34**, 1045.
- Megill, N. D., K. Fresl, M. Waegell, P. K. Aravind, and M. Pavičić (2011), *Phys. Lett. A* **375**, 3419.
- Meon, J. (1990), [pseudonym for E. P. Specker], printed in (Jäger *et al.*, 1990, p. XI).
- Mermin, N. D. (1990a), *Phys. Rev. Lett.* **65**, 1838.
- Mermin, N. D. (1990b), *Phys. Rev. Lett.* **65**, 3373.
- Mermin, N. D. (1993), *Rev. Mod. Phys.* **65**, 803.
- Mermin, N. D. (1999), [arXiv:quant-ph/9912081 \[quant-ph\]](#).
- Mermin, N. D., and R. Schack (2018), *Found. Phys.* **48**, 1007.
- Meyer, D. A. (1999), *Phys. Rev. Lett.* **83**, 3751.
- Michler, M., H. Weinfurter, and M. Żukowski (2000), *Phys. Rev. Lett.* **84**, 5457.
- Moussa, O., C. A. Ryan, D. G. Cory, and R. Laflamme (2010), *Phys. Rev. Lett.* **104**, 160501.
- Navascués, M., Y. Guryanova, M. J. Hoban, and A. Acín (2015), *Nat. Commun.* **6**, 6288.
- Navascués, M., S. Pironio, and A. Acín (2007), *Phys. Rev.*

- Lett. **98**, 010401.
- Navascués, M., S. Pironio, and A. Acín (2008), *New J. Phys.* **10**, 073013.
- Navascués, M., and H. Wunderlich (2010), *Proc. R. Soc. A* **466**, 881.
- von Neumann, J. (1931), *Ann. Math.* **32**, 191.
- von Neumann, J. (1932), *Mathematische Grundlagen der Quantenmechanik* (Springer-Verlag, Berlin).
- Neumark, M. A. (1940a), *Izv. Akad. Nauk SSSR Ser. Mat.* **4**, 53.
- Neumark, M. A. (1940b), *Izv. Akad. Nauk SSSR Ser. Mat.* **4**, 277.
- Neumark, M. A. (1943), *C. R. (Doklady) Acad. Sci. URSS (N.S.)* **41**, 359.
- de Obaldia, E., A. Shimony, and F. Wittel (1988), *Found. Phys.* **18**, 1013.
- Oestereich, A. L., and E. F. Galvão (2017), *Phys. Rev. A* **96**, 062305.
- Okay, C., and R. Raussendorf (2020), *Quantum* **4**, 217.
- Palsson, M. S., M. Gu, J. Ho, H. M. Wiseman, and G. J. Pryde (2017), *Sci. Adv.* **3**, e1601302.
- Pavičić, M. (2006), *Quantum Computation and Quantum Communication: Theory and Experiments* (Springer, New York).
- Pavičić, M., N. D. Megill, P. K. Aravind, and M. Waegell (2011), *J. Math. Phys.* **52**, 022104.
- Pavičić, M., J.-P. Merlet, B. D. McKay, and N. D. Megill (2005), *J. Phys. A* **38**, 1577.
- Pawłowski, M., T. Paterek, D. Kaszlikowski, V. Scarani, A. Winter, and M. Żukowski (2009), *Nature (London)* **461**, 1101.
- Penrose, R. (2000), in *Quantum Reflections*, edited by J. Ellis and D. Amati (Cambridge University Press, Cambridge) pp. 1–27.
- Peres, A. (1990), *Phys. Lett. A* **151**, 107.
- Peres, A. (1991), *J. Phys. A: Math. Gen.* **24**, L175.
- Peres, A. (1992), *Found. Phys.* **22**, 357.
- Peres, A. (1993), *Quantum Theory: Concepts and Methods* (Kluwer, Dordrecht).
- Peres, A. (2003), [arXiv:quant-ph/0310035 \[quant-ph\]](https://arxiv.org/abs/quant-ph/0310035).
- Peres, A., and A. Ron (1988), in *Microphysical Reality and Quantum Formalism*, Vol. 2, edited by A. van der Merwe, F. Selleri, and G. Tarozzi (Kluwer, Dordrecht) pp. 115–123.
- Piron, C. (1964), *Helv. Phys. Acta* **37**, 439.
- Piron, C. (1976), *Foundations of Quantum Mechanics* (W. A. Benjamin Inc., Reading, Massachusetts).
- Pitowsky, I. (1985), *Philosophy of Science* **52**, 154.
- Pitowsky, I. (1986), *J. Math. Phys.* **27**, 1556.
- Pitowsky, I. (1989), *Quantum Probability-Quantum Logic*, Lecture Notes in Physics, Vol. 321 (Springer-Verlag, Berlin).
- Pitowsky, I. (1991), *Math. Program.* **50**, 395.
- Pitowsky, I. (1994), *Br. J. Philos. Sci.* **45**, 95.
- Planat, M. (2012), *Eur. Phys. J. Plus* **127**, 86.
- Planat, M. (2013), in *Symmetries and Groups in Contemporary Physics*, edited by C. Bai, J.-P. Gazeau, and M.-L. Ge (World Scientific, Singapore) p. 295.
- Plastino, A. R., and A. Cabello (2010), *Phys. Rev. A* **82**, 022114.
- Popescu, S., and D. Rohrlich (1994), *Found. Phys.* **24**, 379.
- Pusey, M. F. (2018), *Phys. Rev. A* **98**, 022112.
- Qu, D., P. Kurzyński, D. Kaszlikowski, S. Raesi, L. Xiao, K. Wang, X. Zhan, and P. Xue (2020), *Phys. Rev. A* **101**, 060101.
- Rabelo, R., C. Duarte, A. J. López-Tarrida, M. Terra Cunha, and A. Cabello (2014), *J. Phys. A: Math. Theor.* **47**, 424021.
- Rabiner, L. R. (1989), *Proc. IEEE* **77**, 257.
- Raesi, S., P. Kurzyński, and D. Kaszlikowski (2015), *Phys. Rev. Lett.* **114**, 200401.
- Ramanathan, R., and P. Horodecki (2014), *Phys. Rev. Lett.* **112**, 040404.
- Ramanathan, R., A. Soeda, P. Kurzyński, and D. Kaszlikowski (2012), *Phys. Rev. Lett.* **109**, 050404.
- Randall, C. H., and D. J. Foulis (1970), *Am. Math. Mon.* **77**, 363.
- Randall, C. H., and D. J. Foulis (1973), *J. Math. Phys.* **14**, 1472.
- Raussendorf, R. (2013), *Phys. Rev. A* **88**, 022322.
- Raussendorf, R. (2019), *Quantum Inf. Comput.* **19**, 1141.
- Raussendorf, R., and H. J. Briegel (2001), *Phys. Rev. Lett.* **86**, 5188.
- Raussendorf, R., D. E. Browne, N. Delfosse, C. Okay, and J. Bermejo-Vega (2017), *Phys. Rev. A* **95**, 052334.
- Ray, M., N. G. Boddu, K. Bharti, L.-C. Kwek, and A. Cabello (2021), *New J. Phys.* **23**, 033006.
- Redhead, M. L. G. (1987), *Incompleteness, Nonlocality, and Realism* (Oxford University Press, New York).
- Renner, R., and S. Wolf (2004), in *International Symposium on Information Theory, 2004. ISIT 2004. Proceedings.* (IEEE) pp. 322–322.
- Ruuge, A. E. (2007), *J. Phys. A: Math. Theor.* **40**, 2849.
- Ruuge, A. E. (2012), *J. Phys. A: Math. Theor.* **45**, 465304.
- Sadiq, M., P. Badziag, M. Bourennane, and A. Cabello (2013), *Phys. Rev. A* **87**, 012128.
- Saha, D., and A. Chaturvedi (2019), *Phys. Rev. A* **100**, 022108.
- Saha, D., P. Horodecki, and M. Pawłowski (2019), *New J. Phys.* **21**, 093057.
- Saniga, M., and M. Planat (2012), *Quant. Inf. Comput.* **12**, 1011.
- Schaller, M., and K. Svozil (1996), *Int. J. Theor. Phys.* **35**, 911.
- Schmid, D., J. Selby, and R. W. Spekkens (2020a), [arXiv:2009.03297 \[quant-ph\]](https://arxiv.org/abs/2009.03297).
- Schmid, D., J. H. Selby, M. F. Pusey, and R. W. Spekkens (2020b), [arXiv:2005.07161 \[quant-ph\]](https://arxiv.org/abs/2005.07161).
- Schmid, D., J. H. Selby, E. Wolfe, R. Kunjwal, and R. W. Spekkens (2021), *PRX Quantum* **2**, 010331.
- Schmid, D., and R. W. Spekkens (2018), *Phys. Rev. X* **8**, 011015.
- Schmid, D., R. W. Spekkens, and E. Wolfe (2018), *Phys. Rev. A* **97**, 062103.
- Schrödinger, E. (1935), *Proc. Cambridge Phil. Soc.* **31**, 555.
- Seevinck, M. P. (2011), [arXiv:1103.4537 \[physics.hist-ph\]](https://arxiv.org/abs/1103.4537).
- Selby, J. H., D. Schmid, E. Wolfe, A. B. Sainz, R. Kunjwal, and R. W. Spekkens (2021), [arXiv:2106.09045 \[quant-ph\]](https://arxiv.org/abs/2106.09045).
- Shannon, C. (1956), *IRE Trans. Inf. Theory* **2** (3), 8.
- Shimony, A. (1971), in *Foundations of Quantum Mechanics: Proceedings of the International School of Physics “Enrico Fermi”, Course IL, Varenna on Lake Como, Villa Monastero, 29th June–11th July 1970*, edited by B. D’Espagnat (Academic Press, New York) pp. 182–194.
- Shimony, A. (2009), in *Compendium of Quantum Physics: Concepts, Experiments, History and Philosophy*, edited by D. Greenberger, K. Hentschel, and F. Weinert (Springer-Verlag, Berlin) pp. 287–291.

- Simon, C., Č. Brukner, and A. Zeilinger (2001), *Phys. Rev. Lett.* **86**, 4427.
- Soares Barbosa, R. (2014), *EPTCS* **172**, 36.
- Soares Barbosa, R. (2015), *Contextuality in quantum mechanics and beyond*, Ph.D. thesis (University of Oxford).
- Soares Barbosa, R., T. Douce, P.-E. Emeriau, E. Kashefi, and S. Mansfield (2019), [arXiv:1905.08267 \[quant-ph\]](https://arxiv.org/abs/1905.08267).
- Soares Barbosa, R., M. Karvonen, and S. Mansfield (2021), [arXiv:2104.11241 \[quant-ph\]](https://arxiv.org/abs/2104.11241).
- Specker, E. (1960), *Dialectica* **14**, 239.
- Specker, E. (1999), “Private communication to Karl Svozil, mentioned in (Abbott *et al.*, 2012).”
- Spee, C., C. Budroni, and O. Gühne (2020), *New J. Phys.* **22**, 103037.
- Spekkens, R. W. (2005), *Phys. Rev. A* **71**, 052108.
- Spekkens, R. W. (2007), *Phys. Rev. A* **75**, 032110.
- Spekkens, R. W. (2014), *Found. Phys.* **44**, 1125.
- Spekkens, R. W. (2019), [arXiv:1909.04628 \[physics.hist-ph\]](https://arxiv.org/abs/1909.04628).
- Spekkens, R. W., D. H. Buzacott, A. J. Keehn, B. Toner, and G. J. Pryde (2009), *Phys. Rev. Lett.* **102**, 010401.
- Stairs, A. (1978), *Quantum Mechanics, Logic and Reality*, Ph.D. thesis (University of Western Ontario, London, Ontario).
- Stairs, A. (1983), *Philos. Sci.* **50**, 578.
- Stomphorst, R. G. (2002), *Phys. Lett. A* **292**, 213.
- Suppes, P., and M. Zanotti (1981), *Synthese* **48**, 191.
- Svozil, K. (2006), *Am. J. Phys.* **74**, 800.
- Svozil, K. (2010), in *Physics and Computation 2010*, edited by H. Guerra (University of Azores, Ponta Delgada, Portugal) pp. 235–249.
- Szangolies, J. (2015), *Testing Quantum Contextuality: The Problem of Compatibility* (Springer Spektrum, Wiesbaden).
- Szangolies, J., M. Kleinmann, and O. Gühne (2013), *Phys. Rev. A* **87**, 050101.
- Tavakoli, A., E. Z. Cruzeiro, R. Uola, and A. A. Abbott (2021), *PRX Quantum* **2**, 020334.
- Tavakoli, A., and R. Uola (2020), *Phys. Rev. Research* **2**, 013011.
- Toh, S. P. (2013a), *Chin. Phys. Lett.* **30**, 100302.
- Toh, S. P. (2013b), *Chin. Phys. Lett.* **30**, 100303.
- Toner, B. F., and D. Bacon (2003), *Phys. Rev. Lett.* **91**, 187904.
- Trandafir, S., P. Lisoněk, and A. Cabello (2022), *Phys. Rev. Lett.* **129**, 200401.
- Tsirelson, B. S. (1993), *Hadron. J. Suppl.* **8**, 329.
- Um, M., X. Zhang, J. Zhang, Y. Wang, Y. Shen, D.-L. Deng, L.-M. Duan, and K. Kim (2013), *Sci. Rep.* **3**, 1627.
- Um, M., Q. Zhao, J. Zhang, P. Wang, Y. Wang, M. Qiao, H. Zhou, X. Ma, and K. Kim (2020), *Phys. Rev. Appl.* **13**, 034077.
- Uola, R., A. C. S. Costa, H. C. Nguyen, and O. Gühne (2020), *Rev. Mod. Phys.* **92**, 015001.
- Uola, R., G. Vitagliano, and C. Budroni (2019), *Phys. Rev. A* **100**, 042117.
- Veitch, V., C. Ferrie, D. Gross, and J. Emerson (2012), *New J. Phys.* **14**, 113011.
- Veitch, V., S. A. H. Mousavian, D. Gottesman, and J. Emerson (2014), *New J. Phys.* **16**, 013009.
- Vieira, L. B., and C. Budroni (2022), *Quantum* **6**, 623.
- Vorob’ev, N. (1962), *Theory Probab. Appl.* **7**, 147.
- Vorob’ev, N. (1963), *Theory Probab. Appl.* **8**, 420.
- Vorob’ev, N. N. (1959), *Dokl. Akad. Nauk SSSR* **124**, 253.
- Vorob’yev, N. N. (1967), *Theory Probab. Appl.* **12**, 251.
- Vourdas, A. (2004), *Rep. Prog. Phys.* **67**, 267.
- Waegell, M. (2014), *Phys. Rev. A* **89**, 012321.
- Waegell, M., and P. K. Aravind (2010), *J. Phys. A* **43**, 105304.
- Waegell, M., and P. K. Aravind (2011a), *J. Phys. A* **44**, 505303.
- Waegell, M., and P. K. Aravind (2011b), *Found. Phys.* **41**, 1786.
- Waegell, M., and P. K. Aravind (2012), *J. Phys. A: Math. Theor.* **45**, 405301.
- Waegell, M., and P. K. Aravind (2013a), *Phys. Lett. A* **377**, 546.
- Waegell, M., and P. K. Aravind (2013b), *Phys. Rev. A* **88**, 012102.
- Waegell, M., and P. K. Aravind (2015), *J. Phys. A: Math. Theor.* **48**, 225301.
- Waegell, M., and P. K. Aravind (2017), *Phys. Rev. A* **95**, 050101.
- Waegell, M., P. K. Aravind, N. D. Megill, and M. Pavičić (2011), *Found. Phys.* **41**, 883.
- Wang, P., J. Zhang, C.-Y. Luan, M. Um, Y. Wang, M. Qiao, T. Xie, J.-N. Zhang, A. Cabello, and K. Kim (2022), *Sci. Adv.* **8** (6), eabk1660.
- Wigner, E. (1932), *Phys. Rev.* **40**, 749.
- Wilde, M. M., and A. Mizel (2012), *Found. Phys.* **42**, 256.
- Winter, A. (2014), *J. Phys. A: Math. Theor.* **47**, 424031.
- Wiseman, H. M., S. J. Jones, and A. C. Doherty (2007), *Phys. Rev. Lett.* **98**, 140402.
- Wright, R. (1978), in *Mathematical Foundations of Quantum Theory*, edited by A. R. Marlow, Chap. The state of the pentagon. A nonclassical example (Academic Press, New York) pp. 255–274.
- Xu, Z.-P., and A. Cabello (2017), *Phys. Rev. A* **96**, 012122.
- Xu, Z.-P., and A. Cabello (2019), *Phys. Rev. A* **99**, 020103.
- Xu, Z.-P., J.-L. Chen, and O. Gühne (2020), *Phys. Rev. Lett.* **124**, 230401.
- Xu, Z.-P., J.-L. Chen, and H.-Y. Su (2015), *Phys. Lett. A* **379**, 1868.
- Xu, Z.-P., D. Saha, H.-Y. Su, M. Pawłowski, and J.-L. Chen (2016), *Phys. Rev. A* **94**, 062103.
- Xu, Z.-P., X.-D. Yu, and M. Kleinmann (2021), *New J. Phys.* **23** (4), 043025.
- Yan, B. (2013), *Phys. Rev. Lett.* **110**, 260406.
- Yang, T., Q. Zhang, J. Zhang, J. Yin, Z. Zhao, M. Żukowski, Z.-B. Chen, and J.-W. Pan (2005), *Phys. Rev. Lett.* **95**, 240406.
- Yeung, R. W. (2008), *Information theory and network coding*, Information technology–transmission, processing, and storage (Springer).
- Yu, S., and C. H. Oh (2012), *Phys. Rev. Lett.* **108**, 030402.
- Yu, X.-D., Y.-Q. Guo, and D. M. Tong (2015), *New J. Phys.* **17**, 093001.
- Yu, X.-D., and D. M. Tong (2014), *Phys. Rev. A* **89**, 010101.
- Zhan, X., E. G. Cavalcanti, J. Li, Z. Bian, Y. Zhang, H. M. Wiseman, and P. Xue (2017), *Optica* **4**, 966.
- Zhang, A., H. Xu, J. Xie, H. Zhang, B. J. Smith, M. S. Kim, and L. Zhang (2019), *Phys. Rev. Lett.* **122**, 080401.
- Zhang, X., M. Um, J. Zhang, S. An, Y. Wang, D.-l. Deng, C. Shen, L.-M. Duan, and K. Kim (2013), *Phys. Rev. Lett.* **110**, 070401.
- Zhang, Z. (2003), *Commun. Inf. Syst.* **3**, 47.
- Zimba, J. R., and R. Penrose (1993), *Stud. Hist. Philos. Sci. A* **24**, 697.
- Zu, C., Y.-X. Wang, D.-L. Deng, X.-Y. Chang, K. Liu, P.-Y.

- Hou, H.-X. Yang, and L.-M. Duan (2012), *Phys. Rev. Lett.* **109**, 150401.
- Zu, C., Y.-X. Wang, D.-L. Deng, X.-Y. Chang, K. Liu, P.-Y. Hou, H.-X. Yang, and L.-M. Duan (2013), *Phys. Rev. Lett.* **110**, 078902.
- Zurel, M., C. Okay, and R. Raussendorf (2020), *Phys. Rev. Lett.* **125**, 260404.