

Hemlock : Compact and Scalable Mutual Exclusion

Dave Dice 
 dave.dice@oracle.com
 Oracle Labs
 USA

Alex Kogan 
 alex.kogan@oracle.com
 Oracle Labs
 USA

ABSTRACT

We present **Hemlock**, a novel mutual exclusion locking algorithm that is extremely compact, requiring just one word per thread plus one word per lock, but which still provides *local spinning* in most circumstances, high throughput under contention, and low latency in the uncontended case. Hemlock is *context-free* – not requiring any information to be passed from a lock operation to the corresponding unlock – and FIFO. The performance of Hemlock is competitive with and often better than the best scalable spin locks.

CCS CONCEPTS

• **Software and its engineering** → *Multithreading; Mutual exclusion; Concurrency control; Process synchronization.*

KEYWORDS

Synchronization; Locks; Mutual Exclusion; Scalability

1 INTRODUCTION

Locks often have a crucial impact on the performance of parallel software, hence they remain in the focus of intensive research. Many locking algorithms have been proposed over the last several decades. Ticket Locks [28, 42, 49] are simple and compact, requiring just two words for each lock instance and no per-thread data. They perform well in the absence of contention, exhibiting low latency because of short code paths. Under contention, however, performance suffers [19] because all threads contending for a given lock will busy-wait on a central location, increasing coherence costs. For contended operation, so-called *queue based* locks, such as CLH[13, 40] and MCS[43] provide relief via *local spinning* [23]. For both CLH and MCS, arriving threads enqueue an element (sometimes called a “node”) onto the tail of a queue and then busy-wait on a flag in either their own element (MCS) or the predecessor’s element (CLH). Critically, at most one thread busy-waits on a given location at any one time, increasing the rate at which ownership can be transferred from thread to thread relative to techniques that use global spinning, such as Ticket Locks.

Hemlock is inspired by CLH, and, like CLH, threads wait on a field associated with the predecessor. Hemlock, however, avoids the use of queue nodes, freeing the implementation from lifecycle concerns – allocating, releasing, caching – associated with that structure. The lock and unlock execution paths are extremely simple. An uncontended lock operation requires just an atomic SWAP (exchange) operation, and unlock just a compare-and-swap (CAS), which is the same as MCS. Like Ticket Locks, MCS and CLH locks, Hemlock provides FIFO admission.

Hemlock is compact, requiring just one word per extant lock plus one word per thread, regardless of the number of locks held

or waited upon. Like MCS and CLH, the lock contains a pointer to the tail of the queue of threads waiting on that lock, or null if the lock is not held. The thread at the head of the queue is the owner. In MCS the queue is implemented as an explicit linked list running from the head (owner) to the tail. In CLH the queue is implicit and each thread waits on a field in its predecessor’s element. CLH also requires that a lock in unlocked state be provisioned with an empty queue element. When that lock is destroyed, the element must be recovered. Hemlock avoids that requirement.

Instead of using queue nodes, Hemlock provisions each thread with a singular Grant field where any immediate successor can busy-wait. Normally the Grant field – which acts as a mailbox between a thread and its immediate successor on the queue – is null, indicating empty. During an unlock operation, where there are threads queued behind the owner, the outgoing owner installs the address of the lock into its Grant field and then waits for that field to return to null. The successor thread observes the lock address appear in its predecessor’s Grant field, which indicates that ownership has transferred. The successor then responds by clearing the Grant field, acknowledging receipt of ownership and allowing the Grant field of its predecessor to be reused in subsequent handover operations, and then finally enters the critical section.

Under simple contention, when a thread holds at most one contended lock at a time, Hemlock provides local spinning. But if we have one thread T_1 that holds multiple contended locks, the immediate successors for each of the queues will busy-wait on T_1 ’s Grant field. As multiple threads (via multiple locks) can be busy-waiting on T_1 ’s Grant field, T_1 writes the address of the lock being released into its own Grant field to disambiguate and allow the specific successor to determine that ownership has been conveyed. We note that simple contention is a common case for many applications. This is supported by the surveys of Cheng et al. [6] and O’Callahan et al. [46] – which found that it is rare for a thread to hold multiple locks at a given time – as well as by our profiling of LevelDB, described below. This suggests that Hemlock would enjoy local spinning in many practical settings.

The advantages of avoiding queue nodes, however, does not end in reduced space and a simplified implementation that avoids node lifecycle concerns. Both CLH and MCS need to convey the address of the owner (head) node from the lock operation to the unlock operation. The unlock operation needs that node to find the successor, and to reclaim nodes from the queue so that nodes may be recycled. While the locking API could be modified to accommodate this requirement, it is inconvenient for the classic POSIX pthread locking interface, in which case the usual approach to support MCS is to add a field to the lock body that points to the head, allowing that value to be passed from the lock operation to the corresponding unlock operation. This new field is protected by the lock itself, but accesses to the field execute within the effective critical section and

This is an extended version of [22]

```

1 class Thread :
2   atomic<Lock *> Grant = null

3 class Lock :
4   atomic<Thread *> Tail = null

5 def Lock (Lock * L) :
6   assert Self→Grant == null
7   ## Enqueue self at tail of implicit queue
8   auto pred = swap (&L→Tail, Self)
9   if pred ≠ null :
10    ## Contention : must wait
11    while pred→Grant ≠ L : Pause
12    pred→Grant = null
13    assert L→Tail ≠ null

14 def Unlock (Lock * L) :
15   assert Self→Grant == null
16   auto v = cas (&L→Tail, Self, null)
17   assert v ≠ null
18   if v ≠ Self :
19     ## one or more waiters exist -- convey ownership to successor
20     Self→Grant = L
21   while Self→Grant ≠ null : Pause

```

Listing 1: Simplified Pseudo-code for Hemlock

may also induce additional coherence traffic. Instead of an extra field in the lock body to convey the head – the owner’s element – from the lock operation to the corresponding unlock, implementations may also opt to use a per-thread associative map that relates the lock address to the owner’s element. A lock algorithm or interface that does not need to pass information from the lock operator to unlock is said to be *context-free* [52]. Hemlock is context-free and does not require the head pointer in the unlock operation, simplifying the implementation.

2 THE HEMLOCK ALGORITHM

We start by describing a simplified version of the Hemlock algorithm, with pseudo-code provided in Listing-1. In Section 2.1 we describe a key performance optimization, and the pseudo-code for that optimized Hemlock algorithm is given in Listing-2.

Self refers to a thread-local structure containing the thread’s Grant field. Threads arrive in the lock operator at line 8 and atomically swap their own address into the lock’s Tail field, obtaining the previous tail value, constructing the implicit FIFO queue. If the Tail field was null, then the caller acquired the lock without contention and may immediately enter the critical section. Otherwise the thread waits for the lock’s address to appear in the predecessor’s Grant field, signalling succession, at which point the thread restores the predecessor’s Grant field to null (empty) indicating the field can be reused for subsequent unlock operations by the predecessor. The thread has been granted ownership by its predecessor and may enter the critical section. Clearing the Grant field, above, is the only circumstance in which one thread may store into another thread’s Grant field. Threads in the queue hold the address of their immediate predecessor, obtained as the return value from the SWAP operation, but do not know the identity of their successor, if any.

In the unlock operator, at line 16, threads initially use an atomic compare-and-swap (CAS) operation to try to swap the lock’s Tail field from the address of their own thread, Self, back to null, which

```

1 class Thread :
2   atomic<Lock *> Grant = null

3 class Lock :
4   atomic<Thread *> Tail = null

5 def Lock (Lock * L) :
6   assert Self→Grant == null
7   auto pred = swap (&L→Tail, Self)
8   if pred ≠ null :
9     while cas(&pred→Grant, L, null) ≠ L : Pause

10 def Unlock (Lock * L) :
11   assert Self→Grant == null
12   auto v = cas (&L→Tail, Self, null)
13   if v ≠ Self :
14     Self→Grant = L
15     while FetchAdd(&Self→Grant, 0) ≠ null : Pause

```

Listing 2: Hemlock with CTR Optimization

represents *unlocked*. If the CAS was successful then there were no waiting threads and the lock was released by the CAS. Otherwise waiters exist and the thread then writes the *address* of the lock *L* into its own Grant, alerting the waiting successor and passing ownership. Finally, the outgoing thread waits for that successor to acknowledge the transfer and restore the Grant field back to empty, indicating the field be reused for future locking operations. Waiting for the mailbox to return to null happens outside the critical section, after the thread has conveyed ownership.

In Hemlock, transfer of ownership in unlock is **address-based**, where the outgoing owner writes the lock address into its own grant field, whereas under MCS and CLH owner transfer is via a boolean written into a queue element monitored by its immediate successor.

Threads that attempt to release a lock that they do not hold will stall indefinitely at Line 21, waiting for an acknowledgement that will never arrive. This property makes it easy to identify and debug the offending thread and unlock operation.

The assert statements in the listings are not necessary for correct operation, but serve to document invariants that may be useful in understanding the algorithm.

MCS and Hemlock allow trivial implementations of the TryLock operations – using CAS instead of SWAP – whereas Ticket Locks and CLH do not. An uncontended lock acquisition requires an atomic SWAP for MCS, CLH and Hemlock and an atomic fetch-and-add for Ticket Locks. An uncontended unlock – no waiters – requires an atomic CAS for MCS and Hemlock, and simple stores for CLH and Ticket Locks while a contended unlock, which passes ownership to a waiter, requires a store for MCS, CLH and Ticket Locks.

In Listing-1 line 21, threads in the unlock operator must wait for the successor to acknowledge receipt of ownership, indicating the unlocking thread’s Grant mailbox is again available for communication in subsequent locking operations. That is, the recipient needs to take positive action and respond before the previous owner can return from the unlock operator. While this phase of waiting

occurs outside and after the transfer of ownership – crucially, *not* within the effective critical section or on critical path– such waiting may still impede the progress and latency of the thread that invoked unlock. Specifically, we have tightly coupled back-and-forth synchronous communication, where the thread executing unlock stores into its Grant field and then waits for a response from the successor, while the successor, running in the lock operator, waits for the transfer indication (line 11) and then responds to the unlocking thread and acknowledges by restoring Grant to null (line 12). The unlock operator must await a positive reply from the successor in order to safely reuse the Grant field for subsequent operations. That is, the algorithm must not start an unlock operation until the previous contended unlock has completed, and the successor has emptied the mailbox. We note that MCS, in the unlock operator, must also wait for the successor executing in the lock operator to establish the back-link that allows the owner to reach the successor. That is, both MCS and Hemlock have wait loops in the contended unlock path where threads may need to wait for the arriving successor to become visible to the current owner, and as such, neither unlock operator is wait-free. Compared to MCS and CLH, the only additional burden imposed by Hemlock that falls inside the critical path is the clearing of the predecessor’s Grant field by the recipient (Line 12), which is implemented as a single store.

To mitigate the performance concern described above, we could optimize Hemlock to defer and shift the waiting-for-response phase (Listing-1 line 21) to the prologue of subsequent lock and unlock operations, allowing more useful overlap and concurrency between the successor, which clears the Grant field, and the thread which performed the unlock operation. The thread that called unlock may enter its critical section earlier, before the successor clears Grant. Ultimately, however, we opted to forgo this particular optimization in our implementation as it provided little observable performance benefit. While the Grant mailbox field might appear to be a source of contention and to potentially induce additional coherence traffic, a given thread can release only one lock at a time, mitigating that concern.

2.1 Optimization: Coherence Traffic Reduction

The synchronous back-and-forth communication pattern where a thread waits for ownership and then clears the Grant field (Listing-1 Lines 11-12) is inefficient on platforms that use MESI or MESIF “single writer” cache coherence protocols [30, 31]. Specifically, in unlock when the owner stores the lock address into its Grant field (Line 20), it drives the cache line underlying Grant into *M*-state (modified) in its local cache. Subsequent polling by the successor (Line 11) results in a *coherence miss* that will pull the line back into the successor’s cache in *S*-state (shared). The successor will then observe the waited-for lock address and proceed to clear Grant (Line 12) forcing an upgrade from *S* to *M* state in the successor’s cache and invalidating the line from the cache of the previous owner, adding a delay in the critical path where ownership is conveyed to the successor.

We avoid the upgrade coherence transaction by polling with CAS (Listing-2 Line 9) instead of using simple loads, so, once the hand-over is accomplished and the successor observes the lock address, the line is already in *M*-state in the successor’s local cache.

We refer to this technique as the *Coherence Traffic Reduction (CTR)* optimization.

As an alternative to busy-waiting with CAS, we can achieve equivalent performance by using an atomic fetch-and-add of 0 – implemented via LOCK:XADD on x86 – on Grant as a *read-with-intent-to-write* primitive, and, after observing the waited-for lock address to appear in Grant, issuing a normal store to clear Grant. That is, we simply replace the load instruction in the traditional busy-wait loop with fetch-and-add of 0. Busy-waiting with an atomic read-modify-write operator, such as CAS, SWAP or fetch-and-add, is typically considered a performance anti-pattern. For instance, Anderson[5] observed that test-and-test-and-set locks are superior to crude test-and-set locks when there are multiple waiters. But in our case with the 1-to-1 communication protocol used on the Grant field in Hemlock, busy-waiting via read-modify-write atomic operations provides a performance benefit. Because of the simple communication pattern, back-off in the busy-waiting loop is not useful.

We also apply CTR in the unlock operator at Listing-2 Line 15 as we expect the Grant field will be written by that same thread in subsequent unlock operations.

Related approaches to coherence-optimized waiting have been described [24]. Using MONITOR-MWAIT[2] to wait for invalidation, instead of waiting for a value, has promise, but the facility is not yet available in user-mode on Intel processors¹. MWAIT may confer additional benefits, as it avoids a classic busy-wait loop and thus avoids branch mispredictions in the critical path to exit the loop when ownership has transferred [25]. In addition, depending on the implementation, MWAIT may be more “polite” with respect to yielding pipeline resources, potentially allowing other threads, including the lock owner, to execute faster by reducing competition for shared resources. We might also busy-wait via hardware transactional memory, where invalidation of lines in a processor’s read-set or write-set will cause an abort, serving as a hint to the waiting thread. In addition, other techniques to hold the line in *M*-state are possible, such as issuing stores to a dummy variable that abuts the Grant field but which resides on the same cache line. Using the prefetchw prefetch-for-write advisory “hint” instruction would appear workable but yielded no performance improvement in our experiments².

The CTR optimization is specific to the shared memory communication pattern used in Hemlock, and is not directly applicable to other lock algorithms.

All Hemlock performance data reported herein uses the CTR optimization unless otherwise noted. We note that the relative benefit of CTR is retained on single-socket non-NUMA Intel systems.

In Section 5.5 we show the impact of the CTR optimization on coherence traffic.

2.2 Example Configuration

Figure-1 shows an example configuration of a set of threads and locks in Hemlock. *L1 – L7* depict locks while *A – N* represent

¹Future Intel processors may support user-mode `umonitor` and `umwait` instructions [10]. We hope to use those instructions in future Hemlock experiments

²We plan on experimenting with non-temporal stores and new `CLDEMOTE` instruction, with the intention that the writer can immediately expunge the written-to-line from its cache, avoiding subsequent coherence traffic when the reader loads that line.

threads. Solid arrows reflect the lock’s explicit Tail pointer, which points to the most recently arrived thread – the tail of the lock’s queue. Dashed arrows, which appear between threads, refer to a thread’s immediate predecessor in the implicit queue associated with a lock. The address of the immediate predecessor is obtained via the atomic SWAP executed when threads arrive. The dashed edge can be thought of as the *busy-waits-on* relation and are not physical links in memory that could be traversed. In the example, A holds L1, B holds L2 and L3 while E holds L4, L5 and L7. K holds L6 but also waits to acquire L5. A, B and E execute in their critical sections, while all the other threads are stalled waiting for locks. The queue of waiting threads for L2 is C (the immediate successor) followed by D. D’s predecessor is C, and, equivalently, C’s successor is D. Thread D busy-waits on C’s Grant field and C busy-waits on B’s Grant field.

Threads H and J both busy-wait on G’s Grant field. In simple locking scenarios Hemlock provides local waiting, but when the dashed lines form junctions (elements with in-degree greater than one) in the waits-on directed graph, we find non-local spinning, or *multi-waiting*. Similarly, in our contrived example, N and G both wait on F. While our design admits inter-lock performance interference, arising from multiple threads spinning on one Grant variable, as is the case for G and F, above, we believe this case to be rare and not of consequence for common applications. (For comparison, CLH and MCS does not allow the concurrent sharing of queue elements, and thus provides local spinning, whereas Hemlock has a shared singleton queue element – effectively the Grant field – that can be subject to being busy-waited upon by multiple threads). Crucially, if we have a set of coordinating threads where each thread acquires only one lock at a time, then they will enjoy local spinning. Non-local spinning can occur only when threads hold multiple locks. Specifically, the worst-case number of threads that could be busy-waiting on a given thread T ’s Grant field is M where M is the number of locks held simultaneously by T . We note that common usage patterns such as hand-over-hand “coupled” locking do not result in multi-waiting.

When E ultimately unlocks L4, E installs a pointer to L4 into its Grant field. Thread F observes that store, assumes ownership, clears E’s Grant field back to empty (null) and enters the critical section. When F then unlocks L4, it deposits L4’s address into its own Grant field. Threads G and N both monitor F’s Grant field, with G waiting for L4 to appear and N waiting for L7 to appear. Both threads observe the update of F’s Grant field, but N ignores the change while G notices the value now matches L4, the lock that G is waiting on, which indicates that E has passed ownership of L4 to G. G clears F’s Grant field, indicating that F can reuse that field for subsequent operations, and enters the critical section.

We note that holding multiple locks does not itself impose a performance penalty, while holding multiple locks when contention (and waiting) is involved will result in reduced local spinning and a consequent reduction in performance because of increased lock handover latency.

2.3 Space Requirements

Table-1 characterizes the space utilization of MCS, CLH, Ticket Locks, and Hemlock. The values in the *Lock* column reflect the

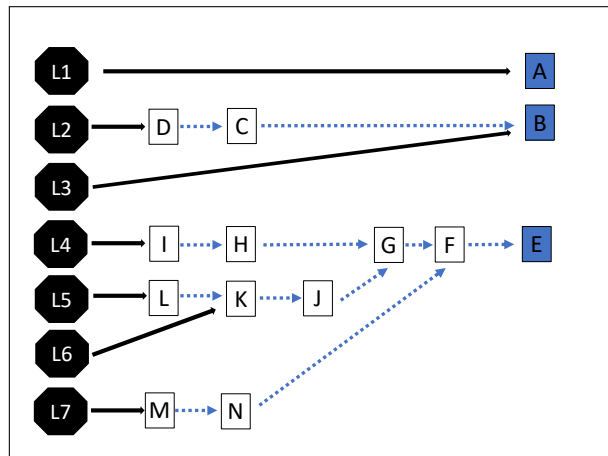

Figure 1: Object Graph in Hemlock

| | Space | | | | |
|--------------|-------|------|------|--------|------|
| | Lock | Held | Wait | Thread | Init |
| MCS | 2 | E | E | 0 | |
| CLH | $2+E$ | 0 | E | 0 | • |
| Ticket Locks | 2 | 0 | 0 | 0 | |
| Hemlock | 1 | 0 | 0 | 1 | |

Table 1: Space Usage

size of the lock body in words. For MCS and CLH we assume that the implementation stores the head of the chain – reflecting the current owner – in an additional field in the lock body, and thus the lock consists of head and tail fields, requiring 2 words in total. E represents the size of a queue element. CLH requires the lock to be preinitialized with a so-called *dummy* element before use. When the lock is ultimately destroyed, the current dummy element must be recovered. The *Held* field indicates the space cost for each held lock and similarly, the *Wait* field indicates the cost in space of waiting for a lock. The *Thread* column reflects per-thread state that must be reserved for locking. For Hemlock, this is the Grant field. A single word suffices, although to avoid false sharing we opted to sequester the Grant field as the sole occupant of a cache line. In our implementation we also elected to align and pad the MCS and CLH queue nodes to reduce false sharing and to provide a fair comparison, raising the size of E to a cache line. *Init* indicates if the lock requires non-trivial constructors and destructors. CLH, for instance, requires that the current dummy node be released when a lock is destroyed.

Taking MCS as an example, lets say lock L is owned by thread $T1$ while threads $T2$ and $T3$ wait to acquire L . The lock body for L requires 2 words and the MCS chain consists of elements $E1 \Rightarrow E2 \Rightarrow E3$ where $E1$, $E2$ and $E3$ are associated with and enqueued by $T1$, $T2$ and $T3$ respectively. L ’s head field points to $E1$, the owner, and the tail field points to $E3$. The space consumed in this configuration is 2 words for L itself plus $3 * E$ for the queue elements. In

comparison, Hemlock consumes one word for L and 3 words of thread-local state for the Grant fields.

In MCS, when a thread acquires a lock, it contributes an element to the associated queue, and when that element reaches the head of the queue, the thread becomes the owner. In the subsequent `unlock` operation, the thread extracts and reclaims that same element from the queue. In CLH, a thread contributes an element but, and once it has acquired the lock, recovers a different element from the queue – elements *migrate* between locks and threads. The MCS and CLH `unlock` operators require dependent loads and indirection to locate queue nodes, while Hemlock avoids these overheads. In MCS, if the `unlock` operation is known to execute in the same stack frame as the lock operation, the queue element may be allocated on stack. This is not the case for CLH. As previously noted, Hemlock avoids elements and their management.

The K42 [39, 50] variation of MCS can recover the queue element before returning from `lock` whereas classic MCS recovers the queue element in `unlock`. That is, under K42, a queue element is needed only while waiting but not while the lock is held, and as such, queue elements can always be allocated on stack, if desired. While appealing, the paths are much more complex and touch more cache lines than the classic version, impacting performance.

If a lock site is well-balanced – with the lock and corresponding `unlock` operators lexically scoped and executing in the same stack frame³ – a Hemlock implementation can opt to use an on-stack Grant field instead of the thread-local Grant field accessed via `Self`. This optimization, which can be applied on an ad-hoc site-by-site basis, also acts to reduce multi-waiting on the thread-local Grant field.

3 CORRECTNESS PROOFS

In this section, we argue that the Hemlock algorithm is a correct implementation of a mutual exclusion lock with the FIFO admission and so-called *ferre-local*⁴ spinning properties. We define those properties more formally below, but first we note that we consider the standard model of shared memory [32] with basic atomic *read* and *write* operations as well as more advanced atomic *SWAP*, *CAS* and *FAA* operations. We presume atomic operators with the usual semantics.

Multiple threads perform execution steps, where at each step a thread may perform local computation or execute one of the atomic operations on the shared memory. We assume threads use the Hemlock algorithm to protect access to one or more critical sections, i.e., specially marked blocks of code that must be executed by at most one thread at a time. Our arguments are formulated for the simplified version of the algorithm given in Listing-1, and as such, all line references in this section are w.r.t. Listing-1. Yet, we note that the correctness arguments apply, albeit with minor modifications, to the optimized version in Listing-2.

We call Lines 5–13 the *entry* code and Lines 14–21 the *exit* code. Each thread cycles between the entry code (where it is trying to get into the critical section), critical section code, exit code (where it is cleaning up to allow other threads to execute their critical sections)

³For example Java synchronized blocks and methods; C++ `std::lock_guard` and `std::scoped_lock`; or locking constructs that allow the critical section to be expressed as a lambda

⁴mostly or frequently local

and the so-called remainder section, where it executes code that does not belong to any of the other three sections [38]. We assume the order in which threads take their execution steps is unknown, yet no thread ceases execution in the entry, exit or critical sections. In other words, if a thread T is in any of those code sections at time t , it is guaranteed that, eventually, at some time $t' > t$, T would perform its next execution step. We also assume that each thread executes a finite number of steps in the critical section.

We refer to Line 8 as the *entry doorstep* of the entry code and Line 20 as the *exit doorstep* of the exit code for lock L . We say that a thread is *spinning on a word* W if its next execution step is reading from a shared memory location W inside the while-loop (e.g., in Line 11 in Listing-1). We say a lock L is *associated* with a thread T if T has executed the entry doorstep for L , but has not completed the exit code for L . We prove the following properties for Hemlock algorithm defined with respect to any instance of a lock L .

- **Mutual exclusion:** At any point in time, at most one thread is in the critical section.
- **Lockout freedom:** Any thread that starts executing the entry code eventually completes the exit code.
- **FIFO:** Threads enter the critical section in the order in which they execute the entry doorstep.
- **Ferre-local spinning:** At any point in time, the number of spinning threads on the same word is bounded by the maximum number of locks associated with any thread at that time.

We note that lockout-freedom is a stronger property than the more common deadlock-freedom property [38]. Also, we note that if a thread never executes entry code of one lock inside the critical section of another (i.e., each thread has at most one associated lock), the *ferre-local* spinning implies *local* spinning, i.e., each spinning thread reads a different word W . Furthermore, the *ferre-local* spinning is a dynamic property, e.g., the bound at time t does not depend on the maximum number of locks associated with a thread prior to t .

We start with an auxiliary lemma. We denote the `Self` variable that (contains the Grant field and) belongs to a thread T_i as `Selfi`.

LEMMA 1. *For any lock L , if $L \rightarrow \text{Tail}$ is null, there is no thread that executed the entry doorstep, but has not executed the exit doorstep. In particular, there is no thread in the critical section protected by L .*

PROOF. The claim trivially holds initially at the beginning of the execution when $L \rightarrow \text{Tail}$ is null.

Let T_j be the first thread for which the claim does not hold. That is, T_j is the first thread for which `SWAP` in Line 8 returns null, yet there is a thread T_k that has executed that `SWAP` before T_j but has not executed `CAS` in Line 16 yet.

Let T_i be the last thread that set $L \rightarrow \text{Tail}$ to null before T_j (T_i might be the same thread as T_k or a different one). From the inspection of the code, once $L \rightarrow \text{Tail}$ is set to a non-null value in the entry doorstep, it can revert to null only by a successful `CAS` in Line 16. For `CAS` in Line 16 to be successful, it has to be executed by the last thread that executed `SWAP` in Line 8. In other words, if T_i executes a successful `CAS` in Line 16 at time t_1 and it executed the corresponding `SWAP` at time t_0 ($t_0 < t_1$), no other thread executed `SWAP` at time $t_0 < t < t_1$.

Consider when T_k executes the SWAP instruction in Line 8 w.r.t. $[t_0, t_1]$. Case 1: T_k executes SWAP at time $t_2 < t_0$. Let T_l be the next thread that executes SWAP after T_k (T_l can be the same as T_i , or a different thread). Since $L \rightarrow \text{Tail}$ contains Self_k , T_k will enter the while-loop in Line 11. It will exit the loop only when $\text{Self}_k \rightarrow \text{Grant}$ changes to L , which can happen, according to the code, only in Line 20 when T_k executes the exit code. By induction on the number of threads that executed SWAP between t_2 and t_0 , T_i can execute the successful CAS in Line 16 only after T_k executes the exit code. This means that when T_i executes SWAP in Line 8, T_k has executed CAS in Line 16 – a contradiction.

Case 2: T_k executes SWAP at time $t_2 > t_1$. This means that when T_j executes SWAP in Line 8, $L \rightarrow \text{Tail}$ contains either Self_k or Self_l for some other thread T_l that executes SWAP after T_k – a contradiction to the fact that T_j 's SWAP returned null. \square

With this lemma, we prove the correctness property for Hemlock.

THEOREM 2. *The Hemlock algorithm provides mutual exclusion.*

PROOF. By way of contradiction, assume T_i and T_j are simultaneously in the critical section protected by the same lock L . Let t_i and t_j be the points in time when T_i and T_j executed Line 8 for the last time, respectively. Without loss of generality, assume $t_i > t_j$. Consider the value returned by SWAP in Line 8 when executed by thread T_i . If the returned value is null, by Lemma 1 T_j must have executed its CAS instruction in Line 16 before t_i . Hence, T_i will execute the critical section after T_j has completed its own – a contradiction.

If the returned value is $\text{Self}_k \neq \text{null}$ (for some thread T_k that might be the same as T_j or a different one), let T_l be the thread that executes SWAP in Line 8 right after T_j and before T_j executes CAS in Line 16. T_l might be the same as T_i or a different thread. T_l waits in Line 11 for $\text{Self}_j \rightarrow \text{Grant}$ to become L . $\text{Self}_j \rightarrow \text{Grant}$ can only change to L (from null) in Line 20 by thread T_j . When this happens, T_j is outside of the critical section. By induction on the number of threads that execute SWAP in $(t_j, t_i]$, when T_i finds $\text{Self}_j \rightarrow \text{Grant}$ to be null in Line 11 and subsequently enters the critical section, T_j is outside of the critical section – a contradiction. \square

Next, we prove the progress property for Hemlock. We do so by showing first that a thread cannot get stuck in the exit code, i.e., the exit-code is lockout-free.

LEMMA 3. *Every thread T_i exiting the critical section eventually completes the exit code.*

PROOF. The only place in the exit code where a thread T_i may iterate indefinitely is the while-loop in Line 21. In the following, we argue that T_i either completes the exit code without reaching Line 21, or eventually breaks out of the loop in Line 21.

Let t_0 be the time T_i executes the last SWAP instruction in Line 8 before entering the critical section and t_1 be the time it executes the CAS instruction in Line 16 when it starts the exit code. Consider the following two cases. Case 1: no thread executes SWAP in $[t_0, t_1]$. In this case, $L \rightarrow \text{Tail}$ contains Self_i and the CAS instruction in Line 16 is successful. Therefore, CAS returns Self_i , and T_i can complete the exit code by a constant number of its steps by skipping Lines 18–21.

Case 2: at least one thread executes SWAP in $[t_0, t_1]$. Let T_k be the first such thread. Thus, CAS in Line 16 is not successful, and

it returns Self_j , for some $j \neq i$ (perhaps $j = k$). (We note that, by Lemma 1, CAS cannot return null.) Therefore, T_i reaches the while-loop in Line 21, after storing L into $\text{Self}_i \rightarrow \text{Grant}$ in Line 20. Consider the execution steps of thread T_k after its SWAP instruction. The SWAP instruction returns Self_i , and so T_k reaches the while-loop in Line 11. After T_i executes Line 20, eventually T_k reads L from $\text{Self}_i \rightarrow \text{Grant}$ and breaks out of the while-loop in Line 11. Next, it executes Line 12, storing null into $\text{Self}_i \rightarrow \text{Grant}$. Finally, T_i eventually reads null in Line 21 and breaks out of the while-loop. \square

Next, we show that a thread cannot get stuck in the entry code either, but first we prove a simple auxiliary lemma.

LEMMA 4. *The SWAP instruction in Line 8 executed by thread T_i never returns Self_i .*

PROOF. From code inspection, only thread T_i can write Self_i into $L \rightarrow \text{Tail}$. Thus, the claim holds until T_i executes SWAP at least for the second time.

Let T_i execute SWAP in Line 8 for the k -th time, $k \geq 2$, at time t_k . Consider the previous, $k-1$ -th execution of SWAP by T_i , at time t_{k-1} . From code inspection, T_i has to execute CAS in Line 16 at time $t_{k-1} < t < t_k$. If CAS is successful, T_i changes the value of $L \rightarrow \text{Tail}$ to null, and thus k -th SWAP will return null or Self_j for $j \neq i$. If CAS is unsuccessful, there has been (at least one) another thread T_j , $j \neq i$, that performed SWAP in Line 8 at time $t_{k-1} < t' < t$. Thus, k -th SWAP at time $t_k > t'$ will return Self_j , or Self_k (for $k \neq i, j$) or null, but not Self_i . \square

LEMMA 5. *Every thread T_i starting the entry code eventually enters the critical section.*

PROOF. The only place in the entry code where a thread T_i may iterate indefinitely is the while-loop in Line 11. In the following, we argue that T_i either completes the entry code without reaching Line 11, or eventually breaks out of the loop in Line 11.

Consider the following two cases w.r.t. to the value returned by SWAP executed by thread T_i in the entry code at time t_i . Case 1: SWAP returns null. In this case, T_i can complete the entry code by a constant number of its steps by skipping Lines 9–12.

Case 2: SWAP returns Self_j . Thus, T_i reaches the while-loop in Line 11 and waits until $\text{Self}_j \rightarrow \text{Grant}$ contains L . From Lemma 4, we know that $j \neq i$. Consider the state of thread T_j w.r.t. to the value returned by SWAP executed by thread T_j in Line 8 at time $t_j < t_i$. If T_j 's SWAP returned null, T_j will complete the entry code, and eventually reach Line 20 in the exit code. Otherwise, T_j 's SWAP returned Self_k . If Self_k is equal to Self_i , then T_i executed (another) SWAP at time $t'_i < t_j$. This means that T_i has executed the exit code in the interval (t'_i, t_i) , and in particular, has executed Line 20 in the interval (t_j, t_i) . Therefore, T_j will break out of the while-loop in Line 11*, enter the critical section, and eventually execute Line 20, allowing T_i to complete its entry code. If Self_k is not equal to Self_i , consider whether at time t_j , T_k has completed the while-loop in Line 11 (including by skipping that while-loop entirely by evaluating the condition in Line 9 to false). If so, T_k will complete the entry code, and eventually reach Line 20 in the exit code, letting T_j and, eventually, T_i to break out of the while-loop in Line 11*. Otherwise, T_k is waiting in Line 11. (We note that there is

a third possibility that T_k has executed SWAP, but has not evaluated the condition in Line 9 yet, or has evaluated it to true, but has not started the while-loop in Line 11. We treat it as one of the first two possibilities, according to whether or not T_k eventually waits in the while-loop in Line 11).

In the case T_k is waiting in Line 11, we consider recursively the state of T_k w.r.t. to the value returned by its SWAP, and any thread T_k is waiting for in Line 11. Since the number of threads is bounded, there have to be two threads, T_a and T_b , s.t. T_a 's SWAP returns Self_b and T_b 's SWAP returns either (a) null, or (b) Self_c for T_c in $\{T_i, T_j, T_k, \dots, T_a\}$ or (c) Self_c for T_c that has completed the while-loop in Line 11. Following the similar reasoning as above, we conclude that T_b eventually executes Line 20. in its exit code, and allows T_a to break our of the waiting loop in Line 11. By induction on the number of threads in the set $\{T_i, T_j, T_k, \dots, T_a\}$, we conclude that, eventually, T_i completes the while-loop in Line 11 and enters the critical section. \square

THEOREM 6. *The Hemlock algorithm is lockout-free.*

PROOF. This follows directly from Lemma 3 and 5, and the assumption that a thread completes its critical section in a finite number of its execution steps. \square

Next, we prove that threads enter the critical section in the FIFO order w.r.t. their execution of the entry doorstep. In the following lemma, we show that when two threads execute the entry doorstep one after the other, the latter thread cannot “skip” over the former and enter the critical section first.

LEMMA 7. *Let T_i be the next thread that executes the entry doorstep after T_j . Then T_i enters the critical section after T_j .*

PROOF. First, we note that the claim trivially holds if $i = j$. This is because T_i may execute another entry doorstep only after (entering and) exiting the critical section.

Next, we consider two cases. Case 1: T_i 's execution of the SWAP instruction in the entry doorstep returns null. This can only happen if T_j performs CAS in Line 16 before T_i executes the SWAP instruction. This means, however, that T_j has completed its critical section, and the claim holds. Case 2: T_i 's execution of the SWAP instruction in the entry doorstep returns Self_j . Then T_i will proceed to Line 11, and wait until $\text{Self}_j \rightarrow \text{Grant}$ changes to L . This can only happen when T_j reaches Line 20, which means that, once again, T_j has completed its critical section, and the claim holds. \square

THEOREM 8. *The Hemlock algorithm has the FIFO property.*

PROOF. By way of contradiction, assume there is a thread T_i that executes the entry doorstep after a thread T_j , but enters the critical section before T_j . Without loss of generality, let T_i be the first such thread in the execution of the algorithm. Let T_k be the thread that executes the entry doorstep right before T_i (T_k might be the same thread as T_j or a different one). By the way we chose T_i , T_k has not entered the critical section when T_i does. This is a contradiction to Lemma 7. \square

We are left to prove the last stated property of Hemlock, namely the fere-local spinning. Again, we start with an auxiliary lemma.

LEMMA 9. *For every lock L and thread T_i , there is at most one thread T_j waiting in Line 11 for $\text{Self}_i \rightarrow \text{Grant}$ to become L .*

PROOF. Consider thread T_j waiting in Line 11 for $\text{Self}_i \rightarrow \text{Grant}$ to become L . To reach Line 11, T_j executed Line 8, where SWAP returned Self_i . This, in turn, means that T_i has also executed Line 8 (before T_j did). This is because Line 8 is the only place where Self_k can be written into $L \rightarrow \text{Tail}$, for any thread T_k .

Assume by way of contradiction that another thread T_k is also waiting in Line 11 for $\text{Self}_i \rightarrow \text{Grant}$ to become L . Let t_j and t_k be the points in time when T_j and T_k executed Line 8 for the last time, respectively. From the atomicity of SWAP, $t_j \neq t_k$. Assume without loss of generality that $t_j < t_k$. Let t_i be the time T_i executed the SWAP for the last time before t_j . From the above, $t_i < t_j < t_k$.

From the inspection of the code, the only way for T_k to write Self_i in Line 8 into pred is for T_i to execute Line 8 right before T_k does. That is, there has to be a point in time $t_j < t'_i < t_k$ in which T_i executed Line 8 again. This means that during (t_i, t'_i) , T_i has completed the entry code, its critical section, and the exit code (and started executing another entry code). When executing the exit code, T_i performed CAS in Line 16*. If this CAS is successful, this means that it takes place before t_j (since the value of $L \rightarrow \text{Tail}$ remains unchanged), and so T_j would not read Self_i into pred in Line 8 at t_j . Thus, this CAS has to fail, i.e., return a value different from Self_i .

Thus, T_i has to execute Lines 20–21, and in particular, wait until its Grant field contains null. This happens before t'_i and hence before t_k , therefore T_j is the only thread at this point that waits in Line 11 for $\text{Self}_i \rightarrow \text{Grant}$ to become L . Since T_i completes its exit point (and executes SWAP at t'_i), it must have exited the while-loop in Line 21 before t'_i . This can happen only if T_j has executed Line 12 after t_j and before t'_i . Thus, T_j no longer waits in Line 11 for $\text{Self}_i \rightarrow \text{Grant}$ to become L when T_k starts to wait there – a contradiction. \square

Note that as explained in Section-2.2, there might be multiple threads spinning on the word $\text{Self}_i \rightarrow \text{Grant}$ in Line 11, each for a different lock L . However, as we argue in the lemma above, there might be only one thread *per any given lock* that waits for the value of $\text{Self}_i \rightarrow \text{Grant}$ to change.

THEOREM 10. *The Hemlock algorithm has the fere-local spinning property.*

PROOF. Assume thread T_i has k associated locks at the given point in time. By inspecting the code, threads can spin on a word only in Lines 11 or 21. By Lemma 9, there might be at most k threads spinning on $\text{Self}_i \rightarrow \text{Grant}$ in Line 11, one for each of the k locks associated with T_i . (We note that by the definition of the associated locks, a thread T_j cannot spin on $\text{Self}_i \rightarrow \text{Grant}$ and wait until it contains a value of a lock that is not associated with T_i .) At the same time, only T_i can spin on $\text{Self}_i \rightarrow \text{Grant}$ in Line 21, and it does so after writing L into $\text{Self}_i \rightarrow \text{Grant}$ in Line 20. This means that when T_i starts spinning on $\text{Self}_i \rightarrow \text{Grant}$, another thread T_j stops spinning on $\text{Self}_i \rightarrow \text{Grant}$ in Line 11. We note that it can be easily shown that such T_j exists. Thus, at any given point in time, the number of threads spinning on $\text{Self}_i \rightarrow \text{Grant}$ is bounded by k . \square

4 RELATED WORK

While mutual exclusion remains an active research topic [48] [13] [43] [19] [33] [26] [18] [17] [16] [20] [1] [23] [50] we focus on locks closely related to our design.

Simple test-and-set or polite test-and-test-and-set [50] locks are compact and exhibit excellent latency for uncontended operations, but fail to scale and may allow unfairness and even indefinite starvation. Ticket Locks are compact and FIFO and also have excellent latency for uncontended operations but they also fail to scale because of global spinning, although some variations attempt to overcome this obstacle, at the cost of increased space [19, 21, 47]. For instance Anderson’s array-based queueing lock [4, 5] is based on Ticket Locks but provides local spinning. It employs a waiting array for each lock instance, sized to ensure there is at least one array element for each potentially waiting thread, yielding a potentially large footprint. The maximum number of participating threads must be known in advance when initializing the lock.

Queue-based locks such as MCS or CLH are FIFO and provide local spinning and are thus more scalable. MCS is used in the linux kernel for the low-level “qspinlock” construct [7, 9, 37]. Modern extensions of MCS edit the queue order to make the lock *NUMA-Aware* [18]. MCS readily allows editing and re-ordering of the queue of waiting threads, [16, 18, 41] whereas editing the chain is more difficult under Hemlock.

Hemlock does not provide constant remote memory reference (RMR) complexity [26]. Similar to MCS, Hemlock lacks a wait-free unlock operation, whereas the unlock operator for CLH and Tickets is wait-free. Unlike MCS, Hemlock requires active synchronous back-and-forth communication in the unlock path between the outgoing thread and its successor.

Dvir’s algorithm [26] and Lee’s HL1 [35, 36], when simplified for use in cache-coherent environments, both have extremely simple paths, suggesting they would be competitive with Hemlock, but they do not readily tolerate multiple locks being held simultaneously. A crucial requirement for our design is that the lock algorithms can be used under existing APIs such as pthread mutex locks or linux kernel locks, which allow multiple locks to be held simultaneously and released in arbitrary order.

5 EMPIRICAL RESULTS

Unless otherwise noted, all data was collected on an Oracle X5-2 system. The system has 2 sockets, each populated with an Intel Xeon E5-2699 v3 CPU running at 2.30GHz. Each socket has 18 cores, and each core is 2-way hyperthreaded, yielding 72 logical CPUs in total. The system was running Ubuntu 20.04 with a stock Linux version 5.4 kernel, and all software was compiled using the provided GCC version 9.3 toolchain at optimization level “-O3”. 64-bit C or C++ code was used for all experiments. Factory-provided system defaults were used in all cases, and Turbo mode [51] was left enabled. In all cases default free-range unbound threads were used (no pinning of threads to processors).

We implemented all user-mode locks within LD_PRELOAD interposition libraries that expose the standard POSIX pthread_mutex_t programming interface using the framework from [23]. This allows us to change lock implementations by varying the LD_PRELOAD environment variable and without modifying the

application code that uses locks. The C++ std::mutex construct maps directly to pthread_mutex primitives, so interposition works for both C and C++ code. All lock busy-wait loops used the Intel PAUSE instruction.

5.1 MutexBench benchmark

The MutexBench benchmark spawns T concurrent threads. Each thread loops as follows: acquire a central lock L ; execute a critical section; release L ; execute a non-critical section. At the end of a 10 second measurement interval the benchmark reports the total number of aggregate iterations completed by all the threads. We report the median of 7 independent runs in Figure-2 where the critical section is empty as well as the non-critical section, subjecting the lock to extreme contention. (At just one thread, this configuration also constitutes a useful benchmark for uncontended latency). The X -axis reflects the number of concurrently executing threads contending for the lock, and the Y reports aggregate throughput. For clarity and to convey the maximum amount of information to allow a comparison of the algorithms, the X -axis is offset to the minimum score and the Y -axis is logarithmic.

We ran the benchmark under the following FIFO/FCFS lock algorithms: **MCS** is classic MCS; **CLH** is CLH based on Scott’s *CLH variant with a standard interface* Figure-4.14 of [50]; **Ticket** is a classic Ticket Lock; **Hemlock** is the Hemlock algorithm, with the CTR optimization, described above. **Hemlock-** is the naive Hemlock algorithm without the CTR optimization, and corresponds to Listing 1. For the MCS and CLH locks, our implementation stores the current head of the queue – the owner – in a field adjacent to the tail, so the lock body size was 2 words. The Ticket Lock also has a size of 2 words, while Hemlock requires a lock body of just 1 word. MCS and CLH additionally require one queue element for each lock held or waited upon. CLH also requires that each lock be initialized with a so-called dummy element. To avoid memory allocation during the measurement interval, the MCS implementation uses a thread-local stack of free queue elements⁵.

In Figure-2 we make the following observations regarding operation at maximal contention with an empty critical section:⁶

- At 1 thread the benchmark measures the latency of uncontended acquire and release operations. Ticket Locks are the fastest, followed by Hemlock, CLH and MCS.

⁵As we are implementing a general purpose pthreads locking interface, a thread can hold multiple locks at one time. Using MCS as an example, lets say thread $T1$ currently holds locks $L1, L2, L3$ and $L4$. We’ll assume no contention. $T1$ will have deposited MCS queue nodes into each of those locks. MCS nodes can not be reclaimed until the corresponding unlock operation. Our implementation could malloc and free nodes as necessary – allocating in the lock operator and freeing in unlock – but to avoid malloc and its locks, we instead use a thread-local stack of free queue nodes. In the lock operator, we first try to allocate from that free list, and then fall back to malloc only as necessary. In unlock, we return nodes to that free list. This approach reduces malloc-free traffic and the incumbent scalability concerns. We currently don’t bother to trim the thread-local stack of free elements. So, if thread $T1$ currently holds no locks, the free stack will contain N elements where N is the maximum number of locks concurrently held by $T1$. We reclaim the elements from the stack when $T1$ exits. A stack is convenient for locality.

⁶We note in passing that care must be taken when *negative* or *retrograde* scaling occurs and aggregate performance degrades as we increase threads. As a thought experiment, if a hypothetical lock implementation were to introduce additional synthetic delays outside the critical path, aggregate performance might increase as the delay throttles the arrival rate and concurrency over the contended lock [29]. As such, evaluating just the maximal contention case in isolation is insufficient.

Hemlock : Compact and Scalable Mutual Exclusion

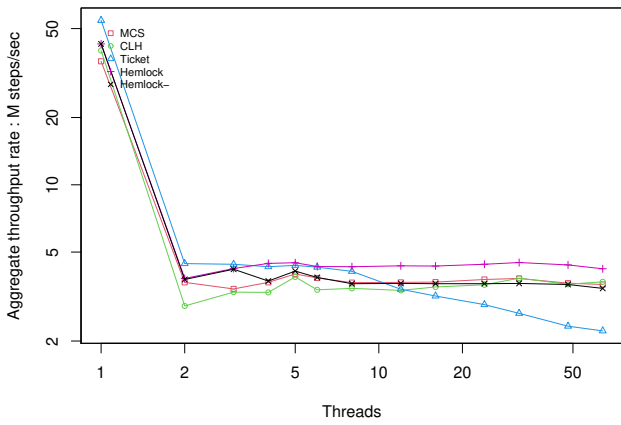

Figure 2: MutexBench : Maximum Contention

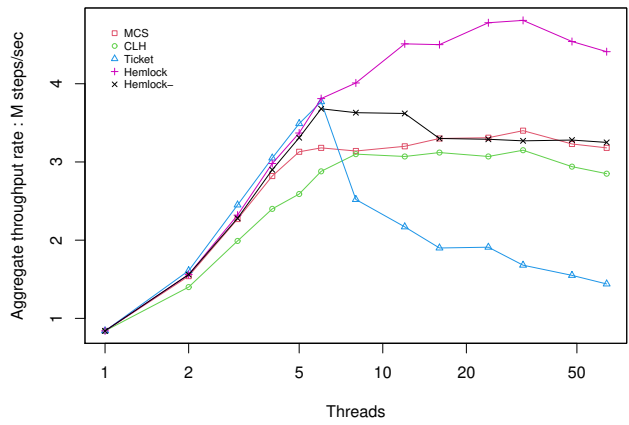

Figure 3: MutexBench : Moderate Contention

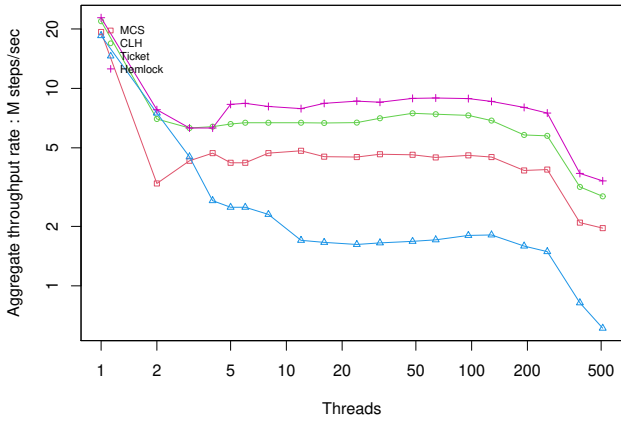

Figure 4: MutexBench : Maximum Contention – SPARC

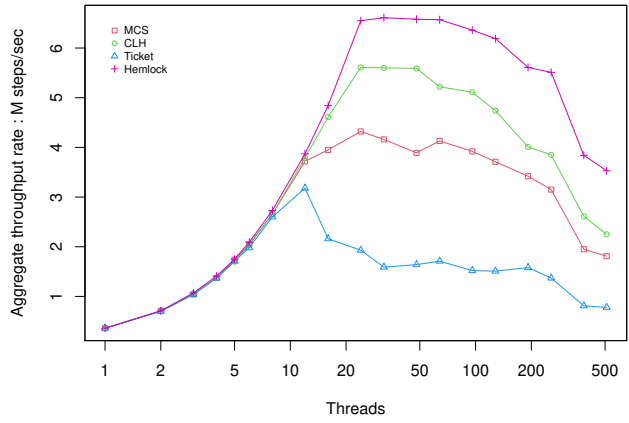

Figure 5: MutexBench : Moderate Contention – SPARC

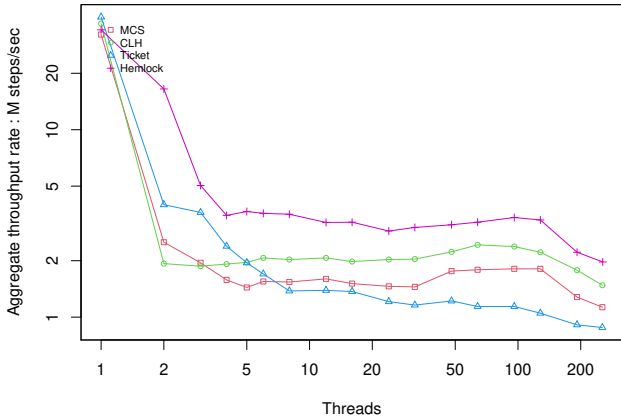

Figure 6: MutexBench : Maximum Contention – AMD

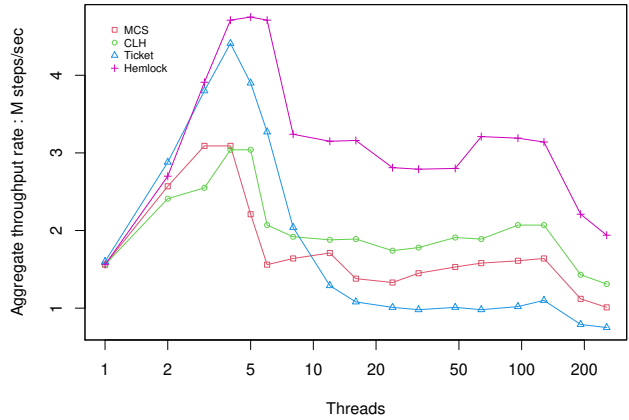

Figure 7: MutexBench : Moderate Contention – AMD

- As we increase the number of threads, Ticket Locks initially do well but then fade, exhibiting a precipitous drop in performance.

- Broadly, Hemlock performs slightly better than or the same as CLH or MCS.

To gauge the contribution and benefit of the CTR optimization, we can compare Hemlock, which incorporates CTR, against Hemlock-, the simplistic reference implementation, shown in Listing 1.

In Figure-3 we configure the benchmark so the non-critical section generates a uniformly distributed random value in [0–400) and steps a thread-local C++ `std::mt19937` random number generator (PRNG) that many steps, admitting potential positive scalability. The critical section advances a shared random number generator 5 steps. In this moderate contention case we observe that Ticket Locks again do well at low thread counts, and that Hemlock outperforms both MCS and CLH.

5.2 MutexBench Benchmark : SPARC

To show that our approach is general and portable, we next report MutexBench results on a Sun/Oracle T7-2 [12] in Figures 4 and 5. The T7-2 has 2 sockets, each socket populated by an M7 SPARC CPU running at 4.13GHz with 32 cores. Each core has 8 logical CPUs sharing 2 pipelines. The system has 512 logical CPUs and was running Solaris 11. We used the GCC version 6.1 toolchain to compile the benchmark and the lock libraries. 64-bit SPARC does not directly support atomic fetch-and-add or SWAP operations – these are emulated by means of a 64-bit compare-and-swap operator (CASX). To implement CTR in the waiting phase, we used MONITOR-MWAIT on the predecessor’s Grant field followed by an immediate CASX to try to reset Grant, avoiding the promotion from *shared* to *modified* state which would normally be found in naive busy-waiting. As needed, CASX(A, 0, 0) serves as the read-with-intent-to-write primitive. The system uses MOESI cache coherency instead of the MESIF [30] found in modern Intel-branded processors, allowing more graceful handling of write sharing. The abrupt performance drop experienced by all locks starting at 256 threads is caused by competition for pipeline resources.

5.3 MutexBench Benchmark : AMD

Figures 6 and 7 show performance on a 2-socket AMD NUMA system, where each socket contains an EPYC 7662 64-Core Processor and each core supports 2 logical CPUs, for 256 logical processors in total. The base clock speed is 2.0 GHz. The kernel was linux version 5.4 and we used the same binaries built on the Intel X5-2 system. AMD uses a MOESI coherence protocol. The results on AMD concur with those observed on the Intel system.

5.4 LevelDB

In Figure-8 we used the “readrandom” benchmark in LevelDB version 1.20 database⁷ varying the number of threads and reporting throughput from the median of 5 runs of 50 second each. Each thread loops, generating random keys and then tries to read the associated value from the database. We used the Oracle X5-2 system to collect data. We first populated a database⁸ and then collected data⁹. We made a slight modification to the `db_bench` benchmarking

⁷leveldb.org

⁸`db_bench --threads=1 --benchmarks=fillseq --db=/tmp/db/`

⁹`db_bench --threads=threads --benchmarks=readrandom --use_existing_db=1 --db=/tmp/db/ --duration=50`

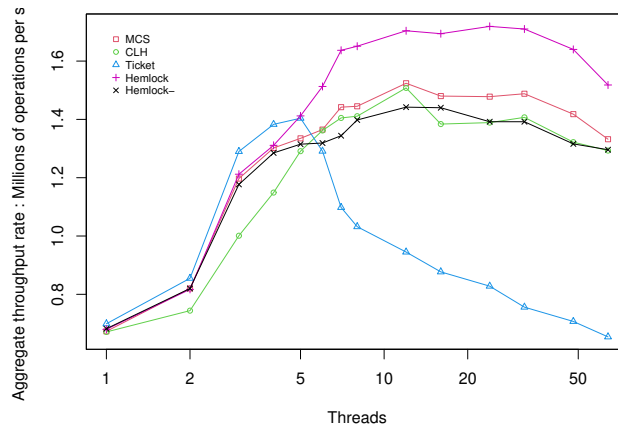

Figure 8: LevelDB readrandom

harness to allow runs with a fixed duration that reported aggregate throughput. Ticket Locks exhibit a slight advantage over MCS, CLH and Hemlock at low threads count after which Ticket Locks fade. LevelDB uses coarse-grained locking, protecting the database with a single central mutex: `DBImpl::Mutex`. Profiling indicates contention on that lock via `leveldb::DBImpl::Get()`.

Using an instrumented version of Hemlock we characterized the application behavior of LevelDB, as it relates to Hemlock. At 64 threads, during a 50 second run, we found 24 instances of calls to lock where a thread already held at least one other lock. These all occurred during the first second after startup. The maximum number of locks held simultaneously by any thread was 2. The maximum number of threads waiting simultaneously on any Grant field was 1, thus the application enjoyed purely local spinning.

5.5 Impact of CTR Optimization

We used the built-in linux `perf stat` command to collect data from the hardware performance monitoring unit counters and found that CTR reduced total offcore traffic [11], while providing an improvement in throughput. Table 2 examines the execution of the MutexBench benchmark on the X5-2 system configured for 32 threads and with 0-length critical and non-critical sections. The *Rate* column is given in units of millions of lock-unlock operations completed per second and the *OffCore* column reports the number of offcore accesses¹⁰ counters per lock-unlock pair. Offcore accesses are memory references that can not be satisfied from the core’s local L2 cache, including coherence misses. As the working set of the each thread in the benchmark is tiny, offcore accesses largely reflect cache coherent communications arising from acquiring and releasing the lock. As we can see Hemlock with CTR yields higher throughput than Hemlock without CTR, and incurs less offcore traffic. Both CLH and MCS suffer from moderately elevated offcore communication rates. We isolated that increase to the stores the reinitialize the queue nodes in preparation for reuse. Those stores execute outside the critical section.

¹⁰we used the sum of `offcore_requests.all_data_rd` and `offcore_requests.demand_rfo`

| Lock | Rate | OffCore |
|---------------------|------|---------|
| MCS | 3.81 | 10.6 |
| CLH | 3.82 | 11.1 |
| Ticket Locks | 2.66 | 45.9 |
| Hemlock | 4.48 | 6.81 |
| Hemlock without CTR | 3.62 | 7.92 |

Table 2: Impact of CTR on OffCore Access Rates

We can show similar benefits from CTR with a simple program where a set of concurrent threads are configured in a ring, and circulate a single token. A thread waits for its mailbox to become non-zero, clears the mailbox, and deposits the token in its successor’s mailbox. Using CAS, SWAP or Fetch-and-Add to busy-wait improves the circulation rate as compared to the naive form which uses loads.

5.6 Multi-waiting

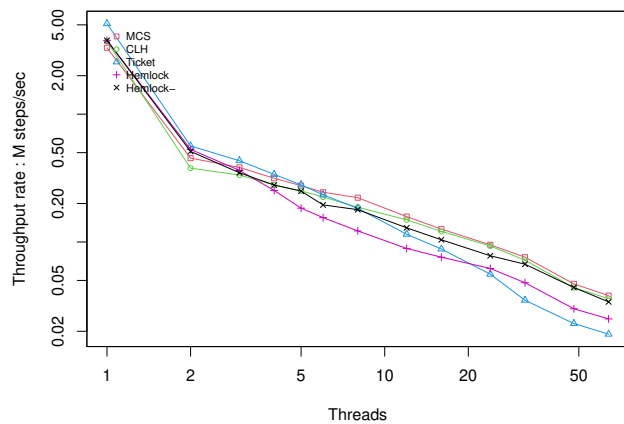

Figure 9: Multi-waiting

We intentionally constructed a benchmark that induces multi-waiting to measure the performance of Hemlock in a challenging and unfavorable operating region. We modify `MutexBench` to have an array of 10 shared locks. There is a single dedicated “leader” thread which loops as follows : acquire all 10 lock in ascending order and then release the locks in reverse order. At the end of the measurement interval the leader reports the number of steps it completed, where a step consists of acquiring and releasing all the locks. All the other threads loop, picking a single random lock from the set of 10, and then acquire and release that lock. We ignore the number of iterations completed by the non-leader threads. Neither the leader nor the non-leaders execute any delays in their critical or non-critical phases. When configured for 32 threads, for example, we have 1 leader and 31 non-leaders. In general, the worst-case maximum number of threads busy-waiting on a given location at a given time is as follows : 1 for CLH and MCS, which enjoy purely local spinning; $T - 1$ for ticket locks; and $\min(T - 1, N - 1)$ for Hemlock, where T is the number of threads and N is the number

of locks, which is 10 in our configuration. We plot the throughput results in Figure-9. Data for this experiment was collected on the Oracle X5-2 described earlier.

As we increase the number of threads, performance, as expected, drops over all the lock algorithms as the primary leader threads suffers more obstruction from the non-leader threads. And as usual, ticket lock performs well, relative to other locks, at low thread counts but the performance then falls behind as we increase the number of threads. Hemlock-, without CTR, performs somewhat worse than CLH and MCS as we increase the number of threads, and multi-waiting increases. Finally, Hemlock with CTR performs worse than Hemlock- as the CTR form optimistically assumes multi-waiting is rare and busy-waits in an impolite fashion with CAS instead of loads. As such, a grant field subject to multi-waiting will *slosh* or bounce between caches as each waiting thread drives the underlying line into exclusive M -state. This behavior consumes interconnect bandwidth and can retard lock ownership handover. The CTR optimization is actually harmful under high degrees of multi-waiting.

6 FUTURE WORK

An interesting variation we intend to explore in the future is to replace the simplistic spinning on the Grant field with a per-thread condition variable and mutex pair that protect the Grant field, allowing threads to use the same waiting policy as the platform mutex and condition variable primitives. All long-term waiting for the Grant field to become a certain address or to return to 0 would be via the condition variable. Essentially, we treat Grant as a bounded buffer of capacity 1 protected in the usual fashion by a condition variable and mutex. This construction yields 2 interesting properties : (a) the new lock enjoys a fast-path, for uncontended locking, that doesn’t require any underlying mutex or condition variable operations, (b) even if the underlying system mutex isn’t FIFO, our new lock provides strict FIFO admission. Again, the result is compact, requiring only a mutex, condition variable and Grant field per thread, and only one word per lock to hold the Tail. For systems where locks outnumber threads, such an approach would result in space savings.

7 CONCLUSION

Hemlock trades off improved space complexity against the cost of higher remote memory reference (RMR) complexity. Hemlock is exceptionally simple with short paths, and avoids the dependent loads and indirection required by CLH or MCS to locate queue nodes. The contended handover critical path is extremely short – the unlock operator conveys ownership to the successor in an expedited fashion. Despite being compact, it provides local spinning in common circumstances and scales better than Ticket Locks. Instead of traditional queue elements, as found in CLH and MCS, we use a per-thread shared singleton element. Finally, Hemlock is practical and readily usable in real-world lock implementations.

ACKNOWLEDGMENTS

We thank Peter Buhr and Trevor Brown at the University of Waterloo for access to their AMD system.

REFERENCES

- [1] Ole Agesen, David Detlefs, Alex Garthwaite, Ross Knippel, Y. S. Ramakrishna, and Derek White. An efficient meta-lock for implementing ubiquitous synchronization. *SIGPLAN Notices OOPSLA* 1999, 1999. doi : 10.1145/320385.320402.
- [2] H. Akkan, M. Lang, and L. Ionkov. HPC runtime support for fast and power efficient locking and synchronization. In *2013 IEEE International Conference on Cluster Computer – CLUSTER*, 2013. URL: <http://dx.doi.org/10.1109/CLUSTER.2013.6702659>.
- [3] Vitaly Aksenov, Dan Alistarh, and Petr Kuznetsov. Brief announcement: Performance prediction for coarse-grained locking. In *Proceedings of the 2018 ACM Symposium on Principles of Distributed Computing*, PODC '18. ACM, 2018. URL: <http://doi.acm.org/10.1145/3212734.3212785>, doi : 10.1145/3212734.3212785.
- [4] J.H. Anderson, Y.J. Kim, and T. Herman. Shared-memory mutual exclusion: major research trends since 1986. *Distributed Computing*, 2003. URL: <https://doi.org/10.1007/s00446-003-0088-6>.
- [5] T. E. Anderson. The performance of spin lock alternatives for shared-memory multiprocessors. *IEEE Transactions on Parallel and Distributed Systems*, 1990. doi : 10.1109/71.80120.
- [6] Guang-len Cheng, Mingdong Feng, Charles E. Leiserson, Keith H. Randall, and Andrew F. Stark. Detecting data races in cilk programs that use locks. In *Proceedings of the Tenth Annual ACM Symposium on Parallel Algorithms and Architectures*, SPAA '98. Association for Computing Machinery, 1998. doi : 10.1145/277651.277696.
- [7] Jonathan Corbet. MCS locks and qspinlocks. <https://lwn.net/Articles/590243>, March 11, 2014. Accessed: 2018-09-12.
- [8] Jonathan Corbet. A surprise with mutexes and reference counts. <https://lwn.net/Articles/575460>, December 4, 2013.
- [9] Jonathan Corbet. Mcs locks and qspinlocks, 2014. URL: <https://lwn.net/Articles/590243/>.
- [10] Jonathan Corbet. Short waits with umwait. 2019. URL: <https://lwn.net/Articles/790920/>.
- [11] Intel Corporation. 6th generation intel® core™ processor family uncore performance monitoring reference manual, April, 2016. URL: <https://www.intel.com/content/dam/www/public/us/en/documents/manuals/6th-gen-core-family-uncore-performance-monitoring-manual.pdf>.
- [12] Oracle Corporation. Sparc t7-2 server - oracle datasheet, 2014. URL: <http://www.oracle.com/us/products/servers-storage/sparc-t7-2-server-ds-2687049.pdf>.
- [13] Travis Craig. Building fifo and priority-queueing spin locks from atomic swap, 1993.
- [14] D. Dice. Waiting policies for locks : spin-then-park, 2015. URL: <https://blogs.oracle.com/dave/waiting-policies-for-locks--spin-then-park>.
- [15] Dave Dice. Malthusian locks. *CoRR*, abs/1511.06035, 2015. URL: <http://arxiv.org/abs/1511.06035>, arXiv: 1511.06035.
- [16] Dave Dice. Malthusian locks. In *Proceedings of the Twelfth European Conference on Computer Systems*, EuroSys '17, 2017. URL: <http://doi.acm.org/10.1145/3064176.3064203>.
- [17] Dave Dice and Alex Kogan. Compact numa-aware locks. *CoRR*, abs/1810.05600, 2018. URL: <http://arxiv.org/abs/1810.05600>.
- [18] Dave Dice and Alex Kogan. Compact numa-aware locks. In *Proceedings of the Fourteenth EuroSys Conference 2019*, EuroSys '19. Association for Computing Machinery, 2019. doi : 10.1145/3302424.3303984.
- [19] Dave Dice and Alex Kogan. TWA - ticket locks augmented with a waiting array. In *Euro-Par 2019: Parallel Processing - 25th International Conference on Parallel and Distributed Computing*, Göttingen, Germany, August 26-30, 2019, *Proceedings*. Springer, 2019. doi : 10.1007/978-3-030-29400-7_24.
- [20] Dave Dice and Alex Kogan. Fissile locks, 2020. URL: <https://arxiv.org/abs/2003.05025>, arXiv: 2003.05025.
- [21] David Dice. Brief announcement: A partitioned ticket lock. In *Proceedings of the Twenty-third Annual ACM Symposium on Parallelism in Algorithms and Architectures*, SPAA '11, 2011. URL: <http://doi.acm.org/10.1145/1989493.1989543>.
- [22] David Dice and Alex Kogan. Hemlock : Compact and scalable mutual exclusion. In *Proceedings of the 33rd ACM Symposium on Parallelism in Algorithms and Architectures*, SPAA, 2021. URL: <https://doi.org/10.1145/3409964.3461805>.
- [23] David Dice, Virendra J. Marathe, and Nir Shavit. Lock cohorting: A general technique for designing numa locks. *ACM Trans. Parallel Comput.*, 2015. URL: <http://doi.acm.org/10.1145/2686884>, doi : 10.1145/2686884.
- [24] David Dice and Mark Moir. Inter-thread communication using processor messaging – us patent 10,776,154, 2008. URL: <https://patents.google.com/patent/US10776154B2/en>.
- [25] David Dice and Mark Moir. System and method for mitigating the impact of branch misprediction when exiting spin loops – us patent 9,304,776, 2012. URL: <https://patents.google.com/patent/US9304776>.
- [26] Rotem Dvir and Gadi Taubenfeld. Mutual Exclusion Algorithms with Constant RMR Complexity and Wait-Free Exit Code. In James Aspnes, Alysson Bessani, Pascal Felber, and João Leitão, editors, *21st International Conference on Principles of Distributed Systems (OPDIS 2017)*, Leibniz International Proceedings in Informatics (LIPIcs), Dagstuhl, Germany, 2018. Schloss Dagstuhl–Leibniz-Zentrum fuer Informatik. URL: <http://drops.dagstuhl.de/opus/volltexte/2018/8652>, doi : 10.4230/LIPIcs.OPDIS.2017.17.
- [27] Stijn Eyerman and Lieven Eeckhout. Modeling critical sections in amdahl's law and its implications for multicore design. In *Proceedings of the 37th Annual International Symposium on Computer Architecture*, ISCA '10. ACM, 2010. URL: <http://doi.acm.org/10.1145/1815961.1816011>, doi : 10.1145/1815961.1816011.
- [28] M. J. Fischer, N. A. Lynch, J. E. Burns, and A. Borodin. Resource allocation with immunity to limited process failure. In *20th Annual Symposium on Foundations of Computer Science (FOCS 1979)*, 1979. URL: <http://dx.doi.org/10.1109/SFCS.1979.37>.
- [29] Carlos Gershenson and Dirk Helbing. When Slower is Faster. *CoRR*, 2011. URL: <http://arxiv.org/abs/1506.06796v2>.
- [30] J.R. Goodman and H.H.J. Hum. Mesif: A two-hop cache coherency protocol for point-to-point interconnects, 2009. URL: <https://www.cs.auckland.ac.nz/~goodman/TechnicalReports/MESIF-2009.pdf>.
- [31] John L. Hennessy and David A. Patterson. *Computer Architecture, Sixth Edition: A Quantitative Approach*. Morgan Kaufmann Publishers Inc., San Francisco, CA, USA, 6th edition, 2017.
- [32] Maurice P. Herlihy and Jeannette M. Wing. Linearizability: A correctness condition for concurrent objects. *ACM Trans. Program. Lang. Syst.*, 1990. doi : 10.1145/78969.78972.
- [33] Prasad Jayanti, Siddhartha Jayanti, and Sucharita Jayanti. Towards an ideal queue lock. In *Proceedings of the 21st International Conference on Distributed Computing and Networking*, ICDCN 2020. Association for Computing Machinery, 2020. URL: <https://doi.org/10.1145/3369740.3369784>.
- [34] Doug Lea. The java.util.concurrent synchronizer framework. *Science of Computer Programming*, 2005. Special Issue on Concurrency and synchronization in Java programs. URL: <http://www.sciencedirect.com/science/article/pii/S0167642305000663>, doi : <https://doi.org/10.1016/j.scico.2005.03.007>.
- [35] Hyonho Lee. Local-spin mutual exclusion algorithms on the dsm model using fetch&store objects. Masters Thesis, University of Toronto. URL: <http://www.cs.toronto.edu/pub/hlee/thesis.ps>.
- [36] Hyonho Lee. Transformations of mutual exclusion algorithms from the cache-coherent model to the distributed shared memory model. In *25th IEEE International Conference on Distributed Computing Systems (ICDCS'05)*, 2005. doi : 10.1109/ICDCS.2005.83.
- [37] Waiman Long. qspinlock: Introducing a 4-byte queue spinlock implementation. <https://lwn.net/Articles/561775>, July 31, 2013, 2013. Accessed: 2018-09-19.
- [38] Nancy A. Lynch. *Distributed Algorithms*. Morgan Kaufmann Publishers Inc., 1996.
- [39] O. Krieger B. Rosenberg M. Auslander, D. Edelson and R. Wisniewski. Enhancement to the mcs lock for increased functionality and improved programmability – u.s. patent application number 20030200457, 2003. URL: <https://patents.google.com/patent/US20030200457>.
- [40] P. Magnusson, A. Landin, and E. Hagersten. Queue locks on cache coherent multiprocessors. In *Proceedings of 8th International Parallel Processing Symposium*, 1994. doi : 10.1109/IPPS.1994.288305.
- [41] Evangelos P. Markatos and Thomas J. LeBlanc. Multiprocessor synchronization primitives with priorities. 8th IEEE Workshop on Real-Time Operating Systems and Software. IEEE, 1991.
- [42] John M. Mellor-Crummey and Michael L. Scott. Algorithms for scalable synchronization on shared-memory multiprocessors. *ACM Trans. Comput. Syst.*, 1991. URL: <http://doi.acm.org/10.1145/103727.103729>.
- [43] John M. Mellor-Crummey and Michael L. Scott. Scalable reader-writer synchronization for shared-memory multiprocessors. In *Proceedings of the Third ACM SIGPLAN Symposium on Principles and Practice of Parallel Programming*, PPOPP '91. ACM, 1991. URL: <http://doi.acm.org/10.1145/109625.109637>.
- [44] Microsoft. Waitonaddress function, 2015. URL: <https://docs.microsoft.com/en-us/windows/win32/api/synchapi/nf-synchapi-waitonaddress>.
- [45] Atsushi Nemoto. Bug 13690 – pthread_mutex_unlock potentially cause invalid access. https://sourceware.org/bugzilla/show_bug.cgi?id=13690, February 14, 2012.
- [46] Robert O'Callahan and Jong-Deok Choi. Hybrid dynamic data race detection. In *Proceedings of the Ninth ACM SIGPLAN Symposium on Principles and Practice of Parallel Programming*, PPOPP '03. Association for Computing Machinery, 2003. doi : 10.1145/781498.781528.
- [47] Pedro Ramalhete. Ticket lock - array of waiting nodes (awn), 2015. URL: <http://concurrencyfreaks.blogspot.com/2015/01/ticket-lock-array-of-waiting-nodes-awn.html>.
- [48] Pedro Ramalhete and Andreia Correia. Tidex: A mutual exclusion lock. In *Proceedings of the 21st ACM SIGPLAN Symposium on Principles and Practice of Parallel Programming*, PPOPP '16, 2016. URL: <http://doi.acm.org/10.1145/2851141.2851171>.
- [49] David P. Reed and Rajendra K. Kanodia. Synchronization with eventcounts and sequencers. *Commun. ACM*, 1979. URL: <http://doi.acm.org/10.1145/359060.359076>.
- [50] Michael L. Scott. *Shared-Memory Synchronization*. Morgan & Claypool Publishers, 2013. URL: <https://doi.org/10.2200/S00499ED1V01Y201304CAC023>.

- [51] U. Verner, A. Mendelson, and A. Schuster. Extending amdahl's law for multicores with turbo boost. *IEEE Computer Architecture Letters*, 2017. URL: <https://doi.org/10.1109/LCA.2015.2512982>.
- [52] Tianzheng Wang, Milind Chabbi, and Hideaki Kimura. Be my guest: Mcs lock now welcomes guests. *SIGPLAN PPOPP*, 2016. doi:10.1145/3016078.2851160.

A OPTIMIZATION: OVERLAP

To reduce the impact of waiting for receipt of transfer in the unlock operator, at Listing-1 line 20, we can apply the *Overlap* optimization which shifts and defers that waiting step until subsequent synchronization operations, allowing greater overlap between the successor and the outgoing owner.

Threads arriving in the lock operator at Listing-3 line 6 wait to ensure their Grant mailbox field does not contain a residual address from a previous contended unlock operation on that same lock, in which case it must wait for that tardy successor to fetch and clear the Grant field¹¹. In practice, waiting on this condition is rare. (If thread *T1* were to enqueue an element that contains an residual Grant value that happens to match that of the lock, then when a successor *T2* enqueues after *T1*, it will incorrectly see that address in *T1*'s grant field and then incorrectly enter the critical section, resulting in exclusion and safety failure and a corrupt chain. The check at line 6 prevents that pathology).

In Listing-3 line 16, threads wait for their own Grant field to become empty. Grant could be non-null because of previous unlock operations that wrote an address into the field, but the corresponding successor has not yet cleared the field back to null. That is, Grant is still occupied. Once Grant becomes empty, the thread then writes the address of the lock into Grant, alerting the successor and passing ownership. When ultimately destroying a thread, it is necessary to wait while the thread's Grant field to transition back to null before reclaiming the memory underlying Grant.

```

1 class Thread :
2   atomic<Lock *> Grant = null

3 class Lock :
4   atomic<Thread *> Tail = null

5 def Lock (Lock * L) :
6   while Self→Grant == L : Pause
7   auto pred = swap (&L→Tail, Self)
8   if pred ≠ null :
9     while pred→Grant ≠ L : Pause
10    pred→Grant = null
11  assert L→Tail ≠ null

12 def Unlock (Lock * L) :
13  auto v = cas (&L→Tail, Self, null)
14  assert v ≠ null
15  if v ≠ Self :
16    while Self→Grant ≠ null : Pause
17    Self→Grant = L

```

Listing 3: Hemlock with Overlap Optimization

B OPTIMIZATION: AGGRESSIVE HAND-OVER

The *Aggressive Hand-Over (AH)* optimization, shown in Listing-4, changes the code in unlock to first store the lock's address into the Grant field (Listing-4 Line 12), optimistically anticipating the existence of waiters, and then execute the atomic CAS to try to swing the Tail field back from Self to null, handling the uncontended case. If the CAS succeeded, there are no waiters, and we then reset Grant back to null and return, and otherwise wait for the successor

¹¹We thank Adrian Uffmann for identifying an error in earlier versions of this figure.

```

1 class Thread :
2   atomic<Lock *> Grant = null
3
4 class Lock :
5   atomic<Thread *> Tail = null
6
7 def Lock (Lock * L) :
8   assert Self→Grant == null
9   auto pred = swap (&L→Tail, Self)
10  if pred ≠ null :
11    while cas(&pred→Grant, L, null) ≠ L : Pause
12
13 def Unlock (Lock * L) :
14   assert Self→Grant == null
15   Self→Grant = L
16   auto v = cas (&L→Tail, Self, null)
17   if v = Self :
18     Self→Grant = null
19   return
20   while FetchAdd(&Self→Grant, 0) ≠ null : Pause

```

Listing 4: Hemlock with Aggressive Hand-Over Optimization

to clear Grant. This reorganization accomplishes handover earlier in the unlock path and improves scalability by reducing the critical path for handover. Handover time impacts the scalability as the lock is held throughout handover, increasing the effective length of the critical section [3, 27]. For uncontended locking, where there are no waiting successors, the superfluous stores to set and clear Grant are harmless to latency as the thread is likely to have the underlying cache line in *modified* state in its local cache. Listing-4 also incorporates the CTR optimization.

The contended handover critical path is extremely short – the very first statement in the unlock operator, at line 12, conveys ownership to the successor.

In unlock, after we store into the Grant field and transfer ownership, the successor may enter the critical section and even release the lock in the interval before the original owner reaches the CAS in unlock. As such, it is possible that the CAS in unlock could fetch a Tail value of null. We therefore remove the corresponding assert found in line 17 in Listing-1.

While the aggressive hand-over optimization improves contended throughput, it can lead to surprising *use-after-free* memory lifecycle pathologies and is thus not safe for general use in a pthread_mutex implementation¹².

Consider the following scenario where we have a structure instance *I* that contains a lock *L* and a reference count for *I*. The reference count, which is currently 2, is protected by *L*. Thread *T1* currently holds *L* while it accesses *I*. Thread *T2* arrives and stalls waiting to acquire *L* and access *I*. *T1* finishes accessing *I*, decrements the reference count from 2 to 1 and then calls `unlock(L)`. *T1* executes Listing-4 line 12 and then stalls. *T2* then acquires *L* and accesses *I*. When finished, *T2* reduces the reference count from 1 to 0, making note of that fact. *T2* then releases *L*, and, as the reference count transitioned to 0, and *I* should not longer be accessible or reachable, *T2* frees the memory associated with *I*, which includes *L*. *T1* resumes at line 13 and accesses *L*, resulting in a *use-after-free* error. Similar pathologies have been observed and fixed in the linux

¹²We thank Alexander Monakov and Travis Downs for reminding us of this concern

kernel lock implementation and the user-mode pthread_mutex implementations [8, 45].

Broadly, if the unlock operator has a fast-path which might release or transfer the lock, and, in the same invocation of unlock, might then subsequently access the lock body, then the lock implementation is exposed to the *use-after-free* problem. Put another way, once transfer has been effected or potentially effected, the lock implementation must not access the lock body again. In our case, the speculative hand-over store at line 12 renders the AH algorithm vulnerable.

AH remains safe and immune from *use-after-free* errors, however, in any environment where the lock body *L* can not recycle while a thread remains in `unlock(L)`. If *L* is garbage-collected or protected by safe memory reclamation techniques, such as *read-copy update* (RCU), then AH is permissible as the thread calling `Unlock(L)` holds a reference to *L* which prevents *L* from recycling. Furthermore, AH is safe if *L* resides in type-stable memory or if *L* is never deallocated, as would be the case for statically allocated locks. The AH form (with CTR) provides the best overall performance of the Hemlock family and is our preferred form when lifecycle concerns permit.

```

1 class Thread :
2   atomic<Lock *> Grant = null
3
4 class Lock :
5   atomic<Thread *> Tail = null
6
7 def Lock (Lock * L) :
8   auto pred = swap (&L→Tail, Self)
9   if pred ≠ null :
10    ## Note that we do use the value returned by the following cas()
11    cas (&pred→Grant, 0, L|1) ;
12    while cas(&pred→Grant, L, null) ≠ L : Pause
13
14 def Unlock (Lock * L) :
15   if Self→Grant == (L|1) :
16     PassLock:
17     Self→Grant = L
18     while FetchAdd(&Self→Grant, 0) == L : Pause
19     return
20   auto v = cas (&L→Tail, Self, null)
21   assert v ≠ null
22   if v ≠ Self : goto PassLock

```

Listing 5: Hemlock with Optimized Hand-Over – Variant 1

We now show additional variants that avoid *use-after-free* concerns, but which still provide the fast contended hand-over exhibited by AH.

In Listing-5 we augment the encoding of Grant to add a distinguished `L|1` state, borrowing the low-order bit of the lock address (which is otherwise 0) as a flag to indicate that a successor exists. In the unlock operator, if a thread discovers that its Grant field is `L|1` then it is certain that an immediate successor exists for *L*, in which case the thread overwrites `L|1` with *L* to pass ownership to that successor. This approach also avoids, for common modes of contention, any accesses to the lock’s Tail field in the unlock operator, further reducing coherence traffic on that coherence hotspot. By eliminating the speculative store into Grant found in AH, we avoid *use-after-free* concerns.

The form in Listing-6 checks for the existence of successors in the unlock operator by first fetching the lock’s Tail field. Successors

```

1 class Thread :
2   atomic<Lock *> Grant = null

3 class Lock :
4   atomic<Thread *> Tail = null

5 def Lock (Lock * L) :
6   assert Self→Grant == null
7   ## constant-time arrival "doorway" step
8   auto pred = swap (&L→Tail, Self)
9   if pred ≠ null :
10    ## waiting phase
11    while cas(&pred→Grant, L, null) ≠ L : Pause

12 def Unlock (Lock * L) :
13   assert Self→Grant == null
14   if L→Tail ≠ Self :
15     PassLock:
16     Self→Grant = L
17     while FetchAdd(&Self→Grant, 0) ≠ null : Pause
18     return
19   auto v = cas (&L→Tail, Self, null)
20   assert v ≠ null
21   if v ≠ Self : goto PassLock

```

Listing 6: Hemlock with Optimized Hand-Over – Variant 2

exist if and only iff the value is not equal to Self (Listing-6 line 12). This is tantamount to “polite” CAS operator that first loads the value, avoiding the futile CAS and its write invalidation when there are successors. This form is also immune to use-after-free concerns. Under contention, when there are waiting threads, the naive form incurs a futile CAS and write invalidation on the Tail field (Listing-1 line 16) in the critical path, *before* effecting transfer at line 20, while this version avoids the futile CAS.

C WAITING STRATEGIES

If desired, threads in the Hemlock slow-path (Listing-1 Line 10) could optionally be made to wait politely, voluntarily surrendering their CPU and blocking in the operating system, via constructs such as `WaitOnAddress`[44], where a waiting thread could use `WaitOnAddress` to monitor its predecessor’s Grant field.

Under Hemlock, a thread releasing a lock can determine with certainty – based on the Tail value – that successors do or do not exist, but the identity of the successor is not known to the thread calling unlock. As such, Hemlock is not immediately amenable to waiting strategies such as park-unpark [14, 15, 34] where unpark wakes a specific thread.

To allow purely local spinning and enable the use of park-unpark waiting constructs, we can replace the per-thread Grant field with a per-thread pointer to a chain of *waiting elements*, each of which represents a waiting thread. The elements on T ’s chain are T ’s immediate successors for various locks. Waiting elements contain a next field, a flag and a reference to the lock being waited on and can be allocated on-stack. Instead of busy waiting on the predecessor’s Grant field, waiting threads use CAS to push their element onto the predecessor’s chain, and then busy-wait on the flag in their element. The contended `unlock(L)` operator detaches the thread’s own chain, using SWAP of null, traverses the detached chain, and sets the flag in the element that references L . (At most one element will reference L). Any residual non-matching elements

are returned to the chain. The detach-and-scan phase repeats until a matching successor is found and ownership is transferred.