

TianheGraph: Customizing Graph Computation for Tianhe Exascale Supercomputing System

Xinbiao Gan and Yiming Zhang

Abstract—As the era of exascale supercomputing is coming, it is vital for next-generation supercomputers to find appropriate applications with high social and economic benefit. In recent years, it has been widely accepted that extremely-large graph computation is a promising killer application for supercomputing. Although Tianhe series supercomputers are leading in the world-wide competition of supercomputing (ranked No. 1 in the Top500 list for six times), previously they had been inefficient in graph computation according to the Graph500 list. This is mainly because the previous graph processing system cannot leverage the advanced hardware features of Tianhe supercomputers. To address the problem, in this paper we present our integrated optimizations for improving the graph computation performance on our next-generation exascale Tianhe supercomputing system, mainly including sorting with buffering for heavy vertices, vectorized searching with SVE (Scalable Vector Extension) on matrix2000+ CPUs, and group-based monitor communication on the proprietary interconnection network. Performance evaluation on a subset of the Tianhe exascale supercomputer (with 512 nodes and 96608 cores) shows that our customized graph processing system achieves 2131.98 GTEPS, which even outperforms the Tianhe-2 supercomputer (ranked No. 7 in Graph500 by running the state-of-the-art graph processing system) that has 16x more computing nodes.

Index Terms—Breadth-first search; exascale supercomputer; matrix2000+; group-based monitor communication; Graph500

1 INTRODUCTION

As the era of exascale supercomputing is coming, it is vital for next-generation supercomputers to find appropriate applications with high social benefit and economic profit. In recent years, it has been widely accepted that graph computation is a promising killer application for supercomputing. Various graph algorithms, like PageRank, Single-Source Shortest Path (SSSP), Connected Component, and Betweenness Centrality, have been applied in a broad range of applications including bio computation, social networks, business intelligence, and public safety, generating extremely large-scale graph datasets and necessitating the power of supercomputers for efficient data processing and analysis.

The Graph500 benchmark [3] ranks supercomputers for graph processing worldwide. Different from the Top500 benchmark which compares supercomputers using FLOPS (FLoating-point Operations Per Second) for computing intensive applications, Graph500 instead measures the graph

processing performance for data intensive applications, using the TEPS (Traversed Edges Per Second) or GTEPS (Giga TEPS) metric. The most popular test of Graph500 is the evaluation of the BFS (Breadth First Search) algorithm which can be used as the kernel for many more complex graph algorithms (like Connected Component and Betweenness Centrality). Most graph processing frameworks, such as Ligma [6], Gemini [7], Gluon [8], and TopoX [9], have been optimized for efficient processing of BFS.

Graph500 reflects the capability of supercomputers to dealing with real-life, large-scale graphs generated from practical data intensive applications. Although our Tianhe series supercomputers are leading in the world-wide competition of supercomputing (ranked No. 1 in the Top500 list for six times), previously they had been inefficient in graph computation according to the Graph500 list. This was mainly because the previous graph processing system cannot leverage the advanced hardware features of Tianhe series supercomputers and the proprietary CPUs and high-speed networks were not fully utilized when running the Graph500 benchmark. As we develop the next-generation exascale Tianhe Supercomputer, the mismatch between hardware and software designs becomes even more challenging.

Specifically, the following architectural features of the next-generation exascale Tianhe Supercomputer provide both challenges and opportunities for improving the performance of graph computation.

• Xinbiao Gan, is with the National University of Defense Technology, Changsha, 410073, China E-mail: xinbiaogan@nudt.edu.cn.

• Yiming Zhang is with the National University of Defense Technology, Changsha, 410073, China E-mail: zhangyiming@nudt.edu.cn.

Please note that all acknowledgments should be placed at the end of the paper, before the bibliography (note that corresponding authorship is not noted in affiliation box, but in acknowledgment section).

- **Vectorized Matrix-2000+ CPU with SVE.** The computing nodes (CN) install the powerful Matrix-2000+ CPUs which have SVE (Scalable Vector Extension) configured in hardware. We leverage SVE to accelerate BFS by designing synchronization-free searching algorithm which adapts to the variable width vector elements.
- **Proprietary fast interconnection network.** The Tianhe exascale Supercomputer adopts our proprietary lossless interconnection network of which the link rate is as high as 200 Gbps. To maximize the utilization of the network, we design the hybrid BFS mechanism with group-based monitor communication.

In this paper we present TianheGraph, an efficient graph processing system for the next-generation Tianhe exascale Supercomputer that not only explores the properties of BFS but also exploits the advanced hardware features of the supercomputer fully utilizing the powerful processing capability of the Tianhe Supercomputer. We have deployed TianheGraph on a subset of the Tianhe exascale Supercomputer which consists of 512 CNs with totally 96608 cores. Performance evaluation shows that the 512-node sub-system achieves 2131.98 GTEPS, which even outperforms Tianhe-2 Supercomputer (running the state-of-the-art graph processing system) that has 16x more nodes.

The remainder of this paper is organized as follows. Section 2 introduces the Graph500 benchmark (BFS) and related work. Section 3 introduces the architecture of Tianhe exascale supercomputer and the advanced features of the Matrix-2000+ CPUs and the interconnection network. Section 4 and Section 5 respectively describe our design and evaluation of TianheGraph. Section 6 discusses related work. And finally Section 7 concludes the paper and discusses future work.

2 BACKGROUND

2.1 Graph500

Different from Top500 which ranks supercomputers by comparing the Linpack benchmark with the GFLOPS metric, Graph500 ranks supercomputers by executing data-intensive graph algorithms on large-scale graphs using the GTEPS metric. There are three rankings tests in the Graph500 benchmark [3], namely, BFS, SSSP (Single Source Shortest Path) and GreenGraph500, in which BFS is the most popular one that have received the highest attention from the world. The BFS test performs the following steps [3].

Step1 (Edge Generation): This step produces an edge list using the Kronecker generator (according to recursively sub-divided adjacency matrix) into 4 partitions A, B, C, and D, and then adds edges one at a time with partition probability $A = 0.57$, $B = 0.19$, $C = 0.19$, and $D = 0.05$. This step is not counted for the Graph500 execution times.

Step2 (Graph Construction): This step constructs a suitable data structure, usually adopting the CSR (Compressed Sparse Row) graph format. Graph construction is

also not counted for the Graph500 execution times.

Step3 (BFS searching): This step is the kernel to create a BFS tree. It is the only one that will be counted for the Graph500 execution times.

Step4 (Tree validation): Finally, Graph500 verifies the result of the BFS tree produced by Step3.

Graph500 adopts GTEPS (Giga Traversed Edges Per Second) as the performance metrics. Therefore, the execution time of BFS and the total number of processed edges jointly determine the ranking of supercomputers in the Graph500 list.

The Kronecker graph generator is built inside Graph500 and produces scale-free graphs (from 64 randomly-selected roots) to model real-world graphs [4-5]. To further understand the target graphs of Graph500, we run the generator and collect statistics on the distribution of vertex degrees. The result is shown in Figure 1, where we observe two important properties. First, a large proportion of vertices are isolated vertices (with degree = 0), and the proportion increases as the scale increases. Second, there are about 5% vertices have relatively-high degrees (≥ 1000) for various graph scales.

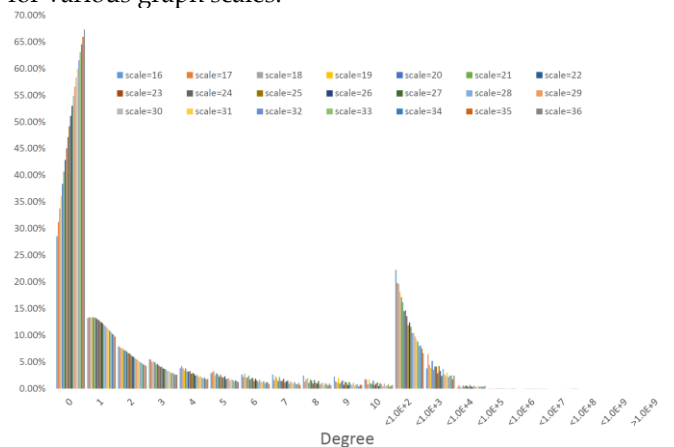

Figure 1. Distribution of vertex degree (Edge factor=16)

2.2 Parallel Hybrid BFS

The traditional BFS algorithm is a top-down traversal of a tree. In BFS, the *explored list* is the list of vertices that have already been visited, and the *frontier* is the list of vertices we know about but have not visited. The frontier is used to track which vertices will be explored next. Given the current level of the tree, the top-down approach checks each vertex v in the frontier and marks v as visited. For each neighbor w of vertex v , if w is unvisited then w will be added to the frontier at the next level; if w is already marked as visited then w will be skipped. Clearly, the top-down BFS method will generate more and more invalid detections as the level increases in the traversal, which significantly damages the performance of BFS.

To address this problem, Beamer et al. [10] proposed the bottom-up BFS algorithm for reducing invalid detections. The bottom-up BFS searches for vertices in the frontier from all unvisited vertices in the current level. If we find that a vertex v connected to an unvisited vertex w is in-

cluded in the frontier, we mark the unvisited vertex as visited. The bottom-up BFS terminates search in a current level once an unvisited vertex w is connected from a vertex v in the frontier. If so, it breaks out of the loop and ends the access to the remaining neighbor vertices, thus reducing the unnecessary detection overhead. On the down side, the bottom-up approach also has a drawback that inefficient search happens when the state of a given graph holds only a few vertices in the frontier, since the possibility of finding frontier vertices is low. Table 1 compares the difference between top-down BFS and bottom-up BFS.

Table 1. Comparison between top-down BFS and bottom-up BFS

Items	Policy	
	top-down	bottom-up
Data Structure	Bitmap & Array	Array
Compress Format	CSR	CSC
Current Level Size	Small	Big

Top-down BFS and bottom-up BFS have both advantages and disadvantages, which usually depend to the sizes of the currently-processing levels. Therefore, it is desirable to perform parallel hybrid (including both top-down and bottom-up) BFS, so as to boost the BFS performance of Graph500 benchmark. The hybrid BFS mechanism is shown in Figure 2.

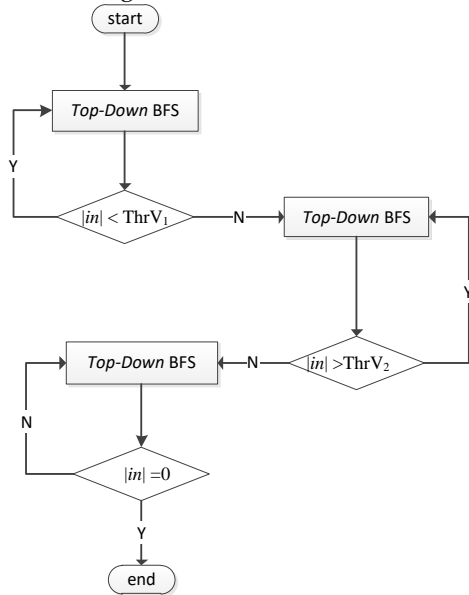

Figure 2. Flow chart of hybrid BFS

The switch between top-down BFS and bottom-up BFS is essential for hybrid BFS. In Figure 2, $|in|$ represents the number of vertices in the current level. The switching policy has two thresholds $ThrV_1$ and $ThrV_2$, which is given by the following formulas.

$$ThrV_1 = (|V| - |vis|) / \alpha \quad (1)$$

$$ThrV_2 = |V| / \beta \quad (2)$$

$|V|$ and $|vis|$ respectively denote the total numbers of vertices and visited vertices in the graph, and α and β are two configurable tuning parameters.

3 TIANHE EXASCALE SYSTEM

3.1 Architecture of Tianhe Exascale System

The next-generation Tianhe exascale supercomputing system consists of several subsystems, mainly including the computing and processing subsystem, high-speed interconnection subsystem, parallel storage subsystem, service processing subsystem, monitoring and diagnosis subsystem and infrastructure subsystem [2], as shown in Figure 3. Focusing on graph processing, this subsection will briefly introduce the computing and processing subsystem (the Matrix-2000+ CPUs) and the high-speed interconnection subsystem (the proprietary network).

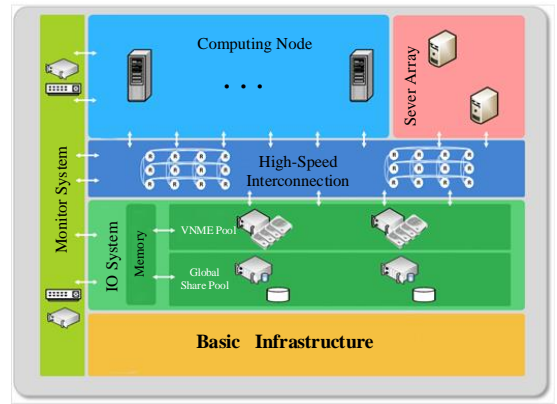

Figure 3. Architecture of Tianhe exascale supercomputing system

3.2 Compute Node with Matrix-2000+ CPUs

Powerful computing capacity is vital for fast graph processing. In the computing and processing subsystem, each Computing Node (CN) is equipped with three Matrix-2000+ CPUs [2] each of which has 128 compute cores running at 2 GHz. Each core has an in-order 8-to-12-stage pipeline extended with vectorization, resulting in eight double precision flops per cycle. Consequently, a Matrix-2000+ CPU has peak performance of 2.048 Tflops and each CN achieves peak performance of about 6 Tflops. The conceptual structure of Matrix-2000+ CPUs is illustrated as Figure 4.

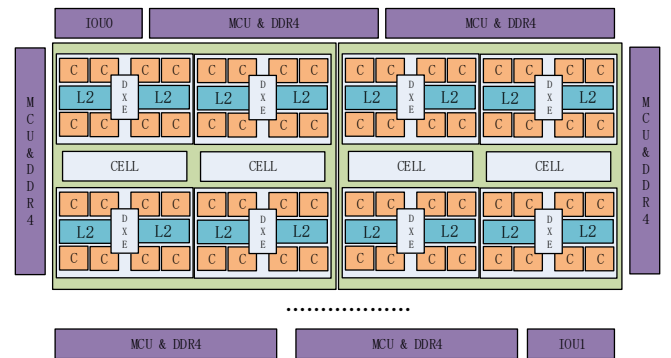

Figure 4. Structure of the half of a Matrix-2000+ CPU, with two regions (SNs) each having four panels. Each panel has 8 cores.

Matrix-2000+ CPUs adopt a regional autonomous parallel architecture where one CPU is composed of four regions connected through a scalable on-chip communication network. Each region is a functionally independent

Super-Node (SN), which has four panels communicating with each other through an intra-region interconnection interface. Each panel has eight cache-coherent compute cores. A Matrix-2000+ CPU has 8 DDR4-3200 channels integrated with PCIe 3.0 interface. Each CN has $8 \times 3 = 24$ DDR4 channels with maximum memory bandwidth of 614.4 GB/sec and maximum memory capacity of 768 GB.

The regional autonomous parallel architecture requires our system to exploit the locality of memory access of upper-layer programs for high performance and scalability. For BFS, for example, we must map the BFS communication between vertices to the group-based hierarchical structure of core organization and buffer heavy vertices to reduce inter-node communication.

3.3 Proprietary Interconnection Network

Interconnection between computing nodes plays an important role in modern supercomputers for large-scale computing tasks including the Graph500 benchmark. Recently, massively-parallel computer architecture has become popular where the underlying network connects large numbers of computing nodes and cores. For example, a subset of Tianhe exascale system (used in our evaluation in Section 5) has 96608 cores located in 8 racks. With the rapid increasing of the number of nodes and cores, fast interconnection has become crucial for supercomputing systems.

The Tianhe exascale system adopts a proprietary interconnection network [2]. The networking logic is integrated into the network interface chip (called HFI-E) and the network router chip (called HFR-E). HFI-E and HFR-E collaboratively achieve high-performance communication with regard to bandwidth, latency, reliability, and stability. The network bandwidth is upgraded to 25 GB/sec (200Gbps) from 14 GB/sec of the TianHe-2 supercomputer. HFI-E provides the software-hardware interface for accessing the network, implementing the proprietary MP/RDMA (Mini Packet/Remote Direct Memory Access) communication and collective offloading mechanism. HFI-E contains a 16-lane PCIe 3.0 interface.

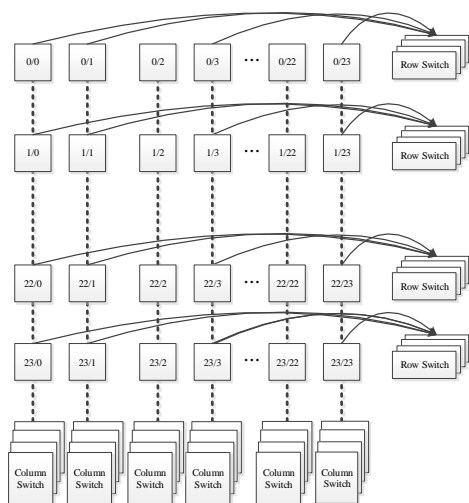

Figure 5. Network topology of Tianhe exascale system

HFR-E has 24 network ports. Each port has an eight-lane 25 Gbps SerDes interface, with 200 Gbps unidirectional bandwidth. The throughput of a single HFR-E chip is up to 9.6 Tbps, and the Message Passing Interface latency is 1.1 us. HFR-E also adopts FC-PBGA (Flip Chip-Plastic Ball Grid Array) packaging technology and supplies 2816 pins. The interconnection network adopts a two-dimensional tree network topology on the basis of optoelectronic hybrid interconnection, as shown in Figure 5. A total of 72 compute frames are connected by four communication frames using active optical cables with a two-dimensional tree network topology which is more efficient than n-D-Torus topology. The links between the adjacent nodes on each dimension are replaced with tree switches.

According to the topology of the interconnection network, the Tianhe exascale system always prefer less number of hops as well as less detours. Therefore, how to collectively gather and scatter messages through the network would determine the scalability and performance when processing extremely-large graphs on the Tianhe exascale system.

4 TIANHEGRAPH DESIGN

The special hardware features of Tianhe exascale system brings not only challenges but also opportunities for improving graph computation performance. In this section, we will introduce the design of TianheGraph, which leverage the features of our Matrix2000+ CPUs and fast Interconnection network of the Tianhe exascale system for efficient large-scale BFS.

4.1 Sorting with Buffering in Preprocessing

The two properties of Kronecker-generated graphs (discussed in Section 2.1) directly imply two optimizations for graph preprocessing of TianheGraph: isolated vertices require pruning, which has been widely studied in the literature and will not be covered in this paper; and heavy vertices need buffering, which is tightly coupled with the supercomputer architecture and will be introduced in detail in this subsection.

For BFS, the workload and communication traffic are higher for heavy vertices than for low-degree vertices. To handle this situation, TianheGraph performs sorting with buffering in the preprocessing stage. Specifically, we sort vertices according to their degree, assigning ID 0 to the vertex with the highest degree. We maintain a mapping for each vertex between its new and old IDs. The sorting helps vectorized processing of BFS, which will be discussed in the next subsection.

Further, for load balancing we design a *buffer_column* structure to steal edges of heavy vertices from the column. This is for evenly assigning the edges of a heavy vertex to all processes (and all CNs) in the system. Figure 6 presents an example of the design with two processes. First, the edges of heavy vertices are all in the local *rowstarts* of each hashed process, so as to effectively reduce the inter-node and inter-process communication. Second, the edges of each heavy vertex are assigned to all processes by hashing

(similar to hybrid-cut [11]), which avoids load imbalancing for heavy vertices.

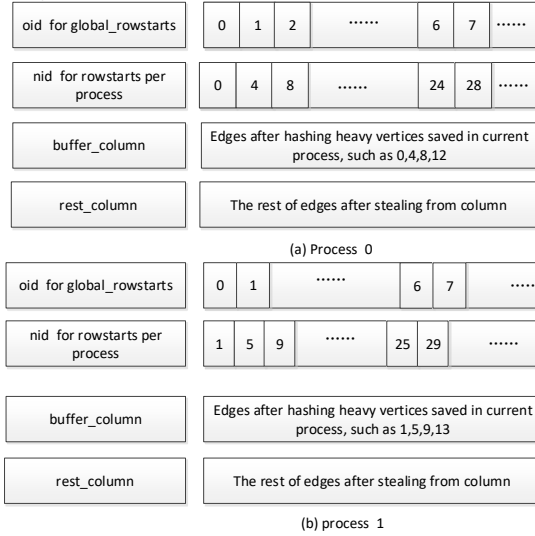

Figure 6. Sort vertices with buffering

The old IDs (*oid*) are map to new IDs (*nid*) according to the following rules.

$$nid = [oid, size] + rank \quad (3)$$

$$\begin{cases} \{column\} = \{buffer_column\} \cup \{rest_column\} \\ \{buffer_column\} \cap \{rest_column\} = \emptyset \end{cases} \quad (4)$$

The operator $[oid, size]$ means the maximum positive integer by *oid* divided by *size*, and the *rank* is the owner id for MPI process. Besides, the remaining edges after stealing is marked as *rest_column*.

The degree threshold (*D*) for buffering heavy vertex is determined as follows. The proportion of heavy vertices should be (i) large enough for effective buffering and (ii) small enough for low memory overhead. On a subset of 512 CNs (each with 192 GB memory) of the Tianhe exascale system, we experimentally find $D = 100$ is the best tradeoff achieving the highest performance (as evaluated in Section 5.3). Note that the best value of the threshold might change for different system and graph scales. For example, in the Graph500 test on Tianhe-2 with 8192 CNs, we found $D = 1000$ (resulting in about 5% heavy vertices as shown in Figure 1) is the best choice which enables Tianhe-2 to be ranked No. 7 in the latest Graph500 list.

In addition to reducing inter-CN communication, buffering heavy vertices also improves cache utilization. As shown in Figure 4, Matrix CPUs use a group-shared L2 caching mechanism. Consequently, when sorting vertices according to their degrees, heavy vertices are also in the group-shared L2 cache, which effectively accelerates the intra-group communication.

4.2 BFS with SVE

Different from the traditional SIMD technique adopted by Tianhe-2, the Matrix2000+ CPUs on Tianhe exascale system employs the SVE (Scalable Vector Extension) technique to accelerate computation by using vectors with variable sizes.

Traditional vectorization induces synchronization between processing consecutive vectors by automatically inserting stalls, which lowers the overall performance. We note that the processing of BFS at one level simply scans a vertex range to determine the vertices at the next level. Most synchronization between vectors can be eliminated only if none of the vertices belongs to more than one levels, the situation of which might exist because of the existence of loops in graphs. Therefore, in the preprocessing we could split a vertex into two virtual ones if it exists in two successive levels, and take the first processed virtual vertex as the resulting level of that vertex. Then, by leveraging SVE to pact variable length of bits (i.e., vertices to be processed), we can eliminate most synchronization operations (stalls).

As shown in Figure 4, the Matrix-2000+ CPUs adopt a regional autonomous parallel architecture composed of several regions. Each region can be viewed as a functionally-independent SN, which has SVE (Scalable Vector Extension) configured in hardware that can be used to accelerate BFS [12-17]. Rather than using a fixed vector length, SVE allows Matrix-2000+ to choose the most appropriate vector length for applications, ranging from 128 bits up to 1024 bits per vector register file. Besides, there are 16 prediction registers p0-p15. We use the last bit of each prediction register to represent the status of sub-vectors inside a vector. Taking a 256-bit vector as an example. As shown in Figure 7. When the data size of each operation is 64-bit, the first and third sub-vectors are active because the lowest bits of the two corresponding pg registers are 1, and the second and fourth sub-vectors are inactive because the lowest bits of the two corresponding pg registers are 0.

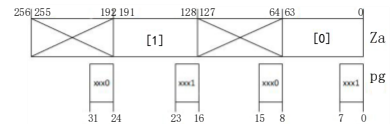

Figure 7. SVE for a 256-bit vector

The Matrix-2000+ CPUs have two usage modes namely, (i) auto vector-length agnostic (AVLA) programming model that can automatically pact sub-vectors into vectors but requires synchronization between processing of two vectors, and (ii) assembly vector-length specified (AVLS) programming model that allows programming to specify user-defined sub-vector lengths and thus enables BFS on Matrix-2000+ CPUs without synchronization.

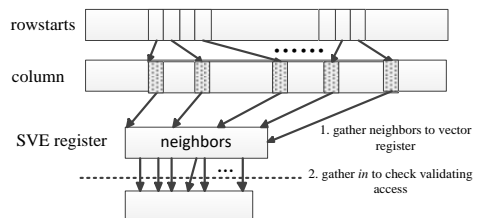

Figure 8. Vectorizing BFS with SVE

As discussed in Section 2.1, TianheGraph adopts the hybrid BFS mechanism. Since top-down BFS might encounter too many loops at the first few levels, we simply adopt

AVLA for top-down BFS to avoid too frequent vertex splitting, and mainly focus on bottom-up BFS for which we adopt AVLS to avoid synchronization. In bottom-up BFS, every thread (core) handles a different vertex range and examines the edges connected to unvisited vertices, determining if the neighbor vertices should be visited on the next level. We pack the neighbors into the vectors through AVLS (as illustrated in Figure 8), and resolve loops through splitting.

4.3 Group-based monitor communication

Without communication optimization, there would be a large amount of messages for BFS on supercomputers, which might be overwhelming for the underlying interconnection network. Simple evaluation on our 512-CN subsystem without communication optimization shows that over 95% messages traverse more than one hops (i.e., cross multiple HFR-E controllers) and many of them may traverse as many as ten hops, which tends to exhaust the network capacity.

In order to shorten the communication paths, we organized the CNs attached to the same HFR-E controller into a one group. Owing to the highly-optimized routing mechanism of our proprietary HFR-E controllers, the overhead of intra-group communication is much lower than that of inter-group communication. Therefore, we propose the group-based monitor communication to minimize the expected numbers of hops in BFS communication.

In each group, a CN which buffers heavy vertices in the *buffer_column* structure (Section 4.1) would be voted as a monitor. Messages between different groups should be forwarded by monitors. Figure 9 shows examples of the group-based monitor communication, where CNs attached to the same HFR-E controller belong to the same group, e.g., A, B, C and D are in group 0. CNs with the same color but in different groups can be voted as monitors and configured by HFR-E controller to form a *mirror group* for efficient communication.

For example, there are three messages for the top-down BFS, including message₁ <C0, A>, message₂ <D0, A1> and message₃ <D0, A2> listed in Figure 9(a), where, e.g., message <C0, A1> represents message from CN C in group 0 to CN A in group 1. When group-based monitor communication is applied to the messages listed in Figure 9(a), message exchanging will be optimized with two steps. First, checking and voting monitor to form a new mirror groups. For example, CNs with green color are voted as monitors configured as a new mirror group. Second, message₁ <C0, A1> will be transformed into <C0, A0> and <A0, A1>, so that the message from CN 0 could be collected by monitor CN A in group 0, and then forwarded from monitor CN A in group 0 to the monitor in group 1. Because the monitors of group 0 and group 1 are both buffered in a CN, traversal hops for message₁ <C0, A1> would be reduced as <C0, A0> in a group and <A0, A1> in a mirror group. Similarly, message₂ <D0, A1> can be transformed into <D0, A0> and <A0, A1>, and message₃ <D0, A2> into <D0, A0> and <A0, A2>. Clearly, the inter-

group message <A0, A1> can serve message₁ and message₂ in a batch. Note that the bottom-up BFS has a reverse direction. As shown in Figure 9(b), for example, Message <D0, A2> in the bottom-up BFS can be optimized as two sub-messages <A2, D2> and <D2, D0>.

The selection of monitors should satisfy the following requirements. First, heavy vertices should be placed in monitor CNs. Second, heavy vertices should be buffered in the same CN or different CNs attached to the same HFR-E controller as many as possible. We propose the Orchestra vote policy, which selects monitors according to the proportions of heavy vertices on CNs. Section 5.4 will compare the Orchestra policy with other policies.

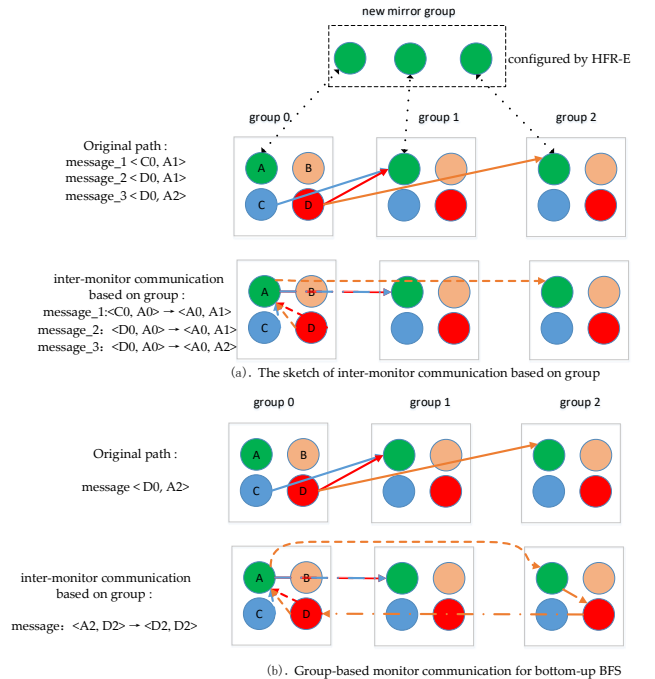

Figure 9. Group-based inter-monitor communication

5 EVALUATION

5.1 Experimental Setup

We have implemented TianheGraph by using MPI plus embedded assembly programming model, where MPI runs on computing nodes (CNs) with embedded assembly carefully orchestrated for SVE on Matrix-2000+ CPUs.

Table 2. Configuration for running Graph500 on TianheGraph

Architecture	Parameters	Notes
No. of Nodes	512	
CPU	2 GHz	Matrix2000+
Cores/Node	384	3x128
No. of Cores	196608	
Memory per Node	192 GB	
Total	98304 GB	
Interconnection	200 Gbps	TH-Ex2

In order to validate the proposed optimizations of TianheGraph for the Graph500 benchmark on Tianhe exascale

system, the main experimental configurations are listed in table 2. If not specified, we use the default edge factor (16) of Graph500. Our evaluation is conducted for various numbers of CNs, and (if not specified) the graph scale for each number is the *best* one which achieves the highest performance (GTEPS) for all tested systems: 4, 16, 32, 64, 256, and 512 CNs correspond to graph scales 30, 32, 33, 34, 36, and 37, respectively.

5.5 Overall Performance

We first compare the overall Graph500 performance of TianheGraph to that of the graph processing systems of Tianhe-2 and K computer, as well as the default BFS implementation (i.e., reference-3.0.0) of Graph500 adopting AML (Active Messages Library) as introduced in Section 6, on a subset (512 CNs) of the Tianhe exascale system. The number of CNs increases from 16 (with 6144 cores) up to 512 (with 196,608 cores).

The result is shown in Figure 10, where Rference 3.0.0, TH-2, and K represent reference-3.0.0 with AML, Tianhe-2, and K computer, respectively. TianheGraph achieves the best performance among all graph processing systems, because it is highly optimized for the architectural features of the Matrix2000+ CPUs and the interconnection network. The peak performance of TianheGraph on the 512-CN subset is 2131.98 GTEPS, which is even higher than that of our previous graph processing system on the Tianhe-2 supercomputer which has 8192 computing nodes (16x the number of the testing subset).

Figure 10 also shows the speedups of TianheGraph compared to the graph processing system of K computer, which increases as the number of CNs increases up to 256. The slight decrease of the ratio (when the number of CNs increases from 256 to 512) implies potential optimization opportunities of the scalability of TianheGraph, which will be studied in our future work.

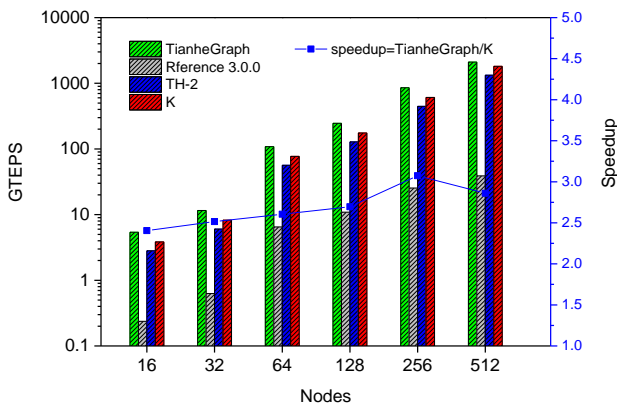

Figure 10. Overall performance comparison.

5.2 BFS with SVE on Single Node

BFS on single CN is the basis for large-scale Graph500 testing on Tianhe exascale system. The GTEPS metric is limited by the computing capacity of the CPUs (matrix2000+) as well as the graph traversal parallelism. In this section we compare the single-CN performance of the two usage modes (AVLA and AVLS) using different numbers

of running cores and different scales. The scale of the generated graphs are respectively 16, 26, and 30.

The result is shown in Figure 11. As the number of cores used in the Matrix2000+ CPU increases, the GTEPS of both AVLA and AVLS both increases first, but the performance on 64 cores is slightly lower than that on 16 cores. This is because for 64 cores the performance is bottlenecked by the expensive registers. Clearly, the performance of AVLS is much better than that of AVLA, owing to the SVE-accelerated vectorization (with carefully orchestrating embedded assembly).

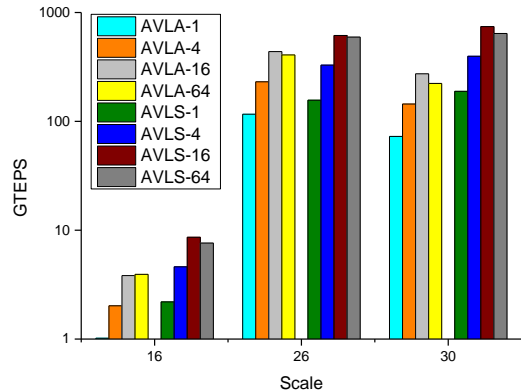

Figure 11. Performance testing for SVE on Matrix2000+. Y-axis uses log scale.

We also compare the two usage modes of Matrix2000+ with two BFS implementations, namely, reference-3.0.0 of Graph500 and SMARCO&ICT (ranked No. 1 in the latest GreenGraph500 list) [3, 18-19].

The performance comparison is demonstrated in Figure 12. The results of SMARCO&ICT are from the latest GreenGraph500 list (released in Nov. 2020). Note that Figure 12 has result for SMARCO&ICT when scale is 16 because no data is released. Figure 11 shows that the performance of the Matrix2000+ customized AVLA and AVLS is significantly higher than that of SMARCO&ICT (with similar energy cost not shown in this figure), and outperforms reference-3.0.0 by almost two orders of magnitude.

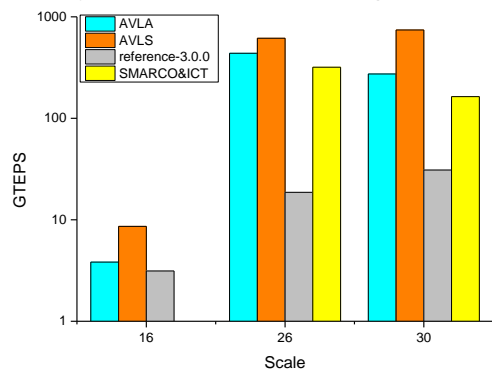

Figure 12. Performance Comparison on single node. Y-axis uses log scale.

5.3 Sorting with Buffering

Vertex sorting is vital for efficient graph processing on TianheGraph, and buffering high-degree vertices effectively reduces processing times of real-world and

Graph500-generated graphs with power-law degree distribution.

In this subsection, we first compare the performance of TianheGraph with and without vertex sorting, as the number of CNs increases from 1 to 512. The result is shown in Figure 13, where the performance with sorting is about two times higher than that without sorting, demonstrating the importance of vertex sorting.

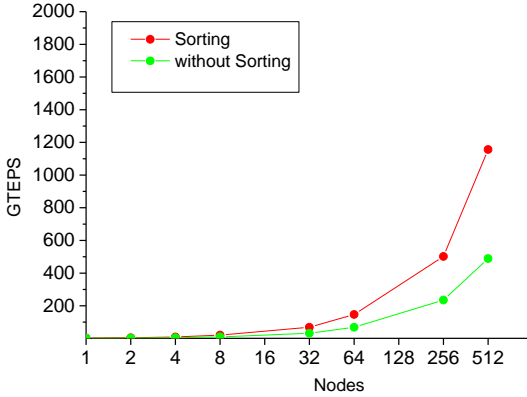

Figure 13. Sorting vs. no sorting

We also evaluate the overhead of TianheGraph adopting various vertex sorting methods (including merge sorting, quick sorting, and bubble sorting), as the number of CNs increases from 1 to 512. The result is shown in Figure 14, where the overheads with different sorting methods are different. The merge sorting method is obviously better than quick sorting, which is subsequently slightly better than bubble sorting. The main reason is that the time and space complexity of merge sorting is lower than others, and merge sorting is easy to be parallelized through vectorization, which gives a broader range of opportunities for vector optimization on Matrix2000+. As the number of nodes increases the overhead advantage of merge sorting becomes more significant, because merge sorting has better scalability. Consequently, TianheGraph uses merge sorting as the default sorting method.

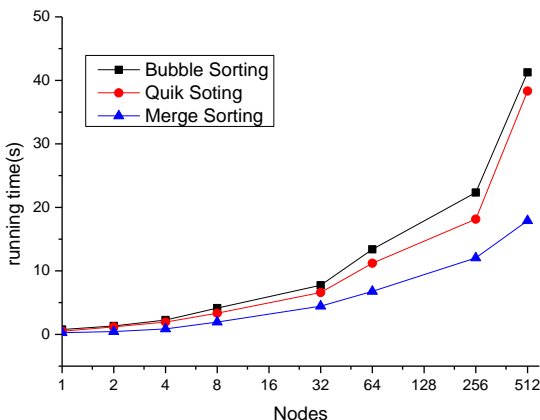

Figure 14. Overhead various vertex sorting methods

Besides the performance benefit, sorting also introduces preprocessing cost which should be take into consideration. We measure the benefit (saved execution times) and cost

(sorting times), and calculate the cost-benefit ratio, for different numbers of CNs ranging from 1 to 512. The result is shown in Figure 15, where the cost-benefit ratio first increases and then slightly decreases as the number of CNs increases. The ratio (benefit/cost) tends to be stable after the number of CNs is higher than 64. Therefore, vertex sorting is an effective preprocessing step for large-scale parallel BFS to improve the performance in the Graph500 testing.

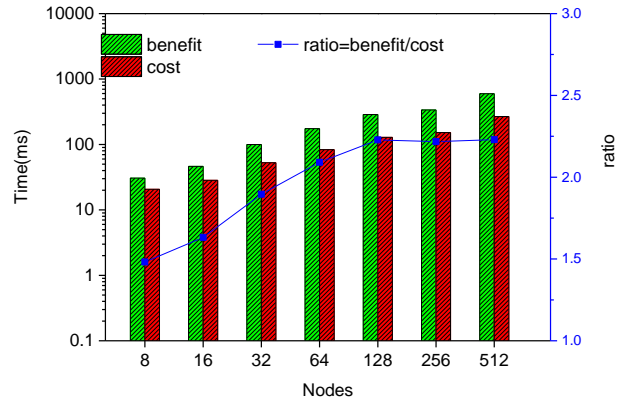

Figure 15. Benefit-cost evaluation on Sorting

We then evaluate the effectiveness of heavy vertices clustering and buffering with various buffering thresholds (50, 100, and 1000), as the number of CNs increases from 32 to 512. The result is shown in Figure 16, where we also include the performance without buffering for reference.

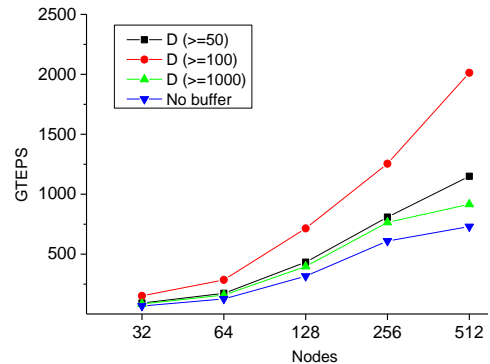

Figure 16. Buffering heavy vertices with different degree of vertex

The thresholds $D \geq 50$, $D \geq 100$ and $D \geq 1000$ represent buffering the vertices of which the degrees are greater than or equal to 50, 100 and 1000, respectively. First, buffering heavy vertices greatly improves the performance. The reason is that heavy vertices clustering and buffering improves locality in BFS and reduce redundant communications among CNs. Second, $D \geq 100$ is better than $D \geq 50$ and $D \geq 1000$, and the advantage increases sharply as the number of CNs increases. The reason is that (i) $D \geq 50$ leads to too high percent of buffered vertices which consumes more memory and results in more synchronization; and (ii) $D \geq 1000$ leads to too low percent of buffered vertices which causes poor locality in BFS and longer communication paths. The best choice for the threshold is determined by both software and hardware factors such as

graph scale, system scale, memory size, cache size, network bandwidth and latency, etc., which are beyond the scope of this paper.

5.4 Group-Based Monitor Communication

The efficiency of communication determines the scalability of supercomputers [19-21]. The collective communication approach of MPI is not suitable for graph traversal [38]. Therefore, TianheGraph designs its own communication mechanism with three objectives, namely, packing small messages to improve bandwidth utilization, minimizing traversal path hops to reduce communication amount, and dividing heavy vertices among CNs for loading balancing. As a result, group-based monitor communication is proposed in TianheGraph, which (i) packs small messages using monitors, (ii) reduces message exchange between CNs attached to different network routers (i.e., HFR-E controllers) via group-based monitor communication, and (iii) hashes heavy vertices to all CNs.

In this subsection, we first compare different policies on choosing monitors, namely, (i) Random policy, which selects a group monitor randomly from the nodes attached to heavy vertices, (2) Heaviest policy, which chooses the node attached to the heaviest vertex as a monitor, (3) Orchestra policy, which selects monitors carefully according to the proportion of heavy vertices.

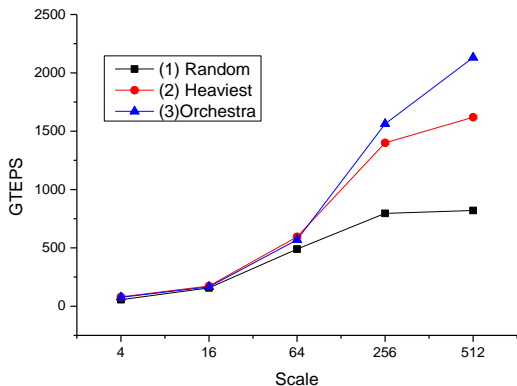

Figure 17. Graph500 running with different monitor policy

Figure 17 compares the performance of the three policies, as the number of CNs increases from 4 to 512. The result shows that monitor voting policy has important impact on the performance and scalability of Graph500. First, Orchestra achieves the best scalability and GTEPS when the number of CNs is higher than 64. Second, heaviest is better than Random.

We then measure the reduction in hops of message routing path, which is accumulated by equation (5), where acc_hops is the accumulative number of hops traversed, HNR_hops and NRM_hops are the numbers of hops in routing chips and switchboards respectively, and BOB_hops and Cab_hops are the numbers of hops in Bunch of Blades and Cabs respectively.

$$acc_hops = HNR_hops + NRM_hops + BOB_hops + Cab_hops \quad (5)$$

Figure 18 shows the accumulative numbers of hops of the three policies. We also include the result for the default BFS without groups/monitors for reference. First, all group-based monitor communication policies are better than the default BFS. Second, Orchestra performs the best among the three policies, the advantage of which increases as the number of CNs increases.

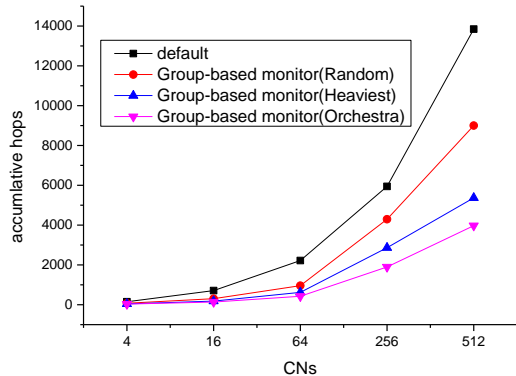

Figure 18. Accumulative hops with different monitor policy

We further evaluate the ratios of execution times of computation, communication, and synchronization/stall, respectively for the three policies and the default BFS of Graph500, for TianheGraph on 512 CNs running Graph500 at scale = 37. The result is shown in Figure 19. The result shows that (i) the group-based monitor communication policies effectively reduce the communication cost, and (ii) Orchestra is more effective than Heaviest and Random in communication efficiency.

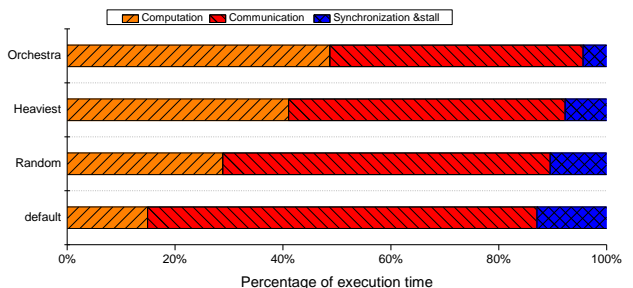

Figure 19. Execution time breakdown

We define *communication efficiency* by the following formula (6), in which $Comm_Efficiency$ represents the efficiency of communication, $Comm_Volume$ is the total communication message volume, and $Comm_Time$ is the time for message transfer.

$$Comm_Efficiency = comm_Volume / Comm_Time \quad (6)$$

We compare the communication efficiencies of TianheGraph and the default BFS implementation of Graph500, which adopts AML. The result is shown in Figure 20, where the efficiency of TianheGraph is significantly higher than that of the default BFS with AML. The advantage of TianheGraph increases as the graph scale increases, demonstrating TianheGraph has higher scalability than the default BFS of Graph500.

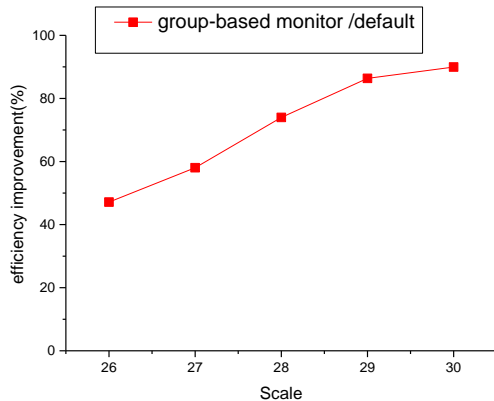

Figure 20. Efficiency improvement of group-based monitor communication of TianheGraph, compared to the default BFS of Graph500.

5.5 TianheGraph for SSSP

TianheGraph can also support other graph algorithms like SSSP. In this subsection, we compare the performance of TianheGraph and the default SSSP of Graph500 (adopting AML), as the number of CNs increases from 16 to 512. The result is shown in Figure 21, where the GTEPS of TianheGraph is about 20x that of the default SSSP. Note that TianheGraph is not fully optimized for SSSP and we expect higher speedups of TianheGraph after further optimization.

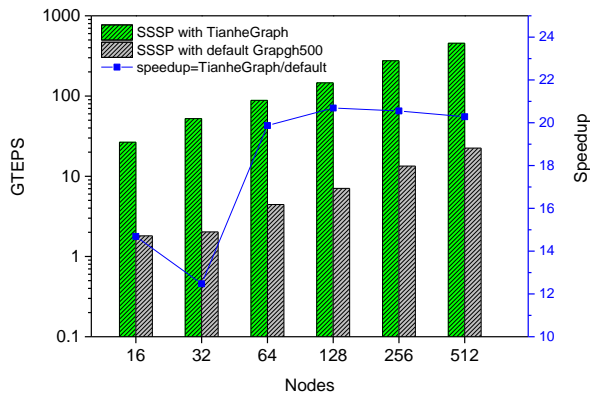

Figure 21. TianheGraph vs. default SSSP

6 RELATED WORK

BFS is the representative graph algorithm for Graph500. Currently most supercomputers run BFS as the Graph500 benchmark. Algorithm optimization is challenging for running large-scale BFS for ranking supercomputers. An important milestone is the direction optimization proposed by Beamer et al [9], which effectively decreases memory access and boosts the performance Graph500 by an order of magnitude. Fujisawa et al presented insight into the features of graphs and proposed a promising vertex reordering mechanism, which also significantly improved the Graph500 performance. Following vertex reordering, many studies on degree-aware optimization and vertex-sorting are conducted for Graph500 testing.

Large graphs (i.e., large parameters for graph scale) are

preferred in the Graph500 benchmark using the GTEPS metric. Therefore, memory footprint reduction is a key optimization path for supercomputers to win in the Graph500 ranking. The mainstream strategy is to employ the CSR (Compressed Sparse Row) format built in the Graph500 benchmark to describe adjacency matrix. Several variations from CSR are proposed for concisely describing the graphs. In addition, bitmap-based sparse matrix representation has been designed to further reduce memory footprint which achieves nearly 60% reduction according to Ueno et al [22-23].

Communication optimization is important for scalable BFS in the Graph500 testing [24-29] in that modern supercomputers are massive parallel systems with large numbers of computing nodes/cores. Fuentes et al [24-25] characterized Graph500 communication demands and used compression schemes to reduce communication overhead. Communication for 2D-partitioned graphs is optimized to scale BFS which reduces column frontier queue data by up to 91% [26-27]. Communication pipeline is provided by Chen et al [28-29] to achieve high performance on Sunway TaihuLight supercomputer.

Architectural optimization is to exploit the hardware designs of target supercomputers for fast graph processing, represented by Tianhe, Sunway TaihuLight, K, and Fugaku supercomputers [23, 26-27, 30-37]. For example, Graph500 on Tianhe have utilized the hardware prefetching and leveraged the routing topology of fat-tree to improve the performance [2, 38, 39], which can be viewed as the preliminary design of this paper. Ueno et al proposed an efficient BFS algorithm based on Tofu network configured in K computer, which won the best graph500 performance by achieving 38621.4 GTEPS [23, 27, 32]. They retained the advantage in Graph500 to Fugaku [31]. A scalable graph traverse method on Sunway TaihuLight and a Shentu framework is proposed by Lin et al [23-24]. For scaling Graph500 to Sunway TaihuLight, researchers fully explored architectural details of SW26010 CPU, shared memory among MPEs and CPEs, and Network topology of TaihuLight. Although these studies exploited architectural optimization for efficient graph processing, TianheGraph is different from them in that our CPUs and interconnection network have their distinct features. Compared to these studies, how to leverage the Matrix2000+ CPUs and proprietary interconnection network to boost graph processing on Tianhe exascale system is the main contribution of this paper.

MPI (Message Passing Interface) is the predominant parallel programming model for supercomputers today, making it a key technology to be optimized. Autoperf is created and some insights are gathered from detailed analysis of the MPI usage logs, which reveal that large-scale applications running on supercomputers tend to use more communication and parallelism. While MPI library does not behavior well and performs discrepancy vary from supercomputers from different vendors. M. Blocksome et.al designed and implemented a one-sided communication interface for the IBM Blue Gene/L supercomputer [40],

which improved the maximum bandwidth by a factor of three. Furthermore, Sameer Kumar et.al presented several optimizations by extensively exploiting IBM Blue Gene/P interconnection networks and hardware features and enhancements to achieve near-peak performance across many collectives for MPI collective communication on Blue Gene/P [41]. Motivated for better support of task mapping for Blue Gene/L super-computer, a topology mapping library is used in BG/L MPI library for improving communication performance and scalability of applications [42]. Moreover, Kumar et.al presented PAMI (Parallel Active Message Interface) as Blue Gene/Q communication library solution to the many challenges with massive parallelism and scale [43]. In order to optimize the performance of large-scale applications on supercomputers. IBM developed LAPI (Low-level Applications Programming Interface), which is a low-level, high-performance communication interface available on the IBM RS/6000 SP system [44]. It provides an active message-like interface along with remote memory copy and synchronization functionality. However, the limited set from LAPI does not compromise on functionality expected on a communication API, what's worse is that topology mapping library and LAPI is de-signed for IBM supercomputers, resulting in difficulties in adaptation to applications running on general super-computers, especially for Graph500 testing on other supercomputers.

Different from communication optimizations on IBM supercomputers, Naoyuki Shida et.al implemented a customized MPI library and low-level communication at topology level based on open MPI for K super-computer [45, 46]. Similar with IBM supercomputers, above proposed MPI implementation is target at K supercomputer. For insight into performance influence on Graph500 from MPI communication, Mingzhe Li et.al presented a detailed analysis of MPI Send/Recv and MPI-2 RMA based on Graph500 and exposed performance bottle-necks, furthermore, they proposed a scalable and high performance design of Graph500 using MPI-3 RMA to improve GTEPS and win two times speedup on TACC Stampede Cluster [47]. But, above analysis and efficient usage optimization on MPI are hardly established into a general Communication Library for Graph500 testing.

Anton Korzh from Graph500 executive committee integrated AML (Active Messages Library) [48] into the Graph500 reference code. AML is an SPMD (Single Program Multiple Data) communication library built on top of MPI3 intended to be used in fine grain applications like Graph500. AML also makes user code clearer while delivering high performance.

7 CONCLUSION

Graph have gained much attention in the past few years. Graph computation on supercomputers presents high demands for high-performance CPUs and networks, as well as architectural optimization for effectively processing huge numbers of vertices and edges. Graph500 is the standard benchmark to rank supercomputing systems for

their ability to processing data-intensive graph applications.

In this paper we present TianheGraph, a Tianhe-optimized graph processing system for Graph500. TianheGraph orchestrates embedding assembly on SVE for Matrix200+, caches heavy vertices, and realizes group-based monitor communication for Tianhe exascale system. On a 512-node testbed of the Tianhe exascale system, TianheGraph has achieved more than 3 times speedup over previous best techniques on the same testbed. Specifically, TianheGraph scales to all the 396608 cores of the 512 nodes and achieves 2131.98 GTEPS.

As evaluated on our 512-node testbed, communication still accounts for a considerable proportion in the execution time. This potentially becomes even more challenging on the complete Tianhe exascale system. In our future work, as the number of computing nodes increases, architectural optimization is still our focus. Further, BFS scalability with customized communication library (similar with the Active Message Library [48]) will also be studied in our future work.

REFERENCES

- [1] Top500: <http://www.top500.org/>.
- [2] Graph500: <http://www.graph500.org/>.
- [3] Erik Vermij, Leandro Fiorin, Christoph Hagleitner and Koen Bertels. "Boosting the efficiency of HPCG and Graph500 with near-data processing". In Proceedings of the 46th International Conference on Parallel Processing, 2017.
- [4] Pablo Fuentes, Enrique Vallejo, Jose Luis Bosque, etc. "Synthetic Traffic Model of the Graph500 Communications". In Proceedings of the International Conference on Algorithms and Architectures for Parallel Processing, 2016.
- [5] Julian Shun and Guy E. Blelloch. "Ligra: a lightweight graph processing framework for shared memory". In Proceedings of the ACM SIGPLAN Symp. Principles and Practice of Parallel Programming (PPoPP), 2013.
- [6] Xiaowei Zhu, Wenguang Chen, Weimin Zheng, and Xiaosong Ma. "Gemini: A Computation-centric Distributed Graph Processing System". In Proceedings of the 12th USENIX Conference on Operating Systems Design and Implementation (OSDI), 2016.
- [7] Roshan Dathathri, Gurbinder Gill, Loc Hoang. "Gluon: A Communication-Optimizing Substrate for Distributed Heterogeneous Graph Analytics". In Proceedings of the ACM SIGPLAN Conference on Programming Language Design and Implementation (PLDI), 2018.
- [8] Yiming Zhang, Haonan Wang, Menghan Jia, Jinyan Wang, Dongsheng Li, Guangtao Xue, Kian-Lee Tan. "TopoX: Topology Refactorization for Minimizing Network Communication in Graph Computations". IEEE/ACM Transactions on Networking, 28(6): 2768-2782.
- [9] Scott Beamer, Krste Asanović and David Patterson. "Directionoptimizing breadth-first search". In Proceedings of the International Conference on High Performance Computing, Networking, Storage and Analysis, 2012.
- [10] Rong Chen, Jiaxin Shi, Yanzhe Chen, Binyu Zang, Haibing Guan, Haibo Chen. "PowerLyra: Differentiated Graph Computation and Partitioning on Skewed Graphs". ACM Trans. Parallel Comput. 5(3): 13:1-13:39 (2018).
- [11] Maciej Besta1y, Florian Marending1y, Edgar Solomonik and Torsten Hoefler. "SlimSell: A Vectorizable Graph Representation for Breadth-First Search". In Proceedings of the Parallel & Distributed Processing Symposium, 2017.
- [12] Milan Stanic, Oscar Palomar, Ivan Ratkovic, Milovan Duric, Osman Unsal, Adrian Cristal and Mateo Valero. "Evaluation of Vectorization

- Potential of Graph500 on Intel's Xeon Phi". In Proceedings of the International Conference on High Performance Computing & Simulation (HPCS), 2014.
- [13] Zehan Cui, Licheng Chen, Mingyu Chen, Yungang Bao, Yongbing Huang and Huiwei Lv. "Evaluation and Optimization of Breadth-First Search on NUMA Cluster". In Proceedings of the IEEE International Conference on Cluster Computing, 2012.
- [14] Samuel D. Pollard and Boyana Norris. "A Comparison of Parallel Graph Processing Implementations". In Proceedings of the IEEE International Conference on Cluster Computing (CLUSTER), 2017.
- [15] Roger Pearce "Triangle Counting for Scale-Free Graphs at Scale in Distributed Memory". In Proceedings of the IEEE High Performance Extreme Computing Conference (HPEC), 2017.
- [16] Takuji Mitsuishi, Takahiro Kaneda, Sunao Torii and Hideharu Amano. "Implementing Breadth-First Search on a compact supercomputer Suiren". In Proceedings of the Fourth International Symposium on Computing and Networking, 2016.
- [17] Mingzhe Li, Xiaoyi Lu, Sreeram Potluri, Khaled Hamidouche and Jithin Jose. "Scalable Graph500 Design with MPI-3 RMA". In Proceedings of the IEEE International Conference On Cluster Computing (CLUSTER), 2014.
- [18] Fabien Chaix, Ikki Fujiwara and Michihiro Koibuchi. "Suitability of the random topology for HPC applications". In Proceedings of the 24th Euro-micro International Conference on Parallel, Distributed, and Network-Based Processing, 2016.
- [19] Nadathur Satish, Changkyu Kim, Jatin Chhugani and Pradeep Dubey. "Large-Scale Energy-Efficient Graph Traversal: A Path to Efficient Data-Intensive Supercomputing". In Proceedings of the International Conference for High Performance Computing, Networking, Storage and Analysis (SC), 2012.
- [20] Huiwei Lu, Guangming Tan, Mingyu Chen and Ninghui Sun. "Reducing Communication in Parallel Breadth-First Search on Distributed Memory Systems". In Proceedings of the IEEE International Conference on Computational Science and Engineering, 2014.
- [21] Fabio Checconi, Fabrizio Petrini. "Traversing Trillions of Edges in Real-time: Graph Exploration on Large-scale Parallel Machines". Parallel and Distributed Processing Symposium, 2014.
- [22] Koji Ueno and Toyotaro Suzumura "Highly Scalable Graph Search for the Graph500 Benchmark". In Proceedings of the 21st International ACM Symposium on High-Performance Parallel and Distributed Computing, 2012.
- [23] Pablo Fuentes, Mariano Benito, Enrique Vallejo, Jos'e Luis Bosque and Ram'on. "A scalable synthetic traffic model of Graph500 for computer-networks analysis". Concurrency and Computation Practice and Experience, 2017, 29(6684): 4231.
- [24] Pablo Fuentes, Jos'e Luis Bosque and Ram'on Bevide. "Characterizing the Communication Demands of the Graph500 Benchmark on a Commodity Cluster". In Proceedings of the IEEE/ACM International Symposium on Big Data Computing, 2014.
- [25] Toyotaro Suzumura, Koji Ueno, Hitoshi Sato, Katsuki Fujisawa and Satoshi Matsuoka. "Performance Characteristics of Graph500 on Large-Scale Distributed Environment". In Proceedings of the IEEE International Symposium on Workload Characterization (IISWC), 2011.
- [26] Koji Ueno and Toyotaro Suzumura. "2D Partitioning Based Graph Search for the Graph500 Benchmark". In Proceedings of the IEEE 26th International Parallel and Distributed Processing Symposium Workshops & PhD Forum, 2012.
- [27] Heng Lin, Xiongchao Tang, Bowen Yu, Youwei Zhuo, Wenguang Chen, Jidong Zhai, Wanwang Yin and Weimin Zheng. "Scalable Graph Traversal on Sunway TaihuLight with Ten Million Cores". In Proceedings of the IEEE International Parallel and Distributed Processing Symposium (IPDPS), 2017.
- [28] Heng Lin, Xiaowei Zhu, Bowen Yu, Xiongchao Tang, Wei Xue, Wenguang Chen, Lufei Zhang, Torsten Hoefler, Xiaosong Ma, Xin Liu, Weimin Zheng, and Jingfang Xu. 2018. ShenTu: processing multi-trillion edge graphs on millions of cores in seconds. In Proceedings of the International Conference for High Performance Computing, Networking, Storage, and Analysis (SC '18), 2018.
- [29] Yuichiro Yasui and Katsuki Fujisawa. "Fast and scalable NUMA-based thread parallel breadth-first search". In Proceedings of the International Conference on High Performance Computing & Simulation, 2015.
- [30] Yuichiro Yasui, Katsuki Fujisawa and Kazushige Goto. "NUMA-optimized Parallel Breadth-first Search on Multicore Single-node System". In Proceedings of the IEEE International Conference on Big Data, 2013.
- [31] Yuichiro Yasui and Katsuki Fujisawa. "Fast and scalable NUMA-based thread parallel breadth-first search". In Proceedings of the International Conference on High Performance Computing & Simulation, 2015.
- [32] Yuichiro Yasui, Katsuki Fujisawa and Kazushige Goto. "NUMA-optimized Parallel Breadth-first Search on Multicore Single-node System". In Proceedings of the IEEE International Conference on Big Data, 2013.
- [33] Koji Ueno, Toyotaro Suzumura and Naoya Maruyama. "Extreme Scale Breadth-First Search on Supercomputers". In Proceedings of the IEEE International Conference on Big Data, 2016.
- [34] Masahiro Nakao, Koji Ueno, Katsuki Fujisawa, Yuetsu Kodama and Mitsuhi Sato. "Performance Evaluation of Supercomputer Fugaku using Breadth-First Search Benchmark in Graph500". In Proceedings of the IEEE International Conference on Cluster Computing (CLUSTER), 2020.
- [35] Koji Ueno and Toyotaro Suzumura. "2D Partitioning Based Graph Search for the Graph500 Benchmark". In Proceedings of the IEEE 26th International Parallel and Distributed Processing Symposium Workshops & PhD Forum, 2012.
- [36] Keita Iwabuchi, Hitoshi Sato, Yuichiro Yasui, Katsuki Fujisawa and Satoshi Matsuoka. "NVM-based Hybrid BFS with Memory Efficient Data Structure". In Proceedings of the IEEE International Conference on Big Data, 2014.
- [37] Tao Gao, Yutong Lu, Baida Zhang and Guang Suo. "Using the Intel Many Integrated Core to accelerate graph traversal". International Journal of High Performance Computing Applications. 2014, Vol. 28(3):255-266.
- [38] Gao Tao, Lu Yutong and Suo Guang. "Using MIC to Accelerate a Typical Data-Intensive Application: The Breadth-first Search". In Proceedings of the IEEE International Symposium on Parallel & Distributed Processing, Workshops and Phd Forum, 2013.
- [39] Chenxu Wang, Yutong Lu, Baida Zhang, Tao Gao and Peng Cheng. "An optimized BFS algorithm: A path to load balancing in MIC". In Proceedings of the IEEE International Conference on Computer and Communications, 2015.
- [40] M. Blocksome, C. Archer, T. Inglett, et al. "Design and Implementation of a One-Sided Communication Interface for the IBM eServer Blue Gene Supercomputer". In Proceedings of the 2006 ACM/IEEE SC'06 Conference (SC'06), 2006.
- [41] Ahmad Faraj, Sameer Kumar, Brian Smith, et al. "MPI Collective Communications on The Blue Gene/P Supercomputer: Algorithms and Optimizations". In Proceedings of the 17th IEEE Symposium on High Performance Interconnects, 2009.
- [42] Hao Yu, I-Hsin Chung, Jose Moreira. "Topology Mapping for Blue Gene/L Supercomputer". In Proceedings of the 2006 ACM/IEEE SC'06 Conference (SC'06).
- [43] Sameer Kumar, Amith R. Mamidala, Daniel A. Faraj, et al. "PAMI: A Parallel Active Message Interface for the Blue Gene/Q Supercomputer". In proceedings of the IEEE 26th International Parallel and Distributed Processing Symposium, 2012.
- [44] Gautam Shah, Jarek Nieplocha, Jamshed Mirza, et al. "Performance and Experience with LAPI - a New High-Performance Communication Library for the IBM RS/6000 SP". In proceedings of the First Merged International Parallel Processing Symposium and Symposium on Parallel and Distributed Processing. 1998.
- [45] Naoyuki Shida, shinji Sumimoto, Atsuya Uno. "MPI Library and Low-Levemcommunication on the K computer". FUJISU sci.tech.J., vol.48, No.3, 2012.
- [46] Masahiro Nakao, Koji Ueno, Katsuki Fujisawa, Yuetsu Kodama and Mitsuhi Sato. "Performance Evaluation of Supercomputer Fugaku using Breadth-First Search Benchmark in Graph500". In Proceedings of the IEEE International Conference on Cluster Computing (CLUSTER), 2020.
- [47] Mingzhe Li, Xiaoyi Lu, Sreeram Potluri, et al. "Scalable Graph500 Design with MPI-3 RMA". In proceedings of the IEEE International Conference on Cluster Computing (CLUSTER), 2014.
- [48] <https://github.com/EPCCed/GASNet-AM-benchmarks/blob/master/graph500-newreference/src/README>