

Präzi: From Package-based to Call-based Dependency Networks

Joseph Hejderup  · Moritz Beller*  ·
Konstantinos Triantafyllou · Georgios
Gousios* 

Received: date / Accepted: date

Abstract Software reuse has emerged as one of the most crucial elements of modern software development. The standard way to study the dependency networks caused by reuse is to infer relationships between software packages through manifests in the packages' repositories. Such networks can help answer important questions like “How many packages have dependencies to packages with known security issues?” or “What are the most used packages?”. However, an important overlooked aspect of current networks is that manifest-inferred relationships do not necessarily describe how or whether these dependencies are actually used in the code. To better model dependencies between packages, we devise PRÄZI, an approach combining manifests and call graphs of packages. PRÄZI constructs a fine-grained dependency network at the more fine-grained function-level, instead of at the manifest-level. For this paper, we provide a prototypical PRÄZI implementation for the popular system programming language Rust. Using it, we replicate a recent evolution study characterizing Rust's package repository, CRATES.IO, on the function-level. Our results identify new key characteristics and developments of CRATES.IO: i) 49% of all function calls in CRATES.IO target a function in a dependency, suggesting

*Work completed while author was a researcher at TU Delft, The Netherlands.

✉ Joseph Hejderup
Delft University of Technology
E-mail: j.i.hejderup@tudelft.nl

Moritz Beller
Facebook, Inc.
E-mail: mmb@fb.com

Konstantinos Triantafyllou
University of Athens
E-mail: ks.triantafyllou@gmail.com

Georgios Gousios
Facebook, Inc.
E-mail: gousiosg@fb.com

prevalent reuse of dependencies, ii) packages call 40% of their resolved transitive dependencies, iii) package maintainers make nearly 7 new calls to their dependencies biannually, and iv) packages have two to three times more indirect callers than direct callers of their APIs. These results show that current analyses of manifest-level dependency networks are not sufficient to understand how packages use each other.

Keywords package repository · dependency network · package manager · software ecosystem · network analysis · call graphs

1 Introduction

Converting information between different well-known formats, accessing external storage, manipulating information such as numbers, locations, and dates, or integrating with popular online services are examples of essential operations that developers need to handle in software projects. Unlike the standard library of programming languages, these essential operations change over time as a result of evolving technologies (e.g., shift to JSON from XML) or provide support to niche user communities (e.g., interfaces to Twitter API or Amazon AWS SDK). In addition to a standard library, modern programming languages such as Java, JavaScript, C#, and Rust also hosts a public repository for users to freely contribute and maintain essential operations in the form of reusable libraries (also known as packages). A package manager such as MAVEN, NPM, NUGET, and CARGO enable users to discover and import packages from repositories in their workspace through command-line interface (CLI) commands.

Package repositories principle on the UNIX philosophy (Raymond 2003)—mainly on the rule of modularity and composition. As a general guideline for modularity, a package should perform a well-defined task, developed with simple and clean interfaces, and be pluggable (composable) with other packages (Schlueter 2013; Abdalkareem et al. 2019). The manifest file such as Rust’s CARGO.TOML and NPM’s `package.json` in every package makes libraries composable: developers declare in the manifest how others can import their library and also if it utilizes external libraries by specifying dependencies on other existing packages. As packages can depend on one another through manifests, package repositories implicitly form a complex network, known as a package dependency network (Decan et al. 2018a; Hejderup 2015; Kikas et al. 2017).

In light of repository-wide incidents such as the `left-pad` package removal (Schlueter 2017), the hiding of a bitcoin wallet stealer in the legitimate `event-stream` package (Baldwin 2018), and malicious typosquatting packages in PyPI (Dunn 2017), researchers are conducting network analysis of package repositories for risk assessment (Zimmermann et al. 2019; Decan et al. 2018a; Kikas et al. 2017), sustainability (Valiev et al. 2018; Decan et al. 2019), license violations (Duan et al. 2017), and partially for detecting breaking changes (Mezzetti et al. 2018; Chen et al. 2020; Mujahid et al. 2020). Constructing a package dependency network for such analyses typically involves

scraping available manifests in the repository and then resolving dependency constraints in each manifest using a specific resolver (i.e., variations of `semver`) to infer relationship between packages (Kikas et al. 2017; Hejderup 2015).

However, inferring networks solely from package manifests yields an incomplete representation of package repositories. Manifests only describe metadata of package dependencies and miss information on its actual use in the source code, making network analysis prone to false positives. For example, a project might have redundant dependencies to packages whose functionality is not used anymore. Without knowing how packages actually use external libraries, Ponta et al. (2018)’s work on vulnerability checking packages demonstrates that metadata-based analysis have limited actionability, making it difficult for developers to understand how vulnerabilities in external libraries affect their code. Increasingly, package repository workgroups such as the Rust Ecosystem WG¹ are also calling for more comprehensive network analysis of package repositories to support code-centric analysis for more effective identification of critical yet unstable packages (Zhang et al. 2020a; Bogart et al. 2016). One such example is the `Libz Blitz` (Brian et al. 2020) initiative where community members come together and contribute to poorly maintained yet critical packages in `CRATES.IO` as an effort for stabilizing highly-dependent code in the repository.

This paper attempts to enable code-centric network analysis by inferring dependency relationships at the function call level. A call graph captures how functions between packages use each other and thus naturally lend themselves to this objective. We coin networks generated from call graphs `Call-based Dependency Networks (CDNs)`. To generate a CDN from a package repository, we devise `PRÄZI`, an approach that generates call graphs of packages and then merges them into a single network with functions embedding package qualifiers. The result is a more fine-grained dependency network improving current network analyses by only considering the actual package dependencies in use.

We implement `PRÄZI` for `CRATES.IO` to demonstrate the feasibility of our approach for a source-based package repository. Unlike repositories hosting analyzable binaries such as `MAVEN CENTRAL`, `CRATES.IO` requires large-scale compilation of the repository to produce binaries for call graph generation. The resulting CDN comprises 90% of all compilable packages, achieving a near-complete representation of `CRATES.IO`. Then, we replicate (Kikas et al. 2017)’s evolution study to characterize and derive new insights of `CRATES.IO` through function calls. We also compare CDNs against dependency networks derived from conventional and compile-validated metadata to understand their differences and similarities in dependency network analyses.

Our results find that 49% of all function calls in `CRATES.IO` are a call from a package to a dependency, suggesting that external function reuse is prevalent across the repository. On average, we find that a package calls 87.5% of its direct dependencies and 40% of its transitive dependencies, indicating

¹ <https://github.com/rust-lang-nursery/ecosystem-wg>

that packages do not interact with most of its transitive dependencies. When looking at the APIs of packages, packages have three times more indirect (i.e., transitive) callers than direct callers to their API. On average, the API of a package increases biannually with two new callers. Moreover, the number of calls from a package to its dependencies increases with 6.6 new direct calls and 12.2 indirect calls biannually. The majority of packages do not pose a threat to the stability of CRATES.IO. Among the most central packages, the most reachable function can reach up to 30% of all packages in CRATES.IO. The high indirect use of APIs in transitive dependencies of packages could constitute an important but missing confounding variable in API studies.

The metadata-based networks can approximate the results of package relationships for direct dependencies, direct dependents, and transitive dependents in a CDN. However, notable differences exist between the studied networks for transitive dependencies and for analyzing the most dependent packages. Metadata networks report twice the number of transitive dependencies than the CDN. The high variance between transitive dependencies implies that dependency checkers such as GITHUB's `Dependabot`² and Rust's `cargo-audit`³ are likely to make incorrect recommendations on transitive dependencies as these may not be used in practice. As a step towards inferring networks from the source code of package repositories, PRÄZI can enable both researchers and practitioners to estimate complex patterns of relationships between packages and their functions.

In summary, we make the following contributions:

- An approach to create call-based package dependency networks (CDNs) called PRÄZI.
- An open-source implementation for generating CDN of Rust's CRATES.IO
- An empirical study describing the structure, evolution, and fragility of CRATES.IO from a package and function view.
- A comparison of network analyses using PRÄZI CDN, metadata network, and compile-validated network.
- Two datasets for replication: CDNs for CRATES.IO and dataset of all generated call graphs.

2 Background

2.1 Related Work

Analyzing package repositories from a network perspective has become an important research area in light of numerous incidents such as the removal of the `left-pad` package in NPM and recent moves to emulate such problems on package dependency networks (Kikas et al. 2017; Kula et al. 2017; Decan et al. 2019; Zerouali et al. 2018). The aftermath of the `left-pad` incident (Schlueter

² <https://dependabot.com/>

³ <https://github.com/RustSec/cargo-audit>

2017) in 2016 raised questions on how the removal of a single 11 LOC package downloaded over 575,000 times could break the build for large groups of seemingly unrelated packages in NPM. To understand how certain packages exhibit such a large degree of influence in package repositories, Kikas et al. (2017)'s network analysis of three package repositories—NPM, CRATES.IO, and RubyGems—uncovered that package repositories have scale-free network properties (Albert and Barabási 2002). As a result of a large number of end-user applications depending on a popular set of packages (such as the `babel` compiler), these popular yet distinct packages become hubs in package dependency networks. Packages that act as hubs are not isolated packages; they also depend on small and common utility packages such as `left-pad` that appear as transitive dependencies for end-users. By reversing the direction of package dependency networks, (Kikas et al. 2017) identify that utility packages are highly central in package dependency networks with the power to affect more than 30% of all packages in the studied repositories.

In a comprehensive study of the evolution of package repositories, Decan et al. (2019) observe that three out of seven studied repositories have superlinear growth of transitive relationships, forming and strengthening new network hubs over time. Half of the packages in CRATES.IO, NPM, and, NuGet had in 2017 at least 41, 21, and 27 transitive dependencies, nearly two times more than their respective number in 2015. Although Decan et al. (2019) finds that the number of dependencies a developer declares in an application remains stable over time, the increasing number of transitive relationships in package repositories is still an active phenomenon after the `left-pad` incident. Apart from understanding the structure and evolution of package repositories, researchers have also studied known security vulnerabilities (Decan et al. 2018a; Zimmermann et al. 2019), maintainability (Valiev et al. 2018; Cogo et al. 2019; Zerouali et al. 2018), software reuse (Abdalkareem et al. 2019, 2017), and more recently breaking changes (Mezzetti et al. 2018; Mujahid et al. 2020) from a network perspective. Zimmermann et al. (2019) report that 40% of NPM include a package with a known vulnerability, suggesting that NPM forms a large attack surface for hackers to exploit. Despite developer awareness on using trivial and simple packages after the `left-pad` incident, Abdalkareem et al. (2019) still find a prevalent number of applications depending on trivial packages: 10% of NPM and 6% of PyPI applications on GITHUB depends on at-least one package with less than 35 LOC.

Network analysis of packages commonly makes use of metadata from package manifests to calculate the impact and severity of measured variables. Ponta et al. (2018)'s work on building a security dependency checker using call graphs highlights the limitations of using metadata and the importance of studying package dependencies with a contextual lens. Typically, a subset of an API is vulnerable—not the entire package—and how clients interact with API's is also highly contextual. To pitch for code-centric instead of metadata-based representations of package repositories, Hejderup et al. (2018) propose dependency networks based on function calls which we concretize in this work.

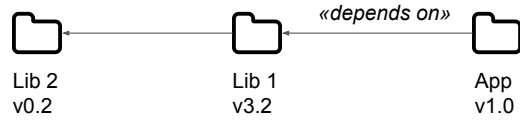

(a) State of the art: Package-based Dependency Networks.

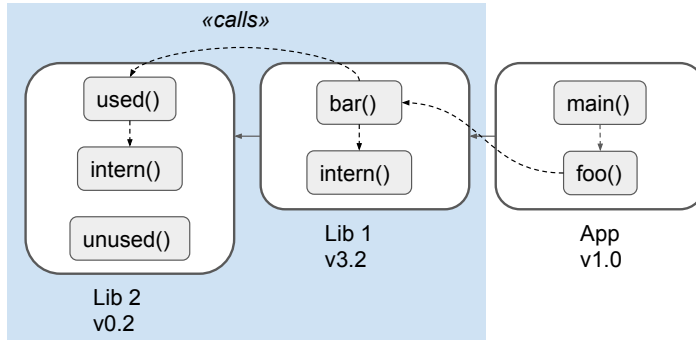

(b) Our proposal: Call-based Dependency Networks.

Fig. 1: Different granularities of dependency networks.

By embedding function call relationships into package dependency networks, we aim to also bridge the gap between API and package repository research. Notably, PRÄZI could resolve the limitation of studying immediate API calls to include chains of API calls (i.e., transitive calls) such as in Robbes et al. (2012)’s work on determining the ripple effects on deprecated APIs in the Smalltalk ecosystem. Similarly, combining qualitative studies such as looking into deprecation (Sawant et al. 2018c,a), breakages (Raemaekers et al. 2017; Xavier et al. 2017; Bogart et al. 2016), and migration patterns (Zhong et al. 2010; Nguyen et al. 2019) with network analyses could provide an additional empirical dimension in such studies. In support of this, Zhang et al. (2020b)’s need-finding study calls for tooling that supports API designers with data-driven recommendations, for example, on when to deprecate an API.

2.2 Rust Programming Language

Rust is a relatively new (first stable release 1.0 in 2015)⁴ systems programming language that aims to combine the speed of C with the memory safety guarantees of a garbage-collected language such as Java. Rust is also unique because its package management system (CARGO) was designed from the ground-up to be part of the language environment (Katz 2016). CARGO not only manages

⁴ <https://blog.rust-lang.org/2015/05/15/Rust-1.0.html>

dependencies but prescribes a build process and a standardized repository layout which helps facilitate the creation of automated large-scale analyses such as PRÄZI. Every CARGO package contains a file called `Cargo.toml`, specifying dependencies on external packages. Moreover, with CRATES.IO, there is one central place where all Rust packages (so-called “crates”) live. As of 13 August 2020, CRATES.IO is the fifth most fast-growing package repository hosting over 44,745 packages and averaging 60 new packages per day.⁵

2.3 Call-based Dependency Networks

We distinguish two kinds of dependency networks, shown in Figure 1: i) coarse-grained *Package-based Dependency Networks* (PDNs) shown in Figure 1a, similar to what dependency resolution tools (e.g., CARGO or MAVEN) build internally or what researchers have used in the past, and ii) fine-grained *Call-based Dependency Networks* (CDNs) shown in Figure 1b, which we advocate in this paper.

Figure 1a models an example of an end user application `App`, which directly depends on `Lib1` and transitively depends on `Lib2`. In such a PDN, each node represents a versioned package. An edge connecting two nodes denotes that one package imports the other, for example `App 1.0` depends on `Lib1 3.2`.

Figure 1b consists of three individual call graphs for `App`, `Lib1`, and `Lib2`. Each of these call graphs approximate internal function calls in a single package. Every node represents a function by its name. The edges approximate the calling relationship between functions, e.g., from `main()` to `foo()` within `App` in Figure 1b. However, the function identifiers bear no version, nor do they have globally unique identifiers (e.g., there are two `intern()` functions in Figure 1b). We merge these two graph representations to produce a CDN:

Definition 1 A *Call-based Dependency Network* (CDN) is a directed graph $G = \langle V, E \rangle$ where:

1. V is a set of versioned functions. Each $v \in V$ is a tuple $\langle id, ver \rangle$, where id is a unique function identifier and ver is a float value depicting the version of the package in which id resides.
2. E is a set of edges that connect functions. Each $\langle v_1, v_2 \rangle \in E$ represents a function call from v_1 to v_2 .

Applying the above definitions, the function `used()` in Figure 1b becomes a node with the fully qualified identifier $\langle Lib2::used, 0.2 \rangle \in V$. The dependency between `App` and `Lib1` is represented as $\langle \langle App::foo, 0.1 \rangle, \langle Lib1::bar, 3.2 \rangle \rangle \in E$.

CDNs offer a white-box view of the more coarse-grained Package-based Dependency Networks. In particular, we can see that `unused()` is never called. If `unused()` was affected by a vulnerability, we can deduce from Figure 1b that we should *not* issue a security warning for `App`, since it does not use the

⁵ <http://www.modulecounts.com/>

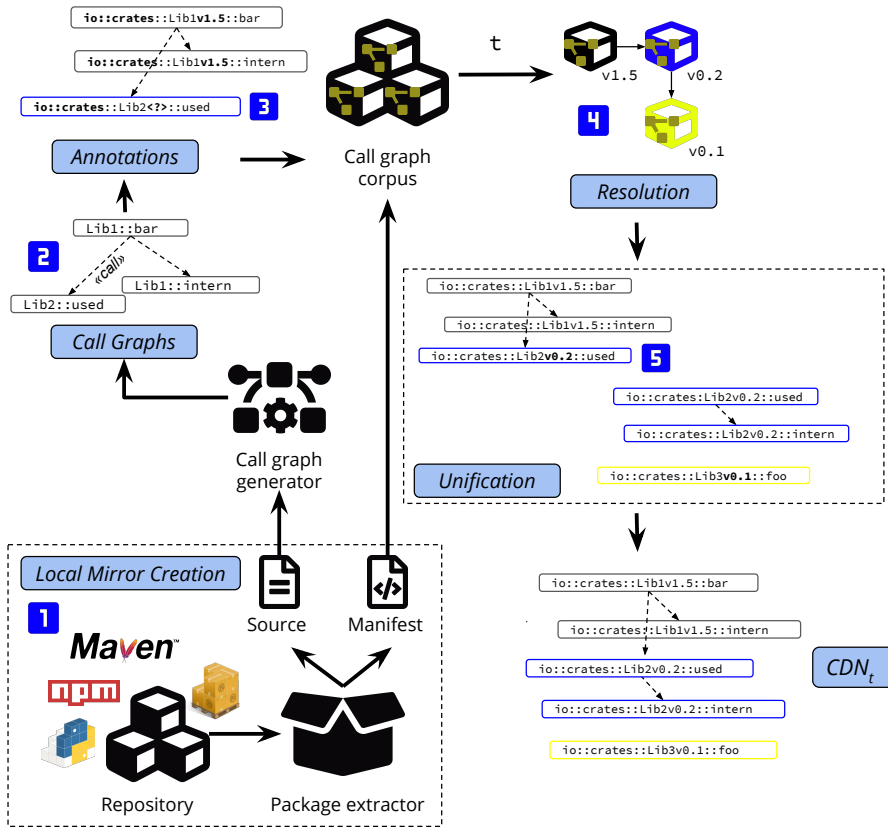

Fig. 2: Generic approach to generate CDNs from package repositories

affected functionality. In contrast to the CDN, the PDN in Figure 1 by its nature cannot provide such a fine-grained precision level.

3 Präzi: Generating CDNs from Package Repositories

In this section, we devise a generic approach, PRÄZI, to systematically construct CDNs of package repositories. PRÄZI can be applied to any programming environment that features i) a way of expressing dependency information between packages, and ii) tooling to generate call graphs for a package.

PRÄZI constructs a CDN in a two-phase process illustrated in Figure 2. In the first phase, *Call Graph Generation* (step [1], [2], and [3]), PRÄZI attempts to generate a static dataset of annotated call graphs from indexed packages in a repository. In the second phase, *Temporal Network Generation* (step [4] and [5]), PRÄZI first generates an intermediate package dependency network by resolving dependencies between packages at a user-provided timestamp t , and

then unifies the call graphs of resolved packages into one temporal call-based network, the CDN_t .

3.1 Call Graph Generation

Local Mirror Package managers keep an updatable index of package repositories to lookup available packages and their versions. Similarly, we use such indices to extract and download available packages in step [1](#) to create local mirrors of repositories. Minimally, a local mirror needs to contain the manifest, publication (or creation) timestamp, and unit of source for each version of a package.

Package Call Graphs A call graph is a data representation of relationships between functions in a program and serves as a high-level approximation of its runtime behavior (Ryder 1979; Ali and Lhoták 2012). From a static analysis context, a call graph is useful for investigating and understanding interprocedural communication between code elements (i.e., how functions exchange information). In PRÄZI, we view a call graph as a partial or sub-graph of a resulting CDN. Moreover, we increase the scope of a call graph from a single package (i.e., program) to a package and its dependencies. We denote inter-package function relationships as the actual specific code resources that packages use between each other (i.e., a dependency relationship at the function granularity) and are first-class citizens in CDN analyses. The call from `Lib1::bar` to `Lib2::used` in [2](#) exemplifies an inter-package function relationship. Minimally, PRÄZI requires nodes in call graphs to have function qualifiers with fully resolved return types and arguments.

In the presence of dynamic features in programming languages such as Java’s Reflection API, there are implications to the precision and soundness of constructed call graphs that indirectly also affects generated CDNs. Practically, it is impossible to have both a precise and sound call graph of a program. Thus, we advocate the use of *soundy* (Livshits et al. 2015) call graph algorithms that should support the resolution of most language features. Precise yet unsound call graph algorithms could miss actual inter-package function calls, making certain dependency analyses (e.g., security) of CDNs incomplete. Examples of sound call graph algorithms for typed languages include subclasses of Class Hierarchy Analysis (CHA) (Tip and Palsberg 2000; Sundaresan et al. 2000) and Points-to analysis (Steensgaard 1996; Shapiro and Horwitz 1997; Emami et al. 1994) such as *k*-CFA (Shivers 1991). In the case of untyped languages such as Python or JavaScript with no option for sound call graph algorithms, a middle-ground is hybrid approaches combining both dynamic analysis and static analysis such as (Alimadadi et al. 2015)’s Tochal.

Annotating Call Graphs To prepare call graphs for the unification in the network generation phase, we need to rewrite function identifiers in each package call graph such that they are globally unique. Without annotating function

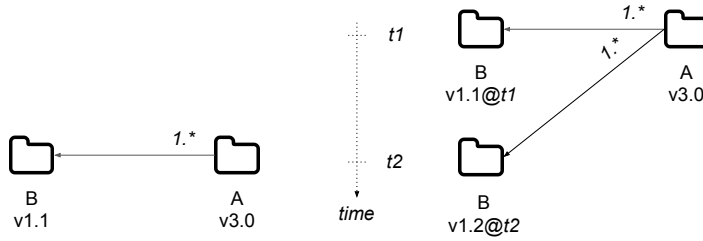

(a) Package A depends on B version 1.*. (b) Full dependency resolution tree with time.

Fig. 3: Retro-active dependency resolution

identifiers, inconsistencies can arise from packages that have identical namespaces and multiple versions of the same package in a dependency tree. PRÄZI solves these issues by annotating the function names, return types, and argument types in function signatures with three components: i) repository name, ii) package name, and iii) static or dynamic (i.e., constraint) package version.

For each function signature in a call graph of a package version, PRÄZI maps each type identifier found in the signature to the package that declares it. There are three potential mappings of a type identifier to a package that do not reside in the standard library of the language:

- **Local**, resulting in an annotated qualifier with the repository name, and its package name and version as exemplified in `io::crates::Lib1v1.5::bar`.
- **Dependency with a static version**, resulting in an annotated qualifier with the repository name, and the name and version of the dependency.
- **Dependency with a dynamic version**, resulting in an annotated qualifier with the repository name and name of the dependency. However the version is missing as exemplified in `io::crates::Lib2<?>::used` in [3].

The first two mappings denote a resolved type annotation, and the last one is an unresolved type annotation due to having a dynamic version. Function identifiers with unresolved type annotations have their dynamic versions resolved to a specific version at dependency resolution time (i.e., at the *Temporal Network Generation* phase). Finally, PRÄZI splits the annotated call graph into two sections, one immutable section containing resolved function signatures, and another section containing unresolved function signatures. The annotated call graphs are then stored in our dataset. The final dataset should contain all downloaded packages that include creation timestamp, manifest file, and annotated call graph with global identifiers.

3.2 Temporal Network Generation

Retro-active Dependency Resolution To study the evolution of the relationships between packages in a repository, we perform retroactive dependency

resolution [4] that generates a concrete dependency network valid at a given timestamp t . The use of dynamic versions in package manifests complicates network generation of package repositories. During resolution time of package dependencies, a dynamic version instructs the dependency resolver to fetch the most recent version within its allowed version boundary, making the relationship between packages contemporary. Package A depending on the dynamic version $1.*$ of package B that satisfies any version with a leading 1 . (e.g., $1.0, 1.8$, or $1.20.2$) in Figure 3a exemplifies a dynamic version. Given that Package B releases version 1.1 at t_1 and 1.2 at t_2 ($t_1 < t_2$) in Figure 3b. At t , where $t_1 < t < t_2$, a dependency resolver will select version 1.1 . However, at $t > t_2$, it will select version 1.2 , highlighting the temporal changes in package relationships.

Given a timestamp t , PRÄZI creates a subset $mirror_t$ of our local mirror containing packages and versions with a creation timestamp t_c satisfying $t_c \leq t$. Then, for each package version manifest file in $mirror_t$, we resolve its dependencies using a dependency resolver. Dependency resolvers are usually integrated into package managers and are available as independent libraries.

Call Graph Unification The unification is a two-phase process. In the first phase, we build a resolved dependency tree for each package version in $mirror_t$ and then perform a level-order traversal of each tree to merge call graphs of child nodes with their parent nodes. The output is a package-level call graph of statically dispatched function calls for each package version in $mirror_t$. In the merge phase of a parent and a child call graph, we complete the unresolved function identifiers in the parent call graph with the resolved version available in the child node. The function `io::crates::Lib2v0.2::used` in [5] replaces the unresolved function `io::crates::Lib2<?>::used` in [3] with `v0.2`.

In the second phase, we complement each dynamically dispatched function in the merged call graph with new call targets by looking up compatible function implementations in other packages. As packages can have shared interfaces, we can expect that developers can pass an object with an implemented interface from one dependency to another dependency where it invokes the interface methods of the passed object, creating a call target between those dependencies. Albeit seeming both unrelated and imprecise, the second phase is necessary to ensure that dynamically dispatched functions remain sound after merging all call graphs together.

After constructing a package-level call graph for each package version in $mirror_t$, we merge all partial call graphs into a single CDN. The process consists of aggregating all package-level call graphs and then merging them to remove duplicate nodes and edges. The result is a CDN corresponding to the package repository at the given timestamp t .

4 Implementing Präzi for Crates.io

We chose to implement PRÄZI for CRATES.IO, the official package repository for Rust. Unlike mainstream package repositories such as MAVEN CENTRAL,

PyPI, NPM, and NuGet, CRATES.IO do not host pre-built binaries but the source code of its packages. To generate call graphs for Rust packages, we need to first perform a large-scale compilation of CRATES.IO and then extract call graphs from generated binaries. Attempting to reproduce the build of a piece of software is known to be challenging (Sulír and Porubän 2016), Tufano et al. (2017)’s compilation of 219,395 Apache snapshots yielded a success rate of 38%, and Martins et al. (2018)’s compilation of 353,709 Github Java projects yielded a success rate of 56%. An overall low success rate could potentially endanger representative studies of CRATES.IO.

In the remainder of this section, we describe key implementation choices and results from our large-scale compilation of CRATES.IO. The source code, processing scripts, and datasets are available for replication at <https://github.com/praezi/rust-emse-2020>.

Creating a local mirror We clone a snapshot of CRATES.IO’s official git-based index⁶ at revision 6c550c8 (14th February 2020) containing 35,896 packages, 208,023 releases, and 1,151,001 dependency relationships. By validating the dependency specification in the index for invalid names or dependency constraints, we can save resources by avoiding building broken releases. We identify 1,506 releases from 201 packages having dependencies that do not match existing packages, and 5,667 releases from 4,427 packages having dependencies with unsolvable constraints (i.e., no available versions for the constraint)

The documentation hosting service for CRATES.IO, `Docs.rs`,⁷ provides Rust users API documentation for every published package release. In addition to automatically generating documentation for package releases, `Docs.rs` also documents the build log and compile status publically. We create a web scraper that extracts the build status on `Docs.rs` for each release in our dataset. In total, we found that 43,893 indexed releases belonging to 10,154 packages have build failures, amounting to 20% of CRATES.IO. In addition to the CRATES.IO index, we use `Docs.rs` as the compile-validated metadata source in our study.

After subtracting build failures and invalid dependency specifications, our final index amounts to 156,484 releases from 29,480 packages. Lastly, we use the official API at <https://crates.io/api/v1/crates> to download all packages and its creation timestamp (not available in the index) to disk.

Choosing a Call Graph Generator There are two approaches for constructing a call graph from a Rust program, the higher-level LLVM analysis,⁸ and the lower-level MIR analysis (Matsakis 2016). Rust functions and its calls are either of monomorphized (i.e., static dispatch) or virtualized (i.e., dynamic dispatch) nature. From the documentation⁹ and a comprehensive benchmark (Triantafyllou 2019), we can learn that there are two monomorphized fea-

⁶ <https://github.com/rust-lang/crates.io-index>

⁷ <https://github.com/rust-lang/docs.rs>

⁸ <https://llvm.org/docs/Passes.html>

⁹ <https://doc.rust-lang.org/book/ch03-03-how-functions-work.html>

Table 1: Build statistics

Build	#Releases	#Packages	Time (hrs)
CRATES.IO index	208,023	35,896	—
Docs.rs	156,484 (-24.78%)	29,480 (-17.87%)	—
rust-callgraphs	142,301(-9.06%)	23,767 (-19.38%)	10 days

tures, `macros`¹⁰ and `generic functions`, and two virtualized features, `Trait Objects`,¹¹ and `function pointers`,¹² that dispatch functions in Rust.

As part of the output in compilation of Rust programs, we can use the optionally generated LLVM IRs¹³ to build call graphs using the LLVM call graph generator¹⁴ or `cargo-call-stack` (Aparicio 2019). Due to the absence of Rust-specific type information in LLVM IRs,¹⁵ call graph generators can only resolve monomorphized features and cannot provide complete type information needed in PRÄZI. By analyzing at the MIR level instead of the LLVM level, `rust-callgraphs`¹⁶ offers a more feature-complete call graph by implementing a CHA algorithm and is our choice for building CDNs. In addition to monomorphized features, it can resolve function calls dispatched through `Trait Objects`, making it a more soundy choice over the LLVM-based call graph generators. Although `rust-callgraphs` do not support `function pointers`, it is a negligible trade-off as the documentation¹⁷ state that `function pointers` are mostly useful for talking to C code in Rust.

For annotating call graphs, the metadata in call graph nodes contains package information and access identifiers. Moreover, the complementary type hierarchy output contains complete type information for creating resolved function identifiers. We also keep the edge metadata that includes dispatch information (i.e., static, dynamic, or macro) in the annotated call graphs.

Large-Scale Compilation of CRATES.IO Some Rust packages depend on external system libraries such as `libavcodec` or `libxml2` to successfully compile. Knowing which external libraries to install for compiling such packages is a manual and tedious process. Luckily, the Rust infrastructure team maintains a Docker image, `rust-lang/crates-build-env`, that bootstraps a Rust build environment pre-installed with community curated systems libraries, increasing the chances for successful compilations. We use `Rustwide`,

¹⁰ <https://doc.rust-lang.org/stable/reference/macros.html#trait-objects>

¹¹ <https://doc.rust-lang.org/stable/reference/types.html>

¹² <https://doc.rust-lang.org/book/ch19-05-advanced-functions-and-closures.html>

¹³ [https://doc.rust-lang.org/rustc/command-line-arguments.html#](https://doc.rust-lang.org/rustc/command-line-arguments.html#--emit-specifies-the-types-of-output-files-to-generate)

`--emit-specifies-the-types-of-output-files-to-generate`

¹⁴ http://llvm.org/doxygen/CallGraph_8h_source.html

¹⁵ <https://github.com/rust-lang/rust/issues/59412>

¹⁶ <https://github.com/ktrianta/rust-callgraphs>

¹⁷ <https://rust-lang.github.io/unsafe-code-guidelines/layout/function-pointers.html>

an API for spawning Rust build containers, and configure it to use `rustc 1.42.0-nightly` compiler together with `rust-callgraphs`'s compiler plugin. After compilation, we use the analyzer component in `rust-callgraphs` to generate and store the call graphs in our dataset.

We set up a compilation pipeline on four build servers running 34 docker containers to compile packages and build call graphs. It took 10 days to complete it. Table 1 shows the compilation results in comparison with index entries and `Docs.rs` results. Overall, our call graph corpus (CG Corpus) has a call graph for 90% of all compilable versions (70% of all indexed versions) and at least one version for 80% of all packages built by `Docs.rs`. The high success rate showcases the practical feasibility of PRÄZI for CRATES.IO.

Dependency Resolution For each `CARGO.TOML` manifest in our downloaded dataset, we extract dependencies intended for source code use. These include library dependencies (i.e., `[dependencies]`), platform-specific dependencies (i.e., `[target]`), and also enabled optional dependencies in `[features]`. Both Kikas et al. (2017) and Decan et al. (2019) fail to take into account both enabled optional dependencies and platform-specific dependencies, considering only library dependencies when analyzing CRATES.IO.

The `CARGO.TOML` manifest supports specifications of dependencies using the `semver` schema (Preston-Werner 2013). A version is a three-part version number: major version, minor version, and patch version. An example of a version is 1.0.0. An increase in the major number denotes incompatible changes, an increase in the minor number denotes backward-compatible changes, and an increase in the patch number denotes small bug fixes. With the support of range operators (i.e., dynamic version) in dependency specifications such as caret (e.g., `^1.0.0`), tilde (i.e., `~ 1.0.0`), wildcard (e.g., `1.*`), and ranges (e.g., `> 1.0.0. <= 2.0.0`), the dependency resolver in `CARGO` will attempt to resolve the latest version satisfying the constraint.

To emulate dependency resolution in Rust, we use the native Rust-implementation of the `semver` library for use in Python by invoking its native implementation through FFI (Foreign Function Interface) bindings. Thus, we resolve dependencies and their constraints using the same library as the `CARGO` package manager. For every timestamp t in the CDN generation process, we set the resolution to solve the latest version available at t .

5 Structure and Evolution of Crates.io CDN

We replicate the study setup of Kikas et al. (2017) to demonstrate how researchers can conduct studies using a CDN instead of a conventional package dependency network. Our motivation for replicating this work is two-fold: i) follow-up on the growth and evolution of CRATES.IO as the most recent studies (Decan et al. 2019; Kikas et al. 2017) date back to 2017, and ii) quantify the structure and evolution of a package network using data from three differ-

ent network sources: metadata, compile-validated metadata, and control-flow data.

5.1 Research Questions

We adopt the three formulated research questions in the original study (Kikas et al. 2017) to make it specific for CRATES.IO:

RQ1: What are the network characteristics of Crates.io?

We conduct descriptive network analysis to characterize the calling relationship between packages in CRATES.IO, and then draw out various influential packages having a high number of callers and callees within the networks. Specifically, we describe the degree distribution to understand the direct relationship between functions among the packages and calculate weakly connected components to investigate the presence of community structures. We perform these analyses on a generated CDN and CRATES.IO index network dated February 2020.

RQ2: How does Crates.io evolve?

The frequent number of new package releases and the adoption of `semver` range operators in dependency specifications make the relationship between packages highly temporal in CRATES.IO. We capture these dynamics by understanding its overall growth on the number of new packages, releases, and calls between packages since its inception in 2015. First, we create a set of resolved snapshots per year for the CDN, `Docs.rs` network, and CRATES.IO index network. For creating snapshots, we use a time window t where a large fraction of package dependencies in CRATES.IO resolve to a new version. For each snapshot, we then measure the adoption rate and trends of dependencies and dependents at the package-level and then at the function-level. For the CDN snapshots, we also investigate the presence and growth of function co-existence in CRATES.IO.

RQ3: How fragile is Crates.io to function-level changes?

Security vulnerabilities, breaking changes, or severe performance bugs in functions can result in creating new `left-pad` like incidents in package repositories. Identifying influential packages and their functions can help unveil single points of failures that can potentially destabilize package repositories. To quantify such threats and understand how it differs between networks, we measure the *local reaching centrality* (Mones et al. 2012) in the largest weakly connected component of each snapshot per network. We then also identify a set of highly influential packages based on their overall reaching capacity.

Among the top-reaching packages, we also tabulate the top 10 functions with the highest reach in their respective CDN snapshot.

As the **RQs** make comparisons between metadata-based and call-based representations, we also need to reverse-engineer a package-based network from the CDN to make comparisons possible between them (i.e., at the package-level). To infer a package-based network from the CDN, we map a *direct dependency* as at-least one call from a function in package *A* to a function in package *B*. A *transitive dependency* is at-least one call path from a function in package *A* via intermediate functions in package *B* to a function in package *C*.

5.2 RQ1: Descriptive Analysis

5.2.1 Summary of Datasets

Before investigating the calling relationship among packages in CRATES.IO, we first describe our datasets of generated call graphs (i.e., **CG Corpus**) and our largest CDN dated February 2020 in Table 2. After removing all function calls to the standard libraries of Rust, the call graph corpus has over 121 million functions and 327 million function calls from 142,301 compiled releases. When merging call graphs into a CDN, we generate a compact representation with over 44 million functions and 216 million function calls, a sizeable reduction of 2.5 and 1.5 times of the **CG Corpus** (i.e., functions and calls), respectively.

Table 2 also breaks down function calls into their dispatch type, namely macro, static, and dynamic calls. Notably, nearly 80% of all edges in the **CG Corpus** are of a dynamic dispatch type, followed by static dispatch (18%) and macro invocations (2%). The high number of dynamically dispatched calls in the network indicates that CRATES.IO has a large pool of possible target implementations to virtual functions—not necessarily magnitude more function calls than statically dispatched calls. When comparing the access modifiers between functions, we can see that 40% of all functions inside CRATES.IO are publicly consumable. Also, we can see that calling functions in external packages is widespread in CRATES.IO; half of all the function calls invoke a function from an external package (i.e., inter-package call). Unlike the other two dispatch forms, 91% of all macro dispatched calls exclusively target macros defined in external packages. Overall, the high number of declared public functions and the large degree of inter-package calls indicate that code reuse in the form of functions between packages is a prevalent practice in CRATES.IO.

Code reuse of functions is a prevalent practice; 40% of functions are public and 49% of call edges target a dependency.

CRATES.IO is a scale-free network, indicating the presence of a handful of functions or hubs that are highly connected to other functions in the repository

Table 2: Summary of Datasets

	CG Corpus	CDN Feb'20
Functions	121,825,729	44,190,643
... public access	46,236,696	20,157,155
... private access	75,589,033	24,033,488
Call edges	327,535,934	216,239,360
Intra-Package Calls	169,579,315	102,136,956
... macro invocation	693,148	356,329
... static dispatch	28,570,266	20,650,000
... dynamic dispatch	140,315,901	83,130,627
Inter-Package Calls	157,956,619	114,102,404
... macro invocation	7,183,797	2,178,547
... static dispatch	29,650,173	13,319,367
... dynamic dispatch	121,122,649	98,604,490

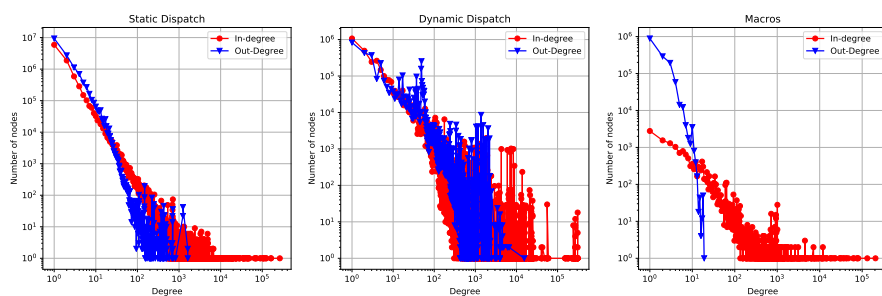

Fig. 4: Degree distribution of all function calls

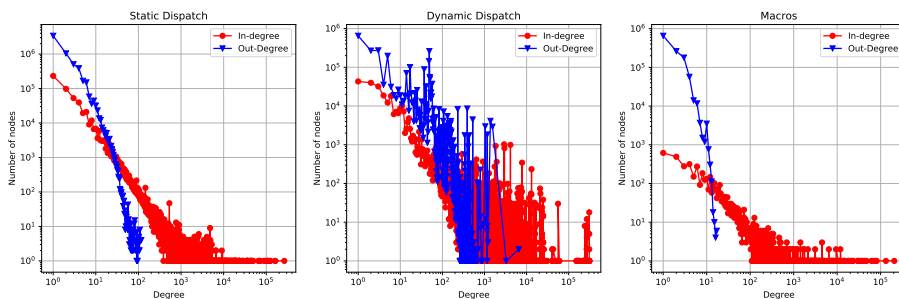

Fig. 5: Degree distribution of inter-package function calls

5.2.2 Relationships between functions

Figure 4 depicts the degree distribution for all function calls divided by their dispatch type, and Figure 5 is a narrowed-down version looking at only inter-package function calls. As mentioned earlier, the inter-package call set contains

Table 3: The top 10 functions with most statically-dispatched calls

Package	Outdegree Function	#	Package	Indegree Function	#
epoxy	<code>load_with</code>	1,625	serde	<code>missing_field</code>	264,281
sv-parser-syntaxtree	<code>next, into_iter</code>	1,243	log	<code>max_level</code>	162,747
python-syntax	<code>__reduce</code>	821	vcell	<code>set</code>	125,287
rustpython-parser	<code>__reduce</code>	720	serde_json	<code>from_str</code>	73,171
mallumo-gls	<code>load_with</code>	712	futures	<code>and_then</code>	65,043
gl	<code>load_with, inner</code>	695	trackable	<code>new</code>	49,308
gleam	<code>load_with</code>	635	hyper	<code>send</code>	47,212
lalrpop	<code>__reduce</code>	504	clap	<code>value_of</code>	44,152
rute	<code>fmt</code>	466	proc-macro2	<code>call_site</code>	41,664
wast	<code>encode</code>	445	http	<code>is_success</code>	38,459

only function calls between packages (i.e., pruning all internal calls). For dynamically dispatched calls, we only focus on calls between a package and its dependencies and filter out calls between dependencies that belong to different subtrees. When such dependencies of packages have more common interfaces and implementations between them than the package under analysis, a positive skew appears towards the dependencies than the package under analysis in centrality measures. As our focus of analysis are interactions between packages and their dependencies (including the transitivity of dependencies), we omit such type of calls. The out-degree distribution for dynamic dispatch represents the number of possible target functions in a virtual method table, and, for static- and macro dispatch, the number of function calls. The in-degree distribution presents the aggregated number of callers for a function (i.e., callee) and implementations of virtual functions for dynamic dispatch, respectively. Overall, we can observe a long tail for both the in-degree and the out-degree of each dispatch mechanism, suggesting that the CRATES.IO CDN is a scale-free network with the presence of a few nodes that are highly connected to other nodes in the network (i.e., hubs). Finally, Tables 3 to 5 describes the top 10 functions with the highest in-degree and out-degree calls per dispatch type. The top 10 list is an aggregation of functions per package. For example, `serde` package in Table 4 has over 300 serialization functions with an in-degree similar to 264,281. Thus, we present the top 10 functions as the top most called function(s) per package. In the following subsections, we describe key results for each of the three dispatch forms.

Static dispatch The median out-degree for statically dispatched function call is 1 call (mean: 2.25) in both cases and at the 99th percentile being 15 calls (13 calls for inter-package calls). When comparing the out-degree between statically dispatched calls in Figure 4 and Figure 5, we can notice that there are 1865 functions (0.012%) that call more than 100 other internal functions in Figure 4. The highest number of calls made by a single function in both plots is to 1625 local functions and 116 external functions, respectively. The relatively high number of internal function calls among the outliers seems un-realistic

Table 4: The top 10 functions with most dynamically-dispatched calls

Outdegree			Indegree		
Package	Function	#	Package	Function	#
hyperbuild	<code>match_trie</code>	15,460	serde	<code>deserialize_any</code>	307,976
heim-common	<code>to_base, from_base</code>	6,597	serde_json	<code>from_str</code>	268,887
uom	<code>to_base, from_base</code>	6,045	serde_urlencoded	<code>deserialize_identifier</code>	59,737
fpa	<code>I1F7, I2F6</code>	3,966	yup_oauth2	<code>token</code>	42,737
rtdlib	<code>deserialize</code>	2,470	cpp_core	<code>cast_into</code>	28,278
mkI26z4	<code>eq</code>	2,222	num_traits	<code>zero</code>	21,948
webkit2gtk-webextension	<code>partial_cmp</code>	2,212	rustc_serialize	<code>encode</code>	21,468
screeps-api	<code>deserialize</code>	2,032	actix-router	<code>deserialize_identifier</code>	16,331
cfm	<code>deserialize</code>	1,708	glib	<code>to_glib_none</code>	15,404
tinkerforge	<code>ry_recv</code>	1,704	toml	<code>deserialize_identifier</code>	14,840

at a first glance. Upon manual inspection of the source code of the only two packages having functions with an out-degree greater than 1000 (see Table 3), namely `epoxy` and `sv-parser-syntaxtree`, we identify that this is the result of generic instantiations for creating bindings to the `libepoxy` (an OpenGL function pointer manager) and tokens for parsing SystemVerilog files.

The median in-degree for statically dispatched function calls are 1 (mean: 3.6) and the 99th quantile is 24. When omitting all internal calls and considering only inter-package calls, the median is 2 (mean: 24) and the 99th quantile is 208. There are three functions having over 100,000 external calls in Table 3, `serde` for *serialization*, `log` for *logging*, and `vcell` for *memory management*. While the first two are the most downloaded and dependable packages in CRATES.IO, `vcell` stands out for only having a sizeable number of nearly 300 dependent packages. When performing a `grep` search and inspection in the source code of those packages for the specific `set` call, we could identify extensive implementations of low-level drivers to interface various microcontrollers such as the `Cortex-M` and `STM32` series.

Dynamic dispatch For dynamically dispatched function calls, we can understand how Trait-compatible function targets populate virtual method tables (i.e., `vtables`) in Rust packages. We use `vtable` to refer to all implementations of a virtual function of a Trait object. In practice, each Trait Object points to compatible Trait Implementations (having a `vtable` with function and other member implementations). The median number of function targets function `vtable` is 9 (mean: 42 (all), 32 (inter-package)) for both all function targets and only inter-package function targets. The main deviation is at the 99th percentile, the outdegree for all function targets is 800 for all targets, two times higher than when only considering inter-package function targets. The highest out-degree function in Table 4 is `match_trie` in the package `hyperbuild v0.0.10`, a HTML minification library, having a `vtable` with 15,460 function targets. The function takes as an argument a `trie: &dyn ITrieNode<V>` Trait, invoking `get_child` and `get_value` of the Trait `ITrieNode`. The Trait is implemented for all forms of HTML entities, explaining this high outdegree value. In total, there are 38,352 (< 0.9%) functions that populate a `vtable` with

Table 5: The top 10 functions with most macro-dispatched calls

Outdegree			Indegree		
Package	Function	#	Package	Function	#
item	<code>path_segment</code>	19	log	<code>log!</code>	205,810
fungi-lang	<code>fgi_module</code>	18	bitflags	<code>__impl_bitflags!</code>	77,848
syn	<code>path_segment</code>	17	lazy_static	<code>__lazy_static_internal!</code>	64,161
device_tree_source	<code>parse_data</code>	17	trackable	<code>track!</code>	47,648
numpy	<code>map</code>	17	serde	<code>forward_to_deserialize_any_method</code>	43,063
melib	<code>uid_fetch_response_</code>	16	quote	<code>quote_spanned</code>	31,283
qjs-derive-support	<code>qjs</code>	16	phf	<code>phf_map</code>	19,746
ambassador	<code>delegate_macr</code>	14	nom	<code>do_parse</code>	18,304
bindgen	<code>codegen</code>	14	quick-error	<code>quick_error</code>	12,830
coi-derive	<code>inject_derive</code>	14	slog	<code>record_static</code>	9,435

more than 1000 function targets. Similarly, we can observe 11,906 ($< 0.36\%$) inter-package function calls with over 1000 function targets.

The median in-degree for implementing a virtual (i.e. trait) function is 3 (mean: 53) and the 99th percentile is 608. When only considering inter-package relationships, the median is 3 (mean: 64) and the 99th percentile is 875. As shown in Table 4, the most commonly implemented trait function stems from serializer packages such as `deserialize_any` in `serde`, `from_str` in `serde_json` and `deserialize_identifier` in `toml`. In addition to serialization functions, we can also observe that 42,737 functions implement the trait function `token` in `yup-oauth2` for user authentication with OAuth 2.0.

Macro dispatch When comparing the out-degree for both all and inter-package calls, we can observe a similar trend between them: the median is 1 (mean: 1.7) and the 99th quantile is 6, suggesting that macro-dispatched calls are largely inter-package calls. This resonates with our observations for macro-dispatched calls in Table 1. Looking at functions calling the most number of macros in Table 5, we can observe that the outdegree generally is relatively low in comparison to the other two dispatch types. The function `path_segement` in `item` makes in total 19 macro calls, the highest in CRATES.IO. The median in-degree is 7 (mean: 146) and the 99th quantile is 1427. When only considering inter-package calls, the median is 12 (mean: 391) and the 99th quantile is 6433. We can observe comparable numbers to the in-degree with the other two dispatch types in Table 5. With over 200,000 functions in CRATES.IO calling `log!`, it is the most called macro followed by `__impl_bitflags!` and `__lazy_static_internal!`. Generally, we can observe that the top most called macros belong to popular packages in CRATES.IO that are known to simplify logging (`log`), generate bit flag structures (`bitflags`), and wrapping error messages (`quick-error`).

The median function in CRATES.IO makes one static call, one macro call and has a `vtable` with nine function targets. The median function (or virtual function) is also dependent on one static call, one macro call, and implemented by three functions.

5.2.3 Weakly Connected Components

Similar to social networks such as the Facebook graph (Backstrom et al. 2012) and the web graph (Boldi et al. 2004), package repositories exhibit a giant component where nearly every node is reachable to another node (Kikas et al. 2017). Extracting components within a network can also reveal possible community structures (Porter et al. 2009). Before identifying community structures, we first compare the difference in connectedness between the giant component extracted from a CDN CRATES.IO index network with the CDN at the package-level granularity. Moreover, we make the comparison on package releases common to both networks (i.e., all compilable package releases in the CDN). Thus, we do not include the Docs.rs network in the comparison as the dependency relationships are identical with the CRATES.IO index network in this case. By calculating the set difference on the largest common component between these two networks, we can identify package releases that are not connected in the CDN (but connected in the CRATES.IO index network).

When deriving the largest component with common packages releases from the two networks, we find that 84% of all package releases are connected in the CRATES.IO index network and 73% in the CDN. We find that both networks exhibit a giant component, showcasing that most package releases are weakly connected to each other. When comparing the networks, the CRATES.IO network has 1985 package releases that are not connected in the CDN. Examples of those are `html-minifier::1.2.1`, `serde_json::1.0.51`, `request::0.10.4`, and `nalgebra::0.21.0`. Without an established ground truth of packages and their interactions of imported dependencies, the 1985 package releases are potential candidates for not using their declared dependencies.

Most packages are connected in a single giant component. When comparing connectedness, 11% of packages in a metadata-based network are not connected in a CDN.

In addition to the giant component of the CDN, we identify three small yet sizable independent ecosystems. The largest with 61 packages represents an ecosystem with Windows-specific packages such as `crypt32-sys`, `kernel32-sys`, and `shell32-sys`. The two remaining ecosystems form around two-game engine frameworks, `Piston` and `Allegro` with 47 and 38 packages, respectively.

Three independent ecosystems exists: one Windows-specific and two game-engine specific.

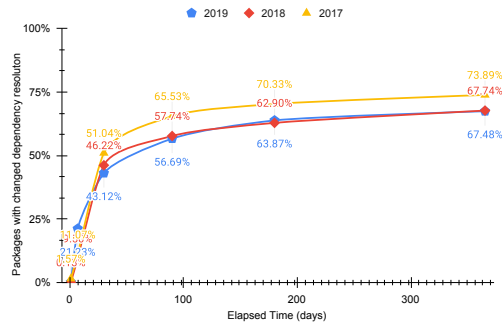

Fig. 6: Retroactive resolution of dependencies over a time period of one year in 2017, 2018, and 2019

5.3 RQ2: Evolution

5.3.1 Adoption rate of new dependency versions in existing packages

We measure the fraction of packages in CRATES.IO that adopt a new dependency version after a time window of t . We measure the rate of adopting a new version for a set of packages at the beginning of 2017, 2018, and 2019 for one day, one week, one month, three months, six months, and one year. When studying the evolution of package repositories, setting the right time window between consecutive snapshots enable us to gradually track structural changes inside CRATES.IO.

In Figure 6, we can observe an exponential cumulative growth in the rate of adopting new dependency versions for each year group. While there are notable differences between them, we can see that after 30 days, more than 40% of all existing packages in each year group have at-least one dependency resolving to a new version. The high adoption rate is not surprising: only 2.92% of CRATES.IO specify fixed versions for their dependencies (Dietrich et al. 2019). We only find that 26% of all packages do not resolve to a new version in 2017. The number is higher for 2018 and 2019 at 33%.

In general, the fast adoption of new versions in CRATES.IO questions the use of yearly snapshots for evolution analysis in Kikas et al. (2017) and Decan et al. (2019); half of the packages in CRATES.IO resolve to a new dependency version within 3 months. Long time gaps between snapshots can result in missing short-lived yet significant historical events. Based on our observations in Figure 6, we set a time window of one month and generate 59 snapshots between April 2015 to February 2020.

40% of all CRATES.IO packages have at-least one dependency resolving to a new version after 30 days.

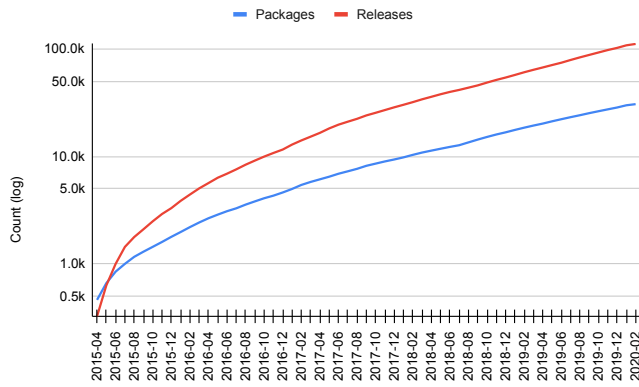

(a) Number of unique packages and releases

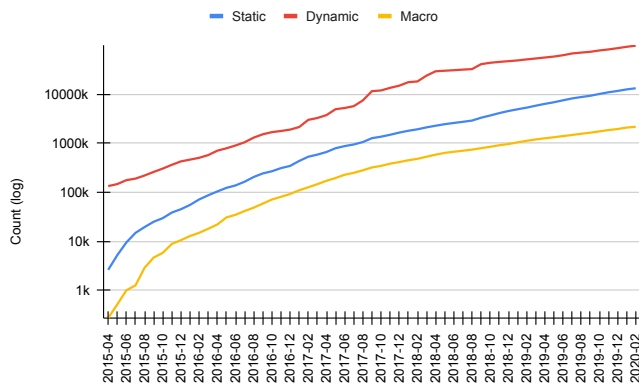

(b) Number of inter-package function calls per dispatch mechanism

Fig. 7: Dependency network growth

5.3.2 Ecosystem growth

Figure 7 describes the cumulative growth of (a) the number of unique packages, releases, and (b) inter-package function calls per dispatch mechanism between 2015 and 2020. The shape of each plotted variable in both the semi-log plots follows an exponential growth often observed in package repositories (Kikas et al. 2017; Decan et al. 2019; Wittern et al. 2016): the simplicity in both releasing new packages and specifying dynamic versions drives the development of package repositories.

In Figure 7a, we can derive a near 6-fold increase in the monthly average growth of packages from 168 packages/month between 2014-2016 to 1012 packages/month between 2019-2020. Similarly, the increase in monthly average growth of releases is nearly 10-fold from 392 versions/month to 4146 ver-

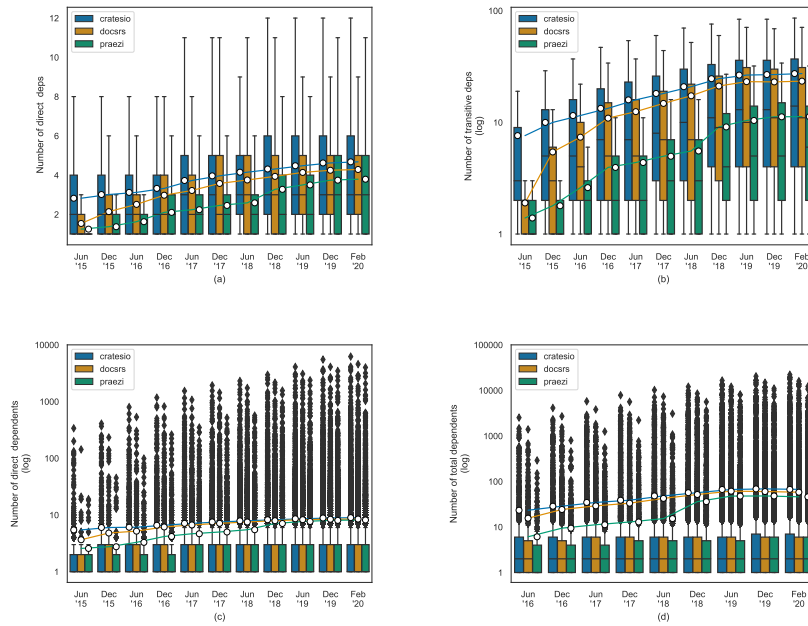

Fig. 8: The evolution of package relationships on two metadata-based networks, CRATES.IO and Docs.rs, and one call-based network, PRÄZI.

sions/month for the same period. In a formative period of CRATES.IO around mid-2015 in Figure 7a, we note a short period of higher number of new packages than new releases. For inter-package function calls in Figure 7b, we observe a monthly growth that is exceedingly higher than for packages and releases in Figure 7a: a 105-fold (5879 to 619, 253) increase of statically dispatched calls, a 96-fold (36, 876 to 3, 536, 251) increase of dynamic function targets, and a 62-fold (1401 to 87, 125) increase of macro invocations. Consequently, the rapid increase of function calls between packages indirectly makes CRATES.IO more interconnected over time as a result.

CRATES.IO has a growing community of package contributors that are both proactive in releasing new versions and making use of external packages through means of static- and dynamic dispatching of functions, and macros.

5.3.3 Evolution of package relationships

Figure 8 depicts boxplots showing the number of direct and transitive package relationships split by network type over time. Each sub-plot also features

line plots showing the mean with a circle for each snapshot. By using three different network representations, we can understand and contrast the differences between the three approximations of dependency relationships. In the following, we first report relationships between packages from a dependency perspective and then from a dependent perspective. Lastly, we view the same relationships from a function-level perspective in Figure 9.

Direct dependencies Direct dependencies refer to the dependencies that a developer specifies in a package manifest. For each network group in Figure 8a, we see a marginal growth in the median number of direct dependencies over time. The median number of dependencies for a package grew from two to three between 2015-2020 for the CRATES.IO index network as an example. The median is also similar in the other two networks. Although there are notable differences in the overall spread in the formative years of CRATES.IO, the growth curve is relatively comparable between the networks. When comparing the mean between the CDN and the CRATES.IO index network, we find the average package call 87.5% of its direct dependencies. As the CRATES.IO index network has a higher overall spread than the Docs.rs network, and the Docs.rs network has a higher overall spread than the CDN, we can derive that the CRATES.IO network represents an upper-bound and the CDN a lower-bound on the number of direct dependencies. With 75% of all packages having less than six direct dependencies, the results are overall similar to the findings of Decan et al. (2019) and Kikas et al. (2017).

Package maintainers roughly use 2 to 3 direct dependencies and are unlikely to increase their use over time. The three networks have comparable results.

Transitive dependencies Transitive dependencies represent the indirect dependencies of a package after resolving its specified dependencies. In comparison to the direct dependencies, in Figure 8b, we can observe a superlinear growth for the three networks over time. The median number of transitive dependencies in 2015 is 5 for the CRATES.IO index network and 1 for the other two networks. The median number of transitive dependencies grew with a delta of 5 additional packages for the CDN, 9 for the Docs.rs network, and 12 for the CRATES.IO index network in five years. While we can find a similar continuing growth trend to Figure 8a, we observe higher degrees of dispersions between the CDN and the other two networks. The third-quartile in nearly all CDN snapshots is the same or below the median of the other two networks. Thus, half the packages in the CRATES.IO index network and Docs.rs network report a higher number of transitive dependencies than 75% of packages in the CDN. When comparing the mean between the CDN and the CRATES.IO index network in 2020, we find the average package call 40% of its resolved transitive dependencies. The discrepancy indicates substantial differences between call-based and metadata-based networks in network analyses; CDNs will overall

report a notably lower number of transitive dependencies than the metadata ones.

The average dependency tree of resolved packages has nearly grown thrice; 5 to 17 transitive dependencies in 5 years. Substantial differences exist between the networks; packages are indirectly not calling 60% of its resolved transitive dependencies.

Direct dependents In addition to dependencies, another commonly studied package relationship are dependents (also known as *reverse* dependencies), which measure the number of consumers a package has. In the context of this study, we consider a consumer as an internal consumer (i.e., a package making use of another package within CRATES.IO). Figure 8c depicts boxplots for the number of dependents over time. Irrespective of the network, we can see that the median number of consumers per package remains unchanged at one over time. Similarly, we can also find the interquartile ranges of the networks to be identical from June 2017 and onwards. In that period, the top 25% packages have at-least three or more consumers. When comparing the mean over time, we see a steady growth of the number of direct dependents for the three networks. The growth pattern is a result of a few commonly used packages (e.g., `serde` and `log`) having the largest share of consumers in CRATES.IO (see also Figure 5). The outliers in the boxplot represents the top-most dependents (or used) packages for each network. Here, we can observe notable differences in the range and number of outliers between the networks. The number of top dependent packages in June 2018 is 651 for the CDN, 1245 for the `Docs.rs` network, and 1680 for the CRATES.IO index network. There are 2.5x more top-dependent packages for CRATES.IO than in the CDN. When comparing the top-most dependent packages in each network, the most consumed package has 566 dependents in CDN, 1735 in the `Docs.rs` network, and 2305 in the CRATES.IO index network. Although the gap between the outliers in the networks reduces over time (i.e., from 2.5x to 1.8x in 2020), there are notable differences between the networks when analyzing the top-most dependent packages in CRATES.IO.

Overall, the results are similar to the findings of both Decan et al. (2019) and Kikas et al. (2017), suggesting that an average CRATES.IO package has a relatively constant and low degree of consumers in general. While the networks seem comparable and interchangeable at large, there is a notable discrepancy between the outliers (i.e., topmost used packages in CRATES.IO) in metadata-based networks and call-based networks in earlier snapshots, potentially yielding differences in network analyses of top dependent packages.

The average number of consumers of a package remains at one over time. There is a notable change among consumers of top-dependent packages over time; they are more than ever calling packages that they declare.

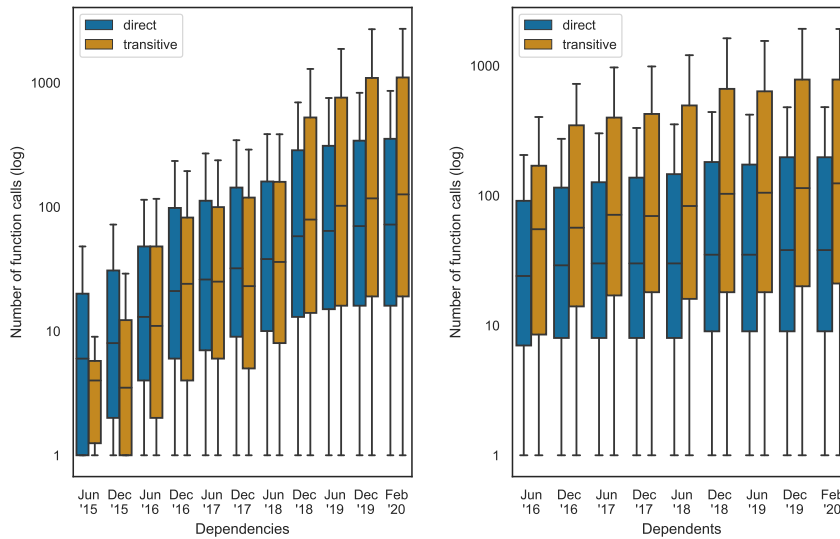

Fig. 9: The evolution of the number of functions calls to dependencies and dependents

Total dependents Figure 8d shows the total number of dependents per package. The total number of dependents include both direct and transitive dependents. We omit both June and December 2015 as these snapshots only have 19 and 47 transitive dependents in the CDN, respectively. Except for June 2016, the median number of total dependents remains constant at two for the three networks. Thus, in addition to the one median direct consumer in Figure 8c, packages also have one median transitive consumer. When looking at the top 25% consumed packages, the number of total dependents ranges from 8 or more consumers for the CRATES.IO index network and 7 or more consumers for the remaining networks. There is also a slight increase in the overall range at two occurrences for the CDN (Feb'17, Dec'19) and one occurrence for the Docs.rs network (Dec'17) and the CRATES.IO index network (Dec'19). When comparing the mean and outliers between the networks, we find a similar growth pattern and gap to Figure 8c. Overall, we see that the total number of dependents remains stable over time with a few instances of gradual increases. Moreover, we see that the distributions of dependents are generally much lower in comparison to the transitive dependency relationships in Figure 8b. Thus, the results indicate that an average package in CRATES.IO has a handful stable number of consumers.

The average package also has one transitive consumer that remains unchanged over time. Similar to direct top-most dependent packages; indirect consumers are using them to a much higher degree than previously.

Evolution of direct and transitive inter-package function calls Using only the CDN snapshots, we can quantify the use of external APIs in package dependencies. Figure 9 describes the evolution of the number of direct and transitive inter-package (i.e., API) calls per package for dependencies on the left-hand side and dependents on the right-hand side. When looking at the number of calls to dependencies over time, we make two major observations. First, the number of direct and transitive calls to dependencies has a superlinear growth over time. From December 2016 to December 2019, the number of direct calls grew from 21 (transitive: 24) to 70 (transitive: 116), a three-fold increase in three years. On average, we also see a biannually growth of 6.6 new function calls to direct dependencies and 12.2 new indirect calls to transitive dependencies. Second, we can see that the median number of transitive calls overtakes the median number of direct calls in December 2018. Our findings unveil that the amount of calls to indirect APIs are comparable in numbers to calls of direct APIs. Recent snapshots further indicate that packages invoke more indirect APIs than direct APIs. The transitive median API calls in December 2019 is 1.6x larger than the median direct API calls.

The average API usage of transitive dependencies is both greater and comparative to direct dependencies in recent years.

Similar to the total dependents in Figure 8d, we also omit the two snapshots in 2015 due to an insignificant number of transitive dependents. Generally, we can observe a continuous growth of the number of direct and transitive consumers of package APIs over time. The median number of consumer grew from 25 callers in 2015 to 38 callers in 2020, an average growth of 1.6 new functions per year. The median of indirect consumers is larger than that of direct consumers, growing from 55 callers in 2015 to 124 callers in 2020, an average of 8.75 new functions biannually. When comparing the growth pattern between direct and transitive dependents, the gap between the median of direct dependents and transitive dependents expands over time. Moreover, we also find that the interquartile ranges and overall range is greater for transitive dependents than for direct dependents in all snapshots. A package with transitive dependents is likely to have more indirect callers than direct callers of their APIs. Notably, the median number of transitive dependent callers (median: 114) is three times larger than the median of direct dependent callers (median: 38) in 2020. When also taking into account the findings of transitive dependency callers, our results strongly indicate that indirect users of library APIs is both highly prevalent in CRATES.IO, and comparable to direct users of library APIs. Despite the largely unchanged number of direct and total dependents (See Figure 8cd) over time, we see indications that developers are increasingly using more APIs over time.

Packages with transitive consumers have three times more API callers stemming from indirect consumers than direct consumers.

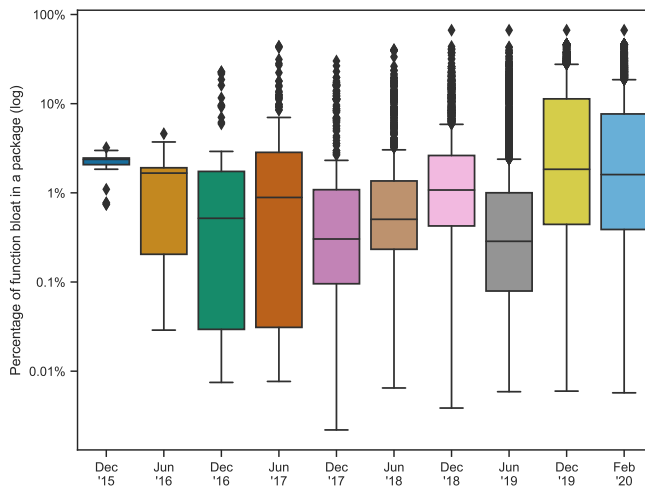

Fig. 10: Percentage of co-existing functions (i.e., bloat) in CRATES.IO packages

Below, we summarize the two perspectives of package relationships using both the metadata-based results with function-based results:

Dependencies: Package managers are pulling in a larger number of transitive dependencies over time. Package maintainers, however, are not drastically declaring more dependencies. Although there is an increase of new direct and indirect API calls to dependencies over time, roughly 60% of all resolved transitive dependencies are not called.

Dependents: The number of total dependents, one direct and one transitive consumer, remains constant over time. However, consumers have a growing number of callers over time. For packages with transitive consumers, there is a higher number of calls stemming from indirect callers than direct callers.

5.3.4 Co-existing dependency functions

Packages depending on a growing number of external packages are also likely to introduce dependency conflicts. Conflicts arise when a dependency resolver is unable to eliminate the co-existence of a package in a dependency tree due to version incompatibility. For example, a resolver may arrive that there is no overlapping version when two packages in a dependency tree depend on package A where the former specifies a version constraint 1.* and the latter 2.*. Rust's CARGO package manager avoids such conflicts by allowing multiple versions of the same package to co-exist in a dependency tree using *name mangling* techniques (Katz 2016). A potential drawback of this strategy is

the risk of bloating binaries due to multiple copies of identical yet obfuscated functions.

As a step towards an indicative measure of function bloat in binaries, we calculate the percentage of co-existing functions for all public functions in CRATES.IO. We denote a co-existing function as multiple copies of identical function identifiers loaded from different versions of the same package. It is important to note that the measure is an estimation and does not validate the semantic equivalence of functions. Before measuring the percentage of co-existing functions, we first inspect the presence of co-existing functions in all CRATES.IO packages. On average, we find packages having at-least one co-existing function to be 5.4% of CRATES.IO in Dec 2015-Dec 2017 and 28% of CRATES.IO in Jun 2018-Feb 2020. There are no packages with co-existing functions in June 2015. Largely non-existent in the formative years of CRATES.IO, we find that function co-existing among dependencies is relatively prevalent in recent years.

Among packages having co-existing functions, Figure 10 breaks down the percentage of co-existing functions in dependencies of packages over time. We can observe that the median fluctuates between 0.3% and 1.6% over time, indicating a constant yet insignificant amount of function co-existence in packages. 75% of all packages range between 1 to 10% co-existing functions in their dependencies, suggesting that a majority of packages have a small amount of possible bloat in their binaries. Thus, bloating of binaries from co-existing dependency functions are highly unlikely for most packages in CRATES.IO.

Finally, we find a small minority (i.e., outliers) of packages with a high degree of possible function bloat between December 2018 and February 2020. The package reporting the highest bloat of this time frame is `downward` with 67% bloat. However, it is an invalid outlier as it has a circular dependence on itself.¹⁸ Thereby, the two packages with highest bloat is `const-c-str-impl` and `mpris` with 43% and 46% bloat, respectively. Upon manual inspection of their respective dependency tree, we identify that the packages have a dependence on multiple versions of `proc_macro`, `quote`, `syn`, and `unicode_xid`, common libraries for creating procedural macros. For example, `mpris` uses four different versions of `syn` and `quote`.¹⁹ We also make similar observations in three other outliers: `js-object` (33%), `js-intern-proc-macro` (41%), and `mockers_derive` (43%). Further investigation could perhaps reveal whether the combination of certain procedural macros libraries are highly likely to always result in bloated dependency tree configurations.

Co-existing functions exist in a small number of packages in CRATES.IO. Potential bloat range between 1-10%.

¹⁸ <https://crates.io/crates/downwards>

¹⁹ <https://docs.rs/crate/mpris/2.0.0-rc2/source/Cargo.lock>

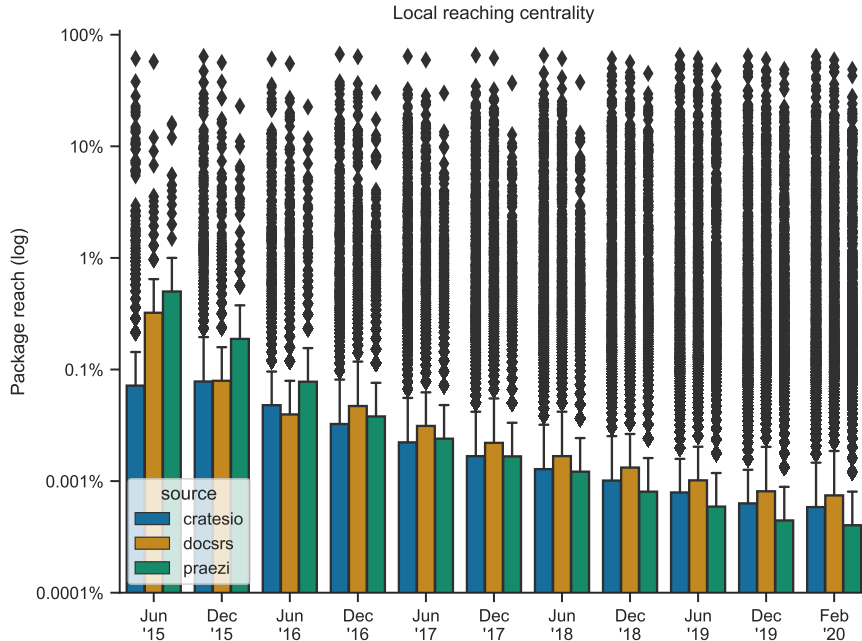

Fig. 11: Distribution of Package Reachability

Table 6: Most central APIs in the largest component in Dec 2015, Dec 2017, and Feb 2020

2015 (size: 534)			2017 (size: 6,004)			2020 (size: 24,857)		
Package	Function	Reach	Package	Function	Reach	Package	Function	Reach
pkg-config:0.3.6	find_library	10%	log:0.3.8	__log	16%	log:0.4.10	max_level	30%
gcc:0.3.20	Build::new	6%	libc:0.2.34	memchr	12%	serde:1.0.104	next_element	24%
libc:0.2.1	memchr	6%	lazy_static:0.2.11	get	11%	bitflags:1.2.1	__fn_bitflags	23%
log:0.3.4	__static_max_level	6%	bitflags:1.0.1	__fn_bitflags	8%	lazy_static:1.4.0	get	21%
bitflags:0.3.3	bitflags	3%	unicode-width:0.1.4	width	8%	libc:0.2.66	sysconf	18%
gcc:0.3.20	Build::compile	3%	serde:1.0.24	deserialize	6.3%	libc:0.2.66	isatty	18%
log:0.3.4	log::macros::log	6%	lazy_static:0.2.11	lazy_static	5.95%	memchr:2.3.2	memchr	18%
gcc:0.3.20	compile_library	4%	byteorder:1.2.1	write_u32	5.1%	itoa:0.4.5	Buffer::new	17.5%
time:0.1.34	precise_time_ns	2.5%	libc:0.2.34	localtime_r	5%	ryu:1.0.2	Buffer::format_finite	17%
libc:0.2.1	sysconf	2.5%	time:0.1.38	num_seconds	4.1%	serde.json:1.0.48	from_str	10%

5.4 RQ3: Reachability

Our goal in **RQ3** is to identify packages that indirectly reach most of CRATES.IO and understand the differences and similarities in using different networks for impact analyses of package repositories. We use the local reaching centrality (Mones et al. 2012) to measure the reach of individual packages in the CDN, compile-validated metadata (i.e., Docs.rs), and regular metadata (CRATES.IO) networks. With reach, we measure the fraction of CRATES.IO packages that depend on a particular package (i.e., its transitive dependents).

Figure 11 presents the evolution of the reach of each package per network. When comparing the third-quartile between the snapshots, we can observe a

gradual decrease of reachability over time. The top 25% of the distribution of for the CRATES.IO index network have a ten-fold decrease of 0.07% in June 2015 to 0.008% in June 2019. Both the CDN and Docs.rs distribution also follow a similar pattern. In comparison to recent years, the higher reach of packages in the formative years reflects the small network size. In the remaining 75% of packages, they have no or limited reach of CRATES.IO irrespective of network choice, indicating that a majority of packages do not exhibit any influence in CRATES.IO. However, we can observe that the range and number of outliers expand over time, indicating that there is an increasing number of packages that exhibit a degree of influence in CRATES.IO. The number of outliers with greater than 10% reachability grew from 19 (Docs.rs/CDN: 3) to 92 (Docs.rs: 80, CDN: 66) packages as an example.

For each snapshot, we can see that the top-most outlier and the number of outliers is lower than that of the metadata-based network in each network. The most reachable package in June 2019 reaches 65% in the CRATES.IO index network, 61% in the Docs.rs network, and 47% in the CDN network.

Upon inspection of the top 10 highest reaching outliers in each network, we see that a similar set of packages such as `libc`, `log`, `lazy_static`, and `bitflags` remains prominent over time across the networks. These packages are also among the most directly called packages in Section 5.2.2. `libc`, one of the most downloaded packages in CRATES.IO, is the package exhibiting the highest all-time influence in CRATES.IO. There are also packages in decline: `rustc-serialize`, a serializer package, decreased in reach from its peak of 17% in 2016 to 2% in 2020. A potential explanation for its decline could be the adoption of `serde`, a rivaling serializer package, that grew its reach from 6% in 2016 to 42% in 2020.

We derive the ten most influential APIs by measuring the local reach centrality on functions of the CDN for 2015, 2017, and 2020 in Table 6.²⁰ Overall, we note that individual functions have a lower reach than aggregated together as a package (Figure 11). Although `libc` exhibit the highest reach at the package-level, functions in `log` or `serde` exhibit higher influence than individual functions in `libc`. Moreover, we can see that `libc`, `log`, and `bitflags` have remained important since the inception of CRATES.IO. However, we can observe that the most called function changes over time. For example, `log` reports three distinctly different API functions. A possible explanation could be that new features or best practices over time change the use of APIs. Finally, we can also see a new fast-growing entrant in 2020: `serde` is second to `log`.

A large majority of packages do not pose a threat to CRATES.IO; a handful of packages can reach 47% of CRATES.IO. Among individual functions, the reach is at most 30% of CRATES.IO.

²⁰ due to presentation reasons, we showcase for only three years

6 Discussion

We center our discussion on two key aspects; differences and similarities between using three different networks for network analyses and studying function relationships on a network level.

6.1 Strengths and Weaknesses between Metadata and Call-based Networks

As package repositories do not test whether a package can build or not, developers can by mistake or unknowingly publish broken versions to CRATES.IO. By verifying the build of package releases, the Docs.rs network excludes package releases that do not have a successful build record. When comparing the results of the network analyses in Figure 8 with CRATES.IO index network, overall, we find them to have comparable results except in the formative years of CRATES.IO. The diverging results in the initial years show that a large number of releases are not reproducible and consumable, stressing the importance of performing additional validation besides the correctness of packages manifests. Thereby, we argue researchers to minimally validate package manifests with external information such as publically available build and test data for network studies of package repositories.

When comparing the network analysis results in Figure 8, we find notable similarities and differences between metadata-based and call-based networks for CRATES.IO. Except for the formative years of CRATES.IO, the distributions of recent snapshots for direct dependencies, direct dependents, and total dependents are mostly similar between the networks. Thus, a network inferred from CRATES.IO metadata closely approximates the presence of function reuse relationships between packages without needing to construct and verify with call graphs. Recent snapshots of CRATES.IO further indicate that recent package releases are highly likely to be reproducible and compile as well. On the other hand, there are also significant differences between the networks, specifically for transitive dependencies and outliers in dependent distributions. By taking into account that a developer does not make use of all APIs available in a package, we identify a two-fold difference between call-based and metadata-based networks. These differences also manifest among the most popular dependent packages (i.e., outliers)—despite the networks reporting similar results for the average dependent package.

Based on the discussed similarities and differences, we do not pitch a network as more accurate than the other as there is no ground truth for package repositories. Instead, we call for a careful treatment on how we assess and study relationships between packages. On a semantic note, the dependencies that a developer specifies in a package manifest denote the developer’s intention to use external libraries in their application. It is incorrect to consider the intent to use a package as using it—a fallacy commonly seen in previous studies (Kula et al. 2017; Kikas et al. 2017; Decan et al. 2019; Wittern et al. 2016). An inter-package call, on the other hand, explicitly denotes that a

package uses a dependency through a function call. Thus, metadata-based and call-based networks are two networks with different semantics; the metadata network models how packages make declarations between each other, and the CDN informs on how packages reuse each other through functions.

Despite their semantic differences, we can use the metadata-based networks to approximate the reuse relationships between packages and vice versa for declarations as mentioned earlier. As a practical implication from our findings, dependency management toolings such as `Dependabot` an automated dependency updater, and `cargo audit`, a known vulnerability scanner, are likely to make a more accurate recommendation for affected direct dependencies than transitive dependencies in projects. Actual reuse of functions is more likely to occur for declared direct dependencies than transitive dependencies (see Section 5.3.3).

6.2 Transitive API Usage

Datasets such as `fine-GRAPE` (Sawant and Bacchelli 2017) provide researchers with information on API usage for understanding the evolution and impact of deprecation (Robbes et al. 2012; Sawant et al. 2018b) and refactoring (Kula et al. 2018) decisions in libraries. As demonstrated in (Robbes et al. 2012)’s API deprecation analysis of the Smalltalk ecosystem, the absence of sequences or chains of API calls in such datasets limits the scope of additional confounding variables influencing the decision-making of APIs.

By analyzing call paths between packages and its direct and transitive dependencies on external packages, we identify that the indirect API uses in transitive dependencies are greater than that of direct dependencies in recent snapshots. To a limited degree, we are increasingly seeing APIs co-existing under the same application space. Although developers do not have control of transitive package dependencies, they have the same execution right and follow the same law of software evolution (Lehman 1980) as direct dependencies. Thus, API decisions in transitive dependencies can equally impact clients as direct dependencies. For example, a user in PR #20 of IDnow SDK,²¹ an identity verification framework, is persuading the maintainers to drop dependence on Sentry, an application monitoring platform, due to the user having problems with Sentry as a co-existing dependency in its application. With indirect API usage exceeding the level of direct API usage, we call for researchers to not only study APIs horizontally but also vertically. By studying APIs from a vertical view, we can tap into the evolution of API call chains spanning several libraries and thier implications of co-existing APIs.

²¹ <https://github.com/idnow/de.idnow.ios.sdk/issues/20>

7 Threats to Validity

In this section, we discuss limitations and threats that can affect the validity of our study and show how we mitigated them.

7.1 Internal validity

For CDNs to closely mirror actual package reuse in CRATES.IO, we only consider packages specified under the `#[dependencies]` section and optionally-enabled packages as these are consumable in the source code. As packages in `#[dependencies]` are also available in the test portion of packages, developers could potentially specify packages for testing purposes that do not attribute towards package reuse. We mitigate the risk of inferring test specific calls by restricting the build of packages to compilation without further execution steps such as tests.

The `rust-callgraphs` generator can resolve function invocations that involve static and dynamic dispatch except for function pointer types. Although the documentation²² states that function pointers have a specific and limited purpose, we acknowledge that we cannot make any claims around the completeness of generated CDNs due to the general absence of ground truth for package repositories. When limiting the scope to the features that the call graph generator supports, the generated CDNs represent an over-approximation of function calls in CRATES.IO. It is an over-approximation as function targets in dynamic dispatch may never be called by the end-user in practice (i.e., it is inexact). Using additional analysis such as dynamic analysis to remove all unlikely function targets is error-prone and could result in unsound inferences. Thus, we avoid considering both static (i.e., exact) and dynamic (i.e., inexact) function calls as the same. Instead, we view the results of dynamically dispatched calls from the perspective of virtual method tables (i.e., its concrete representation during runtime).

Real-world constraints such as non-updated caches of the repository index, user-defined dependency patches, and deviating semver specifications could influence the actual version resolution of package dependencies. The selection of packages and their versions for creating snapshots has additional implications on the representativeness of CRATES.IO and its users. To mitigate the risk of making incoherent versions resolutions, we create Python-to-Rust bindings using the exact resolver component implemented in CARGO, ensuring the same treatment of version constraints.

Kikas et al. (2017) report the highest package reach to be up to 30% in 2015 while our CRATES.IO metadata network report over 60%, nearly twice the number. The difference lies in the selection of packages when creating the networks: Kikas et al. (2017) build a dependency tree for all available versions of a package valid at timestamp t and we build a tree for the single most recent version of a package at a timestamp t . As there is no consensus on best

²² <https://doc.rust-lang.org/book/first-edition/trait-objects.html>

practices for which packages and releases to include in a network, we take a conservative approach that avoids including dormant and unused releases. For example, we argue that it is rare that a user today would declare a dependence on version dating back to 2017 when newer versions from 2019 exist. Kikas et al. (2017) would include such versions.

7.2 External and reliability validity

We acknowledge that the results of network analysis are not generalizable to other package repositories and only explain properties of CRATES.IO. Due to differences in community values (Bogart et al. 2016) and reuse practices of packages, we expect network analyses to yield different results. However, based on (Decan et al. 2018b) comparison of seven package repositories, we believe certain repositories, for example, NPM and NUGET may share some similarities with CRATES.IO than with CRAN and CPAN.

The PRÄZI approach to constructing a CDN is general applicability as long as the programming language has a resolver for package dependencies and a call graph generator. However, the soundness of generated CDNs may vary depending on the programming language. For example, CDNs generated for Java are more accurate and practical than CDNs for Python due to limited call graph support. Therefore, evaluating trade-offs in terms of precision and recall plays an important role in whether a study scenario is suitable for CDN analysis.

For the reproducibility of our approach, generated CDNs, and study, we have made the source code, the processing scripts and our data publicly available in a replication package available at <https://github.com/praezi/rust-emse-2020>

8 Future work

Our work opens an array of opportunities for future work in data-driven analysis of package repositories, both for researchers and tool builders.

8.1 Enabling data-driven insights into code reuse with network analysis

As functions are not the only form of achieving code reuse, we aim to explore how we can model reuse of interfaces, generics, class hierarchies, and wrapper classes as networks. In a similar spirit to enabling data-driven insights of APIs, language designers can use data-driven models to understand patterns and adoption of certain code reuse practices. As Rust advocates developers to prefer using generics over trait objects and limit the use of unsafe code constructs, language designers can verify such premises with feedback through network- and data-driven analyses of package repositories.

Following Zhang et al. (2020a)’s need-finding study on data-driven API design, we are investigating possibilities to mine program contexts and error-inducing patterns using PRÄZI to extract API usage patterns beyond syntactic features and frequencies. Insights into involved API usage patterns can help library maintainers to make changes echoing improvements that simplify code reuse and strengthening the stability of a package repository.

8.2 Modeling socio-technical risks of package abandonment

Package repositories are successful in attracting developers to release new packages. However, they are less successful in keeping these packages maintained on a long-term perspective. As a result of developers abandoning packages due to shifting priorities, unmaintained packages are increasingly jeopardizing the security and stability of package repositories. Notably, the *event-stream* incident (Baldwin 2018) is emerging as a textbook example of how the abandonment of a package turned itself into a bitcoin stealing apparatus affecting thousands of users. While survival analysis of packages can yield insights into the stages of abandonment (Valiev et al. 2018), understanding the social-technical motives behind developer abandonment could potentially help develop a risk control model that package repository owners can exercise. As an example, when a package repository recognizes the slowdown of development activities of popular yet central packages, they could explore incentives such as monetary support, developer assistant in resolving long-running bug reports, or discuss possible handover to a network of trustful developers. We are exploring both quantitative and qualitative strategies on how to model and mitigate risks around package abandonment using PRÄZI.

9 Conclusions

In this work, we devise PRÄZI, an approach combining manifests and call graphs of packages to infer dependency networks of package repositories at the function granularity. By implementing PRÄZI for Rust’s CRATES.IO, we showcase the feasibility of compiling and generating call graphs for 70% of all indexed releases. Then, we compare the CRATES.IO CDN against a conventional metadata-based network and an enhanced corroborated version with compile data in a replication study to understand their differences and similarities in network analysis common to package repositories and derive new insights offers CRATES.IO. By using function call data, we find that packages do not indirectly call 60% of their transitive dependencies. Packages that have transitive consumers are likely to have three times more calls from indirect users than direct users. When we investigated the trends of function calls, we observed that packages biannually make 6.6 new direct and 12.2 new indirect calls to dependencies over time. A majority of packages do not pose a threat to the stability of CRATES.IO; the most reachable function in

2020—`max-level()` in package `log`—reaches 30% of all CRATES.IO packages. When comparing the three studied networks, we find that metadata-based networks closely approximates the CDN for analysis involving direct dependencies, direct dependents, and transitive dependents. Analysis of transitive package relationships and top-most dependent packages, on the other hand, yield significantly different results for the studied networks. Here, a metadata network reports on average two times more transitive dependencies than a CDN. Thus, dependency checkers such as Rust’s `cargo-audit` and GITHUB’s `Dependabot` are likely to incorrectly make recommendations on potentially unused transitive dependencies. Overall, PRÄZI opens up new doors to precise network analysis of code reuse and APIs of package repositories.

References

- Abdalkareem R, Nourry O, Wehaibi S, Mujahid S, Shihab E (2017) Why do developers use trivial packages? an empirical case study on npm. In: Proceedings of the 2017 11th Joint Meeting on Foundations of Software Engineering, ACM, pp 385–395
- Abdalkareem R, Oda V, Mujahid S, Shihab E (2019) On the impact of using trivial packages: an empirical case study on npm and pypi. *Empirical Software Engineering* pp 1–37
- Albert R, Barabási AL (2002) Statistical mechanics of complex networks. *Reviews of modern physics* 74(1):47
- Ali K, Lhoták O (2012) Application-only call graph construction. In: European Conference on Object-Oriented Programming, Springer, pp 688–712
- Alimadadi S, Mesbah A, Pattabiraman K (2015) Hybrid dom-sensitive change impact analysis for javascript. In: 29th European Conference on Object-Oriented Programming (ECOOP 2015), Schloss Dagstuhl-Leibniz-Zentrum fuer Informatik
- Aparicio J (2019) `cargo-call-stack`: Static, whole program stack analysis. <https://github.com/japaric/cargo-call-stack>
- Backstrom L, Boldi P, Rosa M, Ugander J, Vigna S (2012) Four degrees of separation. In: Proceedings of the 4th Annual ACM Web Science Conference, pp 33–42
- Baldwin A (2018) Details about the event-stream incident. <https://blog.npmjs.org/post/180565383195/details-about-the-event-stream-incident>
- Bogart C, Kästner C, Herbsleb J, Thung F (2016) How to break an API: Cost negotiation and community values in three software ecosystems. In: Proceedings of the 2016 24th ACM SIGSOFT International Symposium on Foundations of Software Engineering, ACM, pp 109–120
- Boldi P, Codenotti B, Santini M, Vigna S (2004) Ubicrawler: A scalable fully distributed web crawler. *Software: Practice and Experience* 34(8):711–726
- Brian A, David T, Aaron T (2020) The rust libz blitz. <https://blog.rust-lang.org/2017/05/05/libz-blitz.html>

- Chen L, Hassan F, Wang X, Zhang L (2020) Taming behavioral backward incompatibilities via cross-project testing and analysis. In: IEEE/ACM International Conference on Software Engineering
- Cogo FR, Oliva GA, Hassan AE (2019) An empirical study of dependency downgrades in the npm ecosystem. *IEEE Transactions on Software Engineering*
- Decan A, Mens T, Constantinou E (2018a) On the impact of security vulnerabilities in the npm package dependency network. In: International Conference on Mining Software Repositories
- Decan A, Mens T, Grosjean P (2018b) An empirical comparison of dependency network evolution in seven software packaging ecosystems. *Empirical Software Engineering*
- Decan A, Mens T, Grosjean P (2019) An empirical comparison of dependency network evolution in seven software packaging ecosystems. *Empirical Software Engineering* 24(1):381–416
- Dietrich J, Pearce D, Stringer J, Tahir A, Blincoe K (2019) Dependency versioning in the wild. In: 2019 IEEE/ACM 16th International Conference on Mining Software Repositories (MSR), IEEE, pp 349–359
- Duan R, Bijlani A, Xu M, Kim T, Lee W (2017) Identifying open-source license violation and 1-day security risk at large scale. In: Proceedings of the 2017 ACM SIGSAC Conference on computer and communications security, pp 2169–2185
- Dunn J (2017) Pypi python repository hit by typosquatting sneak attack. <https://nakedsecurity.sophos.com/2017/09/19/pypi-python-repository-hit-by-typosquatting-sneak-attack/>
- Emami M, Ghiya R, Hendren LJ (1994) Context-sensitive interprocedural points-to analysis in the presence of function pointers. *ACM SIGPLAN Notices* 29(6):242–256
- Hejderup J (2015) In dependencies we trust: How vulnerable are dependencies in software modules? Master’s thesis, Delft University of technology
- Hejderup J, van Deursen A, Gousios G (2018) Software ecosystem call graph for dependency management. In: Proceedings of the 40th International Conference on Software Engineering: New Ideas and Emerging Results, ACM, pp 101–104
- Katz Y (2016) Cargo: predictable dependency management. <https://blog.rust-lang.org/2016/05/05/cargo-pillars.html>
- Kikas R, Gousios G, Dumas M, Pfahl D (2017) Structure and evolution of package dependency networks. In: Proceedings of the 14th International Conference on Mining Software Repositories, IEEE Press, pp 102–112
- Kula RG, De Roover C, German DM, Ishio T, Inoue K (2017) Modeling library dependencies and updates in large software repository universes. arXiv preprint arXiv:170904626
- Kula RG, Ouni A, German DM, Inoue K (2018) An empirical study on the impact of refactoring activities on evolving client-used apis. *Information and Software Technology* 93:186–199

- Lehman MM (1980) Programs, life cycles, and laws of software evolution. *Proceedings of the IEEE* 68(9):1060–1076
- Livshits B, Sridharan M, Smaragdakis Y, Lhoták O, Amaral JN, Chang BYE, Guyer SZ, Khedker UP, Møller A, Vardoulakis D (2015) In defense of soundness: a manifesto. *Communications of the ACM* 58(2):44–46
- Martins P, Achar R, Lopes CV (2018) 50k-c: A dataset of compilable, and compiled, java projects. In: 2018 IEEE/ACM 15th International Conference on Mining Software Repositories (MSR), IEEE, pp 1–5
- Matsakis N (2016) Introducing mir. <https://blog.rust-lang.org/2016/04/19/MIR.html>
- Mezzetti G, Møller A, Torp MT (2018) Type regression testing to detect breaking changes in node. js libraries. In: 32nd European Conference on Object-Oriented Programming (ECOOP 2018), Schloss Dagstuhl-Leibniz-Zentrum fuer Informatik
- Mones E, Vicsek L, Vicsek T (2012) Hierarchy measure for complex networks. *PloS one* 7(3):e33799
- Mujahid S, Abdelkareem R, Shihab E, McIntosh S (2020) Using others’ tests to avoid breaking updates. In: Proceedings of the 17th International Conference on Mining Software Repositories (MSR’20), p To Appear
- Nguyen HA, Nguyen TN, Dig D, Nguyen S, Tran H, Hilton M (2019) Graph-based mining of in-the-wild, fine-grained, semantic code change patterns. In: 2019 IEEE/ACM 41st International Conference on Software Engineering (ICSE), IEEE, pp 819–830
- Ponta SE, Plate H, Sabetta A (2018) Beyond metadata: Code-centric and usage-based analysis of known vulnerabilities in open-source software. arXiv preprint arXiv:180605893
- Porter MA, Onnela JP, Mucha PJ (2009) Communities in networks. *Notices of the AMS* 56(9):1082–1097
- Preston-Werner T (2013) Semantic versioning. <https://semver.org/>
- Raemaekers S, van Deursen A, Visser J (2017) Semantic versioning and impact of breaking changes in the maven repository. *Journal of Systems and Software* 129:140–158
- Raymond ES (2003) *The art of Unix programming*. Addison-Wesley Professional
- Robbes R, Lungu M, Röthlisberger D (2012) How do developers react to api deprecation? the case of a smalltalk ecosystem. In: Proceedings of the ACM SIGSOFT 20th International Symposium on the Foundations of Software Engineering, pp 1–11
- Ryder BG (1979) Constructing the call graph of a program. *IEEE Transactions on Software Engineering* (3):216–226
- Sawant AA, Bacchelli A (2017) fine-grape: fine-grained api usage extractor—an approach and dataset to investigate api usage. *Empirical Software Engineering* 22(3):1348–1371
- Sawant AA, Aniche M, van Deursen A, Bacchelli A (2018a) Understanding developers’ needs on deprecation as a language feature. In: 2018 IEEE/ACM 40th International Conference on Software Engineering (ICSE), IEEE, pp

- 561–571
- Sawant AA, Aniche M, van Deursen A, Bacchelli A (2018b) Understanding developers’ needs on deprecation as a language feature. In: Proceedings of the 40th International Conference on Software Engineering, ACM, New York, NY, USA, ICSE ’18, pp 561–571
- Sawant AA, Robbes R, Bacchelli A (2018c) On the reaction to deprecation of clients of 4+ 1 popular java apis and the jdk. *Empirical Software Engineering* 23(4):2158–2197
- Schlueter I (2013) Unix philosophy and node.js. <https://blog.izs.me/2013/04/unix-philosophy-and-nodejs>
- Schlueter I (2017) The npm blog — kik, left-pad, and npm. <http://blog.npmjs.org/post/141577284765/kik-left-pad-and-npm>
- Shapiro M, Horwitz S (1997) Fast and accurate flow-insensitive points-to analysis. In: Proceedings of the 24th ACM SIGPLAN-SIGACT symposium on Principles of programming languages, pp 1–14
- Shivers O (1991) Control-flow analysis of higher-order languages. PhD thesis, PhD thesis, Carnegie Mellon University
- Steensgaard B (1996) Points-to analysis in almost linear time. In: Proceedings of the 23rd ACM SIGPLAN-SIGACT symposium on Principles of programming languages, pp 32–41
- Sulír M, Porubán J (2016) A quantitative study of Java software buildability. In: Proceedings of the 7th International Workshop on Evaluation and Usability of Programming Languages and Tools, ACM, pp 17–25
- Sundaresan V, Hendren L, Razafimahefa C, Vallée-Rai R, Lam P, Gagnon E, Godin C (2000) Practical virtual method call resolution for Java, vol 35. ACM
- Tip F, Palsberg J (2000) Scalable propagation-based call graph construction algorithms. In: Proceedings of the 15th ACM SIGPLAN conference on Object-oriented programming, systems, languages, and applications, pp 281–293
- Triantafyllou K (2019) A benchmark for rust call-graph generators. <https://users.rust-lang.org/t/a-benchmark-for-rust-call-graph-generators/34494>
- Tufano M, Palomba F, Bavota G, Di Penta M, Oliveto R, De Lucia A, Poshyanyk D (2017) There and back again: Can you compile that snapshot? *Journal of Software: Evolution and Process* 29(4)
- Valiev M, Vasilescu B, Herbsleb J (2018) Ecosystem-level determinants of sustained activity in open-source projects: a case study of the pypi ecosystem. In: Proceedings of the 2018 26th ACM Joint Meeting on European Software Engineering Conference and Symposium on the Foundations of Software Engineering, ACM, pp 644–655
- Wittern E, Suter P, Rajagopalan S (2016) A look at the dynamics of the JavaScript package ecosystem. In: Mining Software Repositories (MSR), 2016 IEEE/ACM 13th Working Conference on, IEEE, pp 351–361
- Xavier L, Brito A, Hora A, Valente MT (2017) Historical and impact analysis of api breaking changes: A large-scale study. In: 2017 IEEE 24th In-

- ternational Conference on Software Analysis, Evolution and Reengineering (SANER), IEEE, pp 138–147
- Zerouali A, Constantinou E, Mens T, Robles G, González-Barahona J (2018) An empirical analysis of technical lag in npm package dependencies. In: International Conference on Software Reuse, Springer, pp 95–110
- Zhang T, Hartmann B, Kim M, Glassman EL (2020a) Enabling data-driven api design with community usage data: A need-finding study. In: Proceedings of the 2020 CHI Conference on Human Factors in Computing Systems, pp 1–13
- Zhang T, Hartmann B, Kim M, Glassman EL (2020b) Enabling data-driven api design with community usage data: A need-finding study. In: Proceedings of the 2020 CHI Conference on Human Factors in Computing Systems, pp 1–13
- Zhong H, Thummalapenta S, Xie T, Zhang L, Wang Q (2010) Mining api mapping for language migration. In: Proceedings of the 32nd ACM/IEEE International Conference on Software Engineering-Volume 1, pp 195–204
- Zimmermann M, Staicu CA, Tenny C, Pradel M (2019) Small world with high risks: A study of security threats in the npm ecosystem. In: 28th USENIX Security Symposium (USENIX Security 19), pp 995–1010