

AUTOMATED VERIFICATION AND SYNTHESIS OF STOCHASTIC HYBRID SYSTEMS: A SURVEY

ABOLFAZL LAVAEI¹, SADEGH SOUDJANI², ALESSANDRO ABATE³, AND MAJID ZAMANI^{4,5}

ABSTRACT. Stochastic hybrid systems have received significant attentions as a relevant modelling framework describing many systems, from engineering to the life sciences: they enable the study of numerous applications, including transportation networks, biological systems and chemical reaction networks, smart energy and power grids, and beyond. Automated verification and policy synthesis for stochastic hybrid systems can be inherently challenging: this is due to the heterogeneity of their dynamics (presence of continuous and discrete components), the presence of uncertainty, and in some applications the large dimension of state and input sets. Over the past few years, a few hundred articles have investigated these models, and developed diverse and powerful approaches to mitigate difficulties encountered in the analysis and synthesis of such complex stochastic systems. In this survey, we overview the most recent results in the literature and discuss different approaches, including *(in)finite abstractions, verification and synthesis for temporal logic specifications, stochastic similarity relations, (control) barrier certificates, compositional techniques*, and a selection of results on *continuous-time stochastic systems*; we finally survey recently developed *software tools* that implement the discussed approaches. Throughout the manuscript we discuss a few open topics to be considered as potential future research directions: we hope that this survey will guide younger researchers through a comprehensive understanding of the various challenges, tools, and solutions in this enticing and rich scientific area.

1. INTRODUCTION

1.1. Motivations. Stochastic hybrid systems (SHS) [BLE⁺06, CL06] concern complex dynamical models combining both digital-computation elements and physical components, tightly interacting with each other in feedback interconnections. SHS models thus comprise discrete dynamics modelling computational components including hardware and software, and continuous dynamics that model the physical system. Due to their broad real-world applications, over the past few years SHS have gained remarkable attention in the areas of control theory, formal verification, applied mathematics, and performance evaluation, among others. Automated verification and policy synthesis to achieve high-level specifications, *e.g.*, those expressed as (linear) temporal logic formulae [Pnu77], can naturally be very challenging for complex SHS. In particular, the ability to handle the interaction between continuous and discrete dynamics is a prerequisite for providing a rigorous formal framework for automated verification and synthesis of SHS.

The complexity of SHS models, resulting from the aforementioned interaction of discrete and continuous components and from the presence of uncertainty modelled via probabilistic terms, makes it difficult to obtain analytical results. Hence verification and policy synthesis for SHS are generally addressed by approximation techniques. These can be categorized as (i) discretization-based and (ii) discretization-free techniques.

1.2. Discretization-based Techniques. In the analysis of SHS, it is often the case that quantities of interest, such as value functions, or the characterization of optimal policies, are in general not available in a closed (explicit, analytical) form. Therefore, a suitable approach for analyzing SHS is to approximate given (“concrete”) SHS models by simpler ones endowed with finite state spaces, also known as “finite abstractions”. Finite abstractions of SHS are often in the form of Markov decision processes (MDP), where each discrete state corresponds to a set of continuous states of the concrete SHS (similarly for actions). In practice, such finite abstractions can be generated by partitioning state/action sets of the concrete models. The discrete dynamics of the finite abstractions are similarly obtained from those of the concrete continuous models (cf. Figure 1).

Since the obtained abstractions are finite, many algorithmic machineries from computer science [BK08] are directly applicable to perform analysis, model checking, or to synthesize controllers maximizing reward or enforcing complex logic properties, including those expressed as logical formulae. A crucial step related to these discretization-based techniques is to provide formal guarantees on the obtained abstractions, so that the verification or synthesis results on abstract models can be carried over to the original SHS. Discretization-based techniques using finite abstractions are schematically illustrated in Figure 1.

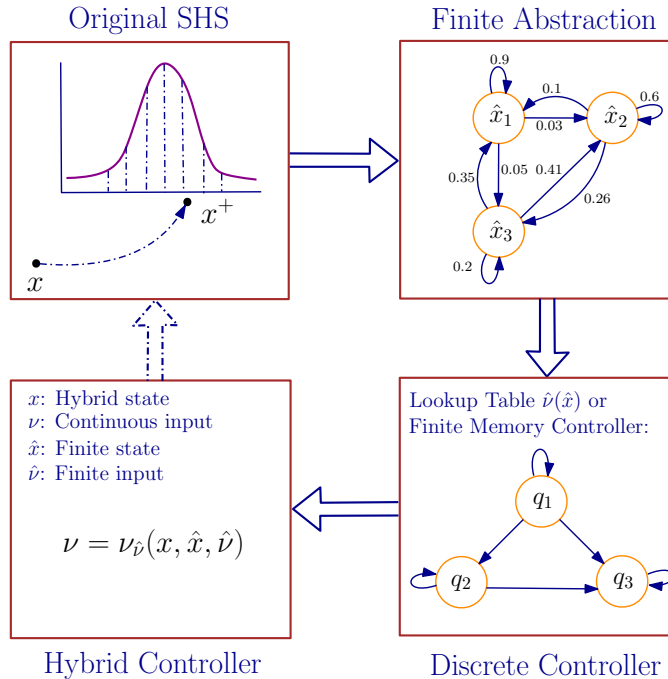

FIGURE 1. Illustration of the procedure underlying discretization-based techniques based on finite abstractions. The discrete controller can be a static lookup table or a dynamic controller (with finite memory).

1.3. Discretization-free Techniques. The techniques discussed in the setting of finite abstractions rely on the discretization (that is, partitioning, or gridding) of state and input/action sets; consequently, they can suffer from an issue known as the *curse of dimensionality*: the complexity of constructing the abstraction grows exponentially with the state/input dimension of the SHS. This critical challenge motivates the development of discretization-free approaches, such as those based on (*control*) *barrier certificates*, on Lyapunov-like techniques for invariance analysis, or on notions of probabilistic simulations. These techniques have been introduced over the last 15 years for verification and controller synthesis of complex SHS. Barrier certificates are Lyapunov-like functions defined over the state space of the system and satisfying a set of inequalities on both the function itself and the one-step transition (or the infinitesimal generator along the flow) of the system. An appropriate level set of a barrier certificate can separate an unsafe region from all system trajectories starting from a given set of initial conditions (cf. Figure 2). Consequently, the existence of such a function provides a formal probabilistic certificate for system safety.

In this survey paper, we discuss recent approaches grounded on both discretization-based and -free techniques. We should mention that the main focus of the survey is on *discrete-time, continuous-space* stochastic hybrid systems, whereas we dedicate only one section (Sec. 8) to the otherwise interesting framework of *continuous-time, continuous-space* models, where we overview the corresponding major theoretical results. We should

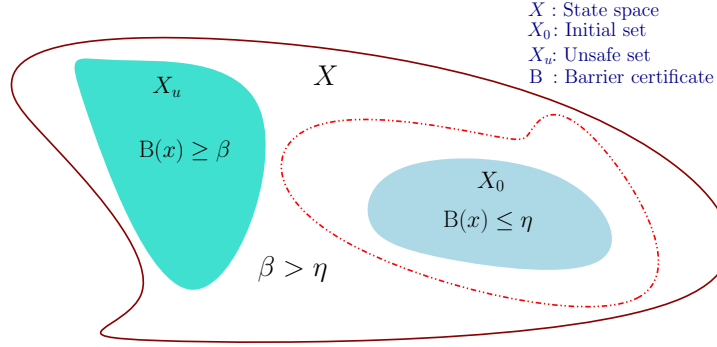

FIGURE 2. Discretization-free techniques can study probabilistic safety based on the synthesis of control barrier certificates. The (red) dashed line denotes the level set $B(x) = \eta$.

also stress that much of the presented work builds on the extensive theoretical and algorithmic background of *finite-space* Markov models, which is not overviewed here in view of length limitations: we refer the interested reader to [BK08, KNP11] for informative overviews.

1.4. Different Types of Closeness Guarantees. In this survey we discuss four different types of closeness guarantees (or error bounds) between original SHS and their finite abstractions, as introduced next. These guarantees allow to compute assertions over abstractions and formally refine them over the concrete models.

Definition 1.1. *Let Σ be a concrete SHS and $\widehat{\Sigma}$ be its abstraction. For a given specification, the probabilistic closeness between Σ and $\widehat{\Sigma}$ is defined according to one of the following:*

- (i) *the difference between probabilities of satisfaction of specifications over the original system Σ and its corresponding abstraction $\widehat{\Sigma}$ (cf. equation (2.3) or (2.4));*
- (ii) *the probability of the difference between the output trajectories of Σ and $\widehat{\Sigma}$ being less than a given threshold (cf. equation (2.6));*
- (iii) *the expectation (moment) of the difference between output trajectories of original system Σ and those of its abstraction $\widehat{\Sigma}$ (cf. equation (8.1));*
- (iv) *the probability of satisfaction of logic properties over the abstract system $\widehat{\Sigma}$ is either lower- or upper-bounds the satisfaction probability over original system Σ (cf. equations (2.7) and (2.8)).*

In the following subsections, we formalize the required definitions and present preliminaries and main notations from control theory and computer science, which are widely employed in the paper.

1.5. Notations and Preliminaries. The sets of non-negative and positive integers are denoted by $\mathbb{N} := \{0, 1, 2, \dots\}$ and $\mathbb{N}_{\geq 1} := \{1, 2, 3, \dots\}$, respectively. Moreover, the symbols \mathbb{R} , $\mathbb{R}_{>0}$, and $\mathbb{R}_{\geq 0}$ denote, respectively, the sets of real, positive and nonnegative real numbers. For any set X we denote by 2^X the power set of X that is the set of all subsets of X . Given N vectors $x_i \in \mathbb{R}^{n_i}$, $n_i \in \mathbb{N}_{\geq 1}$, and $i \in \{1, \dots, N\}$, we use $x = [x_1; \dots; x_N]$ to denote the corresponding column vector of dimension $\sum_i n_i$. We denote by $\|\cdot\|$ and $\|\cdot\|_2$ the infinity and Euclidean norms, respectively. Given any $a \in \mathbb{R}$, $|a|$ denotes the absolute value of a . Symbols \mathbb{I}_n , $\mathbf{0}_n$, and $\mathbf{1}_n$ denote the identity matrix in $\mathbb{R}^{n \times n}$ and the column vector in $\mathbb{R}^{n \times 1}$ with all elements equal to zero and one, respectively. Given a matrix $P = \{p_{ij}\} \in \mathbb{R}^{n \times n}$, we denote the trace of P by $\text{Tr}(P)$, where $\text{Tr}(P) = \sum_{i=1}^n p_{ii}$. We denote the disjunction (\vee) and conjunction (\wedge) of Boolean functions $f : \Gamma \rightarrow \{0, 1\}$ over a (possibly infinite) index set Γ by $\bigvee_{\alpha \in \Gamma} f(\alpha)$ and $\bigwedge_{\alpha \in \Gamma} f(\alpha)$, respectively. Given functions $f_i : X_i \rightarrow Y_i$, for any $i \in \{1, \dots, N\}$, their Cartesian product $\prod_{i=1}^N f_i : \prod_{i=1}^N X_i \rightarrow \prod_{i=1}^N Y_i$ is defined as

$(\prod_{i=1}^N f_i)(x_1, \dots, x_N) = [f_1(x_1); \dots; f_N(x_N)]$. Given sets X and Y , a relation $\mathcal{R} \subseteq X \times Y$ is a subset of the Cartesian product $X \times Y$ that relates $x \in X$ with $y \in Y$ if $(x, y) \in \mathcal{R}$, which is equivalently denoted by $x\mathcal{R}y$. A function $\gamma : \mathbb{R}_{\geq 0} \rightarrow \mathbb{R}_{\geq 0}$, is said to be a class \mathcal{K} function if it is continuous, strictly increasing, and $\gamma(0) = 0$. A class \mathcal{K} function $\gamma(\cdot)$ is said to be a class \mathcal{K}_∞ if $\gamma(r) \rightarrow \infty$ as $r \rightarrow \infty$. A continuous function $\beta : \mathbb{R}_{\geq 0} \times \mathbb{R}_{\geq 0} \rightarrow \mathbb{R}_{\geq 0}$ is said to belong to class \mathcal{KL} if, for each fixed t , the map $\beta(r, t)$ belongs to class \mathcal{K} with respect to r , and for each fixed nonzero r , the map $\beta(r, t)$ is decreasing with respect to t , and $\beta(r, t) \rightarrow 0$ as $t \rightarrow \infty$.

We consider a probability space $(\Omega, \mathcal{F}_\Omega, \mathbb{P}_\Omega)$, where Ω is the sample space, \mathcal{F}_Ω is a sigma-algebra on Ω comprising subsets of Ω as events, and \mathbb{P}_Ω is a probability measure that assigns probabilities to events. We assume that random variables introduced in the article are measurable functions of the form $X : (\Omega, \mathcal{F}_\Omega) \rightarrow (S_X, \mathcal{F}_X)$. Any random variable X induces a probability measure on its space (S_X, \mathcal{F}_X) as $Prob\{A\} = \mathbb{P}_\Omega\{X^{-1}(A)\}$ for any $A \in \mathcal{F}_X$. We often directly discuss the probability measure on (S_X, \mathcal{F}_X) without explicitly mentioning the underlying probability space and the function X itself.

A topological space \mathcal{S} is called a Borel space if it is homeomorphic to a Borel subset of a Polish space (*i.e.*, a separable and completely metrizable space). Examples of a Borel space are Euclidean spaces \mathbb{R}^n , its Borel subsets endowed with a subspace topology as well as hybrid spaces. Any Borel space \mathcal{S} is assumed to be endowed with a Borel sigma-algebra, which is denoted by $\mathcal{B}(\mathcal{S})$. We say that a map $f : \mathcal{S} \rightarrow Y$ is measurable whenever it is Borel measurable.

1.6. Discrete-Time Stochastic Hybrid Systems. In this survey, we consider stochastic hybrid systems in discrete time (dt-SHS) defined formally as follows.

Definition 1.2. *A discrete-time stochastic hybrid system (dt-SHS) is characterized by the tuple*

$$\Sigma = (\mathcal{Q}, n, X, U, T_x, Y, h), \text{ where} \quad (1.1)$$

- $\mathcal{Q} := \{q_1, \dots, q_p\}$ for some $p \in \mathbb{N}_{\geq 1}$, represents the discrete-state space;
- $n : \mathcal{Q} \rightarrow \mathbb{N}_{\geq 1}$ assigns to each discrete state value $q \in \mathcal{Q}$ the dimension of the continuous-state space $\mathbb{R}^{n(q)}$;
- $X \subseteq \cup_{q \in \mathcal{Q}} \{q\} \times \mathbb{R}^{n(q)}$ is a Borel space as the hybrid-state space of the system. We denote by $(X, \mathcal{B}(X))$ the measurable space, with $\mathcal{B}(X)$ being the Borel sigma-algebra over the state space;
- $U \subseteq \mathbb{R}^m$ is a Borel space as the input space of the system;
- $T_x : \mathcal{B}(X) \times X \times U \rightarrow [0, 1]$ is a conditional stochastic kernel that assigns to any $x \in X$, and $\nu \in U$, a probability measure $T_x(\cdot|x, \nu)$ on the measurable space $(X, \mathcal{B}(X))$. This stochastic kernel specifies probabilities over executions $\{x(k), k \in \mathbb{N}\}$ of the hybrid system, such that for any set $\mathcal{A} \in \mathcal{B}(X)$ and any $k \in \mathbb{N}$,

$$\mathbb{P}(x(k+1) \in \mathcal{A}|x(k), \nu(k)) = \int_{\mathcal{A}} T_x(dx(k+1)|x(k), \nu(k));$$

- $Y \subseteq \mathbb{R}^q$ is a Borel space as the output space of the system;
- $h : X \rightarrow Y$ is a measurable function as the output map that takes a state $x \in X$ to its output $y = h(x)$.

An example of dt-SHS is discussed in the running example and equation (1.4).

This definition is general and describes the dynamics of rich and diverse SHS models, in particular covering models with hybrid state spaces that are very expressive and useful to describe numerous applications. As this general structure of the state space can be notationally heavy, for the scope of this survey and for the sake of an easier presentation, we will introduce definitions, algorithms, and theorems based on a specific class of SHS with a single discrete mode (*i.e.*, $X \subseteq \mathbb{R}^n$), called discrete-time stochastic control systems (dt-SCS) [MT93, HLL96, HSA17]. We emphasize that broadly the notions and approaches underlying the proposed results can be generalized to SHS endowed with *hybrid* state spaces. A schematic representation of dt-SCS Σ is shown in Figure 3.

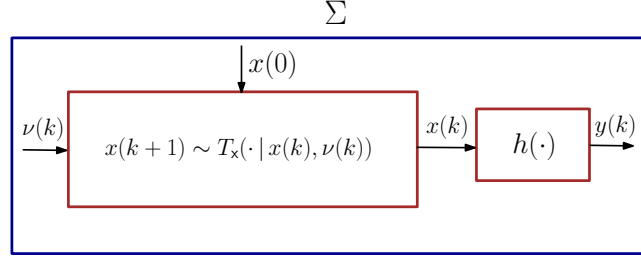
FIGURE 3. A schematic representation of a dt-SCS Σ .

As argued in [Kal97], any dt-SCS endowed with a stochastic transition kernel T_x as in Definition 1.2 can be *equivalently* represented by a dt-SCS with a terms (f, ς) , as formalized next. Note that this alternative representation is more common in control theory. It is often easier to show specific results of this paper based on the alternative representation.

Definition 1.3. A discrete-time stochastic control system (dt-SCS) is represented by the tuple

$$\Sigma = (X, U, \varsigma, f, Y, h), \text{ where} \quad (1.2)$$

- $X \subseteq \mathbb{R}^n$ is a Borel space as the state space of the system;
- $U \subseteq \mathbb{R}^m$ is a Borel space as the input space of the system;
- ς is a sequence of independent and identically distributed (i.i.d.) random variables from a sample space Ω to the measurable space $(\mathcal{V}_\varsigma, \mathcal{F}_\varsigma)$

$$\varsigma := \{\varsigma(k) : (\Omega, \mathcal{F}_\Omega) \rightarrow (\mathcal{V}_\varsigma, \mathcal{F}_\varsigma), k \in \mathbb{N}\};$$

- $f : X \times U \times \mathcal{V}_\varsigma \rightarrow X$ is a measurable function characterizing the state evolution of the system;
- $Y \subseteq \mathbb{R}^q$ is a Borel space as the output space of the system;
- $h : X \rightarrow Y$ is a measurable function as the output map.

For given initial state $x(0) \in X$ and input sequence $\nu(\cdot) : \mathbb{N} \rightarrow U$, the evolution of the state of the dt-SCS Σ can be written, with $k \in \mathbb{N}$, as

$$\Sigma : \begin{cases} x(k+1) = f(x(k), \nu(k), \varsigma(k)), \\ y(k) = h(x(k)). \end{cases} \quad (1.3)$$

We denote by \mathbb{U} the collection of the input sequences $\{\nu(k) : \Omega \rightarrow U, k \in \mathbb{N}\}$, in which $\nu(k)$ is independent of $\varsigma(z)$ for any $k, z \in \mathbb{N}$ and $z \geq k$. For any initial state $a \in X$, and input $\nu(\cdot) \in \mathbb{U}$, the random sequences $x_{a\nu} : \Omega \times \mathbb{N} \rightarrow X$, and $y_{a\nu} : \Omega \times \mathbb{N} \rightarrow Y$ that satisfy (1.3) are respectively called the solution process and the output trajectory of Σ under an input ν , and an initial state a . System Σ is said to be finite if X and U are finite sets, and infinite otherwise.

Running Example. To help the reader gain a better understanding of the details in this survey paper, we present a simple yet interesting running example. We apply the results presented in this survey to a temperature regulation problem for a room equipped with a heater. The model of this case study is borrowed from [FI04, MGW17], but modified by including an additive noise, which is intended to capture the effect of uncertain weather- or user-dependent factors. The evolution of the temperature $T(\cdot)$ over time can be described by the following dt-SCS:

$$\Sigma : \begin{cases} T(k+1) = a(k)T(k) + \gamma T_h \nu(k) + \theta T_e + R\varsigma(k), \\ y(k) = T(k), \end{cases} \quad (1.4)$$

where the signal $a(k) := (1 - \theta - \gamma\nu(k))$ depends on the input $\nu(k)$, $R = 0.6$ is the noise coefficient, and $\theta = 0.4$, and $\gamma = 0.5$ are factors that affect the rate of heat conduction between the external environment

and the room, and between the heater and the room. The parameter $T_e = -1^\circ C$ is the outside temperature, $T_h = 50^\circ C$ is the heater temperature, and finally y is the output of the system, which corresponds to the temperature itself. The model in (1.4) can be alternatively (and equivalently) characterized via the tuple in (1.2): here X, U are subsets of the real numbers, $f(x(k), \nu(k), \varsigma(k)) = a(k)T(k) + \gamma T_h \nu(k) + \theta T_e + R\varsigma(k)$, and the output map h is identity (accordingly, the output space $Y = X$). Note that this system is a very special instance of SHS in (1.1) endowed with a single discrete mode, where the conditional stochastic kernel T_x is a normal distribution with mean $a(k)T(k) + \gamma T_h \nu(k) + \theta T_e$ and covariance RR^T . Alternatively, if the input $\nu(k)$ is assumed to be a finite-value function of the state (the temperature T), e.g. a binary function switching upon hitting the boundaries of a temperature interval [AKLP10], then the model can be interpreted as a two-mode (autonomous) SHS. \square

Given the dt-SCS model in (1.2), we introduce *Markov policies* as follows.

Definition 1.4. *A Markov policy for the dt-SCS Σ in (1.2) is a sequence $\mu = (\mu_0, \mu_1, \mu_2, \dots)$ of universally measurable stochastic kernels μ_n [BS96], each defined on the input space U given X and such that for all $x(n) \in X$, $\mu_n(U(x(n)) | x(n)) = 1$. The class of all Markov policies is denoted by \mathcal{M}_p .*

In words, Markov policies are history-independent and the control input taken at the current time instance is selected, possibly randomly, with a distribution that depends only on the current state.

We now define the notion of incremental input-to-state stability for Σ , as a pivotal assumption that will allow some of the results, in particular to provide closeness guarantees between output trajectories of Σ and $\widehat{\Sigma}$, as per (iii) and (iv) in Definition 1.1.

Definition 1.5. *A dt-SCS $\Sigma = (X, U, \varsigma, f, Y, h)$ is called incrementally input-to-state stable (δ -ISS) if there exists a function $S : X \times X \rightarrow \mathbb{R}_{\geq 0}$ such that $\forall x, x' \in X$, $\forall \nu, \nu' \in U$, the following two inequalities hold:*

$$\underline{\alpha}(\|x - x'\|) \leq S(x, x') \leq \overline{\alpha}(\|x - x'\|), \quad (1.5)$$

and

$$\mathbb{E}\left[S(f(x, \nu, \varsigma), f(x', \nu', \varsigma)) | x, x', \nu, \nu'\right] - S(x, x') \leq -\bar{\kappa}(S(x, x')) + \rho(\|\nu - \nu'\|), \quad (1.6)$$

for some $\underline{\alpha}, \overline{\alpha}, \bar{\kappa} \in \mathcal{K}_\infty$, and $\rho \in \mathcal{K}_\infty \cup \{0\}$.

Later we will show how one can use the δ -ISS property to bound the distance between two solution processes starting from different initial conditions and under different input trajectories.

We now define the notion of stochastic simulation functions (SSF) between $\widehat{\Sigma}$ and Σ , which allows to provide closeness guarantees between the output trajectories of the two models, as per (ii) in Definition 1.1.

Definition 1.6. *Consider two dt-SCS $\Sigma = (X, U, \varsigma, f, Y, h)$ and $\widehat{\Sigma} = (\widehat{X}, \widehat{U}, \varsigma, \widehat{f}, \widehat{Y}, \widehat{h})$. A function $V : X \times \widehat{X} \rightarrow \mathbb{R}_{\geq 0}$ is called a stochastic simulation function (SSF) from $\widehat{\Sigma}$ to Σ if*

- $\exists \alpha \in \mathcal{K}_\infty$ such that

$$\forall x \in X, \forall \hat{x} \in \widehat{X}, \quad \alpha(\|h(x) - \widehat{h}(\hat{x})\|) \leq V(x, \hat{x}),$$

- $\forall x := x(k) \in X, \hat{x} := \hat{x}(k) \in \widehat{X}, \hat{\nu} := \hat{\nu}(k) \in \widehat{U}, \exists \nu := \nu(k) \in U$ such that

$$\mathbb{E}\left[V(x(k+1), \hat{x}(k+1)) | x, \hat{x}, \nu, \hat{\nu}\right] \leq -\kappa V(x, \hat{x}) + \rho_{\text{ext}}(\|\hat{\nu}\|) + \psi, \quad (1.7)$$

for some $0 < \kappa < 1$, $\rho_{\text{ext}} \in \mathcal{K}_\infty \cup \{0\}$, and $\psi \in \mathbb{R}_{\geq 0}$.

We denote $\widehat{\Sigma} \preceq \Sigma$ if there exists an SSF V from $\widehat{\Sigma}$ to Σ , and call the system $\widehat{\Sigma}$ an abstraction of the concrete (original) system Σ . Note that $\widehat{\Sigma}$ may be finite or infinite, depending on the cardinality of the sets \widehat{X} and \widehat{U} .

Informally, stochastic simulation functions are Lyapunov-like functions defined over the Cartesian product of the state spaces of the two models, which relate their output trajectories and indeed guarantee that their mismatch (namely their difference, or the abstraction error) remains within some guaranteed error bounds.

Remark 1.7. *The second condition in Definition 1.6 implies the existence of a function $\nu = \nu_{\hat{\nu}}(x, \hat{x}, \hat{\nu})$ for the satisfaction of (1.7). This function is called the “interface function” and will be used to refine a synthesized policy $\hat{\nu}$ for $\hat{\Sigma}$ to a policy ν for Σ (cf. Figure 1), and will be discussed later in Sections 3 and 4.*

1.7. Temporal Logic Specifications. Formal requirements provide a rigorous and unambiguous formalism to express formal requirements over models. A common way to describe such formal requirements is utilizing automata-based or temporal logic-based specifications, *e.g.*, formulae expressed in linear temporal logic (LTL) [Pnu77]. For instance, consider the dt-SCS in (1.2) and a measurable target set $B \subset Y$. We say that an output trajectory $\{y(k)\}_{k \geq 0}$ reaches a target set B within the discrete time interval $[0, T_d] \subset \mathbb{N}$, if there exists a $k \in [0, T_d]$ such that $y(k) \in B$. This bounded reaching of B is denoted by $\diamond^{\leq T_d} \{y \in B\}$ or briefly $\diamond^{\leq T_d} B$. For $T_d \rightarrow \infty$, we denote the reachability property as $\diamond B$, *i.e.*, eventually B . This is a basic property that can be reframed more broadly within LTL. We formally define syntax and semantics of linear temporal logic (LTL) as follows.

Definition 1.8. *Consider a set of atomic propositions AP and the alphabet $\Sigma_a := 2^{AP}$. Let $\omega = \omega(0), \omega(1), \omega(2), \dots$ be an infinite word, that is, a string composed of letters from Σ_a (*i.e.* $\omega(i) \in \Sigma_a, \forall i \in \mathbb{N}$). We are interested in those atomic propositions that are relevant to the dt-SCS via a measurable labeling function L from the output space to the alphabet as $L : Y \rightarrow \Sigma_a$. Output trajectories $\{y(k)\}_{k \geq 0} \in Y^{\mathbb{N}}$ can be readily mapped to the set of infinite words $\Sigma_a^{\mathbb{N}}$, as*

$$\omega = L(\{y(k)\}_{k \geq 0}) := \{\omega \in \Sigma_a^{\mathbb{N}} \mid \omega(k) = L(y(k))\}.$$

We define the LTL syntax [BK08] as

$$\varphi ::= \text{true} \mid p \mid \neg\varphi \mid \varphi_1 \wedge \varphi_2 \mid \bigcirc\varphi \mid \varphi_1 \mathcal{U} \varphi_2.$$

Given a trace $\omega = \omega(0), \omega(1), \omega(2), \dots$, let us denote the suffix of ω starting from $\omega(i)$ by

$$(\omega, i) = \omega(i), \omega(i+1), \omega(i+2), \dots$$

We denote by $(\omega, i) \models \varphi$ when the LTL formula φ is true on the suffix (ω, i) . This satisfaction is defined inductively as follows:

- $(\omega, i) \models \text{true}$;
- $(\omega, i) \models p$, for $p \in AP$ iff $p \in \omega(i)$;
- $(\omega, i) \models \neg\varphi$ iff $(\omega, i) \not\models \varphi$;
- $(\omega, i) \models \varphi_1 \wedge \varphi_2$ iff $(\omega, i) \models \varphi_1$ and $(\omega, i) \models \varphi_2$;
- $(\omega, i) \models \bigcirc\varphi$ iff $(\omega, i+1) \models \varphi$;
- $(\omega, i) \models \varphi_1 \mathcal{U} \varphi_2$ iff for some j such that $i \leq j$, we have $(\omega, j) \models \varphi_2$, and for all k s.t. $i \leq k < j$, we have $(\omega, k) \models \varphi_1$.

Formula φ is true on ω , denoted by $\omega \models \varphi$, if and only if $(\omega, 0) \models \varphi$.

Based on the above operators, we can also introduce others, obtained via propositional or temporal manipulations. For instance, $\varphi_1 \vee \varphi_2$, $\diamond\varphi$, and $\square\varphi$ have semantics

- $(\omega, i) \models \varphi_1 \vee \varphi_2$ iff $(\omega, i) \models \varphi_1$ or $(\omega, i) \models \varphi_2$;
- $(\omega, i) \models \diamond\varphi$ iff for some j such that $i \leq j$, we have $(\omega, j) \models \varphi$;
- $(\omega, i) \models \square\varphi$ iff for all j such that $i \leq j$, we have $(\omega, j) \models \varphi$.

Later, we shall be interested in reasoning about likelihoods to verify given LTL formulae by Markov models, such as MDPs or dt-SCS. Clearly, this requires reasoning about measurability of events associated to the LTL specifications introduced above; however, we shall not delve into this issue in the present survey.

We now define a fragment of LTL properties known as syntactically co-safe linear temporal logic (scLTL) [KV01].

Definition 1.9. *An scLTL over a set of atomic propositions AP is a fragment of LTL such that the negation operator (\neg) only occurs before atomic propositions, and it is characterized by the following grammar:*

$$\varphi ::= \text{true} \mid p \mid \neg p \mid \varphi_1 \wedge \varphi_2 \mid \varphi_1 \vee \varphi_2 \mid \bigcirc \varphi \mid \varphi_1 \mathcal{U} \varphi_2 \mid \diamond \varphi,$$

with $p \in AP$.

scLTL properties are popular since their verification can be performed via a reachability property, which can be expressed by means of a finite-state automaton [KV01, BYG17]. For this purpose, we introduce a class of models known as deterministic finite-state automata (DFA).

Definition 1.10. *A DFA is a tuple $\mathcal{A} = (Q_\ell, q_0, \Sigma_a, F_a, \mathbf{t})$, where Q_ℓ is a finite set of locations, $q_0 \in Q_\ell$ is the initial location, Σ_a is a finite set (a.k.a. alphabet), $F_a \subseteq Q_\ell$ is a set of accept locations, and $\mathbf{t} : Q_\ell \times \Sigma_a \rightarrow Q_\ell$ is a transition function.*

Consider a set of atomic propositions AP and the alphabet $\Sigma_a := 2^{AP}$. A finite word composed of letters of the alphabet, i.e., $\omega_f = (\omega_f(0), \dots, \omega_f(n)) \in \Sigma_a^{n+1}$, is accepted by a DFA \mathcal{A} if there exists a finite run $q = (q(0), \dots, q(n+1)) \in Q_\ell^{n+2}$ such that $q(0) = q_0$, $q(i+1) = \mathbf{t}(q(i), \omega_f(i))$ for all $0 \leq i \leq n$, and $q(n+1) \in F_a$. The accepted language of \mathcal{A} , denoted $\mathcal{L}(\mathcal{A})$, is the set of all words accepted by \mathcal{A} . For every scLTL property φ , cf. Definition 1.9, there exists a DFA \mathcal{A}_φ such that

$$\mathcal{L}_f(\varphi) = \mathcal{L}(\mathcal{A}_\varphi).$$

where \mathcal{L}_f denotes the set of all words associated to an scLTL formula φ . The following example borrowed from [LSZ19b] provides an automaton associated with a reach-avoid specification.

Example 1.11. *Consider two measurable sets $A, B \subset Y$ as the safe and target sets, respectively. We present the DFA for the specification $(A\mathcal{U}B)$ which requires the output trajectories to reach the target set B while remaining in the safe set A . Note that we do not assume these two sets being disjoint. Consider the set of atomic propositions $AP = \{A, B\}$ and the alphabet $\Sigma_a = \{\emptyset, \{A\}, \{B\}, \{A, B\}\}$. Define the labeling function as*

$$L(y) = \begin{cases} \{A\} =: a & \text{if } y \in A \setminus B, \\ \{B\} =: b & \text{if } y \in B, \\ \emptyset =: c & \text{if } y \notin A \cup B. \end{cases}$$

As can be seen from the above definition of the labeling function L , it induces a partition over the output space Y as

$$L^{-1}(a) = A \setminus B, \quad L^{-1}(b) = B, \quad L^{-1}(c) = Y \setminus (A \cup B).$$

Note that we have indicated the elements of Σ_a with lower-case letters for the ease of notation. The specification $(A\mathcal{U}B)$ can be equivalently written as $(a\mathcal{U}b)$ with the associated DFA depicted in Figure 4. This DFA has the set of locations $Q_\ell = \{q_0, q_1, q_2, q_3\}$, the initial location q_0 , and accepting location $F_a = \{q_2\}$. Thus output trajectories of a dt-SCS Σ satisfy the specification $(a\mathcal{U}b)$ if and only if their associated words are accepted by this DFA.

Generalizing beyond scLTL and DFAs, often we are interested in infinite paths through a system and thus in infinite words and the ω -automata that accept them.¹ Two of the most commonly used automata to express ω -regular properties are *Büchi* and *Rabin* automata. Indeed, non-deterministic *Büchi* automata can encompass the entire LTL.

Definition 1.12. *An NBA is a tuple $\mathcal{A} = (Q_\ell, q_0, \Sigma_a, F_a, \mathbf{t})$, where Q_ℓ is a finite set of locations, $q_0 \in Q_\ell$ is the initial location, Σ_a is the finite alphabet, $F_a \subseteq Q_\ell$ is a set of accept locations, and $\mathbf{t} : Q_\ell \times \Sigma_a \rightarrow 2^{Q_\ell}$ is a transition relation.*

¹Here ω denotes infinite repetitions, so for instance the string p^ω corresponds to $\{p, p, p, \dots\}$.

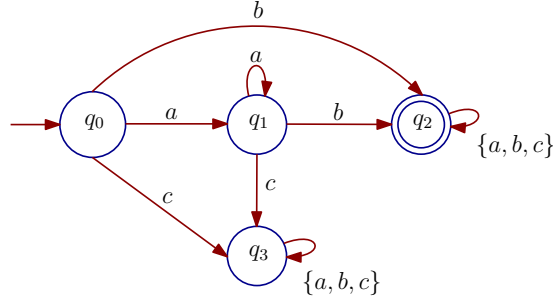
FIGURE 4. DFA \mathcal{A}_φ of the reach-avoid specification (aUb) .

A infinite word composed of letters of the alphabet, *i.e.*, $\omega_f = (\omega_f(0), \omega_f(1) \dots) \in \Sigma_a^\omega$, is accepted by the NBA \mathcal{A} if there exists an infinite run $q = (q(0), q(1), \dots) \in Q_\ell^\omega$ such that $q(0) \in q_0$, $q(i+1) \in \mathfrak{t}(q(i), \omega_f(i))$ for all $0 \leq i$, and $q(i) \in F_a$ infinitely often. Let us remark that the non-deterministic feature of NBA is necessary to express ω -regular properties, and in particular LTL specifications. Alternatively, later in this survey, we shall mention limit-deterministic *Büchi* automata. Similarly, deterministic *Rabin* automata can be utilized, which employ a different (and more involuted) acceptance semantics. However, for the sake of space we avoid to detail them and instead refer the reader to [BK08] for a comprehensive discussion.

For probabilistic models, properties of interest can be expressible in a different logic, which encompasses a probabilistic operator in its syntax. Probabilistic computation tree logic (PCTL) [CG04] can be introduced as follows.

Definition 1.13. *The syntax of (PCTL) formulae is defined recursively using the following operators:*

$$\begin{aligned} \varphi &::= \text{true} \mid p \mid \varphi \wedge \varphi \mid \neg \varphi \mid \mathbb{P}_{\sim p}[\psi], \\ \psi &::= \bigcirc \varphi \mid \varphi \mathcal{U} \varphi, \end{aligned}$$

where $p \in AP$ and $\sim \in \{<, \leq, \geq, >\}$, and $p \in [0, 1]$. The semantics for \bigcirc and for \mathcal{U} are as before, and the semantics for true, p , \wedge , and \neg are also identical except for being defined using the state $s = \omega(0)$ instead of the whole path ω . The remaining semantics for the probabilistic operator $\models \mathbb{P}_{\sim p}[\psi]$ are defined as:

$$\Pr(\{\omega \in Y^\omega \mid \omega(0) = s \text{ and } \omega, 0 \models \psi\}) \sim p,$$

where \Pr is the probability distribution over the infinite paths through Y induced by the stochastic dynamics.

Discussion of characterization and computation of basic PCTL specifications, such as safety and reachability, for dt-SCS is introduced in [AAP⁺06] and generalized in [APLS08], is applied to invariance in [PP06], and then extended to reach-avoid [SL10]. [RCSL10] connects the characterization of PCTL to dynamic programming. Further, [TMKA13, TMKA17a] generalizes this to regular and ω -regular properties, respectively, leveraging the DFA an NBA automata from above, and a product construction further discussed in Section 6. Finally, let us mention that other temporal logics, such as signal temporal logic (STL) [MNP08], are also meaningfully used over stochastic models - however, we do not delve into further details for the sake of space, and in view of the relevance and prevalence of LTL and of PCTL.

1.8. Contributions and Organization. This paper provides the first survey of literature on automated formal verification and synthesis of stochastic hybrid systems (SHS). While trying to be comprehensive, we focus on the most recent and sharpest results in the literature, and discuss related approaches in various sections in coarser detail. Besides the selection of the most relevant articles, this survey is intended to help researchers to gain an overall understanding of the many challenges and solution strategies related to the formal verification and the control synthesis of SHS, as well as the associated software tools that have been developed

to support the theory. For the sake of a clear and streamlined presentation, we present selected methods, applications, and results in detail, and instead briefly overview alternative approaches, for the following topics. We discuss approaches in relevant literatures via both discretization-based and -free techniques, categorizing them over four different closeness guarantees between the concrete SHS and their abstractions, according to Definition 1.1. We employ a running example and discuss approaches under the lens of *(ii) time complexity*, and *(iii) memory requirements*. We also discuss many open problems throughout this survey paper.

We remark that although the survey paper in [TSS14] also covers *stochastic* hybrid systems, its main focus is on stability analysis: different notions of stability are overviewed, including Lyapunov, Lagrange, asymptotic stability, and recurrence analysis. In contrast, here we focus on formal verification and synthesis goals, defined around complex properties including those expressed as temporal logic formulae (simple instances are safety and reachability specifications), as well as more general properties expressed via omega-regular languages [BK08]. In addition, we zoom in on *algorithmic solutions* for verification and synthesis of SHS against temporal properties.

This survey paper is structured as follows. In Section 2, we present one of the pivotal theorems of the article, elaborating on four different types of closeness guarantees between the a given SHS and its abstraction. We discuss in depth the required assumptions, and present tools to compute such guarantees. Corresponding results on stochastic similarity relations, to connect the probabilistic behavior of concrete models to that of their abstractions are also presented in the same section. Work on the construction of *infinite* abstractions for SHS is discussed in Section 3, and corresponding results on the construction of *finite* abstractions are studied in Section 4. We also discuss existing abstraction algorithms, together with the assumptions and details underpinning them.

In Section 5, we first formally present the definition of control barrier certificates, as discretization-free approaches for the analysis and synthesis of SHS. We then present another main theorem of this survey, which allows to quantify an upper bound on the probability that the given system reaches an unsafe region over both finite and infinite time horizons. Temporal logic verification and synthesis of SHS are studied in Section 6. Section 7 is devoted to compositional techniques as a potential direction for mitigating the curse of dimensionality. We present the definition of subsystems together with the formal definition of interconnected systems. We then propose the main compositionality results, based on two different techniques from the literature.

The results for *continuous-time* SHS are presented in Section 8. Section 9 is dedicated to simulation-based analysis of SHS. Software tools on verification and synthesis of SHS are discussed in Section 10. In Section 11, we summarize the existing analysis methods and highlight some important directions for future research. In particular, we discuss a few open problems including “formal analysis of SHS via learning and data-driven approaches”, “formal synthesis of partially-observed SHS”, “secured-by-construction controller synthesis for SHS”, “(mixed)-monotonicity of SHS”, “compositional construction of interval Markov processes”, “compositional controller synthesis for SHS”, and “potential extensions of software tools”.

2. STOCHASTIC SIMILARITY RELATIONS FOR ABSTRACTIONS

Closed-form solutions of SHS or optimal policies for SHS are in general not available explicitly, and thus required being numerically computed. A suitable approach is to approximate a given SHS model by simpler abstract ones, with possibly lower dimensional or finite state spaces. In order to render this approximation “formal,” it is desirable to provide guarantees on this approximation step, so that the analysis and/or synthesis on the abstract models can be translated back to the original system. Stochastic similarity relations are indeed employed to relate the probabilistic behavior of a concrete model to that of its abstractions. They can be presented in the context of stochastic simulation and bisimulation relations, in exact and approximate form.

In the following, we present four theorems that summarize several results in relevant literature, to provide four different types of closeness guarantees between original SHS and that of their abstractions. First, we present the difference between probabilities of satisfaction of logic properties over original systems Σ and their

corresponding finite abstractions $\widehat{\Sigma}$ [Sou14, TMKA13], as introduced in Sec. 1.2. This type of probabilistic closeness requires a Lipschitz continuity assumption on the stochastic kernel of the dt-SCS, as in the following.

Assumption 1. *The dt-SCS in Definition 1.3 is Lipschitz continuous if the stochastic kernel T_x admits a density function $t_s(\bar{x}|x, \nu)$ satisfying the following inequality for a some constant $\bar{\mathcal{H}} \geq 0$:*

$$|t_s(\bar{x}|x, \nu) - t_s(\bar{x}|x', \nu')| \leq \bar{\mathcal{H}}(\|x - x'\| + \|\nu - \nu'\|), \quad (2.1)$$

for all $x, x', \bar{x} \in X$ and all $\nu, \nu' \in U$. If the policy for dt-SCS is given as $\hat{\nu} : X \rightarrow U$, we define the Lipschitz constant of the stochastic kernel by \mathcal{H} , where

$$|t_s(\bar{x}|x, \hat{\nu}(x)) - t_s(\bar{x}|x', \hat{\nu}(x'))| \leq \mathcal{H}\|x - x'\|, \quad (2.2)$$

for all $x, x', \bar{x} \in X$.

Now, we have all the ingredients to introduce the first theorem, which is related to (i) in Definition 1.1. Note that a finite abstraction $\widehat{\Sigma}$ is obtained from the original system Σ by first constructing finite partitions of state and input sets, and then selecting arbitrary “representative points” as abstract states and inputs. Transition probabilities in the finite abstraction $\widehat{\Sigma}$ are computed accordingly (cf. Section 4, Algorithm 1).

Theorem 2.1. *Let $\Sigma = (X, U, \varsigma, f, Y, h)$ be a continuous-space dt-SCS and $\widehat{\Sigma} = (\widehat{X}, \widehat{U}, \varsigma, \widehat{f}, \widehat{Y}, \widehat{h})$ be its finite abstraction. Assume that the original system Σ is Lipschitz continuous, as per Assumption 1. For a given logic specification φ , and for any policy $\hat{\nu}(\cdot) \in \widehat{\mathbb{U}}$ that preserves the Markov property for the closed-loop $\widehat{\Sigma}$ (i.e., system $\widehat{\Sigma}$ fed by input $\hat{\nu}(\cdot)$, which is denoted by $\widehat{\Sigma}_{\hat{\nu}}$), the probabilistic closeness between two systems can be defined as:*

$$|\mathbb{P}(\Sigma_{\hat{\nu}} \models \varphi) - \mathbb{P}(\widehat{\Sigma}_{\hat{\nu}} \models \varphi)| \leq \lambda_1, \quad (2.3)$$

with $\lambda_1 := T_d \delta \mathcal{H} \mathcal{L}_b$, where T_d is the finite-time horizon, δ is the state discretization parameter, \mathcal{H} is the Lipschitz constant of the stochastic kernel T_x under policy $\hat{\nu}$ as in (2.2), and \mathcal{L}_b is the Lebesgue measure of the state space. Moreover, the difference between the optimal probabilities of satisfying the given LTL specification by the two models is bounded by

$$\left| \sup_{\nu} \mathbb{P}(\Sigma_{\nu} \models \varphi) - \sup_{\hat{\nu}} \mathbb{P}(\widehat{\Sigma}_{\hat{\nu}} \models \varphi) \right| \leq \bar{\lambda}_1, \quad (2.4)$$

with $\bar{\lambda}_1 := T_d \delta \bar{\mathcal{H}} \mathcal{L}_b$, where $\bar{\mathcal{H}}$ is the Lipschitz constant of the stochastic kernel T_x over the state x and input ν as in (2.1). Furthermore, for the optimal policy $\hat{\nu}^*$ that maximizes the satisfaction probability of φ for the abstraction $\widehat{\Sigma}$, we have

$$|\mathbb{P}(\Sigma_{\hat{\nu}^*} \models \varphi) - \mathbb{P}(\widehat{\Sigma}_{\hat{\nu}^*} \models \varphi)| \leq 2\bar{\lambda}_1. \quad (2.5)$$

Remark 2.2. *Note that the Lebesgue measure \mathcal{L}_b (informally, the “volume”) of the state set appears in the errors, as per (2.3)-(2.5), which makes them meaningful over bounded domain and, possibly, quite conservative. There exist techniques based on an adaptive and sequential gridding scheme (e.g., [SA13]) that mitigate both shortcomings.*

In the next theorem, we present a condition such that the probabilistic distance between output trajectories of Σ and $\widehat{\Sigma}$ being less than a given threshold, which is related to (ii) in Definition 1.1, as proposed in [LSMZ17]. Note that it works with a finite abstraction with a finite state set or an infinite abstraction with a lower dimension, which can be constructed via a linear transformation of the state space, obtained with a rectangular matrix (cf. Theorem 3.2).

Theorem 2.3. *Let $\Sigma = (X, U, \varsigma, f, Y, h)$ be a continuous-space dt-SCS and $\widehat{\Sigma} = (\widehat{X}, \widehat{U}, \varsigma, \widehat{f}, \widehat{Y}, \widehat{h})$ be its abstraction, either with a lower dimension or a finite state set. Suppose there exists a SSFV $V : X \times \widehat{X} \rightarrow \mathbb{R}_{\geq 0}$*

from $\widehat{\Sigma}$ to Σ as in Definition 1.6. For any input trajectory $\hat{\nu}(\cdot) \in \widehat{\mathcal{U}}$ that preserves Markov property for the closed-loop $\widehat{\Sigma}$, and for any random variables a and \hat{a} as the initial states of dt -SCS Σ and $\widehat{\Sigma}$, respectively, one can construct an input trajectory $\nu(\cdot) \in \mathcal{U}$ for Σ through an interface function associated with V (cf. Def. 1.6) such that:

$$\mathbb{P}\left\{\sup_{0 \leq k \leq T} \|y_{a\nu}(k) - \hat{y}_{\hat{a}\hat{\nu}}(k)\| \geq \varepsilon \mid [a; \hat{a}]\right\} \leq \lambda_2, \quad (2.6)$$

where,

$$\lambda_2 := \begin{cases} 1 - (1 - \frac{V(a, \hat{a})}{\alpha(\varepsilon)})(1 - \frac{\hat{\psi}}{\alpha(\varepsilon)})^T, & \text{if } \alpha(\varepsilon) \geq \frac{\hat{\psi}}{\kappa}, \\ (\frac{V(a, \hat{a})}{\alpha(\varepsilon)})(1 - \kappa)^T + (\frac{\hat{\psi}}{\kappa \alpha(\varepsilon)})(1 - (1 - \kappa)^T), & \text{if } \alpha(\varepsilon) < \frac{\hat{\psi}}{\kappa}, \end{cases}$$

with $\hat{\psi} \geq \rho_{\text{ext}}(\|\hat{\nu}\|_\infty) + \psi$, where $\alpha \in \mathcal{K}_\infty$, $0 < \kappa < 1$, $\rho_{\text{ext}} \in \mathcal{K}_\infty \cup \{0\}$, and $\varepsilon, \psi \in \mathbb{R}_{\geq 0}$ as introduced in Def. 1.6.

In order to provide the presented closeness guarantee between output trajectories of Σ and $\widehat{\Sigma}$ (as per (2.6)), the work in (e.g., [LSZ19b, ZRME17]) has introduced sufficient conditions, namely requiring that the original system Σ should be *incrementally input-to-state stable* (δ -ISS), as per Definition 1.5. In contrast, notice that the closeness guarantee in (2.3) is more general, since it does not require original systems to be δ -ISS: instead, only the Lipschitz continuity of the associated stochastic kernels is required for such guarantee [SAM15].

On the other hand, the abstraction error presented in (2.3) depends on the Lipschitz constants of the stochastic kernel, and the error grows to infinity when the standard deviation of the noise goes to zero, which is not the case for (2.6). Thus, whilst different in nature, the bound in (2.6) can practically outperform that in (2.3) for noises with a small standard deviation, as long as the δ -ISS assumption is satisfied by the original model. In addition, recent works [HSA17, HS18, LSZ20b] have proposed a closeness guarantee as a version of (2.3) by establishing an approximate probabilistic relation between Σ and $\widehat{\Sigma}$ based on a new notion of so-called δ -lifting. The proposed framework is based on constructing an ε -expansion or ε -contraction of the set of interest (cf. ε in (2.6)) over the abstract system. Accordingly, the probability of satisfaction computed over the modified sets on the abstract system provides upper and lower bounds for the probability of satisfaction on the original model.

We now present a result, related to (iv) in Definition 1.1, where the probability of satisfaction of a temporal logic property over the abstract system $\widehat{\Sigma}$ is either a lower or upper bound for the probability of property satisfaction over the original system Σ .

Theorem 2.4. *Let $\Sigma = (X, U, \varsigma, f, Y, h)$ be a continuous-space dt -SCS and $\widehat{\Sigma} = (\widehat{X}, \widehat{U}, \varsigma, \widehat{f}, \widehat{Y}, \widehat{h})$ be its finite abstraction. For a given LTL specification φ , and for any policy $\hat{\nu}(\cdot) \in \widehat{\mathcal{U}}$ that preserves the Markov property for the closed-loop $\widehat{\Sigma}$, one can construct a policy of $\nu(\cdot) \in \mathcal{U}$ for Σ such that:*

$$\mathbb{P}(\widehat{\Sigma}_{\hat{\nu}} \models \varphi) \leq \mathbb{P}(\Sigma_\nu \models \varphi). \quad (2.7)$$

Remark 2.5. *As (2.7) provides a lower bound for the probability of satisfaction over Σ , it is mainly useful when one is interested in maximizing the satisfaction probability. Conversely, if the goal is to minimize the probability of satisfaction, one would want to search for an upper bound of the satisfaction probability. Such an upper bound can be quantified from (2.7) using the negation of the specification (i.e., $\neg\varphi$) as the following:*

$$\mathbb{P}(\Sigma_\nu \models \varphi) \leq 1 - \mathbb{P}(\widehat{\Sigma}_{\hat{\nu}} \models \neg\varphi). \quad (2.8)$$

One can employ the same approach as in [LSZ19b, Section 6] and transfer the proposed closeness bound of (2.6) to (2.3) for any class of specifications that can be expressed as accepting languages of deterministic finite automata (DFA) [KV01]. In particular, any LTL property φ over the concrete system can be seen as the

union of events over the product output space. For instance, for a given safe set \mathbb{S} , the safety property over a finite-time horizon T is a subset of Y^{T+1} (with $Y^{T+1} = \prod_{i=0}^T Y$) indicated by the set \mathbb{S}^{T+1} . For all measurable events $\mathbf{A} \subset Y^{T+1}$, one can construct an ϵ -expansion and ϵ -contraction of \mathbf{A} over the abstract model within a given finite-time horizon T , as

$$\begin{aligned} \mathbf{A}^\epsilon &:= \{ \{y(k)\}_{0:T} \in Y^{T+1} \mid \exists \{\bar{y}(k)\}_{0:T} \in \mathbf{A}, \text{ s.t. } \max_{k \leq T} \|\bar{y}(k) - y(k)\| \leq \epsilon \}, \\ \mathbf{A}^{-\epsilon} &:= \{ \{y(k)\}_{0:T} \in Y^{T+1} \mid \forall \{\bar{y}(k)\}_{0:T} \in Y^{T+1} \setminus \mathbf{A}, \max_{k \leq T} \|\bar{y}(k) - y(k)\| > \epsilon \}, \end{aligned}$$

where $\{y(k)\}_{0:T} = [y(0); \dots; y(T)]$, whose probabilities of satisfaction give respectively upper and lower bounds for the probability of satisfaction in the concrete domain with some quantified error bounds in the form of (2.3).

There has been substantial work in the area of Formal Methods on different types of stochastic similarity relations, which are employed to relate the probabilistic behavior of a concrete model to that of its abstraction and have been more recently studied for continuous-space models [Pan09, Aba13]. Early on, similarity relations over finite-state stochastic systems via exact notions of probabilistic bisimulation relations have been introduced in [LS91]. Leveraging probabilistic transition systems as the underlying semantic model, the article shows how a testing algorithm can distinguish, with a probability arbitrarily close to one, between processes that are not bisimilar. Similarity relations over finite-state probabilistic models via exact probabilistic simulation relations are also presented in [SL95]. In general, similarities are based on simulation or bisimulation relations, and can be either exact or approximate. Whenever the relation between a concrete model and its abstraction is symmetric, it is called “bisimulation relation.” Exact simulation relations require the outputs of related systems to be exactly the same, while approximate simulation relations relax this requirement by allowing the outputs to differ up to a given error term [BK08, Tab09, BYG17].

Admittedly, exact bisimulation relations raise very strong requirements amongst models, and in practice very limited classes of models can admit abstractions with those types of relations [DLT08, DAK12]. This is particularly true for continuous-space models [Aba13]. Similarity relations of probabilistic models via approximate versions of probabilistic (bi)simulation relations are provided in [DLT08]. The proposed framework is based on two-player games: the existence of a winning strategy for one of the players induces the ϵ -(bi)simulation, and furthermore letting $\epsilon = 0$ gives back the exact notion. The paper also proposes a polynomial time algorithm to compute a derived metric, where the distance between states s and t is defined as the smallest ϵ such that s and t are ϵ -equivalent.

An approximate probabilistic bisimulation relation for discrete-time Markov chains is proposed in [DAK12]. The provided scheme exploits the structure and properties of the approximate probabilistic bisimulation and leverages the mathematical framework of Markov set-chains [Har06] (related to Interval MC in Section 4.3) in order to provide a quantified upper bound on a metric over probabilistic realizations for labeled Markov chains. It is shown that the existence of an approximate probabilistic bisimulation relation implies the preservation of robust PCTL formulae.

Similarity relations for models with general, uncountable state spaces have also been proposed in the more recent literature [Pan09, Aba13]. These relations can depend on stability requirements, on model’s dynamics via martingale theory [HH14a], or on contractivity analysis [ZMEM⁺14]. Notably, the work in [ZMEM⁺14] argues that every stochastic control system satisfying a probabilistic variant of incremental input-to-state stability (δ -ISS), and for every given precision $\varepsilon > 0$, a finite-state transition system can be constructed that is ε -approximately bisimilar to the original stochastic control system. It also provides a closeness bound between the δ -ISS stochastic control system and its bisimilar finite abstraction, related to the one in (8.1).

Similarity relations of dt-SCS via approximate (bi)simulation relations are proposed in [DGJP04], in which the relations enforce structural abstractions of a model by exploiting continuity conditions on its probability laws. Approximation metrics of stochastic processes, in particular Markovian processes in discrete time evolving on general state spaces (which are again domains with infinite cardinality and endowed with proper measurability and metric structures), are based in [Aba13] on the notion of probabilistic bisimulation.

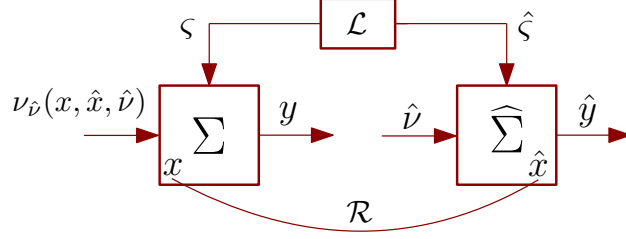

FIGURE 5. Notion of *lifting* for specifying the similarity between a dt-SCS Σ and its abstraction $\widehat{\Sigma}$.

Labelled Markov processes (LMP) as probabilistic versions of labelled transition systems with continuous-state spaces are widely discussed in [Pan09] and related to dt-SCS [AKNP14]. This book covers basic probability and measure theory on continuous-state spaces and then develops the theory of LMPs. The main topics covered are bisimulation, the logical characterization of bisimulation, metrics and approximation theory.

Probabilistic model checking of dt-SCS via finite approximate bisimulations is proposed in [AKNP14]. The paper considers notions of (exact and approximate) probabilistic bisimulation and proposes a technique to compute an approximate probabilistic bisimulation of a dt-SCS, where the resulting abstraction is characterized as a finite-state Markov chain.

A notion of approximate similarity relation based on “lifted” probability measures is presented in [HSA17], which is inspired by notions of similarity relations proposed in [SL95] for finite-state systems. The provided relation, underpinned by the use of metrics, allows in particular for a useful trade-off between deviations over probability distributions on states, and metric-based distances between model outputs. This new relation is inspired by a notion of simulation developed for finite-state models, and can be effectively employed over dt-SCS for both verification and synthesis purposes. The work also quantifies the distance in probability between the original system and its abstraction as a version of the closeness guarantee proposed in (2.3). The notion of lifting for specifying the similarity between a dt-SCS Σ and its abstraction $\widehat{\Sigma}$ is schematically shown in Figure 5. The relation \mathcal{R} connects states of the two dt-SCS, and \mathcal{L} specifies the relation between the two noises. The interface function $\nu_{\delta}(x, \hat{x}, \hat{\delta})$ is used for refining a policy from the abstract system to the concrete one.

These notions and results are then generalized in [HSA18] to a larger class of temporal properties ((bounded) probabilistic reachability problems and co-safe LTL specifications) and in [HS18] to synthesize policies for a robust satisfaction of these properties, with applications in building automation systems [HCA17]. An extension of these results to *networks* of dt-SCS is presented in [LSZ20b], and will be discussed in more detail in Section 7.

An approach for computing probabilistic bisimilarity distances for finite-state probabilistic automata has been proposed in [BBL⁺19]. The work proves that the bisimilarity distance bounds the difference in the maximal (or minimal) probability of two states to satisfy any arbitrary ω -regular properties (*i.e.*, (namely, the notion is specification-independent). As expected, since the proposed results should hold for any arbitrary ω -regular specification, it can be much more conservative and difficult to be fulfilled or checked, compared to establishing the previously mentioned guarantees for a given specification.

A notion of approximate probabilistic trace equivalences for both finite-state Markov processes and dt-SCS, and its relation to approximate probabilistic bisimulation, is presented in [BA17]. The proposed framework induces a tight upper bound on the approximation between finite-horizon traces, as expressed by a total variation distance. This bound can be employed to relate the closeness in satisfaction probabilities over bounded linear-time properties, such as in Equation (2.3), and allows for probabilistic model checking of concrete models via their abstractions.

We conclude by raising the following open challenge.

Open Problem 1. *Let Σ_1 and Σ_2 be two dt-SCSs. Develop an approach for computing the probabilistic bisimilarity distance between Σ_1 and Σ_2 , satisfying any ω -regular specification φ as follows:*

$$|\mathbb{P}(\Sigma_1 \models \varphi) - \mathbb{P}(\Sigma_2 \models \varphi)| \leq \lambda_3, \quad \forall \varphi.$$

3. INFINITE ABSTRACTIONS

The computational complexity associated to verifying or to synthesizing controllers for dt-SCS (and thus for SHS) models can be alleviated leveraging abstractions in two consecutive stages. In the first phase, the original complex systems can be abstracted by models either with simpler dynamics (e.g. linear, noiseless, or etc) or lower-dimensional state spaces (this is also known in the control literature as “model-order reduction”). Then one can employ those simpler models (a.k.a. infinite abstractions) as a replacement of original systems, perform analysis and synthesis over those models, and finally refine the results back (via an interface map) over the original models. Since the mismatch between outputs of original systems and those of their infinite abstractions are formally quantified, one can guarantee that concrete systems also satisfy the specifications as abstract ones with some guaranteed error bounds. An example of infinite abstractions is schematically depicted in Figure 6. In comparison with Figure 1, which focuses on discretization-based techniques to obtain finite abstractions, Figure 6 focuses on infinite abstractions with lower-dimensional systems.

Remark 3.1. *Infinite abstractions can take numerous shapes and forms: they can for instance be linearized versions of the original models, they can be obtained via polynomial truncation, they can be models with different noises (e.g., stochastic realizations [vS89]), or even models without noise [ZMEM⁺14]. The main focus of this section is on infinite abstractions with lower-dimensional state spaces.*

Note that one can construct finite abstractions directly, namely without going through infinite abstractions first (e.g., those obtained via model-order reduction). However, constructing finite abstractions for high-dimensional systems can result in large finite state spaces, which might not be practically viable with limited computational and memory resources. One of the main benefits of infinite abstractions is thus to help reducing dimensions or complexity of concrete systems, and then leveraging finite abstractions for the reduced-order versions, while still providing the probabilistic closeness guarantees.

Developed earlier for continuous-time models [JP09, Aba09, Aba10] and further discussed in Section 8, the construction of infinite abstractions for discrete-time stochastic control systems is proposed in [LSMZ17] and [LSZ20d]. The abstraction framework is based on notions of stochastic simulation functions (Def. 1.6). These functions relate output trajectories of an abstract system to those of the original one, such that the mismatch between the output trajectories of two systems remains within some guaranteed error bound. Through these stochastic simulation functions it is possible to quantify the probabilistic distance between the original stochastic system and its abstraction, based on the closeness in (2.6). The aforementioned work also focuses on a class of discrete-time *linear* stochastic control systems, as in (3.1) and further detailed next, and proposes a computational scheme to construct infinite abstractions together with their corresponding stochastic simulation functions.

Consider the class of discrete-time linear stochastic control system (a special instance of dt-SCS), as

$$\Sigma : \begin{cases} x(k+1) = Ax(k) + B\nu(k) + R\zeta(k), \\ y(k) = Cx(k), \end{cases} \quad (3.1)$$

where the additive noise $\zeta(k)$ is a sequence of independent random vectors with multivariate standard normal distributions. We use the tuple $\Sigma = (A, B, C, R)$ to refer to the class of linear systems in (3.1). In the next theorem, we establish a formal relation between Σ and its reduced-order model $\widehat{\Sigma}$, by constructing corresponding matrices $\widehat{A}, \widehat{B}, \widehat{C}, \widehat{R}$.

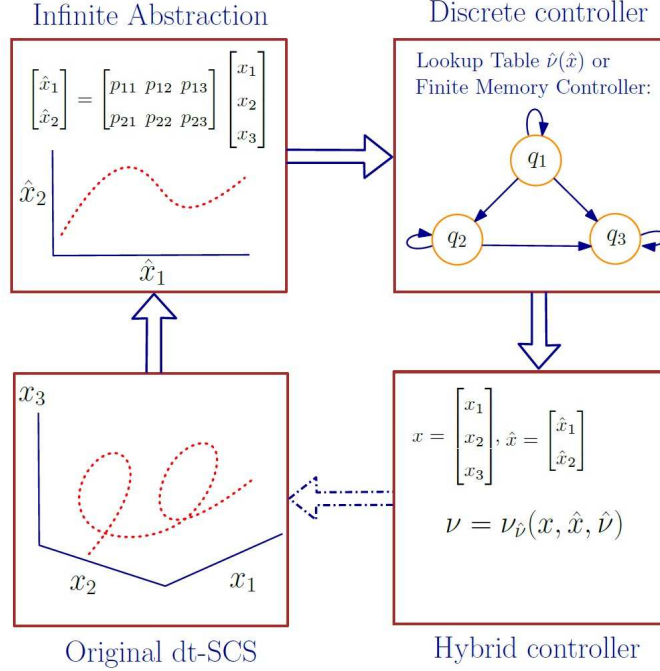

FIGURE 6. **Infinite abstractions.** The original dt-SCS has a 3-dimensional state set while its abstraction has a 2-dimensional state set. This model reduction can be performed via a transformation matrix P satisfying conditions (3.2) and (3.3).

Theorem 3.2. Let $\Sigma = (A, B, C, R)$, $\hat{\Sigma} = (\hat{A}, \hat{B}, \hat{C}, \hat{R})$ be two linear dt-SCS with independent additive noises. Suppose there exist a matrix K and a positive-definite matrix M such that the following matrix inequalities

$$\begin{aligned} C^T C &\preceq M, \\ ((1 + \pi)(A + BK)^T M (A + BK) - M) &\preceq -\hat{\kappa} M, \end{aligned}$$

hold for some constants $0 < \pi$ and $0 < \hat{\kappa} < 1$. If further

$$AP = P\hat{A} - BQ, \quad (3.2)$$

$$CP = \hat{C}, \quad (3.3)$$

hold for some matrices Q and P of appropriate dimension, then there exists a quadratic SSF $V(x, \hat{x})$ [LSMZ17] between Σ and $\hat{\Sigma}$ as

$$V(x, \hat{x}) = (x - P\hat{x})^T M (x - P\hat{x}), \quad (3.4)$$

where $P \in \mathbb{R}^{n \times \hat{n}}$ is a matrix of an appropriate dimension with \hat{n} being the dimension of the reduced-order model $\hat{\Sigma}$.

The stochastic simulation function $V(x, \hat{x})$ in (3.4) gives a formal probabilistic closeness guarantee between the original dt-SCS Σ and its infinite abstraction $\hat{\Sigma}$, as per (2.6).

Remark 3.3. Condition (3.2) holds as long as condition (V.18) in [ZA18] is satisfied. In addition, notice that the results in Theorem 3.2 do not impose any condition on the matrix \hat{B} , which thus can be chosen arbitrarily. As an example, one can select $\hat{B} = \mathbb{I}_{\hat{n}}$, which renders the abstract system $\hat{\Sigma}$ fully actuated and, hence, can facilitate a subsequent synthesis task.

Notice further that the matrix \hat{R} can be also chosen arbitrarily. In this case, the probabilistic closeness between two systems Σ and $\hat{\Sigma}$ can be quantified as λ_2 in (2.6), where

$$\psi = \text{Tr}(R^T M R + \hat{R}^T P^T M P \hat{R}).$$

One can readily verify that selecting $\hat{R} = 0$ results in a tighter relationship between the original system Σ and its infinite abstraction $\hat{\Sigma}$. However, observe that this is not the case when the noises of the concrete system and of its infinite abstraction are the same, as assumed in [Zam14, ZRME17] (i.e., the abstraction has access to the noise of the concrete system, which is a strong assumption in practice), where the developed probabilistic closeness is similar to that in (2.6).

The construction of infinite abstractions for dt-SCS is also discussed in [LSZ19b]. The proposed approach employs the notion of stochastic storage function (a variant of the stochastic simulation function in Definition 1.6) between a concrete system and its abstraction, which allows to provide a closeness guarantee as in (2.6). This work also focuses on a specific class of discrete-time *nonlinear* stochastic systems, with a nonlinearity Υ satisfying a slope restriction as

$$0 \leq \frac{\Upsilon(c) - \Upsilon(d)}{c - d} \leq b, \quad (3.5)$$

for any $c, d \in \mathbb{R}, c \neq d$, for some $b \in \mathbb{R}_{>0} \cup \{\infty\}$, and proposes a construction scheme for building infinite abstractions together with their corresponding stochastic storage functions.

It is worth mentioning that the contributions in [LSMZ17, LSZ19b] do not raise any restrictions on the sources of uncertainty in the concrete and abstract systems (i.e., the noises of the abstraction can be completely independent of that of the concrete system). In particular, the results provided in [LSMZ17, LSZ19b] are more general than [ZRME17], where the noises in the concrete and abstract systems are assumed to be the same, which practically means the abstraction has access to the noise of the concrete system. The results in [LSMZ17, LSZ19b] provide a closeness guarantee between output trajectories of Σ and $\hat{\Sigma}$ as in (2.6).

4. FINITE ABSTRACTIONS

In the second phase of the abstraction procedure (cf. Figure 1), one can construct finite abstractions usually in the form of finite Markov decision processes (MDPs). These abstractions are approximate descriptions of (reduced-order) systems in which each discrete state corresponds to a set of continuous states of the (reduced-order) systems. Since the obtained abstractions are finite, one can employ algorithmic machineries and existing software tools to automatically synthesize controllers, which can then be applied (refined) over the concrete models, thus enforcing complex properties, including specifications expressed as temporal logical formulae.

A concrete model Σ is approximated by a *finite* $\hat{\Sigma}$ using Algorithm 1. For the sake of an easier presentation, we present the construction algorithm just for dt-SCS, however we refer the interested reader to [ZTA17, TMKA17a, HSA17] for related, more general SHS, and to [ZA14b, ZAG15, LSZ20a] for the construction of finite MDPs for a class of SHS namely stochastic *switched* systems. To construct such a finite approximation, the state and input sets (over which one is interested to perform analysis and synthesis) of the dt-SCS Σ are restricted to be compact.² The rest of the state space can be considered as a single absorbing state. Algorithm 1 first constructs a finite partition of the state set $X = \cup_i X_i$ and the input set $U = \cup_i U_i$. Then arbitrary “representative points” $\bar{x}_i \in X_i$ and $\bar{v}_i \in U_i$ are selected as abstract states and inputs. Transition probabilities in the finite MDP $\hat{\Sigma}$ are computed according to (4.1). The output map \hat{h} is the same as h with its domain restricted to the finite set \hat{X} (cf. Step 7) and the output set \hat{Y} is the image of \hat{X} under h (cf. Step 6).

²This compactness assumption can be relaxed, as in [SA14a, SA15].

Algorithm 1 Approximation of a dt-SCS Σ by a finite MDP $\widehat{\Sigma}$ **Require:** Input dt-SCS $\Sigma = (X, U, T_x, Y, h)$

- 1: Select finite partitions of sets X, U as $X = \cup_{i=1}^{n_x} X_i, U = \cup_{i=1}^{n_u} U_i$
- 2: For each X_i , and U_i , select single representative points $\bar{x}_i \in X_i, \bar{u}_i \in U_i$
- 3: Define $\hat{X} := \{\bar{x}_i, i = 1, \dots, n_x\}$ as the finite state set of MDP $\widehat{\Sigma}$ with the finite input set $\hat{U} := \{\bar{u}_i, i = 1, \dots, n_u\}$
- 4: Define the map $\Xi : X \rightarrow 2^{\hat{X}}$ that assigns to any $x \in X$, the corresponding partition set it belongs to, *i.e.*, $\Xi(x) = X_i$ if $x \in X_i$ for some $i \in \{1, 2, \dots, n_x\}$
- 5: Compute the discrete *transition probability matrix* \hat{T}_x for $\widehat{\Sigma}$ as:

$$\hat{T}_x(x'|x, \nu) = T_x(\Xi(x')|x, \nu), \quad (4.1)$$

for all $x, x' \in \hat{X}, \nu \in \hat{U}$

- 6: Define the output space $\hat{Y} := h(\hat{X})$
- 7: Define the output map $\hat{h} := h|_{\hat{X}}$

Ensure: Output finite MDP $\widehat{\Sigma} = (\hat{X}, \hat{U}, \hat{T}_x, \hat{Y}, \hat{h})$ Given a dt-SCS $\Sigma = (X, U, \varsigma, f, Y, h)$, the finite MDP $\widehat{\Sigma}$ constructed in Algorithm 1 can be represented as

$$\widehat{\Sigma} = (\hat{X}, \hat{U}, \varsigma, \hat{f}, \hat{Y}, \hat{h}), \quad (4.2)$$

where $\hat{f} : \hat{X} \times \hat{U} \times \mathcal{V}_\varsigma \rightarrow \hat{X}$ is defined as

$$\hat{f}(\hat{x}, \hat{u}, \varsigma) = \Pi_x(f(\hat{x}, \hat{u}, \varsigma)), \quad (4.3)$$

and $\Pi_x : X \rightarrow \hat{X}$ is the map that assigns to any $x \in X$, the representative point $\bar{x} \in \hat{X}$ of the corresponding partition set containing x . The initial state of $\widehat{\Sigma}$ is also selected according to $\hat{x}_0 := \Pi_x(x_0)$, with x_0 being the initial state of Σ .

The dynamical representation of the abstract finite MDP $\widehat{\Sigma}$ employs the map $\Pi_x : X \rightarrow \hat{X}$, which satisfies the inequality

$$\|\Pi_x(x) - x\| \leq \delta, \quad \forall x \in X, \quad (4.4)$$

where $\delta := \sup\{\|x - x'\|, x, x' \in X_i, i = 1, 2, \dots, n_x\}$ is the state discretization parameter.

Remark 4.1. *Observe that the state discretization parameter δ appears in the probabilistic closeness quantified in (2.3)-(2.6): thus, one can decrease the error by reducing the state discretization parameter, namely by aptly refining the state partitions. Notice that there is no requirement on the shape of the partition elements in constructing the finite MDPs. For the sake of an easier implementation, one can for instance consider partition sets as hyper-boxes, and representative points as centers of each box (cf. Figure 7). The errors and guarantees derived above provide flexibility and have been embedded in a few software tools generating finite abstractions, cf. [SGA15, LKSZ20].*

4.1. Abstractions for Finite-Horizon Specifications. The construction of finite abstractions of SHSs has been initially proposed in [AKLP10] and used for formal verification and synthesis. This work investigates probabilistic safety and reachability over a finite-time horizon for a general class of discrete-time SHS with control inputs. The proposed framework characterizes the set of initial conditions providing a certain probabilistic guarantee that the system will keep evolving within a desired ‘safe’ region of the state space in terms of a value function, and determines ‘maximally safe’ Markov policies via dynamic programming over the finite abstract MDP. An improved gridding scheme, which is adaptive and sequential, for the abstraction and verification of stochastic processes is proposed in [SA13] (cf. Remark 4.1). The abstract model is constructed as a Markov chain using an adaptive gridding algorithm that conforms to the underlying dynamics of the model and thus mitigates the curse of dimensionality unavoidably related to the partitioning procedure. The work focuses on the study of a particular specification (probabilistic safety or invariance, over a finite horizon) and

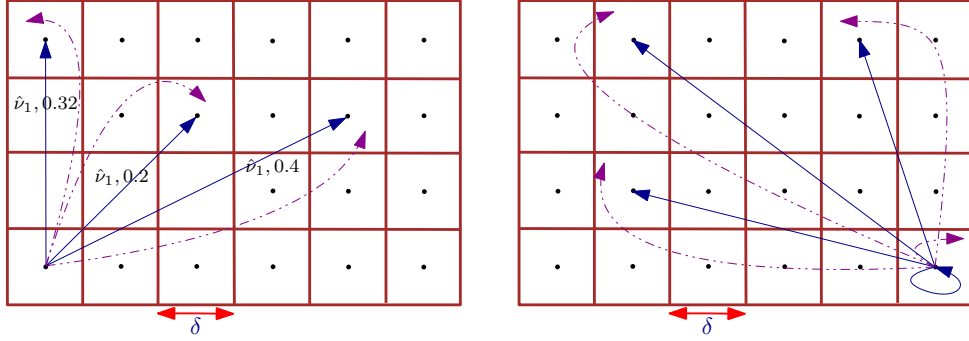

FIGURE 7. Construction of finite MDPs: A grid is first overlaid on the state and input sets. The center of each cell is considered as a representative point, and the transition probability (*i.e.*, probability of jumping from each representative point in a cell to all other cells) for all possible discrete inputs is computed. By repeating the process and storing the probabilities in a matrix called *transition probability matrix*, the corresponding finite MDP is accordingly constructed.

the results are then extended to SHS models with hybrid state spaces. The closeness guarantee between the original SHS and their finite abstractions is in the form of (2.3).

The above results in general rely on Lipschitz continuity of the stochastic kernel associated with the system. The works [SA12b, SA14b] extend the method for systems with discontinuous stochastic kernels and provide error bounds for inequalities of the form (2.3). On the other hand, if the kernel admits higher-order derivatives, refined computations are proposed in [SA12a], with errors that naturally depend on higher orders of the discretization parameter δ and that can show faster convergence to zero.

Among the many applications of these formal abstractions, the approach is employed to aggregate modeling and control of thermostatically controlled loads, as in [SGE⁺14], and in building automation [CA18]. In the aggregation procedure, each thermostatically controlled load model in the population, in principle similar to the Running Example in this paper, is formally abstracted as a finite MDP, and the cross product of these MDPs is lumped into its coarsest (exact) probabilistic bisimulation, and can be used for predictive energy scheduling. The abstraction procedure allows for the quantification of the induced error in the form of (2.3).

The construction of finite abstractions for stochastic control systems is presented in [SAM15, SAM17]. These studies investigate the problem of finite-horizon probabilistic invariance for dt-SCS by providing a closeness guarantee between two systems in the form of (2.3). The proposed approach is more general than [LSZ20d, LSZ18b], since the provided framework does not require original systems to be δ -ISS. On the other hand, the abstraction error in [SAM15, SAM17] depends on the Lipschitz constants of the stochastic kernels associated with the system, and accordingly, it grows to infinity as the standard deviation of the noise goes to zero, which is not the case in [LSZ20d, LSZ18b].

Running example (continued). We construct a finite MDP from the model in (1.4) according to Algorithm 1, with the state discretization parameter $\delta = 0.005$. By taking the initial states of the two models Σ and $\widehat{\Sigma}$ to be equal to 20, and using the proposed bound in (2.6), one can guarantee that the distance between the outputs of Σ and $\widehat{\Sigma}$ does not exceed $\varepsilon = 0.5$ over the time horizon $T_d = 100$, with a probability of at least 98%, *i.e.*,

$$\mathbb{P}\left\{\|y(k) - \hat{y}(k)\| \leq 0.5, \forall k \in [0, 100]\right\} \geq 0.98. \quad (4.5)$$

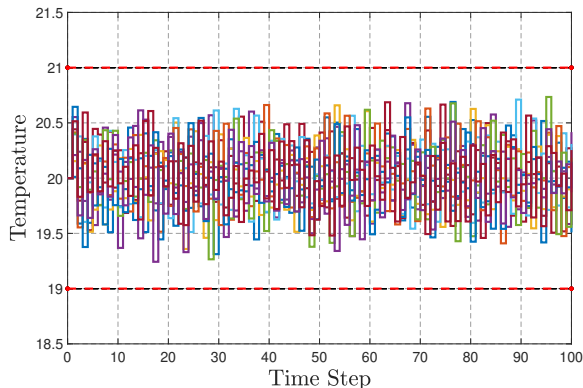

FIGURE 8. Closed-loop state trajectories with 10 different noise realizations for the finite time horizon $T_d = 100$.

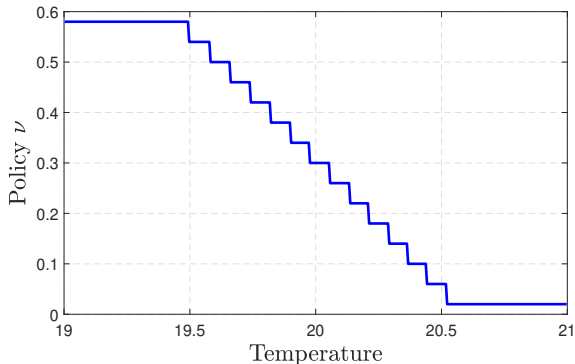

FIGURE 9. Synthesized policy as a function of state (room temperature).

Let us now synthesize a controller for Σ via its finite abstraction $\widehat{\Sigma}$, such that for Σ the temperature of the room remains in the safe region $[19, 21]$. This is attained by employing the software tool AMYTISS [LKSZ20]. The synthesized policy of the room as a function of state is illustrated in Figure 9. Closed-loop state trajectories describing the dynamics of the room temperature over the finite-time horizon $T_d = 100$, under 10 different noise realizations, are illustrated in Figure 8. We remark that the synthesized concrete policy for this example is simply chosen as $\nu = \hat{\nu}$, which is a special case of the interface function discussed in Remark 1.7.

In order to better understand the provided probabilistic bound in (4.5), we also run Monte Carlo simulation of 10000 runs. One expects that the distance between the outputs of Σ and $\widehat{\Sigma}$ is always less than or equal to 0.1 with a probability at least of 98%, and indeed this bound is easily matched in practice. Indeed, we expected the empirical outcomes to be tighter, due to the conservative nature of Lyapunov-like techniques (simulation functions) and associated error bounds. \square

4.2. Abstractions for Infinite-Horizon Specifications. The construction of finite Markov chains for discrete-time stochastic models with continuous state spaces and their use to verify infinite-horizon properties (*e.g.*, safety and reachability specifications) is proposed by a line of work in [TA11, TA12a, TA12b, TA14]. The proposed approaches employ notions of stochastic bisimulation functions and provide a lower bound for

infinite-time probabilistic invariance (cf. equations (2.7) and (2.8)) by decomposing this property into a finite-time reach-avoid together with an infinite-time invariance around absorbing sets (cf. Definition 4.2 below) over the state space of the model.

A quantitative abstraction-based controller synthesis for SHS is discussed in [TMKA13] and later extended in [TMKA17b]. The problem is reformulated as an optimization of a probabilistic reachability property over a product process (known as product automaton), which is obtained from the model of the specification and that of the system. The work develops a discretization procedure, which results in a standard synthesis problem over Markov decision processes with history-independent Markov policies, with errors of the form (2.3) and (2.4), respectively.

The satisfaction probability of infinite-horizon properties is theoretically investigated in [TA14]. Extending to control-dependent models in [TMKA17b], it is shown that the satisfaction probability depends on the existence of *absorbing sets*, as defined next.

Definition 4.2. *The set $\mathcal{A} \in \mathcal{B}(X)$ is called (weakly) absorbing if there exists a randomized selector $\bar{\mu}$ such that for all $x \in \mathcal{A}$, it holds that $\bar{\mu}(U \mid x) = 1$ and*

$$\int_U T_x(\mathcal{A} \mid x, \nu) \bar{\mu}(d\nu \mid x) = 1.$$

We say that the set $\mathcal{A} \in \mathcal{B}(X)$ is simple if it does not have non-empty (weakly) absorbing subsets.

Employing Definition 4.2, the following theorem is proposed in [TMKA17b].

Theorem 4.3. *The infinite-horizon safety probability for a continuous-space dt-SCS and a compact safe set \mathcal{S} is equal to zero over the entire set if and only if the safe set \mathcal{S} does not contain any absorbing sets.*

If the underlying system is a finite MDP, the simple absorbing sets in Definition 4.2 are bottom strongly connected components (BSCCs) of the MDP, and computing these BSCCs is straightforwardly done by graph search algorithms. Conversely, no computational method is proposed in the literature for finding absorbing sets of continuous systems. Motivated by Definition 4.2 and Theorem 4.3, we present the following open problem, which would allow to expand beyond the results in [TA14, TMKA17b].

Open Problem 2. *Given a dt-SCS with continuous-state space, compute its absorbing sets, or to compute over- and under-approximations of such absorbing sets within a-priori precision.*

A method to generate finite Markovian abstractions for discrete-time linear stochastic systems is provided in [LAB12]. The proposed approach proceeds by approximating the transition probabilities from one partition set to another by calculating the probability from a single representative point in the first region. The work employs an adaptive refinement algorithm that takes advantage of the dynamics of the system to achieve a desired error value. The proposed approach is similar to that of [SA13] with a closeness guarantee in the form of (2.3), however here the transition probabilities are averaged over partition sets.

The construction of finite abstractions for discrete-time stochastic systems is also pursued in [LSZ18b, LSZ18a]. Focusing on a specific class of linear dt-SCS, these results employ notions of stochastic simulation (or storage) functions by providing a probabilistic distance between the interconnection of stochastic control subsystems and that of their finite abstractions based on (2.6).

The construction of finite MDPs for stochastic systems that are not necessarily stabilizable is presented in [LSZ19c, LZ19, LSZ20c]. The proposed frameworks rely on a relation between a system and its finite abstraction employing a new notion called *finite-step* stochastic simulation. In comparison with the existing notions of simulation functions in which stability or stabilizability of each subsystem is required, a *finite-step* stochastic simulation function needs to decay only after some finite numbers of steps (rather than at each time step). This results in a less conservative approach in the sense that one can compositionally

construct finite MDPs such that stabilizability of each subsystem is not necessarily required. The work in [LSZ19c, LZ19, LSZ20c] provides a closeness guarantee between output trajectories of Σ and $\widehat{\Sigma}$ as per (2.6).

The construction of finite abstractions for stochastic *switched* systems is presented in [LSZ20a, LZ20]. The transition map switches between a finite set of modes and the switched system accepts multiple Lyapunov (or storage) functions with a dwell-time condition that puts a lower bound on the interval between two consecutive switching time instants. The dwell-time is deterministic and always met by the controller designed using the finite MDP. In particular, switching signals in those works are control inputs and the main goal is to synthesize them with a specific dwell-time, such that the output of original systems satisfies some high-level specifications, such as safety, reachability, etc. Those works utilize notions of stochastic simulation (or storage) functions and provide a closeness guarantee in the form of (2.6) but adapted to the switched setup. These works also show that under standard assumptions ensuring incremental input-to-state stability of switched systems similar to Definition 1.5 (*i.e.*, existence of common incremental Lyapunov (or storage) functions, or multiple incremental Lyapunov (or storage) functions with some dwell-time conditions), one can construct finite MDPs for nonlinear stochastic switched systems. These results also propose an approach to construct finite MDPs together with their corresponding stochastic simulation (or storage) functions for a particular class of nonlinear stochastic switched systems whose nonlinearity Υ satisfies either a slope restriction similar to (3.5) or an incremental quadratic inequality as

$$\begin{bmatrix} d_2 - d_1 \\ \Upsilon_p(k, d_2) - \Upsilon_p(k, d_1) \end{bmatrix}^T \bar{Q}_p \begin{bmatrix} d_2 - d_1 \\ \Upsilon_p(k, d_2) - \Upsilon_p(k, d_1) \end{bmatrix} \geq 0, \quad (4.6)$$

for all $k \in \mathbb{N}$, $d_1, d_2 \in \mathbb{R}$, for all switching modes $p \in P = \{1, \dots, m\}$, and for all $\bar{Q}_p \in \bar{\mathcal{Q}}_p$, where $\bar{\mathcal{Q}}_p$ is the set of symmetric matrices referred to as “incremental multiplier” matrices. For this class of nonlinear systems, the aforementioned incremental stability property can be readily checked via matrix inequalities.

Abstraction-based synthesis of general MDPs using approximate probabilistic relations is proposed in [LSZ19a, LSZ20b]. The abstraction framework is based on the notion of δ -lifted relations, which is similar to [HSA17], using which one can quantify the distance in probability between dt-SCS and that of their abstractions as a version of closeness guarantee proposed in (2.3). The works focus on a class of stochastic nonlinear dynamical systems and construct their (in)finite abstractions using both model order reduction and space discretization in a unified framework.

An alternative approach to handle infinite-horizon specifications is to employ interval MCs or interval MDPs, as discussed in the next subsection.

4.3. Abstractions as Interval Markov Models. The classical finite-state Markov models seen in the previous sections are not the only possible architecture for abstractions: uncertain Markov models can as well be employed for this task, and indeed they have been in particular employed to construct finite abstractions that are capable of satisfying infinite-time horizon properties in a more natural manner than standard Markov models. Uncertain Markov models have been studied under different but related perspectives and semantics: [Jun20] provides an overview of existing approaches, and in particular focuses on models where the uncertainty is described parametrically, where probabilities are symbolic expressions rather than concrete values. [Jun20] discusses the parameter synthesis problem for the analysis of this class of Markov models. Alternatively, when the probabilities of transition between states belong to intervals, we can use interval Markov chains (IMC) and interval Markov decision processes (IMDP).

The definition of IMDP is similar to finite MDP as in Algorithm 1 with a tuple $\widehat{\Sigma}_I = (\widehat{X}, \widehat{U}, \widehat{T}_{x_1}, \widehat{T}_{x_2}, \widehat{Y}, \widehat{h})$ where the exact transition probabilities are not known but are bounded above and below as $\widehat{T}_{x_1} \leq \widehat{T}_x \leq \widehat{T}_{x_2}$. An IMC is schematically depicted in Figure 10.

It is worth mentioning that constructing IMCs/IMDPs can be more complicated compared to standard MCs/MDPs since one needs to provide both lower and upper bounds for probabilities of transitions among

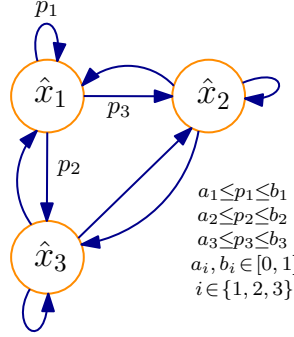

FIGURE 10. Example of an IMC.

partition sets, by solving max-min optimization problems. However, one can mitigate the construction complexity if the system has a property called *mixed-monotonicity* and if the noise of the system has some nice properties.

Definition 4.4. A function $f : X \rightarrow X$ is called *mixed monotone* if there exists a decomposition function $g : X \times X \rightarrow X$ satisfying [Smi08, CA15]

- $\forall x \in X : f(x) = g(x, x)$,
- $\forall x_1, x_2, z \in X : x_1 \leq x_2$ implies $g(x_1, z) \leq g(x_2, z)$,
- $\forall x, z_1, z_2 \in X : z_1 \leq z_2$ implies $g(x, z_2) \leq g(x, z_1)$.

Mixed monotonicity generalizes the notion of monotonicity in dynamical systems, which is recovered when $g(x, z) = f(x)$ for all x, z .

Consider the discrete-time stochastic system $x(k+1) = f(x(k)) + \zeta(k)$, where $f(\cdot)$ is mixed monotone and entries of the noise $\zeta(\cdot)$ are independent with unimodal distributions. Then, an IMC as abstraction of this system can be computed without the need for the optimization required in the computation of $\hat{T}_{x_1}, \hat{T}_{x_2}$ [DC19].

Specification-guided verification and abstraction refinement for mixed-monotone stochastic systems against omega-regular specifications are proposed in [DC19]. The article presents a procedure to compute a finite-state interval-valued Markov chain abstraction of discrete-time mixed-monotone stochastic systems subject to additive noise, given a rectangular partition of the state space. An algorithm is proposed for performing verification against omega-regular properties in IMCs that aims to compute bounds on the probability of satisfying a specification from any initial state of the IMC, in the form of (2.7). This is achieved by solving a reachability problem on sets of so-called “winning and losing” components in the Cartesian product between the IMC and a Rabin automaton representing the original specification.

The results of [DC19] have been recently extended to the controller synthesis problem for discrete-time, continuous-state stochastic systems, under omega-regular specifications, by means of finite-state abstractions [DHC20]. The work presents a synthesis algorithm for optimizing the probability that a discrete-time stochastic switched system with a finite number of modes satisfies an omega-regular property. The approach relies on a finite-state abstraction of the underlying dynamics in the form of a bounded-parameter Markov decision process arising from a finite partition of the model’s domain, with errors in the form of (2.7). Such Markovian abstractions allow for a range of probabilities of transitions between states for each selected action representing a mode of the original system. The proposed framework decomposes the synthesis into a qualitative problem, where the so-called greatest permanent winning or losing components of the product automaton are created, and a quantitative problem, which requires maximizing the probability of reaching these components in the worst-case instantiation of the transition intervals.

Remark 4.5. *The results in [DC19] and [DHC20] leverage the mixed-monotonicity property (cf. Definition 4.4) of the deterministic part of the map f by assuming that (i) the stochasticity is additive, (ii) the distribution of the noise is unimodal, and (iii) noises of different states are independent from each other. This observation leads to the following open problem.*

Open Problem 3. *Provide a suitable definition of mixed-monotonicity for stochastic systems based on their stochastic kernels and investigate which classes of systems satisfy that property. An initial investigation is provided in Subsection 11.4.*

An abstraction framework for mapping a discrete-time stochastic system to an IMC and mapping a switched dt-SCS to a bounded-parameter Markov decision process (BMDP) is proposed in [LAB15]. The work constructs model checking algorithms for IMCs and BMDPs against PCTL formulae to find sets of initial states that definitely, possibly, and never satisfy a given specification. It also develops an algorithm for BMDPs that synthesizes a policy maximizing the probability of satisfaction, and further proposes an adaptive refinement algorithm that exploits the dynamics of the system and the geometry of the partition to increase the precision of the solution. The work proposes a closeness guarantee in the form of (2.7).

Approximate abstractions of dt-SCS with interval MDPs are proposed in [ZLWDA18]. The abstraction leverages the semantics of IMDPs and the standard notion of approximate probabilistic bisimulation. The resulting model presents a smaller one-step bisimulation error, in the form of Equation (2.3) or (2.4), when compared to a Markov chain abstraction. The work outlines a method to perform probabilistic model checking, and shows that the computational complexity of the new method is comparable to that of standard abstractions based on approximate probabilistic bisimulations.

A constructive procedure for obtaining a finite abstraction of a discrete-time SHS is proposed in [ADB11], with errors as in Equation (2.7) but usable over infinite horizons. Similar to the finite abstractions discussed above, the procedure consists of a partition of the state space of the system which depends on a controllable parameter. Given proper continuity assumptions on the model, the approximation errors introduced by the abstraction procedure are explicitly computed and it is shown that they can be tuned through the parameter of the partition.

An efficient abstraction framework for formal analysis and control synthesis of a class of discrete-time SHS with linear dynamics is developed in [CLL⁺19]. The work constructs IMDPs and focuses on temporal logic specifications over both finite- and infinite-time horizons. A strategy that maximizes the satisfaction probability of the given specification is synthesized over the IMDP and mapped to the underlying SHS. In contrast to existing formal approaches, which are by and large limited to finite-time properties and rely on conservative over-approximations, the article shows that the exact abstraction error can be computed as a solution of convex optimization problems and can be embedded into the IMDP abstraction. This is later used in the synthesis step over both bounded- and unbounded-time properties, mitigating the known state-space explosion problem but at the cost of lack of convergence guarantees.

Open Problem 4. *The discussed results in the setting of IMCs/IMDPs by and large provide a guarantee in the form of (2.7). In particular, the satisfaction probability computed over the IMDPs gives a lower bound for the probability of satisfaction over the original system. Quantify instead the distance between the probability of satisfactions over the two systems in the form of equation (2.3) or (2.4).*

5. VERIFICATION AND SYNTHESIS VIA BARRIER CERTIFICATES

As discussed in the previous sections, discretization-free approaches can prevent the curse of dimensionality arising in the construction of finite abstractions. In this section we discuss discretization-free approaches based on (control) barrier certificates that have been proposed in recent years. Work in this domain follows seminal contributions in [PJP07] and the following [JP09, Aba09, Aba10] (these are further discussed below), which

however are developed for continuous-time models. We first formally define control barrier certificates in the context of this work.

Definition 5.1. Consider a dt-SCS $\Sigma = (X, U, \varsigma, f, Y, h)$ with sets $X_0, X_u \subseteq X$ that are respectively initial and unsafe sets of the system. A function $\mathbb{B} : X \rightarrow \mathbb{R}_{\geq 0}$ is called a control barrier certificate (CBC) for Σ if there are constants $\eta, \beta \in \mathbb{R}_{\geq 0}$ with $\beta > \eta$ such that

$$\mathbb{B}(x) \leq \eta, \quad \forall x \in X_0, \quad (5.1)$$

$$\mathbb{B}(x) \geq \beta, \quad \forall x \in X_u, \quad (5.2)$$

and $\forall x \in X, \exists \nu \in U$, such that

$$\mathbb{E} \left[\mathbb{B}(x(k+1)) \mid x(k), \nu(k) \right] \leq \max \left\{ \kappa \mathbb{B}(x(k)), c \right\}, \quad (5.3)$$

for constants $0 < \kappa \leq 1$ and $c \in \mathbb{R}_{\geq 0}$.

Remark 5.2. Note that the existential quantifier for the condition in (5.3) implies the existence of a feedback controller for a model satisfying the conditions.

Employing Definition 5.1, one can propose an upper bound on the probability that the dt-SCS in (1.3) reaches an unsafe region over a finite time horizon, as presented in the next theorem. Note that the requirement $\beta > \eta$ is needed in order to propose meaningful probabilistic bounds. Corollary 5.5 and the subsequent remark discuss the choice of the constant c in the statement above.

Theorem 5.3. Consider a dt-SCS $\Sigma = (X, U, \varsigma, f, Y, h)$ and a CBC \mathbb{B} for Σ . Then the probability that the solution process of Σ starts from any initial state $x(0) \in X_0$ and reaches X_u under the policy $\nu(\cdot)$ (associated with the CBC \mathbb{B}) within the time interval $[0, T_d]$ is bounded by $\bar{\delta}$, namely

$$\mathbb{P} \left\{ x(k) \in X_u \text{ for some } k \in [0, T_d] \mid x(0) \in X_0 \right\} \leq \bar{\delta}, \quad (5.4)$$

where if $0 < \kappa < 1$:

$$\bar{\delta} := \begin{cases} 1 - (1 - \frac{\eta}{\beta})(1 - \frac{c}{\beta})^{T_d}, & \text{if } \beta \geq \frac{c}{\kappa}, \\ (\frac{\eta}{\beta})(1 - \kappa)^{T_d} + (\frac{c}{\kappa\beta})(1 - (1 - \kappa)^{T_d}), & \text{if } \beta < \frac{c}{\kappa}, \end{cases} \quad (5.5)$$

whereas if $0 < \kappa \leq 1$:

$$\bar{\delta} := \frac{\eta + cT_d}{\beta}. \quad (5.6)$$

Remark 5.4. Note that the upper bound proposed in (5.5) is less conservative than that of (5.6) in the sense that (5.5) yields a tighter probabilistic bound. On the other hand, the proposed bound in (5.6) is more general, since there may not exist a κ strictly less than one satisfying condition (5.3) for many classes of models and dynamics.

The results in Theorem 5.3 provide upper bounds on the probability that the models reach unsafe regions within a finite time horizon. One can generalize the proposed results to an infinite time horizon, provided that the constant $c = 0$, as stated in the following corollary.

Corollary 5.5. Let $\Sigma = (X, U, \varsigma, f, Y, h)$ be a dt-SCS and suppose \mathbb{B} is a CBC for Σ with $c = 0$ in (5.3). Then the probability that the trajectory of Σ starts from any initial state $x(0) \in X_0$ and reaches X_u under the policy $\nu(\cdot)$ is bounded by

$$\mathbb{P} \left\{ x(k) \in X_u \text{ for some } k \geq 0 \mid x(0) \right\} \leq \frac{\eta}{\beta}. \quad (5.7)$$

Remark 5.6. *Note that a CBC \mathbb{B} satisfying condition (5.3) with $c = 0$ is a non-negative supermartingale [Kus67, Chapter I]. Although the supermartingale property on \mathbb{B} allows one to provide probabilistic guarantees for infinite-time horizons via Corollary 5.5, it is restrictive in the sense that a supermartingale \mathbb{B} may not exist [ST12, JSZ20]. One may therefore employ a more general c -martingale type condition as in (5.3) that does not require such an assumption at the cost of providing probabilistic guarantees for finite-time horizons.*

Note that the computation underlying CBC does not generate an abstract model, and accordingly it does not rely on any similarity relation and closeness error as presented in Definition 1.1. Instead, one can employ Definition 5.1 together with Theorem 5.5 and directly compute an upper bound on the probability that a dt-SCS reaches an unsafe region in a finite-time horizon, much alike (2.7).

Remark 5.7. *Note that the verification problem is a special case of the synthesis one, in which the main goal is to verify that the property of interest is satisfied with some probability lower-bound. The statements above can be accordingly tailored by changing the quantifier ‘ \exists ’ in (5.3) to ‘ \forall ’, and the results follow.*

5.1. Computation of CBC and of Control Policies. In this subsection, we discuss suitable methods to search for CBCs and to synthesize corresponding control policies. We study two different approaches based on (i) sum-of-squares (SOS) optimization and on (ii) counter-example guided inductive synthesis (CEGIS) [JSZ20].

5.1.1. Sum-of-Squares Optimization Problem. We reformulate conditions (5.1)-(5.3) as an SOS optimization problem [Par03], where a CBC is restricted to be a non-negative polynomial that can be written as a sum of squares of different polynomials. To do so, the following assumption is required.

Assumption 2. *The dt-SCS Σ has a continuous state set $X \subseteq \mathbb{R}^n$, and continuous input set $U \subseteq \mathbb{R}^m$. Moreover, the vector field $f : X \times U \times \mathcal{V}_\zeta \rightarrow X$ is a polynomial function of the state x and of the input ν . Sets X and U are bounded semi-algebraic sets (i.e., they can be represented by the intersection of polynomial inequalities).*

Under Assumption 2, one can reformulate conditions (5.1)-(5.3) as an SOS optimization problem to search for a polynomial CBC \mathbb{B} and a polynomial controller $\nu(\cdot)$ for the dt-SCS Σ . The following lemma provides the SOS formulation.

Lemma 5.8. *Suppose Assumption 2 holds and sets X_0 , X_u , X can be defined as $X_0 = \{x \in \mathbb{R}^n \mid g_0(x) \geq 0\}$, $X_u = \{x \in \mathbb{R}^n \mid g_u(x) \geq 0\}$ and $X = \{x \in \mathbb{R}^n \mid g(x) \geq 0\}$, where g_0, g_u and g are vectors of polynomials and inequalities are intended element-wise. Suppose for a given dt-SCS Σ , there exists a sum-of-squares polynomial $\mathbb{B}(x)$, constants $\eta, \beta, \bar{c} \in \mathbb{R}_{\geq 0}$, with $\beta > \eta$, $0 < \bar{\kappa} < 1$, vectors of sum-of-squares polynomials $\lambda_0(x), \lambda_u(x), \lambda(x)$, and polynomials $\lambda_{\nu_j}(x)$ corresponding to the j^{th} input in $\nu = (\nu_1, \nu_2, \dots, \nu_m) \in U \subseteq \mathbb{R}^m$ of appropriate dimensions, such that the following expressions are sum-of-squares polynomials:*

$$\begin{aligned} & -\mathbb{B}(x) - \lambda_0^T(x)g_0(x) + \eta \\ & \mathbb{B}(x) - \lambda_u^T(x)g_u(x) - \beta \\ & -\mathbb{E}\left[\mathbb{B}(f(x, \nu, \zeta)) \mid x, \nu\right] + \bar{\kappa}\mathbb{B}(x) + \bar{c} - \sum_{j=1}^m (\nu_j - \lambda_{\nu_j}(x)) - \lambda^T(x)g(x). \end{aligned}$$

Then $\mathbb{B}(x)$ is a CBC satisfying conditions (5.1)-(5.3) and $\nu = [\lambda_{\nu_1}(x); \dots; \lambda_{\nu_m}(x)]$, is the corresponding controller of the dt-SCS Σ , where

$$\kappa = 1 - (1 - \pi)(1 - \bar{\kappa}), \quad c = \frac{\bar{c}}{\pi(1 - \bar{\kappa})},$$

with $0 < \pi < 1$.

For such computations, one can readily employ existing software tools available in the literature such as SOSTOOLS [PAV⁺13], together with a semidefinite programming (SDP) solver such as SeDuMi [Stu99].

5.1.2. *Counter-Example Guided Inductive Synthesis.* One can find a CBC with a given parametric form, *e.g.*, a polynomial, by utilizing satisfiability modulo theories (SMT) solvers such as Z3 [DMB08], dReal [GAC12] or MathSat [CGSS13]. The counter-example guided inductive synthesis (CEGIS, [SLTB⁺06]) scheme can compute CBC for finite input sets, and it does not require any restrictions on underlying dynamics beyond what required by the SMT solver of choice. One can employ the following lemma and reformulate conditions (5.1)-(5.3) as a satisfiability modulo theory problem, as follows.

Lemma 5.9. *Consider the dt-SCS Σ . Suppose there exists a function $\mathbb{B}(x)$, constants $\eta, \beta, c \in \mathbb{R}_{\geq 0}$, and $0 < \kappa < 1$ such that*

$$\bigwedge_{x \in X_0} (\mathbb{B}(x) \leq \eta) \bigwedge_{x \in X_u} (\mathbb{B}(x) \geq \beta) \bigwedge_{x \in X} \bigvee_{\nu \in U} \left(\mathbb{E} \left[\mathbb{B}(f(x, \nu, \varsigma)) \mid x, \nu \right] \leq \max \{ \kappa \mathbb{B}(x), c \} \right),$$

where the index sets of conjunctions and disjunctions are possibly infinite. Then $\mathbb{B}(x)$ is a CBC satisfying conditions (5.1)-(5.3).

Remark 5.10. *The computational complexity in the construction of finite MDPs as in Algorithm 1 grows exponentially with the dimension of the state set. In contrast, in the case of sum-of-squares optimization, the computational complexity depends on both the degree of the polynomials and the number of state variables. It is shown that for fixed degree of the polynomials, the required computation grows polynomially with the dimension [WTL15]. Hence, we expect this technique to be more scalable than discretization-based approaches to study specific problems, such as safety analysis, that can be tackled via barrier certificates. The CEGIS approach [JSZ20] has a bottleneck that resides with the SMT solver, and it is difficult to provide any analysis on the computational complexity due to its iterative nature and lack of completeness (termination) guarantees.*

5.1.3. *Related Work.* Within this line of work, the synthesis of invariants to study probabilistic safety of infinite-state models (probabilistic programs) is discussed in [CS13]. The proposed analysis employs concentration inequalities and martingales theory.

Finite-time safety verification of stochastic nonlinear systems using barrier certificates is proposed in [ST12]. The work considers the problem of bounding the probability of failure (defined as leaving a given bounded region of the state space) over a finite-time horizon for stochastic nonlinear systems with continuous state and in continuous time. The proposed approach searches for exponential barrier functions (*e.g.*, $\mathbb{B}(x, k) = e^{\frac{1}{2}x^T M(k)x} - 1$) that provide bounds using c -martingale type conditions as in (5.3), however in continuous time.

Probabilistic safety verification of systems using barrier certificates is proposed in [HCL⁺17]. The paper considers stochastic hybrid systems where the dynamics are represented as polynomial relations (equalities and inequalities) over the system variables and where random variables denote the initial discrete mode. The proposed approach guarantees the safety over an infinite-time horizon, using either statistical model checking or the computation of probabilistic reachable sets.

Control barrier certificates for a class of stochastic nonlinear systems against safety specifications (*i.e.*, all states are required to be constrained in a bounded compact set) are discussed in [LLT⁺18]. The proposed scheme provides probabilistic safety guarantees by reasoning over the stability properties of the model.

Temporal logic verification of stochastic systems via barrier certificates is proposed in [JSZ18]. The goal is to find a lower bound on the probability that a complex temporal logic property is satisfied by finite trajectories of the system (cf. (5.6)), in the spirit of (2.7). Considering properties expressed as safe LTL formulae, the proposed approach relies on decomposing the negation of the specification into a union of sequential reachabilities and then using barrier certificates to compute upper bounds for those reachability probabilities. The results of [JSZ18] are recently extended in [JSZ20] to provide a formal synthesis framework for stochastic systems. The extended work distinguishes uncountable and finite input sets in the computation of control barrier certificates, using respectively SOS optimization and the CEGIS approach.

A controller synthesis framework for stochastic control systems based on control barrier functions is also provided in [Cla19]. The paper considers both complete information systems, in which the controller has

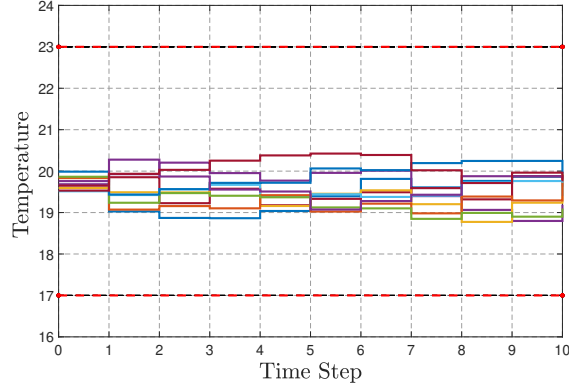

FIGURE 11. Closed-loop state trajectories with 10 different noise realizations for the finite-time horizon $T_d = 10$.

access to the full system information, as well as incomplete information systems where the state must be reconstructed from noisy measurements. In the complete information case, it formulates barrier functions that leads to sufficient conditions for safety with probability 1. However, in order to provide infinite-time horizon guarantees, this result requires that the control barrier functions exhibit supermartingale property, which presupposes stochastic stability and vanishing noise at the equilibrium point of the system. This approach is only applicable to systems with unbounded input sets and it does not provide any probabilistic guarantee 1 when the input set is bounded. In the incomplete information case, it formulates barrier functions that take an estimate from an extended Kalman filter as input, and derives bounds on the probability of safety as a function of the asymptotic error for the filter.

A methodology for safety verification of non-stochastic systems using barrier certificates is proposed in [PR05]. Using the concepts of convex duality and density functions, the paper presents a converse statement for barrier certificates, showing that the existence of a barrier certificate is also necessary for safety. The results are then extended in [WS15] to more general classes of dynamical systems: in particular, [WS15] proves converse barrier certificate theorems for a class of structurally stable dynamical systems.

Open Problem 5. *There is no guarantee in general for the existence of barrier certificates for SHS. In particular, Definition 5.1 provides a set of sufficient conditions for the existence of CBC: if there exists a barrier certificate, then the system is safe with the a lower bound on the safety probability determined by the CBC. One interesting direction as a future work is to investigate necessary and sufficient conditions for the existence of control barrier certificates for SHS.*

Open Problem 6. *Develop computational techniques to construct CBC for general, nonlinear dt-SCS (not only polynomial-type models).*

Running example (continued). The regions of interest in this example are considered as $X \in [1, 50]$, $X_0 \in [19.5, 20]$, $X_u = [1, 17] \cup [23, 50]$. The main goal is to find a CBC for the system, for which a safety controller is synthesized maintaining the temperature of the room in a comfort zone $[17, 23]$.

We employ software tool SOSTOOLS [PAV⁺13] and the SDP solver SeDuMi [Stu99] to compute CBC as described in Definition 5.1. We compute CBC of an order 2 as $\mathbb{B}(T) = 0.86043T^2 - 33.78116T + 331.57433$ and the corresponding safety controller as $\nu(T) = -0.0120155T + 0.9$. Furthermore, the corresponding parameters in Definition 5.1 satisfying conditions (5.1)-(5.3) are quantified as $\eta = 0.13$, $\beta = 4.4$, $\kappa = 0.99$, and $c = 99 \times 10^{-4}$.

By employing Theorem 5.3, one can guarantee that the temperature of the room starting from the initial set $X_0 = [19.5, 20]$ remains in the safe set $X_u = [17, 23]$ during the time horizon $T_d = 10$ with a probability at least 95%, *i.e.*,

$$\mathbb{P}\left\{x(k) \in X_u \text{ for some } k \in [0, T_d] \mid a\right\} \geq 0.95. \quad (5.8)$$

Closed-loop state trajectories with 10 noise realizations are illustrated in Figure 11. \square

6. TEMPORAL LOGIC VERIFICATION AND SYNTHESIS

In this section, we discuss how one can perform verification and synthesis for stochastic hybrid systems over interesting requirements, such as safety, reachability, or over more complex specifications encompassed by temporal logic or omega-regular languages. In presenting work at the interface between control theory and formal methods, we mainly focus on LTL and PCTL properties in this survey for the sake of better readability.

A quantitative, abstraction-based controller synthesis for SHS is proposed in [TMKA13], for specifications expressed over DFAs. The problem is first reformulated as an optimization of a probabilistic reachability property over a product process obtained from the model for the specification and the model of the system. The article develops a discretization procedure leading into standard dynamic programming problems over finite MDPs with history-independent Markov policies. Errors are in the form of Equation (2.4). A similar controller design scheme for stochastic hybrid systems is also provided in [KSL13]. As a generalization, an optimal control synthesis approach defined over general controlled discrete-time Markov processes is proposed in [TMKA17a] in which the probability of a given event is optimized: it is shown that the optimization over a wide class of LTL and ω -regular properties can be reduced to the solution of one of two fundamental problems: reachability and repeated reachability.

A policy refinement scheme for dt-SCS via approximate similarity relations based on δ -lifting is proposed in [HSA17] by providing a closeness guarantee similar to (2.3). In particular, given safety properties over the concrete system, the work constructs an epsilon-perturbed specification over the abstract model whose probability of satisfaction gives a lower bound for the probability of satisfaction in the concrete domain with some quantified error bounds in the form of (2.3). The work is then generalized in [HSA18] to a larger class of temporal properties ((bounded) probabilistic reachability problem and temporal logic control problem) and in [HS18] to synthesize policies for a robust satisfaction of specifications. This framework is applied in building automation systems [HCA17].

Policy refinement over co-safe linear temporal logic for stochastic control systems is proposed in [LSZ19b] in which it is discussed how synthesized policies for abstract systems can be refined back to original models while providing guarantees on the probability of satisfaction. All those works [HSA17, HSA18, HS18, LSZ19b] quantify a probabilistic distance between original systems and that of their epsilon-perturbed abstractions as a version of closeness guarantee proposed in (2.3). We should highlight that, given the DFA \mathcal{A} in Definition 1.10, the epsilon-perturbed specification in [HSA17, HSA18, HS18, LSZ19b] corresponds to a new DFA $\hat{\mathcal{A}}_\varphi = (\bar{Q}_\ell, q_0, \bar{\Sigma}_a, F_a, \bar{\tau})$ in which one absorbing location q_{abs} and one letter ϕ_\circ are added as $\bar{Q}_\ell := Q_\ell \cup \{q_{\text{abs}}\}$ and $\bar{\Sigma}_a := \Sigma_a \cup \{\phi_\circ\}$. The initial and accept locations are the same with \mathcal{A}_ϕ . The transition relation is defined, $\forall q \in \bar{Q}_\ell, \forall a \in \bar{\Sigma}_a$, as

$$\bar{\tau}(q, a) := \begin{cases} \mathbf{t}(q, a) & \text{if } q \in Q_\ell, a \in \Sigma_a, \\ q_{\text{abs}} & \text{if } a = \phi_\circ, q \in \bar{Q}_\ell, \\ q_{\text{abs}} & \text{if } q = q_{\text{abs}}, a \in \bar{\Sigma}_a. \end{cases}$$

In other words, an absorbing state q_{abs} is added and all states will jump to this absorbing state with label ϕ_\circ . As an example, the modified DFA of the reach-avoid specification in Figure 4 is plotted in Figure 12.

Temporal logic verification and control of stochastic systems via control barrier certificates against a fragment of linear temporal logic, *i.e.*, safe LTL, over finite traces are presented in [JSZ18, JSZ20].

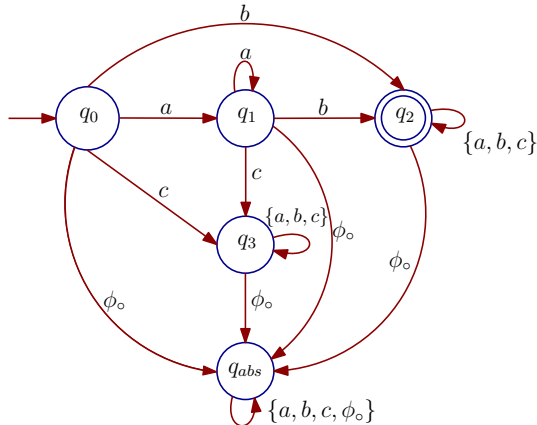
FIGURE 12. Modified DFA $\hat{\mathcal{A}}_\varphi$ of the specification (aUb) .

Forward stochastic reachability analysis for uncontrolled linear systems with affine (bounded or unbounded) disturbance is presented in [VHO17]. The proposed method utilizes Fourier transforms to efficiently compute the forward stochastic reach probability measure (density) and the forward stochastic reach set. Underpinned by the same technique, an under-approximation of the stochastic reach-avoid probability for high-dimensional linear stochastic systems is presented in [VO17] while providing guarantees of the type in equations (2.7) and (2.8). The proposed framework exploits fixed control sequences parameterized by the initial condition (an open-loop control policy) to generate the under-approximation. For Gaussian disturbances, the under-approximation can be obtained using existing efficient algorithms by solving a convex optimization problem. The work in [VO18] proposes a scalable algorithm to construct a polytopic under-approximation of the terminal hitting time stochastic reach-avoid set, for the verification of high-dimensional linear stochastic systems with arbitrary stochastic disturbance. The existence of a polytopic under-approximation is proved by characterizing sufficient conditions under which the stochastic reach-avoid set and the proposed open-loop under-approximation are compact and convex.

Under-approximation of finite-time horizon, stochastic reach-avoid sets for discrete-time stochastic nonlinear systems is discussed in [GVO17] via Lagrangian methods. The article utilizes the concept of target-tube reachability to define robust reach-avoid sets that are parameterized by the target set, safe set, and the set which the disturbance is drawn from. The proposed framework unifies two existing Lagrangian approaches to compute these sets, and establishes that there exists an optimal Markov control policy for the robust reach-avoid sets. The results characterize the subset of the disturbance space whose corresponding robust reach-avoid set for a given target and safe set is a guaranteed underapproximation of the stochastic reach-avoid level set of interest. Although the proposed method is conservative, it does not rely on a grid, implying scalability features that now hinge on geometrical computations.

A framework for analyzing probabilistic safety and reachability problems for discrete-time SHS, in scenarios where system dynamics are affected by competing agents, is proposed in [KDS⁺11]. The provided framework considers a zero-sum game formulation of the probabilistic reach-avoid problem, in which the control objective is to maximize the probability of reaching a desired subset of the hybrid state space, while avoiding an unsafe set, subject to the worst-case behavior of a rational adversary. The results are then extended in [DKS⁺13] to demonstrate how the proposed results can be specialized to address the safety problem, by computing the minimal probability that the system state reaches an unsafe subset of the state space.

[LA18] investigate multi-objective optimal control for dt-SHS with safety as a priority, by means of a *lexicographic* approach that prioritizes the safety as a constraint to be met prior to optimizing a given reward. The

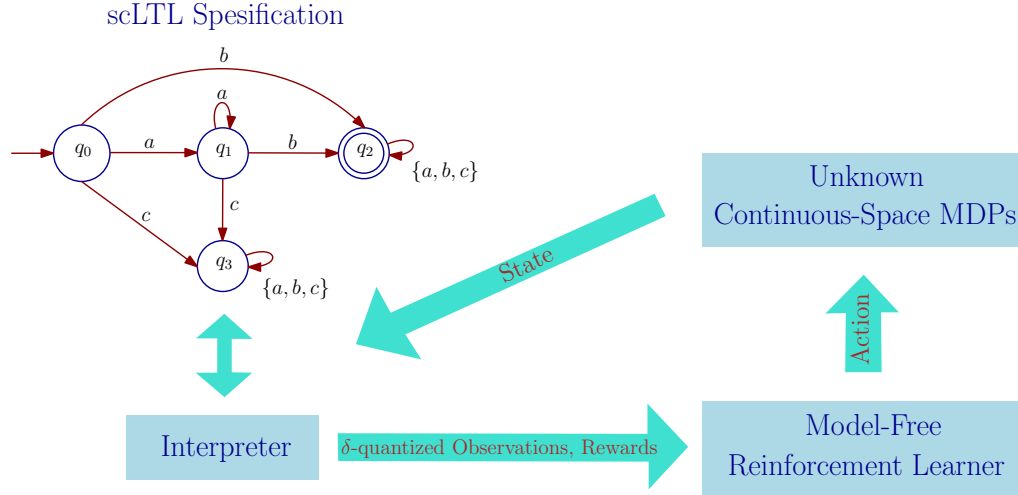

FIGURE 13. Model-free reinforcement learning is employed by a DFA corresponding to an SCLTL objective. In particular, the δ -quantized observation set of the dt-SCS Σ is used by an *interpreter* process to compute a run of the DFA. When the run reaches a final state, the interpreter gives the reinforcement learner a positive reward and the training episode terminates. Any converging reinforcement learning algorithm over such δ -quantized observation set is guaranteed to maximize the probability of satisfaction of the scLTL objective and converge to an optimal strategy over the unknown dt-SCS Σ .

paper in [HNS21] proposes an abstraction framework for computation of policies to satisfy multiple specifications with different priorities by encoding them in a multi-objective framework.

We discuss briefly the formal synthesis over SHS via learning and data-driven approaches in Subsection 11.1 as an open research direction. Here, to conclude this section, we only present a few limited recent works with a focus on temporal logic verification and synthesis via learning approaches. A reinforcement learning framework for controller synthesis of finite MDPs with unknown transition probabilities against LTL objectives with a proof of convergence is proposed in [HAK19a, HPS⁺19]. A key feature of the proposed techniques is the compilation of ω -regular properties into limit deterministic Büchi automata (LDBA), instead of the Rabin automata that are standard with MDPs. [HAK19a] exploits the structure of the LDBA and shapes a synchronous reward function on-the-fly, so that an RL algorithm can synthesize a policy resulting in traces that maximize the probability of satisfying the linear temporal property. If the dt-SCS is finite, theoretical guarantees are provided on the convergence of the RL algorithm to an optimal policy, maximizing the satisfaction probability. The setup is extended to *probabilistic labels* in [HKA⁺19]. [HPS⁺19] presents a constructive reduction from the satisfaction of LTL objectives to a reachability problem, and extends this technique to learning how to control an MDP with unknown transition probabilities so that the chance of satisfying the objective is maximized.

A model-free reinforcement learning scheme to synthesize policies for unknown continuous-space dt-SCS is proposed in [LSS⁺20]. The proposed approach is schematically illustrated in Figure 13: the properties of interest for the system belong to so-called syntactically co-safe linear temporal logic formulae, and the synthesis requirement is to maximize the probability of satisfaction within a given bounded time horizon. The work provides control strategies maximizing the probability of satisfaction over unknown continuous-space dt-SCS while providing probabilistic closeness guarantees in the form of (2.3). Similarly based on the scheme in

Figure 13, extensions to continuous spaces and ω -regular properties with formal guarantees are studied in [HAK19b, HKA20, KS20]. This line of works leads to the following problem.

Open Problem 7. *Provide convergence guarantee for learning-based approaches that compute a controller for dt-SCS to satisfy any given LTL specification.*

7. COMPOSITIONAL TECHNIQUES

It is of interest to extend the techniques introduced in previous sections to networks of interacting models, or to models with specially structured dynamics or coupling between variables. Moreover, the construction of (in)finite abstractions for large-scale stochastic hybrid systems in a monolithic manner suffers severely from the curse of dimensionality. To mitigate this issue, one promising solution is to consider a large-scale complex model as an interconnected system composed of several smaller subsystems. Compositional techniques are specifically suitable to tackle these problems, and are broadly studied in this section. We overview results on compositional frameworks for the construction of (in)finite abstractions for interconnected systems using abstractions of smaller subsystems.

We first define stochastic control *subsystems* next. The term “internal” is employed for inputs and outputs of subsystems that are affecting each other in the interconnection: an internal output of a subsystem affects an internal input of another subsystem downstream. The term “external” instead is utilized to denote (exogenous) inputs and outputs that are not employed for the construction of the interconnection.

Definition 7.1. *A discrete-time stochastic control subsystem (dt-SCSu) is described by the tuple*

$$\Sigma = (X, U, W, \varsigma, f, Y^1, Y^2, h^1, h^2), \quad (7.1)$$

where

- $X \subseteq \mathbb{R}^n$ is a Borel space as the state space of the subsystem;
- $U \subseteq \mathbb{R}^m$ is a Borel space as the external input space of the subsystem;
- $W \subseteq \mathbb{R}^p$ is a Borel space as the internal input space of the subsystem;
- ς is a sequence of i.i.d. random variables from a sample space Ω to the measurable space $(\mathcal{V}_\varsigma, \mathcal{F}_\varsigma)$;

$$\varsigma := \{\varsigma(k) : (\Omega, \mathcal{F}_\Omega) \rightarrow (\mathcal{V}_\varsigma, \mathcal{F}_\varsigma), k \in \mathbb{N}\};$$

- $f : X \times U \times W \times \mathcal{V}_\varsigma \rightarrow X$ is the transition map;
- $Y^1 \subseteq \mathbb{R}^{q^1}$ is a Borel space as the external output space of the subsystem;
- $Y^2 \subseteq \mathbb{R}^{q^2}$ is a Borel space as the internal output space of the subsystem;
- $h^1 : X \rightarrow Y^1$ is a measurable function as the external output map that takes a state $x \in X$ to its external output $y^1 = h^1(x)$;
- $h^2 : X \rightarrow Y^2$ is a measurable function as the internal output map that takes a state $x \in X$ to its internal output $y^2 = h^2(x)$.

Properties of the interconnected system are specified over external outputs, as in Definition 7.1, and the synthesis objective is to control external inputs in order to satisfy desired properties over external outputs; whereas internal signals are utilized for the sake of interconnections amongst subsystems. We are now well equipped to define an interconnected SCS.

Definition 7.2. *Consider $N \in \mathbb{N}_{\geq 1}$ stochastic control subsystems $\Sigma_i = (X_i, U_i, W_i, \varsigma_i, f_i, Y_i^1, Y_i^2, h_i^1, h_i^2)$, $\forall i \in \{1, \dots, N\}$, and a matrix M of appropriate dimensions, defining the coupling between these subsystems. The interconnection of Σ_i for any $i \in \{1, \dots, N\}$, is the SCS $\Sigma = (X, U, \varsigma, f, Y, h)$, denoted by $\mathcal{I}(\Sigma_1, \dots, \Sigma_N)$, such that $X := \prod_{i=1}^N X_i$, $U := \prod_{i=1}^N U_i$, $f := \prod_{i=1}^N f_i$, $Y := \prod_{i=1}^N Y_i^1$, and $h = \prod_{i=1}^N h_i^1$, subjected to the following interconnection constraint:*

$$[w_1; \dots; w_N] = M[h_1^2(x_1); \dots; h_N^2(x_N)].$$

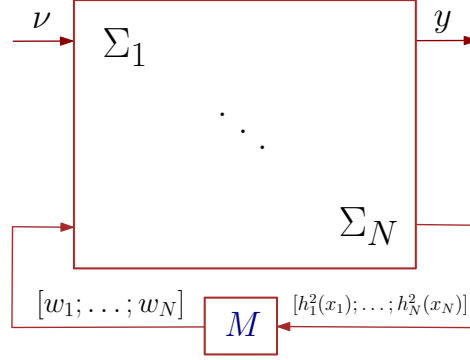

FIGURE 14. An interconnected SCS with external input and output signals ν and y , respectively. Note that in the small-gain setting the interconnection matrix M is a permutation matrix that results in an element-wise interconnection constraint (i.e., $\forall i, j \in \{1, \dots, N\}, i \neq j: w_{ij} = y_{ji}^2, y_{ji}^2 \subseteq W_{ij}$).

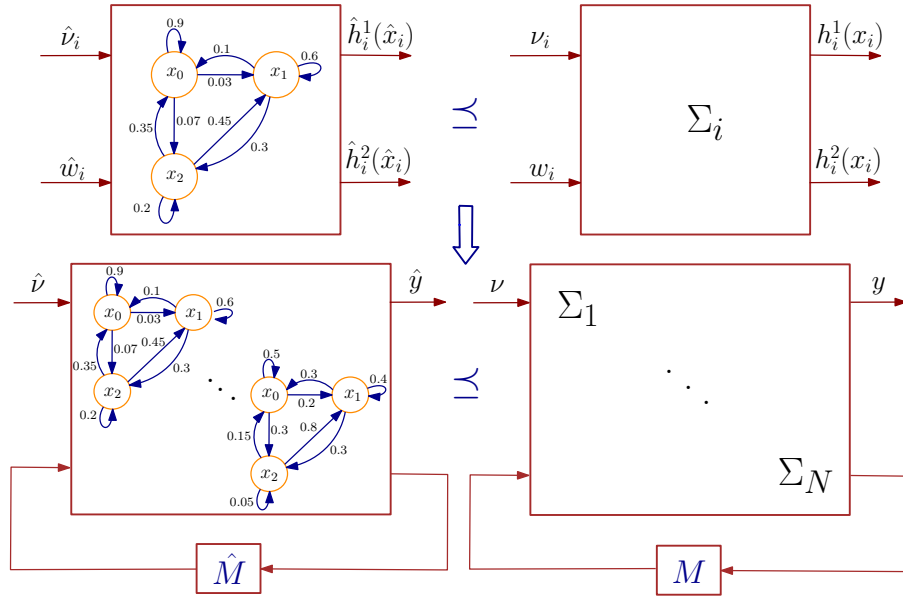

FIGURE 15. Representation of compositionality results under external input and output signals ν and y , respectively. We denote $\hat{\Sigma} \preceq \Sigma$ if there exists an SSF V from $\hat{\Sigma}$ to Σ (cf. Definition 1.6).

An interconnected SCS based on Definition 7.2 is schematically depicted in Figure 14.

In this section, we discuss two different compositional approaches based on small-gain and dissipativity conditions. Small-gain and dissipativity techniques have been traditionally employed in the context of stability analysis for networks of interconnected systems [DRW10, AMP16]. Suppose Σ is an interconnected SCS with N stable subsystems $\Sigma_1, \dots, \Sigma_N$. Under some small-gain or dissipativity conditions, one can ensure that the composed network $\Sigma = \mathcal{I}(\Sigma_1, \dots, \Sigma_N)$ is also stable. A similar idea can be utilized here in the setting of similarity relations, using which one can establish a formal relation between an interconnected system Σ and

its abstraction $\widehat{\Sigma}$, based on relations between subsystems and their corresponding abstractions. We present the semantics of compositionality techniques in the following.

Semantics of compositionality techniques. Consider the interconnected SCS $\Sigma = \mathcal{I}(\Sigma_1, \dots, \Sigma_N)$, and assume proper relations between subsystems Σ_i and their corresponding abstractions $\widehat{\Sigma}_i$ in the sense of Definition 1.6. Under some compositionality conditions, one can construct an overall relation between the two interconnected systems $\widehat{\Sigma} = \mathcal{I}(\widehat{\Sigma}_1, \dots, \widehat{\Sigma}_N)$ and Σ , based on the relations between the subsystems and their abstractions.

Compositionality conditions based on dissipativity approaches are in the form of LMI that can be readily checked via semidefinite programming (SDP) solvers such as SeDuMi [Stu99]. For small-gain reasoning, we distinguish the corresponding compositionality conditions based on so-called sum-type and max-type small-gain approaches. In particular, in sum-type small-gain approach, the second condition of the stochastic simulation function (SSF) is in the form of (1.7), and the overall SSF is a weighted sum of SSF of subsystems. Accordingly, one deals with a spectral radius of some matrix that needs to be strictly less than one as the compositionality condition. In contrast, in max-type small-gain approach, the upper bound in (1.7) is in the max form and the overall SSF is based on maximum of SSF of subsystems. We refer the interested readers for more details on the compositionality conditions in (sum and max-type) small-gain and dissipativity approaches respectively to [LSMZ17, LSZ20d] and [LSZ19b]. It will be further discussed in this section that the closeness guarantees are of the type in (2.6).

Compositionality results have been schematically depicted in Figure 15. As illustrated, if there exists a local stochastic simulation function between each original subsystem and its corresponding finite MDP, one can construct an overall stochastic simulation function between the original interconnected system and its interconnected finite abstraction provided that some compositionality conditions are satisfied.

Remark 7.3. *Note that the proposed compositionality results based on sum-type small-gain approaches [LSMZ17] require linear growth on gains of subsystems (cf. [LSMZ17, Assumption 1]) and provide an additive overall error (i.e., the error of the interconnected abstraction is linear combination of errors of abstractions of subsystems). In contrast, the max-type small-gain approaches [LSZ20d] are more general, since they do not require any linearity assumption on gains of subsystems and the overall error is the maximum error of abstractions of subsystems. Both errors provide closeness guarantees of the type in (2.6). On the other hand, checking the compositional condition in the sum-type small-gain is much easier than the max-type one, since it is based on the spectral radius of some matrix that can be easily checked.*

Compositionality techniques based on infinite and finite abstractions have been schematically illustrated in Figure 16.

Compositional construction of finite abstractions for stochastic control systems is presented in [SAM15, SAM17]. Those works investigate the finite-horizon probabilistic invariance for dt-SCS and provide a closeness guarantee between two systems in the form of (2.3). The compositionality framework is based on finite *dynamic Bayesian networks (DBNs)* and the works exploit the structure of the underlying Markov process to compute the abstraction separately for each dimension and discuss how factor graphs and the sum-product algorithm for DBNs can be utilized to solve the finite-horizon probabilistic invariance problem.

Compositional construction of *infinite* abstractions for interconnected SCS is proposed in [LSMZ17] via *sum-type small-gain* conditions. The abstraction framework is based on notions of SSF in Definition 1.6, using which one can quantify the probabilistic distance between original interconnected stochastic control systems and their abstractions based on the closeness type in (2.6). A compositional scheme for constructing *infinite* abstractions based on dissipativity approaches is presented in [LSZ19b]. The proposed scheme employs the interconnection matrix and joint dissipativity-type properties of subsystems and their abstractions described by a notion of stochastic storage functions [LSZ19b, Definition 3.1].

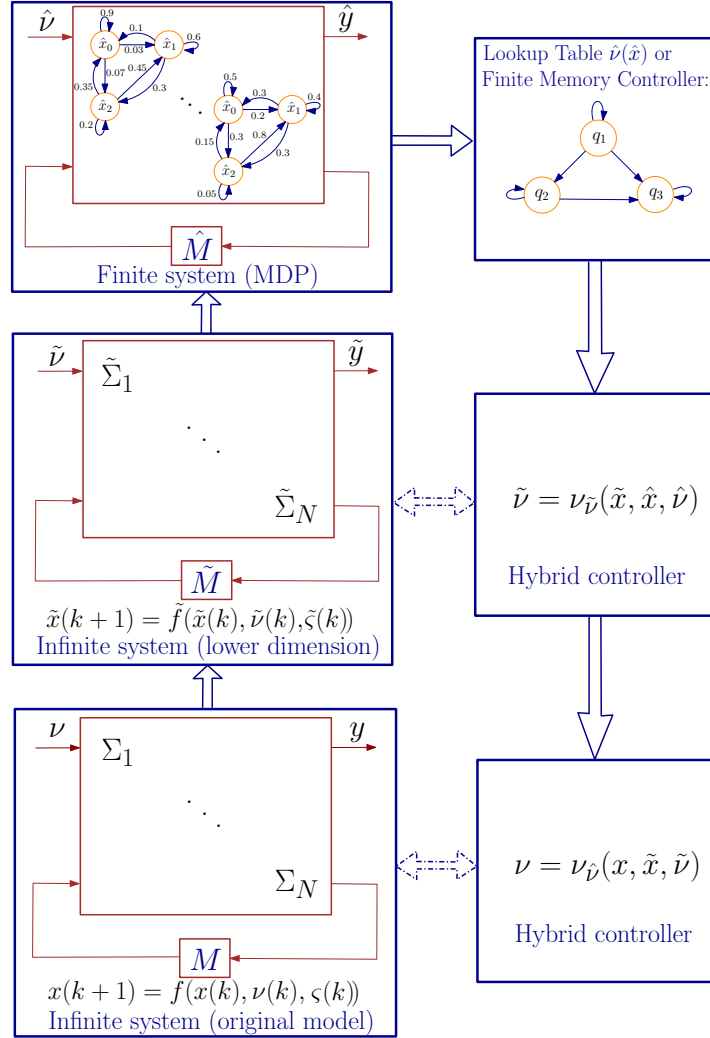

FIGURE 16. Compositional techniques based on abstractions.

Compositional construction of both infinite and finite abstractions via max-type small-gain conditions is discussed in [LSZ18a, LSZ20d]. The proposed overall error is computed based on maximum errors of subsystems. The articles in [LSZ18a, LSZ20d] employ a variant of notions of SSF in Definition 1.6) and provide the probabilistic distance between the interconnection of stochastic control subsystems and that of their (in)finite abstractions based on (2.6). The proposed framework also leverages the δ -ISS property of original systems as in Definition 1.5 and provides an approach to construct finite MDPs of the concrete models (or their reduced-order versions).

Compositional construction of finite abstractions for stochastic control systems is also presented in [LSZ18b] but using dissipativity conditions. This work provides a closeness in the form of (2.6) and proposes an approach to construct finite MDPs for the general setting of discrete-time nonlinear SCS satisfying a passivity-like property, whereby one can construct finite MDPs by selecting a suitable discretization of the input and state sets. Moreover, for linear SCS, the aforementioned property boils down to a matrix inequality.

Compositional construction of finite MDPs for networks of not necessarily stabilizable stochastic systems is presented in [LSZ19c] and [LSZ20c] respectively via *relaxed* max small-gain and dissipativity approaches. The proposed framework relies on a relation between each subsystem and its finite abstraction employing a new notion of simulation functions, called *finite-step* stochastic simulation functions [LSZ19c, Definition 3.5]. In comparison with the existing notions of simulation functions in which stability or stabilizability of each subsystem is required, a *finite-step* stochastic simulation function needs to decay only after some finite numbers of steps instead of at each time step. This relaxation results in a *less conservative* version of small-gain or dissipativity conditions.

Compositional construction of finite abstractions for networks of stochastic *switched* systems is presented in [LSZ20a, LZ20] via respectively small-gain and dissipativity approaches. These contributions utilize notions of stochastic simulation (or storage) functions and provide a closeness guarantee in the form of (2.6), however adapted to switched models.

Compositional abstraction-based synthesis of dt-SCS using approximate probabilistic relations is proposed in [LSZ19a, LSZ20b]. The abstraction framework is based on the notion of δ -lifted relations, using which one can quantify the distance in probability between the interconnected dt-SCS and that of their abstractions as a version of closeness guarantee proposed in (2.3). Those results provide some matrix (in)equality conditions for simultaneous existence of relations incorporating the structure of the network. It is shown that the unified compositional scheme is less conservative than the two-step consecutive procedure that independently constructs infinite and finite abstractions (*e.g.*, [LSZ18b, LSZ19b]). Compositional construction of infinite and finite abstractions for large-scale *discrete-time* stochastic systems via different compositionality conditions is widely discussed in [Lav19].

Open Problem 8. *Developing a compositional multi-objective synthesis framework for continuous-space SHS is an interesting open problem. Note that there have been some partial results on this problem for discrete-space models [KNPQ13] and for continuous-space monolithic models [HNS21], which however are respectively not applicable or in general computationally tractable for (large-scale) SHS.*

Although the proposed compositional frameworks for constructing finite abstractions can mitigate the state-space explosion problem, the curse of dimensionality may still arise at the level of single subsystems. As discussed in Section 5, an alternative direction is to employ *control barrier functions* as a discretization-free technique for controller synthesis of complex stochastic systems. However, searching for control barrier certificates for large-scale systems can be also computationally expensive. Consequently, developing compositional techniques for constructing control barrier functions is a promising solution to alleviate this complexity. Compositional construction of control barrier certificates for large-scale stochastic control systems is presented in [ALZ20, ALZ21]. The proposed compositional methodology is based on a notion of *control sub-barrier certificates*, enabling one to construct control barrier certificates of interconnected systems by leveraging some max-type small-gain conditions. Compositional construction of control barrier certificates for discrete-time stochastic switched systems accepting multiple barrier certificates with some dwell-time conditions is instead proposed in [NSZ20a].

Running example (continued). We present the dynamics of (1.4) based on a network of two rooms, as illustrated in Figure 17. The evolution of the temperatures T_i can be described by (1.4) in which A is a matrix with diagonal elements $\bar{a}_{ii} = (1 - 2\sigma - \theta - \gamma\nu_i(k))$, $i \in \{1, 2\}$, and off-diagonal elements $a_{1,2} = a_{2,1} = \sigma$. Parameter $\sigma = 0.1$ is the conduction factor between the rooms. Furthermore, $T(k) = [T_1(k); T_2(k)]$, $\nu(k) = [\nu_1(k); \nu_2(k)]$, $\varsigma(k) = [\varsigma_1(k); \varsigma_2(k)]$, $T_E = [T_{e_1}; T_{e_2}]$, and $R = 0.3\mathbb{I}_2$. By considering the individual rooms Σ_i as

$$\Sigma_i: \begin{cases} T_i(k+1) = \bar{a}_{ii}T_i(k) + \gamma T_h \nu_i(k) + D_i w_i(k) + \theta T_{e_i} + 0.3\varsigma_i(k), \\ y_i(k) = T_i(k), \end{cases} \quad (7.2)$$

one can readily verify that $\Sigma = \mathcal{I}(\Sigma_1, \Sigma_2)$ where $D_i = \sigma$, and $w_i(k) = y_{i-1}^2(k)$ for any $i \in \{1, 2\}$ (with $y_0^2 = y_2^2$). One can also establish a quadratic stochastic simulation function between Σ_i and $\widehat{\Sigma}_i$ in the form

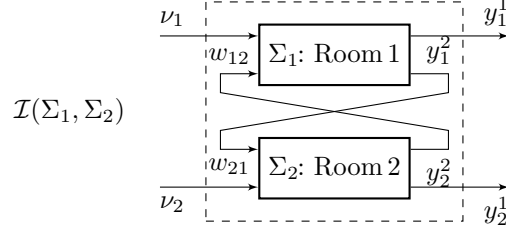
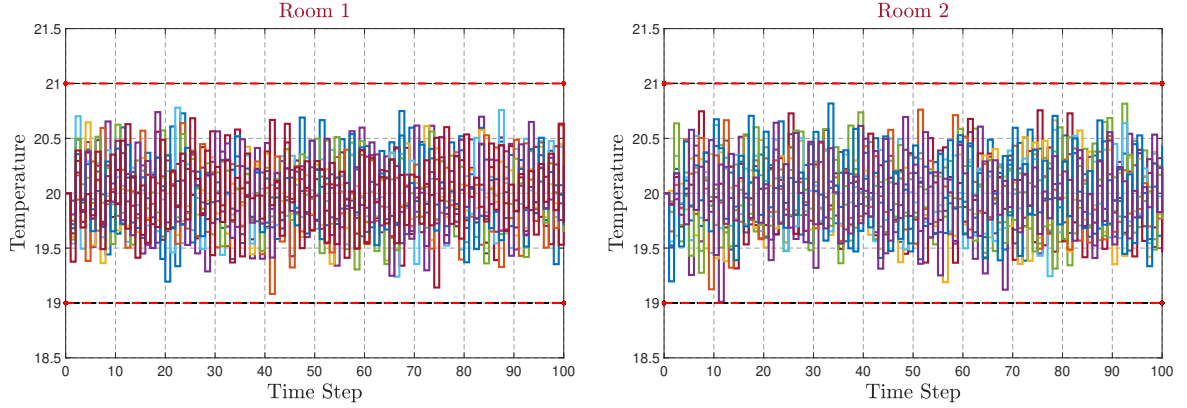
 FIGURE 17. Interconnection of two rooms Σ_1 and Σ_2 .

 FIGURE 18. Closed-loop state trajectories of Room 1 (top) and Room 2 (bottom) with 10 different noise realizations for the finite-time horizon $T_d = 100$.

of $S_i(T_i, \hat{T}_i) = (T_i - \hat{T}_i)^2$ satisfying [LSZ20d, conditions (III.1), (III.2)] with $\alpha_i(s) = s^2$, $\kappa_i(s) = 0.99s$, $\rho_{\text{inti}}(s) = 0.97s^2$, $\rho_{\text{exti}}(s) = 0$, $\forall s \in \mathbb{R}_{\geq 0}$, and $\psi_i = 6.06 \delta_i^2$, for any $i \in \{1, 2\}$.

Now we need to check the small-gain condition for the interconnected system (1.4). The small-gain condition [LSZ20d, equation (V.2)] is readily satisfied if

$$\kappa_{12} \cdot \kappa_{21} < 1, \quad (7.3)$$

where κ_{ij} for any $i, j \in \{1, 2\}, i \neq j$, is defined as $\kappa_{ij}(s) = \rho_{\text{inti}}(\alpha_j^{-1}(s))$. Since $\kappa_{12} = \kappa_{21} = 0.97$, the small-gain condition (7.3) is simply satisfied. Hence, $V(T, \hat{T}) = \max_i (T_i - \hat{T}_i)^2$ for any $i \in \{1, 2\}$ is a stochastic simulation function from the interconnected system $\hat{\Sigma}$ to Σ .³

By taking the *state* discretization parameter $\delta = 0.005$, the initial states of the interconnected systems Σ and $\hat{\Sigma}$ as $20\mathbf{1}_2$, and using [LSZ20d, inequality (III.3)], one can guarantee that the distance between outputs of Σ and $\hat{\Sigma}$ will not exceed $\varepsilon = 0.5$ during the time horizon $T_d = 100$ with a probability at least 98%, in the form of (2.6), *i.e.*,

$$\mathbb{P}\left\{\|y(k) - \hat{y}(k)\| \leq 0.5, \forall k \in [0, 100]\right\} \geq 0.98. \quad (7.4)$$

Let us now synthesize a controller for Σ via its finite abstraction $\hat{\Sigma}$ such that the controller maintains the temperature of any room in a comfort zone defined as the interval $[19, 21]$. We design a local controller for the abstract subsystem $\hat{\Sigma}_i$, and then refine it back to the subsystem Σ_i using an *interface* map. Consequently, the overall controller for the interconnected system Σ would be a vector such that each of its components is the

³We should highlight that condition (7.3) is exactly similar to what proposed in [Zam66] in the context of stability verification of feedback interconnection of two linear systems.

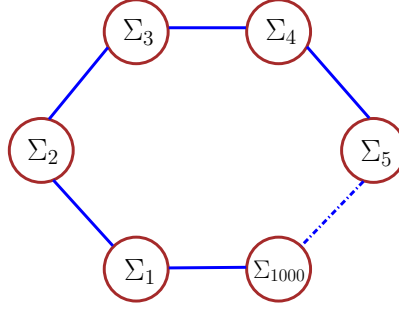

FIGURE 19. A circular interconnection for a network of 1000 rooms.

controller for subsystems Σ_i . We employ the software tool AMYTISS [LKSZ20] to synthesize controllers for Σ_i . Closed-loop state trajectories of two rooms with 10 different noise realizations are illustrated in Figure 18. The simulations show that none of 10 trajectories violates the specification, which is in accordance with the theoretical guarantee (7.4). As discussed in Section 4, if one employs our designed controllers and run Monte Carlo simulations of the closed-loop model, the distance between outputs of Σ and $\widehat{\Sigma}$ will likely be empirically closer than 0.5 with the same probability as in (7.4). This is as expected, in view of the conservative nature of formal guarantees provided using Lyapunov-like techniques (simulation functions).

We now increase the number of rooms to $n = 1000$ and interconnect them in a circular fashion, as depicted Figure 19). In this case, A in (1.4) is a matrix with diagonal elements $\bar{a}_{ii} = (1 - 2\sigma - \theta - \gamma\nu_i(k))$, $i \in \{1, \dots, n\}$, off-diagonal elements $\bar{a}_{i,i+1} = \bar{a}_{i+1,i} = \bar{a}_{1,n} = \bar{a}_{n,1} = \sigma$, $i \in \{1, \dots, n-1\}$, and all other elements are identically zero. Moreover, σ is a conduction factor between pairs of room $i \pm 1$ and i , $T(k) = [T_1(k); \dots; T_n(k)]$, $\nu(k) = [\nu_1(k); \dots; \nu_n(k)]$, $\varsigma(k) = [\varsigma_1(k); \dots; \varsigma_n(k)]$, $T_E = [T_{e1}; \dots; T_{en}]$, $R = 0.3\mathbb{I}_n$. Considering the individual rooms Σ_i as (7.2), one can readily verify that $\Sigma = \mathcal{I}(\Sigma_1, \dots, \Sigma_N)$ where $D_i = [\sigma; \sigma]^T$, and $w_i(k) = [y_{i-1}^2(k); y_{i+1}^2(k)]$ (with $y_0^2 = y_n^2$ and $y_{n+1}^2 = y_1^2$).

We set the state discretization parameter $\delta = 0.005$, and initial states of the interconnected systems Σ and $\widehat{\Sigma}$ as $20\mathbf{1}_{1000}$. Using the proposed bound in [LSZ20d, inequality (III.3)], one can guarantee that the distance between outputs of Σ and $\widehat{\Sigma}$ will not exceed $\varepsilon = 0.5$ during the time horizon $T_d = 100$ with the probability at least 98%, *i.e.*,

$$\mathbb{P}\left\{\|y(k) - \hat{y}(k)\| \leq 0.5, \forall k \in [0, 100]\right\} \geq 0.98. \quad (7.5)$$

We employ AMYTISS [LKSZ20] and synthesize a controller for Σ via the abstraction $\widehat{\Sigma}$ such that the controller maintains the temperature of any room in the comfort zone [19, 21]. Closed-loop state trajectories of a representative room with 10 different noise realizations are illustrated in Figure 20 for a finite-time horizon $T_d = 100$. \square

8. CONTINUOUS-TIME STOCHASTIC HYBRID SYSTEMS

Foundations of continuous-time SHS can be traced back to the work on piecewise-deterministic Markov models in [Dav93], which was extended to diffusion processes in [HLS00]. An early survey of work can be found in [PBLB03]. In this survey, we present selected results for the continuous-time setting, categorized according to the different topics discussed in the previous sections.

Notations. We assume that for continuous-time processes, the triple $(\Omega, \mathcal{F}_\Omega, \mathbb{P}_\Omega)$ denotes a probability space endowed with a filtration $\mathbb{F} = (\mathcal{F}_s)_{s \geq 0}$ satisfying the standard conditions of completeness and right-continuity. Let $(\mathbb{W}_s)_{s \geq 0}$ be a \mathbf{b} -dimensional \mathbb{F} -Brownian motion, and $(\mathbb{P}_s)_{s \geq 0}$ be an \mathbf{r} -dimensional \mathbb{F} -Poisson process. We

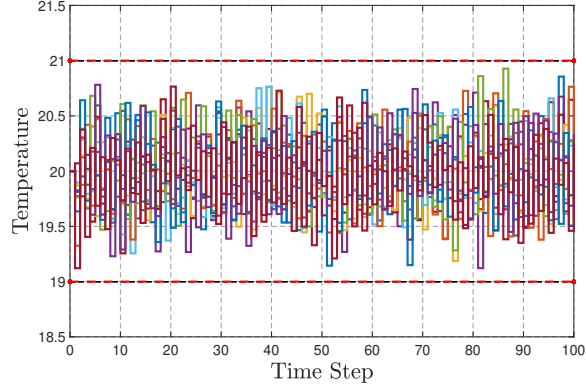

FIGURE 20. Closed-loop state trajectories of a representative room with 10 different noise realizations, for the network of 1000 rooms.

assume that the Poisson process and the Brownian motion are independent of each other. The Poisson process $\mathbb{P}_s = [\mathbb{P}_s^1; \dots; \mathbb{P}_s^r]$ models r events whose occurrences are assumed to be independent of each other.

There is a notion of SSF also for continuous-time stochastic systems (cf. [ZRME17, Definition 3.2]) that is similar to that in Definition 1.6. The only difference is that in the left-hand side of (1.7), instead of the shown one-step expectation, there is a condition on the stochastic process that acts on a twice differentiable function V . This notion was initially developed in [JP09].

Stochastic Similarity Relations. In the next theorem, we present a result on the closeness in *expectation (moment)* of the difference between output trajectories of original continuous-time systems Σ and their corresponding abstractions $\hat{\Sigma}$, as proposed in [ZMEM⁺14].

Theorem 8.1. *Let Σ be a continuous-time SCS and $\hat{\Sigma}$ be its abstraction. Suppose there exists a stochastic simulation function $V : X \times \hat{X} \rightarrow \mathbb{R}_{\geq 0}$ from $\hat{\Sigma}$ to Σ similar to Definition 1.6 but for continuous-time stochastic systems. For any input trajectory $\hat{\nu}(\cdot) \in \hat{\mathcal{U}}$ that preserves the Markov property for the closed-loop $\hat{\Sigma}$, and for any random variables a and \hat{a} as the initial states of Σ and $\hat{\Sigma}$, respectively, one can construct an input trajectory $\nu(\cdot) \in \mathcal{U}$ for Σ through an interface function associated with V (cf. Def. 1.6), such that:*

$$\mathbb{E} \left[\|y_{a\nu}(t) - \hat{y}_{\hat{a}\hat{\nu}}(t)\|^{\bar{q}} \right] \leq \lambda_4, \quad \forall t \in \mathbb{R}_{>0}, \quad (8.1)$$

where,

$$\lambda_4 := \beta(\mathbb{E}[V(a, \hat{a})], t) + \rho_{\text{ext}}(\mathbb{E}[\|\hat{\nu}\|_{\infty}^{\bar{q}}]) + c,$$

with $\beta \in \mathcal{KL}$, $\rho_{\text{ext}} \in \mathcal{K}_{\infty}$, $c \in \mathbb{R}_{>0}$, and $\bar{q} \in \mathbb{N}_{\geq 1}$ denoting the moment of a random variable.

Remark 8.2. *Note that one can leverage the bound in (8.1) together with the Markov inequality [Oks13] to provide a lower bound on the probability of satisfaction of logic specifications for which satisfiability is only concerned at single time instances (e.g., reachability). The new bound is similar to (2.6), but the supremum appears outside of the probability operator [ZMEM⁺14]. Note that this is not the case for logic specifications such as always (operator \square) or even until (\mathcal{U}). Then, one can conclude that the bound in (8.1) implies (2.6) and accordingly (2.3) and (2.7).*

The characterization and computation of probabilistic bisimulations of diffusion processes is discussed in [Aba09]. This work proposes sufficient conditions for the existence of a bisimulation function based on the use of contractivity analysis and supermartingale inequalities for probabilistic systems. It is shown that the notion of

stochastic contractivity is related to a probabilistic version of the concept of incremental stability. This relationship leads to a procedure that constructs a discrete approximation of a diffusion process. The results are then extended in [Aba10] to probabilistic bisimulations between two diffusion processes that are additionally endowed with switching and resetting behaviors.

Infinite abstractions. The construction of infinite abstractions for a class of continuous-time SHS is initially proposed in [JP09]. The approximation framework is based on stochastic simulation functions and the work provides a closeness guarantee in the form of (8.1) but for infinite-time horizons (*i.e.*, $0 \leq k < \infty$). For the class of jump linear stochastic systems and linear stochastic hybrid automata, the article shows that the computation of stochastic simulation functions can be cast as a linear matrix inequality (LMI) problem.

Finite abstractions. Construction of symbolic models (*i.e.*, finite abstractions) for incrementally stable stochastic switched systems is proposed in [ZAG15]. The underlying switched systems have a probabilistic evolution over a continuous domain and control-dependent discrete dynamics over a finite set of modes. The paper constructively derives approximately equivalent (bisimilar) symbolic models of stochastic switched systems. The article provides two different symbolic abstraction techniques: one requires state space discretization, but the other one does not require any space discretization which can be potentially more efficient than the first one especially when dealing with higher dimensional stochastic switched systems. Both techniques provide finite symbolic models that are approximately bisimilar to stochastic switched systems under some stability assumptions on the concrete models.

Construction of symbolic models for *randomly switched* stochastic system is studied in [ZA14a]. The proposed framework is based on approximate bisimilar relations and leverages some incremental stability assumption over randomly switched stochastic systems to establish the relation between original systems and their corresponding finite symbolic models. Construction of finite bisimilar abstractions for incrementally stable stochastic control systems without discrete dynamics is presented in [ZMEM⁺14]. The work shows that every stochastic control system satisfying a probabilistic variant of incremental input-to-state stability, and for every given precision $\varepsilon > 0$, a finite-state transition system can be constructed, which is ε -approximately bisimilar to the original stochastic control system. It also provides a closeness bound between the δ -ISS stochastic control system and its bisimilar finite abstraction based on the one proposed in (8.1).

Abstraction-based synthesis of continuous-time stochastic control systems is also discussed in [NSZ19]. The proposed framework leverages stochastic simulation functions to relate continuous-time stochastic systems with their discrete-time (in)finite counterparts. In order to propose the construction procedure for finite abstractions, the paper first introduces infinite abstractions as time-discretized versions of ct-SCS (as a middle step) since the finite abstractions are constructed from the infinite discrete-time counterparts. The work quantifies the distance in probability between original continuous-time stochastic control systems and their discrete-time (finite or infinite) abstractions at sampling times in the form of (2.6). It also constructs finite abstractions together with their corresponding stochastic simulation functions for a particular class of stochastic affine systems having some stability property. It should be mentioned that the original models in [ZAG15, ZA14a] are stochastic, and whereas the constructed abstractions are finite, non-stochastic labeled transition systems, the finite abstractions in [NSZ19] are finite MDPs.

Control barrier certificates. Discretization-free approaches based on barrier certificates for safety verification of continuous-time stochastic hybrid systems are initially proposed in [PJP07]. The article leverages the supermartingale property and quantifies an upper bound on the probability that a trajectory of the system ever reaches a given unsafe set (over an infinite time horizon) as proposed in (5.7). For polynomial-type systems, barrier certificates can be constructed using convex optimization, which is deemed computationally tractable.

Verification and control for finite-time safety of stochastic systems via barrier functions are discussed in [SDC19]. The proposed certificate condition includes a state-dependent bound on the infinitesimal generator, allowing

for tighter probability bounds. Moreover, for stochastic systems where the drift dynamics are affine in the control input, the paper proposes a method for synthesizing a polynomial state-feedback controller that achieves a specified safety probability.

A verification approach for stochastic switched systems with random switching signals via barrier functions is presented in [AJZ19]. The temporal properties required on the system are expressed as safe-LTL specifications over finite traces. The proposed approach combines automata-based verification and the use of barrier certificates. It relies on decomposing the automaton associated with the negation of the specification into a sequence of simpler reachability tasks and computes upper bounds for these reachability probabilities by means of *common* or *multiple* barrier certificates.

Control barrier functions for stochastic systems under (Gaussian) process and measurement noise have been proposed in [Cla20]. The article first considers the case where the system state is known at each time step, and presents a construction that guarantees almost surely safety. It then extends the approach to models with incomplete state information, where the state must be estimated: it is shown that the proposed certificates ensure safety with probability 1 when the state estimate is within a given bound of the true state, which can be achieved using an Extended Kalman Filter when the system is linear or the process and measurement noises are sufficiently small.

Synthesis for stochastic systems with partial state information via control barrier functions is discussed in [JJZ20b]. Given an estimator with a probabilistic guarantee on its accuracy, the paper proposes an approach to compute a controller providing a lower bound on the probability that the trajectories of the stochastic control system remain safe over a finite time horizon (similar to (5.6)). This work does not require a supermartingale property on the control barrier functions, and in particular it does not require any stability assumption on the model. The results of this article are recently generalized in [JJZ20a] in which no a-priori knowledge about the estimation accuracy is needed. Besides, the class of properties is extended to those expressed by nondeterministic finite automata (NFA), and the dynamics are also generalized to partially-observed jump-diffusion systems.

Compositional techniques. Compositional construction of infinite abstractions (in particular, reduced-order models) for a class of SHS is proposed in [ZRME17] using sum-type small-gain conditions. The class of systems includes both jump linear stochastic systems and linear stochastic hybrid automata. The work employs stochastic simulation functions to quantify an error between the interconnection of stochastic hybrid subsystems and that of their approximations, in the form of (8.1) (but in the continuous-time setting). It also focuses on a specific class of SHS, namely jump linear stochastic systems, and proposes a constructive scheme to determine approximations together with their corresponding stochastic simulation functions.

Compositional construction of finite abstractions for stochastic control systems is presented in [MSSM17]. The proposed framework is based on a notion of (approximate) disturbance bisimulation relation, which results in a closeness guarantee with the form of (8.1) (but in the continuous-time setting). Given any SCS satisfying a stochastic version of a δ -ISS property and a positive error bound, the article shows how to construct a finite-state transition system (whenever existing) that is disturbance-bisimilar to the given stochastic control system.

The results of [NSZ19] are extended in [NSZ21] to provide a compositional framework for the construction of finite MDPs for networks of continuous-time stochastic systems via max small-gain conditions. The class of systems is also extended to a class of continuous-time SHS by adding Poisson processes to the dynamics, and the construction framework of finite MDPs is generalized for a particular class of *nonlinear* SHS. Compositional construction of finite MDPs for continuous-time stochastic systems is recently presented in [NZ20] but using a different compositionality approach based on dissipativity conditions.

Compositional construction of infinite abstractions for networks of stochastic hybrid systems under randomly switched topologies are proposed in [AZ18]. The proposed framework leverages the interconnection topology, switching randomly between \mathcal{P} different interconnection topologies (it is modelled by a Markov chain), and the joint dissipativity-type properties of subsystems and their abstractions. The abstraction itself is a stochastic

hybrid system (possibly with a lower dimension) and can be used as a substitute of the original system in the controller design process. The work provides a closeness guarantee based on k moments similar to (8.1) but in the continuous-time setting.

Compositional construction of infinite abstractions of interconnected stochastic hybrid systems via dissipativity theory is discussed in [AZ19]. The proposed results leverage a notion of stochastic simulation function in which the supply rate has its own dynamics. The stochastic noises and jumps in the concrete subsystem and its abstraction do not need to be the same. For a class of nonlinear stochastic hybrid subsystems with an incremental quadratic inequality on the nonlinearity, a set of matrix (in)equalities is established to facilitate the construction of their abstractions together with the corresponding stochastic storage functions. The article quantifies a formal error between the output behaviors of the original system and the ones of its infinite abstractions in the form of (8.1).

Compositional construction of control barrier functions for networks of continuous-time stochastic systems is presented in [NSZ20c]. The proposed scheme is based on notions of *pseudo-barrier functions* (similar to Definition 5.1 but computed over subsystems), using which one can synthesize state-feedback controllers for interconnected systems enforcing safety specifications over a finite time horizon. This work leverages sum-type small-gain conditions to compositionally construct control barrier functions for interconnected systems based on the corresponding pseudo-barrier functions computed for subsystems. Then, using the constructed control barrier functions, it quantifies upper bounds on the probability that an interconnected system reaches certain *unsafe* regions in a finite time horizon, similar to Theorem 5.3 but in the continuous-time setting. The work also employs a systematic technique based on the SOS optimization program to search for pseudo-barrier functions of subsystems, while synthesizing safe controllers. Those results are extended to SHS [NSZ20b] and the class of specifications is also generalized to those that can be expressed as languages accepted by a DFA. Besides, the provided results in [NSZ20c] are only applicable to systems with polynomial dynamics and continuous controllers, while [NSZ20b] employs an additional approach to compute control pseudo-barrier functions for finite input sets using the CEGIS framework, which does not require any assumptions on the underlying dynamics and relies on SMT solvers.

Temporal logic verification and synthesis. Early work on SHS is in [GLQ06] and [KR06], which focused on probabilistic reachability analysis.

A probabilistic approach for control of continuous-time linear stochastic systems subject to LTL formulae over a set of linear predicates in the state of the system is presented in [LAB09]. The article defines a polyhedral partition of the state space and a finite collection of controllers, represented as symbols, and constructs a finite MDP. By utilizing an algorithm resembling LTL model checking, it determines a run satisfying the formula in a corresponding Kripke structure. A sequence of control actions in the MDP is determined to maximize the probability of following the run.

Measurability and safety verification of a class of SHS are discussed in [FHH⁺11] in which the continuous-time behaviour is given by differential equations, but discrete jumps are chosen by probability distributions. In this work, non-determinism is also supported, and it is exploited in an abstraction and evaluation method that establishes safe upper bounds on reachability probabilities.

Reachability analysis for continuous-time stochastic hybrid systems with no resets is proposed in [LAB⁺17] in which continuous dynamics described by linear stochastic differential equations. For this class of models, the article studies reachability (and dually, safety) properties on an abstraction defined in terms of a discrete-time and finite-space Markov chain, with provable error bounds. The paper provides a characterization of the uniform convergence of the time discretization of stochastic processes with respect to safety properties, and this allows to provide a complete and sound numerical procedure for reachability and safety computation over the stochastic systems.

Stochastic reachability analysis of hybrid systems is also studied in [Buj12]. This line of work continues to these days [WBS20] and is summarized in [BL03].

A new approach for the automated synthesis of safe and robust proportional-integral-derivative (PID) controllers for SHS is proposed in [SPB⁺17]. The work considers hybrid systems with nonlinear dynamics (Lipschitz continuous ordinary differential equations) and random parameters, and synthesizes PID controllers such that the resulting closed-loop systems satisfy safety and performance constraints given as probabilistic bounded-reachability properties. The proposed technique leverages satisfiability modulo theories (SMT) solvers over reals and nonlinear differential equations to provide formal guarantees that the synthesized controllers satisfy such properties. These controllers are also robust by design since they minimize the probability of reaching an unsafe set in the presence of random disturbances.

Automated synthesis of digital controllers with formal safety guarantees for systems with nonlinear dynamics, noisy output measurements, and stochastic disturbances is recently presented in [SSP⁺19]. The proposed method derives digital controllers such that the corresponding closed-loop system, modeled as a sampled-data stochastic control system, satisfies a safety specification with probability above a given threshold. If the probability so obtained is not above the threshold, the approach expands the search space for candidates by increasing the controller degree.

A theoretical and computational synthesis framework for safety properties of continuous-time continuous-space switched diffusions is proposed in [LLA⁺20]. The work provides an appropriate discrete abstraction in the form of an uncertain Markov model that captures all possible behaviors of the system. This is achieved through a discretization of both time and space domains, each introducing an error such that the errors are formally characterized and represented as uncertain transition probabilities in the abstraction model. It also provides a robust strategy that optimizes a safety property over the abstraction. This strategy is computed by considering only the feasible transition probability distributions, preventing the explosion of the error term and resulting in achievable bounds for the safety probability. This robust strategy is mapped to a switching strategy for the system of switched diffusions with the guarantee that safety probability bounds also hold for this system in the form of (2.7).

An optimal control problem for continuous-time stochastic systems subject to objectives specified in a fragment of metric interval temporal logic specifications, a temporal logic with real-time constraints, is presented in [FT15]. The work proposes a numerical method for computing an optimal policy with which the given specification is satisfied with maximal probability in the discrete approximation of the underlying stochastic system. It is shown that the policy obtained in the discrete approximation converges to the optimal one for satisfying the specification in the continuous or dense-time semantics, as the discretization becomes finer in both state and time.

Motion planning for continuous-time stochastic processes via dynamic programming is discussed in [MECL15]. The work studies stochastic motion planning problems which involve a controlled process, with possibly discontinuous sample paths, visiting certain subsets of the state-space while avoiding others in a sequential fashion. A weak dynamic programming principle (DPP) is proposed that characterizes the set of initial states which admit a control enabling the process to execute the desired maneuver with probability no less than some pre-specified value. The proposed DPP comprises auxiliary value functions defined in terms of discontinuous payoff functions.

Stability and Optimal control. In this survey we do not delve into the broad issues of stability analysis and optimal control synthesis for SHS, which have been widely investigated over the past two decades. For stability, we point the reader to the survey in [TSS14], whereas for optimal control we refer the interested reader to the books [BLE⁺06, CL06] (which covers seminal work [Dav93, ABFG⁺93]) and to the work of [PC16]. It is worth mentioning that formal verification and synthesis have a tight connection to *optimal control* by expressing logic specifications as a part of constraints in the optimization problem [LA18, HNS21].

9. SHS SIMULATION AND STATISTICAL MODEL CHECKING

In this section, we study simulation-based analysis of stochastic hybrid systems, and also encompass work on statistical model checking (SMC). Early work, grounded on a sequential Monte Carlo simulations and the use of Petri Nets, is proposed in [BKB⁺07], and employed in collision risk estimation of free flight operations. The proposed results show are applicable to rare-event estimation over complex models. Safety risk analysis of an air traffic management operation over a SHS is similarly discussed in [BSB13]. [BEOB14] puts forward techniques for efficient Monte Carlo simulation of stochastic hybrid systems.

So far, we have widely discussed formal verification and synthesis of SHS in which a closeness guarantee between original SHS and their abstractions is formally provided in four different forms, as elaborated in Definition 1.1. For simulation-based analysis instead, new guarantees are provided. Suppose $(\hat{x}_i)_{i=1}^{\bar{N}}$ are \bar{N} i.i.d. sampled data from a set Ω . Simulation-based guarantees are presented in two-layer probabilities [CC06], as follows:

$$\mathbb{P}\left\{(\hat{x}_i)_{i=1}^{\bar{N}} \in \Omega: \mathbb{P}\{\bar{y}_{av} \neq \varphi\} \leq \bar{\varepsilon}\right\} \geq \bar{\beta}, \quad (9.1)$$

where φ is the property of interest, \bar{y}_{av} is any given random trajectory, and $\bar{\varepsilon}, \bar{\beta} \in [0, 1]$ are respectively a threshold and confidence level. As a comparison with the studied approaches in the previous sections, the formal guarantee there comes with only one layer probability similar to (5.4). If one pushes the confidence $\bar{\beta}$ to zero, the chance constrained problem (9.1) can be understood to be similar to (5.4).

A statistical model checking (SMC) algorithm to verify stochastic properties with unbounded until is presented in [SVA05]. The algorithm is based on Monte Carlo simulation of the model and hypothesis testing of the samples, as opposed to sequential hypothesis testing. Statistical model checking for synthesizing policies on stochastic models including finite MDPs is presented in [HMZ⁺12]. The proposed framework develops an algorithm that resolves nondeterminism probabilistically, and then uses multiple rounds of sampling and reinforcement learning to provably improve resolutions of nondeterminism with respect to satisfying a bounded linear temporal logic (BLTL) property. The proposed algorithm thus reduces an MDP to a fully probabilistic Markov chain on which SMC may be applied to give an approximate estimation of the probability of the BLTL property.

A numerically rigorous Monte Carlo approach for computing probabilistic reachability in hybrid systems subject to random and nondeterministic parameters is proposed in [SZ16]. Instead of standard simulation, the work employs δ -complete SMT procedures, which enables formal reasoning for nonlinear systems up to a user-definable numeric precision. Monte Carlo approaches for probability estimation assume that sampling is possible for the real system at hand, however when using δ -complete simulations, one instead samples from an over-approximation of the random quantities at hand. The article introduces a Monte Carlo-SMT approach for computing probabilistic reachability confidence intervals that are both statistically and numerically rigorous. A survey on statistical model checking is provided in [AP18], which covers SMC algorithms, techniques, and tools, while emphasizing limitations and tradeoffs between precision and scalability.

A multilevel Monte Carlo method for statistical model checking of continuous-time stochastic hybrid systems is proposed in [SMN17]. The provided approach relies on a sequence of discrete-time stochastic processes whose executions approximate and converge weakly to that of the original continuous-time SHS with respect to the satisfaction of a property of interest. With focus on bounded-horizon reachability, the paper casts the model checking problem as the computation of the distribution of an exit time, which is in turn formulated as the expectation of an indicator function. This latter computation involves estimating discontinuous functionals, which reduces the bound on the convergence rate of the Monte Carlo algorithm. The work then proposes a smoothing step with tuneable precision and formally quantifies the error in the mean-square sense, which is composed of smoothing error, bias, and variance.

A statistical simulator for hybrid Petri nets with general transitions, called HYPEG, is presented in [PER17], which combines discrete and continuous components with a possibly large number of random variables, whose stochastic behavior follows arbitrary probability distributions. HYPEG employs time-bounded discrete-event

simulation and well-known statistical model checking techniques to verify complex properties, including time-bounded reachability.

In conclusion, statistical model checking approaches appear to be suitable for verification goals, whereas they appear to be less efficient when synthesis is in order. The latter objective could be considered as an open problem for future research. In addition, most of the proposed SMC results are suitable for *finite-time* horizons. More precisely, in the setting of SMC approaches in *infinite-time* horizons, the proposed results require some strong assumptions that are not in general satisfiable by SHS. More emphasis on infinite-horizon properties via SMC can be cast as another future research direction.

10. SOFTWARE TOOLS

In this section, we discuss software tools for verification and synthesis, as well as simulation, of stochastic hybrid systems.

10.1. Modest Toolset. Modest Toolset [HH14b] performs modelling and analysis for hybrid, real-time, distributed and stochastic systems. At its core are models of networks of stochastic hybrid automata (SHA), which combine nondeterministic choices, continuous system dynamics, stochastic decisions and timing, and real-time behaviour, including nondeterministic delays. The Modest Toolset is a modular framework, supporting as input the high-level Modest modelling language and providing a variety of analysis backends for various special cases of SHA. Many existing automata-based formalisms are special cases of SHA.

10.2. SReach. SReach [WZK⁺15] solves probabilistic, bounded-time reachability problems for two classes of models: (i) nonlinear hybrid automata with parametric uncertainty, and (ii) probabilistic hybrid automata with additional randomness on both transition probabilities and variable resets. Standard approaches to reachability analysis for linear hybrid systems require numerical solutions of large optimization problems, which become practically infeasible for systems involving both nonlinear dynamics and stochasticity. SReach instead encodes stochasticity by using a set of random variables, and combines δ -complete decision procedures and statistical tests to solve δ -reachability problems. Compared to standard simulation-based methods, SReach supports non-deterministic branching and allows one to increase the coverage of performed simulations.

10.3. ProbReach. ProbReach [SZ15] studies bounded-time reachability and other quantitative properties in stochastic hybrid systems. It handles SHS with random continuous initial parameters, which encompass model parameters or initial conditions that are chosen within the initial state and remain unchanged throughout the system evolution. For continuous dynamics, ProbReach can analyze any Lipschitz-continuous differential equations with stochastic parameters. Given an SHS with random continuous parameters and an arbitrarily small $\epsilon > 0$, ProbReach returns an interval of size not larger than ϵ containing the exact bounded-reachability probability. This result is guaranteed to be numerically sound, *e.g.*, free from floating-point inaccuracies. The introduction of discrete random parameters to the system will not affect the guarantees provided by ProbReach, however if the model features only discrete random parameters, then these guarantees do not hold: this happens because probability distributions over discrete random parameters are not continuous, and hence, an arbitrary precision cannot be provided. Introducing nondeterministic continuous parameters affects the guarantees the tool provides, as well: this happens because nondeterministic parameters do not have any probability measure. In this case, ProbReach computes an enclosure that is guaranteed to contain all the possible reachability probabilities. In general, such an enclosure may have size larger than $\epsilon > 0$. ProbReach employs a validated integration procedure to obtain a partition over the random parameters in such a way that the guarantees described above hold. This partition is then used to enclose the probability value by computing under- and over-approximations.

10.4. **SReachTools**. SReachTools [VGO19] is an open-source MATLAB toolbox for performing stochastic reachability of linear, potentially time-varying, discrete-time systems that are perturbed by a stochastic disturbance. More precisely, this tool addresses the problem of stochastic reachability of a target tube, which also encompasses terminal-time (hitting) problems, reach-avoid problems, and viability problems. The stochastic reachability of a target tube problem maximizes the likelihood that the state of a stochastic system will remain within a collection of time-varying target sets for a given time horizon, while respecting system dynamics and within a bounded control domain. SReachTools implements several algorithms based on convex optimization, computational geometry, and Fourier transforms, to efficiently compute over- and under-approximations of the stochastic reach set. SReachTools can be employed to perform probabilistic verification of closed-loop systems, and can also perform controller synthesis via open-loop, affine, and state-feedback controllers.

TABLE 1. Comparison between features of FAUST², StocHy, and AMYTISS.

Aspect	FAUST ²	StocHy	AMYTISS
Impl. Lang.	MATLAB	C++	C++/OpenCL
License	GNU	GNU	MIT
Platform	CPU	CPU	All platforms (<i>e.g.</i> , CPU, GPU, HWA)
Algorithms	Serial on HPC	Serial on HPC	Parallel on HPC
Model	SCSs: nonlinear	SCS: linear, bilinear	SCSs: nonlinear
Specification	Safety, reachability	Safety, reachability	Safety, reachability, reach-avoid
Stochasticity	Additive noise	Additive noise	Additive & multiplicative noises
Distribution	Normal, user-defined	Normal, user-defined	Normal, uniform, exponential, beta, user-defined
Non-deterministic disturbance	Not supported	Supported	Supported

10.5. **Mascot-SDS**. Mascot-SDS [MMS20] (the suffix SDS stands for “Stochastic Dynamical Systems”) is an open-source tool for synthesizing controllers with formal correctness guarantees for discrete-time dynamical systems in the presence of stochastic perturbations. Mascot-SDS is written in C++, and is an extension of Mascot [HMMS18]. The tool supports *infinite-horizon* control specifications for stochastic dynamical systems and computes over- and under-approximations of the set of states that satisfy the specification with probability one. The current version of the tool is developed for “always eventually” specifications, namely for specifications dealing with infinitely often requirements. However an upcoming new version will handle all omega-regular specifications including Linear Temporal Logic properties.

10.6. **FAUST²**. FAUST² [SGA15] generates formal abstractions for continuous-space discrete-time Markov processes defined over uncountable (continuous) state spaces, and performs verification and synthesis for safety and reachability specifications. The abstract model is formally put in a relationship with the concrete model via a user-defined maximum threshold on the approximation error introduced by the abstraction procedure. FAUST² allows exporting the abstract model to well-known probabilistic model checkers, such as PRISM [KNP02] or Storm [DJKV17]. Alternatively, it can handle internally the computation of PCTL properties (*e.g.*, safety or reachability) over the abstract model. It also allows refining the outcomes of the verification procedures over the concrete model in view of the quantified and tuneable error, which depends on the concrete dynamics and on the given formula.

10.7. **StocHy**. StocHy [CDA19] performs quantitative stochastic analysis of discrete-time stochastic hybrid systems. The tool allows to (i) simulate the SHS evolution over a given time horizon; and to automatically construct finite abstractions of the SHS. Abstractions are then employed for (ii) formal verification or (iii) control synthesis satisfying safety and reachability specifications. The tool is implemented in C++ and employs manipulations based on vector calculus, using sparse matrices, the symbolic construction of probabilistic kernels, and multi-threading. StocHy allows for modular modelling, and has separate simulation, verification

and synthesis engines which are implemented as independent libraries. This allows for libraries to be readily used and for extensions to be easily built.

10.8. AMYTISS. AMYTISS [LKSZ20] is developed in C++/OpenCL for designing correct-by-construction controllers of large-scale discrete-time stochastic systems. AMYTISS natively supports both additive and multiplicative noises with different practical distributions including normal, uniform, exponential, and beta. This software tool provides scalable parallel algorithms that allow to (i) construct finite MDPs from discrete-time stochastic control systems, and (ii) synthesize controllers satisfying complex logic properties including safety, reachability, and reach-avoid specifications. AMYTISS employs high-performance computing platforms and cloud-computing services to alleviate the effects of the state-explosion problem. This tool improves performances over computation time and memory usage by parallel execution over different heterogeneous computing platforms including CPUs, GPUs and hardware accelerators (*e.g.*, FPGA). AMYTISS significantly reduces the memory usage by setting a cutting probability threshold $\gamma \in [0, 1]$ to control how many partition elements around the mean of the system should be stored. Such an approximation allows controlling the sparsity of the columns of \hat{T}_x . AMYTISS also proposes another technique that further reduces the required memory for computing \hat{T}_x as *on-the-fly abstractions* (OFA). In OFA, computing and storing the probability transition matrix \hat{T}_x are skipped. Instead the required entries of \hat{T}_x on-the-fly are computed as they are needed for the synthesis part via the standard dynamic programming. This reduces the required memory for \hat{T}_x but at the cost of repeated computation of their entries in each time step from 1 to a finite-time horizon T_d .

10.9. Tool Comparison. In this subsection, we provide a comparison of AMYTISS, FAUST² and StocHy, since they all perform similar verification tasks. AMYTISS differs from FAUST² and StocHy in two directions. First, AMYTISS implements novel parallel algorithms and data structures targeting high-performance computing (HPC) platforms to reduce the undesirable effects of the state-explosion problem. Accordingly, it is able to perform parallel execution in different heterogeneous computing platforms including CPUs, GPUs and HWAs. Whereas, FAUST² and StocHy can only run serially on one CPU. Additionally, AMYTISS can handle the abstraction construction and controller synthesis for two and a half player games, whereas FAUST² and StocHy only handle one and a half player games (*e.g.*, disturbance-free systems). AMYTISS offers distributed execution of parallel algorithms utilizing all available processing elements (PEs) in any heterogeneous computing platform. To the best of the authors' knowledge, AMYTISS is the only tool of its kind for continuous-space stochastic systems that is able to utilize all types of compute units (CUs), simultaneously. AMYTISS also provides a script that converts the constructed finite MDPs into PRISM-input-files. In particular, AMYTISS can natively construct finite MDPs from continuous-space stochastic control systems. PRISM can then be employed to perform the controller synthesis for those classes of complex specifications that AMYTISS does not support.

A comparison between AMYTISS, FAUST² and StocHy is provided in Table 1 in detail in terms of different technical aspects. There have been some efforts in FAUST² and StocHy for parallel implementations: specifically, FAUST² employs some parallelization techniques using parallel for-loops and sparse matrices inside Matlab, and StocHy uses Armadillo, a multi-threaded library for scientific computing. However, these tools are not designed for the parallel computation on HPC platforms. Consequently, they can only utilize CPUs and cannot run on GPUs or HWAs. In comparison, AMYTISS is developed in OpenCL, a language specially designed for data-parallel tasks, and supports heterogeneous computing platforms combining CPUs, GPUs and HWAs. Note that FAUST² and StocHy do not natively support reach-avoid specifications. Implementing this type of properties requires some modifications inside those tools.

Outcomes of benchmarking competitions on tools for formal verification and policy synthesis of stochastic models are provided in [ABC⁺18, ABC⁺19, ABC⁺20]. These competitions aim at providing a unified point of reference on the current state of the art in the area of stochastic models, together with the currently available tools and frameworks for performing formal verification and optimal policy synthesis. They further provide a set of benchmarks aiming to push forward the development of current and future tools.

11. DIRECTIONS FOR OPEN RESEARCH

In this subsection, we summarize and further discuss a few open topics that can be taken up as future research initiatives.

11.1. Formal Analysis of SHS via Learning and Data-Driven Approaches. We discuss a few limited works on formal synthesis of SHS via learning and data-driven approaches, which is still considered as an open direction. A deterministic policy gradient algorithm for reinforcement learning with continuous actions is presented in [S⁺14]. The framework introduces an off-policy actor-critic algorithm that learns a deterministic target policy from an exploratory behaviour policy. It shows that the deterministic policy gradient can be estimated much more efficiently than the usual stochastic policy gradient especially in high-dimensional action spaces. However, the results do not provide any quantitative guarantee on the optimality of synthesized policies for original MDPs.

A model-free reinforcement learning framework of ω -regular objectives for Markov decision processes is proposed in [HAK19a, HPS⁺19]. The ω -regular properties are compiled into limit-deterministic Büchi automata (LDBA) instead of the traditional Rabin automata; this choice sidesteps difficulties that have marred previous proposals. [HAK19a] exploits the structure of the LDBA and shapes a synchronous reward function on-the-fly, so that an RL algorithm can synthesize a policy resulting in traces that maximize the probability of satisfying the linear temporal property. [HPS⁺19] presents a constructive reduction from the almost-sure satisfaction of ω -regular objectives to an almost-sure reachability problem, and extends this technique to learning how to control an unknown model so that the chance of satisfying the objective is maximized. The approach in [BWZP20] proposes a reward scheme associated to the given specification that requires two discounting factors in the reinforcement learning algorithm and provides a condition on these discounting to guarantee convergence of the learned policy to the optimal policy. These three approaches can be applied with off-the-shelf reinforcement learning algorithms to compute optimal strategies from the sample paths of the MDP. Extensions to continuous-space (and -actions) models are investigated in [LSS⁺20, KS20] and in [HAK19b, HKA20], as surveyed in Section 6.

A data-driven verification approach under signal temporal logic constraints is proposed in [SSZ20], based on a framework introduced in [HHA17] for deterministic models and LTL properties. As the dynamics are parameterized and partially unknown, the framework collects data from the system and employs Bayesian inference techniques to associate a confidence value to the satisfaction of the property. The results combine both data-driven and model-based techniques in order to have a two-layer probabilistic reasoning over the behavior of the system: one layer is related to the stochastic noise inside the system and the next layer is related to the noisy data collected from the system. Approximate algorithms are also provided for computing the confidence for linear dynamical systems.

A data-driven technique for satisfying temporal properties on unknown stochastic processes with continuous spaces is recently presented in [KS20]. The proposed framework is based on reinforcement learning that is used to compute sub-optimal policies that are finite-memory and deterministic. The work addresses properties expressed by LTL and uses their automaton representation to give a path-dependent reward function maximized via the RL algorithm. It also develops theoretical foundations characterizing the convergence of the learned policy to the optimal policy in the continuous space. To improve the performance of the learning on the constructed sparse reward function, the paper proposes a learning procedure based on a sequence of labelling functions obtained from the positive normal form of the LTL specification. This procedure is utilized to guide the RL algorithm towards the optimal policy. It is shown that the proposed approach can provide guaranteed lower bounds for the optimal satisfaction probability.

11.2. Formal Synthesis of Partially-Observed SHS. With a few mentioned exceptions, most of the surveyed work on automated verification and synthesis of SHS assumes complete state information. However, in many real applications we do not have access to full information. There have been a limited work on formal synthesis of partially-observed SHS. An early formulation is put forward in [DAT13], which characterizes the

safety problem measure-theoretically and develops an application in air traffic management. Reachability analysis of partially observable discrete-time SHS is proposed in [LO14]. The proposed framework includes a change of measure that simplifies the distribution of the sufficient statistic conditioned on its previous value. A dynamic programming recursion is also developed for the solution of the equivalent perfect information problem, proving that the recursion is valid, an optimal solution exists, and results in the same solution as to the original problem.

A finite-state approximation for safety verification and control of partially observable SHS is presented in [LO15b, LO16]. The papers solve a dynamic program over the finite state approximation to generate a lower bound to the viability probability, using a point-based method that generates samples of the information state. The proposed approach produces approximate probabilistic viable sets and synthesizes a controller to satisfy safety specifications. It also provides error bounds and convergence results, assuming additive Gaussian noise in the continuous-state dynamics and observations. Computing probabilistic viable sets for partially observable systems using truncated Gaussians and adaptive gridding is presented in [LO15a].

A perception-aware point-based value iteration for POMDPs is presented in [GT19]. The approach avoids combinatorial expansion over the action space from the integration of planning and perception decisions, through a greedy strategy for observation selection that minimizes an information-theoretic measure of the state uncertainty. The article develops a point-based value iteration algorithm that incorporates this greedy strategy to pick perception actions for each sampled belief point in each iteration. A sequential decision making process using POMDPs is studied in [WABT19]. The work aims to find strategies that actively interact with the dynamical system, and observe its reactions so that the true model is determined efficiently and with high confidence.

Verification of uncertain POMDPs using barrier certificates is discussed in [ACJT18]. A class of POMDPs is considered with uncertain transition and/or observation probabilities in which the uncertainty takes the form of probability intervals. Given an uncertain POMDP representation of the autonomous agent, the main goal is to propose a method for checking whether the system will satisfy an optimal performance, while not violating a safety requirement. A policy synthesis in multi-agent POMDPs via discrete-time barrier functions to enforce safety is proposed in [ASBA19]. The method is implemented online by a sequence of one-step greedy algorithms as a standalone safe controller or as a safety-filter given a nominal planning policy.

Synthesis of stochastic systems with partial state information via control barrier functions is proposed in [JJZ20b, JJZ20a], as surveyed in Section 8.

Open Problem 9. *Formal synthesis of POMDPs (even with finite set of states) is a hard problem and the available methods are not scalable. Developing compositional techniques for POMDPs to make the synthesis problem more scalable is a potential future research direction. Generalizing the available work on games [DKS⁺13] is an additional desideratum.*

11.3. Secure-by-Construction Controller Synthesis. Security vulnerabilities related to information leaks in complex systems, such as SHS, can be difficult to discover and mitigate, as the interaction between the embedded control software and the physical environment exposes numerous attack surfaces for malicious exploitation. An important class of security properties is called *opacity*: opacity is a confidentiality property in security analysis, which characterizes whether or not some “secret” information about the system (*e.g.*, a defender) can be inferred by outside observers with potentially malicious intentions (*e.g.*, intruders or attackers). There has been recent work with the goal to synthesize controllers that not only satisfy complex LTL specifications, but also fulfill some security properties. In this respect, probabilistic opacity for Markov decision processes is proposed in [BCS15], where non-deterministic choices are combined with probabilistic transitions, and where related decidability problems with partial or complete observation hypotheses for the schedulers are studied. The article proves that all questions are decidable with complete observations and ω -regular secrets. On the other hand, with partial observations, it is shown that all quantitative questions

are undecidable. However, the question whether a system is almost surely non-opaque becomes decidable for a restricted class of ω -regular secrets, as well as for all ω -regular secrets under finite-memory schedulers.

Notions of infinite-step and K -step opacity for stochastic discrete-event systems are presented in [YLWL17, YLWL19]. These works propose a new notion of opacity, called almost infinite-step opacity (respectively, almost K -step opacity), to capture whether or not the probability of violating infinite-step opacity (respectively, K -step opacity) is smaller than a given threshold. They also provide an effective algorithm for the verification of almost infinite-step and K -step opacity.

A notion of approximate initial-state opacity for discrete-time stochastic control systems is discussed in [LYZ20]. The work first proposes a notion of approximate initial-state opacity for stochastic control systems in order to quantitatively evaluate the security guarantee. It then introduces a notion of opacity-preserving stochastic simulation functions to quantify the distance between two systems in a probabilistic setting based on (2.6), while preserving approximate initial-state opacity across them.

Open Problem 10. *The results in [LYZ20] are the few dealing with opacity verification of continuous-space stochastic control systems. However, to the best of our knowledge, there is still no procedure on secure-by-construction controller synthesis of SHS by considering privacy properties in addition to temporal logic ones in the design phase: this stands as an interesting open research direction.*

11.4. (Mix)-monotonicity of SHS. As discussed in Subsection 4.3, the construction of IMC/IMDP can be more complex than standard abstractions based on MC/MDP, since one needs to compute lower and upper bounds for the probabilities of transition between states, rather than computing just a single number as in standard MCs/MDPs. As an alternative, under some assumptions (*e.g.*, additive stochasticity, unimodal noise distribution, independent noises affecting different states), contributions in [DC18, DC19, DHC20] utilize the mix-monotonicity property of the deterministic part of the map f and propose an approach to compute those lower and upper bounds in an efficient way. Here, we suggest an appropriate definition of mix-monotonicity in the stochastic setting that can be useful in constructing IMDPs.

Definition 11.1. *A stochastic system Σ with $\nu \equiv 0$ (i.e., an autonomous model) is called mix-monotone if there exist functions $g_1 : X \times X \rightarrow X$ and $g_2 : X \times X \rightarrow X$ such that:*

$$x(k) \in [a_1, b_1] \implies z_1 \leq \mathbb{P}\{x(k+1) \in [a_2, b_2] \mid x(k)\} \leq z_2,$$

where,

$$\begin{aligned} z_1 &= \mathbb{P}\{x(k+1) \in [a_2, b_2] \mid x(k) = g_1(a_1, b_1)\}, \\ z_2 &= \mathbb{P}\{x(k+1) \in [a_2, b_2] \mid x(k) = g_2(a_1, b_1)\}. \end{aligned}$$

If the mix-monotonicity property in Definition 11.1 holds, one can actually construct IMCs/IMDPs more efficiently. This leads to the following outstanding problem.

Open Problem 11. *It is desirable to investigate which classes of systems satisfy the property in Definition 11.1, as well as alternative ways of describing monotonicity for stochastic systems.*

11.5. Compositional Construction of IMCs/IMDPs. Since constructing IMCs/IMDPs is more complex than standard abstractions, as discussed in Subsection 4.3, a promising approach to mitigate the related computational complexity is to develop compositional techniques: these might allow constructing IMCs/IMDPs of high-dimensional systems based on IMCs/IMDPs for smaller subsystems.

11.6. Compositional Controller Synthesis for SHS. In this survey, we mainly discussed different compositional approaches for the construction of (in)finite abstractions for networks of stochastic systems. Potential future work concerns the investigation of compositional controller synthesis for stochastic hybrid systems. In particular, given a specification over the interconnected system, it is of interest to find a formal relation

between the satisfaction probabilities provided by local controllers for individual subsystems, as well as the optimal satisfaction probability for the specification on the monolithic (global) system.

11.7. Extensions and Development of Software Tools. Developing efficient software tools based on the theoretical and algorithmic results is essential for automated verification and synthesis of SHS. Most of the tools discussed in Section 10 are developed for discrete-time SHS. As such, a potential direction of useful work is to develop software tools for *continuous-time* SHS. Moreover, developing software tools to handle *infinite-horizon specifications* is another promising extension. In addition, there is no tool at the moment that handles the construction of finite MDPs in a *compositional way*: further developing software tools for compositional purposes is therefore of interest.

A comprehensive and up-to-date discussion about different software tools together with their potential directions of extension can be found in [ABC⁺20] and available at <https://bit.ly/3nGechr>.

12. CLOSING DISCUSSION

In this article, we have provided the first survey of work on automated formal verification and control synthesis of stochastic hybrid systems. We have focused on most recent and sharpest results, and for the sake of a clear and streamlined presentation we have presented selected analysis methods, applications, and results in detail, and instead briefly overviewed alternative approaches. We have distinguished approaches as discretization-based and -free, and have investigated four different closeness guarantees between a concrete SHS model and its abstractions. We have discussed different problems including stochastic similarity relations, infinite and finite abstractions, control barrier certificates, temporal logic verification and synthesis, compositional techniques, continuous-time stochastic models, and overviewed existing software tools that implement the discussed approaches. Throughout this survey, we have also added the discussion of a few open problems.

We hope that this survey article provides an introduction to the foundations of SHS, towards an easier understanding of many challenges and existing solutions related to formal verification and control synthesis of these models, together with the associated software tools.

REFERENCES

- [AAP⁺06] S. Amin, A. Abate, M. Prandini, J. Lygeros, and S. Sastry. Reachability analysis for controlled discrete time stochastic hybrid systems. In *Proceedings of HSCC06, LNCS 3927*, pages 49–63. Springer Verlag, 2006.
- [Aba09] A. Abate. A contractivity approach for probabilistic bisimulations of diffusion processes. In *Proceedings of the 48th IEEE Conference of Decision and Control*, pages 2230–2235, 2009.
- [Aba10] A. Abate. Probabilistic bisimulations of switching and resetting diffusions. In *Proceedings of the 49th IEEE Conference of Decision and Control*, pages 5918–5923, 2010.
- [Aba13] A. Abate. Approximation metrics based on probabilistic bisimulations for general state-space Markov processes: a survey. *Electronic Notes in Theoretical Computer Science*, 297:3–25, 2013.
- [ABC⁺18] Alessandro Abate, Henk Blom, Nathalie Cauchi, Sofie Haesaert, Arnd Hartmanns, Kendra Lesser, Meeko Oishi, Vignesh Sivaramakrishnan, Sadegh Soudjani, Cristian-Ioan Vasile, and Abraham P. Vinod. ARCH-COMP18 category report: Stochastic modelling. In *5th International Workshop on Applied Verification of Continuous and Hybrid Systems*, volume 54 of *EPiC Series in Computing*, pages 71–103, 2018.
- [ABC⁺19] Alessandro Abate, Henk Blom, Nathalie Cauchi, Kurt Degiorgio, Martin Fraenzle, Ernst Moritz Hahn, Sofie Haesaert, Hao Ma, Meeko Oishi, Carina Pilch, Anne Remke, Mahmoud Salamati, Sadegh Soudjani, Birgit van Huijgevoort, and Abraham Vinod. ARCH-COMP19 category report: Stochastic modelling. In *6th International Workshop on Applied Verification of Continuous and Hybrid Systems*, volume 61 of *EPiC Series in Computing*, pages 62–102, 2019.
- [ABC⁺20] Alessandro Abate, Henk Blom, Nathalie Cauchi, Joanna Delicaris, Arnd Hartmanns, Mahmoud Khaled, Abolfazl Lavaei, Carina Pilch, Anne Remke, Stefan Schupp, Fedor Shmarov, Sadegh Soudjani, Abraham Vinod, Ben Wooding, Majid Zamani, and Paolo Zuliani. ARCH-COMP20 category report: Stochastic models. In *7th International Workshop on Applied Verification of Continuous and Hybrid Systems (ARCH20)*, volume 74 of *EPiC Series in Computing*, pages 76–106, 2020.

- [ABFG⁺93] Aristotle Arapostathis, Vivek S. Borkar, Emmanuel Fernández-Gaucherand, Mrinal K. Ghosh, and Steven I. Marcus. Discrete-time controlled Markov processes with average cost criterion: A survey. *SIAM J. Control Optim.*, 31(2):282–344, 1993.
- [ACJT18] M. Ahmadi, M. Cubuktepe, N. Jansen, and U. Topcu. Verification of uncertain POMDPs using barrier certificates. In *Proceedings of the Annual Allerton Conference on Communication, Control, and Computing*, pages 115–122, 2018.
- [ADB11] A. Abate, A. D’Innocenzo, and M.D. Di Benedetto. Approximate abstractions of stochastic hybrid systems. *IEEE Transactions on Automatic Control*, 56(11):2688–2694, 2011.
- [AJZ19] M Anand, P Jagtap, and M Zamani. Verification of switched stochastic systems via barrier certificates. In *Proceedings of the 58th IEEE Conference on Decision and Control*, to appear, pages 4373–4378, 2019.
- [AKLP10] A. Abate, J.P. Katoen, J. Lygeros, and M. Prandini. Approximate model checking of stochastic hybrid systems. *European Journal of Control*, 16(6):624–641, 2010.
- [AKNP14] Al. Abate, M. Kwiatkowska, G. Norman, and D. Parker. Probabilistic model checking of labelled Markov processes via finite approximate bisimulations. In *Horizons of the Mind. A Tribute to Prakash Panangaden*, pages 40–58. Springer, 2014.
- [ALZ20] M. Anand, A. Lavaei, and M. Zamani. Compositional construction of control barrier certificates for large-scale interconnected stochastic systems. In *Proceedings of the 21st IFAC World Congress*, to appear, 2020.
- [ALZ21] M. Anand, A. Lavaei, and M. Zamani. From small-gain theory to compositional construction of barrier certificates for large-scale stochastic systems. *arXiv:2101.06916*, 2021.
- [AMP16] M. Arcak, Ch. Meissen, and A. Packard. *Networks of dissipative systems: compositional certification of stability, performance, and safety*. Springer, 2016.
- [AP18] G. Agha and K. Palmskog. A survey of statistical model checking. *ACM Transactions on Modeling and Computer Simulation (TOMACS)*, 28(1):1–39, 2018.
- [APLS08] A. Abate, M. Prandini, J. Lygeros, and S. Sastry. Probabilistic reachability and safety for controlled discrete-time stochastic hybrid systems. *Automatica*, 44(11):2724–2734, 2008.
- [ASBA19] M. Ahmadi, A. Singletary, J. W. Burdick, and A. D. Ames. Safe policy synthesis in multi-agent POMDPs via discrete-time barrier functions. In *Proceedings of the 58th Conference on Decision and Control (CDC)*, pages 4797–4803, 2019.
- [AZ18] A. U. Awan and M. Zamani. Compositional abstractions of networks of stochastic hybrid systems under randomly switched topologies. In *Proceedings of the American Control Conference (ACC)*, pages 1586–1591, 2018.
- [AZ19] A. U. Awan and M. Zamani. From dissipativity theory to compositional abstractions of interconnected stochastic hybrid systems. *IEEE Transactions on Control of Network Systems*, 7(1):433–445, 2019.
- [BA17] G. Bian and A. Abate. On the relationship between bisimulation and trace equivalence in an approximate probabilistic context. In *Proceedings of the International Conference on Foundations of Software Science and Computation Structures*, pages 321–337, 2017.
- [BBL⁺19] G. Bacci, G. Bacci, K. G. Larsen, R. Mardare, Q. Tang, and F. van Breugel. Computing probabilistic bisimilarity distances for probabilistic automata. *arXiv:1907.01768*, 2019.
- [BCS15] B. Bérard, K. Chatterjee, and N. Sznajder. Probabilistic opacity for Markov decision processes. *Information Processing Letters*, 115(1):52–59, 2015.
- [BEOB14] Marc Bouissou, Hilding Elmqvist, Martin Otter, and Albert Benveniste. Efficient Monte Carlo simulation of stochastic hybrid systems. In *Proceedings of the 10th International Modelica Conference*, 2014.
- [BK08] C. Baier and J.-P. Katoen. *Principles of model checking*. MIT press, 2008.
- [BKB⁺07] H. AP. Blom, J. Krystul, G.J. Bakker, M. B. Klompstra, and B. K. Obbink. Free flight collision risk estimation by sequential MC simulation. pages 249–281, 2007.
- [BL03] M. L. Bujorianu and J. Lygeros. Reachability questions in piecewise deterministic Markov processes. In *Proceedings of the 6th International Workshop on Hybrid Systems: Computation and Control*, volume 2623 of *Lecture Notes in Computer Science*, pages 126–140. Springer, 2003.
- [BLE⁺06] H. AP. Blom, J. Lygeros, M. Everdij, S. Loizou, and K. Kyriakopoulos. *Stochastic hybrid systems: theory and safety critical applications*, volume 337. Springer, 2006.
- [BS96] D. P. Bertsekas and S. E. Shreve. *Stochastic optimal control: The discrete-time case*. Athena Scientific, 1996.
- [BSB13] H. AP. Blom, S. H. Stroeve, and T. Bosse. Modelling of potential hazards in agent-based safety risk analysis. In *Proceedings of the 10th USA/Europe Air Traffic Management Research and Development Seminar*, 2013.
- [Buj12] L. M. Bujorianu. *Stochastic reachability analysis of hybrid systems*. Springer Science & Business Media, 2012.
- [BWZP20] A. Bozkurt, Yu Wang, Michael M. Zavlanos, and M. Pajic. Control synthesis from linear temporal logic specifications using model-free reinforcement learning. *2020 IEEE International Conference on Robotics and Automation (ICRA)*, pages 10349–10355, 2020.
- [BYG17] Calin Belta, Boyan Yordanov, and Ebru Aydin Gol. *Formal Methods for Discrete-Time Dynamical Systems*, volume 89 of *Studies in Systems, Decision and Control*. Springer, 2017.
- [CA15] S. Coogan and M. Arcak. Efficient finite abstraction of mixed monotone systems. In *Proceedings of the 18th International Conference on Hybrid Systems: Computation and Control*, pages 58–67, 2015.

- [CA18] N. Cauchi and A. Abate. Benchmarks for cyber-physical systems: A modular model library for building automation systems. In *Proceedings of ADHS*, pages 49–54, 2018.
- [CC06] G. C. Calafiore and M. C. Campi. The scenario approach to robust control design. *IEEE Transactions on Automatic Control*, 51(5):742–753, 2006.
- [CDA19] N. Cauchi, K. Degiorgio, and A. Abate. StocHy: Automated verification and synthesis of stochastic processes. In *TACAS’19, Lecture Notes in Computer Science*, pages 247–264. Springer, 2019.
- [CG04] F. Ciesinski and M. Größer. On probabilistic computation tree logic. In *Validation of Stochastic Systems*, pages 147–188. Springer, 2004.
- [CGSS13] A. Cimatti, A. Griggio, B. J. Schaafsma, and R. Sebastiani. The MathSAT5 SMT solver. In *Tools and Algorithms for the Construction and Analysis of Systems*, Lecture Notes in Computer Science, pages 93–107, 2013.
- [CL06] C. G. Cassandras and J. Lygeros. *Stochastic hybrid systems*. CRC Press, 2006.
- [Cla19] A. Clark. Control barrier functions for complete and incomplete information stochastic systems. In *Proceedings of the American Control Conference (ACC)*, pages 2928–2935, 2019.
- [Cla20] A. Clark. Control barrier functions for stochastic systems. *arXiv:2003.03498*, 2020.
- [CLL⁺19] N. Cauchi, L. Laurenti, M. Lahijanian, A. Abate, M. Kwiatkowska, and L. Cardelli. Efficiency through uncertainty: Scalable formal synthesis for stochastic hybrid systems. In *Proceedings of the 22nd ACM International Conference on Hybrid Systems: Computation and Control*, pages 240–251, 2019.
- [CS13] A. Chakarov and S. Sankaranarayanan. Probabilistic program analysis with martingales. In *Proceedings of the International Conference on Computer Aided Verification*, pages 511–526, 2013.
- [DAK12] A. D’Innocenzo, A. Abate, and J.P. Katoen. Robust PCTL model checking. In *Proceedings of the 15th ACM international conference on Hybrid Systems: Computation and Control*, pages 275–286, 2012.
- [DAT13] J. Ding, A. Abate, and C. Tomlin. Optimal control of partially observable discrete time stochastic hybrid systems for safety specifications. In *Proceedings of the 2013 American Control Conference*, pages 6231–6236, 2013.
- [Dav93] M. H. A. Davis. *Markov models and optimization*, volume 49 of *Monographs on Statistics and Applied Probability*. Chapman & Hall, London, 1993.
- [DC18] Maxence Dutreix and Samuel Coogan. Efficient verification for stochastic mixed monotone systems. In *Proceedings of the 9th International Conference on Cyber-Physical Systems (ICCPs)*, pages 150–161, 2018.
- [DC19] M. Dutreix and S. Coogan. Specification-guided verification and abstraction refinement of mixed monotone stochastic systems. *arXiv:1903.02191*, 2019.
- [DGJP04] J. Desharnais, V. Gupta, R. Jagadeesan, and P. Panangaden. Metrics for labelled Markov processes. *Theoretical computer science*, 318(3):323–354, 2004.
- [DHC20] M. Dutreix, J. Huh, and S. Coogan. Abstraction-based synthesis for stochastic systems with omega-regular objectives. *arXiv:2001.09236*, 2020.
- [DJKV17] C. Dehnert, S. Junges, J.-P. Katoen, and M. Volk. A storm is coming: A modern probabilistic model checker. In *Proceedings of the 29th International Conference on Computer Aided Verification (CAV)*, volume 10427 of *Lecture Notes in Computer Science*, pages 592–600. Springer, 2017.
- [DKS⁺13] J. Ding, M. Kamgarpour, S. Summers, A. Abate, J. Lygeros, and C. Tomlin. A stochastic games framework for verification and control of discrete time stochastic hybrid systems. *Automatica*, 49(9):2665–2674, 2013.
- [DLT08] J. Desharnais, F. Lavolette, and M. Tracol. Approximate analysis of probabilistic processes: Logic, simulation and games. In *Proceedings of the 5th international conference on quantitative evaluation of system*, pages 264–273, 2008.
- [DMB08] L. De Moura and N. Bjørner. Z3: An efficient SMT solver. In *Proceedings of the International conference on Tools and Algorithms for the Construction and Analysis of Systems*, pages 337–340, 2008.
- [DRW10] S. N. Dashkovskiy, B. S. Rüffer, and F. R. Wirth. Small gain theorems for large scale systems and construction of ISS Lyapunov functions. *SIAM Journal on Control and Optimization*, 48(6):4089–4118, 2010.
- [FHH⁺11] M. Fränzle, E. M. Hahn, H. Hermanns, N. Wolovick, and L. Zhang. Measurability and safety verification for stochastic hybrid systems. In *Proceedings of the 14th international conference on hybrid systems: computation and control*, pages 43–52, 2011.
- [FI04] A. Fehnker and F. Ivančić. Benchmarks for hybrid systems verification. In *International Workshop on Hybrid Systems: Computation and Control*, pages 326–341. Springer, 2004.
- [FT15] J. Fu and U. Topcu. Computational methods for stochastic control with metric interval temporal logic specifications. In *Proceedings of the 54th IEEE Conference on Decision and Control (CDC)*, pages 7440–7447, 2015.
- [GAC12] S. Gao, J. Avigad, and E. M. Clarke. δ -complete decision procedures for satisfiability over the reals. In *Automated Reasoning*, Lecture Notes in Computer Science, pages 286–300, 2012.
- [GLQ06] Y. Gao, J. Lygeros, and M. Quincampoix. The reachability problem for uncertain hybrid systems revisited: A viability theory perspective. In *Proceedings of the 9th International Workshop on Hybrid Systems: Computation and Control*, volume 3927 of *Lecture Notes in Computer Science*, pages 242–256. Springer, 2006.
- [GT19] M. Ghasemi and U. Topcu. Perception-aware point-based value iteration for partially observable Markov decision processes. In *Proceedings of the 28th International Joint Conference on Artificial Intelligence (IJCAI)*, pages 2371–2377, 2019.

- [GVO17] J. D. Gleason, A. P. Vinod, and M. MK. Oishi. Underapproximation of reach-avoid sets for discrete-time stochastic systems via Lagrangian methods. In *Proceedings of the 56th Conference on Decision and Control*, pages 4283–4290, 2017.
- [HAK19a] M. Hasanbeig, A. Abate, and D. Kroening. Certified reinforcement learning with logic guidance. *arXiv:1902.00778*, 2019.
- [HAK19b] Mohammadhosein Hasanbeig, Alessandro Abate, and Daniel Kroening. Logically-Constrained Neural Fitted Q-Iteration. In *Proceedings of the 18th International Conference on Autonomous Agents and Multi-Agent Systems (AAMAS)*, pages 2012–2014, 2019.
- [Har06] D. J. Hartfiel. *Markov set-chains*. Springer, 2006.
- [HCA17] S. Haesaert, N. Cauchi, and A. Abate. Certified policy synthesis for general Markov decision processes: An application in building automation systems. *Performance Evaluation*, 117:75–103, 2017.
- [HCL⁺17] C. Huang, X. Chen, W. Lin, Z. Yang, and X. Li. Probabilistic safety verification of stochastic hybrid systems using barrier certificates. *ACM Transactions on Embedded Computing Systems (TECS)*, 16(5s):186, 2017.
- [HH14a] P. Hall and C. C. Heyde. *Martingale limit theory and its application*. Academic press, 2014.
- [HH14b] A. Hartmanns and H. Hermanns. The modest toolset: An integrated environment for quantitative modelling and verification. In *Proceedings of the International Conference on Tools and Algorithms for the Construction and Analysis of Systems*, pages 593–598, 2014.
- [HHA17] S. Haesaert, P.M.J. V.d. Hof, and A. Abate. Data-driven and model-based verification via Bayesian identification and reachability analysis. *Automatica*, 79(5):115–126, 2017.
- [HKA⁺19] M. Hasanbeig, Y. Kantaros, A. Abate, D. Kroening, G. J. Pappas, and I. Lee. Reinforcement Learning for Temporal Logic Control Synthesis with Probabilistic Satisfaction Guarantees. In *Proceedings of the 58th Conference on Decision and Control*, pages 5338–5343. IEEE, 2019.
- [HKA20] Mohammadhosein Hasanbeig, Daniel Kroening, and Alessandro Abate. Deep reinforcement learning with temporal logics. In *FORMATS*, pages 1–22. Springer LNCS 12288, 2020.
- [HLL96] Onésimo Hernández-Lerma and J. B. Lasserre. *Discrete-time Markov control processes*. Appl. Math. 30, Springer, New York, 1996.
- [HLS00] Jianghai Hu, John Lygeros, and Shankar Sastry. Towards a theory of stochastic hybrid systems. In *Proceedings of the Third International Workshop on Hybrid Systems: Computation and Control*, volume 1790 of *Lecture Notes in Computer Science*, pages 160–173. Springer, 2000.
- [HMMS18] K. Hsu, R. Majumdar, K. Mallik, and A.-K. Schmuck. Multi-layered abstraction-based controller synthesis for continuous-time systems. In *Proceedings of the 21st International Conference on Hybrid Systems: Computation and Control*, pages 120–129, 2018.
- [HMZ⁺12] D. Henriques, J. G. Martins, P. Zuliani, A. Platzer, and E. M. Clarke. Statistical model checking for Markov decision processes. In *Proceedings of the 9th international conference on quantitative evaluation of systems*, pages 84–93, 2012.
- [HNS21] S. Haesaert, P. Nilsson, and S. Soudjani. Formal multi-objective synthesis of continuous-state MDPs. *IEEE Control Systems Letters*, 5(5):1765–1770, 2021.
- [HPS⁺19] E. M. Hahn, M. Perez, S. Schewe, F. Somenzi, A. Trivedi, and D. Wojtczak. Omega-regular objectives in model-free reinforcement learning. In *Proceedings of the International Conference on Tools and Algorithms for the Construction and Analysis of Systems*, pages 395–412, 2019.
- [HS18] S. Haesaert and S. Soudjani. Robust dynamic programming for temporal logic control of stochastic systems. *CoRR*, abs/1811.11445, 2018.
- [HSA17] Sofie Haesaert, Sadegh Soudjani, and Alessandro Abate. Verification of general Markov decision processes by approximate similarity relations and policy refinement. *SIAM Journal on Control and Optimization*, 55(4):2333–2367, 2017.
- [HSA18] S. Haesaert, S. Soudjani, and A. Abate. Temporal logic control of general Markov decision processes by approximate policy refinement. *IFAC-PapersOnLine*, 51(16):73–78, 2018.
- [JJZ20a] N. Jahanshahi, P. Jagtap, and M. Zamani. Synthesis of partially observed jump-diffusion systems via control barrier functions. *IEEE Control Systems Letters*, 5(1):253–258, 2020.
- [JJZ20b] N. Jahanshahi, P. Jagtap, and M. Zamani. Synthesis of stochastic systems with partial information via control barrier functions. In *Proceedings of the 21st IFAC World Congress, to appear*, 2020.
- [JP09] A. A. Julius and G. J. Pappas. Approximations of stochastic hybrid systems. *IEEE Transactions on Automatic Control*, 54(6):1193–1203, 2009.
- [JSZ18] P. Jagtap, S. Soudjani, and M. Zamani. Temporal logic verification of stochastic systems using barrier certificates. In *Proceedings of the International Symposium on Automated Technology for Verification and Analysis*, pages 177–193, 2018.
- [JSZ20] P. Jagtap, S. Soudjani, and M. Zamani. Formal synthesis of stochastic systems via control barrier certificates. *IEEE Transactions on Automatic Control*, DOI: 10.1109/TAC.2020.3013916, 2020.
- [Jun20] S. Junges. *Parameter Synthesis in Markov Models*. PhD thesis, RWTH Aachen University, Germany, 2020.
- [Kal97] O. Kallenberg. *Foundations of modern probability*. Springer-Verlag, New York, 1997.

- [KDS⁺11] M. Kamgarpour, J. Ding, S. Summers, A. Abate, J. Lygeros, and C. Tomlin. Discrete time stochastic hybrid dynamical games: Verification & controller synthesis. In *Proceedings of the 50th IEEE Conference on Decision and Control and European Control Conference*, pages 6122–6127, 2011.
- [KNP02] M. Kwiatkowska, G. Norman, and D. Parker. PRISM: Probabilistic symbolic model checker. In *Proceedings of the International Conference on Modelling Techniques and Tools for Computer Performance Evaluation*, pages 200–204, 2002.
- [KNP11] M. Kwiatkowska, G. Norman, and D. Parker. Prism 4.0: Verification of probabilistic real-time systems. In *International conference on computer aided verification*, pages 585–591. Springer, 2011.
- [KNPQ13] M. Kwiatkowska, G. Norman, D. Parker, and H. Qu. Compositional probabilistic verification through multi-objective model checking. *Information and Computation*, 232:38–65, 2013.
- [KR06] X. D. Koutsoukos and D. Riley. Computational methods for reachability analysis of stochastic hybrid systems. In *Proceedings of the 9th International Workshop on Hybrid Systems: Computation and Control*, volume 3927 of *Lecture Notes in Computer Science*, pages 377–391. Springer, 2006.
- [KS20] Milad Kazemi and Sadegh Soudjani. Formal policy synthesis for continuous-space systems via reinforcement learning. In *International Conference on integrated Formal Methods (iFM20)*, 2020.
- [KSL13] M. Kamgarpour, S. Summers, and J. Lygeros. Control design for specifications on stochastic hybrid systems. In *Proceedings of the 16th international conference on hybrid systems: computation and control*, pages 303–312, 2013.
- [Kus67] H. J. Kushner. *Stochastic Stability and Control*. Mathematics in Science and Engineering. Elsevier Science, 1967.
- [KV01] O. Kupferman and M. Y. Vardi. Model checking of safety properties. *Formal Methods in System Design*, 19(3):291–314, 2001.
- [LA18] K. Lesser and A. Abate. Multi-objective optimal control with safety as a priority. *IEEE Transactions on Control Systems Technology*, 26(3):1015–1027, 2018.
- [LAB09] M. Lahijanian, S. B. Andersson, and C. Belta. A probabilistic approach for control of a stochastic system from LTL specifications. In *Proceedings of the 48th IEEE Conference on Decision and Control (CDC) held jointly with 28th Chinese Control Conference*, pages 2236–2241, 2009.
- [LAB12] M. Lahijanian, S. B. Andersson, and C. Belta. Approximate Markovian abstractions for linear stochastic systems. In *Proceedings of the 51st IEEE Conference on Decision and Control (CDC)*, pages 5966–5971, 2012.
- [LAB15] M. Lahijanian, S. B. Andersson, and C. Belta. Formal verification and synthesis for discrete-time stochastic systems. *IEEE Transactions on Automatic Control*, 60(8):2031–2045, 2015.
- [LAB⁺17] L. Laurenti, A. Abate, L. Bortolussi, L. Cardelli, M. Ceska, and M. Kwiatkowska. Reachability computation for switching diffusions: Finite abstractions with certifiable and tuneable precision. In *Proceedings of the 20th ACM International Conference on Hybrid Systems: Computation and Control*, pages 55–64, 2017.
- [Lav19] A. Lavaei. *Automated Verification and Control of Large-Scale Stochastic Cyber-Physical Systems: Compositional Techniques*. PhD thesis, Department of Electrical Engineering, Technische Universität München, Germany, 2019.
- [LKSZ20] A. Lavaei, M. Khaled, S. Soudjani, and M. Zamani. AMYTISS: Parallelized automated controller synthesis for large-scale stochastic systems. In *Proceedings of the 32nd International Conference on Computer-Aided Verification (CAV), Lecture Notes in Computer Science 12225*, pages 461–474, 2020.
- [LLA⁺20] L. Laurenti, M. Lahijanian, A. Abate, L. Cardelli, and M. Kwiatkowska. Formal and efficient synthesis for continuous-time linear stochastic hybrid processes. *IEEE Transactions on Automatic Control*, 2020.
- [LLT⁺18] Y.-J. Liu, S. Lu, S. Tong, X. Chen, C. P. Chen, and D.-J. Li. Adaptive control-based barrier Lyapunov functions for a class of stochastic nonlinear systems with full state constraints. *Automatica*, 87:83–93, 2018.
- [LO14] K. Lesser and M. Oishi. Reachability for partially observable discrete time stochastic hybrid systems. *Automatica*, 50(8):1989–1998, 2014.
- [LO15a] K. Lesser and M. Oishi. Computing probabilistic viable sets for partially observable systems using truncated gaussians and adaptive gridding. In *Proceedings of the American Control Conference (ACC)*, pages 1505–1512, 2015.
- [LO15b] K. Lesser and M. Oishi. Finite state approximation for verification of partially observable stochastic hybrid systems. In *Proceedings of the 18th International Conference on Hybrid Systems: Computation and Control*, pages 159–168, 2015.
- [LO16] K. Lesser and M. Oishi. Approximate safety verification and control of partially observable stochastic hybrid systems. *IEEE Transactions on Automatic Control*, 62(1):81–96, 2016.
- [LS91] K. G. Larsen and A. Skou. Bisimulation through probabilistic testing. *Information and computation*, 94(1):1–28, 1991.
- [LSMZ17] A. Lavaei, S. Soudjani, R. Majumdar, and M. Zamani. Compositional abstractions of interconnected discrete-time stochastic control systems. In *Proceedings of the 56th IEEE Conference on Decision and Control*, pages 3551–3556, 2017.
- [LSS⁺20] A. Lavaei, F. Somenzi, S. Soudjani, A. Trivedi, and M. Zamani. Formal controller synthesis for continuous-space mdps via model-free reinforcement learning. In *Proceedings of the 11th ACM/IEEE International Conference on Cyber-Physical Systems (ICCPs)*, pages 98–107. IEEE, 2020.
- [LSZ18a] A. Lavaei, S. Soudjani, and M. Zamani. Compositional synthesis of finite abstractions for continuous-space stochastic control systems: A small-gain approach. *Proceedings of the 6th IFAC Conference on Analysis and Design of Hybrid Systems*, 51(16):265–270, 2018.

- [LSZ18b] A. Lavaei, S. Soudjani, and M. Zamani. From dissipativity theory to compositional construction of finite Markov decision processes. In *Proceedings of the 21st ACM International Conference on Hybrid Systems: Computation and Control*, pages 21–30, 2018.
- [LSZ19a] A. Lavaei, S. Soudjani, and M. Zamani. Approximate probabilistic relations for compositional synthesis of stochastic systems. In *Proceedings of the Numerical Software Verification*, pages 101–109, 2019. Lecture Notes in Computer Science 11652.
- [LSZ19b] A. Lavaei, S. Soudjani, and M. Zamani. Compositional construction of infinite abstractions for networks of stochastic control systems. *Automatica*, 107:125–137, 2019.
- [LSZ19c] A. Lavaei, S. Soudjani, and M. Zamani. Compositional synthesis of not necessarily stabilizable stochastic systems via finite abstractions. In *Proceedings of the 18th European Control Conference*, pages 2802–2807, 2019.
- [LSZ20a] A. Lavaei, S. Soudjani, and M. Zamani. Compositional abstraction-based synthesis for networks of stochastic switched systems. *Automatica*, 114, 2020.
- [LSZ20b] A. Lavaei, S. Soudjani, and M. Zamani. Compositional abstraction-based synthesis of general MDPs via approximate probabilistic relations. *Nonlinear Analysis: Hybrid Systems*, 39, 2020.
- [LSZ20c] A. Lavaei, S. Soudjani, and M. Zamani. Compositional abstraction of large-scale stochastic systems: A relaxed dissipativity approach. *Nonlinear Analysis: Hybrid Systems*, 36, 2020.
- [LSZ20d] A. Lavaei, S. Soudjani, and M. Zamani. Compositional (in)finite abstractions for large-scale interconnected stochastic systems. *IEEE Transactions on Automatic Control*, 65(12):5280–5295, 2020.
- [LYZ20] S. Liu, X. Yin, and M. Zamani. On a notion of approximate opacity for discrete-time stochastic control systems. In *Proceedings of the American Control Conference (ACC)*, to appear, 2020.
- [LZ19] A. Lavaei and M. Zamani. Compositional verification of large-scale stochastic systems via relaxed small-gain conditions. In *Proceedings of the 58th IEEE Conference on Decision and Control*, pages 2574–2579, 2019.
- [LZ20] A. Lavaei and M. Zamani. From dissipativity theory to compositional synthesis of large-scale stochastic switched systems. *Submitted for publication*, 2020.
- [MECL15] P. Mohajerin Esfahani, D. Chatterjee, and J. Lygeros. Motion planning for continuous-time stochastic processes: A dynamic programming approach. *IEEE Transactions on Automatic Control*, 61(8):2155–2170, 2015.
- [MGW17] P. J. Meyer, A. Girard, and E. Witrant. Compositional abstraction and safety synthesis using overlapping symbolic models. *IEEE Transactions on Automatic Control*, 2017.
- [MMS20] R. Majumdar, K. Mallik, and S. Soudjani. Symbolic controller synthesis for büchi specifications on stochastic systems. In *Proceedings of the 23rd International Conference on Hybrid Systems: Computation and Control*, pages 1–11, 2020.
- [MNP08] O. Maler, D. Nickovic, and A. Pnueli. Checking temporal properties of discrete, timed and continuous behaviors. In *Pillars of computer science*, pages 475–505. Springer, 2008.
- [MSSM17] K. Mallik, S. Soudjani, A.-K. Schmuck, and R. Majumdar. Compositional construction of finite state abstractions for stochastic control systems. In *Proceedings of the 56th IEEE International Conference on Decision and Control (CDC)*, pages 550–557, 2017.
- [MT93] S. P. Meyn and R. L. Tweedie. *Markov chains and stochastic stability*. Comm. Control Engrg., Springer, London, 1993.
- [NSZ19] A. Nejati, S. Soudjani, and M. Zamani. Abstraction-based synthesis of continuous-time stochastic control systems. In *Proceedings of the 18th European Control Conference*, pages 3212–3217, 2019.
- [NSZ20a] A. Nejati, S. Soudjani, and M. Zamani. Compositional construction of control barrier certificates for large-scale stochastic switched systems. *IEEE Control Systems Letters*, 4(4):845–850, 2020.
- [NSZ20b] A. Nejati, S. Soudjani, and M. Zamani. Compositional construction of control barrier functions for continuous-time stochastic hybrid systems. *arXiv:2012.07296*, 2020.
- [NSZ20c] A. Nejati, S. Soudjani, and M. Zamani. Compositional construction of control barrier functions for networks of continuous-time stochastic systems. In *Proceedings of the 21st IFAC World Congress*, to appear, 2020.
- [NSZ21] A. Nejati, S. Soudjani, and M. Zamani. Compositional abstraction-based synthesis for continuous-time stochastic hybrid systems. *European Journal of Control*, 57:82–94, 2021.
- [NZ20] A. Nejati and M. Zamani. Compositional construction of finite MDPs for continuous-time stochastic systems: A dissipativity approach. In *Proceedings of the 21st IFAC World Congress*, to appear, 2020.
- [Oks13] B. Oksendal. *Stochastic differential equations: an introduction with applications*. Springer Science & Business Media, 2013.
- [Pan09] Prakash Panangaden. *Labelled Markov Processes*. IMPERIAL COLLEGE PRESS, 2009.
- [Par03] P. A. Parrilo. Semidefinite programming relaxations for semialgebraic problems. *Mathematical Programming*, 96(2):293–320, 2003.
- [PAV⁺13] A. Papachristodoulou, J. Anderson, G. Valmorbida, S. Prajna, P. Seiler, and P. Parrilo. SOSTOOLS version 3.00 sum of squares optimization toolbox for MATLAB. *arXiv:1310.4716*, 2013.
- [PBLB03] Giordano Pola, Manuela L. Bujorianu, John Lygeros, and Maria Domenica Di Benedetto. Stochastic hybrid models: An overview. In *IFAC Conference on Analysis and Design of Hybrid Systems*, volume 36-6, pages 45–50, 2003.
- [PC16] Ali Pakniyat and Peter E. Caines. On the stochastic minimum principle for hybrid systems. In *55th IEEE Conference on Decision and Control*, pages 1139–1144, 2016.

- [PER17] C. Pilch, F. Edenfeld, and A. Remke. Hypeg: Statistical model checking for hybrid petri nets: Tool paper. In *Proceedings of the 11th EAI International Conference on Performance Evaluation Methodologies and Tools*, pages 186–191, 2017.
- [PJP07] S. Prajna, A. Jadbabaie, and G. J. Pappas. A framework for worst-case and stochastic safety verification using barrier certificates. *IEEE Transactions on Automatic Control*, 52(8):1415–1428, 2007.
- [Pnu77] A. Pnueli. The temporal logic of programs. In *Proceedings of the 18th Annual Symposium on Foundations of Computer Science*, pages 46–57, 1977.
- [PP06] Gianni Pola and Giordano Pola. Optimal dynamic asset allocation: A stochastic invariance approach. In *45th IEEE Conference on Decision and Control*, pages 2589–2594, 2006.
- [PR05] S. Prajna and A. Rantzer. On the necessity of barrier certificates. *IFAC Proceedings Volumes*, 38(1):526–531, 2005.
- [RCSL10] Federico Ramponi, Debasish Chatterjee, Sean Summers, and John Lygeros. On the connections between PCTL and dynamic programming. In *Proceedings of the 13th ACM International Conference on Hybrid Systems: Computation and Control*, pages 253–262, 2010.
- [S⁺14] D. Silver et al. Deterministic policy gradient algorithms. In *Proceedings of the 31st International Conference on International Conference on Machine Learning*, pages 387–395, 2014.
- [SA12a] S. Soudjani and A. Abate. Higher-order approximations for verification of stochastic hybrid systems. In *Automated Technology for Verification and Analysis*, volume 7561 of *Lecture Notes in Computer Science*, pages 416–434. Springer, 2012.
- [SA12b] S. Soudjani and A. Abate. Probabilistic invariance of mixed deterministic-stochastic dynamical systems. In *ACM Proceedings of the 15th International Conference on Hybrid Systems: Computation and Control*, pages 207–216, April 2012.
- [SA13] S. Soudjani and A. Abate. Adaptive and sequential gridding procedures for the abstraction and verification of stochastic processes. *SIAM Journal on Applied Dynamical Systems*, 12(2):921–956, 2013.
- [SA14a] S. Soudjani and A. Abate. Precise approximations of the probability distribution of a Markov process in time: an application to probabilistic invariance. In *Proceedings of TACAS14, LNCS 8413*, pages 547–561. Springer Verlag, 2014.
- [SA14b] S. Soudjani and A. Abate. Probabilistic reach-avoid computation for partially-degenerate stochastic processes. *IEEE Transactions on Automatic Control*, 59(2):528–534, 2014.
- [SA15] S. Soudjani and A. Abate. Quantitative approximation of the probability distribution of a Markov process by formal abstractions. *Logical Methods in Computer Science*, 11(3), 2015.
- [SAM15] S. Soudjani, A. Abate, and R. Majumdar. Dynamic Bayesian networks as formal abstractions of structured stochastic processes. In *Proceedings of the 26th International Conference on Concurrency Theory*, pages 1–14, 2015.
- [SAM17] S. Soudjani, A. Abate, and R. Majumdar. Dynamic Bayesian networks for formal verification of structured stochastic processes. *Acta Informatica*, 54(2):217–242, 2017.
- [SDC19] C. Santoyo, M. Dutreix, and S.I Coogan. Verification and control for finite-time safety of stochastic systems via barrier functions. In *Proceedings of the IEEE Conference on Control Technology and Applications*, pages 712–717, 2019.
- [SGA15] S. Soudjani, C. Gevaerts, and A. Abate. FAUST²: Formal abstractions of uncountable-state stochastic processes. In *TACAS’15*, volume 9035 of *Lecture Notes in Computer Science*, pages 272–286. Springer, 2015.
- [SGE⁺14] S. Soudjani, S. Gerwinn, C. Ellen, M. Fränzle, and A. Abate. Formal synthesis and validation of inhomogeneous thermostatically controlled loads. In *Proceedings of the International Conference on Quantitative Evaluation of Systems*, pages 57–73, 2014.
- [SL95] R. Segala and N. Lynch. Probabilistic simulations for probabilistic processes. *Nordic Journal of Computing*, 2(2):250–273, 1995.
- [SL10] Sean Summers and John Lygeros. Verification of discrete time stochastic hybrid systems: A stochastic reach-avoid decision problem. *Autom.*, 46(12):1951–1961, 2010.
- [SLTB⁺06] Armando Solar-Lezama, Liviu Tancau, Rastislav Bodik, Sanjit Seshia, and Vijay Saraswat. Combinatorial sketching for finite programs. *ACM Sigplan Notices*, 41(11):404–415, 2006.
- [Smi08] H. L. Smith. Global stability for mixed monotone systems. *Journal of Difference Equations and Applications*, 14(10-11):1159–1164, 2008.
- [SMN17] S. Soudjani, R. Majumdar, and T. Nagapetyan. Multilevel Monte Carlo method for statistical model checking of hybrid systems. In *International Conference on Quantitative Evaluation of Systems*, pages 351–367, 2017.
- [Sou14] S. Soudjani. *Formal Abstractions for Automated Verification and Synthesis of Stochastic Systems*. PhD thesis, Technische Universiteit Delft, The Netherlands, 2014.
- [SPB⁺17] F. Shmarov, N. Paoletti, E. Bartocci, S. Lin, S. A. Smolka, and P. Zuliani. Automated synthesis of safe and robust PID controllers for stochastic hybrid systems. *arXiv:1707.05229*, 2017.
- [SSP⁺19] F. Shmarov, S. Soudjani, N. Paoletti, E. Bartocci, S. Lin, S. A. Smolka, and P. Zuliani. Automated synthesis of safe digital controllers for sampled-data stochastic nonlinear systems. *arXiv:1901.03315*, 2019.
- [SSZ20] A. Salamati, S. Soudjani, and M. Zamani. Data-driven verification under signal temporal logic constraints. *arXiv:2005.05040*, 2020.

- [ST12] J. Steinhardt and R. Tedrake. Finite-time regional verification of stochastic non-linear systems. *The International Journal of Robotics Research*, 31(7):901–923, 2012.
- [Stu99] J. F. Sturm. Using SeDuMi 1.02, a MATLAB toolbox for optimization over symmetric cones. *Optimization methods and software*, 11(1-4):625–653, 1999.
- [SVA05] K. Sen, M. Viswanathan, and G. Agha. On statistical model checking of stochastic systems. In *International Conference on Computer Aided Verification*, pages 266–280, 2005.
- [SZ15] F. Shmarov and P. Zuliani. ProbReach: Verified probabilistic delta-reachability for stochastic hybrid systems. In *Proceedings of the 18th International Conference on Hybrid Systems: Computation and Control*, pages 134–139, 2015.
- [SZ16] F. Shmarov and P. Zuliani. Probabilistic hybrid systems verification via SMT and Monte Carlo techniques. In *Proceedings of the Haifa Verification Conference*, pages 152–168, 2016.
- [TA11] I. Tkachev and A. Abate. On infinite-horizon probabilistic properties and stochastic bisimulation functions. In *Proceedings of the 50th IEEE Conference on Decision and Control and European Control Conference (CDC-ECC)*, pages 526–531, 2011.
- [TA12a] I. Tkachev and A. Abate. Regularization of Bellman equations for infinite-horizon probabilistic properties. In *Proceedings of the 15th ACM international conference on Hybrid Systems: computation and control*, pages 227–236, 2012.
- [TA12b] I. Tkachev and A. Abate. Stability and attractivity of absorbing sets for discrete-time Markov processes. In *Proceedings of the 51st IEEE Conference on Decision and Control*, pages 7652–7657, 2012.
- [TA14] I. Tkachev and A. Abate. Characterization and computation of infinite horizon specifications over Markov processes. *Theoretical Computer Science*, 515:1–18, 2014.
- [Tab09] P. Tabuada. *Verification and control of hybrid systems: A symbolic approach*. Springer Science & Business Media, 2009.
- [TMKA13] I. Tkachev, A. Mereacre, Joost-Pieter Katoen, and A. Abate. Quantitative automata-based controller synthesis for non-autonomous stochastic hybrid systems. In *Proceedings of the 16th ACM International Conference on Hybrid Systems: Computation and Control*, pages 293–302, 2013.
- [TMKA17a] I. Tkachev, A. Mereacre, J.-P. Katoen, and A. Abate. Quantitative model-checking of controlled discrete-time Markov processes. *Information and Computation*, 253:1–35, 2017.
- [TMKA17b] Ilya Tkachev, Alexandru Mereacre, Joost-Pieter Katoen, and Alessandro Abate. Quantitative model-checking of controlled discrete-time Markov processes. *Information and Computation*, 253:1 – 35, 2017.
- [TSS14] A. R. Teel, A. Subbaraman, and A. Sferlazza. Stability analysis for stochastic hybrid systems: A survey. *Automatica*, 50(10):2435–2456, 2014.
- [VGO19] A. P. Vinod, J. D. Gleason, and M. M. Oishi. SReachTools: A MATLAB stochastic reachability toolbox. In *Proceedings of the 22nd ACM International Conference on Hybrid Systems: Computation and Control*, pages 33–38, 2019.
- [VHO17] A. P. Vinod, B. HomChaudhuri, and M. MK. Oishi. Forward stochastic reachability analysis for uncontrolled linear systems using fourier transforms. In *Proceedings of the 20th ACM International Conference on Hybrid Systems: Computation and Control*, pages 35–44, 2017.
- [VO17] A. P. Vinod and M. MK. Oishi. Scalable underapproximation for the stochastic reach-avoid problem for high-dimensional LTI systems using fourier transforms. *IEEE control systems letters*, 1(2):316–321, 2017.
- [VO18] A.P. Vinod and Meeko M.K. Oishi. Scalable underapproximative verification of stochastic LTI systems using convexity and compactness. In *Proceedings of the 21st International Conference on Hybrid Systems: Computation and Control*, pages 1–10, 2018.
- [vS89] J. H. van Schuppen. Stochastic realization problems. In *Three decades of mathematical system theory*, pages 480–523. Springer, 1989.
- [WABT19] B. Wu, M. Ahmadi, S. Bharadwaj, and U. Topcu. Cost-bounded active classification using partially observable Markov decision processes. In *Proceedings of the American Control Conference (ACC)*, pages 1216–1223, 2019.
- [WBS20] Rafael Wisniewski, Manuela L. Bujorianu, and Christoffer Sloth. p-safe analysis of stochastic hybrid processes. *IEEE Trans. Autom. Control.*, 65(12):5220–5235, 2020.
- [WS15] R. Wisniewski and C. Sloth. Converse barrier certificate theorems. *IEEE Transactions on Automatic Control*, 61(5):1356–1361, 2015.
- [WTL15] T. Wongpiromsarn, U. Topcu, and A. Lamperski. Automata theory meets barrier certificates: Temporal logic verification of nonlinear systems. *IEEE Transactions on Automatic Control*, 61(11):3344–3355, 2015.
- [WZK⁺15] Q. Wang, P. Zuliani, S. Kong, S. Gao, and E. M. Clarke. SReach: A probabilistic bounded delta-reachability analyzer for stochastic hybrid systems. In *Proceedings of the International Conference on Computational Methods in Systems Biology*, pages 15–27, 2015.
- [YLWL17] X. Yin, Z. Li, W. Wang, and S. Li. Infinite-step opacity of stochastic discrete-event systems. In *2017 11th Asian Control Conference (ASCC)*, pages 102–107, 2017.
- [YLWL19] X. Yin, Z. Li, W. Wang, and S. Li. Infinite-step opacity and k-step opacity of stochastic discrete-event systems. *Automatica*, 99:266–274, 2019.

- [ZA14a] M. Zamani and A. Abate. Approximately bisimilar symbolic models for randomly switched stochastic systems. *IEEE Control Systems Letters*, 69:38–46, 2014.
- [ZA14b] M. Zamani and A. Abate. Symbolic models for randomly switched stochastic systems. *Systems & Control Letters*, 69:38–46, 2014.
- [ZA18] M. Zamani and M. Arcak. Compositional abstraction for networks of control systems: A dissipativity approach. *IEEE Transactions on Control of Network Systems*, 5(3):1003–1015, 2018.
- [ZAG15] M. Zamani, A. Abate, and A. Girard. Symbolic models for stochastic switched systems: A discretization and a discretization-free approach. *Automatica*, 55(5):183–196, 2015.
- [Zam66] G. Zames. On the input-output stability of time-varying nonlinear feedback systems part one: Conditions derived using concepts of loop gain, conicity, and positivity. *IEEE Transactions on Automatic Control*, 11(2):228–238, 1966.
- [Zam14] M. Zamani. Compositional approximations of interconnected stochastic hybrid systems. In *Proceedings of the 53rd IEEE Conference on Decision and Control (CDC)*, pages 3395–3400, 2014.
- [ZLWDA18] Y. Zaccchia Lun, J. Wheatley, A. D’Innocenzo, and A. Abate. Approximate abstractions of Markov chains with interval decision processes. *Proceedings of the 6th IFAC Conference on Analysis and Design of Hybrid Systems*, 51(16):91–96, 2018.
- [ZMEM⁺14] M. Zamani, P. Mohajerin Esfahani, R. Majumdar, A. Abate, and J. Lygeros. Symbolic control of stochastic systems via approximately bisimilar finite abstractions. *IEEE Transactions on Automatic Control*, 59(12):3135–3150, 2014.
- [ZRME17] M. Zamani, M. Rungger, and P. Mohajerin Esfahani. Approximations of stochastic hybrid systems: A compositional approach. *IEEE Transactions on Automatic Control*, 62(6):2838–2853, 2017.
- [ZTA17] M. Zamani, I. Tkachev, and A. Abate. Towards scalable synthesis of stochastic control systems. *Discrete Event Dynamic Systems*, 27(2):341–369, 2017.

¹INSTITUTE FOR DYNAMIC SYSTEMS AND CONTROL, ETH ZURICH, SWITZERLAND

Email address: `alavaei@ethz.ch`

²SCHOOL OF COMPUTING, NEWCASTLE UNIVERSITY, UNITED KINGDOM

Email address: `Sadegh.Soudjani@newcastle.ac.uk`

³DEPARTMENT OF COMPUTER SCIENCE, UNIVERSITY OF OXFORD, UNITED KINGDOM

Email address: `aabate@cs.ox.ac.uk`

⁴DEPARTMENT OF COMPUTER SCIENCE, UNIVERSITY OF COLORADO BOULDER, USA

⁵DEPARTMENT OF COMPUTER SCIENCE, LMU MUNICH, GERMANY

Email address: `majid.zamani@colorado.edu`