

COVID19-HPSMP: COVID-19 Adopted Hybrid and Parallel Deep Information Fusion Framework for Stock Price Movement Prediction

Farnoush Ronaghi†, Mohammad Salimibeni†, Farnoosh Naderkhani†, and Arash Mohammadi†

†Concordia Institute for Information Systems Engineering, Concordia University,

Emails: {f-ronagh, m_alimib}@encs.concordia.ca; {farnoosh.naderkhani, arash.mohammadi}@concordia.ca

Corresponding Author: Arash Moohammadi; Email: arash.mohammadi@concordia.ca; Tel: (+1) 514-848-2424 Ext. 2712; Address: 1455 De Maisonneuve Blv. W., EV-009.187, Montreal, QC, Canada, H3G-1M8.

Abstract

The novel of coronavirus (COVID-19) has suddenly and abruptly changed the world as we knew at the start of the 3rd decade of the 21st century. Particularly, COVID-19 pandemic has negatively affected financial econometrics and stock markets across the globe. Artificial Intelligence (AI) and Machine Learning (ML)-based prediction models, especially Deep Neural Network (DNN) architectures, have the potential to act as a key enabling factor to reduce the adverse effects of the COVID-19 pandemic and future possible ones on financial markets. In this regard, first, a unique COVID-19 related PRIce MOvement prediction (COVID19 PRIMO) dataset is introduced in this paper, which incorporates effects of social media trends related to COVID-19 on stock market price movements. Afterwards, a novel hybrid and parallel DNN-based framework is proposed that integrates different and diversified learning architectures. Referred to as the COVID-19 adopted Hybrid and Parallel deep fusion framework for Stock price Movement Prediction (COVID19-HPSMP), innovative fusion strategies are used to combine scattered social media news related to COVID-19 with historical mark data. The proposed COVID19-HPSMP consists of two parallel paths (hence hybrid), one based on Convolutional Neural Network (CNN) with Local/Global Attention modules, and one integrated CNN and Bi-directional Long Short term Memory (BLSTM) path. The two parallel paths are followed by a multilayer fusion layer acting as a fusion centre that combines localized features. Performance evaluations are performed based on the introduced COVID19 PRIMO dataset illustrating superior performance of the proposed framework.

Keywords: COVID-19 Pandemic, Deep Neural Networks, Hybrid Models, Information Fusion, Stock Movement Prediction.

1. Introduction

The novel of coronavirus (COVID-19) has suddenly and abruptly changed the world as we knew at the end of the 2nd decade of the 21st century. The global COVID-19 pandemic caused market volatility (Mazur et al., 2020; Baek et al., 2020) rocketing upward around the world. In particular, the pandemic has negatively triggered several sectors including but not limited to stock markets, global supply chains, labor markets, and consumption behaviors. Disruptions of such sectors, especially the stock markets (Bustos & Pomares-Quimbaya, 2020; Al-Awadhi et al., 2020; Saleh Ahmar & Boj del Val, 2020), can adversely affect the global economy. The United States volatility levels in the mid-March of 2020 are similar to those last seen during October 1987; after 1929 to 1939, and; during in 2008. In September 2008, the Dow Jones Industrial Average fell 777.68 points in intraday trading. During the recent pandemic, in the latter part of March 2020, volatility began to retreat and, by late April, fell sharply but remained well above pre-pandemic levels. It is expected that the emerging markets, the ones with restricted resources to cope with negative impacts of the COVID-19, more substantially feel the COVID-19 pressure due to having slower economic growth and not having sufficient capital inflows. In these sad and unfortunate pandemic times, Artificial Intelligence (AI) and Machine Learning (ML)-based (Radojicic & Kredatus, 2020; Rezaei et al., 2020; Hoseinzade & Haratizadeh, 2019; Chong et al., 2019; Seong & Nam, 2021; Zhang et al., 2020) stock market movement prediction solutions can potentially prevent the pandemic crisis that negatively affecting the market across the world causing unexpected havocs.

Literature Review: Stock market movement prediction is a key and challenging problem in financial econometrics as such has attracted extensive recent research focus (Frankel, 1995; Ronaghi et al., 2017; Mohammadi et al., 2017; Edwards et al., 2007; Bollen & H. Mao, 2011; Jiang, 2020; Hu et al., 2019; Koshiyama et al., 2020; Schumaker & Chen, 2009). It is widely acknowledged that investors need high-quality data to make informed and accurate decisions. Particularly, in times of market crisis, specifically during the recent COVID-19 pandemic, investors need advanced Big-Data Analytic and Information Technologies to acquire timely and accurate data. Using high-quality data, investors can perform fast analysis and decision making in the market volatility and react quickly to the fast changing conditions. Any positive or negative news related to the stock market crisis can have a ripple effect on the investors' decision-making process within the stock markets. During the pandemic area, typically, stock movement prediction becomes significantly challenging

as stock markets tend to face high fluctuations. Consequently, it is of paramount importance to develop innovative and advanced processing and learning solutions to accurately predict stock movements for achieving maximum potential profit. This has resulted in a recent surge of interest in ML/AI-based prediction techniques (Hu et al., 2019; Anik et al., 2019) and fusion of multi-modal information sources. In the context of stock price movement prediction, historical stock prices are typically fused with information obtained from media news. For the latter, in addition to the conventional news platforms, recently, extensive interest is shown towards utilization of Internet-based news resources, such as social media for development of ML/AI predictive models. The manuscript focuses on this topic and examines the role of COVID-19 related social media news on behavior of Dow Jones market.

Recent advancements and developments in the field of ML and AI, in particular, Deep Neural Networks (DNNs), have motivated different research works to incorporate such advanced modeling techniques for prediction and forecasting tasks in stock markets (Tetlock, 2007). DNN-based solutions are data-driven techniques that learn the underlying dynamics of the stock price movements through processing of a large amount of data. DNN-based methodologies are, typically, data hungry and will not perform well in absence of a large and diversified set of data resources. Availability of public news media, Internet-based news channels, and social media can pave the way to better train DNN models and further increase utilization of AI within stock markets. This research field, however, is still in its infancy due to its high dependence on the reliability and quality of the information available through Internet-based news channels and social media resources (Hu et al., 2019). Furthermore, such data sources can not be directly used for prediction tasks (Luss & D'Aspremont, 2015) due to the highly correlated nature of stock market price movements. To tackle the aforementioned issues, there is an unmet and timely quest to develop and design: (i) Hybrid processing/learning models based on different and diversified learning architectures to capture underlying correlations and variabilities of the data sources, and; (ii) Smart fusion strategies to combine scattered social media news with historical mark data. The paper aims to take the first step towards addressing this gap.

Contributions: The main objective of the proposed DNN-based predictive model is to construct a new information fusion framework to analyses and interpret ever-changing trends during the COVID-19 pandemic area. In this regard, first, a unique and real COVID-19 related PRIce MOve-

ment prediction (COVID19 PRIMO) dataset (Ronaghi et al.)¹” is constructed to incorporate effects of internet-based and social media trends related to COVID-19 on stock market price movements. The main component of the constructed COVID19 PRIMO dataset is based on Twitter messages. It is well known that news and media move stock prices (Fama, 1998; Huang & Li, 2020; Yun et al., 2019). Nowadays, information reaches out to the public via different news platforms ranging from newspaper, radio and television to social media and Internet-based venues. In this area, social media, especially Twitter, is a popular and widely used platform to share personalized opinion on different topics. Twitter is also used extensively by politicians who potentially have high impact on stock price movements. Based on a survey on Statista (Clement, 2020), from the first quarter of 2017 to 2020, Twitter had 186 million active users worldwide.

Based on the constructed COVID19 PRIMO dataset, the paper proposes a data-driven (DNN-based) COVID-19 adopted Hybrid and Parallel deep fusion framework for Stock price Movement Prediction (COVID19-HPSMP) that uses information fusion to combine COVID-19 related Twitter data with extended horizon market historical data. More specifically, in contrary to the existing data-driven movement prediction models, where a single DL model is used (Ronaghi et al., 2017), the proposed COVID19-HPSMP is a hybrid framework with two parallel paths, i.e., one based on Convolutional Neural Network (CNN) with Local/Global Attention modules, and one integrated CNN and Bi-directional Long Short term Memory (BLSTM). The former path is incorporated within the COVID19-HPSMP framework to extract temporal features, while the latter path is used to extract spatial features. The two parallel paths are followed by a multilayer fusion layer acting as a fusion centre that combines localized features extracted in each of the two parallel paths. The COVID19 PRIMO dataset is used to evaluate the performance of the proposed COVID19-HPSMP framework, which illustrates its superior performance compared to its stand-alone (non-hybrid) counterparts.

The remainder of the paper is organized as follows: Section 2 introduces the COVID19 PRIMO dataset and formulates the stock movement prediction task. The COVID19-HPSMP hybrid framework is presented in Section 3. The implementation study and results are presented in Section 4. Finally, Section 5 concludes the paper.

¹The COVID19 PRIMO dataset is accessible through the following page:
https://github.com/MSBeni/COVID19_PRIMO#COVID19-PRIMO.

2. Problem Definition and COVID19 PRIMO

In this section, first, the COVID19 PRIMO dataset is introduced, which is constructed based on the Dow Jones stock market index and its associated Twitter messages for the period of 01/01/2016 to 30/07/2020. The focus is on the problem of stock price movement prediction as close observation of market movements can reveal presence of a significant amount of trading targets with minor movement ratios. More specifically, the paper focuses on investigating effects of COVID-19 pandemic on stock price movement prediction. In this paper, stock movement prediction is modeled as a two-class classification problem based on the adjusted closing price of the underlying stocks. The adjusted closing price is commonly utilized to compute the associated stock dividends and earnings (Xie et al., 2013). Furthermore, the adjusted closing price is beneficial to learn and predict fluctuations in the stock market (Li et al., 2014; Rekabsaz & et al., 2017).

We have prepared a new dataset for the aforementioned prediction problem, which can facilitate analysis and evaluation of potential impacts of a pandemic on stock market and can provide priceless insights to combat future possible pandemic. The constructed COVID19 PRIMO dataset consists of two components, i.e., historical prices and Twitter messages. The first component, historical data, is obtained from Dow Jones stock market. With the ticker of DJI. Dow Jones is a stock market index that measures the performance of 30 large companies like Apple, Boeing, and Microsoft. Historical stock market prices are obtained from the Yahoo finance. For this task, we used the Yahoo finance library in Python² to collect the data from the Yahoo API. For some of the stocks, we also used Alpha Vantage APIs³. The data is prepared based on three different temporal resolutions, i.e., daily; weekly, and; monthly. The daily prices are used in our model described later for the task of stock movement prediction.

Capitalizing on the facts identified in Section 1, for the news component of the COVID-19 price movement prediction dataset, we focused on Twitter. Fig. 1 shows the block diagram of the approach followed to collect and analyze Twitter messages. Web scraping from the Twitter search engine is utilized to build the Twitter dataset. The official API of the Twitter has some limitations that restricts the extent of text that can be extracted. Additionally, the official API of the Twitter cuts the tweets at times, which in turn results in items with missing data. We have developed a

²[http:https://pypi.org/project/yahoo-finance/](https://pypi.org/project/yahoo-finance/)

³[http:https://pypi.org/project/alpha-vantage/](https://pypi.org/project/alpha-vantage/)

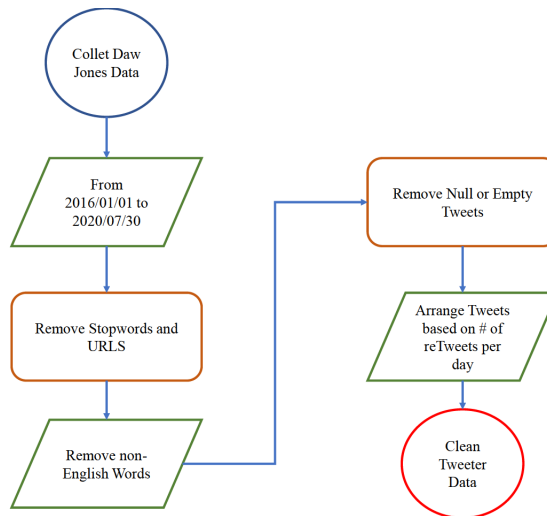

Figure 1: Block diagram of the procedure designed to collect and prepare Tweet component of the COVID19 PRIMO.

localized API to address the aforementioned issues. The localized API uses Twitter search engine and directly collects the required dataset from Twitter. We set up our data collection platform based on scraping the twitter website. The twitter web scraping returns the Tweet text content with a range of useful attributes, for example, *Tweet – ID*, *Tweet Created at*, *Retweet*, *Text*, *Favorite Count*, *Hashtag Text*, *User ID*, *Followers Count*, *Friends Count*, *Statuses Count*, *User Created at*, and *Location*. To collect informative public Tweets, we added a constraint to our implementation to collect tweets retweeted more than once. Many other unnecessary attributes regarding a tweet were also removed from the data gathering session to focus on the essential information such as date, tweet text, and number of retweets. Fig. 2 illustrates an illustrative example of raw tweets collected by web scraping.

A critical challenge is scraping the raw content of Twitter data. Such a process takes extensive time and needs manual and cumbersome pre-processing procedures. We retrieved Dow Jones and *COVID – 19* tweets by querying symbols *\$DJI*, *#DOW*, *Covid19*, *#Covid19*, *#Covid – 19* and *CoronaVirus*. Additionally, the corresponding data associated with historical prices are collected. The constructed dataset includes related tweets from 01/01/2016 to 30/07/2020 for the Dow Jones stock index. Not every day is considered as a trading day, i.e., weekends and holidays are not among the trading dates and ought to be out of the analysis scope. To better organize and use the input, we subtract the number of days in a year from the number of weekends, the

Date	Tweets
2019-12-29	All the markets are going mad pump right now. Do you think it's normal not to pump Crypto? \$ dji \$ xau \$ btc
2020-01-23	\$ SPY \$ DJI - MArket perking up. Did the coronavirus get cured?
2020-04-18	Markets trust @realDonaldTrump White House response to coronavirus plague #coronavirus #COVID #COVID19 #POTUS
2020-05-18	Wall Street rises amid hopes of a Covid-19 Vaccine. The Dow Jones, US30 Index is now up 3.64% for the day and possibly aiming higher. Analysis by @analystphil \$ DJI
2020-07-24	Will be covering over the weekend #video the outlook for the #trend in #StockMarket for #futures #stocks #forex #Commodities #gold #CrudeOil #btc \$ spx \$ ndx \$ dji \$ rut #es_f 3203.25 C #nq_f 10457.75 C \$ gc_f \$ cl_f #algorithm #AI #TRADERS #enjoy #weekend be safe #Covid_19

Figure 2: Illustrative raw Tweets samples in the COVID19 PRIMO datatest before the pre-processing step.

number of half trading days, and the number of market holidays. More specifically, our dataframe is created by combining historical prices and Tweet corpora and matching them to the trading days. Consequently, we considered 1,152 trading days from January 2016 to July 2020 to build our dataset. The COVID19 PRIMO dataset is then divided into a training set from January 2016 to January 2020, and a validation set from January 2020 to February 2020. Data from 01/03/2020 to 30/07/2020 is kept to be used for test purposes.

2.1. Data Visualization

In this sub-section, we visualize the existing relations between different parameters of the COVID19 PRIMO dataste, particularly that of COVID-19 tweets with other parameters. As stated above, the introduced dataset is constructed based on the Dow Jones stock market index and its associated Twitter messages for the period of 01/01/2016 to 30/07/2020. The COVID-19 pandemic crisis covers a fraction of the data represented in the COVID19 PRIMO dataset but plays an essential role in predicting the pandemic's effects on the stock market movements. The COVID-19 related tweets appeared in 2020 (from February to July), specifically starting to show up from the end of February. The dates containing the COVID-19 are stamped with True, making it possible to consider its distribution in the whole frame. Fig. 3 visualizes different aspects of the COVID19 PRIMO dataset and illustrates relation of COVID-19 with other parameters of the dataset. Violin plot is shown in Fig. 3(a), where the distribution of COVID-19 tweets and the market movements are illustrated. As shown in Fig. 3(b), the COVID-19 tweets are less than 200 days, which is expected

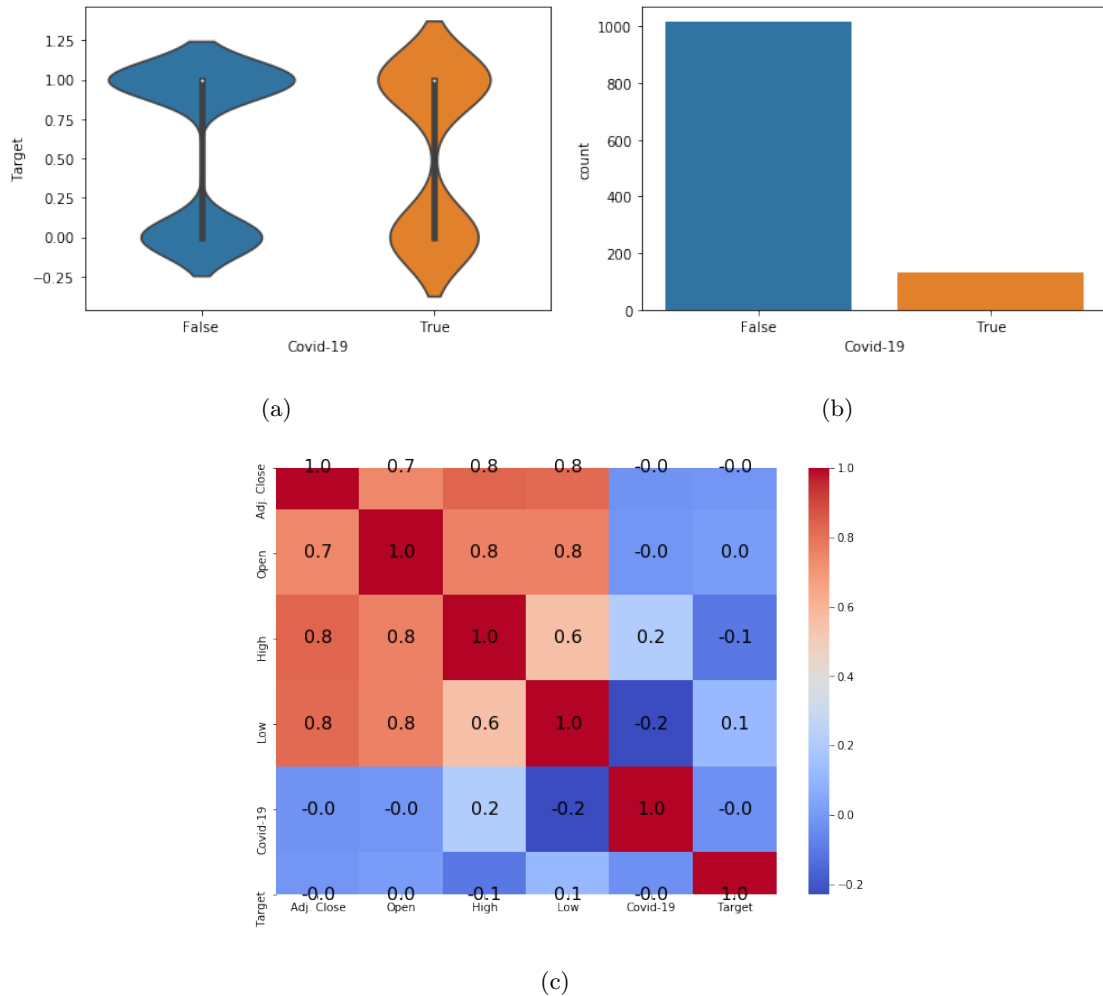

Figure 3: (a) The Distribution of The COVID-19 Tweets and Target. (b) The Number of COVID-19 Tweets. (c) Correlation matrix between different variables.

given the recent emergence of the pandemic. Fig. 3(c) shows the correlation between several different variables affecting the COVID19 PRIMO dataset. Market prices, including Adjusted close price (Adj. Close); Open price (Open); High price (High); Low price (Low); calculated target (Target), and; Presence of COVID-19 in tweets are depicted in this figure. For example, the correlation between normalized adjusted close price and normalized high price is 0.83. Finally, Fig. 4 is a grid of scatter plot used to visualize bivariate relationships between combinations of variables. Fig. 4 is included to have a big picture of the distribution of the data and better understand existing relations between different parameters in the dataset. Fig. 4 shows the relationship for a different combination of variables in a DataFrame as a matrix of plots. The orange dots, show the COVID-

19 related data in the dataset, while the blue dots, represent the lack of COVID-19 related data. Fig. 4 can potentially depict the bivariate relationships between different market price data and COVID-19 together with the relation between the Target recognized in this period of time with the pandemic data.

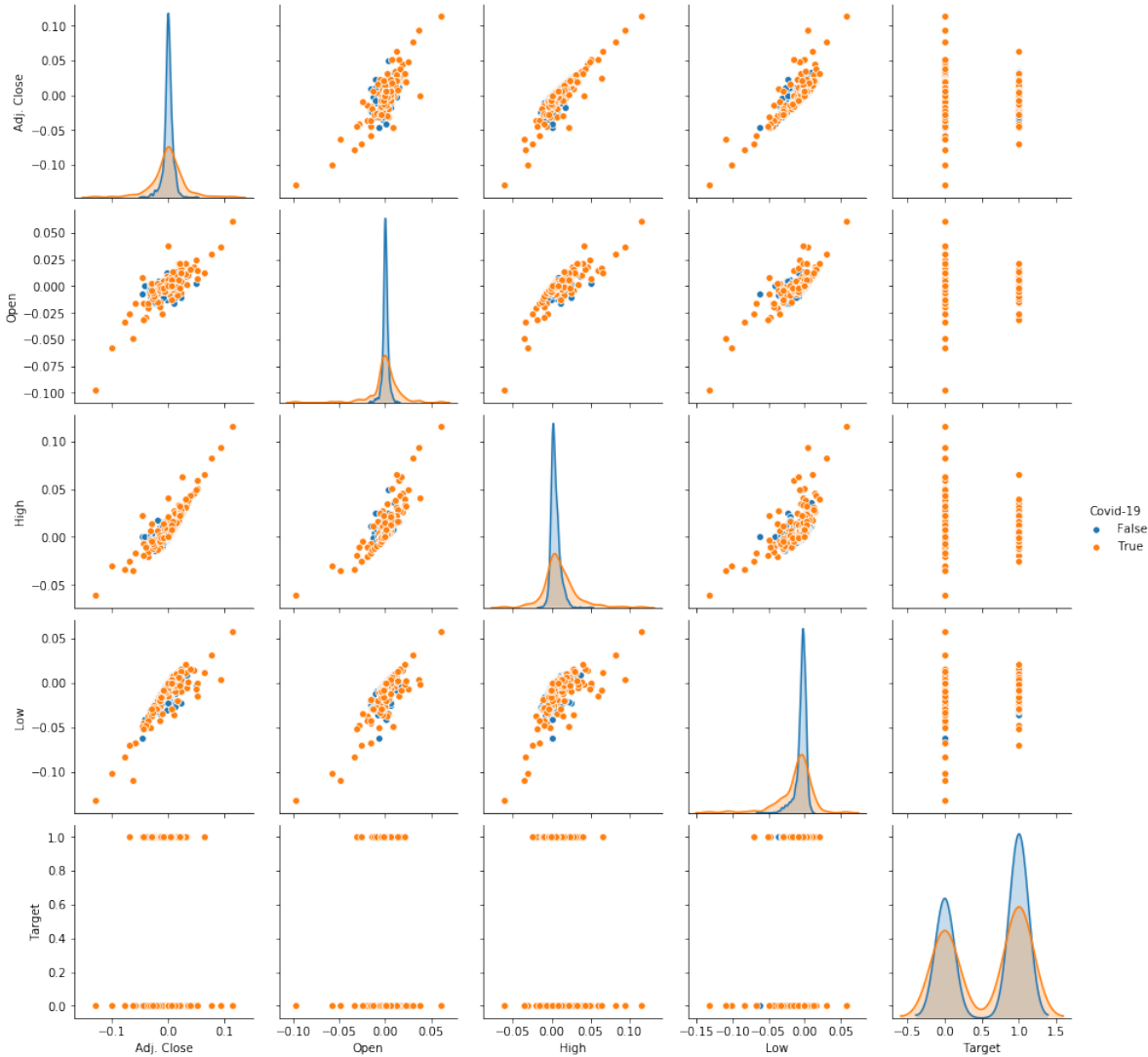

Figure 4: Grid of scatter plots. The orange dots show COVID-19 related data points, while the blue dots represent lack of COVID-19 related data.

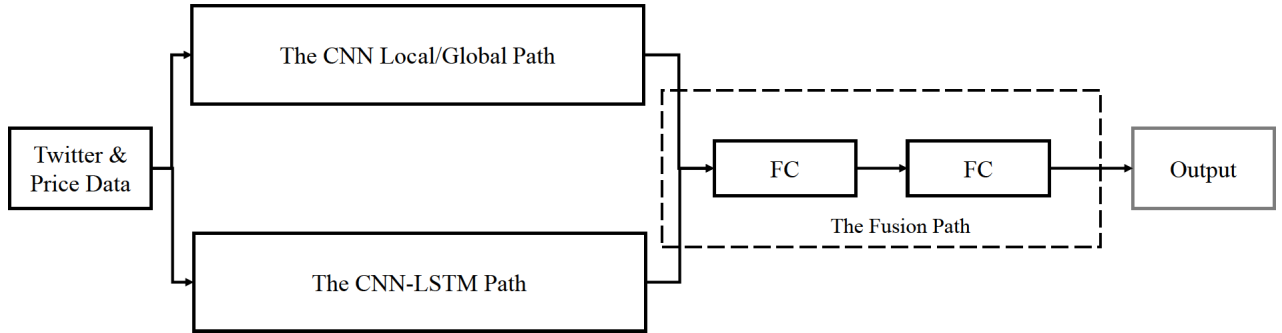

Figure 5: The proposed COVID19-HPSMP framework.

3. Proposed COVID19-HPSMP Framework

In this section, we describe the constituent components used in the development of the proposed COVID19-HPSMP framework. As stated previously, the main architecture of the COVID19-HPSMP is developed based on DNNs. The prominent advantage of DNNs is their ability to extract meaningful patterns from raw data through multiple non-linear transformations and approximation of complex non-linear functions (Al-Dulaimi et al., 2019). More specifically, the proposed COVID19-HPSMP is a data-driven (deep learning model) designed based on hybrid or multiple-model strategies. The COVID19-HPSMP framework extracts and interprets the available news corpus via temporal attention modeling based two key principles, i.e., “Diverse Influence” and “Sequential Context Dependency”. To achieve these objectives, the COVID19-HPSMP is designed as a hybrid multi-modal fusion framework that integrates information obtained from stock market historical data and social media (Twitter data). The proposed hybrid framework consists of three paths, two parallel paths, i.e., the CNN Local/Glocal path, and; the CNN-LSTM path, together with a fusion path. Fig. 5 illustrates the overall structure of the proposed framework. The fusion path composed of fully connected layers that combine extracted features from each of the two parallel paths. Each of the two parallel paths within the COVID19-HPSMP framework are constructed based on the following two main components:

- (i) *Word Embedding Module*: This module is used to calculate embedded vectors for Twitter data. For this purpose, Glove (Pennington et al., 2014), as a pre-trained unsupervised model, is used within the word embedding module of each of the two parallel paths within the proposed COVID19-HPSMP framework.

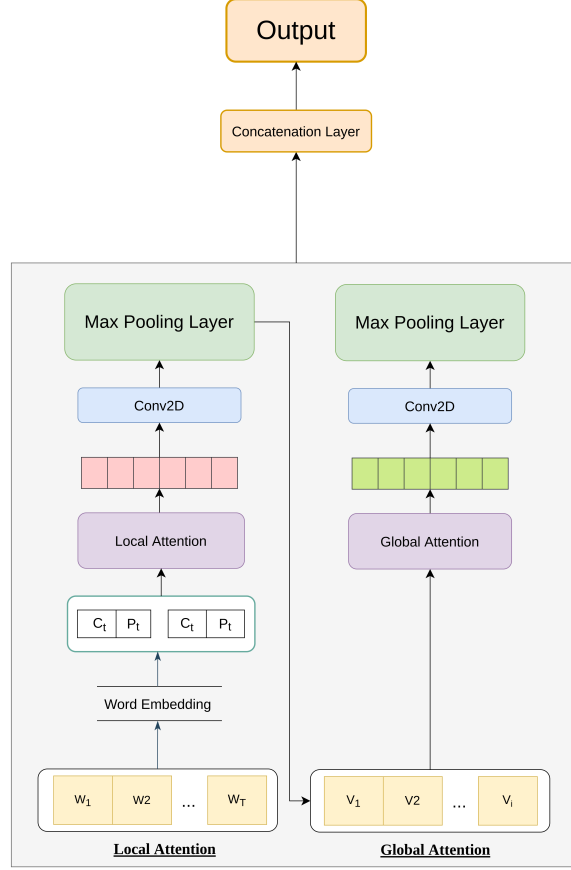

Figure 6: The CNN Local/Global path of the COVID19-HPSMP framework.

- (ii) *Attention Module*: The main objective of this module is to extract specific words with highest attention weight. The COVID19-HPSMP is a hybrid model where each of the two parallel paths (i.e., the CNN Local/Global path, and; the CNN-LSTM path) is a unique attention module extracting different related features. The rationale behind such a hybrid and parallel structure is the significance of the attention network and the intuition that extracting different attention-related features would improve the overall performance of the model.

In what follows, we present each of the three constituent paths of the proposed COVID19-HPSMP framework.

3.1. The CNN Local/Global Path

The first parallel path of the proposed COVID19-HPSMP framework is a CNN-based local/global attention model designed to capture and extract spatial features from the input data.

More specifically, the CNN-based path consists of Local and Global attention layers, which are described in details below.

3.1.1. Local Attention Layer (LAL)

Intuitively speaking, a word embedding model produces representations for each word in the Twitter corpus. Let us denote the l^{th} Tweet among the available set of N_T Tweets with $\mathcal{T}^{(l)}$, for $(1 \leq l \leq N_T)$. Furthermore, consider that Tweet $\mathcal{T}^{(l)}$ contains $N_W^{(l)}$ number of words. The embedding can be thought of as a linear operator (function) that takes as an input a one-hot vector $\mathbf{e}_i^{(l)} \in \mathbb{R}^{N_W}$ corresponding to the i^{th} word of Tweet $\mathcal{T}^{(l)}$, for $(1 \leq i \leq N_W^{(l)})$. Note that, here N_W denotes the number of words in the overall vocabulary. The embedding then maps the one-hot vector into a dense feature vector $\mathbf{x}_i^{(l)} = [x_{i,1}^{(l)}, \dots, x_{i,N_F}^{(l)}]^T \in \mathbb{R}^{N_F}$, which consists of N_F scalar features for the i^{th} word of the l^{th} Tweet within the Twitter corpus. The feature vector $\mathbf{x}_i^{(l)}$ is obtained based on a trainable weighting matrix (to be learned) of the embedding layer as follows

$$\mathbf{x}_i^{(l)} = \mathbf{W}^{(Emb)} \mathbf{e}_i^{(l)}. \quad (1)$$

The embedding layer's output together with price values are provided as a concatenated input to the Local Attention Layer (LAL). The LAL focuses on the words, which are more informative within a localized window. More specifically, let the l^{th} Tweet be represented by $N_W^{(l)}$ word embedding as $(\mathbf{x}_1^{(l)}, \dots, \mathbf{x}_m^{(l)}, \dots, \mathbf{x}_{N_W^{(l)}}^{(l)})$, where $\mathbf{x}_m^{(l)}$ is the middle (center) word within the embedding sequence of the l^{th} Tweet. Local attention process is achieved via a sliding window of length W rolling over the word embedding sequence of $\mathcal{T}^{(l)}$. Attention score $s_i^{(l)}$ for the i^{th} word of $\mathcal{T}^{(l)}$ is computed based on an attention weighting score $\mathbf{W}_i^{(l,LA)} \in \mathbb{R}^{W \times N_F}$, for $(1 \leq i \leq N_W^{(l)})$, and its associated bias vector $\mathbf{b}_i^{(l,LA)}$ as follows

$$s_i^{(l,LA)} = \sigma \left(\mathbf{X}_i^{(l,LA)} \circ \mathbf{W}_i^{(l,LA)} + \mathbf{b}_i^{(l,LA)} \right), \quad (2)$$

where \circ denotes the Hadamard product (element-wise multiplication), $\sigma \cdot$ is the sigmoid activation function, and

$$\mathbf{X}_i^{(l,LA)} \triangleq [\mathbf{x}_{m+\frac{-W+1}{2}}^{(l)}, \dots, \mathbf{x}_i^{(l)}, \dots, \mathbf{x}_{m+\frac{W+1}{2}}^{(l)}]^T, \quad (3)$$

where superscript T denotes transpose operator. The attention score $s_i^{(l)}$ is used as a weight for the words to form localized word embedding as follows $\hat{\mathbf{x}}_i^{(l,LA)} = s_i^{(l,LA)} \mathbf{x}_i^{(l)}$. A higher attention

score can be interpreted as higher importance associated with that specific word than the others. The weighted sequences then go through a Convolutional layer with a kernel size of 15, which is designed to avoid overfitting. A Max-Pooling layer is then implemented after the convolution one to create position invariance over larger local regions and down-sample the input. Addition of the Max-Pooling layer also leads to a faster convergence rate by selecting superior invariant features, which in turn improves generalization performance.

3.1.2. Global Attention Layer (GAL)

The output of the LAL is provided as input to a Global Attention layer (GAL). This scoring process of the GAL is similar in nature to that of the LAL (Eqs. (2)-(3)). However, the attention score, now denoted by $s_i^{(l,G A)}$, is computed through the entire input, i.e.,

$$s_i^{(l,G A)} = \sigma\left(\mathbf{X}^{(l,G A)} \circ \mathbf{W}_i^{(l,G A)} + \mathbf{b}_i^{(l,G A)}\right), \quad (4)$$

where $\mathbf{W}_i^{(l,G A)} \in \mathbb{R}^{N_W^{(l)} \times N_F}$, and

$$\mathbf{X}^{(G,Att)} \triangleq [\mathbf{x}_1, \dots, \mathbf{x}_{N_W^{(l)}}]^T. \quad (5)$$

By applying global attention, the effect of uninformative words will be diminished, and the global semantic meaning will be captured more precisely through the CNN path. This completes description of the CNN Local/Global path of the proposed COVID19-HPSMP *framework*. Next, we present the CNN-BLSTM path.

3.2. CNN-LSTM Attention based Model

The second parallel path of the proposed COVID19-HPSMP is a hybrid CNN and BLSTM attention model, referred to as the CNN-BLSTM path. Similar to the CNN Local/Global path, in the first step, the Twitter messages are provided as input to a ‘‘Word Embedding layer’’. As stated previously, a pre-trained unsupervised Glove model (Pennington et al., 2014) is used as the word embedding layer within the COVID19-HPSMP framework. Afterwards, the corpus and prices are encoded by a CNN layer to extract general contextual features. An attention layer is assigned across all the vectors to calculate the weighted corpus. At the next step, a second CNN layer is implemented to capture and learn more fine-tuned features. The first CNN layer has 50 number of filters with a window size of 25. The second CNN layer has 100 filters with a window

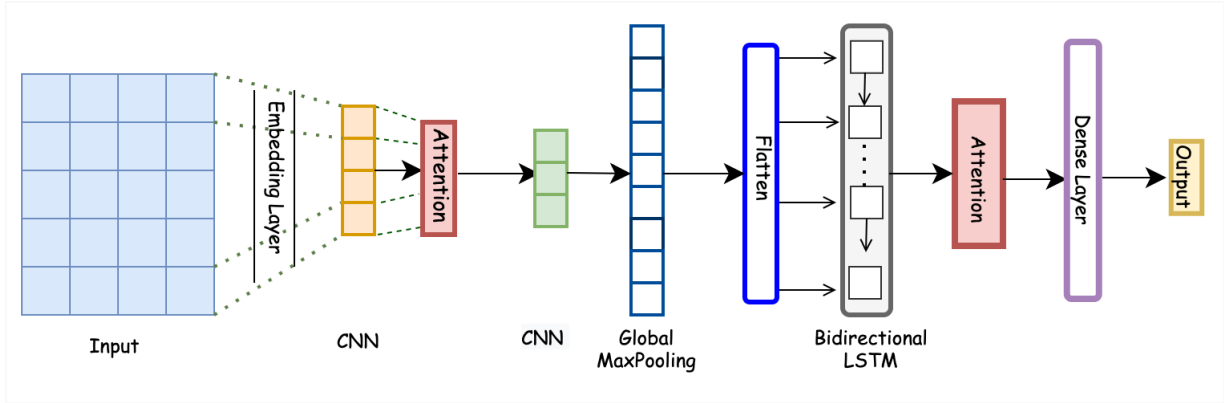

Figure 7: The CNN-LSTM path of the COVID19-HPSMP framework.

size of 25. The first Attention layer is used to capture essential and unique features to provide insight into the vector of the data including tweets and prices. The second Attention layer acts on each vector and calculates the weighted mean of these encoded corpus vectors to represent the overall sequential context information. A global Max-Pooling layer is then applied to capture the essential features and reduce the framework’s complexity. Global Max-Pooling is similar to the regular version but with pool size equals to the size of the input. At the next stage, an attention-based BLSTM layer is designed to remember what has previously learned to better understand the input. The attention-based BLSTM layer is described next.

3.2.1. Attention-based Bidirectional LSTM:

To encode temporal information based on the available set of news corpus and financial time-series data, BLSTM is incorporated within the COVID19-HPSMP hybrid framework. Learning based on financial time-series data is a sequence learning task for which BLSTMs are considered as the state-of-the-art DNN architectures. The LSTM architecture is initially developed by Hochreiter and Schmidhuber (Hochreiter & Schmidhuber, 1997) to address the vanishing and exploding gradient problem of conventional Recurrent Neural Networks (RNNs). Since then, LSTM models have gained significant popularity owing to their extensions, advancements and successful applications in different domains. Generally speaking, LSTM is a memory-based architecture that uses different gating functions and a memory state to manage process if information through time (Di et al.,

2018). LSTM works based on the following update model at each time step (denoted by t)

$$\mathbf{i}_t = \sigma(\mathbf{W}_i x_t + \mathbf{U}_i \mathbf{h}_{t-1} + \mathbf{b}_i) \quad (6)$$

$$\mathbf{f}_t = \sigma(\mathbf{W}_f x_t + \mathbf{U}_f \mathbf{h}_{t-1} + \mathbf{b}_f) \quad (7)$$

$$\mathbf{g}_t = \tanh(\mathbf{W}_c x_t + \mathbf{U}_c \mathbf{h}_{t-1} + \mathbf{b}_c) \quad (8)$$

$$\mathbf{c}_t = \mathbf{f}_t \circ \mathbf{c}_{t-1} + \mathbf{i}_t \odot \mathbf{g}_t \quad (9)$$

$$\mathbf{o}_t = \sigma(\mathbf{W}_o x_t + \mathbf{U}_o \mathbf{h}_{t-1} + \mathbf{b}_o) \quad (10)$$

$$\mathbf{h}_t = \mathbf{o}_t \circ \tanh(\mathbf{c}_t) \quad (11)$$

where \mathbf{W}_i , \mathbf{W}_o , \mathbf{W}_f , \mathbf{W}_c , and \mathbf{U}_i , \mathbf{U}_o , \mathbf{U}_f , \mathbf{U}_c are weight matrices; Terms \mathbf{b}_i , \mathbf{b}_o , \mathbf{b}_f , \mathbf{b}_c are bias vectors, and; $\tanh(\cdot)$ represents element-wise hyperbolic tangent activation function. Furthermore, \mathbf{h}_t and \mathbf{h}_{t-1} represent the current and previous hidden states, respectively. In the context of the proposed COVID19-HPSMP and to encode the temporal layer, we adopt Bidirectional version of the LSTM (BDLSTM) to feed the i^{th} word embedding. BLSTM can access both the preceding and succeeding contexts. It separates the hidden layer into two parts, forward state sequence and backward state sequence based on an iterative process.

3.3. Fusion Path

The final component of the proposed COVID19-HPSMP framework is the Fusion Path with three fully connected layers for fusing features extracted from each of the two underlying parallel paths and performing the final price movement prediction task. The first fusion layer has 100 number of neurons and uses “tan” activation function, while the second fusion layer has 50 number of neurons with the same activation function. The final layer of the Fusion Path, has 1 neuron and uses Rectified Linear Unit (ReLU) as its activation function to produce the price movement predictions. The input to the Fusion Path is constructed by concatenating the output of the CNN Local/Global path, which is a flattened 1-Dimensional feature vector, with that of the CNN-BLSTM path.

4. Experiments

Experimental results and comparisons are presented in this section to evaluate the proposed hybrid COVID19-HPSMP framework for the task of stock movement prediction. As stated previously, the problem at hand is a classification one with the following expected outputs: (i) On one

Table 1: Accuracy comparisons.

Model Variations	Accuracy
The COVID19-HPSMP Framework	66.48
Standalone CNN Local/Global Model	64.65
Standalone CNN-LSTM Model	62.06

hand, within a 5 days prediction horizon, if the adjusted stock price of a specific day is more than that of the previous day, the output of that specific day would be 1. Then, the sum of the output values is computed over the 5 days horizon and if the sum is greater than a pre-defined threshold of 3, we consider the final output for that 5 day horizon to be 1, denoting a rise, and; (ii) On the other hand, when the adjusted stock price associated with a specific day is less than its previous day, value 0 is assigned as the output of that specific day. When the number of such 0 output values within the 5 days window is more than 3, we consider the final output to be 0, representing the fall prediction/state.

4.1. COVID19-HPSMP LSTM-based hybrid attention Model

To perform the evaluations, the available Twitter news corpora is tokenized and words occurring less than 5 times are removed to construct the vocabulary. It is worth noting that removing words with limited usage will reduce the associated memory cost of the DNN models. As stated above, we consider a five day horizon and used a batch size of 64 within 15 epoch. In addition, Glove, which is an unsupervised word embedding algorithm, is used within the embedding modules of the two parallel paths of the COVID19-HPSMP. For comparison purposes, three different models are implemented as follows:

- (ii) *The proposed COVID19-HPSMP Framework*: The proposed hybrid COVID19-HPSMP framework developed in Section 3 is the first implemented stock movement prediction model. The COVID19-HPSMP consists of 2 parallel paths and a fusion path integrating extracted features of each of the two parallel paths.
- (ii) *Stand-Alone CNN Local/Global Model*: The second implemented movement prediction model is the CNN Local/Global path implemented independently (stand alone as a single model). To implement the stand alone version of the CNN Global/Local model, initialization is performed

following the guideline provided in Reference (Seo et al., 2017). A pre-trained Glove (Pennington et al., 2014) is used for weighting corpus within the word embedding layer. In the LAL, we use window of size 5 with a sigmoid function (σ). Total of 80 filters are implemented within the LAL. In the GAL, we used 50 filters of length 2 and 3. Finally, a fully connected layer with 0.5 dropout is designed to form the output.

- (iii) *Stand-Alone CNN-BLSTM Model*: The third implemented movement prediction model is the CNN-BLSTM path implemented independently as a single model. Similar to the stand-alone CNN Global/Local model, a pre-trained Glove (Pennington et al., 2014) is used for weighting corpus within the embedding layer. A convolutional layer with a 64 number of filters and a window size of 25 is followed by an attention layer. To extract essential features and reduce the framework’s complexity, a max-pooling layer is designed. The output of max-pooling layer is the input of next layer which is attention-based Bidirectional LSTM with 250 hidden layers. Finally, two fully connected layers are considered with 300 and 1 number of hidden neurons, respectively, to form the price movement prediction results.

These three implemented models are trained with Adam optimizer (Kingma & Ba, 2014) with a learning rate of 0.001. To reduce the training times of the implemented models, Batch Normalization (Ioffe & Szegedy, 2015) is utilized to normalize the underlying layers. Furthermore, to avoid overfitting issues and improve the overall robustness of the implementations, 0.5 dropout is used within the fully connected layers. Finally, the computational graphs of the implemented models are constructed via Tensorflow (Abadi & et al., 2016) to fine tune different hyper-parameters.

4.2. Performance Evaluation/Results

In this sub-section, we represent different experimental results to evaluate the performance of the proposed COVID19-HPSMP framework for the stock movement prediction. The accuracy of the proposed models areas follows: 64.65% for the stand-alone CNN-based local/global; 62.06% for the stand-alone CNN-LSTM, and 66.48% for the hybrid attention model, i.e., the COVID19-HPSMP framework. The accuracy of all three implemented models are shown in Fig. 8(a). The accuracy is a fraction of correct predictions to the total number of predictions. The loss function associated with the evaluated models is illustrated Fig. 8(b). Loss function demonstrates the distinction between the output of the model and the target value in order to show the probability of misclassification.

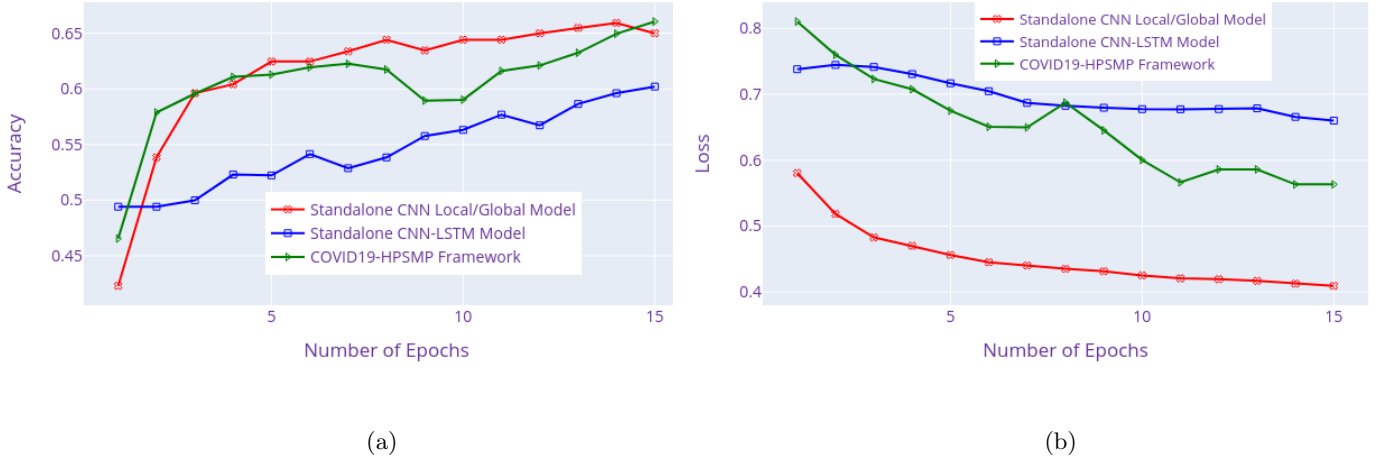

Figure 8: (a) Accuracy of the Models. (b) Loss of the Models.

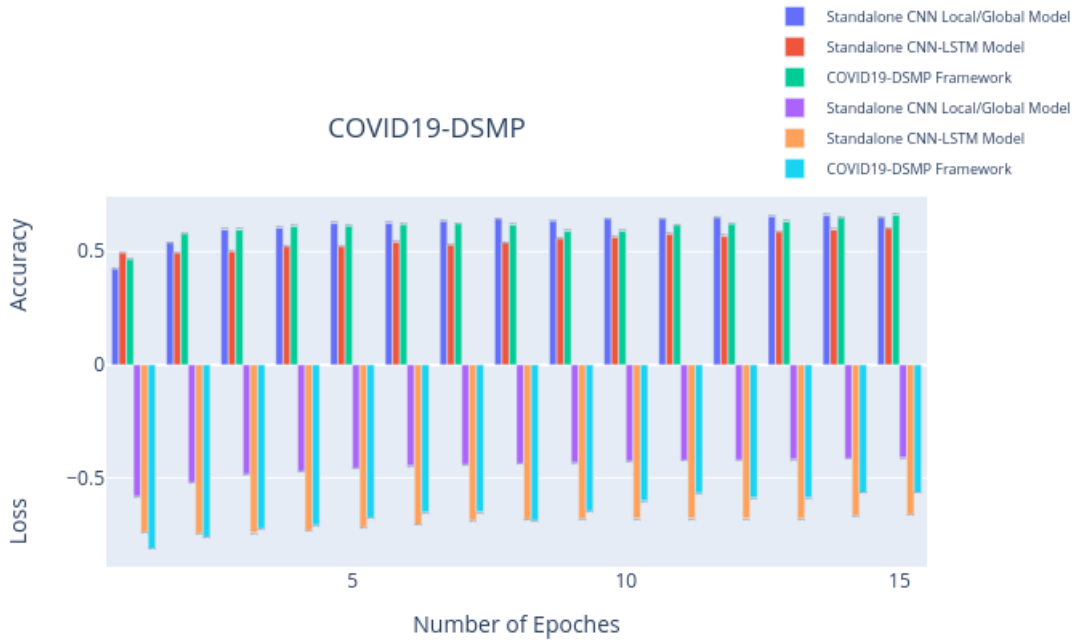

Figure 9: Accuracy and loss contrast of the different price movement prediction models.

We demonstrate the performance of the baseline models in Table 1 comparing performance of the three implemented models. As it can be observed, the hybrid model (the COVID19-HPSMP) outperforms its counterparts. It is worth mentioning that the achieved accuracy of 66.48% is significant, although in absolute terms it seems to be low. First, please note that average accuracies

achieved in the literature for the task of price movement prediction is around 50%. Second, these lower accuracies are obtained based on a much wider window of information compared to the limited duration of the introduced COVID19 PRIMO dataset. The limited duration of the dataset is due to recent emergence of the COVID-19 pandemic.

5. Conclusion

Motivated by abrupt, sudden, and negative effects of COVID-19 pandemic on stock markets, first, the paper introduced a unique COVID-19 related PRIce MOvement prediction (COVID19 PRIMO) dataset. The constructed dataset incorporates effects of social media trends related to COVID-19 on stock market price movements. Based on the constructed COVID19 PRIMO dataset, the paper then proposed a novel data-driven (DNN-based) COVID-19 adopted Hybrid and Parallel deep fusion framework for Stock price Movement Prediction (COVID19-HPSMP). The proposed framework uses information fusion to combine COVID-19 related Twitter data with extended horizon market historical data. More specifically, in contrary to the existing data-driven stock price movement prediction models, where a single DNN model is used, the COVID19-HPSMP framework is a hybrid model consisting of two parallel paths (i.e., the CNN Local/Glocal path, and; the CNN-LSTM path) and a fusion path that combines localized features. Each of the two parallel paths is a unique attention module extracting different attention related features. The rationale behind such a hybrid and parallel structure is the significance of the attention network and the intuition that extracting different attention-related features would improve the overall performance of the model. The proposed COVID19-HPSMP architecture can predict the stock price movements during the pandemic crisis to forecast sudden sharp movements (fall or rise) in the stock market. Based on the results of the COVID19-HPSMP architecture, we can predict the stock market's fluctuations with more than 66% accuracy, which will hopefully be a metric to be more prepared for the unexpected havocs.

References

- Abadi, M., & *et al.* (2016). Tensorflow: Large-scale machine learning on heterogeneous distributed systems. ArXiv:1603.04467.
- Al-Awadhi, A., Alsaifi, K., Al-Awadhi, A., & Alhammadi, S. (2020). Death and contagious infectious diseases: Impact of the covid-19 virus on stock market returns. *Journal of Behavioral and Experimental Finance*.

- Al-Dulaimi, A., Zabihi, S., Asif, A., & Mohammadi, A. (2019). A multimodal and hybrid deep neural network model for remaining useful life estimation. *Computers in Industry*, *108*, 186–196.
- Anik, M., Arefin, M., & Dewan, M. (2019). An intelligent technique for stock market prediction. *International Joint Conference on Computational Intelligence. Algorithms for Intelligent Systems*.
- Baek, S., Mohanty, S., & Glambosky, M. (2020). Covid-19 and stock market volatility: An industry level analysis. *Finance Research Letters*.
- Bollen, J., & H. Mao, H. (2011). Twitter mood as a stock market predictor. *Computer*, *44*, 91–94.
- Bustos, O., & Pomares-Quimbaya, A. (2020). Stock market movement forecast: A systematic review. *Expert Systems with Applications*, *156*.
- Chong, E., Han, C., & Park, F. (2019). Deep learning networks for stock market analysis and prediction: Methodology, data representations, and case studies. *Expert Systems with Applications*, *83*.
- Clement, J. (2020). Number of monetizable daily active twitter users (mdau) worldwide from 1st quarter 2017 to 1st quarter 2020. <https://www.statista.com/statistics/970920/monetizable-daily-active-twitter-users-worldwide/>.
- Di, W., Bhardwaj, A., & Wei, J. (2018). *Deep Learning Essentials: your Hands-on Guide to the Fundamentals of Deep Learning and Neural Network Modeling*. Packt Publishing - ebooks Account.
- Edwards, R., Bassetti, W., & Magee, J. (2007). *Technical Analysis of Stock Trends*. CRC Press.
- Fama, E. (1998). Market efficiency, long-term returns, and behavioral finance. *Journal of Financial Economics*, (pp. 283–306).
- Frankel, J. (1995). *Financial Markets And Monetary Policy*. MIT Press.
- Hochreiter, S., & Schmidhuber, J. (1997). Long short-term memory. *Neural Computation*, *9*, 1735–1780.
- Hoseinzade, E., & Haratizadeh, S. (2019). Cnnpred: Cnn-based stock market prediction using a diverse set of variables. *Expert Systems with Applications*, *129*.
- Hu, Z., Liu, W., Bian, J., & Liu, X. (2019). Listening to chaotic whispers: A deep learning framework for news-oriented stock trend prediction. *ACM International Conference on Web Search and Data Mining*.
- Huang, J., & Li, J. (2020). Using social media mining technology to improve stock price forecast accuracy. *Journal of Forecasting*, (pp. 104–116).
- Ioffe, S., & Szegedy, C. (2015). Batch normalization: Accelerating deep network training by reducing internal covariate shift. ArXiv:1502.03167.
- Jiang, W. (2020). Applications of deep learning in stock market prediction: Recent progress. ArXiv:2003.01859.
- Kingma, D., & Ba, J. (2014). Adam: A method for stochastic optimization. ArXiv:1412.6980.
- Koshiyama, S., Firoozye, N., & Treleaven, P. (2020). Algorithms in future capital markets. *SSRN*.
- Li, X., Xie, H., Chen, L., Wang, J., & Deng, X. (2014). News impact on stock price return via sentiment analysis. *Knowledge-Based Systems*, *69*, 14–23.
- Luss, R., & D’Aspremont, A. (2015). Predicting abnormal returns from news using text classification. *Quantitative Finance*, *15*, 999–1012.
- Mazur, M., Dang, M., & Vega, M. (2020). Covid-19 and the march 2020 stock market crash. evidence from s&p1500. *Finance Research Letters*.
- Mohammadi, A., Zhang, X., & Plataniotis, K. (2017). Interactive gaussian-sum filtering for estimating systematic

- risk in financial econometrics. *IEEE Global Conference on Signal and Information Processing (GlobalSIP)*, (pp. 903–907).
- Pennington, J., Socher, R., & Manning, C. (2014). Glove: Glove vector of word representation. *Empirical Methods in Natural Language Processing (EMNLP)*.
- Radojicic, D., & Kredatus, S. (2020). The impact of stock market price fourier transform analysis on the gated recurrent unit classifier model. *Expert Systems with Applications*, 159.
- Rekabsaz, N., & et al. (2017). Volatility prediction using financial disclosures sentiments with word embedding-based ir models. *Association for Computational Linguistics*, (pp. 1712–1721).
- Rezaei, H., Faaljou, H., & Mansourfar, G. (2020). Stock price prediction using deep learning and frequency decomposition. *Expert Systems with Applications*.
- Ronaghi, F., Salimibeni, M., Naderkhani, F., & Mohammadi, A. (2020). Covid19 primo dataset. https://github.com/MSBeni/COVID19_PRIMO#COVID19-PRIMO.
- Ronaghi, F., Salimibeni, M., Naderkhani, F., & Mohammadi, A. (2017). Ndsmpf: A noisy deep neural network fusion framework for stock price movement prediction. *IEEE International Conference on Information Fusion (FUSION)*, (pp. 1–7).
- Saleh Ahmar, A., & Boj del Val, E. (2020). Suttearima: Short-term forecasting method, a case: Covid-19 and stock market in spain. *Science of the Total Environment*.
- Schumaker, R., & Chen, H. (2009). Textual analysis of stock market prediction using breaking financial news: The azfin text system. *ACM Transactions on Information Systems*.
- Seo, S., Huang, J., Yang, H., & Liu, Y. (2017). Interpretable convolutional neural networks with dual local and global attention for review rating prediction. *Proceedings of the Recsys*, (pp. 297–305).
- Seong, N., & Nam, K. (2021). Predicting stock movements based on financial news with segmentation. *Expert Systems with Applications*, 64.
- Tetlock, P. (2007). Giving content to investor sentiment: The role of media in the stock market. *Journal of Finance*, 62, 1139–1168.
- Xie, B., Passonneau, R., Wu, L., & Creamer, G. (2013). Semantic frames to predict stock price movement. *Association for Computational Linguistics*, (pp. 873–883).
- Yun, H., Sim, G., & Seok, J. (2019). Stock prices prediction using the title of newspaper articles with korean natural language processing. *International Conference on Artificial Intelligence in Information and Communication (ICAIIIC)*, (pp. 019–021).
- Zhang, Y., Chu, G., & Shen, D. (2020). The role of investor attention in predicting stock prices: The long short-term memory networks perspective. *Finance Research Letters*.