

# Feedback Insertion-Deletion Codes

Georg Maringer <sup>\*</sup>    Nikita Polyanski<sup>†</sup>    Ilya Vorobyev <sup>‡</sup>    Lorenz Welter <sup>§</sup>

## Abstract

In this paper, a new problem of transmitting information over the adversarial insertion-deletion channel with feedback is introduced. Suppose that we can transmit  $n$  binary symbols one-by-one over the channel, in which some symbols can be deleted and some additional symbols can be inserted. After each transmission, the encoder is notified about the insertions or deletions that have occurred within the previous transmission and the encoding strategy can be adapted accordingly. The goal is to design an encoder which is able to transmit as much information as possible under the assumption that the total number of deletions and insertions is limited by  $\tau n$ ,  $0 < \tau < 1$ . We show how this problem can be reduced to the problem of transmitting messages over the substitution channel. Thereby, the maximal asymptotic rate of feedback insertion-deletion codes is completely established. For the substitution channel with random errors, an optimal algorithm with a nice intuition behind it was presented in 1963 by Horstein. However, the analysis of this algorithm for the adversarial substitution channel is quite complicated and was completed only 13 years later by Zigangirov. We revisit Zigangirov's result and present a more elaborate version of his proof.

---

<sup>\*</sup>Technical University of Munich. Supported by the German Research Foundation (Deutsche Forschungsgemeinschaft, DFG) under Grant No. WA3907/4-1. Email: [georg.maringer@tum.de](mailto:georg.maringer@tum.de)

<sup>†</sup>Technical University of Munich and Skolkovo Institute of Science and Technology. Supported in part by the German Israeli Project Cooperation (DIP) grant under Grant No. KR3517/9-1. Email: [nikita.polyansky@gmail.com](mailto:nikita.polyansky@gmail.com).

<sup>‡</sup>Skolkovo Institute of Science and Technology. Supported in part by RFBR and JSPS under Grant No. 20-51-50007, and by RFBR under Grant No. 20-01-00559. Email: [vorobyev.i.v@yandex.ru](mailto:vorobyev.i.v@yandex.ru).

<sup>§</sup>Technical University of Munich. Supported by the European Research Council (ERC) under the European Union's Horizon 2020 research and innovation programme (grant agreement No. 801434). Email: [lorenz.welter@tum.de](mailto:lorenz.welter@tum.de)

# 1 Introduction

The problem of constructing codes capable of correcting insertion and deletion errors has been studied since 1965 when Levenshtein published his work [1], where he established that any code is capable of correcting  $t$  deletions if and only if it is capable of correcting  $t$  insertions and deletions and showed that the Varshamov-Tenengolts codes [2] can be used to correct a single insertion or deletion. Notably, most of the classic techniques for constructing error-correcting codes cannot be applied to construct codes coping with insertions and deletions because these types of errors induce a loss of synchronization between the sender and the receiver. This resulted in substantial development of new approaches and methods for the deletion channel in recent years.

We first recap the results for adversarial deletion channels without the presence of noiseless feedback to the sender. Let a code  $\mathcal{C} \subset \{0,1\}^n$  consist of  $2^{Rn}$  binary codewords of length  $n$ . The goal is to find a code maximizing the achievable rate  $R$  which is able to correct up to a fraction  $\tau$  of *adversarial* deletions. By adversarial deletions we refer to the case that the adversary can inflict an arbitrary pattern of deletions with full knowledge of the code. The error correction capability of  $\mathcal{C}$  is closely related to the longest common subsequence between any two codewords in  $\mathcal{C}$ . For a code being able to correct a fraction of  $\tau$  errors the longest common subsequence between any two codewords in  $\mathcal{C}$  is of length less than  $(1 - \tau)n$ . It is clear that for  $\tau \geq \frac{1}{2}$ , the adversary can force the channel to output either the all-one word or the all-zero word. Thus, a code  $\mathcal{C}$  can contain at most two codewords and the asymptotic rate is zero. The first code construction capable of correcting a non-zero fraction of deletions was proposed by Schulman and Zuckerman [3]. They proposed to use concatenated codes composed of non-binary outer codes and well performing short binary inner codes that can be found by brute-force search. The last improvement in this direction is due to Bukh, Guruswami, and Hastad [4, 5]. They provided a family of code constructions with a positive rate for any  $\tau < \sqrt{2} - 1 \approx 0.41$ . For the adversarial substitution channel it is well known that it is not possible to have exponentially many codewords in a code tolerating a fraction of  $\tau \geq 0.25$  errors. However, to the best of our knowledge not much further progress has been made on the limitations of deletion-correcting codes. Even determining the maximal fraction of deletions for which there exist codes with rate bounded away from zero remains an open research problem.

Another type of deletion errors is *random* deletions. In this model, the channel deletes each bit independently with probability  $\tau$  and the receiver has to guess the message sent with high probability. The first results for random deletions have been obtained by Gallager [6] and Zigangirov [7], who proved that for  $\tau < \frac{1}{2}$ , a code can have exponentially many codewords. After that, some results concerning limitations of codes tackling random deletions have been obtained in numerous papers [8, 9, 10, 11, 12]. In particular, it is known for any error probability  $\tau < 1$ , there exist codes with positive rate capable of correcting random deletions. We refer the reader to [13] for a good survey on the known techniques. Other types of errors which are between adversarial and random deletions have been discussed in [14].

It is clear that noiseless *feedback* between sender and receiver can potentially increase the maximal

rate of a code with fractional error correction capability  $\tau$ . Thereby, feedback insertion-deletion coding with random errors has been introduced in [15] by Wang and Lee. It was suggested to consider a queue into which encoded symbols are entering, waiting to be transmitted by the channel. In such a channel, four different events may occur: i) the next queued bit is deleted, ii) an extra bit is inserted, iii) the next queued bit is transmitted, and iv) the next queued bit is bit-flipped. The channel is then specified by the probabilities for each of the aforementioned events.

A feedback model with adversarial substitutions has been investigated in the paper [16] by Berlekamp. In this setting a binary channel which can flip at most a fraction  $\tau$  symbols within a block. Additionally after transmitting each symbol the sender gets notification about which symbol has been received by utilizing a noiseless feedback channel. Therefore, before sending the next symbol he is able to adjust his encoding strategy according to the previously received symbols. The maximal asymptotic rate in a feedback code for this channel has been completely characterized by Berlekamp [16] and Zigangirov [17]. Interestingly, their results show that the rate is positive for  $\tau < 1/3$ .

## 1.1 Problem statement

The problem of communicating over the adversarial insertion-deletion channel with feedback is addressed in this paper. For any message  $m \in [M]$ , Alice's goal is to synthesize and store a binary string symbol-by-symbol in a storage in a way such that Bob is able to correctly decode the message  $m$ . The process of synthesizing and storing a string consists of  $n$  steps and is intercepted by an adversary Calvin who can change the string by inflicting insertions and deletions. At the  $i$ th moment Alice generates a binary symbol  $c_i \in \{0, 1\}$ . Calvin takes  $c_i$  and is able to inflict insertion and deletion errors to obtain a string  $\mathbf{y}_i \in \{0, 1\}^*$ . We stress that the adversary Calvin has the ability to place the insertions before the symbol  $c_i$  and not only after the transmitted symbol  $c_i$ , increasing his flexibility. At the  $(i + 1)$ st moment, Alice can adapt the further encoding strategy for the message  $m$  based on the concatenation of the strings  $\mathbf{y}^{(i)} := (\mathbf{y}_1, \dots, \mathbf{y}_i)$ . Thereby,  $c_{i+1}$  is a function of  $m$  and  $\mathbf{y}^{(i)}$ , i.e.,  $c_{i+1} = c_{i+1}(m, \mathbf{y}^{(i)})$ . Notice that at this point Calvin is not allowed to insert symbols into  $\mathbf{y}_i$  anymore. We require the total number of errors that Calvin can create to be at most  $t$ , that is

$$\sum_{i=1}^n \Delta(c_i(m, \mathbf{y}^{(i-1)}), \mathbf{y}_i) \leq t, \quad (1)$$

where  $\Delta(\mathbf{x}, \mathbf{y})$  denotes the minimal number of deletions and insertions required to obtain  $\mathbf{y}$  from  $\mathbf{x}$ . This quantity is frequently referred to as the *longest common subsequence* distance between strings  $\mathbf{x}$  and  $\mathbf{y}$ . We depict the previously described communication scheme in Figure 1. Our goal is to find the maximum rate at which Alice can store messages onto the storage such that Bob can successfully decode them afterwards, given the maximal fraction of errors  $\tau$  Calvin may induce. More formally, let  $M_{id}(n, t)$  be the maximal number of messages Alice can transmit to Bob under conditions imposed by this model. Define the *maximal asymptotic rate* of feedback codes capable of correcting a fraction

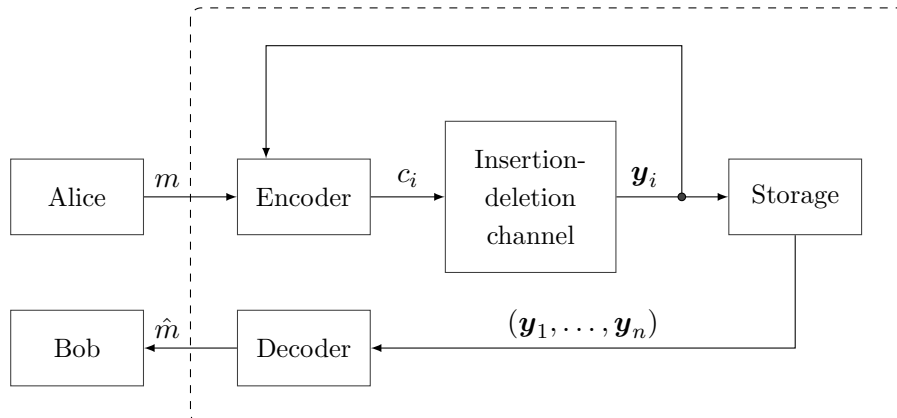

Figure 1: Insertion-deletion channel with complete feedback.

$\tau$  of insertion-deletion errors to be

$$R_{id}(\tau) := \limsup_{n \rightarrow \infty} \frac{\log M_{id}(n, \lfloor \tau n \rfloor)}{n}.$$

Notice that the channel output for the insertion-deletion channel could consist of up to  $n + \lfloor \tau n \rfloor$  symbols when the channel is used  $n$  times. However, the asymptotic rate is measured in bits per channel use. The main goal of this paper is to find the quantity  $R_{id}(\tau)$  for arbitrary  $\tau \in [0, 1]$ .

## 1.2 Our contribution

We show that the problem of transmitting information over the adversarial insertion-deletion channel can be reduced to the problem of communication over the adversarial substitution channel. More specifically, we first demonstrate that any encoding algorithm with  $n$  transmissions tackling  $t$  insertions can serve as an encoding algorithm with  $n + t$  transmissions correcting  $t$  substitution errors. This proves our upper bound on the maximal rate of the adversarial insertion-deletion channel. Then we adapt an encoding strategy originally suggested for the feedback substitution channel to obtain a lower bound on the maximal asymptotic rate of the insertion-deletion channel. This lower bound matches the previously derived upper bound. Therefore, we have determined the maximal asymptotic rate of feedback insertion-deletion codes for any fraction of errors  $\tau$ . The resulting asymptotic rate is plotted in Figure 2.

**Theorem 1.** *The maximal asymptotic rate of feedback codes for the adversarial insertion-deletion channel is*

$$R_{id}(\tau) = \begin{cases} (1 + \tau) \left( 1 - h\left(\frac{\tau}{1+\tau}\right) \right), & \text{for } 0 \leq \tau \leq \sqrt{5} - 2, \\ \log\left(\frac{1+\sqrt{5}}{2}\right)(1 - 2\tau), & \text{for } \sqrt{5} - 2 < \tau \leq \frac{1}{2}, \\ 0, & \text{otherwise,} \end{cases} \quad (2)$$

where  $h(x)$  denotes the binary entropy function and the logarithm is in base two.

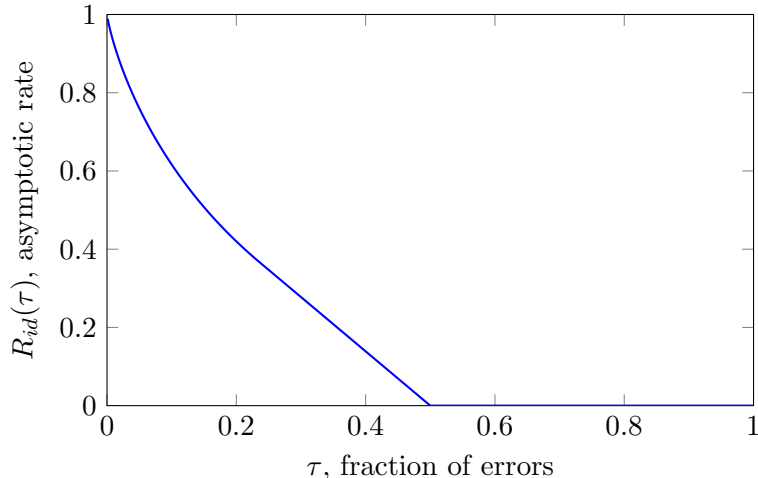

Figure 2: Maximal asymptotic rate of binary feedback insertion-deletion codes.

As a side contribution of our paper, we present a more elaborate version of the technical proof by Zigangirov [17]. We hope that this makes the intuitive algorithm with simple encoding and decoding procedures which is nevertheless hard to analyze more accessible to a wider audience.

### 1.3 Outline

The remainder of the paper is organized as follows. In Section 2, we provide an upper bound on  $R_{id}(\tau)$ . Section 3 discusses a feedback insertion-deletion code and its reduction to feedback substitution codes. The analysis of the feedback substitution code is given in Section 4. Finally, we conclude the paper with Section 5.

## 2 Upper bound on $R_{id}(\tau)$

In this section we introduce the concept of the adversarial substitution channel and prove that a feedback insertion-deletion code correcting a fraction  $\tau$  of errors can serve as a feedback substitution code capable of correcting a fraction  $\tau/(1 + \tau)$  of errors. This enables us to prove an upper bound on maximal achievable rate for the insertion-deletion channel which is equal to  $R_{id}(\tau)$  specified in (2). However, it is unclear whether every substitution code can be used to construct an encoding scheme suitable for correcting insertion-deletion errors. Nevertheless, in Section 3 we show how to correct insertion-deletion errors with a substitution code having an additional property.

### 2.1 Feedback adversarial substitution channel

First we specify the adversarial *substitution channel* with feedback. In this work we are only considering the binary case, thus the channel is specified to have binary alphabets at its input as well as

its output. The channel is synchronized and an error is defined as the event that an output symbol is not equal to its respective input symbol (e.g. input symbol “0” is flipped to output symbol “1”). Thus the transmission of a single bit can be illustrated as shown in Figure 3. This channel is also known in the coding theory literature as the *binary symmetric channel* or the *bit-flip channel*.

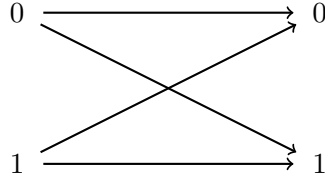

Figure 3: Substitution channel

Let  $[M] := \{1, \dots, M\}$  denote the message set. Suppose that Alice wants to transmit a message  $m \in [M]$  to Bob. We are considering block encoding where we denote the blocklength by  $n$ . We denote the  $i$ th symbol Alice sends over the channel by  $c_i$  and the  $i$ th symbol Bob receives by  $y_i$ . When generating the  $i$ th channel input symbol  $c_i$ , Alice’s encoder can adjust its encoding strategy according to the previously received symbols by Bob  $\mathbf{y}^{(i-1)} := (y_1, \dots, y_{i-1})$ , i.e.  $c_i = c_i(m, \mathbf{y}^{(i-1)})$ . Based on the output vector  $\mathbf{y} := (y_1, \dots, y_n)$ , Bob has to uniquely decode the message  $m$ . We require the total number of errors produced by the channel to be at most  $t$ , i.e.,  $d_H(\mathbf{c}, \mathbf{y}) \leq t$ , where  $\mathbf{c} := (c_1, \dots, c_n)$  and  $d_H(\mathbf{c}, \mathbf{y})$  denotes the Hamming distance between the two strings  $\mathbf{c}$  and  $\mathbf{y}$ . Let  $M_s(n, t)$  be the maximal number of messages Alice can transmit to Bob and define the maximal asymptotic rate of feedback codes capable of correcting a fraction  $\tau$  of substitution errors to be

$$R_s(\tau) := \limsup_{n \rightarrow \infty} \frac{\log M_s(n, \lfloor \tau n \rfloor)}{n}.$$

## 2.2 Insertions from substitution errors

To prove that (2) is an upper bound on the maximal rate of feedback codes for the adversarial insertion-deletion channel, we combine two ideas. First, we prove that a feedback insertion-deletion code can be used to tackle substitution errors.

**Lemma 2.** *Suppose that a feedback insertion-deletion code of length  $n$  and size  $M$  capable of correcting  $t$  errors is given. Then there exists a feedback code of length  $n + t$  and size  $M$  capable of correcting  $t$  substitution errors.*

Second, we make use of an upper bound on the rate  $R_s(\tau)$  provided by Berlekamp [16].

**Theorem 3** (Follows from [16, Chapter IV] and [17]). *The maximal asymptotic rate for the adver-*

serial substitution channel satisfies

$$R_s(\tau) = \begin{cases} 1 - h(\tau), & \text{for } 0 \leq \tau \leq (3 - \sqrt{5})/4, \\ \log\left(\frac{1+\sqrt{5}}{2}\right)(1 - 3\tau), & \text{for } (3 - \sqrt{5})/4 < \tau \leq 1/3, \\ 0, & \text{otherwise.} \end{cases}$$

By Lemma 2, we have  $M_s(n + t, t) \geq M_{id}(n, t)$  and, thus,  $(1 + \tau)R_s(\tau/(1 + \tau)) \geq R_{id}(\tau)$ . This bound and Theorem 3 yield the upper bound from Theorem 1. This bound and Theorem 3 yield that the asymptotic rate specified in Theorem 1 is indeed an upper bound on the maximal achievable rate of the adversarial insertion-deletion channel. So, it remains to check the validity of Lemma 2.

*Proof of Lemma 2.* Let the encoding functions of the given feedback insertion-deletion code be determined by  $c_i : [M] \times \{0, 1\}^* \rightarrow \{0, 1\}$  for  $i \in [n]$ . We shall define encoding functions  $e_j : [M] \times \{0, 1\}^{j-1} \rightarrow \{0, 1\}$  for all  $j \in [n + t]$  for the substitution channel using the encoding functions  $c_i$  as components. We define the encoder to re-transmit symbol  $c_i$  until its reception is correct. Let  $j_i$  be a position at which the  $i$ th symbol  $c_i$  is received correctly (for simplicity, we assume  $j_0 = 0$ ). We are interested in only first  $n$  such moments, which exist since at most  $t$  errors could occur. So, we have  $0 = j_0 < j_1 < \dots < j_n \leq n + t$ . We define the encoding functions  $e_j = e_j(m, \mathbf{y}^{(j-1)})$  by

$$e_j = e_j(m, \mathbf{y}^{(j-1)}) := \begin{cases} c_i(m, \mathbf{y}^{(j_i-1)}), & \text{if } j_{i-1} < j \leq j_i, 1 \leq i \leq n \\ 0, & \text{otherwise,} \end{cases}$$

where for  $j \leq j_n$ , we have that

$$y_j = \begin{cases} e_j, & \text{if } j = j_i, 1 \leq i \leq n, \\ 1 - e_j, & \text{if } j \neq j_i, 1 \leq i \leq n, \end{cases}$$

and for  $j > j_n$ ,  $y_j \in \{0, 1\}$ . Let  $\mathbf{e}^{(n+t)} = (e_1, \dots, e_{n+t})$ . In order to show that Bob is able to uniquely decode the message  $m$  for any output  $\mathbf{y}^{(n+t)}$  with  $d_H(\mathbf{e}^{(n+t)}, \mathbf{y}^{(n+t)}) \leq t$  it suffices to decompose  $\mathbf{y}^{(n+t)}$  to  $\mathbf{y}_1, \dots, \mathbf{y}_n \in \{0, 1\}^*$  such that the inequality (1) holds. For this purpose, we can simply take  $\mathbf{y}_i = (y_{j_{i-1}+1}, \dots, y_{j_i})$  for  $i < n$  and  $\mathbf{y}_n = (y_{j_{n-1}}, \dots, y_{n+t})$ . The inequality (1) is true since  $y_{j_i} = e_{j_i}$  for  $1 \leq i \leq n$ . This completes the proof.  $\square$

### 3 Lower bound on $R_{id}(\tau)$

In this section, we provide a feedback insertion-deletion code that has rate arbitrary close to (2). We adapt an algorithm originally suggested by Horstein [18] and further developed by Schalkwijk [19] and Zigangirov [17]. Note that this algorithm was has already been used for the adversarial substitution channel with feedback. We point out that not every encoding strategy for the adversarial substitution channel can be adopted to be used for the insertion-deletion channel. A key property of Horstein's

algorithm is that in case the channel inflicts an error the sender re-transmits the intended symbol until it is received correctly. We elaborate on the importance of this property by considering a general encoding strategy with feedback. We assume that according to the previously received symbols the encoding strategy implies sending  $c_i = 0$  over the channel and that the adversary inserts a 1-symbol before  $c_i$  such that  $\mathbf{y}_i = 10$ . The 1 symbol at the beginning of the sequence  $\mathbf{y}_i$  can also be interpreted as being created by the adversary as the last symbol of  $\mathbf{y}_{i-1}$ . For a general encoding strategy it is possible that the encoder would output  $c_i = 1$  after observing  $\mathbf{y}_{i-1}$ , thus the adversary would be able to inflict two errors at the price of one for such an encoding strategy. Horstein's procedure prevents this possibility, making it suitable for the proposed insertion-deletions model in this paper.

### 3.1 Feedback insertion-deletion code

Suppose that at most a fraction of  $\tau$  errors can occur and Alice would like to transmit  $M = 2^{Rn}$  messages where  $R = R_{id}(\tau) - \varepsilon$  and  $\varepsilon > 0$ . Based on  $\tau$ ,  $\varepsilon$  and  $n$ , Alice and Bob choose two non-algebraic numbers  $\alpha$  and  $\beta$  fulfilling  $\alpha + \beta = 2$ . For  $\tau < \sqrt{5} - 2$ , they take  $\alpha$  sufficiently close to  $2\tau/(1 + \tau)$  and for  $\sqrt{5} - 2 \leq \tau < \frac{1}{2}$ ,  $\alpha$  is chosen to be around  $(3 - \sqrt{5})/2$ . We discuss how close this parameter has to be taken in Section 4. Then Alice divides the  $[0, 1]$ -segment into  $M$  subsegments of length  $1/M$  and enumerates them from left to right by the elements of  $[M]$ . The length of these  $M$  segments will vary during transmission. If Alice wishes to transmit the message  $m \in [M]$ , then the  $m$ th segment will be called the *true segment*. Let  $T(i)$  denote the true segment of length  $t(i)$  after the  $i$ th transmission. Denote the union of segments on the left and, respectively, on the right to  $T(i)$  by  $L(i)$  and  $R(i)$ . Now we are ready to describe encoding and decoding procedures of the proposed algorithm, written as  $\mathfrak{A}_{id}(M, n, \alpha)$ .

*Remark 1.* We remark that the non-algebraic numbers are dense within the set of real numbers, meaning that we can approximate any real number arbitrarily close within the non-algebraic numbers.

**Encoding procedure:** At the  $i$ th moment Alice checks whether the center of the true segment lies in  $[0, \frac{1}{2})$ . In this case she transmits the symbol  $c_i = 0$  over the channel, otherwise she transmits  $c_i = 1$ . Once she observes the channel outputs  $\mathbf{y}_i$  of length  $n_i$ , Alice modifies the length of all segments in the following manner. She runs over symbols of  $\mathbf{y}_i = (y_{i,1}, \dots, y_{i,n_i})$  from left to right. If  $\mathbf{y}_i$  is the empty string, then she proceeds with transmitting the next symbol. Otherwise, if  $y_{i,j} = 0$ , then the length of all segments, that entirely lie inside  $[0, \frac{1}{2})$ , is enlarged by a factor of  $\beta$ . The length of segments that lie entirely in  $[\frac{1}{2}, 1]$  is shrunk by the factor  $\alpha$ . There could be a segment that contains the point  $\frac{1}{2}$  (not as its endpoint). Let  $x$  be the length of this segment. Then  $x$  can be represented as  $x = x_0 + x_1$ , where  $x_0$  is the length of part of the segment, which lies in  $[0, \frac{1}{2})$ . Then the length of this segment is updated from  $x$  to  $\beta x_0 + \alpha x_1$ . If  $y_{i,j} = 1$  is received, Alice shrinks the segments left to the point  $\frac{1}{2}$  by a factor of  $\alpha$  while increasing the segments right to it by a factor of  $\beta$ . Compared to the case  $y_{i,j} = 0$  the roles of  $\alpha$  and  $\beta$  are just swapped. During the transmissions the length of the segments changes according to the algorithm, however, the order of the segments remains unaltered.



In total, Alice makes  $n_i$  such updates after the  $i$ th transmission. It can be readily seen that the total length of all segments is always 1. The algorithm is designed to increase the length of the true segment such that it contains the point  $\frac{1}{2}$  after the last transmission.

*Remark 2.* The complexity of this encoding algorithm is  $\Theta(Mn)$ . However, it is clear from the description that to follow the encoding algorithm, it suffices for Alice to modify the length of only three segments  $L(i), T(i)$  and  $R(i)$ .

**Decoding procedure:** After receiving a string  $\mathbf{y} = (y_1, \dots, y_{n'})$  of length  $n' \in [n-t, n+t]$ , Bob reconstructs Alice's point of view by varying the length of all segments in the same way as Alice. Bob decodes the message by taking the index of the segment containing the point  $\frac{1}{2}$ .

*Remark 3.* The complexity of this decoding algorithm is  $\Theta(Mn)$ . To reduce the decoding complexity Bob can reverse the decoding procedure in the following way. He runs over the symbols of  $\mathbf{y}$  from right to left and tracks the preimage of the point  $\frac{1}{2}$ . Formally, let  $P(n') := \frac{1}{2}$ . For  $j \in \{0, 1, \dots, n'-1\}$  and  $y_j = 0$ , define

$$P(j-1) := \begin{cases} \frac{P(j)}{\beta}, & \text{if } P(j) \leq \frac{\beta}{2}, \\ \frac{1}{2} + \frac{2P(j)-\beta}{2\alpha}, & \text{if } P(j) > \frac{\beta}{2}. \end{cases}$$

For  $y_j = 1$ , define

$$P(j-1) := \begin{cases} \frac{P(j)}{\alpha}, & \text{if } P(j) \leq \frac{\alpha}{2}, \\ \frac{1}{2} + \frac{2P(j)-\alpha}{2\beta}, & \text{if } P(j) > \frac{\alpha}{2}. \end{cases}$$

Finally, Bob uses  $\hat{m} := \lceil M \cdot P(0) \rceil$  as an estimate for the message  $m$  that Alice intended to send.

**Running time:** The enhancements given in Remark 2 and 3 make the algorithm feasible for implementation. The total complexity is then  $O(n)$ .

### 3.2 Intuition behind the algorithm

We give an intuitive explanation why this strategy is sensible. In this section we are only considering the case that  $\tau < \sqrt{5} - 2$  as only for this case

$$R_{id}(\tau) = (1 + \tau) \left( 1 - h \left( \frac{\tau}{1 + \tau} \right) \right).$$

Let us take  $\alpha = 2\tau/(1 + \tau)$ . Assume that during the decoding procedure the number of times when the true segment contains the point  $\frac{1}{2}$  is  $o(n)$  and the number (1) of insertion and deletion errors during transmission is  $\tau_{ins}n + o(n)$  and  $\tau_{del}n + o(n)$ , respectively, where  $\tau_{ins} + \tau_{del} \leq \tau$ . Then the length of the true segment after  $n$  transmissions,  $t(n)$ , can be bounded from below by

$$\begin{aligned} & M^{-1} \alpha^{\tau_{ins}n + o(n)} \beta^{(1 - \tau_{del})n + o(n)} \\ &= 2^{-(R_{id}(\tau) - \varepsilon)n + \tau_{ins}n \log(2\tau/(1+\tau)) + (1 - \tau_{del})n \log(2/(1+\tau)) + o(n)} \\ &\geq 2^{-(R_{id}(\tau) - \varepsilon)n + \tau n \log(2\tau/(1+\tau)) + n \log(2/(1+\tau)) + o(n)} \\ &= 2^{\varepsilon n + o(n)}, \end{aligned}$$

where we used the fact that the function  $\tau_{ins} \log(2\tau/(1+\tau)) + (1-\tau_{del}) \log(2/(1+\tau))$  provided  $\tau_{ins} + \tau_{del} \leq \tau$  is minimized at  $\tau_{ins} = \tau$  and  $\tau_{del} = 0$ . Thus, the length of the true segment would be very large at the end and it would definitely contain the point  $\frac{1}{2}$ . However, our initial assumption is wrong, and the true segment contains the point  $\frac{1}{2}$  more than  $o(n)$  times. To actually prove that the strategy is working, we need more sophisticated arguments.

### 3.3 Substitutions from insertion and deletion errors

The algorithm  $\mathfrak{A}_{id}(M, n, \alpha)$  described in Section 3.1 was originally proposed in a similar form for the substitution channel. We emphasize that this channel provides synchronization between Alice and Bob, i.e., after transmitting the symbol  $c_i$ , the channel outputs exactly one symbol  $y_i$ . We will refer to the encoding algorithm for the substitution channel with  $n$  channel uses that follows steps described in Section 3.1 as  $\mathfrak{A}_s(M, n, \alpha)$ . A formal definition of this algorithm for the substitution channel will be given in Section 4.

Let  $\mathbf{y} = (\mathbf{y}_1, \dots, \mathbf{y}_n) = (y_1, \dots, y_{n'})$  be a possible output string of length  $n' \in [n-t, n+t]$  if the algorithm  $\mathfrak{A}_{id}(M, n, \alpha)$  is used for transmitting a message  $m \in [M]$  over the adversarial insertion-deletion channel with at most  $t$  errors. Now we show that this string  $\mathbf{y}$  is also a possible output if the algorithm  $\mathfrak{A}_s(M, n', \alpha)$  is used for transmitting the same message  $m \in [M]$  over the adversarial substitution channel with at most  $t' := \lfloor (n' - n + t)/2 \rfloor$  errors. Let  $c_i = c_i(m, \mathbf{y}_1, \dots, \mathbf{y}_{i-1})$  and  $e_i = e_i(m, y_1, \dots, y_{i-1})$  be the  $i$ th bit generated by the feedback insertion-deletion and, respectively, substitution algorithms. Denote  $\mathbf{e} := (e_1, \dots, e_{n'})$ . So, it suffices to show that  $d_H(\mathbf{e}, \mathbf{y}) \leq t'$ . Denote the length of  $\mathbf{y}_i$  by  $n_i$ . We decompose  $\mathbf{e}$  to  $(\mathbf{e}_1, \dots, \mathbf{e}_n)$  such that  $\mathbf{e}_i$  has length  $n_i$ . It is clear that for “synchronized” moments  $i$  and  $n_1 + \dots + n_{i-1} + 1$ , both algorithms send the same symbol, i.e.,

$$c_i(m, \mathbf{y}^{(i-1)}) = e_{n_1 + \dots + n_{i-1} + 1}(m, \mathbf{y}^{(i-1)}),$$

where  $\mathbf{y}^{(i-1)} = (\mathbf{y}_1, \dots, \mathbf{y}_{i-1})$ . By the definition of the algorithm, it can be readily checked that if  $y_j \neq e_j$ , then  $e_{j+1} = e_j$ , i.e., re-transmission occurs. Therefore,

$$d_H(\mathbf{e}_i, \mathbf{y}_i) \leq \begin{cases} n_i - 1 & \text{if } \Delta(c_i, \mathbf{y}_i) = n_i - 1, \\ n_i & \text{if } \Delta(c_i, \mathbf{y}_i) = n_i + 1. \end{cases}$$

Note that the second case can only happen when a deletion occurred. Let  $t_{ins}$  be the total number of insertions and  $t_{del}$  be the total number of deletions. We have restriction  $t_{ins} + t_{del} \leq t$  and  $n - t_{del} + t_{ins} = n'$ . This implies that  $n' - n + 2t_{del} \leq t$  or  $t_{del} \leq \lfloor (n - n' + t)/2 \rfloor$ . It follows that

$$d_H(\mathbf{e}, \mathbf{y}) = \sum_{i=1}^n d_H(\mathbf{e}_i, \mathbf{y}_i) \leq \sum_{i=1}^n n_i - \sum_{i=1}^n \mathbb{1}\{\Delta(c_i, \mathbf{y}_i) = n_i - 1\} \leq n' - (n - t_{del}) \leq t'.$$

Here,  $\mathbb{1}\{x = a\}$  denotes the indicator function of the event  $x = a$ . Thus, we get the following statement.

**Lemma 4.** *If for all  $n' \in [n - t, n + t]$ , the algorithm  $\mathfrak{A}_s(M, n', \alpha)$  can be used for successful transmission of any message  $m \in [M]$  over the feedback adversarial substitution channel with at most  $t' := \lfloor (n' - n + t)/2 \rfloor$  errors, then the algorithm  $\mathfrak{A}_{id}(M, n, \alpha)$  can be used for successful transmission of any message  $m \in [M]$  over the feedback adversarial insertion-deletion channel with at most  $t$  errors.*

Next we have a closer look at the the adversarial substitution channel. In order to achieve the maximal asymptotic rate of the adversarial substitution channel with a fraction  $\tau \leq (3 - \sqrt{5})/4$  of errors, for the parameter  $\alpha$  within the algorithm  $\mathfrak{A}_s(M, n, \alpha)$  it holds that  $\alpha \approx 2\tau$  with  $\alpha$  being non-algebraic.

**Lemma 5** (Follows from [17]). *Let  $\alpha^* = 2\tau^*$  with  $\tau^* \leq (3 - \sqrt{5})/4$  being a non-algebraic number and let the algorithm  $\mathfrak{A}_s(M, n, \alpha^*)$  be used to communicate information over the adversarial substitution channel for different  $\tau$ . Then the achieved rates for different  $\tau$  form a tangent line to the point  $(\tau^*, R_s(\tau^*))$  of the function  $R_s(\tau)$ .*

By using Lemma 5 we can show the following monotonicity property.

**Proposition 1.** *Let  $M_s(n, \tau, \alpha)$  denote the maximum number of messages  $M$  that can successfully be transmitted using the algorithm  $\mathfrak{A}_s(M, n, \alpha)$  for the adversarial substitution channel with blocklength  $n$  and at most  $\tau n$  errors. Let  $\alpha$  and  $\tau$  be non-algebraic such that  $\alpha = 2\tau/(1 + \tau)$  and  $\alpha \leq (3 - \sqrt{5})/2$ . Then it holds that*

$$\begin{aligned} \min_{k \in \{0, 1, \dots, \tau n\}} \log M_s(\lfloor n(1 + \tau) \rfloor - 2k, \lfloor \tau n \rfloor - k, \alpha) &= (1 + o(1)) \log M_s(\lfloor (1 + \tau)n \rfloor, \lfloor \tau n \rfloor, \alpha) \\ &= n(1 + \tau)R_s\left(\frac{\tau}{1 + \tau}\right) + o(n). \end{aligned}$$

*Proof.* We fix  $\alpha = 2\tau/(1 + \tau)$  because it allows us to successfully transmit by the algorithm  $\mathfrak{A}_s(M, \lfloor n(1 + \tau) \rfloor, \alpha)$  asymptotically the maximum amount of messages given the number of errors is at most  $\lfloor \tau n \rfloor$ . Then our goal is to show that although the chosen  $\alpha$  is not optimal in terms of the achievable rate for blocklength  $\lfloor n(1 + \tau) \rfloor - 2k$  and at most  $\lfloor \tau n \rfloor - k$  errors, the quantity  $\log M_s(\lfloor n(1 + \tau) \rfloor - 2k, \lfloor \tau n \rfloor - k, \alpha)$  is still asymptotically minimized for  $k = 0$ .

According to Lemma 5 by fixing  $\alpha = 2\tau/(1 + \tau)$  and using the algorithm  $\mathfrak{A}_s(M, n', \alpha)$  for  $n' = \lfloor n(1 + \tau) \rfloor - 2k$  and at most  $\lfloor \tau n \rfloor - k$  errors the achievable rates form the tangent line to the point  $(\tau/(1 + \tau), R_s(\tau/(1 + \tau)))$  of the function  $R_s(x) = 1 - h(x)$ .

To prove the required claim concerning the minimization, we define the function

$$f(x) := \frac{\log M_s(n(1 + \tau - 2x), (\tau - x)n, \alpha)}{n} = (1 + \tau - 2x) \left( a \frac{\tau - x}{1 + \tau - 2x} + b \right) (1 + o(1)),$$

where the real valued  $a, b$  are fixed by the requirement that the achieved rates form a tangent to the point  $(\tau/(1 + \tau), R_s(\tau/(1 + \tau)))$ . A short computation shows that  $a = \log \frac{\tau}{1 - \tau}$  and  $b = 1 + \log(1 - \tau)$ . The derivative of  $f(x)$  as  $n \rightarrow \infty$  is

$$\frac{\partial f}{\partial x} = -a - 2b + o(1) = \log \left( \frac{1}{\tau(1 - \tau)} \right) - 2 + o(1) \geq 0,$$

where the inequality follows because the denominator within the logarithm is strictly less than  $1/4$  for  $\tau < 1/2$ . This shows that  $f$  is asymptotically minimized for  $x = 0$ , completing the proof.  $\square$

We have already shown that the output sequences of the algorithm  $\mathfrak{A}_{id}(M, n, \alpha)$  for the adversarial insertion-deletion channel are also within the set of output sequences of the adversarial substitution channel if the algorithm  $\mathfrak{A}_s(M, n', \alpha)$  is used for at most  $t' = \lfloor (n' - n + t)/2 \rfloor$  errors and  $n' \in [n - t, n + t]$ . Therefore, from Proposition 1 it follows that  $R_{id}(\tau) \geq (1 + \tau)R_s(\tau/(1 + \tau))$ . By Theorem 3 it holds that the rate  $R_{id}(\tau)$ , given in (2), is actually achievable and upper and lower bounds on the adversarial insertion-deletion channel coincide.

## 4 Analysis of the feedback substitution code

In this section, we revisit the algorithm and the proof suggested by Zigangirov in [17]. To make this section self-contained, we first describe an encoding process for the adversarial substitution channel with feedback. Then we introduce useful concepts and give a high-level analysis of this feedback strategy. Finally, we provide proofs of auxiliary technical statements used for showing the main result.

### 4.1 Feedback substitution code

Suppose that at most  $\tau n$  substitution errors can occur during  $n$  transmissions and Alice wants to transmit one out of  $M$  messages. If  $0 \leq \tau < (3 - \sqrt{5})/4$ , then Alice takes positive real values  $\alpha$  and  $\beta$  such that  $\alpha + \beta = 2$  and  $\alpha$  is sufficiently close to  $2\tau$ . If  $(3 - \sqrt{5})/4 \leq \tau \leq 1/3$ , then  $\alpha$  and  $\beta$  are taken in such a way that  $\alpha + \beta = 2$  and  $\alpha$  is sufficiently close to and less than  $(3 - \sqrt{5})/2$ . Clearly, for this assignment, we have that

$$\alpha\beta^2 \leq 1. \tag{3}$$

**Encoding procedure:** Initially, Alice takes the  $[0, 1]$ -segment and partitions it into  $M$  subsegments of equal length. She enumerates them from left to right and associates the  $j$ th message,  $j \in [M]$ , with the  $j$ th segment. Suppose that Alice wants to transmit a message  $m \in [M]$ . The  $m$ th segment is then called the *true* segment and we denote it by  $T(i)$  after the  $i$ th transmission. We define the union of the segments on the left and on the right to  $T(i)$  by  $L(i)$  and  $R(i)$ , respectively. The lengths of  $L(i)$ ,  $T(i)$  and  $R(i)$  are denoted by  $l(i)$ ,  $t(i)$  and  $r(i)$ . Clearly,  $t(0) = 1/M$  and  $l(i) + t(i) + r(i) = 1$ . At the  $i$ th moment, Alice checks whether the center of  $T(i - 1)$  is less than  $\frac{1}{2}$  and transmits a “0” to the channel in that case. Otherwise she transmits a “1” to the channel. If a “0” is received, then everything on the left to  $\frac{1}{2}$  is enlarged by  $\beta$  and everything on the right to  $\frac{1}{2}$  is shrunk by  $\alpha$ . More

formally,

$$\begin{aligned} l(i) &:= \beta \min\left(\frac{1}{2}, l(i-1)\right) + \alpha \max\left(l(i-1) - \frac{1}{2}, 0\right), \\ r(i) &:= \alpha \min\left(\frac{1}{2}, r(i-1)\right) + \beta \max\left(r(i-1) - \frac{1}{2}, 0\right), \\ t(i) &:= 1 - l(i) - r(i). \end{aligned}$$

If a “1” is received, then everything on the left to  $\frac{1}{2}$  is shrunk by  $\alpha$  and everything on the right to  $\frac{1}{2}$  is enlarged by  $\beta$ . Thus,

$$\begin{aligned} l(i) &:= \beta \max\left(l(i-1) - \frac{1}{2}, 0\right) + \alpha \min\left(\frac{1}{2}, l(i-1)\right), \\ r(i) &:= \alpha \max\left(r(i-1) - \frac{1}{2}, 0\right) + \beta \min\left(\frac{1}{2}, r(i-1)\right), \\ t(i) &:= 1 - l(i) - r(i). \end{aligned}$$

Informally, given  $\varepsilon > 0$ , for properly chosen  $\alpha \approx 2 \min(\tau, (3 - \sqrt{5})/4)$ , sufficiently large  $n$  and  $M = 2^{(R_s(\tau) - \varepsilon)n}$ , we claim that  $T(n)$  contains the point  $\frac{1}{2}$ .

## 4.2 Preliminaries

Define  $x(i) := \min(l(i), r(i))$  and  $y(i) := \max(l(i), r(i))$ . We say  $T(i)$  is *central* if  $y(i) \leq \frac{1}{2}$  and we say that there is a *crossing* between moment  $i-1$  and moment  $i$  if either (1)  $l(i-1) \leq r(i-1)$  and  $l(i) > r(i)$  or (2)  $l(i-1) > r(i-1)$  and  $l(i) \leq r(i)$ . We say  $T(i)$  is *balanced* if  $y(i)/x(i) \leq \beta/\alpha$ . We refer to Figure 4 for an illustration of the properties of  $T(i)$ .

**Example 1.** In Figure 5, one can see how the segments  $L(i)$ ,  $R(i)$ , and  $T(i)$  with  $l(i) = 0.2$ ,  $r(i) = 0.4$  and  $t(i) = 0.4$  change for the case of a correct and incorrect transmission when using the parameters  $\tau = 0.15$ ,  $\alpha = 2\tau$ , and  $\beta = 2 - \alpha$ . In particular, we see that the true segment  $T(i)$  is the one containing the point  $\frac{1}{2}$  and, thus, is central. Moreover, we see that  $x(i) = l(i)$  and  $y(i) = r(i)$ , and can conclude that  $T(i)$  is also balanced as  $2 = \frac{y(i)}{x(i)} \leq \frac{\beta}{\alpha} = \frac{1.7}{0.3}$ . In the example, a correct transmission is sending a “0”, i.e., enlarging the intervals on the left of  $\frac{1}{2}$  by  $\beta$  and shrinking the right hand side by  $\alpha$ . We can see that there was a crossing, since  $l(i) \leq r(i)$  and now  $l(i+1) > r(i+1)$ . Moreover, the true segment at moment  $i+1$  still covers the point  $\frac{1}{2}$  and  $T(i+1)$  is still balanced. In contrast, if the transmission was incorrect, i.e., enlarging by  $\beta$  the right hand side of  $\frac{1}{2}$  and shrinking the other part by  $\alpha$ , we observe that there was no crossing and the true segment  $T(i+1)$  does not contain the point  $\frac{1}{2}$  anymore. Moreover, we have that  $T(i+1)$  is not balanced, since  $\frac{34}{3} = \frac{y(i)}{x(i)} > \frac{\beta}{\alpha} = \frac{1.7}{0.3}$ .

Define  $g(i_0, i_1) := e(i_0, i_1) \log \alpha + f(i_0, i_1) \log \beta$ , where  $e(i_0, i_1)$  and  $f(i_0, i_1)$  are the numbers of incorrect and correct transmissions in moments  $(i_0, i_1]$ . Note that the function  $g$  is additive in the sense  $g(i_0, i_2) = g(i_0, i_1) + g(i_1, i_2)$ . For brevity, we write  $g(n)$ ,  $e(n)$  and  $f(n)$  to denote  $g(0, n)$ ,  $e(0, n)$  and  $f(0, n)$ , respectively. We can think about the value  $g(i, n)$  as of the amount of *energy* we have

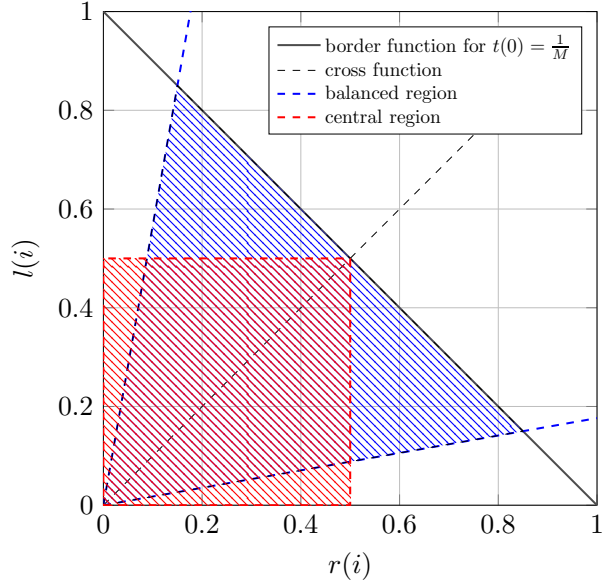

Figure 4: Illustration for the properties *cross*, *balanced*, and *central* as functions of  $l(i)$  and  $r(i)$  when  $\tau = 0.15, \alpha = 2\tau$ , and  $\beta = 2 - \alpha$ .

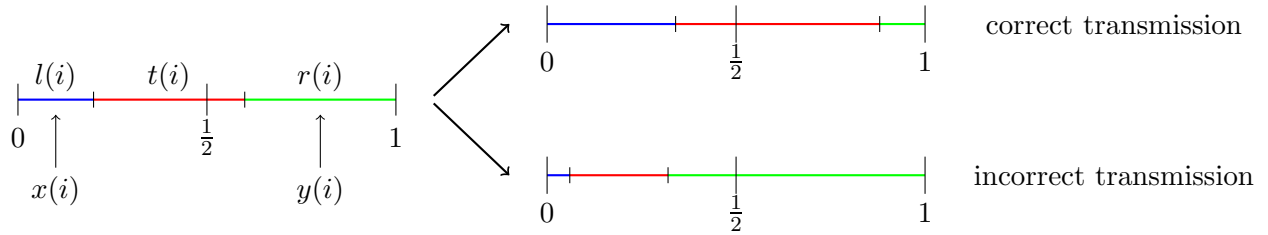

Figure 5: Example for transition of the intervals  $L(i), T(i)$ , and  $R(i)$  in case for a correct and incorrect transmission

at the moment  $i$ . For each correct transmission, we spend  $\log \beta > 0$ , for an incorrect one, we get  $-\log \alpha > 0$ .

### 4.3 High-level analysis

The following statement claims that if the amount of energy is sufficiently large, then at some moment the length of the true segment is bounded away from zero irrespective of the actual blocklength  $n$  and we still have energy left to further increase the length of the true segment in the remaining steps.

**Lemma 6.** *For every  $\varepsilon_1 > \varepsilon_2 > 0$  there exists  $\delta > 0$  such that for all but finitely many  $\alpha \in (0, 1)$  it holds: For  $n \in \mathbb{N}$  the condition  $g(0, n) > \varepsilon_1 n - \log(t(0))$  implies that there is a first moment  $n_1$  such that  $t(n_1) \geq \delta$ . Furthermore,  $g(0, n_1) < \varepsilon_2 n - \log t(0)$  and  $g(n_1, n) > (\varepsilon_1 - \varepsilon_2)n$ .*

The following lemma shows that after spending enough energy the true segment will become

central.

**Lemma 7.** *Let  $\alpha$  and  $\beta$  satisfy (3). Then there exists a constant  $c > 0$  depending only on  $\alpha, \beta$  and  $t(n_1)$  such that if  $g(n_1, n) > c$ , then  $T(n)$  is central. Moreover, the length of the true segment at moment  $n$  is  $1 - o(1)$  as  $c \rightarrow \infty$ .*

Finally, we combine these two lemmas to obtain the main result.

**Theorem 8.** *Let the fraction of substitution errors be  $\tau \in [0, 1/3)$ . For any  $\varepsilon > 0$ , there exists  $\alpha \in [0, (3 - \sqrt{5})/2]$  such that for  $n$  sufficiently large, the encoding procedure over the adversarial substitution channel with feedback can correct  $\tau n$  errors with transmission rate at least  $R_s(\tau) - \varepsilon$ , where*

$$R_s(\tau) = \begin{cases} 1 - h(\tau), & \text{for } 0 \leq \tau \leq (3 - \sqrt{5})/4, \\ \log\left(\frac{1+\sqrt{5}}{2}\right)(1 - 3\tau), & \text{for } (3 - \sqrt{5})/4 < \tau \leq 1/3. \end{cases}$$

*Proof.* We choose  $M$  and accordingly  $t(0) = 1/M$  such that it satisfies  $2^{(R_s(\tau) - \varepsilon)n} < M < 2^{(R_s(\tau) - \varepsilon/2)n}$  and  $-\log(t(0)) < (R_s(\tau) - \varepsilon/2)n$ . By definition, we have that  $e(0, n) \leq \tau n$  and  $f(0, n) \geq (1 - \tau)n$ . For given  $\alpha$  and  $\beta$ , we can compute

$$g(0, n) = e(0, n) \log \alpha + f(0, n) \log \beta \geq (\tau \log \alpha + (1 - \tau) \log \beta)n.$$

Subject to the constraints  $\alpha + \beta = 2$  and  $\alpha\beta^2 \leq 1$ , the function  $\tau \log \alpha + (1 - \tau) \log \beta$  reaches the maximum  $R_s(\tau)$  when  $\alpha = 2 \min(\tau, (3 - \sqrt{5})/4)$  and  $\beta = 2 - \alpha$ . To make use of Lemma 6, we take  $\alpha$  slightly smaller than  $2 \min(\tau, (3 - \sqrt{5})/4)$  to have

$$g(0, n) = e(0, n) \log \alpha + f(0, n) \log \beta \geq \left(R_s(\tau) - \frac{\varepsilon}{10}\right)n > \frac{2}{5}\varepsilon n - \log t(0).$$

By applying Lemma 6 with  $\varepsilon_1 = 2\varepsilon/5$  and  $\varepsilon_2 = \varepsilon/5$ , there exists a constant  $\delta > 0$  such that for all but finite  $\alpha \in (0, 1)$ , there is a first moment  $n_1$  satisfying  $t(n_1) \geq \delta$  and furthermore

$$g(0, n_1) = e(0, n_1) \log \alpha + f(0, n_1) \log \beta < \frac{1}{5}\varepsilon n - \log t(0).$$

This implies that

$$g(n_1, n) = g(0, n) - g(0, n_1) = e(n_1, n) \log \alpha + f(n_1, n) \log \beta > \frac{1}{5}\varepsilon n$$

and, thus, for  $n$  sufficiently large, we conclude by Lemma 7 that  $T(n)$  is central.  $\square$

The key ingredient in the proof of Theorem 1 is Lemma 7. In order to prove it we introduce

several auxiliary functions

$$\begin{aligned}
u_1(i) &:= \log(t(i)/x(i)), \\
v_1(i) &:= \log 2t(i), \\
u_2(i) &:= \begin{cases} -\log 4x(i)y(i), & \text{if } y(i) \leq \frac{1}{2}, \\ \log((1-y(i))/x(i)), & \text{if } y(i) > \frac{1}{2}, \end{cases} \\
v_2(i) &:= \begin{cases} -\log 2y(i), & \text{if } y(i) \leq \frac{1}{2}, \\ \log 2(1-y(i)), & \text{if } y(i) > \frac{1}{2}. \end{cases}
\end{aligned}$$

We also define the constants  $u'_1 := \log(\beta - \alpha)$ ,  $u''_1 := \log(\beta/\alpha - 1)$ ,  $u'_2 := \log(\beta/\alpha)$ . Finally, define

$$\begin{aligned}
u(i) &:= \begin{cases} u_1(i), & \text{if } u_1(i) < u'_1, \\ u_2(i), & \text{if } u_1(i) \geq u'_1, \end{cases} \\
v(i) &:= \begin{cases} v_1(i), & \text{if } u_1(i) < u''_1, \\ v_2(i), & \text{if } u_1(i) \geq u''_1. \end{cases}
\end{aligned}$$

To show the validity of Lemma 7, we prove that the function  $v$  takes a large value at the last moment  $n$ , which happens if and only if  $l(n)$  and  $r(n)$  are small (c.f. Example 2).

**Proposition 2.** *If  $T(i-1)$  is central and there is a crossing, then  $v(i) - v(i-1) \geq -\log \beta$ ; otherwise,*

$$v(i) - v(i-1) \geq \begin{cases} \log \beta, & \text{if transmission is correct;} \\ \log \alpha, & \text{if transmission is incorrect;} \end{cases}$$

The change  $\Delta v(i) := v(i) - v(i-1)$  of the function  $v$  is equal to  $g(i-1, i)$ , except for the case when  $T(i-1)$  is central and there is a crossing. So, if the amount of such central crossings is small enough, then  $v(n)$  is close to  $g(n_1, n)$ . Thus,  $v(n)$  is large and we are done. To handle the case with a lot of central crossings, we use the function  $u$  and the following proposition.

**Proposition 3.** *If  $T(i-1)$  is central and there is a crossing, then  $u(i) - u(i-1) \geq \log \beta$ ; otherwise,  $u(i) - u(i-1) \geq 0$ .*

So, in this case the function  $u$  is big, which implies that the function  $u_2$  is also big. However, this is not enough to conclude that  $T(n)$  is central (c.f. Example 2). Consider the moment of the last central crossing. At this moment, the true segment can be shown to be also balanced, which means that the function  $v_2$  is close to  $u_2$ , i.e., it is also big. To make  $v_2$  small again, we must have a lot of incorrect transmissions due to Proposition 4.



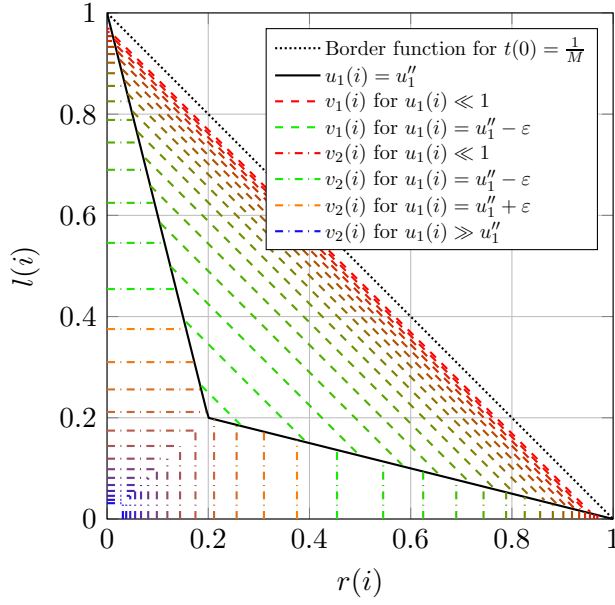

Figure 6: Illustration for level sets of the function  $v(i)$  for  $\tau = 0.15$ ,  $\alpha = 2\tau$ , and  $\beta = 2 - \alpha$ .

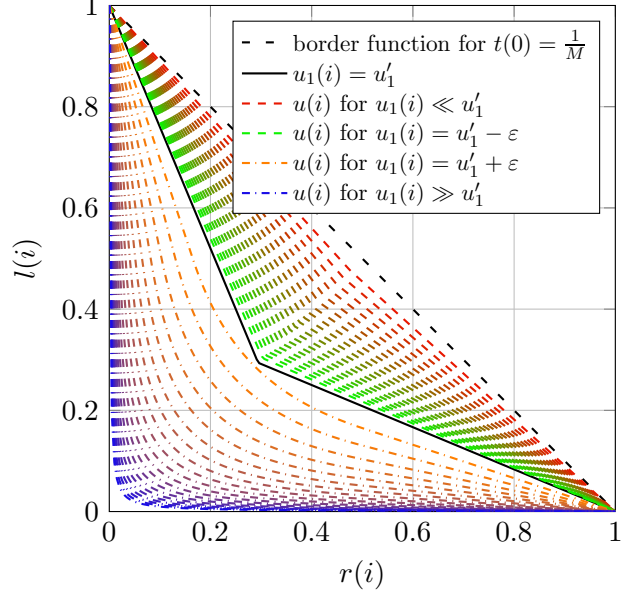

Figure 7: Illustration for level sets of the function  $u(i)$  for  $\tau = 0.15$ ,  $\alpha = 2\tau$ , and  $\beta = 2 - \alpha$ .

**Proposition 4.** *If there is a crossing and  $u_1(i-1) \geq u_1''$ , then  $v_2(i) - v_2(i-1) \geq -\log(\beta)$ . If there is no crossing, then*

$$v_2(i) - v_2(i-1) \geq \begin{cases} \log \beta & \text{if the transmission is correct;} \\ \log \alpha & \text{if the transmission is incorrect and } v_2(i-1) < \log \beta; \\ -\log \beta (\geq \log \alpha) & \text{if the transmission is incorrect and } v_2(i-1) \geq \log \beta. \end{cases}$$

Plenty of incorrect transmissions implies that we have a lot of energy left. Now we can use again Proposition 2, since there are no more central crossings, and, thus, conclude that the function  $v$  takes a large value after the last transmission.

**Example 2.** *Figures 6 and 7 illustrate different level sets of the functions  $v(i)$  and  $u(i)$ , respectively. We refer to a level set if  $v(i) = \text{const}$ , respectively  $u(i)$ . Note that we use the same color for the same level sets in the graphs. For high level sets of the function  $v(i)$ , we are close to the origin of the graph, which corresponds to  $l(i)$  and  $r(i)$  being small and the  $t(i)$  very large. In contrast, for high level sets of the function  $u(i)$ , we can only claim that we are close to an axis, i.e., either  $l(i)$  or  $r(i)$  is small. Notice that in case  $T(i)$  is central, we need to have  $l(i), r(i) < \frac{1}{2}$ . Combining the two figures for the level sets of  $v(i)$  and  $u(i)$ , it becomes clear that we need to prove that the function  $v(n)$  is large in order to conclude that after  $n$  transmissions  $T(n)$  is central.*

Many technical details were hidden in this discussion. In order to give a formal proof of Lemma 7, we need some additional propositions.

**Proposition 5.** *We have the following (trivial) properties.*

1. *If there is a crossing between  $T(i-1)$  and  $T(i)$ , then the transmission is correct.*
2. *If the transmission is correct, then the length of the true segment is increased, i.e.,  $t(i) > t(i-1)$ , otherwise it is decreased.*
3. *If  $T(i-1)$  is central,  $T(i)$  is not central and there is no crossing, then it follows that the transmission was incorrect.*
4. *The following inequalities always hold  $\alpha t(i-1) \leq t(i) \leq \beta t(i-1)$ .*
5. *For any  $x(i)$ ,  $y(i)$  and  $t(i)$ , inequalities  $u_2(i) \geq u_1(i)$  and  $v_2(i) \geq v_1(i)$  hold.*
6. *For any  $x(i)$ ,  $y(i)$  and  $t(i)$ , inequalities  $v_2(i) \geq v_1(i)$  and  $v_2(i) \geq v(i)$  hold.*

**Proposition 6.** *We have the following properties.*

1. *If  $T(i)$  is central, then  $u_2(i) \geq 2v_2(i)$ .*
2. *If  $T(i)$  is central and balanced, then  $u_2(i) < 2v_2(i) + \log(\beta/\alpha)$ .*
3. *If there is a crossing between moment  $i-1$  and moment  $i$ , then  $T(i-1)$  and  $T(i)$  are balanced.*
4. *If  $u_1(i-1) < u_1''$  (or  $u_1'$ ) and  $T(i-1)$  is central, and the transmission is correct, then there is a crossing between moment  $i-1$  and moment  $i$ .*
5. *If  $u_1(i-1) \geq u_1'$  (or  $u_1''$ ) and there is a crossing between moment  $i-1$  and moment  $i$ , then  $T(i)$  is central.*
6. *If  $u_1(i-1) \geq u_1''$  and there is a crossing between moment  $i-1$  and  $i$ , then  $T(i-1)$  is central and  $T(i)$  is central.*
7. *If  $u_2(i) \geq u_2'$  and there is either a crossing between moment  $i-1$  and moment  $i$ , or a crossing between moment  $i$  and moment  $i+1$ , then  $T(i)$  is central.*

**Proposition 7.** *If  $u_1(i-1) < u_1'$ , then  $u_1(i) - u_1(i-1) \geq 0$ . If in addition  $T(i-1)$  is central and there is a crossing, then  $u_1(i) - u_1(i-1) \geq \log(\beta)$ . On the other hand, if  $u_1(i-1) \geq u_1'$ , then  $u_1(i) \geq u_1'$ , and if  $u_1(i-1) \geq u_1''$ , then  $u_1(i) \geq u_1''$ .*

**Proposition 8.** *If  $u_1(i-1) \geq u_1'$ , then  $u_2(i) - u_2(i-1) \geq 0$ . If both  $T(i-1)$  and  $T(i)$  are central, then  $u_2(i) - u_2(i-1) = -\log(\alpha\beta)$ .*

**Proposition 9.** *Suppose  $u_1(i-1) < u_1''$ . If there is a crossing, then  $v_1(i) - v_1(i-1) > 0$ ; otherwise*

$$v_1(i) - v_1(i-1) \geq \begin{cases} \log(\beta) & \text{if the transmission is correct;} \\ \log(\alpha) & \text{if the transmission is incorrect.} \end{cases}$$

**Proposition 10.** *There exists a constant  $c = -5 \log(\alpha\beta)$  such that if both  $T(i_0)$  and  $T(i_1)$  are central and balanced, and  $u_2(i_0) \geq c$  then*

$$g(i_0, i_1) \leq u_2(i_1) - u_2(i_0). \quad (4)$$

The proof of lemmas and proposition are given in Section 4.4 and 4.5, respectively. At last, we provide a flowchart in Figure 8 to make it easier to understand the scheme of the proof.

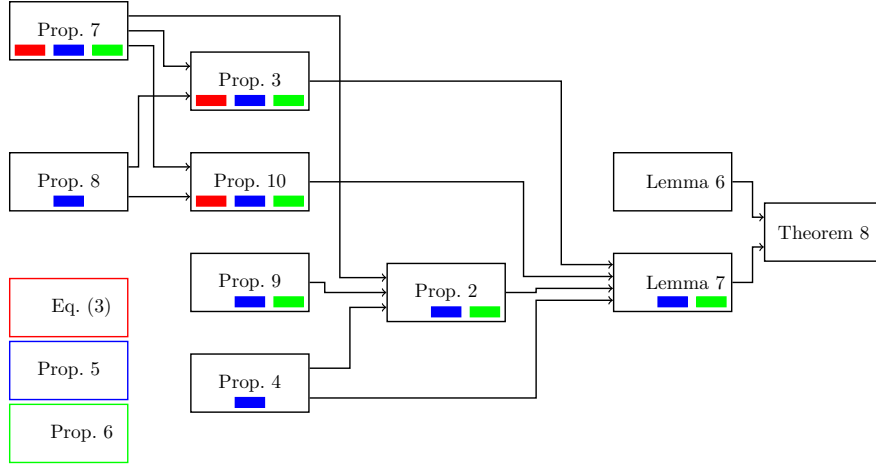

Figure 8: Illustration of the proof strategy for Theorem 8. For the inequality (3), Proposition 5, or Proposition 6 the arrows are omitted due to the sake of clarity. The small indicator boxes however show where they are used.

In prior of the technical proofs of the propositions, we provide in Example 3 an illustration for an example transmission, where we track the length of the true segment  $T(i)$  and its position.

**Example 3.** *We illustrate in Figure 9 an example transmission of a random message  $m$  out of  $M = 2^{14}$  for  $n' = 27$  total transmission. We use that  $\tau = 0.15$ ,  $\alpha = 2\tau$  and  $\beta = 2 - \alpha$ . Recall that  $t(i) = 1 - l(i) - r(i)$ . We have three bit-flip errors at the time steps  $i \in \{16, 21, 22\}$ . Since at the first transmission all segments are the same, thus  $t(0)$  lies close to the border function. For more and more bit transmissions, we see that the trajectory of  $t(i)$  is getting closer to the origin, meaning that its length is increasing. We have that  $T(i)$  is central at time step  $i = 15$  after multiple crosses before. Since at time step  $i = 16$  an error occurred, the trajectory leaves the central region. Furthermore, at the same time step, the trajectory crosscuts the level set  $u'_1$  and does not cross it again in later time steps (c.f. Proposition 7). The same behavior we observe if the level set  $u''_1$  is crosscut although we have errors at time steps  $i = 21, 22$ , which makes  $T(i)$  not central anymore (c.f. Proposition 7). For the remaining correct transmissions, we see that  $t(i)$  is always increasing until we reach the last  $n'$  transmission.*

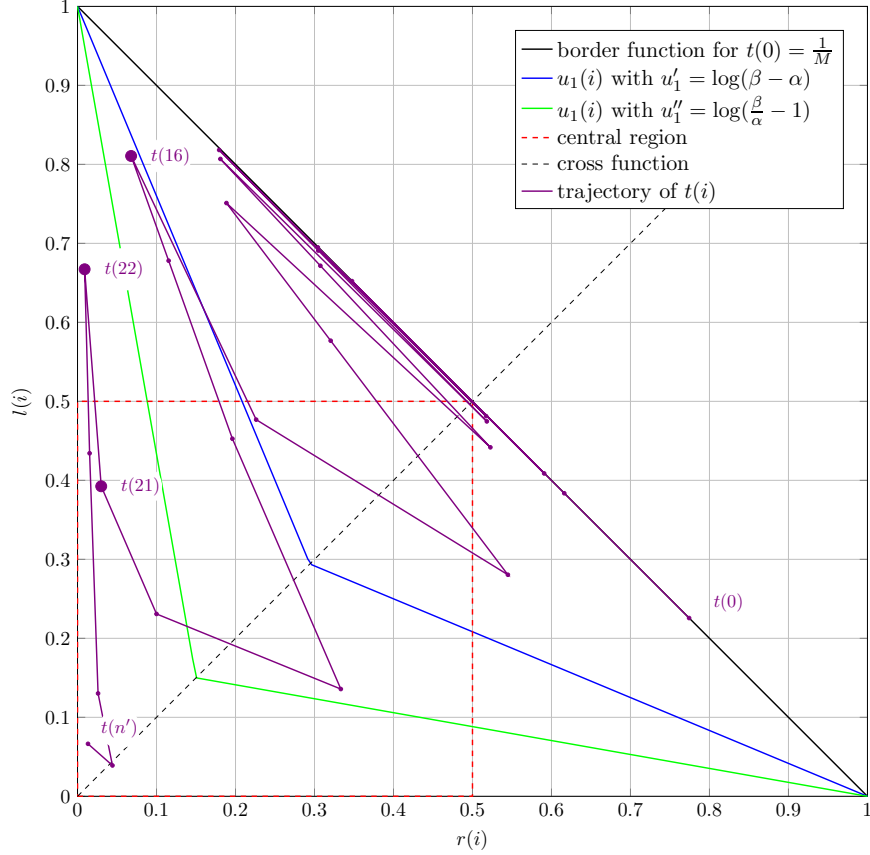

Figure 9: Illustration for a trajectory of  $t(i)$ . We have  $M = 2^{14}$  and transmit a random message, where we use  $n' = 27$  total transmissions. Errors occur at time steps 16, 21, and 22. Used parameters are  $\tau = 0.15$ ,  $\alpha = 2\tau$ , and  $\beta = 2 - \alpha$ .

#### 4.4 Proofs of lemmas

*Proof of Lemma 6.* We choose  $k \in \mathbb{N}$  such that  $k > \frac{\log \beta}{\varepsilon_2}$  for  $\varepsilon_1 > \varepsilon_2 > 0$ . Let us fix  $\delta < \frac{1}{\beta^2}$  which corresponds to the smallest displacement of the position  $\frac{1}{2}$  after  $1, 2, \dots, k - 1$  transmissions. One can prove that  $\delta > 0$  for all but finite  $\alpha \in (0, 1)$ . Remark that if  $\alpha$  is a non-algebraic number, then  $\delta > 0$  for any  $k$ .

Assume on the contrary that  $t(i) < \delta$  for  $i \in \{0, 1, \dots, n\}$ . We have by the definition of  $\delta$  that if  $T(i)$  is central, i.e., the point  $\frac{1}{2}$  is in  $T(i)$ , then  $T(i+1), \dots, T(i+k-1)$  are not central. Let us denote as  $n'$  the number of moments when  $T(i)$  is central. By the definition we know that  $n' \leq \frac{n}{k} + 1 < \frac{\varepsilon_1 n}{\log \beta} + 1$ . Therefore, we conclude

$$t(n) \geq t(0) \alpha^{e(0,n)} \beta^{f(0,n)-n'} \geq t(0) \alpha^{e(0,n)} \beta^{f(0,n) - \frac{\varepsilon_1 n}{\log \beta} - 1} \geq \frac{1}{\beta} > \delta,$$

where we used the fact that  $g(0, n) = e(0, n) \log \alpha + f(0, n) \log \beta > \varepsilon_1 n - \log t(0)$ . Hence, we come to a contradiction.

Let  $n_1$  be a first moment when  $t(n_1) \geq \delta$ . Applying the same strategy we can see that

$$\beta\delta > \beta t(n_1 - 1) \geq t(n_1) \geq t(0)\alpha^{e(0,n_1)}\beta^{f(0,n_1) - \frac{\varepsilon_2 n_1}{\log \beta} - 1}.$$

From the two aforementioned observations it follows that

$$g(0, n_1) < \varepsilon_2 n_1 - \log t(0) + \log \beta^2 \delta < \varepsilon_1 n - \log t(0) < g(0, n).$$

□

*Proof of Lemma 7.* Set  $I := \{i \in (n_1, n] : T(i-1) \text{ is central and there is a crossing between moments } i-1 \text{ and } i\}$ . Let  $m := |I|$ , and take  $c \gg m' \gg v'_2 \gg 1$ . One way to think about the choices of the parameters is to let  $c = x^3, m' = x^2, v'_2 = x$ , where  $x$  is sufficiently large relative to  $\alpha, \beta, t(n_1)$ .

**Case  $m \leq m'$ .** By Propositions 2 and 5.6, we have

$$v(n) \geq v(n_1) + e(n_1, n) \log \alpha + (f(n_1, n) - m) \log \beta - m \log \beta \geq \log 2t(n_1) + g(n_1, n) - 2m' \log \beta \gg 1,$$

which implies that  $T(n)$  is central.

**Case  $m > m'$ .** Let  $n_2$  be the  $m'$ 'th smallest element of  $I$ . By Propositions 3 and 5.5,

$$u_2(n_2) \geq u(n_2) \geq u(n_1) + m' \log \beta \geq \log 2t(n_1) + m' \log \beta = \Omega(m'),$$

which implies by Proposition 6.7 that  $T(n_2)$  is central and by Proposition 6.3 that  $T(n_2)$  is balanced. By Propositions 2, 5.6 and 6.1, we know that

$$\begin{aligned} g(n_1, n_2) &= v(n_2) - v(n_1) + 2m' \log \beta \leq v_2(n_2) - v_1(n_1) + 2m' \log \beta \\ &\leq \frac{1}{2}u_2(n_2) - \log 2t(n_1) + 2m' \log \beta \leq \frac{1}{2}u_2(n_2) + O(m'). \end{aligned} \quad (5)$$

Let  $n_3$  be the last element of  $I$ . We know that  $T(n_2)$  is central and balanced, and  $u_2(n_2) = \Omega(m')$ . The same conclusion holds for  $T(n_3)$ , in particular,  $T(n_3)$  is central and balanced, and  $u_2(n_3) = \Omega(m')$ . By Proposition 10, we obtain

$$g(n_2, n_3) \leq u_2(n_3) - u_2(n_2). \quad (6)$$

By Proposition 6.2, we derive that

$$v_2(n_3) \geq \frac{1}{2}u_2(n_3) - \frac{1}{2}\log(\beta/\alpha) = \Omega(m') \gg v'_2.$$

If  $v_2(n) \geq v'_2$ , we are done. Otherwise, let  $n_4 > n_3$  be a first moment when  $v_2(n_4) < v'_2$ . Since  $v_2(i) > 0$  for all  $i \in [n_3, n_4)$ ,  $T(i)$  is central for all such  $i$ . By the definition of  $I$ , there are no crossings between  $n_3$  and  $n_4$ . By Propositions 4 and 6.2 and the fact  $\alpha\beta < 1$ , we obtain

$$\begin{aligned} g(n_3, n_4) &= e(n_3, n_4) \log \alpha + f(n_3, n_4) \log \beta \leq 2(-e(n_3, n_4) + f(n_3, n_4)) \log \beta \\ &\leq 2v_2(n_4) - 2v_2(n_3) < -u_2(n_3) + O(v'_2). \end{aligned} \quad (7)$$

By the definition of  $I$ , there is no  $i \in (n_4, n]$  such that  $T(i-1)$  is central and there is a crossing between moments  $i-1$  and  $i$ . By Proposition 2, we have

$$g(n_4, n) \leq v(n) - v(n_4). \quad (8)$$

Since there is no crossing between  $n_4-1$  and  $n_4$ , by Proposition 4, we have  $v_2(n_4) \geq v_2(n_4-1) - \log \beta \geq v'_2 - \log \beta \gg 1$ . By the definition of  $v_2(n_4)$ , we know that  $y(n_4) \ll 1$  and so  $v_1(n_4) > 0$ , hence  $v(n_4) \geq 0$ . Adding up (5)-(8) and the fact that  $v(n_4) \geq 0$  yield

$$v(n) \geq g(n_1, n) - O(m') - O(v'_2) \geq v'_2,$$

which implies that  $T(n)$  is central. □

## 4.5 Proofs of propositions

*Proof of Proposition 5.* 1: If there is a crossing, then the smaller segment  $x(i)$  has been increased. It happens only when the transmission is correct.

2: We only proof the assertion for correct transmission because the case for incorrect transmission is proved analogously.

In case that  $T(i-1)$  is non-central the statement follows because  $t(i) = t(i-1)\beta$ . In case  $T(i-1)$  is central we have that

$$t(i) = 1 - \beta x(i-1) - \alpha y(i-1)$$

and therefore

$$t(i) - t(i-1) = (1 - \beta)x(i-1) + (1 - \alpha)y(i-1) = \frac{\beta - \alpha}{2}(y(i-1) - x(i-1))$$

where we have used that  $\alpha + \beta = 2$ .

3: We assume that the transmission is correct and there is no crossing. Then since  $T(i-1)$  is central it holds:

$$\begin{aligned} x(i-1)\beta &= x(i) \\ y(i-1)\alpha &= y(i) \end{aligned} \quad (9)$$

In order for  $T(i)$  to be non central it is necessary that  $y(i) > \frac{1}{2}$  but this leads to a contradiction due to (9) and because  $\alpha < 1$  and  $y(i-1) < \frac{1}{2}$ .

4: Let us consider first that  $T(i-1)$  is not central. Then it holds that

$$t(i) = \beta t(i-1)$$

in case the transmission was correct and

$$t(i) = \alpha t(i-1)$$

if the transmission was incorrect.

So let us now consider the case that  $T(i-1)$  is central. Without loss of generality assume that the left segment has been increased.

$$t(i) = 1 - \beta l(i-1) - \alpha r(i-1) = (1/2 - l(i-1))\beta + (1/2 - r(i-1))\alpha,$$

which leads to

$$t(i) = (1/2 - l(i-1))\beta + (1/2 - r(i-1))\alpha \leq \beta(1 - l(i-1) - r(i-1)) = \beta t(i-1)$$

and

$$t(i) = (1/2 - l(i-1))\beta + (1/2 - r(i-1))\alpha \geq \alpha(1 - l(i-1) - r(i-1)) = \alpha t(i-1).$$

5: Recall that

$$u_2(i) := \begin{cases} -\log 4x(i)y(i), & \text{if } y(i) \leq \frac{1}{2}, \\ \log((1 - y(i))/x(i)), & \text{if } y(i) > \frac{1}{2}. \end{cases}$$

We claim that

$$-\log(4x(i)y(i)) \geq \log((1 - y(i))/x(i)) .$$

The following statements are equivalent

$$\begin{aligned} \frac{1}{4x(i)y(i)} &\geq \frac{1 - y(i)}{x(i)} \\ 1 &\geq (1 - y(i))4y(i) \end{aligned}$$

and the last inequality follows because its right hand side is maximized for  $y(i) = \frac{1}{2}$ . This maximal value is equal to one and our claim follows.

It follows that  $u_2(i) \geq u_1(i)$  because

$$\frac{1 - y(i)}{x(i)} \geq \frac{t(i)}{x(i)} = \frac{1 - x(i) - y(i)}{x(i)} = 2^{u_1(i)} .$$

6: Recall that

$$v_2(i) := \begin{cases} -\log 2y(i), & \text{if } y(i) \leq \frac{1}{2}; \\ \log 2(1 - y(i)), & \text{if } y(i) > \frac{1}{2} . \end{cases}$$

Similar to the proof of Proposition 5.5 we show first that

$$-\log(2y(i)) \geq \log(2(1 - y(i))) . \tag{10}$$

The following statements are equivalent

$$\begin{aligned} \frac{1}{2y(i)} &\geq 2(1 - y(i)) \\ 1 &\geq 4y(i)(1 - y(i)) \end{aligned}$$

where the last inequality follows again because its right hand side is maximized for  $y(i) = \frac{1}{2}$ . This maximal value is again equal to one and we have shown inequality (10).

It follows that  $v_2(i) \geq v_1(i)$  because

$$\log(2(1 - y(i))) \geq \log(2(1 - x(i) - y(i))) = v_1(i) .$$

□

*Proof of Proposition 6.* 1: Since  $T(i)$  is central, we have  $y(i) \leq \frac{1}{2}$ . Thus,

$$u_2(i) = -\log 4x(i)y(i) \geq -\log 4y^2(i) = 2v_2(i).$$

2: Since  $T(i)$  is central and balanced, we have  $y(i) \leq \frac{1}{2}$  and  $y(i)/x(i) \leq \beta/\alpha$ . Hence,

$$\begin{aligned} u_2(i) &= -\log 4x(i)y(i) \\ &= -\log(4y^2(i)x(i)/y(i)) \\ &= -\log 4y^2(i) + \log(y(i)/x(i)) \\ &\leq 2v_2(i) + \log(\beta/\alpha). \end{aligned}$$

3: Without loss of generality, assume that  $l(i-1) < r(i-1)$  and  $l(i) > r(i)$ . This implies that  $l(i) = \beta l(i-1)$  and  $r(i) \geq \alpha r(i-1)$ . Then

$$\frac{y(i)}{x(i)} = \frac{l(i)}{r(i)} \leq \frac{\beta l(i-1)}{\alpha r(i-1)} \leq \frac{\beta r(i-1)}{\alpha r(i-1)} = \frac{\beta}{\alpha}.$$

This means that  $T(i)$  is balanced. Similarly, we check that  $T(i-1)$  is balanced

$$\frac{y(i-1)}{x(i-1)} = \frac{r(i-1)}{l(i-1)} \leq \frac{r(i)/\alpha}{l(i)/\beta} \leq \frac{\beta l(i)}{\alpha l(i)} = \frac{\beta}{\alpha}.$$

4: First we note that  $u'_1 < u''_1$ . Without loss of generality, assume that  $l(i-1) < r(i-1) \leq \frac{1}{2}$ . The condition  $u_1(i-1) \leq u''_1$  is equivalent to that

$$\frac{t(i-1)}{x(i-1)} = \frac{1 - l(i-1) - r(i-1)}{l(i-1)} = \frac{1 - r(i-1)}{l(i-1)} - 1 \leq \frac{\beta}{\alpha} - 1.$$

This implies  $\beta l(i-1) + \alpha r(i-1) \geq \alpha$  or  $\beta l(i-1) \geq \alpha - \alpha r(i-1)$ . Since the transmission is correct, we have  $l(i) = \beta l(i-1)$ . Thus,  $l(i) \geq \alpha - \alpha r(i-1)$ . Since  $r(i-1) \leq \frac{1}{2}$ , we have  $l(i) > \alpha/2 > \alpha r(i-1) = r(i)$ . This proves that there is a crossing between moment  $i-1$  and moment  $i$ .

5: Without loss of generality, we assume that  $l(i-1) \leq r(i-1)$ . From the condition  $u_1(i-1) \geq u'_1$ , we derive

$$\frac{1 - 2l(i-1)}{l(i-1)} \geq \frac{1 - l(i-1) - r(i-1)}{l(i-1)} = \frac{t(i-1)}{x(i-1)} \geq 2^{u'_1} = \beta - \alpha = 2\beta - 2$$

and  $l(i-1) \leq 1/(2\beta)$ . Since there is a crossing, we have  $\beta l(i-1) = l(i) \geq r(i)$  and, thus,  $y(i) = l(i) \leq \frac{1}{2}$ .



6: Without loss of generality, assume that  $l(i-1) < r(i-1)$  and  $l(i) \geq r(i)$ . First we note that a crossing may happen only when the transmission is correct. From condition  $u_1(i-1) \geq u_1''$  we derive that

$$\frac{t(i-1)}{x(i-1)} = \frac{1-l(i-1)-r(i-1)}{l(i-1)} = \frac{1-r(i-1)}{l(i-1)} - 1 \geq \frac{\beta}{\alpha} - 1.$$

This yields that  $\beta l(i-1) + \alpha r(i-1) \leq \alpha$ . Since the transmission is correct, we have  $l(i) = \beta l(i-1)$ , and, thus,  $l(i) + \alpha r(i-1) \leq \alpha$  or  $r(i-1) \leq 1 - l(i)/\alpha$ . Because of the property  $l(i) \geq r(i)$ , we get  $r(i-1) \leq 1 - r(i)/\alpha$ . Since  $r(i) \geq r(i-1)\alpha$ , we obtain  $r(i-1) \leq 1 - r(i-1)$ , which is equivalent to that  $T(i-1)$  is central. To show that  $T(i)$  is central, observe that  $u_1(i-1) \geq u_1'' \geq u_1'$  and we can use Proposition 6.5.

7: Suppose there is either a crossing between moment  $i-1$  and moment  $i$  or a crossing between moment  $i$  and moment  $i+1$ . Without loss of generality, assume that  $l(i) > r(i)$  and either  $l(i-1) < r(i-1)$  or  $l(i+1) < r(i+1)$ . Toward a contradiction, assume that  $T(i)$  is not central and, thus,  $y(i) = l(i) > \frac{1}{2}$ . The condition  $u_2(i) \geq u_2'$  is equivalent to that

$$\frac{1-y(i)}{x(i)} = \frac{1-l(i)}{r(i)} \geq \frac{\beta}{\alpha}.$$

This implies  $\alpha l(i) + \beta r(i) \leq \alpha$ . Since  $l(i) > \frac{1}{2}$ , we have either  $r(i) \geq \alpha r(i-1) > \alpha l(i-1) = \alpha l(i)/\beta \geq \alpha/(2\beta)$  or  $\beta r(i) = r(i+1) > l(i+1) \geq l(i)\alpha \geq \alpha/2$ . Thus, we obtain  $\alpha l(i) + \beta r(i) > \alpha/2 + \alpha/2 = \alpha$ . This contradicts our assumption and, hence,  $T(i)$  is central.  $\square$

*Proof of Proposition 7.* We consider first the part of the proposition where the condition  $u_1(i-1) < u_1'$  holds. There are several cases that need to be distinguished here. We first consider the case when an error occurred. Then  $t(i) \geq \alpha t(i-1)$  (Proposition 5.4) and  $x(i) = \alpha x(i-1)$  and thus,  $u_1(i) = \log(t(i)/x(i)) \geq \log(t(i-1)/x(i-1)) = u_1(i-1)$ . Next we proceed to the case that the transmission was correct. If there is no crossing, then by Proposition 6.4 we have that  $T(i-1)$  has to be non-central and, thus,  $t(i) = \beta t(i-1)$  and  $x(i) = \beta x(i-1)$ , which implies  $u_1(i) = u_1(i-1)$ .

Now suppose that there is a crossing and no error occurred. We consider the case that  $T(i-1)$  is not central. Because we have a crossing we know that  $x(i) < \beta x(i-1)$  and therefore

$$2^{u_1(i)} = \frac{t(i)}{x(i)} \geq \frac{\beta t(i-1)}{\beta x(i-1)} = \frac{t(i-1)}{x(i-1)} = 2^{u_1(i-1)}.$$

It remains to check the case when  $T(i-1)$  is central. By the statement we need to show

$$u_1(i) - u_1(i-1) = \log\left(\frac{1-x(i-1)\beta - y(i-1)\alpha}{y(i-1)\alpha}\right) - \log\left(\frac{1-x(i-1) - y(i-1)}{x(i-1)}\right) \geq \log(\beta)$$

This is equivalent to

$$(1-x(i-1)\beta - y(i-1)\alpha)x(i-1) \geq (1-x(i-1) - y(i-1))y(i-1)\alpha\beta$$

$$x(i-1)\frac{\beta-\alpha}{2}(y(i-1) - x(i-1)) \geq (1-x(i-1) - y(i-1))(y(i-1)\alpha\beta - x(i-1))$$

As the left hand side of this equation is always positive, we only have to consider the case where the right hand side has this property as well. Since  $u_1(i-1) < u'_1$  if we can prove that

$$y(i-1) - x(i-1) > 2(y(i-1)\alpha\beta - x(i-1)) \quad (11)$$

$$x(i-1) > y(i-1)(2\alpha\beta - 1) \quad (12)$$

we are done. Because there is a crossing we know that

$$x(i-1) > y(i-1)\frac{\alpha}{\beta}.$$

We show that  $2\alpha\beta - 1 < \frac{\alpha}{\beta}$ .

$$2\alpha\beta - 1 < \frac{\alpha}{\beta}$$

$$2\alpha\beta^2 - \beta < \alpha = 2 - \beta$$

$$\alpha\beta^2 < 1$$

where the last line follows from (3). This completes the first part of the proposition.

Now we assume that  $u_1(i-1) \geq u'_1$  and show that in this case  $u_1(i) \geq u'_1$ . We assume that the transmission was incorrect. Then

$$\frac{t(i)}{x(i)} \geq \frac{\alpha t(i-1)}{\alpha x(i-1)} = \frac{t(i-1)}{x(i-1)}.$$

Therefore, from now on we only consider successful transmissions. First, we have a look at the case that  $T(i-1)$  is not central. Then

$$\frac{t(i)}{x(i)} \geq \frac{t(i-1)\beta}{x(i-1)\beta} = \frac{t(i-1)}{x(i-1)}$$

where the inequality followed because  $\beta x(i-1) \geq x(i)$  with equality if there is no crossing and a strict inequality if there is a crossing. Therefore, we have shown the assertion for both cases.

Next we analyze the case where  $T(i-1)$  is central and there is no crossing.

$$\frac{t(i)}{x(i)} \geq \frac{t(i-1)}{\beta x(i-1)} \geq \frac{\beta - \alpha}{\alpha\beta} > \beta - \alpha$$

The first inequality follows because correct transmission can never reduce the length of the true segment. The second one follows because otherwise by Proposition 6.4 there would be a crossing and the last inequality follows because  $\alpha\beta < 1$ .

Next we consider the case that  $T(i-1)$  is central and there is a crossing. We observe that since there is a crossing  $T(i-1)$  is balanced by Proposition 6.3. Therefore,  $y(i-1)/x(i-1) < \beta/\alpha$ .

$$\frac{t(i)}{x(i)} = \frac{1 - x(i-1)\beta - y(i-1)\alpha}{y(i-1)\alpha} = \frac{1 - x(i-1)\beta}{y(i-1)\alpha} - 1 \quad (13)$$

Since  $u_1(i-1) \geq u'_1$  we obtain

$$\begin{aligned} \frac{1-x(i-1)-y(i-1)}{x(i-1)} &\geq \beta - \alpha \\ 1-x(i-1)-y(i-1) &\geq (\beta - \alpha)x(i-1) \\ 1-x(i-1) - \frac{\beta - \alpha}{2}x(i-1) - y(i-1) &\geq \frac{\beta - \alpha}{2}x(i-1) \\ 1 - \beta x(i-1) - y(i-1) &\geq \frac{\beta - \alpha}{2}x(i-1) . \end{aligned}$$

Therefore, we get

$$\frac{1-x(i-1)\beta}{y(i-1)\alpha} \geq \frac{\frac{\beta-\alpha}{2}x(i-1)+y(i-1)}{y(i-1)\alpha} = \frac{1}{\alpha} + \frac{x(i-1)\frac{\beta-\alpha}{2}}{y(i-1)\alpha} \quad (14)$$

By using the fact that  $T(i-1)$  is balanced we get

$$\frac{1}{\alpha} + \frac{x(i-1)\frac{\beta-\alpha}{2}}{y(i-1)\alpha} > \frac{1}{\alpha} + \frac{\beta - \alpha}{2\beta} = \frac{2\beta + \alpha\beta - \alpha^2}{2\alpha\beta} = \frac{(\alpha + \beta)\beta + \alpha\beta + \alpha^2 - 2\alpha^2}{2\alpha\beta} \quad (15)$$

which we simplify to

$$\begin{aligned} \frac{(\alpha + \beta)^2 - 2\alpha^2}{2\alpha\beta} &= \frac{2 - \alpha^2}{\alpha\beta} = 1 + \frac{2 - 2\alpha}{\alpha\beta} \\ &= 1 + \frac{\beta - \alpha}{\alpha\beta} > \beta - \alpha + 1 \end{aligned} \quad (16)$$

where the last inequality follows because  $1 > \alpha\beta$ . Combining equation (13) and the inequalities (14), (15), (16) completes the proof of this part.

Now we proof that if  $u_1(i-1) \geq u''_1$ , then  $u_1(i) \geq u''_1$ . Seeking for contradiction, assume  $u_1(i-1) \geq u''_1$  and  $u_1(i) < u''_1$ , i.e.,  $u_1$  is decreasing. The cases that  $T(i-1)$  is not central or the transmission was incorrect can be handled in the same manner as in the previous part of the proof. Therefore,  $T(i-1)$  is central and the transmission is correct.

The following inequalities are equivalent.

$$\begin{aligned} u_1(i-1) &\geq u''_1 = \log(\beta/\alpha - 1) \\ \frac{1-x(i-1)-y(i-1)}{x(i-1)} &\geq \beta/\alpha - 1 \\ \alpha &\geq \alpha y(i-1) + \beta x(i-1), \end{aligned}$$

i.e.,

$$u_1(i-1) \geq u''_1 \quad \Leftrightarrow \quad \alpha \geq \alpha y(i-1) + \beta x(i-1).$$

In the same manner, we can obtain

$$u_1(i) < u''_1 \quad \Leftrightarrow \quad \alpha < \alpha y(i) + \beta x(i).$$

Since  $T(i-1)$  is central and the transmission is correct, we conclude that  $\alpha y(i-1) + \beta x(i-1) = x(i) + y(i)$ . Using this equality results in a contradiction.

$$\alpha \geq \alpha y(i-1) + \beta x(i-1) = y(i) + x(i) \geq \alpha y(i) + \beta x(i) > \alpha.$$

□

*Proof of Proposition 8.* We are first considering the case that both  $T(i-1)$  and  $T(i)$  are central. Whether there occurs an error or not it holds that

$$u_2(i) - u_2(i-1) = -\log(4x(i-1)\beta y(i-1)\alpha) + \log(4x(i-1)y(i-1)) = -\log(\alpha\beta) > 0$$

as  $\alpha\beta < 1$ .

Now we consider the case that  $T(i-1)$  is central and  $T(i)$  is not central. Due to Proposition 6.5 there is no crossing and we know because of Proposition 5.3 that an error occurred.

It follows that

$$u_2(i) - u_2(i-1) = \log\left(\frac{1-y(i)}{x(i)}\right) + \log(4x(i-1)y(i-1)) = \log\left(\frac{(1-y(i))4y(i)}{\alpha\beta}\right)$$

and because  $T(i)$  is not central we have that  $\frac{1}{2} \leq y(i) \leq \frac{\beta}{2}$  where  $y(i) = \frac{\beta}{2}$  minimizes the last logarithm, leading to

$$\log\left(\frac{(1-y(i))4y(i)}{\alpha\beta}\right) \geq \log(1) = 0.$$

Next we are considering the case that  $T(i-1)$  is not central and there occurs a crossing. Without loss of generality we consider that  $l(i-1) < r(i-1)$ . Due to Proposition 6.5 we know that  $T(i)$  is central and therefore we only have to consider this case. Then

$$\begin{aligned} u_2(i) - u_2(i-1) &= -\log(4l(i)r(i)) - \log\left(\frac{1-r(i-1)}{l(i-1)}\right) = -\log\left(\frac{(1-r(i-1))4l(i)r(i)}{l(i-1)}\right) \\ &= -\log((1-r(i-1))4\beta r(i)). \end{aligned}$$

Next we use that  $r(i) = 1 - \beta(t(i-1) + l(i-1)) = \frac{\alpha}{2} + \beta\left(r(i-1) - \frac{1}{2}\right)$  and obtain

$$-\log((1-r(i-1))4\beta r(i)) = -\log\left((1-r(i-1))4\beta\left(\frac{\alpha}{2} + \beta\left(r(i-1) - \frac{1}{2}\right)\right)\right)$$

By looking at the quadratic form (in  $r(i-1)$ ) we find its maximum for  $r(i-1) = \frac{3\beta-\alpha}{4\beta}$  and

$$-\log\left((1-r(i-1))4\beta\left(\frac{\alpha}{2} + \beta\left(r(i-1) - \frac{1}{2}\right)\right)\right) \geq -\log\left((\beta + \alpha)\left(\frac{\alpha}{2} + \frac{\beta - \alpha}{4}\right)\right) = -\log(1) = 0.$$

The last two cases we have to look at is if  $T(i-1)$  is not central and there is no crossing and  $T(i)$  is central or not central. We obtain

$$u_2(i) - u_2(i-1) \geq \log\left(\frac{1-y(i)}{x(i)}\right) - \log\left(\frac{1-y(i-1)}{x(i-1)}\right) = 0$$

where the inequality holds because  $\frac{1}{4x(i)y(i)} \geq \frac{1-y(i)}{x(i)}$  which is essential to prove the statement for the case that  $T(i)$  is central. The equality on the right then follows because

$$1 - y(i) = x(i) + t(i) = \begin{cases} (x(i-1) + t(i-1))\beta & \text{for correct transmission} \\ (x(i-1) + t(i-1))\alpha & \text{for incorrect transmission} \end{cases}$$

as there is no crossing.

A similar result holds for  $x(i)$  and this concludes the proof. □

*Proof of Proposition 9.* If there is a crossing, then because the transmission has to be correct due to Proposition 5.1; in that case the true segment is enlarged by Proposition 5.2 and the first statement follows. For the second statement we first consider the case that  $T(i-1)$  is not central. Then it is clear that

$$v_1(i) - v_1(i-1) = \log(t(i)) - \log(t(i-1)) = \begin{cases} \log(\beta) & \text{if the transmission is correct} \\ \log(\alpha) & \text{if the transmission is incorrect} \end{cases}$$

The other case to be considered is if  $T(i-1)$  is central and there is no crossing. In that case the transmission has to be incorrect because otherwise a crossing would occur, according to Property 6.4. We have to show that

$$\log(t(i)) - \log(t(i-1)) \geq \log \alpha,$$

which is always true due to Proposition 5.4. □

*Proof of Proposition 4.* We first consider the case that there is a crossing and  $u_1(i-1) \geq u_1''$ . Due to Proposition 6.6 we know that  $T(i-1)$  and  $T(i)$  are both central.

It follows that

$$v_2(i) - v_2(i-1) = -\log(2x(i-1)\beta) + \log(2y(i-1)) \geq -\log \beta .$$

For the remainder of the proof we are considering cases without a crossing. We consider the case that  $T(i-1)$  and  $T(i)$  are central. We obtain that

$$v_2(i) - v_2(i-1) = \log \frac{y(i-1)}{y(i)} = \begin{cases} -\log \alpha \geq \log \beta & \text{if the transmission was correct} \\ -\log \beta \geq \log \alpha & \text{if the transmission was incorrect} \end{cases}$$

Next we consider the case that  $T(i-1)$  is central and  $T(i)$  is not central. This can only occur in the incorrect case (Proposition 5.3) and then

$$v_2(i) - v_2(i-1) = \log(2(1-y(i))) + \log(2y(i-1)) = \log(4(1-y(i))y(i)) - \log \beta$$

but since  $y(i-1) \leq \frac{1}{2}$  we know that  $y(i) \leq \frac{\beta}{2}$  and we get

$$\log(4(1-y(i))y(i)) - \log \beta \geq \log(\alpha\beta) - \log \beta = \log \alpha$$

The statement follows because the following statements are equivalent

$$\begin{aligned} v_2(i-1) &< \log \beta \\ -\log(2y(i-1)) &< \log \beta \\ \frac{1}{2} &< \beta y(i-1) = y(i) \end{aligned}$$

where the last line holds because  $T(i)$  is not central.

Now we consider the case that  $T(i-1)$  and  $T(i)$  are both not central and there is no crossing. In this case it holds that

$$\begin{aligned} v_2(i) - v_2(i-1) &= \log(2(1-y(i))) - \log(2(1-y(i-1))) = \log\left(\frac{t(i)+x(i)}{t(i-1)+x(i-1)}\right) \\ &= \begin{cases} \log \beta & \text{if the transmission was correct} \\ \log \alpha & \text{if the transmission was incorrect} \end{cases} \end{aligned}$$

We show that  $v_2(i-1) < \log \beta$ . In order to show this we use the fact that

$$\log(2(1-y(i-1))) \leq -\log(2y(i-1)) .$$

It follows that  $v_2(i-1) < \log \beta$  because the following statements are equivalent

$$\begin{aligned} -\log(2y(i-1)) &< \log \beta \\ \frac{1}{2y(i-1)} &< \beta \\ \frac{1}{2} &< \beta y(i-1) = y(i) \end{aligned}$$

where the last line is true because  $T(i)$  is not central.

Finally we consider the case that  $T(i-1)$  is not central but  $T(i)$  is central. We know that no error occurred in this case. Furthermore, recall that

$$-\log(2y(i)) \geq \log(2(1-y(i)))$$

and therefore we obtain

$$\begin{aligned} v_2(i) - v_2(i-1) &= -\log(2y(i)) - \log(2(1-y(i-1))) \geq \log\left(\frac{1-y(i)}{1-y(i-1)}\right) \\ &= \log \beta, \end{aligned}$$

which concludes the proof. □

*Proof of Proposition 10.* From Proposition 6.2 and the inequality (3) we deduce that

$$v_2(i_0) > u_2(i_0)/2 - \log(\beta/\alpha) = -\frac{1}{2} \log_2(\alpha^4 \beta^6) \geq -\frac{1}{2} \log \beta^{-2} = \log \beta.$$

Since  $v_2(i_0) = -\log 2y(i_0) > \log \beta$ , we have  $y(i_0) < 1/(2\beta)$ .

From  $y(i_0) < 1/(2\beta)$  we obtain that

$$u_1(i_0) = \log \frac{1 - y(i_0) - x(i_0)}{x(i_0)} \geq \log \frac{1 - 2y(i_0)}{y(i_0)} > u'_1$$

From Proposition 7 it follows that  $u_1(i) \geq u'_1$  for all  $i \geq i_0$ . Proposition 8 implies that  $u_2(i) \geq c$  for all  $i \geq i_0$  and  $v_2(i) > \log \beta$  for all  $i$  such that  $T(i)$  is central and balanced. Note that since  $c \geq u'_2$ , the inequality  $u_2(i) \geq u'_2$  holds.

Say that there are crossings at the moments  $j_1, \dots, j_k$ ,  $i_0 \leq j_1 < \dots < j_k < i_1$ . Partition  $[i_0, i_1)$  into the union  $[i_0, j_1) \cup [j_1, j_1 + 1) \cup [j_1 + 1, j_2) \dots [j_k, i_1)$ . By Proposition 6.3 and 6.7 all endpoints of this segments are central and balanced, and all conditions of Proposition 10 are satisfied. Moreover, if we prove the inequality (4) for these segments, it would also be true for their union. Therefore, it is sufficient to consider only two cases:

1.  $i_1 = i_0 + 1$  and there is a crossing.
2. there is no crossing between  $i_0$  and  $i_1$ .

The first case is trivial. There is a crossing between  $i_0$  and  $i_1 = i_0 + 1$ , hence the transmission is correct by Proposition 5.1. In this case  $g(i_0, i_1) = \log \beta$ . From the other hand  $u_2(i_1) - u_2(i_0) = -\log(\alpha\beta)$  by Proposition 8, which is at least  $\log \beta$  because of the inequality (3).

Proceed to the second case, where there is no crossing between  $i_0$  and  $i_1$ . The smallest part is always the same, therefore

$$g(i_0, i_1) = \log \alpha e(i_0, i_1) + \log \beta f(i_0, i_1) = \log \frac{x(i_1)}{x(i_0)}.$$

Denote  $v_2(i_1) - v_2(i_0)$  and  $u_2(i_1) - u_2(i_0)$  as  $\Delta v_2$  and  $\Delta u_2$  correspondingly. Since  $T(i_0)$  and  $T(i_1)$  are central, we have

$$\begin{aligned} \Delta u_2 &= -\log x(i_1)y(i_1) + \log x(i_0)y(i_0) \\ &= -\log y(i_1) + \log y(i_0) - \log \frac{x(i_1)}{x(i_0)} \\ &= \Delta v_2 - g(i_0, i_1), \end{aligned}$$

which is equivalent to

$$g(i_0, i_1) = \Delta v_2 - \Delta u_2.$$

Using Proposition 6.1 and 6.2 for moments  $i_1$  and  $i_0$  respectively, we obtain

$$g(i_0, i_1) = \Delta v_2 - \Delta u_2 \leq \frac{\Delta u_2 + \log \frac{\beta}{\alpha}}{2} - \Delta u_2 = \frac{-\Delta u_2 + \log \frac{\beta}{\alpha}}{2}.$$

Recall that  $y(i_0) < 1/(2\beta)$ , which implies that  $y(i_0 + 1) < \frac{1}{2}$ , i.e.,  $T(i_0 + 1)$  is central. Using Proposition 8, we deduce

$$\Delta u_2 = u_2(i_1) - u_2(i_0 + 1) + u_2(i_0 + 1) - u_2(i_0) \geq -\log(\alpha\beta).$$

Using this inequality and the inequality (3), we have

$$\begin{aligned} g(i_0, i_1) &\leq \frac{-\Delta u_2 + \log \frac{\beta}{\alpha}}{2} \leq \frac{\log(\alpha\beta) + \log \frac{\beta}{\alpha}}{2} \\ &= \log \beta \leq -\log(\alpha\beta) \leq \Delta u_2. \end{aligned}$$

□

*Proof of Proposition 3.* Recall that  $u_2(i) \geq u_1(i)$  for any  $x(i)$ ,  $y(i)$  and  $t(i)$  by Proposition 5.5.

If  $u_1(i-1) < u'_1$ , then  $u_1(i) \geq u_1(i-1)$  by Proposition 7, therefore,  $u(i) \geq u_1(i) \geq u_1(i-1) = u(i-1)$ . If  $T(i-1)$  is central and there is a crossing, then  $u_1(i) - u_1(i-1) \geq \log \beta$  by Proposition 7, hence,  $u(i) - u(i-1) \geq \log \beta$ .

If  $u_1(i-1) \geq u'_1$ , then  $u_1(i) \geq u'_1$  by Proposition 7 and  $u_2(i) \geq u_2(i-1)$  by Proposition 8. It means that  $u(i) = u_2(i) \geq u_2(i-1) = u(i-1)$ . If  $T(i-1)$  is central and there is a crossing, then  $T(i)$  is also central by Proposition 6.5. So, we can use Proposition 8, which gives us  $u_2(i) - u_2(i-1) \geq -\log(\alpha\beta)$ . Since  $\alpha\beta^2 \leq 1$ (see (3)), this expression is not less than  $\log \beta$ .

□

*Proof of Proposition 2.* Recall that  $v_2(i) \geq v_1(i)$  for any  $x(i)$ ,  $y(i)$  and  $t(i)$  by Proposition 5.6.

Suppose  $u_1(i-1) < u''_1$ . If there is no crossing, then the statement is implied by Proposition 9. If there is a crossing, then Proposition 9 gives us  $v_1(i) > v_1(i-1)$ , therefore,  $v(i) \geq v_1(i) > v_1(i-1) = v(i-1)$ , i.e.,  $v(i) - v(i-1) > 0$ . For central  $T(i-1)$  this bound is good enough. If  $T(i-1)$  is not central, then  $u_1(i) = u_1(i-1) < u'_1$  and  $v(i) - v(i-1) = v_1(i) - v_1(i-1)$ . Since there is a crossing, it is clear that transmission is correct; condition  $T(i-1)$  is not central implies that  $t(i) = \beta t(i-1)$  and  $v(i) - v(i-1) = v_1(i) - v_1(i-1) = \log \beta$ .

Suppose  $u_1(i-1) \geq u''_1$ . In this case  $u_1(i) \geq u''_1$  by Proposition 7. If there is no crossing, then proposition follows from Proposition 4. If there is a crossing, then  $T(i-1)$  is central by Proposition 6.6. In this case  $v(i) - v(i-1) = v_2(i) - v_2(i-1) \geq -\log \beta$  by Proposition 4.

□

## 5 Conclusion

In this paper, we have introduced a new problem statement of transmitting information through the adversarial insertion-deletion channel with feedback. We have shown a reduction of this problem to a problem of communication over the adversarial substitution channel. Thereby, the maximal asymptotic rate of feedback codes for the adversarial insertion-deletion channel has been established.



In particular, the rate is positive whenever the fraction of insertion and deletion errors inflicted by the channel is less than  $\frac{1}{2}$ . We also revisit Zigangirov’s algorithm [17] for the adversarial substitution channel with feedback and present a more elaborate version of his proof.

We emphasize that all results discussed in the paper concern the binary channel. A natural question that arises is whether it is possible to extend the methodology for the  $q$ -ary case. The best currently known results for the adversarial  $q$ -ary substitution channel with feedback are discussed in [20]. In particular, for the fraction of errors  $0 < \tau < 1/q$ , the maximal asymptotic rate is established only for a countable number of values for  $\tau$  and so far it remains an open question whether this rate is equal to the Hamming bound. Moreover, we point out that it is hard to generalize Zigangirov’s arguments to the  $q$ -ary case and, in particular, find appropriate analogues of functions  $u$  and  $v$ .

## 6 Acknowledgment

The authors are thankful to Zilin Jiang for the fruitful discussion on Zigangirov’s proof.

## References

- [1] V. I. Levenshtein, “Binary codes capable of correcting deletions, insertions, and reversals,” in *Soviet physics doklady*, vol. 10, no. 8, 1966, pp. 707–710.
- [2] R. Varshamov and G. Tenen Holtz, “A code for correcting a single asymmetric error,” *Automatica i Telemekhanika*, vol. 26, no. 2, pp. 288–292, 1965.
- [3] L. J. Schulman and D. Zuckerman, “Asymptotically good codes correcting insertions, deletions, and transpositions,” *IEEE Transactions on information theory*, vol. 45, no. 7, pp. 2552–2557, 1999.
- [4] B. Bukh and V. Guruswami, “An improved bound on the fraction of correctable deletions,” in *Proceedings of the Twenty-Seventh Annual ACM-SIAM Symposium on Discrete Algorithms*, 2016, pp. 1893–1901.
- [5] B. Bukh, V. Guruswami, and J. Håstad, “An improved bound on the fraction of correctable deletions,” *IEEE Transactions on Information Theory*, vol. 63, no. 1, pp. 93–103, 2016.
- [6] R. G. Gallager, “Sequential decoding for binary channels with noise and synchronization errors,” Massachusetts Inst. Tech. Lexington Lincoln Lab, Tech. Rep., 1961.
- [7] K. Zigangirov, “Sequential decoding for a binary channel with drop-outs and insertions,” *Problemy Peredachi Informatsii*, vol. 5, no. 2, pp. 23–30, 1969.

- [8] E. Drinea and M. Mitzenmacher, “Improved lower bounds for the capacity of iid deletion and duplication channels,” *IEEE Transactions on Information Theory*, vol. 53, no. 8, pp. 2693–2714, 2007.
- [9] S. N. Diggavi and M. Grossglauser, “On transmission over deletion channels,” in *Proceedings of the Annual Allerton Conference on Communication Control and Computing*, vol. 39. Citeseer, 2001, pp. 573–582.
- [10] Y. Kanoria and A. Montanari, “Optimal coding for the binary deletion channel with small deletion probability,” *IEEE Transactions on Information Theory*, vol. 59, no. 10, pp. 6192–6219, 2013.
- [11] M. Rahmati and T. M. Duman, “An improvement of the deletion channel capacity upper bound,” in *2013 51st Annual Allerton Conference on Communication, Control, and Computing (Allerton)*, 2013, pp. 1221–1225.
- [12] M. Cheraghchi, “Capacity upper bounds for deletion-type channels,” in *Proceedings of the 50th Annual ACM SIGACT Symposium on Theory of Computing*, 2018, pp. 493–506.
- [13] M. Cheraghchi and J. Ribeiro, “An overview of capacity results for synchronization channels,” *IEEE Transactions on Information Theory*, 2020.
- [14] V. Guruswami and R. Li, “Coding against deletions in oblivious and online models,” in *Proceedings of the Twenty-Ninth Annual ACM-SIAM Symposium on Discrete Algorithms*. Society for Industrial and Applied Mathematics, 2018, pp. 625–643.
- [15] Z. Wang and R. B. Lee, “Capacity estimation of non-synchronous covert channels,” in *25th IEEE International Conference on Distributed Computing Systems Workshops*, 2005, pp. 170–176.
- [16] E. R. Berlekamp, “Block coding with noiseless feedback,” Ph.D. dissertation, Massachusetts Institute of Technology, 1964.
- [17] K. Zigangirov, “On the number of correctable errors for transmission over a binary symmetrical channel with feedback,” *Problemy Peredachi Informatsii*, vol. 12, no. 2, pp. 3–19, 1976.
- [18] M. Horstein, “Sequential transmission using noiseless feedback,” *IEEE Transactions on Information Theory*, vol. 9, no. 3, pp. 136–143, 1963.
- [19] J. Schalkwijk, “A class of simple and optimal strategies for block coding on the binary symmetric channel with noiseless feedback,” *IEEE Transactions on Information Theory*, vol. 17, no. 3, pp. 283–287, 1971.
- [20] V. S. Lebedev, “Coding with noiseless feedback,” *Problems of Information Transmission*, vol. 52, no. 2, pp. 103–113, 2016.