

N-BEATS neural network for mid-term electricity load forecasting

Boris N. Oreshkin^a, Grzegorz Dudek^b, Paweł Pełka^b

^a*Unity Technologies, 1751 Rue Richardson suite 3.500, Montreal, Quebec H3K 1G6, e-mail: boris.oreshkin@gmail.com*

^b*Department of Electrical Engineering, Czestochowa University of Technology, 42-200 Czestochowa, Al. Armii Krajowej 17, Poland, e-mail: dudek@el.pcz.czest.pl, p.pelka@el.pcz.czest.pl*

Abstract

We address the mid-term electricity load forecasting (MTLF) problem. This problem is relevant and challenging. On the one hand, MTLF supports high-level (e.g. country level) decision-making at distant planning horizons (e.g. month, quarter, year). Therefore, financial impact of associated decisions may be significant and it is desirable that they be made based on accurate forecasts. On the other hand, the country level monthly time-series typically associated with MTLF are very complex and stochastic — including trends, seasonality and significant random fluctuations. In this paper we show that our proposed deep neural network modeling approach based on the N-BEATS neural architecture is very effective at solving MTLF problem. N-BEATS has high expressive power to solve non-linear stochastic forecasting problems. At the same time, it is simple to implement and train, it does not require signal preprocessing. We compare our approach against the set of ten baseline methods, including classical statistical methods, machine learning and hybrid approaches on 35 monthly electricity demand time series for European countries. We show that in terms of the MAPE error metric our method provides statistically significant relative gain of 25% with respect to the classical statistical methods, 28% with respect to classical machine learning methods and 14% with respect to the advanced state-of-the-art hybrid methods combining machine learning and statistical approaches.

Keywords: mid-term load forecasting, neural networks, deep learning

1. Introduction

Continuous balancing of electricity consumption and production is a prerequisite for the stability and efficiency of power systems. Maintaining the balanced system is a serious challenge, made even more difficult in recent years by an increasing share of volatile, fluctuating renewable energy sources. The key requirement for balancing the power system is to have reliable forecasts of demand as well as generation from renewable sources at any time point. Accurate forecasts allow us to avoid costs related to energy shortage or its oversupply. A study from the California Energy Commission indicates potential savings of USD 2 million yearly with improved solar and load forecasting [36]. Another report [29], analyzing the California Independent System Operator market, shows that the total cost savings from improved short-term wind power forecasting can be from the range of USD 5.05 to 146 million yearly depending on the wind power. Therefore, accurate forecasts of electricity demand and supply are of great importance not only in ensuring the safe and efficient operation of the system, but also in increasing market revenues and reducing financial risks.

In this work, we consider mid-term load forecasting (MTLF), focusing on monthly electricity demand forecasting over 12 months horizon. MTLF is necessary for power system operation and planning in such areas as maintenance scheduling, mid-term hydro thermal coordination, fuel reserve planning, energy import and export planning, and security assessment. In deregulated power systems, the market for bilateral contracts, where the time frame for contracts reaches several years, needs MTLF for the negotiation of forward contracts between generators and retailers or large consumers [4]. Forecast accuracy translates directly into financial performance for the energy market players. The financial impact can be measured in millions of dollars for every point of forecasting accuracy gained.

1.1. MTLF models

All the above-mentioned reasons justify interest in new accurate methods for load forecasting, especially MTLF. MTLF approaches can be divided into two general categories [23]: conditional modeling approach and autonomous modeling approach. The former focuses on economic analysis, management and long term planning and forecasting of energy load and energy policies. It takes into account as the model inputs socioeconomic conditions that affect the energy demand. Among them are [23], [22]: gross national product, consumer price index, exchange rates and average wage. Also the weather variables and the variables

describing the network infrastructure and power system operation can be introduced. The latter include: the number and length of transmission lines, number of highest voltage stations, number of connections, reserve margin and load diversity factor. Examples of the conditional modelling can be found in [32], where a knowledge-based expert system is applied to identifying forecasting algorithms and the key input variables; [10], where multiple linear regression and ARIMA models employing weather and economic input variables are used; or [35], where the heuristic model was proposed using economical, weather and power system data.

In autonomous modeling, the prediction of electricity demand is primarily based on historical demand and weather data. This approach is more appropriate for stable economies, with no sudden changes affecting electricity demand. Some examples of such models include [21], where classical approach (ARIMA) and neural networks (NNs) use load profiles, weather factors (temperature and humidity) and the time index as input variables; or [17], where historical demand, atmospheric temperatures, and variables expressing seasonality are used as inputs to NN model. The most parsimonious models in this category use only historical demand or only weather variables. An example of the former can be found in [26], and latter in [11].

The approaches described above use classical statistical and econometric models as well as models based on machine learning and computational intelligence [44]. The first group includes ARIMA, exponential smoothing (ETS), and linear regression. The first two models can deal with seasonal time series but linear regression requires additional operations for this, such as decomposition, local approach [18], or extension of the model with periodic components [6]. In [10] linear regression was compared with ARIMA in MTLF. Both models used the same set of input variables, which included past loads, weather, and economic data. ARIMA turned out to be about twice as accurate as linear regression.

Classical models have inherent shortcomings related to limited adaptability and shortage of expressive power to model non-linear relationships. This prompted researchers to take an interest in more flexible machine learning and computational intelligence models [26]. Of these, NNs are the most explored in the field of forecasting. They have many attractive properties such as ability to model non-linear relationships and learn from data, universal approximation property and massive parallelism. Some examples of using classical NN architectures to MTLF include [25], where two separate multilayer perceptrons (MLPs) are used for forecasting a trend and seasonal fluctuations of the monthly electricity demand, respectively; [12], where MLP predicts the future monthly loads using heuristic

search algorithms for learning; [22], where the Kohonen NN learns on the past loads and microeconomic indicators; [17], where MLP with regularization is supported by fuzzy logic; [11], where weighted evolving fuzzy NNs were applied; and [2], where NNs are combined with linear regression and AdaBoost.

1.2. Deep learning solutions useful for MTLF

A great success of deep learning in the complicated modeling tasks in recent years, encourages their use for complex forecasting problems. Deep learning includes modern NN architectures, which are composed of the combinations of basic structures such as MLPs, recurrent NNs (RNNs) and convolutional NNs. They are more complex than classical architectures and use complex mechanisms for learning. But thanks to this, they can overcome the limitations of classical NNs such as lack of expressive power that prevents the effective extraction of information from datasets containing many time-series. RNNs equipped with dynamic memory and shared weights across time steps and across time-series can handle sequences of varying lengths and are able to exhibit temporal dynamic behavior [27]. To improve the learning process of RNNs which suffers from the vanishing or exploding gradient problem when processing long sequences, long short-term memory network (LSTM) was proposed [28]. LSTM architecture is composed of a cell and several non-linear gates that control the data flow inside the cell and decide on what information should be kept and what should be propagated to the next time step. LSTMs have seen huge success in a wide range of applications including forecasting. They outperform statistical and machine learning models such as ARIMA, support vector machine and classical NNs [46]. It is worth noting that the forecasting models based on LSTMs won the M4 forecasting competition in 2018 [43] which utilized 100,000 real-life time series, and incorporated all major forecasting methods. There are many examples of using LSTM models in load forecasting: [7], [47], [38], and [20].

In addition to the NN architectures mentioned above, the following state-of-the-art deep architectures are considered the most promising and useful for forecasting [8]:

- WaveNet architecture originally proposed for speech synthesis [39], and recently adapted to time series forecasting [9], [3]. WaveNet uses the so-called dilated causal convolutions to learn the long range dependencies. Due to convolutions, the training is very efficient on highly parallel computer architectures such as GPUs. These advantages make WaveNet more competitive to RNNs which struggle with learning long range dependencies and cannot exploit highly parallel architectures due to their sequential nature.

- Encoder-decoder attention mechanism [14] and transformers [45]. The encoder (an RNN), learns a representation of the input sequence while the decoder (another RNN) is trained to predict the target sequence using the representation learned by the encoder. An attention helps to learn which parts of the input sequence is the most relevant to produce a correct prediction at the current time step. Transformer model uses attention in combination with feed-forward NNs to achieve state-of-the-art results. The encoder-decoder attention mechanism is extended to intra- or self-attention to learn where to focus in order to get good feature representations. To improve the transformer performance for forecasting some modifications were introduced in [33].
- N-BEATS, which is a deep neural architecture based on backward and forward residual links and a deep stack of fully-connected layers [40]. The basic building block of N-BEATS consists of a fully-connected network that terminates with backward and forward layers producing the backcast and forecast outputs. Blocks are organized into stacks using doubly residual stacking principle. Forecasts are aggregated in hierarchical fashion. This enables building a very deep NN with interpretable outputs.

1.3. Work motivation and contributions

The motivation for this work is as follows. Accurate load forecasts are of utmost importance to ensure a safe and efficient power system operation, increased revenues from the electricity market, and financial risk reduction. The accuracy of forecasts translates directly into financial gains measured in millions of dollars for every point of forecasting accuracy gained. MTLF is a relevant and challenging problem requiring the forecasting model to be highly flexible and deal with the stochastic data expressing non-stationarity and seasonality. In this work, we propose a state-of-the-art forecasting model for MTLF that meets these high requirements, N-BEATS NN. As mentioned above, this model is considered one of the most promising deep architecture for forecasting. The experimental results presented in [40] showed that N-BEATS demonstrates state-of-the-art performance for challenging competition datasets containing tens of thousands of time series from diverse domains. It outperformed statistical models as well as state-of-the-art machine learning and hybrid models.

The contributions of this study includes the following two points:

1. This work empirically demonstrates that N-BEATS using no time-series specific components outperforms in MTLF well-established statistical ap-

proaches as well as state-of-the-art domain-adjusted machine learning and hybrid approaches.

2. To adapt N-BEATS to the MTLF specificity we introduce a new pinball-MAPE loss function, which allows the model to minimize directly MAPE (our main performance metric) and reduce the forecast bias.

The rest of the work is organized as follows. Section 2 describes the MTLF problem and data. Section 3 presents the proposed N-BEATS NN for MTLF. The experimental framework used to evaluate the performance of the proposed model is described in Section 4. Finally, Section 5 concludes the work.

2. MTLF Problem Statement

Monthly electricity demand time series exhibits a non-linear trend, seasonality and a random component. The trend depends on the country's economic growth rate and climate change, such as global warming caused by greenhouse gas emissions and other factors [13]. Seasonalities are related to the local climate and weather variability [5] and structure of customers. Among factors disturbing electricity demand time series are: unpredictable economic events, extreme weather conditions, and political decisions [16].

Fig. 1 demonstrates an example of the monthly electricity demand time series. From this figure we can observe an upward trend and changing yearly patterns over the years. Also the dispersion of the yearly cycles changes significantly over time, from $\sigma = 696$ to 1484 MWh. Decomposition of this time series using STL method (seasonal and trend decomposition using Loess [15]; see Fig. 2) reveals strong seasonal component (S_t). The ratio of its variance to the total variance of the series is 77%. This ratio for the trend (T_t) is 16%, and for the random component (R_t) is 7%.

In the experimental part of our study, we use dataset of 35 monthly electricity demand time series for European countries (data source: www.entsoe.eu). The time series are presented in Fig. 3. They differ substantially in:

- level; the mean monthly demand changes from 343 (ME) to 43702 MWh (DE),
- dispersion; the mean yearly standard deviations changes from 72 (LU) to 6581 MWh (FR),
- autocorrelation; the lag 12 autocorrelation (yearly period) changes from 0.09 (ME) to 0.92 (CH),

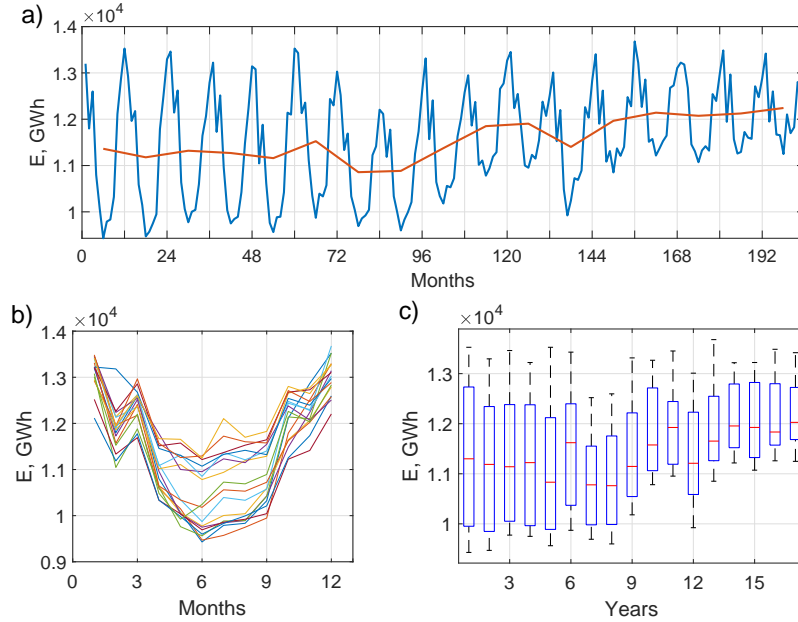

Figure 1: Monthly electricity demand time series for Poland (a), its yearly patterns (b), and dispersion in successive years (c).

- share of the trend, seasonal and random components; the highest share of the trend (over 80%) is for ES, PT, NL, and IT, the highest share of the seasonal component (over 90%) is for NO, FI, EE, SE, and IE, and countries with a high share of the random component (over 30%) are ME, NI, and RS,
- length; from 5 (12 countries) to 24 years (11 countries),
- similarity of the yearly pattern.

Construction of the forecasting model for such times series is a challenging task. This problem becomes especially difficult when the time series is short, contains strong random fluctuations, and irregular spikes such as for BA, DK, IS, ME, NI, and SI time series, see Fig. 3.

The MTLF forecasting task is formulated given a length- H forecast horizon and a length- T observed time-series history $[y_1, \dots, y_T] \in \mathbb{R}^T$. The task is to predict the vector of future values $\mathbf{y} \in \mathbb{R}^H = [y_{T+1}, y_{T+2}, \dots, y_{T+H}]$ given past observations. For simplicity, we will later consider a *lookback window* of length $w \leq T$ ending with the last observed value y_T to serve as model input, and denoted $\mathbf{x} \in \mathbb{R}^w =$

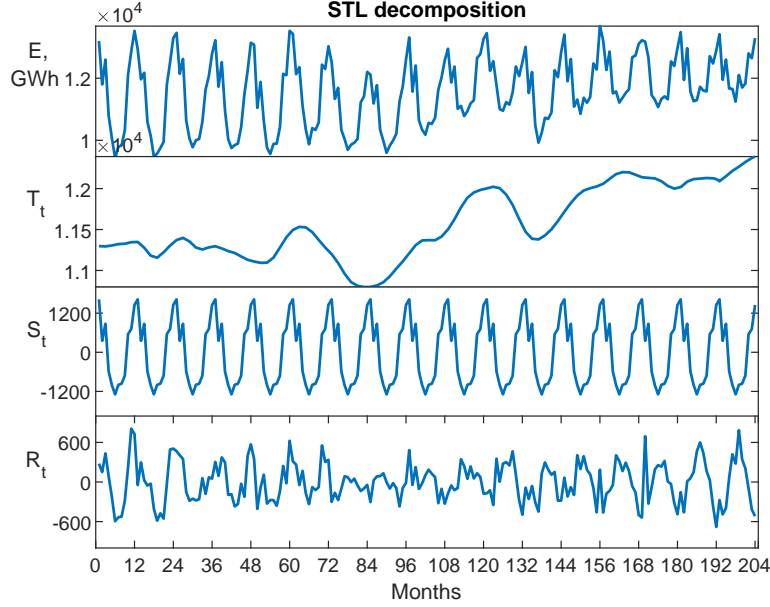

Figure 2: STL decomposition of the monthly electricity demand time series for Poland.

$[y_{T-w+1}, \dots, y_T]$. We denote $\hat{\mathbf{y}}$ the point forecast of \mathbf{y} . Its accuracy is evaluated with MAPE, the mean absolute percentage error [34],

$$\text{MAPE} = \frac{100}{H} \sum_{i=1}^H \frac{|y_{T+i} - \hat{y}_{T+i}|}{|y_{T+i}|}. \quad (1)$$

3. N-BEATS for MTLF

3.1. N-BEATS Architecture

N-BEATS architecture is different from the existing architectures in a few respects. First, instead of treating forecasting as a sequence-to-sequence problem, we treat it as a non-linear multivariate regression problem. Therefore, the basic building block of the architecture (see Fig. 4, left) is a fully-connected non-linear regressor that accepts the history of a time-series and outputs multiple points in the forecasting horizon. Second, most existing time-series architectures are relatively shallow (one to five LSTM layers, for example). We use residual principle to stack many layers together (see Fig. 4, right). For this, the basic block predicts both the future outputs and its contribution to the decomposition of the input, which we

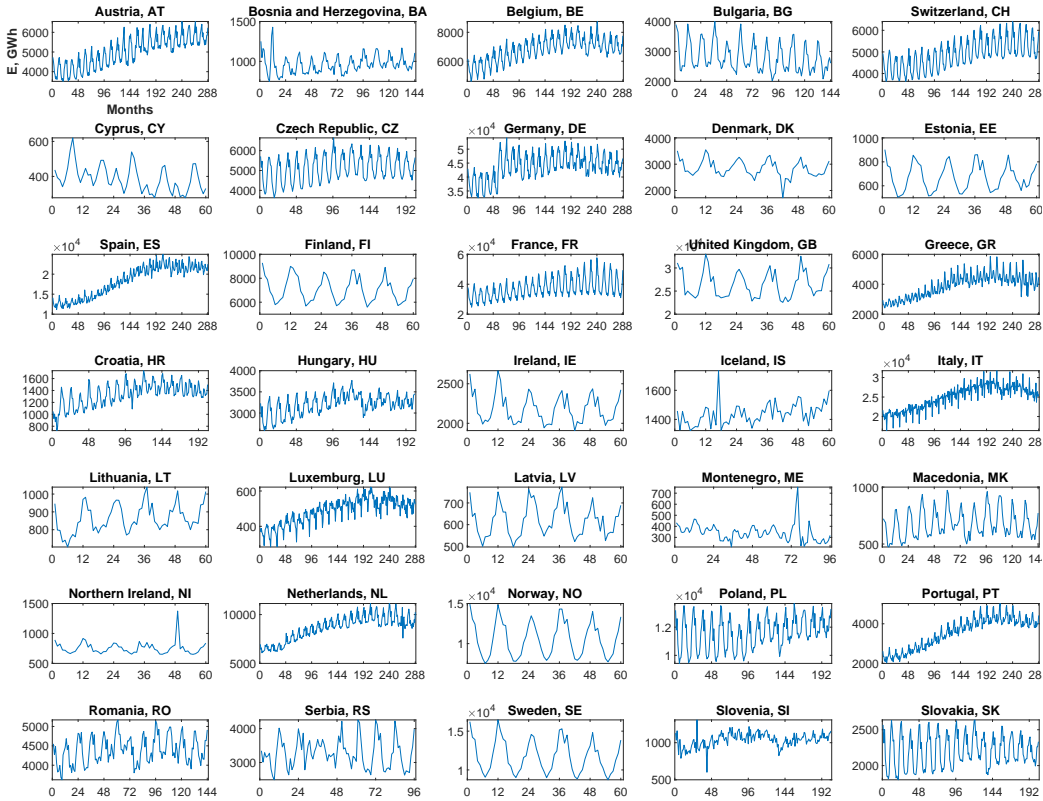

Figure 3: Monthly electricity demand time series for European countries.

call backcast. It was demonstrated in [40] that we can stack on the order of hundred layers effectively using this principle, resulting in a very expressive model having very good generalization capabilities. Another advantage of the architecture is its simplicity that shows both at the conceptual and at the implementation levels. Conceptually, we can think about each fully connected layer as a multivariate linear regression block followed by a ReLu [37, 24] non-linearity. Therefore, N-BEATS can be thought of as simply being a multivariate regression repeated many times and interleaved with non-linearities. The conceptual simplicity translates in the implementation simplicity. The architecture can be coded in just 40 lines of code in the standard TensorFlow [1] syntax, as follows from the python code listing of N-BEATS model presented in Listing 1 of Appendix A.

In terms of mathematical description, each block of N-BEATS is a sequence of fully connected layers, making a forecast/backcast fork at the end. The architecture

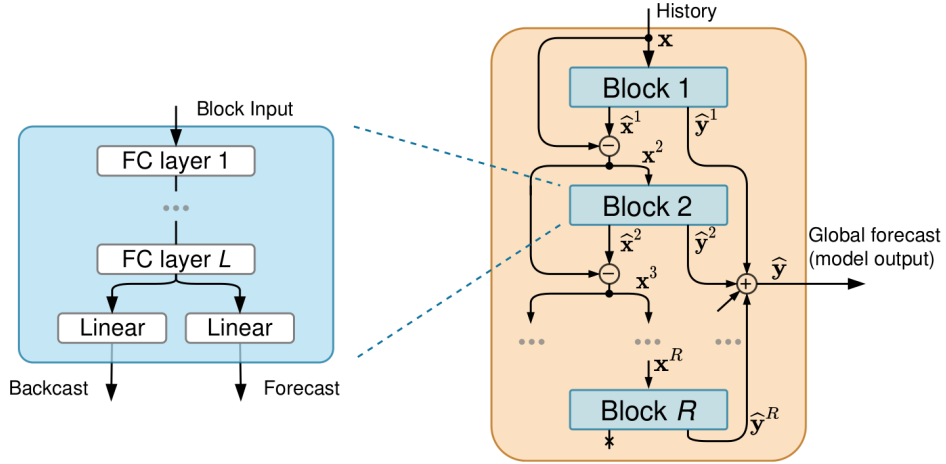

Figure 4: N-BEATS block diagram

runs a residual recursion over the entire input window and sums block outputs to make its final forecast (see Fig. 4). We assume that each residual block has L hidden layers per block and R residual blocks. Referring, as previously, to \mathbf{x} as the input of the architecture, using residual block and layer superscripts (r and ℓ respectively) and denoting the fully connected layer with weights $\mathbf{W}^{r,\ell}$ and biases $\mathbf{b}^{r,\ell}$ as $\text{FC}_{r,\ell}(\mathbf{h}^{r,\ell-1}) \equiv \text{RELU}(\mathbf{W}^{r,\ell}\mathbf{h}^{r,\ell-1} + \mathbf{b}^{r,\ell})$, the operation of N-BEATS is described as follows:

$$\begin{aligned}
 \mathbf{x}^r &= \text{RELU}[\mathbf{x}^{r-1} - \hat{\mathbf{x}}^{r-1}], \\
 \mathbf{h}^{r,1} &= \text{FC}_{r,1}(\mathbf{x}^r), \dots, \mathbf{h}^{r,L} = \text{FC}_{r,L}(\mathbf{h}^{r,L-1}), \\
 \hat{\mathbf{x}}^r &= \mathbf{B}^r \mathbf{h}^{r,L}, \hat{\mathbf{y}}^r = \mathbf{F}^r \mathbf{h}^{r,L}.
 \end{aligned} \tag{2}$$

We assume $\hat{\mathbf{x}}^0 \equiv \mathbf{0}$, $\mathbf{x}^0 \equiv \mathbf{x}$; projection matrices have dimensions $\mathbf{B}^r \in \mathbb{R}^{w \times d_h}$, $\mathbf{F}^r \in \mathbb{R}^{H \times d_h}$ and the final forecast is the sum of forecasts of all residual blocks, $\hat{\mathbf{y}} = \sum_r \hat{\mathbf{y}}^r$.

3.2. Pinball-MAPE loss function

MAPE is a well-established performance metric for forecasting problems [34] and it is the most commonly used accuracy measure in load forecasting. Training using MAPE as a loss function while MAPE is used for performance evaluation may be beneficial, because training and performance evaluation metric objectives are maximally aligned. Yet, this may result in forecasts that are biased, since forecast

bias minimization is not directly instigated by MAPE. To alleviate this problem, we propose a pinball-MAPE (P-MAPE) evaluated over N samples:

$$\text{P-MAPE}(y, \hat{y}) = \frac{1}{N} \sum_{i=1}^N \begin{cases} 200 \cdot \tau(y_i - \hat{y}_i)/y_i & \text{if } y_i \geq \hat{y}_i \\ 200 \cdot (1 - \tau)(\hat{y}_i - y_i)/y_i & \text{otherwise} \end{cases} \quad (3)$$

The τ parameter in the P-MAPE loss can be adjusted on the validation set to compensate biases arising from the training on MAPE loss. P-MAPE loss with $\tau = 0.5$ is equivalent to the MAPE loss. Setting $\tau \in (0, 0.5)$ will tend to compensate over-estimation bias and setting $\tau \in (0.5, 1)$ will tend to compensate under-estimation bias. We conjecture that a similar approach may be employed with other loss functions (sMAPE, RMSE, etc.). Note that the use of lower τ values to avoid over-forecasting with the MAE based training was proposed by Smyl [43].

4. Experimental Results

In this section, we apply the proposed N-BEATS model to MTLF and compare its performance with other models based on classical statistical methods and machine learning methods. The models are applied to the real-world data collected from `www.entsoe.eu` and comprise monthly electricity demand for 35 European countries. The dataset is split into train, validation and test subsets. The test subset is constructed by cutting the last horizon of each of the 35 time-series (twelve months of 2014). The validation and train subsets for each dataset are obtained by splitting their full train sets at the boundary of the last horizon of each time-series. Thus we treat the twelve months of 2013 as a validation subset. We use the train and validation subsets to tune hyperparameters. Once the hyperparameters are determined, we train the model on the full train set and report results on the test set.

4.1. Training setup

The model is trained using the Adam optimizer with default tensorflow 2.0 settings and initial learning rate of 0.001 for 20 epochs. The learning rate is annealed by a factor of 2 every 2 epochs starting at epoch 15. One epoch consists of 50 batches of size 256 and the model takes the history of 12 points (12 month; $w = 12$) and predicts 12 points (12 month; $H = 12$) ahead in one shot. Each training batch is assembled using weighted stratified sampling over time-series IDs. First, 256 time-series IDs are sampled with replacement and the probability of

sampling a given time series is proportional to the length of the time-series. Second, the split time point is chosen uniformly at random for each of the time-series IDs sampled in the previous step.

The weighted stratified sampling of time-series is important, because each time-series has a different length. A training sample is formed by splitting a given time-series at a split point, feeding history window preceding the split point in the network and computing a loss using the values following the split point. Obviously, smaller time-series will generate a smaller number of unique training samples. Therefore, we should not sample time-series IDs uniformly. If we do, then each sample from a short time series will be used to adjust the training loss more times, on average. Thus the model will be overfitting on shorter time series more than on the longer ones. The weighted stratified sampling solves this problem by making sure that each training sample is used to adjust training loss the same number of times, on average¹.

The N-BEATS model described in detail in Section 3 is evaluated in this section with the following settings of hyperparameters. The hidden layer width d_h for all fully connected layers is set to 512. The number of layers L in each residual block and the number of residual blocks R both equal to 3. We do not use weight decay, instead, the regularization is achieved via ensemble of 64 models. Each of the models in the ensemble is trained using a different random initialization and a different random sequence of batches. The objective function used to train the network is pinball MAPE with $\tau = 0.35$ described in Section 3.2 (see eq. (3)), averaged over all forecasts in the batch within horizon $H = 12$. All the hyperparameters were adjusted based by minimizing the MAPE on the validation set.

Due to the stochastic nature of N-BEATS, all results reported for this model take averages over 100 trials. In each trial we build an ensemble of 64 models bootstrapped from the set of 1024 trained models.

4.2. Baseline models

The baseline models that we use in our comparative studies are outlined below.

- ARIMA – ARIMA(p, d, q)(P, D, Q)₁₂ model implemented in function `auto.arima`

¹Similar effect can be achieved by creating all viable training samples from all time-series and by putting them in a flat table. The batches can then be assembled by uniformly sampling the rows of the flat table. For a simple in-memory data loader, this is appropriate for smaller datasets, but for larger datasets may quickly inflate the RAM usage.

in R environment (package `forecast`). This function implements automatic ARIMA modeling which combines unit root tests, minimization of the Akaike information criterion (AICc) and maximum likelihood estimation to obtain the optimal ARIMA model [30].

- ETS – exponential smoothing state space model [31] implemented in function `ets` (R package `forecast`). This implementation includes many types of ETS models depending on how the seasonal, trend and error components are taken into account. They can be expressed additively or multiplicatively, and the trend can be damped or not. As in the case of `auto.arima`, `ets` returns the optimal model estimating its parameters using AICc.
- k -NNw+ETS – a hybrid model combining k -nearest neighbor weighted regression and ETS [19]. It uses pattern representation of time series. Patterns which express unified yearly cycles are forecasted using k -NN with linear weighted function. The mean yearly load and yearly dispersion are both forecasted using ETS. The model hyperparameters are: input pattern length and number of nearest neighbors k .
- FNM+ETS – a hybrid model combining fuzzy neighborhood model for pattern forecasting and ETS for yearly mean and dispersion forecasting [19]. In this case, a non-parametric regression function aggregates all training patterns using a Gaussian-type membership function as a weighting function. The model hyperparameters are: input pattern length and membership function width.
- N-WE+ETS – a hybrid model combining Nadaraya–Watson estimator for pattern forecasting and ETS for yearly mean and dispersion forecasting [19]. For pattern forecasting, N-WE estimates the regression function as a locally weighted average, using a Gaussian kernel function as a weighting function. The model hyperparameters are: input pattern length and kernel bandwidth parameters.
- GRNN+ETS – a hybrid model combining general regression NN for pattern forecasting and ETS for yearly mean and dispersion forecasting [19]. In this case, GRNN with Gaussian nodes is used for pattern forecasting. The model hyperparameters are: input pattern length and bandwidth parameter for nodes.

- MLP – multilayer perceptron with a single hidden layer and sigmoidal neurons [42]. It works on pattern representation of the time series and uses Levenberg-Marquardt learning method with Bayesian regularization to prevent overfitting. The MLP hyperparameters are: input pattern length and number of hidden nodes. We use Matlab R2018a implementation of MLP (function `feedforwardnet` from Neural Network Toolbox).
- ANFIS – adaptive neuro-fuzzy inference system [41]. The initial membership function parameters in the premise parts of rules are determined using fuzzy *c*-means clustering. A hybrid learning method is applied for ANFIS training which uses a combination of least-squares for consequent parameters and backpropagation gradient descent method for premise parameters. The ANFIS hyperparameters are: input pattern length and number of rules. The Matlab R2018a implementation of ANFIS was used (function `anfisc` from Fuzzy Logic Toolbox).
- LSTM – long short-term memory. A standard LSTM model is used where the responses are the training sequences with values shifted by one time step. For multiple time steps, previous prediction was used as input and the LSTM state was updated after each step. LSTM was optimized using Adam optimizer. The length of the hidden state was the only hyperparameter to be tuned. Other hyperparameters remain at their default values. The experiments were carried out using Matlab R2018a implementation of LSTM (function `trainNetwork` from Neural Network Toolbox).
- ETS+RD-LSTM – a hybrid residual dilated LSTM and ETS model [20]. This model, inspired by the winning submission to the M4 forecasting competition 2018, combines ETS, advanced LSTM and ensembling. ETS extracts dynamically the main components of each individual time series and enables the model to learn their representation. Multi-layer LSTM is equipped with dilated recurrent skip connections and a spatial shortcut path from lower layers to allow the model to better capture long-term seasonal relationships and ensure more efficient training. We use C++ implementation of the model provided by Slawek Smyl [43].

The hyperparameters of the comparative models were selected on the training set in grid search procedures.

4.3. Results

Forecasting quality metrics averaged over 35 countries are presented in Table 1. They include: median of absolute percentage error (APE), MAPE, interquartile range of APE (IQR) as a measure of the forecast dispersion, root mean square error (RMSE) and mean percentage error (MPE). Note the lowest values for each error measure and IQR for N-BEATS. It clearly outperforms all other models in accuracy. MAPE below 4% for N-BEATS should be considered a major achievement. The second most accurate model is N-WE+ETS with MAPE = 4.37%. Similar errors, below 4.5%, gave other hybrid models combining ETS and machine learning. The best results for N-BEATS were confirmed by computing bootstrapped confidence intervals for the difference in the MAPE metric between the baseline methods and N-BEATS. None of the 99% confidence intervals overlap zero (see MAPE Diff column in Table 1). Therefore, we conclude that the difference in MAPE between N-BEATS and other models is statistically significant at level $\alpha = 0.01$.

MPE shown in Tab. 1 allows us to assess the bias of the forecasts produced by the proposed and baseline models. All the models produced negatively biased forecasts, which means overprediction. Note the lowest bias for N-BEATS, MPE = -0.34%, while the biases for the other models exceed -1%. In the case of N-BEATS the t -test did not reject the null hypothesis that PE comes from a normal distribution with zero mean ($\alpha = 0.01$). All other models did not pass this test. Therefore, it can be concluded that N-BEATS, as the only model, produced unbiased forecasts. Note that N-BEATS has the mechanism to deal with bias included in the loss function P-MAPE (3). P-MAPE asymmetry is controlled by parameter τ . Its optimal value was selected as 0.35, which allowed the model to reduce the negative bias significantly.

MAPE and MPE distributions over 100 trials are characterized for N-BEATS in Tab. 2. They are compared with distributions achieved for N-BEATS with a standard pinball loss function. Note much lower errors for the proposed model with P-MAPE: the highest MAPE and MPE achieved for this model are lower than the corresponding minimal errors achieved for N-BEATS with pinball loss. N-BEATS in both versions is quite stable, i.e. the mean errors obtained in the individual runs are narrowly distributed (see low Std and tight confidence intervals in Tab. 2). This is because N-BEATS is an ensemble-based model combining in the proposed version 64 base models. A great advantage of ensemble learning is reducing variance of predictions and also generalization error. Comparing a standard deviations of errors for the pool of individual base models and for the ensemble model, we observe a significant reduction:

Table 1: Forecasting metrics. All MAPE difference results between N-BEATS and other algorithms are statistically significant at 1% level as follows from the 99% confidence intervals presented in column MAPE Diff. The confidence intervals are computed using 100k sample bootstrap sampled with replacement from the difference in APE between baseline algorithms and N-BEATS.

| Model | Median APE | MAPE | IQR | RMSE | MPE | MAPE Diff |
|-------------|-------------|-------------|-------------|---------------|--------------|--------------------------------------|
| ARIMA | 3.32 | 5.65 | 5.24 | 463.07 | -2.35 | 1.87 ^{3.10} _{1.01} |
| ETS | 3.50 | 5.05 | 4.80 | 374.52 | -1.04 | 1.27 ^{1.76} _{0.81} |
| k-NNw+ETS | 2.71 | 4.47 | 3.52 | 327.94 | -1.25 | 0.69 ^{1.25} _{0.18} |
| FNM+ETS | 2.64 | 4.40 | 3.46 | 321.98 | -1.26 | 0.63 ^{1.19} _{0.14} |
| N-WE+ETS | 2.68 | 4.37 | 3.36 | 320.51 | -1.26 | 0.59 ^{1.14} _{0.11} |
| GRNN+ETS | 2.64 | 4.38 | 3.51 | 324.91 | -1.26 | 0.61 ^{1.14} _{0.13} |
| MLP | 2.97 | 5.27 | 3.84 | 378.81 | -1.37 | 1.49 ^{2.62} _{0.72} |
| ANFIS | 3.56 | 6.18 | 4.87 | 488.75 | -2.51 | 2.40 ^{3.56} _{1.41} |
| LSTM | 3.73 | 6.11 | 4.50 | 431.83 | -3.12 | 2.33 ^{2.98} _{1.73} |
| ETS+RD-LSTM | 2.74 | 4.48 | 3.55 | 347.24 | -1.11 | 0.70 ^{1.40} _{0.15} |
| N-BEATS | 2.55 | 3.78 | 3.30 | 309.91 | -0.34 | – |

- for N-BEATS with P-MAPE, Std MAPE was reduced from 0.2102 to 0.0303, and Std MPE from 0.3873 to 0.0479,
- for N-BEATS with pinball loss, Std MAPE was reduced from 0.1655 to 0.0216, and Std MPE from 0.3454 to 0.0392.

Fig. 5 shows errors for each country. As we can see from this figure, N-BEATS for most countries is one of the most accurate models. In 16 out of 35 cases it outperforms all other models. The average ranks of the models in the rankings for individual countries are shown in Fig. 6. The rankings were performed for MAPE and RMSE. In both cases N-BEATS is in the first position with a large advantage over the other models.

Fig. 6 shows mean errors for each month of the test period. Characteristically for this data set, electricity demands in August-October are predicted with lower errors and demand in February is predicted with the highest error. Noteworthy are the excellent results for N-BEATS, which produces the most accurate forecasts for 7 months. For February it gives MAPE = 4.74%, while the second-best model, ARIMA, gives MAPE = 5.88%.

Table 2: MAPE and MPE distributions for N-BEATS.

| MAPE | N-BEATS P-MAPE | N-BEATS pinball loss | MPE | N-BEATS P-MAPE | N-BEATS pinball loss |
|------|-------------------|-------------------------|------|-------------------|-------------------------|
| Mean | 3.78 | 4.01 | Mean | -0.34 | -0.80 |
| Std | 0.0303 | 0.0216 | Std | 0.0479 | 0.0392 |
| Min | 3.70 | 3.96 | Min | -0.23 | -0.73 |
| 5% | 3.74 | 3.97 | 5% | -0.25 | -0.75 |
| 25% | 3.75 | 3.99 | 25% | -0.31 | -0.78 |
| 50% | 3.78 | 4.01 | 50% | -0.34 | -0.80 |
| 75% | 3.80 | 4.02 | 75% | -0.37 | -0.83 |
| 95% | 3.83 | 4.04 | 95% | -0.41 | -0.87 |
| Max | 3.85 | 4.06 | Max | -0.47 | -0.91 |

Examples of forecasts for selected countries are depicted in Fig. 8. For PL, FR, DE and ES, N-BEATS produced the most accurate forecasts. Note outlier forecasts of LSTM for IT, and the classical models, ARIMA and ETS, for PL. For GB, the forecasts of all models were underestimated. This results from the fact that demand went up unexpectedly in 2014 despite the downward trend observed in the previous period from 2010 to 2013. The reverse situation for FR caused a slight overestimation of forecasts. For GB, N-BEATS with MAPE = 8.10% was one of the least accurate models.

4.4. Discussion

The results presented in Subsection 4.3 clearly show the best performance of N-BEATS over statistical, classical machine learning, and hybrid methods. It outperforms the baseline models in accuracy and unbiased forecast distribution. The success of N-BEATS should be sought in the new architecture based on backward and forward residual links, a deep stack of fully-connected layers, and ensembling. The architecture can be applicable without modification to a wide range of target domains, including MTLF, which was confirmed in this study.

N-BEATS does not require decomposition of the time series as well as any data preprocessing. Many statistical and machine learning approaches do not work with time series exhibiting non-stationarity, non-linear relationships between input and output variables, or seasonal variations. They require additional preliminary steps such as differencing, detrending, deseasonalization, or decomposition. Sometimes these procedures are included in the model structure as in the case of the ETS or similarity-based methods [19]. N-BEATS deals with raw time series

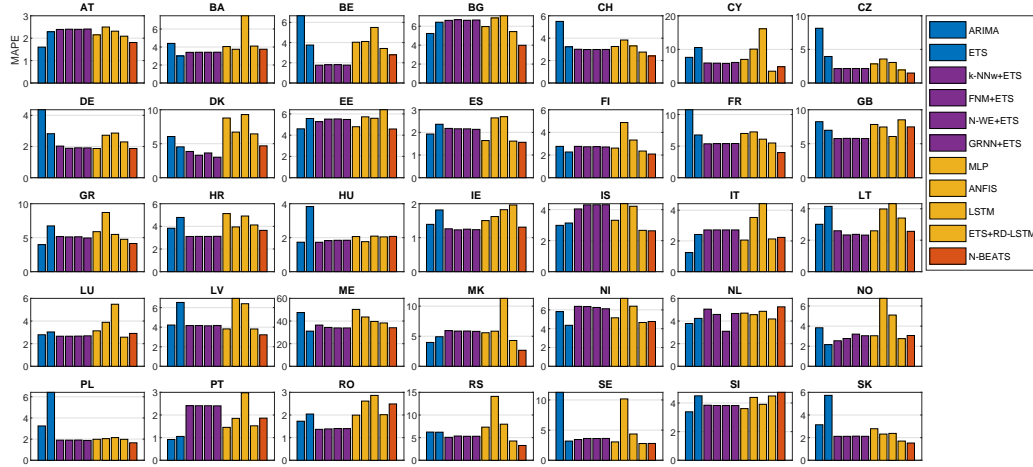

Figure 5: MAPE for each country

processing them properly using built-in mechanisms such as non-linear mapping on several levels, residual links, forecast and backcast paths, and aggregation of the partial forecasts. This, together with the final ensembling, leads to accurate forecasts.

In this work, we modify the original N-BEATS implementation by introducing the pinball-MAPE loss function (3). It allows N-BEATS to minimize directly MAPE, which we selected as the main MTLF performance metric, and to reduce the forecast bias. When comparing to the standard pinball loss, P-MAPE significantly reduces both MAPE and forecast bias (see Tab. 2). Note that N-BEATS can implement any loss function (sMAPE, RMSE, etc.) in a pinball version. This allows the model to be optimized for any forecasting problem with a specific quality metric incorporating the bias.

In this study, we confirmed that training a deep learning model on multiple time series (cross-learning) successfully leads to transferring and sharing individual learnings. All other models excluding ETS+RD-LSTM are trained and optimized separately for a single time series. The cross-learning enables the method to capture the shared features and components of the time series. It also speeds up learning and optimization of the model which is especially important for the complex deep learning models with a huge number of parameters and hyperparameters.

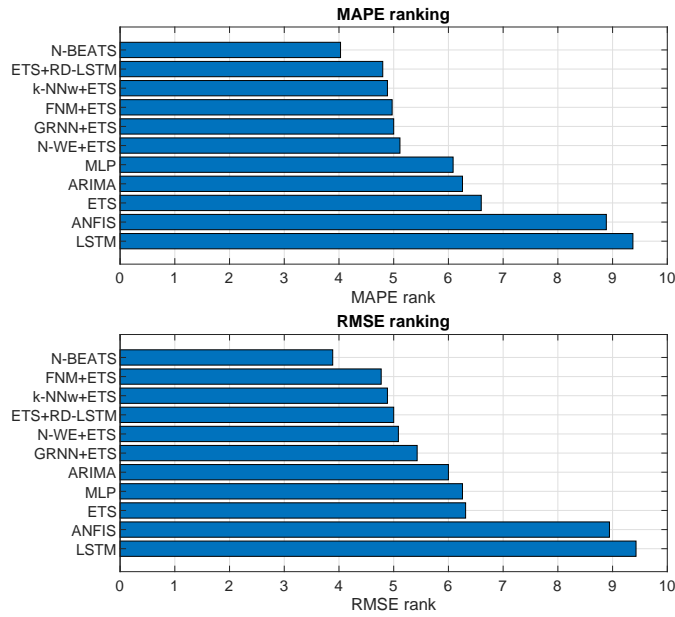

Figure 6: Rankings of the MTLF models

N-BEATS was proposed in two configurations: generic and interpretable [40]. In this study, we use a generic variant with the aim of validating the hypothesis that the generic deep learning approach performs exceptionally well on MTLF problem using no domain knowledge. The interpretable N-BEATS configuration forces a deep learning model to decompose its forecast into distinct human interpretable outputs, i.e. trend and seasonal components. MTLF using interpretable N-BEATS, as very useful for power system operators and practitioners, will be the subject of future work.

5. Conclusions

Accurate load forecasts are of great importance in ensuring the safe and efficient power system operation, increasing electricity market revenues, and reducing financial risks. Mid-term load forecasting considered in this work is a challenging problem requiring the forecasting model to be highly flexible and deal with non-stationarity and seasonality. In this study, we proposed and empirically validated a new architecture for MTLF responding to these expectations, N-BEATS neural network.

The empirical study including the MTLF problem for 35 European countries

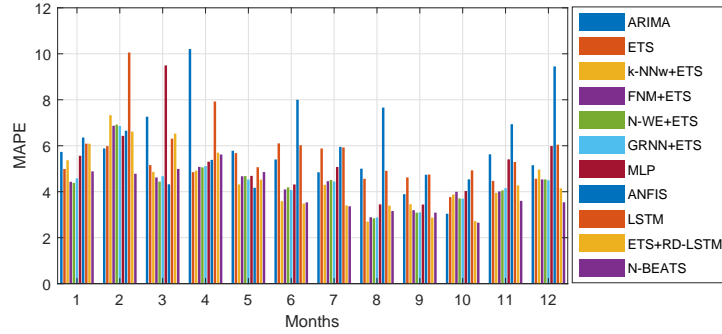

Figure 7: MAPE for each month of the test period

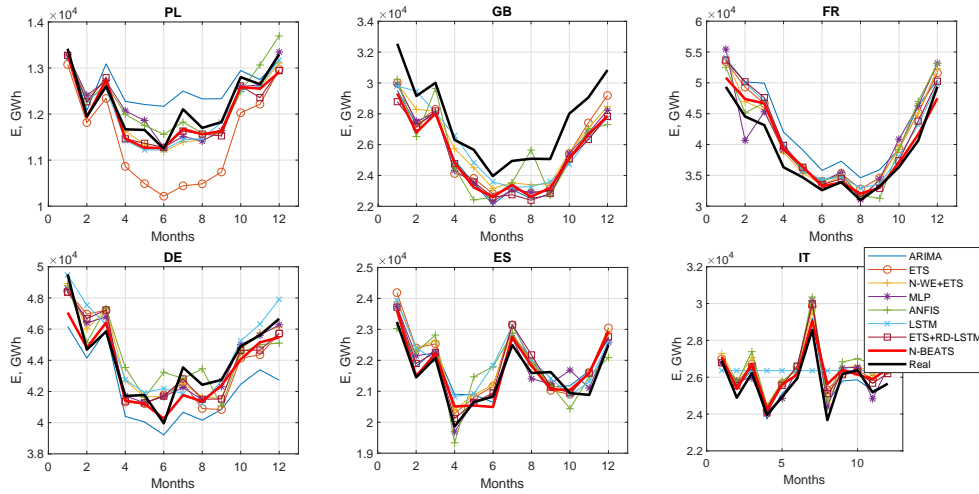

Figure 8: Examples of forecasts

showed the best performance of N-BEATS over statistical, machine learning, and hybrid methods. N-BEATS clearly outperformed its competitors in both accuracy and forecast bias level. In terms of MAPE our method provided relative gain of 25% with respect to the statistical methods, 28% with respect to machine learning methods and 14% with respect to the advanced state-of-the-art hybrid methods. Its success is due to a unique architecture that combines a deep stack of fully-connected layers, backward and forward residual links, aggregation of the partial forecasts in a hierarchical fashion, and ensembling. The cross-learning, i.e. learning on multiple time series, enables N-BEATS to capture the shared features and components of the individual time series. A great advantage of N-BEATS

is dealing with the raw time series, without requiring their decomposition or any preprocessing.

In our implementation of N-BEATS for MTLF, we introduced the pinball-MAPE loss function which allows the model to minimize directly the main MTLF performance metric and to reduce the forecast bias. It is worth noting that N-BEATS can implement any loss function in a pinball version. Therefore the model can be optimized for any forecasting problem with a specific quality metric incorporating the bias.

In our further research, we plan to apply N-BEATS for other forecasting problems in the energy sector such as short-term load forecasting, electricity price forecasting, forecasting electricity smart meter data, and probabilistic forecasting.

References

- [1] Martín Abadi, Ashish Agarwal, Paul Barham, Eugene Brevdo, Zhifeng Chen, Craig Citro, Greg S. Corrado, Andy Davis, Jeffrey Dean, Matthieu Devin, Sanjay Ghemawat, Ian Goodfellow, Andrew Harp, Geoffrey Irving, Michael Isard, Yangqing Jia, Rafal Jozefowicz, Lukasz Kaiser, Manjunath Kudlur, Josh Levenberg, Dan Mané, Rajat Monga, Sherry Moore, Derek Murray, Chris Olah, Mike Schuster, Jonathon Shlens, Benoit Steiner, Ilya Sutskever, Kunal Talwar, Paul Tucker, Vincent Vanhoucke, Vijay Vasudevan, Fernanda Viégas, Oriol Vinyals, Pete Warden, Martin Wattenberg, Martin Wicke, Yuan Yu, and Xiaoqiang Zheng. TensorFlow: Large-scale machine learning on heterogeneous systems, 2015. URL <http://tensorflow.org/>. Software available from tensorflow.org.
- [2] Tanveer Ahmad and Huanxin Chen. Potential of three variant machine-learning models for forecasting district level medium-term and long-term energy demand in smart grid environment. *Energy*, 160:1008–1020, 2018. doi: 10.1016/j.energy.2018.07.084.
- [3] Alexander Alexandrov, Konstantinos Benidis, Michael Bohlke-Schneider, Valentin Flunkert, Jan Gasthaus, Tim Januschowski, Danielle C. Maddix, Syama Rangapuram, David Salinas, Jasper Schulz, Lorenzo Stella, Ali Caner Türkmen, and Yuyang Wang. GluonTS: Probabilistic time series models in Python, 2019. arXiv:1906.05264.
- [4] Edward J. Anderson, Xinin Hu, and Donald Winchester. Forward contracts

- in electricity markets: The Australian experience. *Energy Policy*, 35(5): 3089–3103, 2007.
- [5] Francesco Apadula, Alessandra Bassini, Alberto Elli, and Simone Scapin. Relationships between meteorological variables and monthly electricity demand. *Applied Energy*, 98:346–356, 2012.
- [6] Elhaj Barakat. Modeling of nonstationary time-series data. Part II. Dynamic periodic trends. *International Journal of Electrical Power & Energy Systems*, 23:63–68, 2001. doi: 10.1016/S0142-0615(00)00035-1.
- [7] Jatin Bedi and Durga Toshniwal. Empirical mode decomposition based deep learning for electricity demand forecasting. *IEEE Access*, PP:1–1, 2018. doi: 10.1109/ACCESS.2018.2867681.
- [8] Konstantinos Benidis, Syama Sundar Rangapuram, Valentin Flunkert, Bernie Wang, Danielle Maddix, Caner Turkmen, Jan Gasthaus, Michael Bohlke-Schneider, David Salinas, Lorenzo Stella, Laurent Callot, and Tim Januschowski. Neural forecasting: Introduction and literature overview, 2020. arXiv:2004.10240.
- [9] Toby Bischoff and Austin Gross. Wavenet & dropout: An efficient setup for competitive forecasts at scale. In *Proceedings of the International Symposium on Forecasting*, 2019.
- [10] Pituk Bunnoon, Kusumal Chalermyanont, and Chusak Limsakul. Mid term load forecasting of the country using statistical methodology: Case study in Thailand. In *Signal Processing Systems, International Conference on*, pages 924–928, 2009. doi: 10.1109/ICSPS.2009.174.
- [11] Pei-Chann Chang, Chin-Yuan Fan, and Jyun-Jie Lin. Monthly electricity demand forecasting based on a weighted evolving fuzzy neural network approach. *International Journal of Electrical Power & Energy Systems*, 33: 17–27, 2011. doi: 10.1016/j.ijepes.2010.08.008.
- [12] Jeng-Fung Chen, Shih-Kuei Lo, and Quang Hung Do. Forecasting monthly electricity demands: An application of neural networks trained by heuristic algorithms. *Information*, 8:31, 2017. doi: 10.3390/info8010031.

- [13] Ching-Lai Hor, S. J. Watson, and S. Majithia. Analyzing the impact of weather variables on monthly electricity demand. *IEEE Transactions on Power Systems*, 20(4):2078–2085, 2005.
- [14] Jan Chorowski, Dzmitry Bahdanau, Kyunghyun Cho, and Yoshua Bengio. End-to-end continuous speech recognition using attention-based recurrent NN: First results, 2014. arXiv:1412.1602.
- [15] Robert B. Cleveland, William S. Cleveland, Jean E. McRae, and Irma Terpenning. STL: A seasonal-trend decomposition procedure based on Loess. *Journal of Official Statistics*, 6:3–73, 1990.
- [16] Eyup Dogan. Are shocks to electricity consumption transitory or permanent? sub-national evidence from turkey. *Utilities Policy*, 41(C):77–84, 2016.
- [17] Etti Doveh, Paul Feigin, D. Greig, and Lyne Hyams. Experience with FNN models for medium term power demand predictions. *Power Systems, IEEE Transactions on*, 14:538–546, 1999. doi: 10.1109/59.761878.
- [18] Grzegorz Dudek. Pattern-based local linear regression models for short-term load forecasting. *Electric Power Systems Research*, 130:139–147, 2016. doi: 10.1016/j.epsr.2015.09.001.
- [19] Grzegorz Dudek and Paweł Pełka. Pattern similarity-based machine learning methods for mid-term load forecasting: A comparative study, 2020. arXiv:2003.01475.
- [20] Grzegorz Dudek, Paweł Pełka, and Slawek Smyl. A hybrid residual dilated LSTM end exponential smoothing model for mid-term electric load forecasting, 2020. arXiv:2004.00508.
- [21] Mackean Elkateb, Khalid Solaiman, and Yusuf Al-Turki. A comparative study of medium-weather-dependent load forecasting using enhanced artificial/fuzzy neural network and statistical techniques. *Neurocomputing*, 23: 3–13, 12 1998. doi: 10.1016/S0925-2312(98)00076-9.
- [22] Mihai Gavrilas, Ioan Ciutea, and Cristina Tanasa. Medium-term load forecasting with artificial neural network models. In *16th International Conference and Exhibition on Electricity Distribution, Part 1: Contributions, (IEE Conf. Publ No. 482)*, volume 6, 2001. ISBN 0-85296-735-7. doi: 10.1049/cp:20010930.

- [23] Manoochehr Ghiassi, David K. Zimbra, and Hassine Saidane. Medium term system load forecasting with a dynamic artificial neural network model. *Electric Power Systems Research*, 76:302–316, 2006.
- [24] Xavier Glorot, Antoine Bordes, and Yoshua Bengio. Deep sparse rectifier neural networks. In *AISTATS'2011*, 2011.
- [25] Eva Gonzalez-Romera, Miguel Jaramillo-Moran, and Diego Carmona. Monthly electric energy demand forecasting based on trend extraction. *Power Systems, IEEE Transactions on*, 21:1946–1953, 2006. doi: 10.1109/TPWRS.2006.883666.
- [26] Eva Gonzalez-Romera, Miguel Jaramillo-Morán, and Diego Carmona. Monthly electric energy demand forecasting with neural networks and fourier series. *Energy Conversion and Management*, 49:3135–3142, 2008. doi: 10.1016/j.enconman.2008.06.004.
- [27] Hansika Hewamalage, Christoph Bergmeir, and Kasun Bandara. Recurrent neural networks for time series forecasting: Current status and future directions, 2019. arXiv:1909.00590.
- [28] Sepp Hochreiter and Jürgen Schmidhuber. Long short-term memory. *Neural computation*, 9:1735–80, 1997. doi: 10.1162/neco.1997.9.8.1735.
- [29] B.-M. Hodge, A. Florita, J. Sharp, M. Margulis, and D. McCreavy. The value of improved short-term wind power forecasting. Technical report, National Renewable Energy Laboratory, February 2015.
- [30] Rob Hyndman and George Athanasopoulos. *Forecasting: Principles and Practice*. OTexts, Australia, 2nd edition, 2018.
- [31] Rob Hyndman, Anne Koehler, Keith Ord, and Ralph Snyder. *Forecasting with Exponential Smoothing. The State Space Approach*. Springer-Verlag Berlin Heidelberg, 2008. doi: 10.1007/978-3-540-71918-2.
- [32] M.S. Kandil, S.M. El-Debeiky, and N.E. Hasanién. Long-term load forecasting for fast developing utility using a knowledge-based expert system. *Power Systems, IEEE Transactions on*, 17:491–496, 06 2002. doi: 10.1109/TPWRS.2002.1007923.

- [33] Shiyang Li, Xiaoyong Jin, Yao Xuan, Xiyou Zhou, Wenhui Chen, Yu-Xiang Wang, and Xifeng Yan. Enhancing the locality and breaking the memory bottleneck of transformer on time series forecasting. In *Advances in Neural Information Processing Systems 32*, pages 5243–5253, 2019.
- [34] Spyros Makridakis and Michèle Hibon. The M3-Competition: results, conclusions and implications. *International Journal of Forecasting*, 16(4):451–476, 2000.
- [35] Nooriya Mohammed. Modelling of unsuppressed electrical demand forecasting in Iraq for long term. *Energy*, 162:354–363, 2018. doi: 10.1016/j.energy.2018.08.030.
- [36] Frank A. Monforte, Jennifer Blanco, Suraj Peri, Adam Kankiewicz, Christine Fordham, David Hanna, Stephan Barsun, and Ben Norris. Improving solar and load forecasts by reducing operational uncertainty. Technical report, California Energy Commission, March 2019.
- [37] Vinod Nair and Geoffrey E. Hinton. Rectified linear units improve restricted boltzmann machines. In *ICML*, pages 807–814, 2010.
- [38] Apurva Narayan and Keith Hipel. Long short term memory networks for short-term electric load forecasting. In *2017 IEEE International Conference on Systems, Man, and Cybernetics (SMC)*, pages 2573–2578, 2017. doi: 10.1109/SMC.2017.8123012.
- [39] Aaron Oord, Sander Dieleman, Heiga Zen, Karen Simonyan, Oriol Vinyals, Alex Graves, Nal Kalchbrenner, Andrew Senior, and Koray Kavukcuoglu. Wavenet: A generative model for raw audio, 2016. arXiv:1609.03499.
- [40] Boris N. Oreshkin, Dmitri Carpo, Nicolas Chapados, and Yoshua Bengio. N-BEATS: Neural basis expansion analysis for interpretable time series forecasting. In *ICLR*, 2020.
- [41] Paweł Pełka and Grzegorz Dudek. Neuro-fuzzy system for medium-term electric energy demand forecasting. In *Information Systems Architecture and Technology: Proceedings of 38th International Conference on Information Systems Architecture and Technology – ISAT 2017*, pages 38–47, Cham, 2018. Springer International Publishing. ISBN 978-3-319-67219-9. doi: 10.1007/978-3-319-67220-5_4.

- [42] Paweł Pełka and Grzegorz Dudek. Pattern-based forecasting monthly electricity demand using multilayer perceptron. In *Artificial Intelligence and Soft Computing*, pages 663–672, Cham, 2019. Springer International Publishing. ISBN 978-3-030-20911-7. doi: 10.1007/978-3-030-20912-4_60.
- [43] Slawek Smyl. A hybrid method of exponential smoothing and recurrent neural networks for time series forecasting. *International Journal of Forecasting*, 36(1):75–85, 2020.
- [44] L. Suganthi and Anand Samuel. Energy models for demand forecasting—a review. *Renewable & Sustainable Energy Reviews*, 16:1223–1240, 2012. doi: 10.1016/j.rser.2011.08.014.
- [45] Ashish Vaswani, Noam Shazeer, Niki Parmar, Jakob Uszkoreit, Llion Jones, Aidan N Gomez, Łukasz Kaiser, and Illia Polosukhin. Attention is all you need. In *Proceedings of 31st Conference on Neural Information Processing Systems (NIPS 2017)*, pages 5998–6008, 2017.
- [46] Ke Yan, Xudong Wang, Yang Du, Ning Jin, Haichao Huang, and Hangxia Zhou. Multi-step short-term power consumption forecasting with a hybrid deep learning strategy. *Energies*, 11:3089, 2018. doi: 10.3390/en11113089.
- [47] Huiting Zheng, Jiabin Yuan, and Long Chen. Short-term load forecasting using EMD-LSTM neural networks with a XGBoost algorithm for feature importance evaluation. *Energies*, 10:1168, 2017. doi: 10.3390/en10081168.

Appendix A. N-BEATS TensorFlow implementation

```

1 import tensorflow as tf
2
3
4 class NBEATSBlock(tf.keras.layers.Layer):
5     def __init__(self, input_size: int, output_size: int, block_layers: int, hidden_units: int):
6         super().__init__()
7         self.fc_layers = []
8         for i in range(block_layers):
9             self.fc_layers.append(tf.keras.layers.Dense(hidden_units,
10                                                         activation=tf.nn.relu))
11         self.forecast = tf.keras.layers.Dense(output_size, activation=None)
12         self.backcast = tf.keras.layers.Dense(input_size, activation=None)
13
14     def call(self, x):
15         inputs = x
16         for layer in self.fc_layers:
17             x = layer(x)
18         backcast = tf.keras.activations.relu(inputs - self.backcast(x))
19         return backcast, self.forecast(x)
20
21
22 class NBEATS(tf.keras.layers.Layer):
23     def __init__(self, input_size: int, output_size: int, block_layers: int, hidden_units: int,
24                 num_blocks: int, block_sharing: bool):
25         super().__init__()
26         self.blocks = [NBEATSBlock(input_size=input_size, output_size=output_size,
27                                   block_layers=block_layers, hidden_units=hidden_units)]
28         for i in range(1, num_blocks):
29             if block_sharing:
30                 self.blocks.append(self.blocks[0])
31             else:
32                 self.blocks.append(NBEATSBlock(input_size=input_size, output_size=output_size,
33                                                block_layers=block_layers, hidden_units=hidden_units))
34
35     def call(self, x):
36         level = tf.reduce_max(x, axis=-1, keepdims=True)
37         backcast = tf.math.divide_no_nan(x, level)
38         forecast = 0.0
39         for block in self.blocks:
40             backcast, forecast_block = block(backcast)
41             forecast = forecast + forecast_block
42         return forecast * level
43
44
45 nbeats = NBEATS(input_size=12, output_size=12, block_layers=3, num_blocks=3, hidden_units=512, block_sharing=True)
46 inputs = tf.random.normal([256, 12])
47 forecast = nbeats(inputs)

```

Listing 1: N-BEATS TensorFlow inference code.