

A new perspective on the Sullivan dictionary via Assouad type dimensions and spectra

Jonathan M. Fraser and Liam Stuart

The University of St Andrews, Scotland

E-mails: jmf32@st-andrews.ac.uk and ls220@st-andrews.ac.uk

July 31, 2020

Abstract

We conduct a detailed analysis of the Assouad type dimensions and spectra in the context of limit sets of geometrically finite Kleinian groups and Julia sets of parabolic rational maps. Our analysis includes the Patterson-Sullivan measure in the Kleinian case and the analogous conformal measure in the Julia set case. Our results constitute a new perspective on the Sullivan dictionary between Kleinian groups and rational maps. We show that there exist both strong correspondences and strong differences between the two settings. The differences we observe are particularly interesting since they come from dimension theory, a subject where the correspondence described by the Sullivan dictionary is especially strong.

Mathematics Subject Classification 2020: primary: 28A80, 37C45, 37F10, 30F40, 37F50; secondary: 28A78;

Key words and phrases: Kleinian group, rational map, Julia set, limit set, Patterson-Sullivan measure, conformal measure, parabolicity, Assouad dimension, Assouad spectrum, Sullivan dictionary.

JMF was financially supported by an *EPSRC Standard Grant* (EP/R015104/1) and a *Leverhulme Trust Research Project Grant* (RPG-2019-034). LS was financially supported by the University of St Andrews.

Contents

1	Introduction	3
2	Definitions and Background	5
2.1	Dimensions of sets and measures	5
2.2	Kleinian groups and limit sets	8
2.3	Rational maps and Julia sets	11
2.4	The Sullivan dictionary	13
3	Results	14
3.1	Results regarding Kleinian limit sets	14
3.2	Results regarding Julia sets	15
3.3	A new perspective on the Sullivan dictionary	16
3.4	Examples	19
4	Proofs of results regarding Kleinian limit sets	20
4.1	Preliminaries	20
4.2	The box dimension of μ	23
4.3	The Assouad spectrum of μ	24
4.4	The lower spectrum of μ	29
4.5	The Assouad spectrum of $L(\Gamma)$	32
4.6	The lower spectrum of $L(\Gamma)$	39
5	Proofs of results regarding Julia sets	45
5.1	Preliminaries	45
5.2	The box dimension of m	47
5.3	The Assouad dimension of m	47
5.4	The lower dimension of m	50
5.5	The Assouad spectrum of m	52
5.6	The lower spectrum of m	53
5.7	The Assouad dimension of $J(T)$	54
5.8	The lower dimension of $J(T)$	59
5.9	The Assouad spectrum of $J(T)$	61
5.10	The lower spectrum of $J(T)$	62
	References	64

1 Introduction

The Sullivan dictionary provides a correspondence between Kleinian groups and rational maps. Seminal work of Sullivan in the 1980s [49] resolved a long-standing problem in complex dynamics by proving that the Fatou set of a rational map has no wandering domains. This work served to establish remarkable connections between the dynamics of rational maps and the actions of Kleinian groups. This connection subsequently stimulated activity in both the complex dynamics and hyperbolic geometry communities and led to what is now known as the *Sullivan dictionary*; see, for example, [37]. The Sullivan dictionary provides a framework to study the relationships between Kleinian groups and rational maps. In many cases there are analogous results, even with similar proofs, albeit expressed in a different language.

Both (geometrically finite) Kleinian groups and rational maps generate important examples of dynamically invariant fractal sets: *limit sets* in the Kleinian case, and *Julia sets* in the rational map case. The Sullivan dictionary is very well-suited to understanding the connections between these two families of fractal and the correspondence is especially strong in the context of dimension theory: in both settings there is a ‘critical exponent’ which describes all of the most commonly used notions of fractal dimension. In the Kleinian case the critical exponent is the Poincaré exponent, denoted by δ , and in the rational map case the critical exponent is the smallest zero of the topological pressure, denoted by h , see [16]. In both settings the critical exponent coincides with the Hausdorff, packing and box dimensions of the fractal as well as the Hausdorff, packing, and entropy dimensions of the associated ergodic conformal measure.

This paper is dedicated to dimension theory in the context of the Sullivan dictionary and we find that, by slightly expanding the family of dimensions considered, a much richer and more varied tapestry of results emerges. The dimensions we consider are of ‘Assouad type’ and include the Assouad dimension, the lower dimension, and the Assouad and lower spectrum. The Assouad dimension is perhaps the most widely used of these notions and stems from work in embedding theory and conformal geometry, see [33, 42]. It has recently been gaining substantial attention in the fractal geometry literature, however, see [22]. The lower dimension is the natural ‘dual’ to the Assouad dimension and it is particularly useful to consider these notions together. The Assouad and lower spectrum were introduced much more recently in [25] and provide an ‘interpolation’ between the box dimension and the Assouad and lower dimensions, respectively. The motivation for the introduction of these ‘dimension spectra’ was to gain a more nuanced understanding of fractal sets than that provided by the dimensions considered in isolation. This is already proving a fruitful programme with applications emerging in a variety of settings including to problems in harmonic analysis, see work of Anderson, Hughes, Roos and Seeger [3] and [43].

The Assouad and lower dimensions of limit sets of geometrically finite Kleinian groups and associated Patterson-Sullivan measures were found in [21]. These results already highlight the significance of the Assouad dimension in this setting since it is *not* generally given by the Poincaré

exponent δ . We find that this phenomenon also occurs in the rational map setting, with the Assouad dimension of the Julia set of a parabolic rational map being given by $\max\{1, h\}$, see Theorem 3.4. Our main results consist of precise formulae for the Assouad and lower spectra of limit sets of geometrically finite Kleinian groups (Theorem 3.2) and the associated Patterson-Sullivan measures (Theorem 3.1), as well as the Assouad and lower dimensions and spectra of Julia sets of parabolic rational maps (Theorem 3.4) and their associated h -conformal measures (Theorem 3.3). Many of these results may be of independent interest. That said, our main motivation is to use this rich family of dimensions and spectra to compare the Kleinian and rational map settings, especially to identify differences between the theories. We refer to these differences as new ‘non-entries’ in the Sullivan dictionary.

Our proofs use a variety of techniques. A central concept is that of *global measure formulae* which allow us to use conformal measures to estimate the size of efficient covers. We take some inspiration from the paper [21] which dealt with the Assouad and lower dimensions of Kleinian limit sets. However, the Assouad and lower spectra require much finer control and therefore many of the techniques from [21] need refined and some need replaced. We adapt this broad approach to the Julia setting which, for example, requires replacing *horoballs* with *canonical balls*. This is often more awkward and connected to the lack of understanding of the ‘hidden 3-dimensional geometry’ of Julia sets, see [37, 38]. We also take inspiration from the papers [18, 44, 45, 46, 47] where ideas from Diophantine approximation are applied in the context of conformal dynamics. In order to adequately describe the local behaviour around parabolic points, we rely on structural results such as Bowditch’s theorem in the Kleinian setting and the (quantitative) Leau-Fatou flower theorem in the Julia setting. Since we consider several dual notions of dimension, some of the arguments are analogous and we do our best to suppress repetition. We stress, however, that calculating the lower dimension (for example) is not usually a case of simply ‘reversing’ the Assouad dimension arguments and subtle differences often emerge. For example, Bowditch’s theorem and the Leau-Fatou flower theorem are only needed to study the lower dimension and spectrum.

The rest of the paper is structured as follows. In Section 2, we provide all the necessary background on dimension theory, Kleinian groups, limit sets, rational maps and Julia sets. In Section 3, we state the main results of our paper, including a detailed discussion of our new perspective on the Sullivan dictionary in Section 3.3. Sections 4 and 5 contain the proofs of our results.

For notational convenience throughout, we write $A \lesssim B$ if there exists a constant $C \geq 1$ such that $A \leq CB$, and $A \gtrsim B$ if $B \lesssim A$. We write $A \approx B$ if $A \lesssim B$ and $B \lesssim A$. The constant C is allowed to depend on parameters fixed in the hypotheses of the theorems presented, but not on parameters introduced in the proofs.

2 Definitions and Background

2.1 Dimensions of sets and measures

We recall the key notions from fractal geometry and dimension theory which we will use throughout the paper. For a more in-depth treatment see the books [9, 19, 36] for background on Hausdorff and box dimensions, and [22] for Assouad type dimensions. We will work with fractals in two distinct settings. Kleinian limit sets will be subsets of the d -dimensional sphere \mathbb{S}^d which we view as a subset of \mathbb{R}^{d+1} . On the other hand, Julia sets will be subsets of the Riemann sphere $\hat{\mathbb{C}} = \mathbb{C} \cup \{\infty\}$. However, by a standard reduction we will assume that the Julia sets are bounded subsets of the complex plane \mathbb{C} , which we identify with \mathbb{R}^2 . Therefore, it is convenient to recall dimension theory in Euclidean space only.

Let $F \subseteq \mathbb{R}^d$. Perhaps the most commonly used notion of fractal dimension is the Hausdorff dimension. We write $\dim_{\text{H}} F$ for the *Hausdorff dimension* of F , but refer the reader to [9, 19, 36] for the precise definition since we do not use it directly. We write $|F| = \sup_{x,y \in F} |x - y| \in [0, \infty]$ to denote the diameter of F . Given $r > 0$, we write $N_r(F)$ for the smallest number of balls of radius r required to cover F . We write $M_r(F)$ to denote the largest cardinality of a packing of F by balls of radius r centred in F . In what follows, it is easy to see that replacing $N_r(F)$ by $M_r(F)$ yields an equivalent definition and so we sometimes switch between minimal coverings and maximal packings in our arguments. This is standard in fractal geometry.

For a non-empty bounded set $F \subseteq \mathbb{R}^d$, the *upper and lower box dimensions* of F are defined by

$$\overline{\dim}_{\text{B}} F = \limsup_{r \rightarrow 0} \frac{\log N_r(F)}{-\log r} \quad \text{and} \quad \underline{\dim}_{\text{B}} F = \liminf_{r \rightarrow 0} \frac{\log N_r(F)}{-\log r},$$

respectively. If $\overline{\dim}_{\text{B}} F = \underline{\dim}_{\text{B}} F$, we call the common value the *box dimension* of F and denote it by $\dim_{\text{B}} F$. While we also will not work with the definition of box dimension directly, it is instructive to consider it before the related Assouad and lower dimensions. The key difference is that the box dimension seeks global covers, whereas the Assouad and lower dimensions seek local covers. The *Assouad dimension* of $F \subseteq \mathbb{R}^d$ is defined by

$$\dim_{\text{A}} F = \inf \left\{ s \geq 0 \mid \exists C > 0 : \forall 0 < r < R : \forall x \in F : N_r(B(x, R) \cap F) \leq C \left(\frac{R}{r} \right)^s \right\}.$$

Similarly, the *lower dimension* of F is defined by

$$\dim_{\text{L}} F = \sup \left\{ s \geq 0 \mid \exists C > 0 : \forall 0 < r < R \leq |F| : \forall x \in F : N_r(B(x, R) \cap F) \geq C \left(\frac{R}{r} \right)^s \right\}.$$

Importantly, for compact F we have $\dim_{\text{L}} F \leq \dim_{\text{H}} F \leq \underline{\dim}_{\text{B}} F \leq \overline{\dim}_{\text{B}} F \leq \dim_{\text{A}} F$.

The Assouad and lower spectrum, introduced in [25], interpolate between the box dimensions and the Assouad and lower dimensions in a meaningful way. They provide a parametrised family

of dimensions by fixing the relationship between the two scales $r < R$ used to define Assouad and lower dimension. Studying the dependence on the parameter within this family thus yields finer and more nuanced information about the local structure of the set. For example, one may understand which scales ‘witness’ the behaviour described by the Assouad and lower dimensions. For $\theta \in (0, 1)$, the *Assouad spectrum* of F is given by

$$\dim_{\mathbb{A}}^{\theta} F = \inf \left\{ s \geq 0 \mid \exists C > 0 : \forall 0 < r < 1 : \forall x \in F : N_r(B(x, r^{\theta}) \cap F) \leq C \left(\frac{r^{\theta}}{r} \right)^s \right\}$$

and the *lower spectrum* of F by

$$\dim_{\mathbb{L}}^{\theta} F = \sup \left\{ s \geq 0 \mid \exists C > 0 : \forall 0 < r < 1 : \forall x \in F : N_r(B(x, r^{\theta}) \cap F) \geq C \left(\frac{r^{\theta}}{r} \right)^s \right\}.$$

It was shown in [25] that for a bounded set $F \subseteq \mathbb{R}^d$, we have

$$\begin{aligned} \overline{\dim}_{\mathbb{B}} F &\leq \dim_{\mathbb{A}}^{\theta} F \leq \min \left\{ \dim_{\mathbb{A}} F, \frac{\overline{\dim}_{\mathbb{B}} F}{1 - \theta} \right\} \\ \dim_{\mathbb{L}} F &\leq \dim_{\mathbb{L}}^{\theta} F \leq \underline{\dim}_{\mathbb{B}} F. \end{aligned} \tag{2.1}$$

In particular, $\dim_{\mathbb{A}}^{\theta} F \rightarrow \overline{\dim}_{\mathbb{B}} F$ as $\theta \rightarrow 0$. Whilst the analogous statement does not hold for the lower spectrum in general, it was proved in [22, Theorem 6.3.1] that $\dim_{\mathbb{L}}^{\theta} F \rightarrow \underline{\dim}_{\mathbb{B}} F$ as $\theta \rightarrow 0$ provided F satisfies a strong form of dynamical invariance. Whilst the fractals we study are not quite covered by this result, we shall see that this interpolation holds nevertheless. The limit $\lim_{\theta \rightarrow 0} \dim_{\mathbb{L}}^{\theta} F$ is known to exist in general (see [13, Theorem 1.1]) and moreover can take any value in the range $[\dim_{\mathbb{qL}} F, \underline{\dim}_{\mathbb{B}} F]$.

We write $\dim_{\mathbb{qA}} F$ to denote the *quasi-Assouad dimension* of F and $\dim_{\mathbb{qL}} F$ to denote the *quasi-lower dimension* of F . These were introduced in [14] and [31] and, due to work in [13, 23, 27], it is known that

$$\lim_{\theta \rightarrow 1} \dim_{\mathbb{A}}^{\theta} F = \dim_{\mathbb{qA}} F \quad \text{and} \quad \lim_{\theta \rightarrow 1} \dim_{\mathbb{L}}^{\theta} F = \dim_{\mathbb{qL}} F.$$

In many cases of interest, including the ones we discuss in this paper, we have $\dim_{\mathbb{qA}} F = \dim_{\mathbb{A}} F$ and $\dim_{\mathbb{qL}} F = \dim_{\mathbb{L}} F$, so we make no further mention of the quasi-dimensions.

There is an analogous dimension theory of measures, and the interplay between the dimension theory of fractals and the measures they support is fundamental to fractal geometry, especially in the dimension theory of dynamical systems. Let μ be a locally finite Borel measure on \mathbb{R}^d , i.e. $\mu(B(x, r)) < \infty$ for all $x \in \mathbb{R}^d$ and $r > 0$. We write $\text{supp}(\mu) = \{x \in \mathbb{R}^d \mid \mu(B(x, r)) > 0 \text{ for all } r > 0\}$ for the *support* of μ . We say that μ is *fully supported* on a set $F \subseteq \mathbb{R}^d$ if $\text{supp}(\mu) = F$. Similar to above, we write $\dim_{\mathbb{H}} \mu$ for the (lower) Hausdorff dimension of μ and note that $\dim_{\mathbb{H}} \mu \leq \text{supp}(\mu)$ and, for compact F ,

$$\dim_{\mathbb{H}} F = \sup \{ \dim_{\mathbb{H}} \mu \mid \text{supp}(\mu) \subseteq F \},$$

see [36].

The *Assouad dimension* of μ with $\text{supp}(\mu) = F$ is defined by

$$\dim_A \mu = \inf \left\{ s \geq 0 \mid \exists C > 0 : \forall 0 < r < R < |F| : \forall x \in F : \frac{\mu(B(x, R))}{\mu(B(x, r))} \leq C \left(\frac{R}{r} \right)^s \right\}$$

and, provided $|\text{supp}(\mu)| = |F| > 0$, the *lower dimension* of μ is given by

$$\dim_L \mu = \sup \left\{ s \geq 0 \mid \exists C > 0 : \forall 0 < r < R < |F| : \forall x \in F : \frac{\mu(B(x, R))}{\mu(B(x, r))} \geq C \left(\frac{R}{r} \right)^s \right\}$$

and otherwise it is 0. By convention we assume that $\inf \emptyset = \infty$.

These were introduced in [28, 29], where they were referred to as the upper and lower regularity dimensions of μ . It is well known (see [22, Lemma 4.1.2]) that for a Borel probability measure μ supported on a closed set $F \subseteq \mathbb{R}^d$, we have

$$\dim_L \mu \leq \dim_L F \leq \dim_A F \leq \dim_A \mu$$

and furthermore, we have the stronger fact that

$$\dim_A F = \inf \{ \dim_A \mu \mid \mu \text{ is a Borel probability measure fully supported on } F \}$$

and

$$\dim_L F = \sup \{ \dim_L \mu \mid \mu \text{ is a Borel probability measure fully supported on } F \}.$$

For $\theta \in (0, 1)$, the *Assouad spectrum* of μ with $\text{supp}(\mu) = F$ is given by

$$\dim_A^\theta \mu = \inf \left\{ s \geq 0 \mid \exists C > 0 : \forall 0 < r < |F| : \forall x \in F : \frac{\mu(B(x, r^\theta))}{\mu(B(x, r))} \leq C \left(\frac{r^\theta}{r} \right)^s \right\}$$

and provided $|\text{supp}(\mu)| = |F| > 0$, the *lower spectrum* of μ is given by

$$\dim_L^\theta \mu = \sup \left\{ s \geq 0 \mid \exists C > 0 : \forall 0 < r < |F| : \forall x \in F : \frac{\mu(B(x, r^\theta))}{\mu(B(x, r))} \geq C \left(\frac{r^\theta}{r} \right)^s \right\}$$

and otherwise it is 0. It is known (see [20] for example) that for any measure μ ,

$$\dim_L \mu \leq \dim_L^\theta \mu \leq \dim_A^\theta \mu \leq \dim_A \mu$$

and if μ is fully supported on a closed set F , then

$$\dim_L^\theta \mu \leq \dim_L^\theta F \leq \dim_A^\theta F \leq \dim_A^\theta \mu.$$

The *upper box dimension* of μ with $\text{supp}(\mu) = F$ is given by

$$\overline{\dim}_B \mu = \inf \left\{ s \mid \exists C > 0 : \forall 0 < r < |F| : \forall x \in F : \mu(B(x, r)) \geq Cr^s \right\}$$

and the *lower box dimension* of μ is given by

$$\underline{\dim}_{\mathbb{B}}\mu = \inf \left\{ s \mid \exists C > 0 : \forall r_0 > 0 \exists 0 < r < r_0 : \forall x \in F : \mu(B(x, r)) \geq Cr^s \right\}.$$

If $\overline{\dim}_{\mathbb{B}}\mu = \underline{\dim}_{\mathbb{B}}\mu$, then we refer to the common value as the *box dimension* of μ , denoted by $\dim_{\mathbb{B}}\mu$. These definitions of the box dimension of a measure were introduced only recently in [20]. Similar to the case for Assouad dimension, we can express the box dimensions of a set F in terms of the box dimensions of measures supported on F . More precisely, for a non-empty compact set $F \subseteq \mathbb{R}^d$, it was shown in [20] that

$$\overline{\dim}_{\mathbb{B}}F = \inf \left\{ \overline{\dim}_{\mathbb{B}}\mu \mid \mu \text{ is a finite Borel measure fully supported on } F \right\}$$

and

$$\underline{\dim}_{\mathbb{B}}F = \inf \left\{ \underline{\dim}_{\mathbb{B}}\mu \mid \mu \text{ is a finite Borel measure fully supported on } F \right\}.$$

Furthermore, it was shown that the upper box dimension of μ can be related to the Assouad spectrum of μ in a similar manner to sets. In particular, for a measure μ supported on a compact set F and for $\theta \in (0, 1)$,

$$\overline{\dim}_{\mathbb{B}}\mu \leq \dim_{\mathbb{A}}^{\theta}\mu \leq \min \left\{ \dim_{\mathbb{A}}\mu, \frac{\overline{\dim}_{\mathbb{B}}\mu}{1 - \theta} \right\}.$$

2.2 Kleinian groups and limit sets

For a more thorough study of hyperbolic geometry and Kleinian groups, we refer the reader to [2, 4, 35]. For $d \geq 1$, we model $(d + 1)$ -dimensional hyperbolic space using the Poincaré ball model

$$\mathbb{D}^{d+1} = \{z \in \mathbb{R}^{d+1} \mid |z| < 1\}$$

equipped with the hyperbolic metric $d_{\mathbb{H}}$ defined by

$$ds = \frac{2|dz|}{1 - |z|^2}$$

and we call the boundary $\mathbb{S}^d = \{z \in \mathbb{R}^{d+1} \mid |z| = 1\}$ the *boundary at infinity* of the space $(\mathbb{D}^{d+1}, d_{\mathbb{H}})$. We denote by $\text{Con}(d)$ the group of orientation-preserving isometries of $(\mathbb{D}^{d+1}, d_{\mathbb{H}})$. We will occasionally make use of the upper half space model $\mathbb{H}^{d+1} = \mathbb{R}^d \times (0, \infty)$ equipped with the analogous metric.

We say that a group is *Kleinian* if it is a discrete subgroup of $\text{Con}(d)$, and given a Kleinian group Γ , the *limit set* of Γ is defined to be

$$L(\Gamma) = \overline{\Gamma(\mathbf{0})} \setminus \Gamma(\mathbf{0})$$

where $\mathbf{0} = (0, \dots, 0) \in \mathbb{D}^{d+1}$. It is well known that $L(\Gamma)$ is a compact Γ -invariant subset of \mathbb{S}^d , see Figure 1. If $L(\Gamma)$ contains zero, one or two points, it is said to be *elementary*, and otherwise it is *non-elementary*. In the non-elementary case, $L(\Gamma)$ is a perfect set, and often

has a complicated fractal structure. We consider *geometrically finite* Kleinian groups. Roughly speaking, this means that there is a fundamental domain with finitely many sides (we refer the reader to [10] for further details). We define the *Poincaré exponent* of a Kleinian group Γ to be

$$\delta = \inf \left\{ s > 0 \mid \sum_{g \in \Gamma} e^{-s d_{\mathbb{H}}(\mathbf{0}, g(\mathbf{0}))} < \infty \right\}.$$

Due to work of Patterson and Sullivan [41, 48], it is known that for a non-elementary geometrically finite Kleinian group Γ , the Hausdorff dimension of the limit set is equal to δ . It was discovered independently by Bishop and Jones [8, Corollary 1.5] and Stratmann and Urbański [44, Theorem 3] that the box and packing dimensions of the limit set are also equal to δ .

From now on we only discuss the non-elementary geometrically finite case. We denote by μ the *Patterson-Sullivan measure*, which is a measure first constructed by Patterson in [41]. The geometry of Γ , $L(\Gamma)$ and μ are heavily related. For example, μ is a conformal Γ -ergodic Borel probability measure which is fully supported on $L(\Gamma)$. Moreover, μ has Hausdorff, packing and entropy dimension equal to δ , see [8, 41, 47, 48].

The Assouad and lower dimensions of μ and limit sets of non-elementary geometrically finite Kleinian groups were dealt with in [21]. To state the results, we require some more notation. Let Γ be a non-elementary Kleinian group which contains at least one parabolic point, and denote by $P \subseteq L(\Gamma)$ the countable set of parabolic points. We may fix a standard set of horoballs $\{H_p\}_{p \in P}$ (a horoball H_p is a closed Euclidean ball whose interior lies in \mathbb{D}^{d+1} and is tangent to the boundary \mathbb{S}^d at p) such that they are pairwise disjoint, do not contain the point $\mathbf{0}$, and have the property that for each $g \in \Gamma$ and $p \in P$, we have $g(H_p) = H_{g(p)}$, see [44, 47].

We note that for any $p \in P$, the stabiliser of p denoted by $\text{Stab}(p)$ cannot contain any loxodromic elements, as this would violate the discreteness of Γ . We denote by $k(p)$ the maximal rank of a free abelian subgroup of $\text{Stab}(p)$, which must be generated by $k(p)$ parabolic elements which all fix p , and call this the *rank* of p . We write

$$\begin{aligned} k_{\min} &= \min\{k(p) \mid p \in P\} \\ k_{\max} &= \max\{k(p) \mid p \in P\}. \end{aligned}$$

It was proven in [48] that $\delta > k_{\max}/2$. In [21], the following was proven:

Theorem 2.1. *Let Γ be a non-elementary geometrically finite Kleinian group. Then*

$$\begin{aligned} \dim_{\text{A}} L(\Gamma) &= \max\{\delta, k_{\max}\} \\ \dim_{\text{L}} L(\Gamma) &= \min\{\delta, k_{\min}\} \\ \dim_{\text{A}} \mu &= \max\{2\delta - k_{\min}, k_{\max}\} \\ \dim_{\text{L}} \mu &= \min\{2\delta - k_{\max}, k_{\min}\}. \end{aligned}$$

We resolve the Assouad and lower spectra of μ and $L(\Gamma)$ in Theorems 3.1 and 3.2. An important result used in the proofs of the box and Assouad dimensions of limit sets is Stratmann and

Velani's *global measure formula*, derived in [47], which gives a formula for the measure of any ball centred in the limit set up to uniform constants. More precisely, given $z \in L(\Gamma)$ and $T > 0$, we define $z_T \in \mathbb{D}^{d+1}$ to be the point on the geodesic ray joining $\mathbf{0}$ and z which is hyperbolic distance T from $\mathbf{0}$. We write $S(z, T) \subset \mathbb{S}^d$ to denote the *shadow at infinity* of the d -dimensional hyperplane passing through z_T which is normal to the geodesic joining $\mathbf{0}$ and z . The global measure formula states that

$$\mu(S(z, T)) \approx e^{-T\delta} e^{-\rho(z, T)(\delta - k(z, T))} \quad (2.2)$$

where $k(z, T) = k(p)$ if $z_T \in H_p$ for some $p \in P$ and 0 otherwise, and

$$\rho(z, T) = \inf\{d_{\mathbb{H}}(z_T, y) \mid y \notin H_p\}$$

if $z_T \in H_p$ for some $p \in P$ and 0 otherwise. Basic hyperbolic geometry shows that $S(z, T)$ is a Euclidean ball centred at z with radius comparable to e^{-T} , and so an immediate consequence of (2.2) is the following.

Theorem 2.2 (Global Measure Formula I). *Let $z \in L(\Gamma)$, $T > 0$. Then we have*

$$\mu(B(z, e^{-T})) \approx e^{-T\delta} e^{-\rho(z, T)(\delta - k(z, T))}.$$

We will repeatedly make use of this fact throughout. An easy consequence of Theorem 2.2 is that if Γ contains no parabolic points, then

$$\dim_{\mathbb{A}} L(\Gamma) = \dim_{\mathbb{L}} L(\Gamma) = \dim_{\mathbb{A}} \mu = \dim_{\mathbb{L}} \mu = \dim_{\mathbb{B}} \mu = \delta,$$

and

$$\dim_{\mathbb{A}}^{\theta} L(\Gamma) = \dim_{\mathbb{A}}^{\theta} \mu = \dim_{\mathbb{L}}^{\theta} L(\Gamma) = \dim_{\mathbb{L}}^{\theta} \mu = \delta$$

for all $\theta \in (0, 1)$. Therefore, we may assume throughout that Γ contains at least one parabolic point.

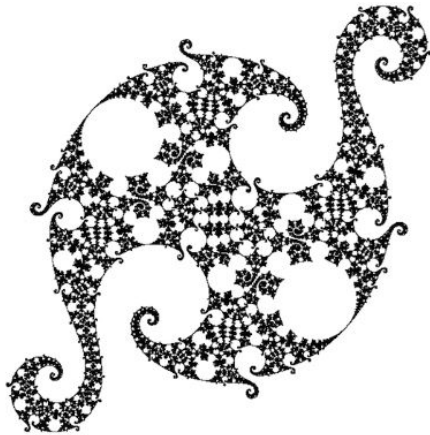

Figure 1: An example of a Kleinian limit set. Here $d = 2$ and the boundary \mathbb{S}^2 has been identified with $\mathbb{R}^2 \cup \{\infty\}$. Parabolic points with rank 1 are easily identified.

2.3 Rational maps and Julia sets

For a more detailed discussion on the dynamics of rational maps, see [5, 12, 40]. Let $T : \hat{\mathbb{C}} \rightarrow \hat{\mathbb{C}}$ denote a rational map, and denote by $J(T)$ the *Julia set* of T , which is equal to the closure of the repelling periodic points of T , see Figure 2. The Julia set is closed and T -invariant. We may assume that $J(T)$ is a compact subset of \mathbb{C} by a standard reduction. If this is not the case, then we can conjugate a point $z \notin J(T)$ to ∞ via a Möbius inversion and then the closedness of the resulting Julia set ensures it lies in a bounded region of \mathbb{C} . This is essentially just choosing a different point on the Riemann sphere to represent the point at infinity. A periodic point $\xi \in \hat{\mathbb{C}}$ with period p is said to be *rationally indifferent* if

$$(T^p)'(\xi) = e^{2\pi i q}$$

for some $q \in \mathbb{Q}$. We say that T is *parabolic* if $J(T)$ contains no critical points of T , but contains at least one rationally indifferent point. We will assume throughout that T is parabolic. We denote by Ω the finite set of parabolic points of T , and let

$$\Omega_0 = \{\xi \in \Omega \mid T(\xi) = \xi, T'(\xi) = 1\}.$$

As $J(T^n) = J(T)$ for every $n \in \mathbb{N}$, we may assume without loss of generality that $\Omega = \Omega_0$. We write $h = \dim_{\mathbb{H}} J(T)$. It was proven in [16] that h can also be characterised by the smallest zero of the function

$$P(t) = P(T, -t \log |T'|)$$

where the P on the right denotes the *topological pressure*. A similar result for hyperbolic Julia sets with ‘smallest’ replaced with ‘only’ is often referred to as the *Bowen-Manning-McCluskey formula*, see [11, 34].

We recall, see [18, 45], that for each $\omega \in \Omega$, we can find a ball $U_\omega = B(\omega, r_\omega)$ with sufficiently small radius such that on $B(\omega, r_\omega)$, there exists a unique holomorphic inverse branch T_ω^{-1} of T such that $T_\omega^{-1}(\omega) = \omega$. For a parabolic point $\omega \in \Omega$, the Taylor series of T about ω is of the form

$$z + a(z - \omega)^{p(\omega)+1} + \dots$$

We call $p(\omega)$ the *petal number* of ω , and we write

$$\begin{aligned} p_{\min} &= \min\{p(\omega) \mid \omega \in \Omega\} \\ p_{\max} &= \max\{p(\omega) \mid \omega \in \Omega\}. \end{aligned}$$

It was proven in [1] that $h > p_{\max}/(1 + p_{\max})$. We define the set of *pre-parabolic points* $J_p(T)$ by $J_p(T) = \bigcup_{k=0}^{\infty} T^{-k}(\Omega)$. It was proven in [16] that there exists a constant $C > 0$ such that to each $\xi \in J(T) \setminus J_p(T)$, we can associate a unique maximal sequence of integers $n_j(\xi)$ such that for each $j \in \mathbb{N}$, the inverse branches $T_\xi^{-n_j(\xi)}$ are well defined on $B(T^{n_j(\xi)}(\xi), C)$. We call $J_r(T) = J(T) \setminus J_p(T)$ the *radial Julia set*. Following [45, 46], we define

$$r_j(\xi) = |(T^{n_j(\xi)})'(\xi)|^{-1}$$

and call the sequence $(r_j(\xi))_{j \in \mathbb{N}}$ the *hyperbolic zoom* at ξ . Similarly, for each $\xi \in J_p(T)$, we can associate its *terminating hyperbolic zoom* $(r_j(\xi))_{j \in \{1, \dots, l\}}$. We also require the concept of a *canonical ball*, see [46]. Let $\omega \in \mathbf{\Omega}$, and let $I(\omega) = T^{-1}(\omega) \setminus \{\omega\}$. Then for each integer $n \geq 0$, we define the *canonical radius* r_ξ at $\xi \in T^{-n}(I(\omega))$ by

$$r_\xi = |(T^n)'(\xi)|^{-1}$$

and we call $B(\xi, r_\xi)$ the *canonical ball*. We will use the fact that $r_\xi \approx r_l$, where r_l is the last element in the terminating hyperbolic zoom at ξ .

Due to work from Aaronson, Denker and Urbański [1, 15, 16] it is known that given a parabolic rational map T , there exists a unique h -conformal measure m supported on $J(T)$, i.e. m is a probability measure such that for each Borel set $F \subset J(T)$ on which T is injective,

$$m(T(F)) = \int_F |T'(\xi)|^h dm(\xi).$$

In [18], it was shown that m has Hausdorff dimension h , and also that the box and packing dimensions of $J(T)$ are equal to h . It also follows from, for example, [46] that m is exact dimensional and therefore the packing and entropy dimensions are also given by h . We resolve the Assouad and lower dimensions and spectra of $J(T)$ and m in Theorems 3.3 and 3.4. Similar to the Kleinian setting, it was shown in [45] that m also has an associated global measure formula which we will make use of throughout.

Theorem 2.3 (Global Measure Formula II). *Let T be a parabolic rational map with Julia set $J(T)$ of Hausdorff dimension h . Let m denote the associated h -conformal measure supported on $J(T)$. Then there exists a function $\phi : J(T) \times \mathbb{R}^+ \rightarrow \mathbb{R}^+$ such that for all $\xi \in J(T)$ and $0 < r < |J(T)|$, we have*

$$m(B(\xi, r)) \approx r^h \phi(\xi, r).$$

The values of ϕ are determined as follows:

i) Suppose $\xi \in J_r(T)$ has associated optimal sequence $(n_j(\xi))_{j \in \mathbb{N}}$ and hyperbolic zooms $(r_j(\xi))_{j \in \mathbb{N}}$ and r is such that $r_{j+1}(\xi) \leq r < r_j(\xi)$ for some $j \in \mathbb{N}$ and $T^k(\xi) \in U_\omega$ for all $n_j(\xi) < k < n_{j+1}(\xi)$ and for some $\omega \in \mathbf{\Omega}$. Then

$$\phi(\xi, r) \approx \begin{cases} \left(\frac{r}{r_j(\xi)}\right)^{(h-1)p(\omega)} & r > r_j(\xi) \left(\frac{r_{j+1}(\xi)}{r_j(\xi)}\right)^{\frac{1}{1+p(\omega)}} \\ \left(\frac{r_{j+1}(\xi)}{r}\right)^{h-1} & r \leq r_j(\xi) \left(\frac{r_{j+1}(\xi)}{r_j(\xi)}\right)^{\frac{1}{1+p(\omega)}} \end{cases}.$$

ii) Suppose $\xi \in J_p(T)$ has associated terminating optimal sequence $(n_j(\xi))_{j=1, \dots, l}$ and hyperbolic zooms $(r_j(\xi))_{j=1, \dots, l}$. Suppose $T^{n_l(\xi)}(\xi) = \omega$ for some $\omega \in \mathbf{\Omega}$. If $r > r_l(\xi)$, the values of ϕ are determined as in the radial case, and if $r \leq r_l(\xi)$, then

$$\phi(\xi, r) \approx \left(\frac{r}{r_l(\xi)}\right)^{(h-1)p(\omega)}.$$

Note that similar to the Kleinian setting, if $J(T)$ contains no parabolic points, then a simple consequence of Theorem 2.3 is that

$$\dim_{\mathbb{A}} J(T) = \dim_{\mathbb{L}} J(T) = \dim_{\mathbb{A}} m = \dim_{\mathbb{L}} m = \dim_{\mathbb{B}} m = h$$

and

$$\dim_{\mathbb{A}}^{\theta} J(T) = \dim_{\mathbb{A}}^{\theta} m = \dim_{\mathbb{L}}^{\theta} J(T) = \dim_{\mathbb{L}}^{\theta} m = h$$

for all $\theta \in (0, 1)$. Therefore, we may assume throughout that $J(T)$ contains at least one parabolic point.

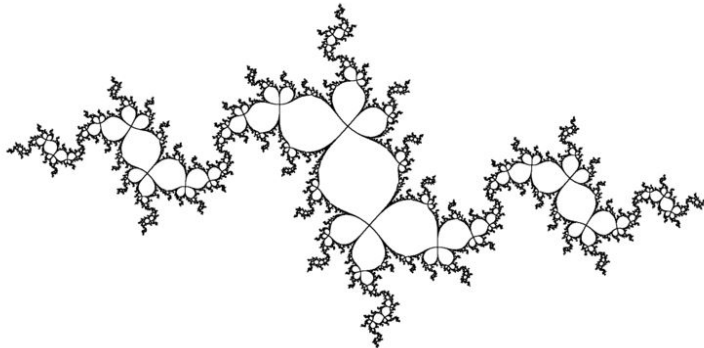

Figure 2: An example of a parabolic Julia set. Parabolic points with petal number 4 are easily spotted.

2.4 The Sullivan dictionary

Given the theory established above, many direct correspondences between the Kleinian group and rational map settings are already evident. We discuss some of these in detail here to put our results in a wider context. For us, the most important entry in the Sullivan dictionary (mentioned above) is that, in both cases, the Hausdorff, box and packing dimensions of the associated invariant fractal and the Hausdorff, packing and entropy dimensions of the associated conformal measure are all equal and given by a natural critical exponent. The relationship between Kleinian groups and rational maps goes much deeper than this, however, and now serves to connect many problems and communities across conformal geometry. See work of Sullivan, McMullen, and many others [37, 39, 49]. We can draw some comparisons between the theory we have discussed above as follows:

Kleinian	Julia
Kleinian group Γ	rational map T
Kleinian limit set $L(\Gamma)$	Julia set $J(T)$
Poincaré exponent δ	critical exponent h
Patterson-Sullivan measure μ	h -conformal measure m
global measure formula for μ	global measure formula for m
set of parabolic points P	set of pre-parabolic points $J_p(T)$
rank of parabolic point $k(p)$	petal number of parabolic point $p(\omega)$
dimension bound $\delta > k_{\max}/2$	dimension bound $h > p_{\max}/(1 + p_{\max})$
horoballs	canonical balls

Table 1: Some ‘entries’ in the Sullivan dictionary.

With the results we prove in this paper, we are able to provide several new entries in the Sullivan dictionary. Perhaps more strikingly, our work also provides several new ‘non-entries’, that is, where the correspondence between the two settings breaks down. This is novel in the setting of dimension theory, where the Sullivan dictionary provides a particularly strong correspondence. Our new entries and non-entries are discussed in Section 3.3.

3 Results

3.1 Results regarding Kleinian limit sets

We assume throughout that $\Gamma < \text{Con}(d)$ is a non-elementary geometrically finite Kleinian group containing at least one parabolic element, and write $L(\Gamma)$ to denote the associated limit set and μ to denote the associated Patterson-Sullivan measure. Recall that the Assouad and lower dimensions of $L(\Gamma)$ and μ were found in [21], see Theorem 2.1. Our first result gives formulae for the Assouad and lower spectrum of μ , as well as the box dimension of μ .

Theorem 3.1. *Let $\theta \in (0, 1)$. Then*

i) $\dim_{\text{B}}\mu = \max\{\delta, 2\delta - k_{\min}\}$.

ii) *If $\delta < k_{\min}$, then*

$$\dim_{\text{A}}^{\theta}\mu = \delta + \min\left\{1, \frac{\theta}{1-\theta}\right\}(k_{\max} - \delta),$$

if $k_{\min} \leq \delta < (k_{\min} + k_{\max})/2$, then

$$\dim_{\text{A}}^{\theta}\mu = 2\delta - k_{\min} + \min\left\{1, \frac{\theta}{1-\theta}\right\}(k_{\min} + k_{\max} - 2\delta)$$

and if $\delta \geq (k_{\min} + k_{\max})/2$, then $\dim_{\text{A}}^{\theta}\mu = 2\delta - k_{\min}$.

iii) *If $\delta > k_{\max}$, then*

$$\dim_{\text{L}}^{\theta}\mu = \delta - \min\left\{1, \frac{\theta}{1-\theta}\right\}(\delta - k_{\min}),$$

if $(k_{\min} + k_{\max})/2 < \delta \leq k_{\max}$, then

$$\dim_{\mathbb{L}}^{\theta} \mu = 2\delta - k_{\max} - \min \left\{ 1, \frac{\theta}{1-\theta} \right\} (2\delta - k_{\min} - k_{\max})$$

and if $\delta \leq (k_{\min} + k_{\max})/2$, then $\dim_{\mathbb{L}}^{\theta} \mu = 2\delta - k_{\max}$.

We prove Theorem 3.1 in Sections 4.2 - 4.4. The next theorem provides formulae for the Assouad and lower spectra of $L(\Gamma)$.

Theorem 3.2. *Let $\theta \in (0, 1)$.*

i) *If $\delta < k_{\max}$, then*

$$\dim_{\mathbb{A}}^{\theta} L(\Gamma) = \delta + \min \left\{ 1, \frac{\theta}{1-\theta} \right\} (k_{\max} - \delta)$$

and if $\delta \geq k_{\max}$, then $\dim_{\mathbb{A}}^{\theta} L(\Gamma) = \delta$.

ii) *If $\delta \leq k_{\min}$, then $\dim_{\mathbb{L}}^{\theta} L(\Gamma) = \delta$, and if $\delta > k_{\min}$, then*

$$\dim_{\mathbb{L}}^{\theta} L(\Gamma) = \delta - \min \left\{ 1, \frac{\theta}{1-\theta} \right\} (\delta - k_{\min}).$$

We prove Theorem 3.2 in Sections 4.5 and 4.6. We defer a detailed discussion of these results until Section 3.3, where they will be compared with the analogous results in the rational map setting.

3.2 Results regarding Julia sets

We assume throughout that T is a parabolic rational map, and write $J(T)$ to denote the associated Julia set and m to denote the associated h -conformal measure. We start with the dimensions and dimension spectra of m .

Theorem 3.3. *Let $\theta \in (0, 1)$. Then*

i) $\dim_{\mathbb{B}} m = \max\{h, h + (h-1)p_{\max}\}$.

ii) $\dim_{\mathbb{A}} m = \max\{1, h + (h-1)p_{\max}\}$.

iii) $\dim_{\mathbb{L}} m = \min\{1, h + (h-1)p_{\max}\}$.

iv) *If $h < 1$, then*

$$\dim_{\mathbb{A}}^{\theta} m = h + \min \left\{ 1, \frac{\theta p_{\max}}{1-\theta} \right\} (1-h)$$

and if $h \geq 1$, then $\dim_{\mathbb{A}}^{\theta} m = h + (h-1)p_{\max}$.

v) *If $h < 1$, then $\dim_{\mathbb{L}}^{\theta} m = h + (h-1)p_{\max}$ and if $h \geq 1$, then*

$$\dim_{\mathbb{L}}^{\theta} m = h + \min \left\{ 1, \frac{\theta p_{\max}}{1-\theta} \right\} (1-h).$$

We prove Theorem 3.3 in Sections 5.2 - 5.6. Turning our attention to $J(T)$, we have the following.

Theorem 3.4. *Let $\theta \in (0, 1)$. Then*

i) $\dim_{\mathbb{A}} J(T) = \max\{1, h\}$.

ii) $\dim_{\mathbb{L}} J(T) = \min\{1, h\}$.

iii) *If $h < 1$, then*

$$\dim_{\mathbb{A}}^{\theta} J(T) = h + \min \left\{ 1, \frac{\theta p_{\max}}{1 - \theta} \right\} (1 - h)$$

and if $h \geq 1$, then $\dim_{\mathbb{A}}^{\theta} J(T) = h$.

iv) *If $h < 1$, then $\dim_{\mathbb{L}}^{\theta} J(T) = h$ and if $h \geq 1$, then*

$$\dim_{\mathbb{L}}^{\theta} J(T) = h + \min \left\{ 1, \frac{\theta p_{\max}}{1 - \theta} \right\} (1 - h).$$

We prove Theorem 3.4 in Sections 5.7 - 5.10.

3.3 A new perspective on the Sullivan dictionary

3.3.1 New entries

1) *Interpolation between dimensions*

In both settings, the Assouad spectrum always interpolates between the upper box and Assouad dimensions of the respective sets and measures regardless of what form it takes, that is, $\lim_{\theta \rightarrow 1} \dim_{\mathbb{A}}^{\theta} F = \dim_{\mathbb{A}} F$ where F can be replaced by $\mu, L(\Gamma), m$ or $J(T)$. Recall that this interpolation does not hold in general. Similar interpolation holds as $\theta \rightarrow 1$ for the lower dimensions and spectra.

2) *Failure to witness the box dimension of measures*

For the measures μ and m , the lower spectrum does not generally tend to the box dimension as $\theta \rightarrow 0$. In fact, if the lower spectrum does tend to the box dimension as $\theta \rightarrow 0$, then it is constant and $\delta = k_{\min} = k_{\max}$ (in the Kleinian setting) and $h = 1$ (in the Julia setting).

3) *Formulae for the spectra*

In fact, the formulae for the Assouad spectra provide an even stronger correspondence than that described above. For F a given set or measure, consider

$$\rho = \inf \{ \theta \in (0, 1) \mid \dim_{\mathbb{A}}^{\theta} F = \dim_{\mathbb{A}} F \}.$$

It turns out that ρ provides the unique phase transition in the spectra and, moreover,

$$\dim_{\mathbb{A}}^{\theta} F = \min \left\{ \dim_{\mathbb{B}} F + \frac{(1 - \rho)\theta}{(1 - \theta)\rho} (\dim_{\mathbb{A}} F - \dim_{\mathbb{B}} F), \dim_{\mathbb{A}} F \right\}$$

where F can be replaced by $\mu, L(\Gamma), m$ or $J(T)$. This formula, and the fact that the Assouad spectrum can be expressed purely in terms of the phase transition and the box and Assouad dimensions, has appeared in a variety of settings, see [22, Section 17.7] and the discussion therein. For example, this formula also holds for self-affine Bedford-McMullen carpets [24]. The phase

transition ρ often has a natural ‘geometric significance’ for the objects involved and has led to a new ‘dictionary’ extending beyond the setting discussed here.

4) *The phase transition and the Hausdorff dimension bound*

There is a correspondence between the phase transition ρ and the general lower bounds for the Hausdorff dimension. Applying (2.1) shows that, for any non-empty bounded set F , $\rho \geq 1 - \overline{\dim}_B F / \dim_A F$. When the spectra are non-constant, in the Kleinian setting we always have $\rho = 1/2$, and in the Julia setting we always have $\rho = 1/(1 + p_{\max})$. Combining this with the general Hausdorff dimension bounds $\delta > k_{\max}/2 = k_{\max}\rho$ and $h > p_{\max}/(1 + p_{\max}) = p_{\max}\rho$ in both settings yields $\rho > 1 - \overline{\dim}_B F / \dim_A F$, showing that the upper bound from (2.1) is never achieved in either setting.

5) *The realisation problem*

Given the interplay between dimensions of sets and dimensions of measures seen in Section 2.1, one may ask if it is possible to construct an (invariant) measure ν which *realises* the dimensions of an (invariant) set F , that is, $\dim \nu = \dim F$. One can ask this about a particular choice of dimension \dim or if a single measure can be constructed to solve the problem for several notions of dimension simultaneously. We note that the measures μ and m *always* realise the Hausdorff dimensions of $L(\Gamma)$ and $J(T)$ respectively. As for the Assouad and lower dimensions, we note that μ realises the Assouad dimension of $L(\Gamma)$ when $\delta \leq (k_{\min} + k_{\max})/2$ and realises the lower dimension when $\delta \geq (k_{\min} + k_{\max})/2$. Similarly, for m to realise the Assouad dimension of $J(T)$ we require $h \leq 1$, and for m to realise the lower dimension of $J(T)$ we require $h \geq 1$. Note that a similar relationship holds for the box dimension too: in the Kleinian setting we require $\delta \leq k_{\min}$ and in the Julia setting we require $h \leq 1$.

6) *A special case*

Finally, we observe that in the (very) special case $k_{\min} = k_{\max} = p_{\max} = 1$, the formulae for the Assouad type dimensions and spectra are identical in the Kleinian and Julia settings. Does this suggest that this special case is one where we can expect the Sullivan dictionary to yield a particularly strong correspondence in other settings?

3.3.2 New non-entries

1) *Assouad dimension*

Our results show that Julia sets of parabolic rational maps can never have full Assouad dimension, that is, we always have $\dim_A J(T) < 2$. This uses our result together with [1, Theorem 8.8] which proves that $h < 2$. This is in stark contrast to the situation for Kleinian limit sets where it is perfectly possible for the Assouad dimension to be full, that is, $\Gamma \in \text{Con}(d)$ with $\dim_A L(\Gamma) = d = \dim \mathbb{S}^d$ for any integer $d \geq 1$, even when the limit set is nowhere dense in \mathbb{S}^d which implies $\dim_H L(\Gamma) < d$ (see [50, Theorem D]). We note that $\dim_A J(T) < 2$ also follows from [26, Theorem 1.4], where it was proved that parabolic Julia sets are porous, together with [32, Theorem 5.2], where it was proved that porous sets in \mathbb{R}^d must have Assouad dimension strictly less than d . Our results can thus be viewed as a refinement of the observation that Julia

sets are porous.

2) Lower dimension

Our results, together with the standard bound $h > p_{\max}/(1 + p_{\max})$, show that $\dim_{\text{L}}J(T) = \min\{1, h\} > p_{\max}/(1 + p_{\max})$, that is, the lower dimension respects the general lower bound satisfied by the Hausdorff dimension. Again, this is in stark contrast to the situation for Kleinian limit sets where the standard bound for Hausdorff dimension is $\delta > k_{\max}/2$ but $\dim_{\text{L}}L(\Gamma) = \min\{k_{\min}, \delta\} < k_{\max}/2$ is possible.

3) Relationships between dimensions

An interesting aspect of dimension theory is to consider what configurations are possible between the different notions of dimension in a particular setting. We refer the reader to [22, Section 17.5] for a more general discussion of this. Our results show that

$$\dim_{\text{L}}J(T) < \dim_{\text{H}}J(T) < \dim_{\text{A}}J(T)$$

is impossible in the Julia setting but the analogous configuration *is* possible in the Kleinian setting.

Configuration	Fuchsian	Kleinian	Julia
L=H=A	✓	✓	✓
L=H<A	✓	✓	✓
L<H=A	×	✓	✓
L<H<A	×	✓	×

Table 2: Summarising the possible relationships between the lower, Hausdorff, and Assouad dimensions of Fuchsian limit sets, Kleinian limits sets and parabolic Julia sets with the obvious labelling. The label ‘Fuchsian’ refers to the Kleinian setting when $d = 1$. The symbol ✓ means that the configuration is possible, and × means the configuration is impossible. In other situations it is interesting to add box dimension into this discussion, but here this always coincides with Hausdorff dimension and so we omit it.

4) The forms of the spectra

Turning our attention to the measures, we note that the Assouad and lower spectra of μ in the Kleinian setting can take 3 different forms, in comparison to the Julia setting where we only have 2 possibilities for m . We also note that in the Kleinian setting, both k_{\min} and k_{\max} appear in the formulae for the Assouad and lower spectra, sometimes simultaneously, but in the Julia setting only p_{\max} appears.

5) The realisation problem for dimension spectra

One can also extend the realisation problem to the Assouad and lower spectra: when does an (invariant) set support an (invariant) measure with equal Assouad or lower spectra? In the Kleinian setting, we have $\dim_{\text{A}}^{\theta}\mu = \dim_{\text{A}}^{\theta}L(\Gamma)$ when $\delta \leq k_{\min}$ and $\dim_{\text{L}}^{\theta}\mu = \dim_{\text{L}}^{\theta}L(\Gamma)$ when $\delta \geq k_{\max}$. This can leave a gap when $k_{\min} < \delta < k_{\max}$ where neither of the spectra are realised by the

Patterson-Sullivan measure. This is in contrast to the Julia setting where $\dim_{\mathbb{A}}^{\theta} m = \dim_{\mathbb{A}}^{\theta} J(T)$ when $h \leq 1$ and $\dim_{\mathbb{L}}^{\theta} m = \dim_{\mathbb{L}}^{\theta} J(T)$ when $h \geq 1$, and so at least one of the spectra is always realised by m .

6) Dimension spectra as a fingerprint

Suppose it is *not* true that $k_{\min} = k_{\max} = p_{\max} = 1$. Then simply by looking at plots of the Assouad and lower spectra, one can determine whether the set in question is a Kleinian limit set or a Julia set. Whenever the Assouad spectrum is non-constant in either the Kleinian or Julia setting, there is a unique phase transition at $\rho = \inf\{\theta \in (0, 1) \mid \dim_{\mathbb{A}}^{\theta} F = \dim_{\mathbb{A}} F\}$. Moreover $\rho = 1/2$ in the Kleinian setting and $\rho = 1/(1 + p_{\max})$ in the Julia setting. Note that in the Kleinian setting the phase transition is constant across all Kleinian limit sets, whereas in the Julia setting the phase transition depends on the rational map T . This allows one to distinguish between the Assouad spectrum of a Kleinian limit set and a Julia set just by looking at the phase transition, provided $p_{\max} \neq 1$. However, even if $p_{\max} = 1$, the spectra will still distinguish between the two settings provided we do not also have $k_{\min} = k_{\max} = 1$.

3.4 Examples

In order to give a visual idea of the results of Theorems 3.1 - 3.4, we plot the Assouad and lower spectra for some examples. In the Kleinian setting, we assume that $d = 2$ throughout for a more direct comparison with the Julia setting, and plot the following cases: when $\delta \leq k_{\min}$, when $k_{\min} < \delta < k_{\max}$ and when $\delta \geq k_{\max}$. In the Julia setting, we consider when $h < 1$ and when $h \geq 1$. The following are plots of the Assouad and lower spectra as functions of $\theta \in (0, 1)$. The spectra of μ and m are plotted with dashed lines, and the spectra of $L(\Gamma)$ and $J(T)$ by solid lines. The Assouad spectra are plotted in black and the lower spectra are plotted in grey.

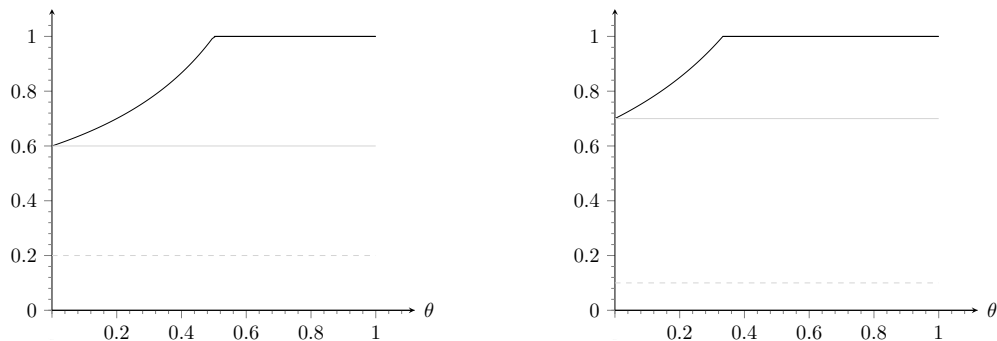

Figure 3: On the left, we have a Kleinian limit set with $\delta = 0.6$ and $k_{\min} = k_{\max} = 1$, and on the right we have a Julia set with $h = 0.7$ and $p_{\max} = 2$.

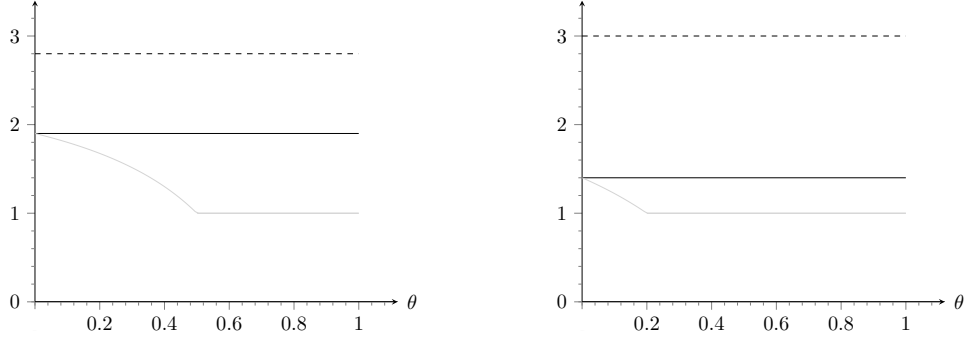

Figure 4: On the left, we have a Kleinian limit set with $\delta = 1.9$ and $k_{\min} = k_{\max} = 1$, and on the right we have a Julia set with $h = 1.4$ and $p_{\max} = 4$.

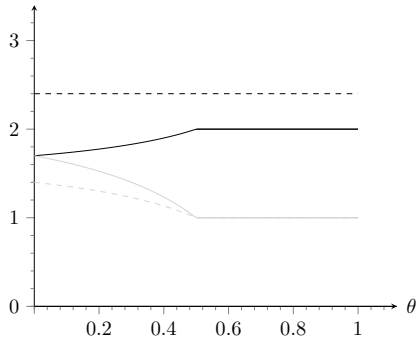

Figure 5: In this case, we have a Kleinian limit set with $\delta = 1.7$, $k_{\min} = 1$ and $k_{\max} = 2$. Recall that in the Julia setting, we always have either $\dim_{\mathbb{A}}^{\theta} m = \dim_{\mathbb{A}}^{\theta} J(T)$ or $\dim_{\mathbb{L}}^{\theta} m = \dim_{\mathbb{L}}^{\theta} J(T)$, and so these plots are impossible in the Julia setting.

4 Proofs of results regarding Kleinian limit sets

4.1 Preliminaries

As many of the proofs in the Kleinian setting are reliant on horoballs, many of the results in this section involve establishing estimates for quantities regarding horoballs, including the ‘escape functions’ $\rho(z, T)$. We start with the following lemma: one should think of the circle involved as a 2-dimensional slice of a horoball.

Lemma 4.1 (Circle Lemma). *Let $R > 0$, and consider a circle centred at $(0, R)$ with radius R , parametrised by $x(\theta) = R\sin\theta$ and $y(\theta) = R(1 - \cos\theta)$ ($0 \leq \theta < 2\pi$). For sufficiently small θ , we have*

$$\frac{\sqrt{Ry(\theta)}}{2} \leq x(\theta) \leq 2\sqrt{Ry(\theta)} \quad (4.1)$$

$$\frac{(x(\theta))^2}{4R} \leq y(\theta) \leq \frac{4(x(\theta))^2}{R}. \quad (4.2)$$

Proof. By Taylor’s Theorem, we have

$$\begin{aligned} x(\theta) &= R \left(\theta - \frac{\theta^3}{3!} + \frac{\theta^5}{5!} - \dots \right) \\ y(\theta) &= R \left(\frac{\theta^2}{2!} - \frac{\theta^4}{4!} + \frac{\theta^6}{6!} - \dots \right). \end{aligned}$$

We note that $x(\theta) \leq R\theta$ for all θ and $y(\theta) \geq R\theta^2/4$ for sufficiently small θ . So we get

$$x(\theta) \leq 2\sqrt{Ry(\theta)}$$

for sufficiently small θ . Similarly, we have that $x(\theta) \geq R\theta/2$ and $y(\theta) \leq R\theta^2$ for sufficiently small θ , which gives

$$y(\theta) \leq \frac{4(x(\theta))^2}{R}$$

as required. \square

We also require the following lemma to easily estimate the ‘escape function’ at a parabolic fixed point.

Lemma 4.2 (Parabolic Centre Lemma). *Let $p \in L(\Gamma)$ be a parabolic fixed point with associated standard horoball H_p . Then we have $\rho(p, T) \sim T$ as $T \rightarrow \infty$, and for sufficiently large $T > 0$ we have $k(p, T) = k(p)$.*

Proof. Let p_S be the ‘tip’ of the horoball H_p , in other words the point on the horoball H_p which lies on the geodesic joining $\mathbf{0}$ and p . It is obvious that $p_T \in H_p \iff T \geq S$, so for sufficiently large T we have $k(p, T) = k(p)$. Also note that

$$1 \geq \frac{\rho(p, T)}{T} = \frac{d_{\mathbb{H}}(p_T, p_S)}{T} = \frac{T - S}{T} \rightarrow 1 \text{ as } T \rightarrow \infty$$

as required. \square

One may note that some of the formulae for $\dim_{\mathbb{A}}^{\theta}\mu$ and $\dim_{\mathbb{L}}^{\theta}\mu$ involve both k_{\min} and k_{\max} . Consequently, in these cases we will need to consider two standard horoballs, where we drag one closer to the other. One could think of the following lemma as saying that the images of this horoball ‘fill in the gaps’ under the fixed horoball.

Lemma 4.3 (Horoball Radius Lemma). *Let $p, p' \in L(\Gamma)$ be two parabolic fixed points with associated standard horoballs H_p and $H_{p'}$ respectively, and let f be a parabolic element which fixes p . Then for sufficiently large n ,*

$$|f^n(p') - p| \approx \frac{1}{n} \quad \text{and} \quad |f^n(H_{p'})| = |H_{f^n(p')}| \approx \frac{1}{n^2}.$$

Proof. By considering an inverted copy of \mathbb{Z} converging to p , one sees that $|f^n(p') - p| \approx 1/n$, so we need only prove that $|H_{f^n(p')}| \approx 1/n^2$. Note that clearly $|H_{f^n(p')}| \lesssim 1/n^2$, as otherwise the horoballs would eventually overlap with H_p , using Lemma 4.1 and the fact that $|f^n(p') - p| \approx \frac{1}{n}$, contradicting the fact that our standard set of horoballs is chosen to be pairwise disjoint. For the lower bound, consider a point $u \neq p'$ on $H_{p'}$, and its images under the action of f . Let v denote the ‘shadow at infinity’ of u (see Figure 6), and note that for sufficiently large n ,

$$|f^n(v) - p| \approx \frac{1}{n}.$$

As $f^n(u)$ lies on a horoball with base point p , we can use Lemma 4.1 to deduce that $|f^n(u) - f^n(v)| \approx 1/n^2$ (see Figure 7), and therefore $|H_{f^n(p')}| \gtrsim 1/n^2$, as required. \square

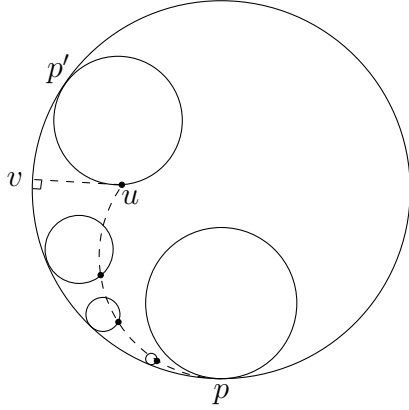

Figure 6: An illustration showing the points u and v . The dashed arc shows the horoball along which the point u is pulled under the action of f .

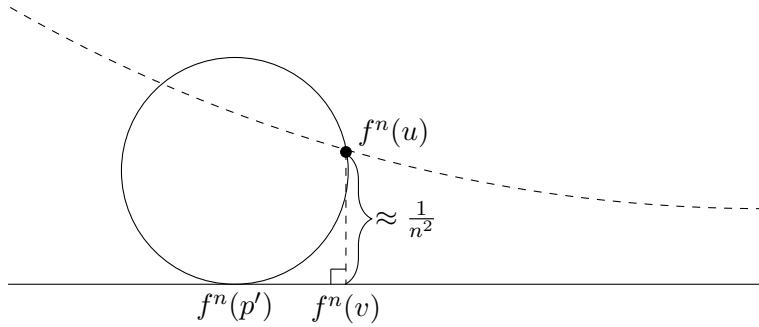

Figure 7: Applying Lemma 4.1, considering the dashed horoball.

The following lemma is also necessary for estimating hyperbolic distance, essentially saying that if $z, u \in L(\Gamma)$ are sufficiently close, then $d_{\mathbb{H}}(z_T, u_T)$ can be easily estimated.

Lemma 4.4. *Let $z, u \in L(\Gamma)$ and $T > 0$ be large. If $|z - u| \approx e^{-T}$, then $d_{\mathbb{H}}(z_T, u_T) \approx 1$.*

Proof. In order to bound $d_{\mathbb{H}}(z_T, u_T)$, we make use of a formula for hyperbolic distance, sometimes referred to as the cross ratio. Given points P and Q , draw a geodesic between them which intersects the boundary of the disc at points A and B such that A is closer to P than Q (see Figure 8). Then we have

$$d_{\mathbb{H}}(P, Q) = \log \frac{|AQ||BP|}{|AP||BQ|}. \quad (4.3)$$

Using the formula above with $P = z_T$ and $Q = u_T$, letting $A = z'$ and $B = u'$, and also noting that $|AQ| = |BP|$ and $|AP| = |BQ|$, we have

$$d_{\mathbb{H}}(z_T, u_T) \approx \log \frac{|z' - u_T|^2}{|z' - z_T|^2}.$$

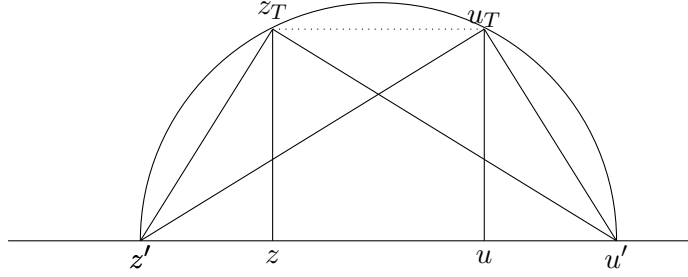

Figure 8: The cross ratio visualised.

Now, note that as $|z - u| \approx e^{-T}$, we also have $|z' - u| \lesssim e^{-T}$, and so by the triangle inequality we have

$$|z' - u_T| \leq |z' - u| + |u - u_T| \lesssim e^{-T}.$$

We also note that clearly $|z' - z_T| \gtrsim e^{-T}$, so by applying (4.3) we get

$$d_{\mathbb{H}}(z_T, u_T) \lesssim \log \frac{|z' - u_T|^2}{|z' - z_T|^2} \lesssim 1.$$

As $d_{\mathbb{H}}(z_T, u_T) > 0$, we have $d_{\mathbb{H}}(z_T, u_T) \approx 1$, as required. \square

Given a standard horoball H_p and $\lambda \in (0, 1]$, we call λH_p the *squeezed horoball* which still has base point p , but has Euclidean diameter scaled by a factor of λ , i.e. $|\lambda H_p| = \lambda |H_p|$. We also write $\Pi : \mathbb{D}^{d+1} \setminus \{\mathbf{0}\} \rightarrow \mathbb{S}^d$ to denote the projection defined by choosing $\Pi(z) \in \mathbb{S}^d$ such that $\mathbf{0}, z$, and $\Pi(z)$ are collinear. Given $A \subset \mathbb{D}^{d+1} \setminus \{\mathbf{0}\}$, we call $\Pi(A)$ the *shadow at infinity* of A , and note that for a horoball H_p , $\Pi(H_p)$ is a Euclidean ball with $|\Pi(H_p)| \approx |H_p|$. We require the following lemma due to Stratmann and Velani [47, Corollary 3.5] regarding squeezed horoballs.

Lemma 4.5. *Let H_p be a standard horoball for some $p \in P$, and let $\lambda \in (0, 1]$. Then*

$$\mu(\Pi(\lambda H_p)) \approx \lambda^{2\delta - k(p)} |H_p|^\delta.$$

We also require the following lemma due to Fraser [21, Lemma 5.2], which allows us to count horoballs of certain sizes.

Lemma 4.6. *Let $z \in L(\Gamma)$ and $T > t > 0$. For t sufficiently large, we have*

$$\sum_{\substack{p \in P \cap B(z, e^{-t}) \\ e^{-t} > |H_p| \geq e^{-T}}} |H_p|^\delta \lesssim (T - t) \mu(B(z, e^{-t}))$$

where P is the set of parabolic fixed points contained in $L(\Gamma)$.

4.2 The box dimension of μ

4.2.1 Upper bound

- We show $\overline{\dim}_{\mathbb{B}} \mu \leq \max\{\delta, 2\delta - k_{\min}\}$.

Let $z \in L(\Gamma)$ and $T > 0$. We have

$$\mu(B(z, e^{-T})) \gtrsim e^{-T\delta} e^{-\rho(z, T)(\delta - k(z, T))} \geq e^{-T\delta} (e^{-T})^{\max\{0, \delta - k_{\min}\}} = (e^{-T})^{\max\{\delta, 2\delta - k_{\min}\}}$$

which proves $\overline{\dim}_B \mu \leq \max\{\delta, 2\delta - k_{\min}\}$.

4.2.2 Lower bound

- We show $\underline{\dim}_B \mu \geq \max\{\delta, 2\delta - k_{\min}\}$.

Note that we have $\underline{\dim}_B \mu \geq \underline{\dim}_B L(\Gamma) = \delta$, so it suffices to prove that $\underline{\dim}_B \mu \geq 2\delta - k_{\min}$, and therefore we may assume that $\delta \geq k_{\min}$.

Let p be a parabolic fixed point such that $k(p) = k_{\min}$, and let $\varepsilon \in (0, 1)$. By Lemma 4.2, it follows that for sufficiently large $T > 0$, we have

$$\mu(B(p, e^{-T})) \lesssim e^{-T\delta} e^{-\rho(p, T)(\delta - k(p))} \leq e^{-T\delta} e^{-(1-\varepsilon)T(\delta - k_{\min})} = (e^{-T})^{\delta + (1-\varepsilon)(\delta - k_{\min})}$$

which proves $\underline{\dim}_B \mu \geq 2\delta - k_{\min} - \varepsilon(\delta - k_{\min})$, and letting $\varepsilon \rightarrow 0$ proves the lower bound.

4.3 The Assouad spectrum of μ

4.3.1 When $\delta < k_{\min}$

- *Lower bound:* We show $\dim_A^\theta \mu \geq \delta + \min\left\{1, \frac{\theta}{1-\theta}\right\} (k_{\max} - \delta)$.

Let $\theta \in (0, 1)$, let $p \in L(\Gamma)$ be a parabolic fixed point such that $k(p) = k_{\max}$, f be a parabolic element fixing p , and $n \in \mathbb{N}$ be very large. Choose $p \neq z_0 \in L(\Gamma)$, and let $z = f^n(z_0)$, noting that $z \rightarrow p$ as $n \rightarrow \infty$. We assume n is large enough to ensure that the geodesic joining $\mathbf{0}$ and z intersects H_p , and choose $T > 0$ to be the larger of two values such that z_T lies on the boundary of H_p .

We now restrict our attention to the hyperplane $H(p, z, z_T)$ restricted to \mathbb{D}^{d+1} . Define v to be the point on $H_p \cap H(p, z, z_T)$ such that v lies on the quarter circle with centre z and Euclidean radius $e^{-T\theta}$ (see Figure 9 below). We also consider 2 additional points u and w , where u is the ‘shadow at infinity’ of v and $w = u_{T\theta}$.

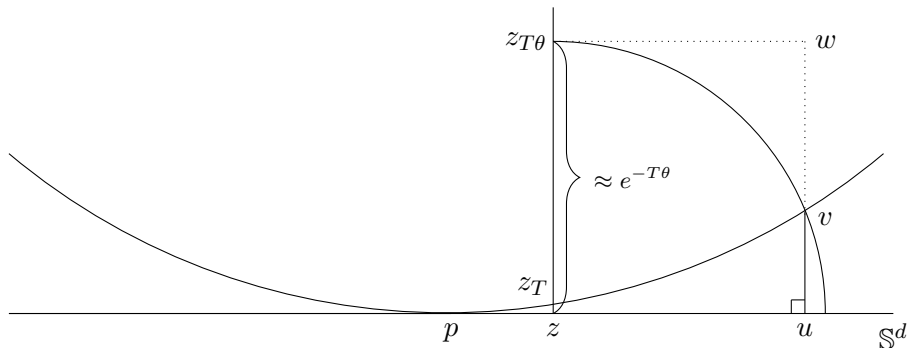

Figure 9: An overview of the horoball H_p along with our chosen points. We wish to find a lower bound for $d_{\mathbb{H}}(z_{T\theta}, v)$.

Our goal is to bound $d_{\mathbb{H}}(v, w)$ from below and $d_{\mathbb{H}}(w, z_{T\theta})$ from above.

Consider the Euclidean distance between z and p . Note that z_T lies on the horoball H_p , so using

(4.1) we have, for sufficiently large n ,

$$|z - p| \lesssim \sqrt{|z - z_T|} \lesssim e^{-\frac{T}{2}}.$$

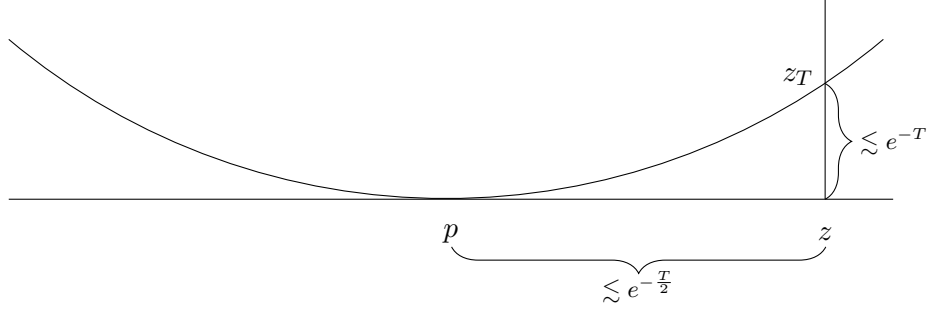

Figure 10: Bounding $|z - p|$ from above using Lemma 4.1.

Also note that clearly $|z - u| \lesssim e^{-T\theta}$. We can apply (4.2), this time considering the point v , and so for sufficiently large n , we obtain

$$|u - v| \lesssim \left(e^{-\frac{T}{2}} + e^{-T\theta} \right)^2 \lesssim e^{-\min\{2T\theta, T\}}.$$

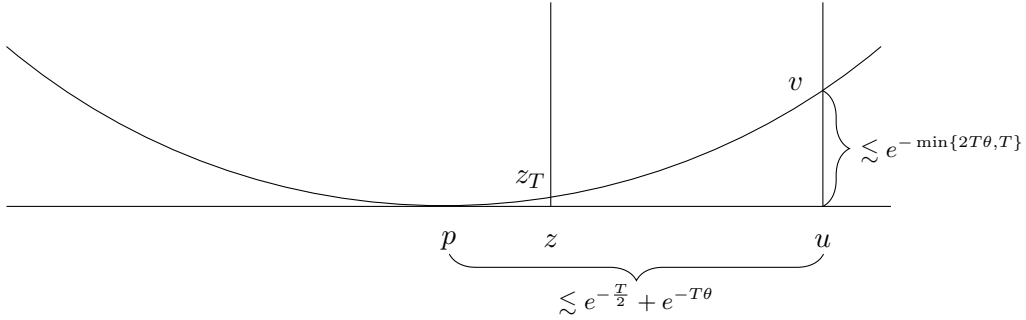

Figure 11: Bounding $|u - v|$ from above, again using Lemma 4.1.

This gives us

$$d_{\mathbb{H}}(v, w) = \log \frac{|z - z_{T\theta}|}{|u - v|} \geq \log \frac{e^{-T\theta}/C_1}{C_2 e^{-\min\{2T\theta, T\}}} = \min\{T(1 - \theta), T\theta\} - \log(C_1 C_2)$$

for some constants C_1, C_2 . We can apply Lemma 4.4 to deduce that $d_{\mathbb{H}}(z_{T\theta}, w) \leq C_3$ for some constant C_3 . Therefore, by the triangle inequality

$$\begin{aligned} \rho(z, T\theta) &= d_{\mathbb{H}}(z_{T\theta}, v) \geq d_{\mathbb{H}}(w, v) - d_{\mathbb{H}}(z_{T\theta}, w) \\ &\geq \min\{T(1 - \theta), T\theta\} - \log(C_1 C_2) - C_3. \end{aligned} \quad (4.4)$$

By Theorem 2.2, we have

$$\begin{aligned}
\frac{\mu(B(z, e^{-T\theta}))}{\mu(B(z, e^{-T}))} &\approx \frac{e^{-\delta T\theta} e^{\rho(z, T\theta)(k_{\max} - \delta)}}{e^{-\delta T} 1} \\
&\gtrsim \left(e^{T(1-\theta)}\right)^\delta e^{\min\{T(1-\theta), T\theta\}(k_{\max} - \delta)} \quad \text{by (4.4)} \\
&= \left(e^{T(1-\theta)}\right)^\delta \left(e^{T(1-\theta)}\right)^{\min\{1, \frac{\theta}{1-\theta}\}(k_{\max} - \delta)} \\
&= \left(e^{T(1-\theta)}\right)^{\delta + \min\{1, \frac{\theta}{1-\theta}\}(k_{\max} - \delta)}
\end{aligned}$$

which gives

$$\dim_{\mathbb{A}}^\theta \mu \geq \delta + \min\left\{1, \frac{\theta}{1-\theta}\right\} (k_{\max} - \delta)$$

as required.

- *Upper bound:* We show $\dim_{\mathbb{A}}^\theta \mu \leq \delta + \min\left\{1, \frac{\theta}{1-\theta}\right\} (k_{\max} - \delta)$.
Let $z \in L(\Gamma)$, $T > 0$. Note that we have

$$\dim_{\mathbb{A}}^\theta \mu \leq \dim_{\mathbb{A}} \mu = k_{\max}$$

so we assume that $\theta \in (0, 1/2)$. Then by Theorem 2.2, we have

$$\begin{aligned}
\frac{\mu(B(z, e^{-T\theta}))}{\mu(B(z, e^{-T}))} &\approx \frac{e^{-\delta T\theta} e^{-\rho(z, T\theta)(\delta - k(z, T\theta))}}{e^{-\delta T} e^{-\rho(z, T)(\delta - k(z, T))}} \lesssim \left(e^{T(1-\theta)}\right)^\delta e^{\rho(z, T\theta)(k_{\max} - \delta)} \\
&\leq \left(e^{T(1-\theta)}\right)^\delta e^{T\theta(k_{\max} - \delta)} \\
&= \left(e^{T(1-\theta)}\right)^{\delta + \frac{\theta}{1-\theta}(k_{\max} - \delta)}
\end{aligned}$$

which gives

$$\dim_{\mathbb{A}}^\theta \mu \leq \delta + \frac{\theta}{1-\theta} (k_{\max} - \delta)$$

as required.

4.3.2 When $k_{\min} \leq \delta < (k_{\min} + k_{\max})/2$

- *Lower bound:* We show $\dim_{\mathbb{A}}^\theta \mu \geq 2\delta - k_{\min} + \min\left\{1, \frac{\theta}{1-\theta}\right\} (k_{\min} + k_{\max} - 2\delta)$.

Let $\theta \in (0, 1/2)$, let $p, p' \in L(\Gamma)$ be parabolic fixed points such that $k(p) = k_{\max}$ and $k(p') = k_{\min}$, and let f be a parabolic element fixing p . Let n be a large positive integer and let $z = f^n(p')$. By Lemma 4.3, we note that for sufficiently large n we may choose T such that $k(z, T) = k_{\min}$, $k(z, T\theta) = k_{\max}$, and $|z - p| = e^{-T\theta}$ (see Figure 12).

We can make use of Lemma 4.4 to deduce that

$$d_{\mathbb{H}}(z_{T\theta}, p_{T\theta}) \leq C_1$$

for some constant C_1 . Also, by Lemma 4.2, given $\varepsilon \in (0, 1)$ we have that $\rho(p, T\theta) \geq (1 - \varepsilon)T\theta$ for sufficiently large n . This gives

$$\rho(z, T\theta) \geq \rho(p, T\theta) - C_1 \geq (1 - \varepsilon)T\theta - C_1. \quad (4.5)$$

Finally, we note that as $|z - p| = e^{-T\theta}$, by Lemma 4.1 we have $|H_z| \approx e^{-2T\theta}$ (see Figure 13), which implies that

$$\rho(z, T) \geq \log \frac{e^{-2T\theta}/C_2}{C_3 e^{-T}} = T(1 - 2\theta) - \log(C_2 C_3) \quad (4.6)$$

for some constants C_2, C_3 .

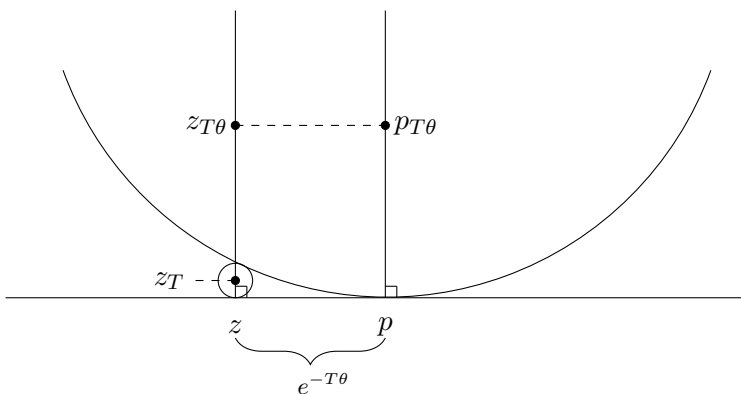

Figure 12: Making use of Lemma 4.3 so we can choose our desired T .

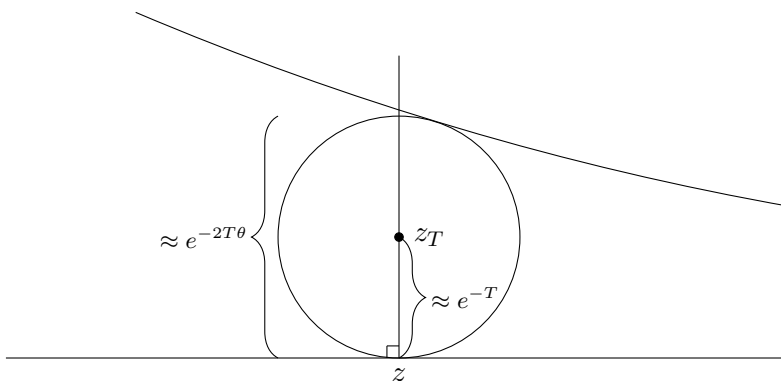

Figure 13: Calculating $\rho(z, T)$ using Lemma 4.1.

Applying (2.2), we get

$$\begin{aligned}
\frac{\mu(B(z, e^{-T\theta}))}{\mu(B(z, e^{-T}))} &\approx \frac{e^{-\delta T\theta} e^{\rho(z, T\theta)(k_{\max} - \delta)}}{e^{-\delta T} e^{-\rho(z, T)(\delta - k_{\min})}} \\
&\gtrsim \left(e^{T(1-\theta)}\right)^\delta e^{(1-\varepsilon)T\theta(k_{\max} - \delta) + (1-2\theta)T(\delta - k_{\min})} \quad \text{by (4.5) and (4.6)} \\
&= \left(e^{T(1-\theta)}\right)^\delta e^{T(1-\theta)\delta + T(1-\theta)k_{\min} + T\theta(k_{\min} + k_{\max} - 2\delta) - \varepsilon T\theta(k_{\max} - \delta)} \\
&\geq \left(e^{T(1-\theta)}\right)^{2\delta - k_{\min} + \frac{\theta}{1-\theta}(k_{\min} + k_{\max} - 2\delta) - \varepsilon \frac{\theta}{1-\theta}(k_{\max} - \delta)}
\end{aligned}$$

which proves

$$\dim_{\mathbb{A}}^\theta \mu \geq 2\delta - k_{\min} + \frac{\theta}{1-\theta}(k_{\min} + k_{\max} - 2\delta) - \varepsilon \frac{\theta}{1-\theta}(k_{\max} - \delta)$$

and letting $\varepsilon \rightarrow 0$ proves the desired lower bound.

The case when $\theta \geq 1/2$ follows identically to the lower bound in Section 4.3.1, so we omit the details.

- *Upper bound:* We show $\dim_{\mathbb{A}}^\theta \mu \leq 2\delta - k_{\min} + \min\left\{1, \frac{\theta}{1-\theta}\right\}(k_{\min} + k_{\max} - 2\delta)$.

Let $z \in L(\Gamma)$, $T > 0$, $\theta \in (0, 1/2)$ (the case when $\theta \geq 1/2$ follows similarly to the upper bound in Section 4.3.1). If z_T and $z_{T\theta}$ do not lie in a common standard horoball, we may use the fact that

$$\rho(z, T) \leq T(1-\theta) - \rho(z, T\theta). \quad (4.7)$$

We have by Theorem 2.2

$$\begin{aligned}
\frac{\mu(B(z, e^{-T\theta}))}{\mu(B(z, e^{-T}))} &\approx \frac{e^{-\delta T\theta} e^{-\rho(z, T\theta)(\delta - k(z, T\theta))}}{e^{-\delta T} e^{-\rho(z, T)(\delta - k(z, T))}} \leq \frac{e^{-\delta T\theta} e^{-\rho(z, T\theta)(\delta - k_{\max})}}{e^{-\delta T} e^{-\rho(z, T)(\delta - k_{\min})}} \\
&= \left(e^{T(1-\theta)}\right)^\delta e^{\rho(z, T\theta)(k_{\max} - \delta) + \rho(z, T)(\delta - k_{\min})} \\
&\leq \left(e^{T(1-\theta)}\right)^\delta e^{T\theta(k_{\min} + k_{\max} - 2\delta) + T(1-\theta)(\delta - k_{\min})} \quad \text{by (4.7)} \\
&\leq \left(e^{T(1-\theta)}\right)^{2\delta - k_{\min} + \frac{\theta}{1-\theta}(k_{\min} + k_{\max} - 2\delta)}
\end{aligned}$$

If z_T and $z_{T\theta}$ do lie in a common standard horoball H_p and $\delta \geq k(p)$, then we use the inequality

$$|\rho(z, T) - \rho(z, T\theta)| \leq T(1-\theta). \quad (4.8)$$

Then we have

$$\begin{aligned}
\frac{\mu(B(z, e^{-T\theta}))}{\mu(B(z, e^{-T}))} &\approx \frac{e^{-\delta T\theta} e^{-\rho(z, T\theta)(\delta - k(z, T\theta))}}{e^{-\delta T} e^{-\rho(z, T)(\delta - k(z, T))}} = \left(e^{T(1-\theta)}\right)^\delta e^{(\rho(z, T) - \rho(z, T\theta))(\delta - k(p))} \\
&\leq \left(e^{T(1-\theta)}\right)^\delta e^{T(1-\theta)(\delta - k_{\min})} \quad \text{by (4.8)} \\
&= \left(e^{T(1-\theta)}\right)^{2\delta - k_{\min}} \\
&\leq \left(e^{T(1-\theta)}\right)^{2\delta - k_{\min} + \frac{\theta}{1-\theta}(k_{\min} + k_{\max} - 2\delta)}
\end{aligned}$$

if $\rho(z, T) - \rho(z, T\theta) \geq 0$, and otherwise

$$\begin{aligned} \frac{\mu(B(z, e^{-T\theta}))}{\mu(B(z, e^{-T}))} &\approx \left(e^{T(1-\theta)}\right)^\delta e^{(\rho(z, T) - \rho(z, T\theta))(\delta - k(p))} \leq \left(e^{T(1-\theta)}\right)^\delta \\ &\leq \left(e^{T(1-\theta)}\right)^{2\delta - k_{\min} + \frac{\theta}{1-\theta}(k_{\min} + k_{\max} - 2\delta)} \end{aligned}$$

If $\delta < k(p)$, then we use

$$\rho(z, T\theta) - \rho(z, T) \leq T\theta. \quad (4.9)$$

By Theorem 2.2,

$$\begin{aligned} \frac{\mu(B(z, e^{-T\theta}))}{\mu(B(z, e^{-T}))} &\approx \left(e^{T(1-\theta)}\right)^\delta e^{(\rho(z, T) - \rho(z, T\theta))(\delta - k(p))} \leq \left(e^{T(1-\theta)}\right)^\delta e^{T\theta(k(p) - \delta)} \quad \text{by (4.9)} \\ &\leq \left(e^{T(1-\theta)}\right)^{\delta + \frac{\theta}{1-\theta}(k_{\max} - \delta)} \\ &\leq \left(e^{T(1-\theta)}\right)^{2\delta - k_{\min} + \frac{\theta}{1-\theta}(k_{\min} + k_{\max} - 2\delta)} \end{aligned}$$

In all cases, we have

$$\dim_{\Lambda}^{\theta} \mu \leq 2\delta - k_{\min} + \frac{\theta}{1-\theta}(k_{\min} + k_{\max} - 2\delta)$$

as required.

4.3.3 When $\delta \geq (k_{\min} + k_{\max})/2$

- We show $\dim_{\Lambda}^{\theta} \mu = 2\delta - k_{\min}$.

This follows easily, since $2\delta - k_{\min} = \overline{\dim}_{\mathbb{B}} \mu \leq \dim_{\Lambda}^{\theta} \mu \leq \dim_{\Lambda} \mu = 2\delta - k_{\min}$ and so $\dim_{\Lambda}^{\theta} \mu = 2\delta - k_{\min}$, as required.

4.4 The lower spectrum of μ

The proofs of the bounds for the lower spectrum follow similarly to the Assouad spectrum, and so we only sketch the arguments.

4.4.1 When $\delta > k_{\max}$

- *Upper bound:* We show $\dim_{\mathbb{L}}^{\theta} \mu \leq \delta - \min\left\{1, \frac{\theta}{1-\theta}\right\}(\delta - k_{\min})$.

Let $\theta \in (0, 1)$, $p \in L(\Gamma)$ be a parabolic fixed point such that $k(p) = k_{\min}$, f be a parabolic element fixing p , and $n \in \mathbb{N}$ be very large. Choose $p \neq z_0 \in L(\Gamma)$, and let $z = f^n(z_0)$. We choose $T > 0$ such that z_T is the 'exit point' from H_p . Identically to the lower bound in Section 4.3.1, we have that

$$\rho(z, T\theta) \geq \min\{T(1-\theta), T\theta\} - C$$

for some constant C . Applying Theorem 2.2, we have

$$\begin{aligned} \frac{\mu(B(z, e^{-T\theta}))}{\mu(B(z, e^{-T}))} &\approx \frac{e^{-\delta T\theta} e^{-\rho(z, T\theta)(\delta - k_{\min})}}{e^{-\delta T} 1} \lesssim \left(e^{T(1-\theta)}\right)^\delta e^{-\min\{T(1-\theta), T\theta\}(\delta - k_{\min})} \\ &= \left(e^{T(1-\theta)}\right)^\delta \left(e^{T(1-\theta)}\right)^{-\min\{1, \frac{\theta}{1-\theta}\}(\delta - k_{\min})} \\ &= \left(e^{T(1-\theta)}\right)^{\delta - \min\{1, \frac{\theta}{1-\theta}\}(\delta - k_{\min})} \end{aligned}$$

which gives

$$\dim_L^\theta \mu \leq \delta - \min\left\{1, \frac{\theta}{1-\theta}\right\}(\delta - k_{\min})$$

as required.

- *Lower bound:* We show $\dim_L^\theta \mu \geq \delta - \min\left\{1, \frac{\theta}{1-\theta}\right\}(\delta - k_{\min})$.

Let $z \in L(\Gamma)$, $T > 0$. Note that $\dim_L^\theta \mu \geq \dim_L \mu = k_{\min}$ so we assume $\theta \in (0, 1/2)$. Then by Theorem 2.2, we have

$$\begin{aligned} \frac{\mu(B(z, e^{-T\theta}))}{\mu(B(z, e^{-T}))} &\approx \frac{e^{-\delta T\theta} e^{-\rho(z, T\theta)(\delta - k(z, T\theta))}}{e^{-\delta T} e^{-\rho(z, T)(\delta - k(z, T))}} \gtrsim \left(e^{T(1-\theta)}\right)^\delta e^{-\rho(z, T\theta)(\delta - k_{\min})} \geq \left(e^{T(1-\theta)}\right)^\delta e^{-T\theta(\delta - k_{\min})} \\ &= \left(e^{T(1-\theta)}\right)^{\delta - \frac{\theta}{1-\theta}(\delta - k_{\min})} \end{aligned}$$

which gives

$$\dim_L^\theta \mu \geq \delta - \frac{\theta}{1-\theta}(\delta - k_{\min})$$

as required.

4.4.2 When $(k_{\min} + k_{\max})/2 < \delta \leq k_{\max}$

- *Upper bound:* We show $\dim_L^\theta \mu \leq 2\delta - k_{\max} - \min\left\{1, \frac{\theta}{1-\theta}\right\}(2\delta - k_{\min} - k_{\max})$.

Similarly to the lower bound in Section 4.3.2, we only need to deal with the case when $\theta \in (0, 1/2)$. Let $p, p' \in L(\Gamma)$ be parabolic fixed points such that $k(p) = k_{\min}$ and $k(p') = k_{\max}$, and let f be a parabolic element fixing p . Let n be a large integer and let $z = f^n(p')$. Again, by Lemma 4.3, for sufficiently large n we may choose T such that $k(z, T) = k_{\max}$ and $k(z, T\theta) = k_{\min}$. We may argue in the same manner as the lower bound in Section 4.3.2 to show that, for sufficiently large n ,

$$\rho(z, T\theta) \geq (1 - \varepsilon)T\theta - C_1 \quad \text{and} \quad \rho(z, T) \geq T(1 - 2\theta) - C_2$$

for some $\varepsilon \in (0, 1)$ and some constants C_1, C_2 . Applying Theorem 2.2 gives

$$\begin{aligned} \frac{\mu(B(z, e^{-T\theta}))}{\mu(B(z, e^{-T}))} &\approx \frac{e^{-\delta T\theta} e^{\rho(z, T\theta)(k_{\min} - \delta)}}{e^{-\delta T} e^{-\rho(z, T)(\delta - k_{\max})}} \\ &\lesssim \left(e^{T(1-\theta)}\right)^\delta e^{(1-\varepsilon)T\theta(k_{\min} - \delta) + (1-2\theta)T(\delta - k_{\max})} \\ &= \left(e^{T(1-\theta)}\right)^\delta e^{T(1-\theta)\delta - T(1-\theta)k_{\max} - T\theta(2\delta - k_{\min} - k_{\max}) + \varepsilon T\theta(\delta - k_{\min})} \\ &= \left(e^{T(1-\theta)}\right)^{2\delta - k_{\max} - \frac{\theta}{1-\theta}(2\delta - k_{\min} - k_{\max}) + \varepsilon \frac{\theta}{1-\theta}(\delta - k_{\min})} \end{aligned}$$

which gives

$$\dim_L^\theta \mu \leq 2\delta - k_{\max} - \frac{\theta}{1-\theta}(2\delta - k_{\min} - k_{\max}) + \varepsilon \frac{\theta}{1-\theta}(\delta - k_{\min})$$

and letting $\varepsilon \rightarrow 0$ proves the desired upper bound.

• *Lower bound:* We show $\dim_L^\theta \mu \geq 2\delta - k_{\max} - \min\left\{1, \frac{\theta}{1-\theta}\right\}(2\delta - k_{\min} - k_{\max})$.

Let $z \in L(\Gamma)$, $T > 0$, $\theta \in (0, 1/2)$ (the case when $\theta \geq 1/2$ follows similarly to the lower bound in Section 4.4.1). Suppose z_T and $z_{T\theta}$ do not lie in a common standard horoball. Applying Theorem 2.2 gives

$$\begin{aligned} \frac{\mu(B(z, e^{-T\theta}))}{\mu(B(z, e^{-T}))} &\approx \frac{e^{-\delta T\theta} e^{-\rho(z, T\theta)(\delta - k(z, T\theta))}}{e^{-\delta T} e^{-\rho(z, T)(\delta - k(z, T))}} \\ &\geq \frac{e^{-\delta T\theta} e^{-\rho(z, T\theta)(\delta - k_{\min})}}{e^{-\delta T} e^{-\rho(z, T)(\delta - k_{\max})}} \\ &= \left(e^{T(1-\theta)}\right)^\delta e^{\rho(z, T\theta)(k_{\min} - \delta) + \rho(z, T)(\delta - k_{\max})} \\ &\geq \left(e^{T(1-\theta)}\right)^\delta e^{T\theta(k_{\max} + k_{\min} - 2\delta) + T(1-\theta)(\delta - k_{\min})} \quad \text{by (4.7)} \\ &\geq \left(e^{T(1-\theta)}\right)^{2\delta - k_{\min} - \frac{\theta}{1-\theta}(2\delta - k_{\min} - k_{\max})}. \end{aligned}$$

If z_T and $z_{T\theta}$ do lie in a common standard horoball H_p and $\delta \leq k(p)$, then we have

$$\begin{aligned} \frac{\mu(B(z, e^{-T\theta}))}{\mu(B(z, e^{-T}))} &\approx \frac{e^{-\delta T\theta} e^{-\rho(z, T\theta)(\delta - k(z, T\theta))}}{e^{-\delta T} e^{-\rho(z, T)(\delta - k(z, T))}} = \left(e^{T(1-\theta)}\right)^\delta e^{(\rho(z, T) - \rho(z, T\theta))(\delta - k(p))} \\ &\geq \left(e^{T(1-\theta)}\right)^\delta e^{T(1-\theta)(\delta - k_{\max})} \quad \text{by (4.8)} \\ &= \left(e^{T(1-\theta)}\right)^{2\delta - k_{\max}} \\ &\geq \left(e^{T(1-\theta)}\right)^{2\delta - k_{\max} - \frac{\theta}{1-\theta}(2\delta - k_{\min} - k_{\max})} \end{aligned}$$

if $\rho(z, T) - \rho(z, T\theta) \geq 0$, and otherwise

$$\begin{aligned} \frac{\mu(B(z, e^{-T\theta}))}{\mu(B(z, e^{-T}))} &\approx \left(e^{T(1-\theta)}\right)^\delta e^{(\rho(z, T) - \rho(z, T\theta))(\delta - k(p))} \geq \left(e^{T(1-\theta)}\right)^\delta \\ &\geq \left(e^{T(1-\theta)}\right)^{2\delta - k_{\max} - \frac{\theta}{1-\theta}(2\delta - k_{\min} - k_{\max})}. \end{aligned}$$

If $\delta > k(p)$, then

$$\begin{aligned} \frac{\mu(B(z, e^{-T\theta}))}{\mu(B(z, e^{-T}))} &\approx \left(e^{T(1-\theta)}\right)^\delta e^{(\rho(z, T) - \rho(z, T\theta))(\delta - k(p))} \geq \left(e^{T(1-\theta)}\right)^\delta e^{-T\theta(\delta - k(p))} \quad \text{by (4.9)} \\ &\geq \left(e^{T(1-\theta)}\right)^{\delta - \frac{\theta}{1-\theta}(\delta - k_{\min})} \\ &\geq \left(e^{T(1-\theta)}\right)^{2\delta - k_{\max} - \frac{\theta}{1-\theta}(2\delta - k_{\min} - k_{\max})}. \end{aligned}$$

In all cases, we have

$$\dim_{\mathbb{L}}^{\theta} \mu \geq 2\delta - k_{\max} - \frac{\theta}{1-\theta}(2\delta - k_{\min} - k_{\max})$$

as required.

4.4.3 When $\delta \leq (k_{\min} + k_{\max})/2$

- We show $\dim_{\mathbb{L}}^{\theta} \mu = 2\delta - k_{\max}$.

Let $p, p' \in L(\Gamma)$ be two parabolic fixed points such that $k(p') = k_{\max}$, let f be a parabolic element fixing p and let n be a large positive integer. Let $z = f^n(p')$ and let $\varepsilon \in (0, 1)$. Note that for sufficiently large n and Lemma 4.2, we may choose T such that

$$\rho(z, T) \geq (1 - \varepsilon)T \text{ and } \rho(z, T\theta) = 0.$$

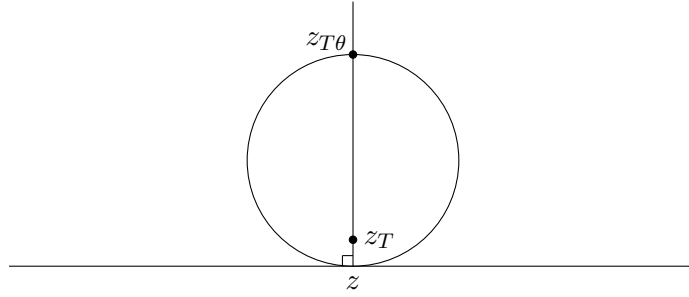

Figure 14: Choosing the appropriate T .

By Theorem 2.2, we have

$$\begin{aligned} \frac{\mu(B(z, e^{-T\theta}))}{\mu(B(z, e^{-T}))} &\approx \frac{e^{-\delta T\theta}}{e^{-\delta T}} \frac{1}{e^{-\rho(z, T)(\delta - k_{\max})}} \lesssim \left(e^{T(1-\theta)}\right)^{\delta} e^{(1-\varepsilon)T(1-\theta)(\delta - k_{\max})} \\ &= \left(e^{T(1-\theta)}\right)^{2\delta - k_{\max} - \varepsilon(\delta - k_{\max})} \end{aligned}$$

which proves $\dim_{\mathbb{L}}^{\theta} \mu \leq 2\delta - k_{\max} - \varepsilon(\delta - k_{\max})$ and letting $\varepsilon \rightarrow 0$ proves the upper bound.

Recall that $\dim_{\mathbb{L}} \mu = \min\{2\delta - k_{\max}, k_{\min}\}$, so when $\delta \leq (k_{\min} + k_{\max})/2$, we have

$$2\delta - k_{\max} = \dim_{\mathbb{L}} \mu \leq \dim_{\mathbb{L}}^{\theta} \mu \leq 2\delta - k_{\max}$$

so $\dim_{\mathbb{L}}^{\theta} \mu = 2\delta - k_{\max}$, as required.

4.5 The Assouad spectrum of $L(\Gamma)$

4.5.1 When $\delta \leq k_{\min}$

- We show $\dim_{\mathbb{A}}^{\theta} L(\Gamma) = \delta + \min\left\{1, \frac{\theta}{1-\theta}\right\} (k_{\max} - \delta)$.

As

$$\dim_{\mathbb{A}}^{\theta} L(\Gamma) \leq \dim_{\mathbb{A}}^{\theta} \mu = \delta + \min\left\{1, \frac{\theta}{1-\theta}\right\} (k_{\max} - \delta) \quad (4.10)$$

when $\delta \leq k_{\min}$, we need only prove the lower bound. To obtain this, we make use of the following result (see [22, Theorem 3.4.8]).

Proposition 4.7. *Let $F \subseteq \mathbb{R}^n$ and suppose that $\rho = \inf \{\theta \in (0, 1) \mid \dim_{\mathbb{A}}^{\theta} F = \dim_{\mathbb{A}} F\}$ exists and $\rho \in (0, 1)$ and $\dim_{\mathbb{L}} F = \overline{\dim}_{\mathbb{B}} F$. Then for $\theta \in (0, \rho)$,*

$$\dim_{\mathbb{A}}^{\theta} F \geq \overline{\dim}_{\mathbb{B}} F + \frac{(1-\rho)\theta}{(1-\theta)\rho} (\dim_{\mathbb{A}} F - \overline{\dim}_{\mathbb{B}} F).$$

We note that if $\delta \leq k_{\min}$, then certainly

$$\dim_{\mathbb{L}} L(\Gamma) = \min\{k_{\min}, \delta\} = \delta = \overline{\dim}_{\mathbb{B}} L(\Gamma).$$

We now show that $\rho = 1/2$. By (4.10), we have $\rho \geq 1/2$, so we need only show that $\rho \leq 1/2$. To do this, we recall a result from [21], which states that using the orbit of a free abelian subgroup of the stabiliser of some parabolic fixed point p with $k(p) = k_{\max}$, we can find a bi-Lipschitz image of an inverted $\mathbb{Z}^{k_{\max}}$ lattice inside $L(\Gamma)$ in \mathbb{S}^d , which gives us

$$\dim_{\mathbb{A}}^{\theta} L(\Gamma) \geq \dim_{\mathbb{A}}^{\theta} \frac{1}{\mathbb{Z}^{k_{\max}}} = \min \left\{ k_{\max}, \frac{k_{\max}}{2(1-\theta)} \right\} \quad (4.11)$$

with the equality coming from [25, Prop 4.5, Cor 6.4]. This proves $\rho \leq 1/2$, as required. Therefore, by Proposition 4.7, we have for $\theta \in (0, 1/2)$

$$\dim_{\mathbb{A}}^{\theta} L(\Gamma) \geq \overline{\dim}_{\mathbb{B}} L(\Gamma) + \frac{(1-\rho)\theta}{(1-\theta)\rho} (\dim_{\mathbb{A}} L(\Gamma) - \overline{\dim}_{\mathbb{B}} L(\Gamma)) = \delta + \frac{\theta}{1-\theta} (k_{\max} - \delta)$$

as required.

4.5.2 When $k_{\min} < \delta < k_{\max}$

- *Upper bound:* We show $\dim_{\mathbb{A}}^{\theta} L(\Gamma) \leq \delta + \min \left\{ 1, \frac{\theta}{1-\theta} \right\} (k_{\max} - \delta)$.

The argument for the upper bound for the Assouad spectrum is nearly identical to the argument for the upper bound for the Assouad dimension given in [21], and so we omit any part of the argument which does not improve upon the bounds provided in the paper, in particular when the Assouad dimension is bounded above by δ . We also note that

$$\dim_{\mathbb{A}}^{\theta} L(\Gamma) \leq \dim_{\mathbb{A}} L(\Gamma) = k_{\max}$$

so we may assume that $\theta \in (0, 1/2)$. Let $z \in L(\Gamma)$, $\varepsilon > 0$, and T be sufficiently large such that $T(1-\theta) \geq \max\{\varepsilon^{-1}, \log 10\}$. Let $\{x_i\}_{i \in X}$ be a centred e^{-T} -packing of $B(z, e^{-T\theta}) \cap L(\Gamma)$ of maximal cardinality, in other words $x_i \in B(z, e^{-T\theta}) \cap L(\Gamma)$ for all $i \in X$ and $|x_i - x_j| > 2e^{-T}$ for $i \neq j$. Decompose X as follows

$$X = X_0 + X_1 + \bigcup_{n=2}^{\infty} X_n$$

where

$$\begin{aligned} X_0 &= \{i \in X \mid (x_i)_T \in H_p \text{ with } |H_p| \geq 10e^{-T\theta}\} \\ X_1 &= \{i \in X \setminus X_0 \mid \rho(x_i, T) \leq \varepsilon T(1-\theta)\} \\ X_n &= \{i \in X \setminus (X_0 \cup X_1) \mid n-1 < \rho(x_i, T) \leq n\}. \end{aligned}$$

Our goal is to bound from above the cardinalities of X_0 , X_1 and X_n separately.

We start with X_0 , which we may assume is non-empty as we are trying to bound from above. We note that if there exists some $p \in P$ with $|H_p| \geq 10e^{-T\theta}$ and $H_p \cap (\cup_{i \in X} (x_i)_T) \neq \emptyset$, then this p must be unique, i.e. if $H_p \cap (\cup_{i \in X} (x_i)_T) \neq \emptyset$ and $H_{p'} \cap (\cup_{i \in X} (x_i)_T) \neq \emptyset$ for some $p, p' \in P$ with $|H_p|, |H_{p'}| \geq 10e^{-T\theta}$, then H_p and $H_{p'}$ could not be disjoint. This means we can choose $p \in P$ such that $(x_i)_T \in H_p$ for all $i \in X_0$, and also note that this forces $z_{T\theta} \in H_p$.

If $\delta \leq k(p)$, then by Theorem 2.2

$$\begin{aligned} e^{-T\theta\delta} e^{-\rho(z, T\theta)(\delta-k(p))} &\gtrsim \mu(B(z, e^{-T\theta})) \geq \mu(\cup_{i \in X_0} B(x_i, e^{-T})) \\ &\gtrsim |X_0| \min_{i \in X_0} (e^{-T})^\delta e^{-\rho(x_i, T)(\delta-k(p))} \end{aligned}$$

where the second inequality follows from the fact that $\{x_i\}_{i \in X_0}$ is an e^{-T} packing. Therefore

$$\begin{aligned} |X_0| &\lesssim \max_{i \in X_0} \left(e^{T(1-\theta)} \right)^\delta e^{(\rho(x_i, T) - \rho(z, T\theta))(\delta-k(p))} \leq \left(e^{T(1-\theta)} \right)^\delta e^{-T\theta(\delta-k_{\max})} \\ &= \left(e^{T(1-\theta)} \right)^{\delta + \frac{\theta}{1-\theta}(k_{\max}-\delta)}. \end{aligned} \quad (4.12)$$

Note that Fraser [21] estimates using $\rho(x_i, T) - \rho(z, t) \leq T - t + 10$, but we can improve this for $t = T\theta$ with $\theta < 1/2$ by using $\rho(x_i, T) \geq 0$ and $\rho(z, T\theta) \leq T\theta$.

If $\delta > k(p)$, then we refer the reader to [21, 4998-5000], where it is shown that

$$|X_0| \lesssim \left(e^{T(1-\theta)} \right)^\delta.$$

Therefore, we have

$$|X_0| \lesssim \left(e^{T(1-\theta)} \right)^{\delta + \frac{\theta}{1-\theta}(k_{\max}-\delta)}$$

regardless of the relationship between δ and $k(p)$.

For X_1 , we have

$$\begin{aligned} e^{-T\theta\delta} e^{-\rho(z, T\theta)(\delta-k(z, T\theta))} &\gtrsim \mu(B(z, e^{-T\theta})) \geq \mu(\cup_{i \in X_1} B(x_i, e^{-T})) \\ &\gtrsim \sum_{i \in X_1} (e^{-T})^\delta e^{-\rho(x_i, T)(\delta-k(x_i, T))} \\ &\geq |X_1| (e^{-T})^\delta e^{-\varepsilon T(1-\theta)(\delta-k_{\min})} \end{aligned}$$

by the definition of X_1 and the fact that $\delta > k_{\min}$. Therefore

$$\begin{aligned} |X_1| &\lesssim \left(e^{T(1-\theta)} \right)^\delta e^{\varepsilon T(1-\theta)(\delta-k_{\min}) - \rho(z, T\theta)(\delta-k(z, T\theta))} \\ &\leq \left(e^{T(1-\theta)} \right)^\delta e^{\varepsilon T(1-\theta)(\delta-k_{\min}) - T\theta(\delta-k_{\max})} \\ &= \left(e^{T(1-\theta)} \right)^{\delta + \frac{\theta}{1-\theta}(k_{\max}-\delta) + \varepsilon(\delta-k_{\min})}. \end{aligned} \quad (4.13)$$

Finally, we consider the sets X_n . If $i \in X_n$ for $n \geq 2$, then $\rho(x_i, T) > n - 1$, and so $(x_i)_T \in H_p$ for some $p \in P$ with $e^{-T} \leq |H_p| < 10e^{-T\theta}$. Furthermore, we may note that $B(x_i, e^{-T})$ is contained in the shadow at infinity of the squeezed horoball $2e^{-(n-1)}H_p$. Also note that as $|H_p| < 10e^{-T\theta}$, we have $p \in B(z, 10e^{-T\theta})$. For each integer $k \in [k_{\min}, k_{\max}]$ define

$$X_n^k = \{i \in X_n \mid k(x_i, T) = k\}.$$

Then

$$\begin{aligned} \mu \left(\bigcup_{i \in X_n^k} B(x_i, e^{-T}) \right) &\leq \mu \left(\bigcup_{\substack{p \in P \cap B(z, 10e^{-T\theta}) \\ 10e^{-T\theta} > |H_p| \geq e^{-T} \\ k(p) = k}} \Pi(2e^{-(n-1)}H_p) \right) \\ &\lesssim \sum_{\substack{p \in P \cap B(z, 10e^{-T\theta}) \\ 10e^{-T\theta} > |H_p| \geq e^{-T} \\ k(p) = k}} \mu(\Pi(2e^{-(n-1)}H_p)) \\ &\lesssim e^{-n(2\delta-k)} \sum_{\substack{p \in P \cap B(z, 10e^{-T\theta}) \\ 10e^{-T\theta} > |H_p| \geq e^{-T}}} |H_p|^\delta \quad \text{by Lemma 4.5} \\ &\lesssim e^{-n(2\delta-k)} (T(1-\theta) + \log 10) \mu(B(z, e^{-T\theta})) \quad \text{by Lemma 4.6} \\ &\lesssim e^{-n(2\delta-k)} T(1-\theta) e^{-T\theta\delta} e^{-\rho(z, T\theta)(\delta-k(z, T\theta))} \quad \text{by Theorem 2.2} \\ &\lesssim e^{-n(2\delta-k)} \varepsilon^{-1} n e^{-T\theta\delta} e^{T\theta(k_{\max}-\delta)} \end{aligned}$$

where the last inequality uses the fact that $\varepsilon T(1-\theta) < \rho(x_i, T) \leq n$ as $i \notin X_1$. On the other hand, using the fact that $\{x_i\}_{i \in X_n^k}$ is an e^{-T} packing,

$$\mu \left(\bigcup_{i \in X_n^k} B(x_i, e^{-T}) \right) \geq \sum_{i \in X_n^k} \mu(B(x_i, e^{-T})) \gtrsim |X_n^k| e^{-T\delta} e^{-n(\delta-k)}$$

using $n-1 < \rho(x_i, T) \leq n$. Therefore

$$|X_n^k| \lesssim \varepsilon^{-1} n e^{-n\delta} \left(e^{T(1-\theta)} \right)^\delta e^{T\theta(k_{\max}-\delta)} = \varepsilon^{-1} n e^{-n\delta} \left(e^{T(1-\theta)} \right)^{\delta + \frac{\theta}{1-\theta}(k_{\max}-\delta)}$$

which implies

$$|X_n| = \sum_{k=k_{\min}}^{k_{\max}} |X_n^k| \lesssim \varepsilon^{-1} n e^{-n\delta} \left(e^{T(1-\theta)} \right)^{\delta + \frac{\theta}{1-\theta}(k_{\max}-\delta)}. \quad (4.14)$$

Combining (4.12), (4.13) and (4.14), we have

$$\begin{aligned} |X| &= |X_0| + |X_1| + \sum_{n=2}^{\infty} |X_n| \\ &\lesssim \left(e^{T(1-\theta)} \right)^{\delta + \frac{\theta}{1-\theta}(k_{\max}-\delta) + \varepsilon(\delta-k_{\min})} + \sum_{n=2}^{\infty} \varepsilon^{-1} n e^{-n\delta} \left(e^{T(1-\theta)} \right)^{\delta + \frac{\theta}{1-\theta}(k_{\max}-\delta)} \\ &\lesssim \left(e^{T(1-\theta)} \right)^{\delta + \frac{\theta}{1-\theta}(k_{\max}-\delta) + \varepsilon(\delta-k_{\min})} + \varepsilon^{-1} \left(e^{T(1-\theta)} \right)^{\delta + \frac{\theta}{1-\theta}(k_{\max}-\delta)} \end{aligned}$$

which proves

$$\dim_{\mathbb{A}}^{\theta} L(\Gamma) \leq \delta + \frac{\theta}{1-\theta} (k_{\max} - \delta) + \varepsilon(\delta - k_{\min})$$

and letting $\varepsilon \rightarrow 0$ proves the desired upper bound.

• *Lower bound:* We show $\dim_{\mathbb{A}}^{\theta} L(\Gamma) \geq \delta + \min \left\{ 1, \frac{\theta}{1-\theta} \right\} (k_{\max} - \delta)$.

Note that the case when $\theta \geq 1/2$ is an immediate consequence of (4.11), so we assume that $\theta \in (0, 1/2)$. In order to derive the lower bound, we let $p \in L(\Gamma)$ be a parabolic fixed point with $k(p) = k_{\max}$, then we switch to the upper half-space model \mathbb{H}^{d+1} and assume that $p = \infty$. Recalling the argument from [21, Section 5.1.1], we know that there exists some subset of $L(\Gamma)$ which is bi-Lipschitz equivalent to $\mathbb{Z}^{k_{\max}}$. Therefore, we may assume that we have a $\mathbb{Z}^{k_{\max}}$ lattice, denoted by Z , as a subset of $L(\Gamma)$, and then use the fact that the Assouad spectrum is stable under bi-Lipschitz maps.

We now partition this lattice into $\{Z_k\}_{k \in \mathbb{N}}$, where

$$Z_k = \{z \in Z \mid 10(k-1) \leq |z| < 10k\}.$$

We note that

$$|Z_k| \approx k^{k_{\max}-1}. \quad (4.15)$$

Let $\phi : \mathbb{H}^{d+1} \rightarrow \mathbb{D}^{d+1}$ denote the Cayley transformation mapping the upper half space model to the Poincaré ball model, and consider the family of balls $\{B(z, 1/3)\}_{z \in Z}$. Taking the ϕ -image of Z yields an inverted lattice and there are positive constants C_1 and C_2 such that if $z \in Z_k$ for some k , then

$$\frac{1}{C_1 k} \leq |\phi(z) - p_1| \leq \frac{C_1}{k} \quad \text{and} \quad \frac{1}{C_2 k^2} \leq |\phi(B(z, 1/3))| \leq \frac{C_2}{k^2},$$

where $p_1 = \phi(\infty)$.

Let $T > 0$. We now choose a constant C_3 small enough which satisfies the following:

- The set of balls $\bigcup_{k \in \mathbb{N}} \bigcup_{z \in Z_k} (B(\phi(z), C_3/k^2))$ are pairwise disjoint.
- If $z \in Z_k$ and $|\phi(z) - p_1| < e^{-T\theta}$, then $B(\phi(z), C_3/k^2) \subset B(p_1, 2e^{-T\theta})$.

This gives us

$$N_{e^{-T}}(B(p_1, 2e^{-T\theta}) \cap L(\Gamma)) \gtrsim \sum_{\substack{z \in Z_k \\ C_3/k^2 > e^{-T} \\ |\phi(z) - p_1| < e^{-T\theta}}} N_{e^{-T}}(B(\phi(z), C_3/k^2) \cap L(\Gamma)). \quad (4.16)$$

We wish to estimate $N_{e^{-T}}(B(\phi(z), C_3/k^2) \cap L(\Gamma))$ from below. Let $k \in \mathbb{N}$ satisfy the conditions given in the sum above, and write $t = \log(k^2/C_3)$, and let $\varepsilon \in (0, 1)$. We will restrict the above sum to ensure that $T - t \geq \max\{\varepsilon^{-1}, \log 10\}$, that is, we assume further that $k \leq a(\varepsilon)e^{T/2}\sqrt{C_3}$ where $a(\varepsilon) = \sqrt{\exp(-\max\{\varepsilon^{-1}, \log 10\})}$.

Let $\{y_i\}_{i \in Y}$ be a centred e^{-T} covering of $B(\phi(z), e^{-t}) \cap L(\Gamma)$, and decompose Y as $Y = Y_0 \cup Y_1$ where

$$\begin{aligned} Y_0 &= \{i \in Y \mid (y_i)_T \in H_p \text{ with } |H_p| \geq 10e^{-t}\} \\ Y_1 &= Y \setminus Y_0. \end{aligned}$$

We wish to estimate the cardinalities of Y_0 and Y_1 , and we refer the reader to [21, Section 5.2] for the details regarding the estimates used.

If $i \in Y_0$, then $(y_i)_T \in H_p$ for some unique parabolic fixed point p with $|H_p| \geq 10e^{-t}$. If $\delta < k(p)$, it can be shown that

$$|Y_0| \gtrsim \left(\frac{e^{-t}}{e^{-T}} \right)^\delta$$

and if $\delta \geq k(p)$ then

$$|Y_0| \gtrsim \left(\frac{e^{-t}}{e^{-T}} \right)^\delta \min_{i \in Y_0} e^{(\rho(y_i, T) - \rho(\phi(z), t))(\delta - k(p))} \gtrsim \left(\frac{e^{-t}}{e^{-T}} \right)^\delta e^{-\rho(\phi(z), t)(\delta - k(p))}. \quad (4.17)$$

In order to estimate $\rho(\phi(z), t)$, we ensure that T is chosen large enough such that the line joining $\mathbf{0}$ and $\phi(z)$ intersects H_{p_1} , and let $u > 0$ be the larger of two values such that $\phi(z)_u$ lies on the boundary of H_{p_1} (see Figure 15). Then note that

$$|\phi(z) - \phi(z)_t| \approx e^{-t} = C_3/k^2$$

and also that since $|\phi(z) - p_1| \approx \frac{1}{k}$, Lemma 4.1 gives $|\phi(z) - \phi(z)_u| \approx 1/k^2$.

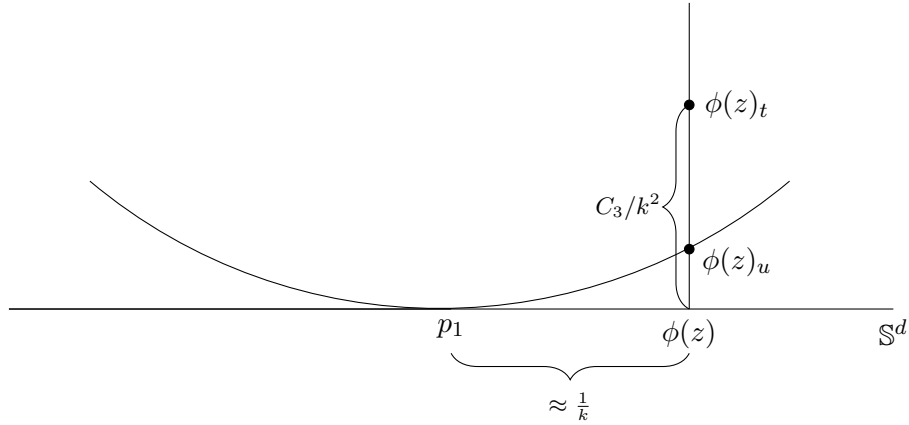

Figure 15: Estimating $\rho(\phi(z), t)$ when $t < u$ using Lemma 4.1.

Therefore, we have

$$\rho(\phi(z), t) \leq \log \frac{|\phi(z) - \phi(z)_t|}{|\phi(z) - \phi(z)_u|} \leq C_4$$

for some constant C_4 . Therefore, by (4.17)

$$|Y_0| \gtrsim \left(\frac{e^{-t}}{e^{-T}} \right)^\delta e^{-C_4(\delta - k_{\min})} \approx \left(\frac{e^{-t}}{e^{-T}} \right)^\delta.$$

Similarly, we can show that

$$|Y_1| \gtrsim \left(\frac{e^{-t}}{e^{-T}} \right)^{\delta + \varepsilon(\delta - k_{\max})} e^{-\rho(\phi(z), t)(\delta - k_{\min})} \gtrsim \left(\frac{e^{-t}}{e^{-T}} \right)^{\delta + \varepsilon(\delta - k_{\max})}.$$

Therefore, we have

$$N_{e^{-T}}(B(\phi(z), e^{-t}) \cap L(\Gamma)) \gtrsim \left(\frac{e^{-t}}{e^{-T}} \right)^{\delta + \varepsilon(\delta - k_{\max})} = \left(\frac{C_3/k^2}{e^{-T}} \right)^{\delta + \varepsilon(\delta - k_{\max})}$$

and so by (4.16)

$$\begin{aligned} N_{e^{-T}}(B(p_1, 2e^{-T\theta}) \cap L(\Gamma)) &\gtrsim \sum_{\substack{z \in Z_k \\ C_3/k^2 > e^{-T} \\ |\phi(z) - p_1| < e^{-T\theta}}} \left(\frac{C_3/k^2}{e^{-T}} \right)^{\delta + \varepsilon(\delta - k_{\max})} \\ &\geq e^{T(\delta + \varepsilon(\delta - k_{\max}))} \sum_{k = \lceil e^{T\theta}/C_1 \rceil}^{\lfloor a(\varepsilon)\sqrt{C_3}e^{T/2} \rfloor} |Z_k| (C_3/k^2)^{\delta + \varepsilon(\delta - k_{\max})} \\ &\gtrsim e^{T(\delta + \varepsilon(\delta - k_{\max}))} \sum_{k = \lceil e^{T\theta}/C_1 \rceil}^{\lfloor a(\varepsilon)\sqrt{C_3}e^{T/2} \rfloor} k^{k_{\max} - 1 - 2\delta - 2\varepsilon(\delta - k_{\max})} \quad \text{by (4.15)} \\ &\gtrsim e^{T(\delta + \varepsilon(\delta - k_{\max}))} \int_{e^{T\theta}/C_1}^{a(\varepsilon)\sqrt{C_3}e^{T/2}} x^{k_{\max} - 1 - 2\delta - 2\varepsilon(\delta - k_{\max})} dx. \end{aligned}$$

We may assume ε is chosen small enough to ensure that $k_{\max} - 2\delta - 2\varepsilon(\delta - k_{\max}) < 0$ and that T is large enough (depending on ε) such that $a(\varepsilon)\sqrt{C_3}e^{T/2} > e^{T\theta}/C_1$. Then the smaller limit of integration provides the dominant term, so we have

$$\begin{aligned} N_{e^{-T}}(B(p_1, 2e^{-T\theta}) \cap L(\Gamma)) &\gtrsim e^{T(\delta + \varepsilon(\delta - k_{\max}))} e^{T\theta(k_{\max} - 2\delta - 2\varepsilon(\delta - k_{\max}))} \\ &= \left(e^{T(1-\theta)} \right)^{\delta + \frac{\theta}{1-\theta}(k_{\max} - \delta) + \varepsilon(\delta - k_{\max})} e^{-T\theta\varepsilon(\delta - k_{\max})} \\ &\geq \left(e^{T(1-\theta)} \right)^{\delta + \frac{\theta}{1-\theta}(k_{\max} - \delta) + \varepsilon(\delta - k_{\max})} \end{aligned}$$

which proves

$$\dim_{\mathbb{A}}^{\theta} L(\Gamma) \geq \delta + \frac{\theta}{1-\theta}(k_{\max} - \delta) + \varepsilon(\delta - k_{\max})$$

and letting $\varepsilon \rightarrow 0$ proves the lower bound.

4.5.3 When $\delta \geq k_{\max}$

- We show $\dim_{\mathbb{A}}^{\theta} L(\Gamma) = \delta$.

This follows easily, since when $\delta \geq k_{\max}$, we have $\delta = \overline{\dim}_{\mathbb{B}} L(\Gamma) \leq \dim_{\mathbb{A}}^{\theta} L(\Gamma) \leq \dim_{\mathbb{A}} L(\Gamma) = \delta$ and so $\dim_{\mathbb{A}}^{\theta} L(\Gamma) = \delta$, as required.

4.6 The lower spectrum of $L(\Gamma)$

4.6.1 When $\delta \leq k_{\min}$

- We show $\dim_{\mathbb{L}}^{\theta} L(\Gamma) = \delta$.

When $\delta \leq k_{\min}$, we have $\delta = \dim_{\mathbb{L}} L(\Gamma) \leq \dim_{\mathbb{L}}^{\theta} L(\Gamma) \leq \underline{\dim}_{\mathbb{B}} L(\Gamma) = \delta$ and so $\dim_{\mathbb{L}}^{\theta} L(\Gamma) = \delta$, as required.

4.6.2 When $k_{\min} < \delta < k_{\max}$

- *Lower bound:* We show $\dim_{\mathbb{L}}^{\theta} L(\Gamma) \geq \delta - \min\left\{1, \frac{\theta}{1-\theta}\right\}(\delta - k_{\min})$.

Similarly to the upper bound for the Assouad spectrum of $L(\Gamma)$, the argument is essentially identical to the one given in [21] for the lower bound for the lower dimension, and so we only include parts of the argument which improve upon the bounds derived in that paper, and we may assume that $\theta \in (0, 1/2)$.

Let $z \in L(\Gamma)$, $\varepsilon \in (0, 1)$, and $T > 0$ with $T(1-\theta) \geq \max\{\varepsilon^{-1}, \log 10\}$. Let $\{y_i\}_{i \in Y}$ be a centred e^{-T} -covering of $B(z, e^{-T\theta}) \cap L(\Gamma)$ of minimal cardinality. Decompose Y as $Y = Y_0 \cup Y_1$ where

$$\begin{aligned} Y_0 &= \{i \in Y \mid (y_i)_T \in H_p \text{ with } |H_p| \geq 10e^{-T\theta}\} \\ Y_1 &= Y \setminus Y_0. \end{aligned}$$

As $\{y_i\}_{i \in Y}$ is a centred e^{-T} -covering of $B(z, e^{-T\theta}) \cap L(\Gamma)$, we have

$$\begin{aligned} \mu(B(z, e^{-T\theta})) &\leq \mu(\cup_{i \in Y} B(y_i, e^{-T})) \\ &\leq \mu(\cup_{i \in Y_0} B(y_i, e^{-T})) + \mu(\cup_{i \in Y_1} B(y_i, e^{-T})) \end{aligned} \quad (4.18)$$

so one of the terms in (4.18) must be at least $\mu(B(z, e^{-T\theta}))/2$.

Suppose that

$$\mu(\cup_{i \in Y_0} B(y_i, e^{-T})) \geq \mu(B(z, e^{-T\theta}))/2.$$

This means that $|Y_0| \neq \emptyset$, and so similar to the Assouad spectrum argument, we can show that there exists a unique $p \in P$ with $|H_p| \geq 10e^{-T\theta}$ such that $(y_i)_T \in H_p$ for all $i \in Y_0$. Moreover, this forces $z_{T\theta} \in H_p$.

If $\delta \geq k(p)$, then

$$\begin{aligned} e^{-T\theta\delta} e^{-\rho(z, T\theta)(\delta - k(p))} &\lesssim \mu(B(z, e^{-T\theta})) \leq 2\mu(\cup_{i \in Y_0} B(y_i, e^{-T})) \quad (\text{by assumption}) \\ &\lesssim |Y_0| \max_{i \in Y_0} e^{-T\delta} e^{-\rho(y_i, T)(\delta - k(p))} \end{aligned}$$

so we have

$$|Y_0| \gtrsim \left(e^{T(1-\theta)}\right)^{\delta} \min_{i \in Y_0} e^{(\rho(y_i, T) - \rho(z, T\theta))(\delta - k(p))} \gtrsim \left(e^{T(1-\theta)}\right)^{\delta} e^{-T\theta(\delta - k_{\min})} = \left(e^{T(1-\theta)}\right)^{\delta - \frac{\theta}{1-\theta}(\delta - k_{\min})}.$$

If $\delta < k(p)$, we refer the reader to [21, 5003-5005] where it is shown that

$$|Y_0| \gtrsim \left(e^{T(1-\theta)}\right)^{\delta}.$$

Therefore

$$|Y_0| \gtrsim \left(e^{T(1-\theta)} \right)^{\delta - \frac{\theta}{1-\theta}(\delta - k_{\min})} \quad (4.19)$$

regardless of the relationship between δ and $k(p)$. Now, suppose that

$$\mu \left(\cup_{i \in Y_1} B(y_i, e^{-T}) \right) \geq \mu(B(z, e^{-T\theta}))/2.$$

Define

$$Y_1^0 = \{i \in Y_1 \mid \rho(y_i, T) \leq \varepsilon T(1 - \theta)\}$$

and suppose $i \in Y_1 \setminus Y_1^0$. Then $\rho(y_i, T) > \varepsilon T(1 - \theta)$ and so similar to the X_n case in the Assouad spectrum argument, we know that $(y_i)_T$ is contained in the squeezed horoball $e^{-\varepsilon T(1-\theta)} H_p$ with $e^{-T} \leq |H_p| < 10e^{-T\theta}$ for some $p \in P$ with $p \in B(z, 10e^{-T\theta})$.

We also note that the Euclidean distance from $(y_i)_T$ to \mathbb{S}^d is comparable to e^{-T} , and so by Pythagoras' Theorem, see Figure 16, we have

$$|y_i - p| \lesssim \sqrt{(e^{-\varepsilon T(1-\theta)}|H_p|)^2 - (e^{-\varepsilon T(1-\theta)}|H_p| - e^{-T})^2} \lesssim \sqrt{e^{-\varepsilon T(1-\theta)}|H_p|e^{-T}}.$$

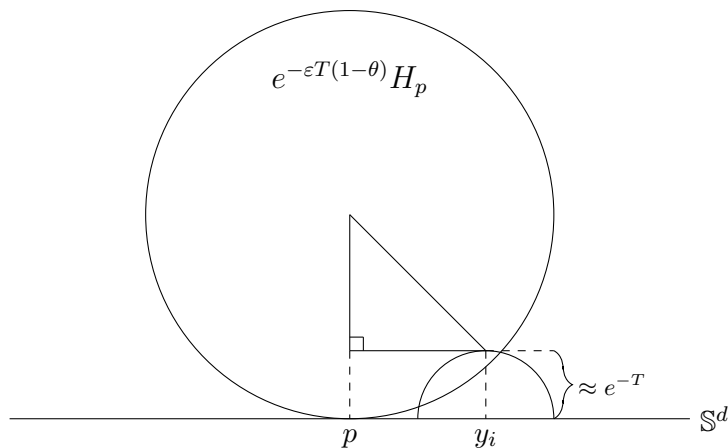

Figure 16: Applying Pythagoras' Theorem using $(y_i)_T$, p_T and the centre of $e^{-\varepsilon T(1-\theta)} H_p$.

Therefore, we have that $B(y_i, e^{-T})$ is contained in the shadow at infinity of the squeezed horoball

$$C \sqrt{\frac{e^{-\varepsilon T(1-\theta)-T}}{|H_p|}} H_p$$

for some constant C . This implies

$$\begin{aligned}
\mu\left(\cup_{i \in Y_1 \setminus Y_1^0} B(y_i, e^{-T})\right) &\leq \sum_{\substack{p \in P \cap B(z, 10e^{-T\theta}) \\ 10e^{-T\theta} > |H_p| \geq e^{-T}}} \mu\left(\Pi\left(C\sqrt{\frac{e^{-\varepsilon T(1-\theta)} - T}{|H_p|}} H_p\right)\right) \\
&\approx \sum_{\substack{p \in P \cap B(z, 10e^{-T\theta}) \\ 10e^{-T\theta} > |H_p| \geq e^{-T}}} \left(\sqrt{\frac{e^{-\varepsilon T(1-\theta)} - T}{|H_p|}}\right)^{2\delta - k(p)} |H_p|^\delta \quad \text{by Lemma 4.5} \\
&\leq e^{-\varepsilon T(1-\theta)(\delta - k_{\max}/2)} \sum_{\substack{p \in P \cap B(z, 10e^{-T\theta}) \\ 10e^{-T\theta} > |H_p| \geq e^{-T}}} \left(\sqrt{\frac{e^{-T}}{|H_p|}}\right)^{2\delta - k(p)} |H_p|^\delta \\
&\leq e^{-\varepsilon T(1-\theta)(\delta - k_{\max}/2)} \sum_{\substack{p \in P \cap B(z, 10e^{-T\theta}) \\ 10e^{-T\theta} > |H_p| \geq e^{-T}}} |H_p|^\delta \\
&\lesssim e^{-\varepsilon T(1-\theta)(\delta - k_{\max}/2)} (T(1-\theta) + \log 10) \mu(B(z, e^{-T\theta})) \quad \text{by Lemma 4.6.}
\end{aligned}$$

As $\delta > k_{\max}/2$, this means that balls with centres in $Y_1 \setminus Y_1^0$ cannot carry a fixed proportion of $\mu(B(z, e^{-T\theta}))$ for sufficiently large T . It follows that

$$\mu\left(\cup_{i \in Y_1^0} B(y_i, e^{-T})\right) \approx \mu\left(\cup_{i \in Y_1} B(y_i, e^{-T})\right) \geq \mu(B(z, e^{-T\theta}))/2$$

by our assumption. This means that

$$\begin{aligned}
e^{-T\theta\delta} e^{-\rho(z, T\theta)(\delta - k(z, T\theta))} &\lesssim \mu(B(z, e^{-T\theta})) \leq \mu(\cup_{i \in Y_1^0} B(y_i, e^{-T})) \\
&\lesssim \sum_{i \in Y_1^0} (e^{-T})^\delta e^{-\rho(y_i, T)(\delta - k(y_i, T))} \\
&\leq |Y_1^0| (e^{-T})^\delta e^{\varepsilon T(1-\theta)(k_{\max} - \delta)}
\end{aligned}$$

using $\rho(y_i, T) \leq \varepsilon T(1-\theta)$ for $i \in Y_1^0$ and $\delta < k_{\max}$. Therefore

$$\begin{aligned}
|Y_1| &\geq |Y_1^0| \gtrsim \left(e^{T(1-\theta)}\right)^\delta e^{\varepsilon T(1-\theta)(\delta - k_{\max})} e^{-T\theta(\delta - k_{\min})} \\
&= \left(e^{T(1-\theta)}\right)^{\delta - \frac{\theta}{1-\theta}(\delta - k_{\min}) + \varepsilon(\delta - k_{\max})}. \tag{4.20}
\end{aligned}$$

At least one of (4.19) and (4.20) must hold, so we have

$$|Y| \geq |Y_0| + |Y_1| \gtrsim \left(e^{T(1-\theta)}\right)^{\delta - \frac{\theta}{1-\theta}(\delta - k_{\min}) + \varepsilon(\delta - k_{\max})}$$

which proves

$$\dim_L^\theta L(\Gamma) \geq \delta - \frac{\theta}{1-\theta}(\delta - k_{\min}) + \varepsilon(\delta - k_{\max})$$

and letting $\varepsilon \rightarrow 0$ proves the desired lower bound.

- *Upper bound:* We show $\dim_{\mathbb{L}}^{\theta} L(\Gamma) \leq \delta - \min\left\{1, \frac{\theta}{1-\theta}\right\} (\delta - k_{\min})$.

In order to obtain the upper bound in this case, we require the following technical lemma due to Bowditch [10]. Switch to the upper half space model \mathbb{H}^{d+1} , and let $p \in P$ be a parabolic fixed point with rank k_{\min} . We may assume by conjugation that $p = \infty$. A consequence of geometric finiteness is that the limit set can be decomposed into the disjoint union of a set of conical limit points and a set of bounded parabolic fixed points (this result was proven in dimension 3 partially by Beardon and Maskit [6] and later refined by Bishop [7], and then generalised to higher dimensions by Bowditch [10]). In particular, $p = \infty$ is a bounded parabolic point, and applying [10, Definition, Page 272] gives the following lemma.

Lemma 4.8. *There exists $\lambda > 0$ and a k_{\min} -dimensional linear subspace $V \subseteq \mathbb{R}^d$ such that $L(\Gamma) \subseteq V_{\lambda} \cup \{\infty\}$, where $V_{\lambda} = \{x \in \mathbb{R}^d \mid \inf_{y \in V} \|x - y\| \leq \lambda\}$.*

Note that by Lemma 4.8, we immediately get $\dim_{\mathbb{L}}^{\theta} L(\Gamma) \leq k_{\min}$ for $\theta \geq 1/2$, so we may assume that $\theta \in (0, 1/2)$.

We proceed in a similar manner to the lower bound in Section 4.5.2. Let $p \in L(\Gamma)$ be a parabolic fixed point with $k(p) = k_{\min}$, and then switch to the upper half-space model \mathbb{H}^{d+1} , and assume that $p = \infty$. Similar to the lower bound in Section 4.5.2, we may assume that we have a $\mathbb{Z}^{k_{\min}}$ lattice as a subset of $L(\Gamma)$, which we denote by Z . We partition Z into $\{Z_k\}_{k \in \mathbb{N}}$, where

$$Z_k = \{z \in Z \mid 10(k-1) \leq |z| < 10k\}$$

noting that

$$|Z_k| \approx k^{k_{\min}-1}. \quad (4.21)$$

We let ϕ denote the Cayley transformation mapping the upper half space model to the Poincaré ball model. Then, as before, there are positive constants C_1 and C_2 such that if $z \in Z_k$ for some k , then

$$\frac{1}{C_1 k} \leq |\phi(z) - p_1| \leq \frac{C_1}{k} \quad \text{and} \quad \frac{1}{C_2 k^2} \leq |\phi(B(z, 1/3))| \leq \frac{C_2}{k^2},$$

where $p_1 = \phi(\infty)$. We let $T > 0$, and then by Lemma 4.8, we may choose a constant C_3 such that

$$B(p_1, e^{-T\theta}) \subseteq \bigcup_{\substack{z \in Z_k \\ C_3/k^2 > e^{-T} \\ |\phi(z) - p_1| < e^{-T\theta}}} B(\phi(z), C_3/k^2).$$

Then we have

$$M_{e^{-T}}(B(p_1, e^{-T\theta}) \cap L(\Gamma)) \lesssim \sum_{\substack{z \in Z_k \\ C_3/k^2 > e^{-T} \\ |\phi(z) - p_1| < e^{-T\theta}}} M_{e^{-T}}(B(\phi(z), C_3/k^2) \cap L(\Gamma)). \quad (4.22)$$

We wish to estimate $M_{e^{-T}}(B(\phi(z), C_3/k^2) \cap L(\Gamma))$ from above.

Let $k \in \mathbb{N}$ satisfy the conditions above, let $\varepsilon \in (0, 1)$, write $t = \log(k^2/C_3)$. Write K to denote the set of k such that $T - t \leq \max\{\varepsilon^{-1}, \log 10\}$. Then note that

$$\frac{e^{-t}}{e^{-T}} \lesssim 1$$

which gives

$$M_{e^{-T}}(B(\phi(z), C_3/k^2) \cap L(\Gamma)) \lesssim 1.$$

Furthermore, using the fact that $C_3/k^2 > e^{-T}$ and the fact that we are summing in k_{\min} directions, we have

$$|K| \lesssim e^{\frac{Tk_{\min}}{2}} \leq e^{T(1-\theta)k_{\min}} \leq e^{T(1-\theta)\delta}.$$

We now assume that $T - t \geq \max\{\varepsilon^{-1}, \log 10\}$.

We let $\{x_i\}_{i \in X}$ denote a centred e^{-T} -packing of $B(\phi(z), e^{-t}) \cap L(\Gamma)$ of maximal cardinality, and decompose X as

$$X = X_0 \cup X_1 \cup \sum_{n=2}^{\infty} X_n$$

where

$$\begin{aligned} X_0 &= \{i \in X \mid (x_i)_T \in H_p \text{ with } |H_p| \geq 10e^{-t}\} \\ X_1 &= \{i \in X \setminus X_0 \mid \rho(x_i, T) \leq \varepsilon(T - t)\} \\ X_n &= \{i \in X \setminus (X_0 \cup X_1) \mid n - 1 < \rho(x_i, T) \leq n\}. \end{aligned}$$

For the details on estimating the cardinalities of X_0 , X_1 and X_n , we refer the reader to [21, Section 5.1].

Suppose that $i \in X_0$. Then $(x_i)_T \in H_p$ for some unique parabolic fixed point p with $|H_p| \geq 10e^{-t}$. If $\delta > k(p)$, then it can be shown that

$$|X_0| \lesssim \left(\frac{e^{-t}}{e^{-T}}\right)^\delta$$

and if $\delta \leq k(p)$, then it can be shown that

$$|X_0| \lesssim \left(\frac{e^{-t}}{e^{-T}}\right)^\delta \max_{i \in X_0} e^{(\rho(\phi(z), t) - \rho(x_i, T))(k(p) - \delta)} \lesssim \left(\frac{e^{-t}}{e^{-T}}\right)^\delta \max_{i \in X_0} e^{\rho(\phi(z), t)(k(p) - \delta)}.$$

In a similar manner to the lower bound in Section 4.5.2, we can show that

$$\rho(\phi(z), t) \leq C_4$$

for some constant C_4 . Therefore, we have

$$|X_0| \lesssim \left(\frac{e^{-t}}{e^{-T}}\right)^\delta e^{C_4(k_{\max} - \delta)} \lesssim \left(\frac{e^{-t}}{e^{-T}}\right)^\delta.$$

Similarly, for $i \in X_1$, we have

$$|X_1| \lesssim \left(\frac{e^{-t}}{e^{-T}}\right)^{\delta + \varepsilon(\delta - k_{\min})} e^{\rho(\phi(z), t)(k(p) - \delta)} \lesssim \left(\frac{e^{-t}}{e^{-T}}\right)^{\delta + \varepsilon(\delta - k_{\min})}$$

and if $i \in X_n$ for some $n \geq 2$, then we have

$$|X_n| \lesssim \varepsilon^{-1} n e^{-n\delta} \left(\frac{e^{-t}}{e^{-T}}\right)^\delta.$$

It follows that

$$\begin{aligned}
|X| &= |X_0| + |X_1| + \sum_{n=2}^{\infty} |X_n| \lesssim \left(\frac{e^{-t}}{e^{-T}}\right)^{\delta+\varepsilon(\delta-k_{\min})} + \sum_{n=2}^{\infty} \varepsilon^{-1} n e^{-n\delta} \left(\frac{e^{-t}}{e^{-T}}\right)^{\delta} \\
&\lesssim \left(\frac{e^{-t}}{e^{-T}}\right)^{\delta+\varepsilon(\delta-k_{\min})} + \varepsilon^{-1} \left(\frac{e^{-t}}{e^{-T}}\right)^{\delta} \\
&= \left(\frac{C_3/k^2}{e^{-T}}\right)^{\delta+\varepsilon(\delta-k_{\min})} + \varepsilon^{-1} \left(\frac{C_3/k^2}{e^{-T}}\right)^{\delta}
\end{aligned}$$

and so by (4.22),

$$\begin{aligned}
M_{e^{-T}}(B(p_1, e^{-T\theta}) \cap L(\Gamma)) &\lesssim \sum_{\substack{z \in Z_k \\ C_3/k^2 > e^{-T} \\ |\phi(z) - p_1| < e^{-T\theta}}} \left(\frac{C_3/k^2}{e^{-T}}\right)^{\delta+\varepsilon(\delta-k_{\min})} + \varepsilon^{-1} \left(\frac{C_3/k^2}{e^{-T}}\right)^{\delta} \\
&\lesssim (1 + \varepsilon^{-1}) e^{T\delta+\varepsilon(\delta-k_{\min})} \sum_{k=\lceil e^{T\theta}/C_1 \rceil}^{\lfloor \sqrt{C_3} e^{T/2} \rfloor} |Z_k| (C_3/k^2)^{\delta+\varepsilon(\delta-k_{\min})} \\
&\lesssim (1 + \varepsilon^{-1}) e^{T\delta+\varepsilon(\delta-k_{\min})} \sum_{k=\lceil e^{T\theta}/C_1 \rceil}^{\lfloor \sqrt{C_3} e^{T/2} \rfloor} k^{k_{\min}-1-2\delta-2\varepsilon(\delta-k_{\min})} \text{ by (4.21)} \\
&\lesssim (1 + \varepsilon^{-1}) e^{T\delta+\varepsilon(\delta-k_{\min})} \int_{e^{T\theta}/C_1}^{\sqrt{C_3} e^{T/2}} x^{k_{\min}-1-2\delta-2\varepsilon(\delta-k_{\min})} dx \\
&\lesssim (1 + \varepsilon^{-1}) e^{T\delta+\varepsilon(\delta-k_{\min})} e^{T\theta(k_{\min}-2\delta-2\varepsilon(\delta-k_{\min}))} dx \\
&\lesssim (1 + \varepsilon^{-1}) \left(e^{T(1-\theta)}\right)^{\delta-\frac{\theta}{1-\theta}(\delta-k_{\min})+\varepsilon(\delta-k_{\min})} e^{-T\theta\varepsilon(\delta-k_{\min})} \\
&\lesssim (1 + \varepsilon^{-1}) \left(e^{T(1-\theta)}\right)^{\delta-\frac{\theta}{1-\theta}(\delta-k_{\min})+\varepsilon(\delta-k_{\min})}
\end{aligned}$$

which proves

$$\dim_L^\theta L(\Gamma) \leq \delta - \frac{\theta}{1-\theta}(\delta - k_{\min}) + \varepsilon(\delta - k_{\min})$$

and letting $\varepsilon \rightarrow 0$ proves the upper bound.

4.6.3 When $\delta \geq k_{\max}$

- We show $\dim_L^\theta L(\Gamma) = \delta - \min\left\{1, \frac{\theta}{1-\theta}\right\}(\delta - k_{\min})$.

The lower bound follows from the fact that

$$\dim_L^\theta L(\Gamma) \geq \dim_L^\theta \mu = \delta - \min\left\{1, \frac{\theta}{1-\theta}\right\}(\delta - k_{\min})$$

and therefore it suffices to prove the upper bound. The case when $\theta \geq 1/2$ is an immediate consequence of Lemma 4.8, and so we assume that $\theta \in (0, 1/2)$. Let $p \in P$ be a parabolic point with rank k_{\min} , and let $T > 0$ be sufficiently large. We can attain an upper bound on

$N_{e^{-T}}(B(p, e^{-T\theta}) \cap L(\Gamma))$ by first covering $B(p, e^{-T\theta}) \cap L(\Gamma)$ with a k_{\min} -dimensional collection of balls of radius $e^{-2T\theta}$ using Lemma 4.8, then covering each of those balls by balls of radius e^{-T} . Using the fact that $\dim_{\Lambda} L(\Gamma) = \delta$, we have

$$\begin{aligned} N_{e^{-T}}(B(p, e^{-T\theta}) \cap L(\Gamma)) &\lesssim N_{e^{-2T\theta}}(B(p, e^{-T\theta}) \cap L(\Gamma)) \left(\frac{e^{-2T\theta}}{e^{-T}}\right)^{\delta} \\ &\lesssim \left(\frac{e^{-T\theta}}{e^{-2T\theta}}\right)^{k_{\min}} \left(\frac{e^{-2T\theta}}{e^{-T}}\right)^{\delta} \\ &= e^{T(1-\theta)\delta + T\theta(k_{\min} - \delta)} = \left(e^{T(1-\theta)}\right)^{\delta - \frac{\theta}{1-\theta}(\delta - k_{\min})} \end{aligned}$$

which proves

$$\dim_{\mathbb{L}}^{\theta} L(\Gamma) \leq \delta - \frac{\theta}{1-\theta}(\delta - k_{\min})$$

as required.

5 Proofs of results regarding Julia sets

5.1 Preliminaries

Similarly to the Kleinian case, we need to be able to count canonical balls of certain sizes.

Lemma 5.1. *Let $\xi \in J(T)$ and $R > r > 0$. For R sufficiently small, we have*

$$\sum_{\substack{c(\omega) \in I \cap B(\xi, R) \\ R > r_{c(\omega)} \geq r}} r_{c(\omega)}^h \lesssim \log(R/r) m(B(\xi, R))$$

where $I := \bigcup_{n \geq 0} T^{-n}(I(\omega))$ for some $\omega \in \Omega$.

Proof. The approach here is similar to the proof of Lemma 4.6 given in [21, Lemma 5.2]. By [46, Theorem 3.1], there exists a constant $\kappa > 0$ dependant only on T such that for each $\omega \in \Omega$ and for sufficiently small $r > 0$, we have

$$J(T) \subseteq \bigcup_{\substack{c(\omega) \in I \\ r_{c(\omega)} \geq r}} B(c(\omega), \kappa r_{c(\omega)}^{p(\omega)/(1+p(\omega))} r^{1/(1+p(\omega))})$$

with multiplicity $\lesssim 1$. In particular, for $R > r > 0$ with R sufficiently small, the set

$$\bigcup_{\substack{c(\omega) \in I \cap B(\xi, R) \\ R > r_{c(\omega)} \geq r}} B(c(\omega), \kappa r_{c(\omega)}^{p(\omega)/(1+p(\omega))} r^{1/(1+p(\omega))})$$

has multiplicity $\lesssim 1$ and is contained in the ball $B(\xi, (\kappa + 1)R)$. Therefore, we have

$$\begin{aligned}
m(B(\xi, (\kappa + 1)R)) &\gtrsim \sum_{\substack{c(\omega) \in I \cap B(\xi, R) \\ R > r_{c(\omega)} \geq r}} m\left(B(c(\omega), \kappa r_{c(\omega)}^{p(\omega)/(1+p(\omega))}, r^{1/(1+p(\omega))})\right) \\
&\gtrsim \sum_{\substack{c(\omega) \in I \cap B(\xi, R) \\ R > r_{c(\omega)} \geq r}} \left(r_{c(\omega)}^{p(\omega)/(1+p(\omega))}, r^{1/(1+p(\omega))}\right)^h \left(\frac{r_{c(\omega)}^{p(\omega)/(1+p(\omega))}, r^{1/(1+p(\omega))}}{r_l(\xi)}\right)^{(h-1)p(\omega)} \\
&\gtrsim r^h \sum_{\substack{c(\omega) \in I \cap B(\xi, R) \\ R > r_{c(\omega)} \geq r}} \left(\frac{r_{c(\omega)}}{r}\right)^{p(\omega)/(1+p(\omega))} \\
&\gtrsim r^h \sum_{\substack{c(\omega) \in I \cap B(\xi, R) \\ R > r_{c(\omega)} \geq r}} 1
\end{aligned} \tag{5.1}$$

where the second inequality is an application of Theorem 2.3, and the third uses the fact that $r_{c(\omega)} \approx r_l$. Therefore

$$\begin{aligned}
\sum_{\substack{c(\omega) \in I \cap B(\xi, R) \\ R > r_{c(\omega)} \geq r}} r_{c(\omega)}^h &\leq \sum_{m \in \mathbb{Z} \cap [0, \log(R/r)]} \sum_{\substack{c(\omega) \in I \cap B(\xi, R) \\ e^{m+1}r > r_{c(\omega)} \geq e^m r}} r_{c(\omega)}^h \\
&\lesssim \sum_{m \in \mathbb{Z} \cap [0, \log(R/r)]} \sum_{\substack{c(\omega) \in I \cap B(\xi, R) \\ e^{m+1}r > r_{c(\omega)} \geq e^m r}} r^h e^{mh} \\
&\lesssim \sum_{m \in \mathbb{Z} \cap [0, \log(R/r)]} r^h e^{mh} \sum_{\substack{c(\omega) \in I \cap B(\xi, R) \\ R > r_{c(\omega)} \geq e^m r}} 1 \\
&\lesssim \sum_{m \in \mathbb{Z} \cap [0, \log(R/r)]} r^h e^{mh} \left((re^m)^{-h} m(B(\xi, (\kappa + 1)R)) \right) \quad \text{by (5.1)} \\
&\lesssim \log(R/r) m(B(\xi, R))
\end{aligned}$$

where the last inequality uses the fact that m is a doubling measure. \square

We also require the following key lemma.

Lemma 5.2. *Let $\xi \in J_r(T)$ and $R > 0$ be sufficiently small. Then there exists some $c(\omega) \in J_p(T)$ and some constant $C \geq 1$ such that*

$$B(\xi, R) \subset B(c(\omega), C\phi(\xi, R)^{\frac{1}{(h-1)p(\omega)}} r_{c(\omega)}).$$

Proof. It was shown in [18, Section 5] that

$$B(\xi, R) \subset T_\xi^{-n}(B(\omega, C\phi(\xi, R)^{\frac{1}{(h-1)p(\omega)}} r_\omega))$$

for some $\omega \in \Omega$ and uniform $C \geq 1$ where T_ξ^{-n} is an appropriately chosen holomorphic inverse branch of T^n . By definition $T_\xi^{-n}(\omega) \in J_p(T)$, and then the result is an immediate consequence of the fact that $(T_\xi^{-n})'(\omega)r_\omega \approx r_{c(\omega)}$, using the Koebe distortion theorem and the fact that $r_\omega \approx 1$ as Ω is a finite set (see [18, 46]). \square

5.2 The box dimension of m

5.2.1 Upper bound

- We show $\overline{\dim}_{\mathbb{B}} m \leq \max\{h, h + (h - 1)p_{\max}\}$.

Note that when $h \geq 1$, we have

$$\overline{\dim}_{\mathbb{B}} m \leq \dim_{\mathbb{A}} m \leq h + (h - 1)p_{\max}$$

(see Section 5.3) so we assume $h < 1$. Then note that for any $\xi \in J(T)$ and $r < |J(T)|$

$$m(B(\xi, r)) \approx r^h \phi(\xi, r) \geq r^h$$

which proves $\overline{\dim}_{\mathbb{B}} m \leq h$, as required.

5.2.2 Lower bound

- We show $\underline{\dim}_{\mathbb{B}} m \geq \max\{h, h + (h - 1)p_{\max}\}$.

Suppose $h \geq 1$. Let $\xi \in J_p(T)$ with associated terminating optimal sequence $(n_j(\xi))_{j=1, \dots, l}$ and hyperbolic zooms $(r_j(\xi))_{j=1, \dots, l}$ such that $T^{n_l(\xi)}(\xi) = \omega$ for some $\omega \in \mathbf{\Omega}$ with $p(\omega) = p_{\max}$. Then using Theorem 2.3, we have for all sufficiently small $r > 0$

$$m(B(\xi, r)) \lesssim r^{h+(h-1)p_{\max}}$$

which proves $\underline{\dim}_{\mathbb{B}} m \geq h + (h - 1)p_{\max}$, as required.

If $h < 1$, then we have $\underline{\dim}_{\mathbb{B}} m \geq \underline{\dim}_{\mathbb{B}} J(T) = h$, as required.

5.3 The Assouad dimension of m

The lower bound will follow from our lower bound for the Assouad spectrum of m , see Section 5.5. Therefore we only need to prove the upper bound.

- We show $\dim_{\mathbb{A}} m \leq \max\{1, h + (h - 1)p_{\max}\}$.

We only argue the case where $\xi \in J_r(T)$, and note that the case when $\xi \in J_p(T)$ follows similarly.

We make extensive use of Theorem 2.3 throughout.

Suppose $\xi \in J_r(T)$, with associated optimal sequence $(n_j(\xi))_{j \in \mathbb{N}}$ and hyperbolic zooms $(r_j(\xi))_{j \in \mathbb{N}}$. Suppose that $r_{j+1}(\xi) \leq r < R < r_j(\xi)$ and that $T^{n_j(\xi)+1}(\xi) \in U_\omega = B(\omega, r_\omega)$ for some $\omega \in \mathbf{\Omega}$, and let $r_m = r_j(\xi) (r_{j+1}(\xi)/r_j(\xi))^{\frac{1}{1+p(\omega)}}$.

If $r > r_m$, then

$$\frac{m(B(\xi, R))}{m(B(\xi, r))} \approx \left(\frac{R}{r}\right)^h \frac{(R/r_j(\xi))^{(h-1)p(\omega)}}{(r/r_j(\xi))^{(h-1)p(\omega)}} \leq \left(\frac{R}{r}\right)^{h+(h-1)p_{\max}}.$$

If $R < r_m$, then

$$\frac{m(B(\xi, R))}{m(B(\xi, r))} \approx \left(\frac{R}{r}\right)^h \frac{(r_{j+1}(\xi)/R)^{h-1}}{(r_{j+1}(\xi)/r)^{h-1}} = \left(\frac{R}{r}\right).$$

If $r \leq r_m \leq R$, then

$$\frac{m(B(\xi, R))}{m(B(\xi, r))} \approx \left(\frac{R}{r}\right)^h \frac{(R/r_j(\xi))^{(h-1)p(\omega)}}{(r_{j+1}(\xi)/r)^{h-1}} = \frac{R^{h+(h-1)p(\omega)}}{r r_j(\xi)^{(h-1)p(\omega)} r_{j+1}(\xi)^{h-1}}. \quad (5.2)$$

If we assume that $h \geq 1$, then note that

$$\left(\frac{r}{R}\right)^{h+(h-1)p(\omega)} \frac{m(B(\xi, R))}{m(B(\xi, r))} \approx \frac{r^{(h-1)(1+p(\omega))}}{r_j(\xi)^{(h-1)p(\omega)} r_{j+1}(\xi)^{h-1}}$$

is maximised when $r = r_m$. Therefore

$$\left(\frac{r}{R}\right)^{h+(h-1)p(\omega)} \frac{m(B(\xi, R))}{m(B(\xi, r))} \lesssim \frac{r_m^{(h-1)(1+p(\omega))}}{r_j(\xi)^{(h-1)p(\omega)} r_{j+1}(\xi)^{h-1}} = \frac{r_j(\xi)^{(h-1)(1+p(\omega))} \left(\frac{r_{j+1}(\xi)}{r_j(\xi)}\right)^{h-1}}{r_j(\xi)^{(h-1)p(\omega)} r_{j+1}(\xi)^{h-1}} = 1$$

which proves that

$$\frac{m(B(\xi, R))}{m(B(\xi, r))} \lesssim \left(\frac{R}{r}\right)^{h+(h-1)p(\omega)} \leq \left(\frac{R}{r}\right)^{h+(h-1)p_{\max}}.$$

Similarly, if $h < 1$, then by (5.2)

$$\left(\frac{r}{R}\right) \frac{m(B(\xi, R))}{m(B(\xi, r))} \approx \frac{R^{(h-1)(1+p(\omega))}}{r_j(\xi)^{(h-1)p(\omega)} r_{j+1}(\xi)^{h-1}}$$

is maximised when $R = r_m$. Therefore, as above

$$\left(\frac{r}{R}\right) \frac{m(B(\xi, R))}{m(B(\xi, r))} \lesssim 1$$

which proves

$$\frac{m(B(\xi, R))}{m(B(\xi, r))} \lesssim \left(\frac{R}{r}\right).$$

This covers all cases when $r_{j+1}(\xi) \leq r < R < r_j(\xi)$.

Now, we consider the cases when $r_{j+1}(\xi) \leq R < r_j(\xi)$, $r_{l+1}(\xi) \leq r < r_l(\xi)$, with $l > j$, $T^{n_j+1}(\xi) \in U_{\omega_1}$ and $T^{n_l+1}(\xi) \in U_{\omega_2}$ for some $\omega_1, \omega_2 \in \Omega$.

Let $r_m = r_j(\xi) (r_{j+1}(\xi)/r_j(\xi))^{\frac{1}{1+p(\omega_1)}}$ and $r_n = r_l(\xi) (r_{l+1}(\xi)/r_l(\xi))^{\frac{1}{1+p(\omega_2)}}$.

Case 1: $R > r_m$, $r > r_n$.

We have

$$\frac{m(B(\xi, R))}{m(B(\xi, r))} \approx \left(\frac{R}{r}\right)^h \frac{(R/r_j(\xi))^{(h-1)p(\omega_1)}}{(r/r_l(\xi))^{(h-1)p(\omega_2)}}. \quad (5.3)$$

If $h < 1$, then

$$\begin{aligned} \left(\frac{r}{R}\right) \frac{m(B(\xi, R))}{m(B(\xi, r))} &\lesssim \frac{R^{(h-1)(1+p(\omega_1))}}{r^{h-1} r_j(\xi)^{(h-1)p(\omega_1)}} \leq \frac{r_m^{(h-1)(1+p(\omega_1))}}{r_{j+1}(\xi)^{h-1} r_j(\xi)^{(h-1)p(\omega_1)}} \\ &= \frac{r_j(\xi)^{(h-1)(1+p(\omega_1))} \left(\frac{r_{j+1}(\xi)}{r_j(\xi)}\right)^{h-1}}{r_{j+1}(\xi)^{h-1} r_j(\xi)^{(h-1)p(\omega_1)}} = 1 \end{aligned}$$

and if $h \geq 1$, then by (5.3)

$$\frac{m(B(\xi, R))}{m(B(\xi, r))} \lesssim \left(\frac{R}{r}\right)^h \left(\frac{r_l(\xi)}{r}\right)^{(h-1)p(\omega_2)} \leq \left(\frac{R}{r}\right)^{h+(h-1)p(\omega_2)}$$

using $r_l(\xi) < R$.

Case 2: $R \leq r_m, r \leq r_n$.

We have

$$\frac{m(B(\xi, R))}{m(B(\xi, r))} \approx \left(\frac{R}{r}\right)^h \frac{(r_{j+1}(\xi)/R)^{h-1}}{(r_{l+1}(\xi)/r)^{h-1}}. \quad (5.4)$$

If $h < 1$, then

$$\frac{m(B(\xi, R))}{m(B(\xi, r))} \approx \left(\frac{R}{r}\right) \frac{r_{j+1}(\xi)^{h-1}}{r_{l+1}(\xi)^{h-1}} \leq \left(\frac{R}{r}\right)$$

and if $h \geq 1$, then by (5.4)

$$\frac{m(B(\xi, R))}{m(B(\xi, r))} \lesssim \frac{R^h}{rr_{l+1}(\xi)^{h-1}}$$

and therefore

$$\begin{aligned} \left(\frac{r}{R}\right)^{h+(h-1)p(\omega_2)} \frac{m(B(\xi, R))}{m(B(\xi, r))} &\lesssim \frac{R^{(1-h)p(\omega_2)}}{r^{(1-h)(1+p(\omega_2))} r_{l+1}(\xi)^{h-1}} \\ &\leq \frac{r_l(\xi)^{(1-h)p(\omega_2)}}{r_n^{(1-h)(1+p(\omega_2))} r_{l+1}(\xi)^{h-1}} \\ &= \frac{r_l(\xi)^{(1-h)p(\omega_2)}}{r_l(\xi)^{(1-h)(1+p(\omega_2))} \left(\frac{r_{l+1}(\xi)}{r_l(\xi)}\right)^{1-h} r_{l+1}(\xi)^{h-1}} = 1. \end{aligned}$$

Case 3: $R > r_m, r \leq r_n$.

We have

$$\frac{m(B(\xi, R))}{m(B(\xi, r))} \approx \left(\frac{R}{r}\right)^h \frac{(R/r_j(\xi))^{(h-1)p(\omega_1)}}{(r_{l+1}(\xi)/r)^{(h-1)}} = \frac{R^{h+(h-1)p(\omega_1)}}{rr_j(\xi)^{(h-1)p(\omega_1)} r_{l+1}(\xi)^{h-1}}. \quad (5.5)$$

If $h < 1$, then

$$\left(\frac{r}{R}\right) \frac{m(B(\xi, R))}{m(B(\xi, r))} \approx \frac{R^{(h-1)(1+p(\omega_1))}}{r_j(\xi)^{(h-1)p(\omega_1)} r_{l+1}(\xi)^{h-1}} \leq \frac{r_j(\xi)^{(h-1)(1+p(\omega_1))} \left(\frac{r_{j+1}(\xi)}{r_j(\xi)}\right)^{h-1}}{r_j(\xi)^{(h-1)p(\omega_1)} r_{j+1}(\xi)^{h-1}} = 1.$$

If $h \geq 1$ and $p(\omega_1) \geq p(\omega_2)$, then by (5.5)

$$\begin{aligned} \left(\frac{r}{R}\right)^{h+(h-1)p(\omega_1)} \frac{m(B(\xi, R))}{m(B(\xi, r))} &\approx \frac{r^{(h-1)(1+p(\omega_1))}}{r_j(\xi)^{(h-1)p(\omega_1)} r_{l+1}(\xi)^{h-1}} \\ &\leq \frac{r_l(\xi)^{(h-1)(1+p(\omega_1))} \left(\frac{r_{l+1}(\xi)}{r_l(\xi)}\right)^{\frac{(h-1)(1+p(\omega_1))}{1+p(\omega_2)}}}{r_l(\xi)^{(h-1)p(\omega_1)} r_{l+1}(\xi)^{h-1}} \\ &= \left(\frac{r_l(\xi)}{r_{l+1}(\xi)}\right)^{(h-1)\left(1-\frac{1+p(\omega_1)}{1+p(\omega_2)}\right)} \leq 1 \end{aligned}$$

and if $h \geq 1$ and $p(\omega_1) < p(\omega_2)$, then by (5.5)

$$\begin{aligned} \left(\frac{r}{R}\right)^{h+(h-1)p(\omega_2)} \frac{m(B(\xi, R))}{m(B(\xi, r))} &\approx \frac{r^{(h-1)(1+p(\omega_2))} R^{(h-1)(p(\omega_1)-p(\omega_2))}}{r_j(\xi)^{(h-1)p(\omega_1)} r_{l+1}(\xi)^{h-1}} \\ &\leq \frac{r_n^{(h-1)(1+p(\omega_2))} R^{(h-1)(p(\omega_1)-p(\omega_2))}}{r_l(\xi)^{(h-1)p(\omega_1)} r_{l+1}(\xi)^{h-1}} \\ &= \left(\frac{R}{r_l(\xi)}\right)^{(h-1)(p(\omega_1)-p(\omega_2))} \leq 1. \end{aligned}$$

Case 4: $R \leq r_m$, $r > r_n$.

This gives

$$\frac{m(B(\xi, R))}{m(B(\xi, r))} \approx \left(\frac{R}{r}\right)^h \frac{(r_{j+1}(\xi)/R)^{(h-1)}}{(r/r_l(\xi))^{(h-1)p(\omega_2)}}. \quad (5.6)$$

If $h < 1$, then

$$\left(\frac{r}{R}\right) \frac{m(B(\xi, R))}{m(B(\xi, r))} \lesssim \frac{r^{(1-h)(1+p(\omega_2))}}{r_{j+1}(\xi)^{1-h} r_l(\xi)^{(1-h)p(\omega_2)}} \leq \frac{r_l(\xi)^{(1-h)(1+p(\omega_2))}}{r_l(\xi)^{1-h} r_l(\xi)^{(1-h)p(\omega_2)}} = 1$$

and if $h \geq 1$, then by (5.6)

$$\frac{m(B(\xi, R))}{m(B(\xi, r))} \lesssim \left(\frac{R}{r}\right)^h \left(\frac{r_l(\xi)}{r}\right)^{(h-1)p(\omega_2)} \leq \left(\frac{R}{r}\right)^{h+(h-1)p(\omega_2)}.$$

In all possible cases, we have

$$\frac{m(B(\xi, R))}{m(B(\xi, r))} \lesssim \left(\frac{R}{r}\right)^{\max\{1, h+(h-1)p(\omega_1), h+(h-1)p(\omega_2)\}} \leq \left(\frac{R}{r}\right)^{\max\{1, h+(h-1)p_{\max}\}}$$

which proves the desired upper bound.

5.4 The lower dimension of m

The upper bound will follow from our upper bound for the lower spectrum of m , see Section 5.6. Therefore we only need to prove the lower bound. The lower bound for $\dim_{\mathbb{L}} m$ follows similarly to the argument for the upper bound for $\dim_{\mathbb{A}} m$, and so we omit some details.

- We show $\dim_{\mathbb{L}} m \geq \min\{1, h + (h-1)p_{\max}\}$.

We make extensive use of Theorem 2.3 throughout. Let $\xi \in J_r(T)$ with associated optimal sequence $(n_j(\xi))_{j \in \mathbb{N}}$ and hyperbolic zooms $(r_j(\xi))_{j \in \mathbb{N}}$. The case $\xi \in J_p(T)$ is similar and omitted. First, assume that $r_{j+1}(\xi) \leq r < R < r_j(\xi)$ with $T^{n_j(\xi)+1}(\xi) \in \omega$ for some $j \in \mathbb{N}$, $\omega \in \Omega$, and let $r_m = r_j(\xi) (r_{j+1}(\xi)/r_j(\xi))^{\frac{1}{1+p(\omega)}}$.

The cases when $r > r_m$ and $R < r_m$ are trivial, and so we assume $r \leq r_m \leq R$. This gives

$$\frac{m(B(\xi, R))}{m(B(\xi, r))} \approx \left(\frac{R}{r}\right)^h \frac{(R/r_j(\xi))^{(h-1)p(\omega)}}{(r_{j+1}(\xi)/r)^{h-1}} = \frac{R^{h+(h-1)p(\omega)}}{r^1 r_j(\xi)^{(h-1)p(\omega)} r_{j+1}(\xi)^{h-1}}.$$

If $h \geq 1$, then

$$\left(\frac{r}{R}\right) \frac{m(B(\xi, R))}{m(B(\xi, r))} \approx \frac{R^{(h-1)(1+p(\omega))}}{r_j(\xi)^{(h-1)p(\omega)} r_{j+1}(\xi)^{h-1}} \geq \frac{r_m^{(h-1)(1+p(\omega))}}{r_j(\xi)^{(h-1)p(\omega)} r_{j+1}(\xi)^{h-1}} = 1$$

and if $h < 1$, then

$$\left(\frac{r}{R}\right)^{h+(h-1)p(\omega)} \frac{m(B(\xi, R))}{m(B(\xi, r))} \approx \frac{r^{(h-1)(1+p(\omega))}}{r_j(\xi)^{(h-1)p(\omega)} r_{j+1}(\xi)^{h-1}} \geq \frac{r_m^{(h-1)(1+p(\omega))}}{r_j(\xi)^{(h-1)p(\omega)} r_{j+1}(\xi)^{h-1}} = 1$$

so in either case we have

$$\frac{m(B(\xi, R))}{m(B(\xi, r))} \gtrsim \left(\frac{R}{r}\right)^{\min\{1, h+(h-1)p(\omega)\}} \geq \left(\frac{R}{r}\right)^{\min\{1, h+(h-1)p_{\max}\}}.$$

We now consider the case when $r_{j+1}(\xi) \leq R < r_j(\xi)$, $r_{l+1}(\xi) \leq r < r_l(\xi)$, with $l > j$, $T^{n_j+1}(\xi) \in U_{\omega_1}$ and $T^{n_l+1}(\xi) \in U_{\omega_2}$ for some $\omega_1, \omega_2 \in \Omega$.

Let $r_m = r_j(\xi) (r_{j+1}(\xi)/r_j(\xi))^{\frac{1}{1+p(\omega_1)}}$ and $r_n = r_l(\xi) (r_{l+1}(\xi)/r_l(\xi))^{\frac{1}{1+p(\omega_2)}}$.

Case 1: $R > r_m$, $r > r_n$.

If $h < 1$, then by (5.3)

$$\frac{m(B(\xi, R))}{m(B(\xi, r))} \gtrsim \left(\frac{R}{r}\right)^h \left(\frac{r_l(\xi)}{r}\right)^{(h-1)p(\omega_2)} \geq \left(\frac{R}{r}\right)^{h+(h-1)p(\omega_2)}$$

and if $h \geq 1$, then by (5.3)

$$\left(\frac{r}{R}\right) \frac{m(B(\xi, R))}{m(B(\xi, r))} \gtrsim \frac{R^{(h-1)p(\omega_1)}}{r^{h-1} r_j(\xi)^{(h-1)p(\omega_1)}} \geq \frac{r_m^{(h-1)(1+p(\omega_1))}}{r_{j+1}(\xi)^{h-1} r_j(\xi)^{(h-1)p(\omega_1)}} = 1.$$

Case 2: $R \leq r_m$, $r \leq r_n$.

If $h < 1$, then by (5.4)

$$\frac{m(B(\xi, R))}{m(B(\xi, r))} \gtrsim \frac{R^h}{r r_{l+1}(\xi)^{h-1}}$$

and therefore

$$\left(\frac{r}{R}\right)^{h+(h-1)p(\omega_2)} \frac{m(B(\xi, R))}{m(B(\xi, r))} \gtrsim \frac{r^{(h-1)p(\omega_2)}}{R^{(h-1)p(\omega_2)} r_{l+1}(\xi)^{h-1}} \geq \frac{r_n^{(h-1)(1+p(\omega_2))}}{r_l(\xi)^{(h-1)p(\omega_2)} r_{l+1}(\xi)^{h-1}} = 1$$

and if $h \geq 1$, then by (5.4)

$$\frac{m(B(\xi, R))}{m(B(\xi, r))} \approx \left(\frac{R}{r}\right) \left(\frac{r_{l+1}(\xi)}{r_{j+1}(\xi)}\right)^{h-1} \geq \left(\frac{R}{r}\right).$$

Case 3: $R > r_m$, $r \leq r_n$.

If $h < 1$ and $p(\omega_1) \geq p(\omega_2)$, then by (5.5)

$$\begin{aligned} \left(\frac{r}{R}\right)^{h+(h-1)p(\omega_1)} \frac{m(B(\xi, R))}{m(B(\xi, r))} &\approx \frac{r^{(h-1)(1+p(\omega_1))}}{r_j(\xi)^{(h-1)p(\omega_1)} r_{l+1}(\xi)^{h-1}} \\ &\geq \frac{r_n^{(h-1)(1+p(\omega_1))}}{r_l(\xi)^{(h-1)p(\omega_1)} r_{l+1}(\xi)^{h-1}} = \left(\frac{r_l(\xi)}{r_{l+1}(\xi)}\right)^{(h-1)\left(1-\frac{1+p(\omega_1)}{1+p(\omega_2)}\right)} \geq 1 \end{aligned}$$

and if $h < 1$ and $p(\omega_1) < p(\omega_2)$, then by (5.5)

$$\begin{aligned} \left(\frac{r}{R}\right)^{h+(h-1)p(\omega_2)} \frac{m(B(\xi, R))}{m(B(\xi, r))} &\approx \frac{r^{(h-1)(1+p(\omega_2))} R^{(h-1)(p(\omega_1)-p(\omega_2))}}{r_j(\xi)^{(h-1)p(\omega_1)} r_{l+1}(\xi)^{h-1}} \\ &\geq \frac{r_n^{(h-1)(1+p(\omega_2))} R^{(h-1)(p(\omega_1)-p(\omega_2))}}{r_l(\xi)^{(h-1)p(\omega_1)} r_{l+1}(\xi)^{h-1}} \\ &= r_l(\xi)^{(h-1)(p(\omega_2)-p(\omega_1))} R^{(h-1)(p(\omega_1)-p(\omega_2))} \geq 1. \end{aligned}$$

If $h \geq 1$, then by (5.5)

$$\left(\frac{r}{R}\right) \frac{m(B(\xi, R))}{m(B(\xi, r))} \approx \frac{R^{(h-1)(1+p(\omega_1))}}{r_j(\xi)^{(h-1)p(\omega_1)} r_{l+1}(\xi)^{h-1}} \geq \frac{r_m^{(h-1)(1+p(\omega_1))}}{r_j(\xi)^{(h-1)p(\omega_1)} r_{j+1}(\xi)^{h-1}} = 1.$$

Case 4: $R \leq r_m$, $r > r_n$.

If $h < 1$, then by (5.6)

$$\frac{m(B(\xi, R))}{m(B(\xi, r))} \gtrsim \left(\frac{R}{r}\right)^h \left(\frac{r_l(\xi)}{r}\right)^{(h-1)p(\omega_2)} \geq \left(\frac{R}{r}\right)^{h+(h-1)p(\omega_2)}$$

and if $h \geq 1$, then by (5.6)

$$\left(\frac{r}{R}\right) \frac{m(B(\xi, R))}{m(B(\xi, r))} \gtrsim \frac{r^{(1-h)(1+p(\omega_2))}}{r_{j+1}(\xi)^{1-h} r_l(\xi)^{(1-h)p(\omega_2)}} \geq \frac{r_l(\xi)^{(1-h)(1+p(\omega_2))}}{r_l(\xi)^{1-h} r_l(\xi)^{(1-h)p(\omega_2)}} = 1.$$

In all cases, we have

$$\frac{m(B(\xi, R))}{m(B(\xi, r))} \gtrsim \left(\frac{R}{r}\right)^{\min\{1, h+(h-1)p(\omega_1), h+(h-1)p(\omega_2)\}} \geq \left(\frac{R}{r}\right)^{\min\{1, h+(h-1)p_{\max}\}}$$

which proves the desired lower bound.

5.5 The Assouad spectrum of m

5.5.1 When $h < 1$

The lower bound here follows from the lower bound for the Assouad spectrum of $J(T)$, see Section 5.9.1. Therefore it remains to prove the upper bound.

- We show $\dim_{\mathbb{A}}^{\theta} m \leq h + \min\left\{1, \frac{\theta p_{\max}}{1-\theta}\right\} (1-h)$.

The case when $\theta \geq 1/(1+p_{\max})$ follows easily, as

$$\dim_{\mathbb{A}}^{\theta} m \leq \dim_{\mathbb{A}} m \leq 1,$$

so we assume $\theta < 1/(1 + p_{\max})$. Let $\xi \in J_r(T)$, and assume that $r_{j+1}(\xi) \leq r^\theta < r_j(\xi)$, $r_{l+1}(\xi) \leq r < r_l(\xi)$, with $l \geq j$, $T^{n_{j+1}(\xi)}(\xi) \in U_{\omega_1}$ and $T^{n_l(\xi)}(\xi) \in U_{\omega_2}$ for some $\omega_1, \omega_2 \in \Omega$. The case $\xi \in J_p(T)$ is similar and omitted. Let $r_m = r_j(\xi) (r_{j+1}(\xi)/r_j(\xi))^{\frac{1}{1+p(\omega_1)}}$. If $r^\theta > r_m$, then by Theorem 2.3

$$\begin{aligned} \frac{m(B(\xi, r^\theta))}{m(B(\xi, r))} &\lesssim \left(\frac{r^\theta}{r}\right)^h \left(\frac{r^\theta}{r_j(\xi)}\right)^{(h-1)p(\omega_1)} \leq \left(\frac{r^\theta}{r}\right)^h r^{\theta(h-1)p(\omega_1)} r_1(\xi)^{(1-h)p(\omega_1)} \\ &\lesssim \left(\frac{r^\theta}{r}\right)^{h + \frac{\theta p_{\max}}{1-\theta}(1-h)} \end{aligned}$$

and if $r^\theta \leq r_m$, then by Theorem 2.3

$$\begin{aligned} \frac{m(B(\xi, r^\theta))}{m(B(\xi, r))} &\lesssim \left(\frac{r^\theta}{r}\right)^h \left(\frac{r_{j+1}(\xi)}{r^\theta}\right)^{h-1} \\ &\leq \left(\frac{r^\theta}{r}\right)^h \frac{r^{\theta(h-1)(1+p(\omega_1))}}{r^{\theta(h-1)}} r_j(\xi)^{(1-h)p(\omega_1)} \left(\text{using } r^\theta/r_j(\xi)^{\frac{p(\omega_1)}{1+p(\omega_1)}} \leq r_{j+1}(\xi)^{\frac{1}{1+p(\omega_1)}}\right) \\ &\lesssim \left(\frac{r^\theta}{r}\right)^{h + \frac{\theta p_{\max}}{1-\theta}(1-h)}. \end{aligned}$$

In either case, we have

$$\frac{m(B(\xi, r^\theta))}{m(B(\xi, r))} \lesssim \left(\frac{r^\theta}{r}\right)^{h + \frac{\theta p_{\max}}{1-\theta}(1-h)}$$

which proves

$$\dim_{\mathbb{A}}^\theta m \leq h + \frac{\theta p_{\max}}{1-\theta}(1-h)$$

as required.

5.5.2 When $h \geq 1$

- We show $\dim_{\mathbb{A}}^\theta m = h + (h-1)p_{\max}$.

This follows easily, since $h + (h-1)p_{\max} = \overline{\dim}_{\mathbb{B}} m \leq \dim_{\mathbb{A}}^\theta m \leq \dim_{\mathbb{A}} m \leq h + (h-1)p_{\max}$.

5.6 The lower spectrum of m

5.6.1 When $h < 1$

- We show $\dim_{\mathbb{L}}^\theta m = h + (h-1)p_{\max}$.

Note that

$$\dim_{\mathbb{L}}^\theta m \geq \dim_{\mathbb{L}} m \geq h + (h-1)p_{\max}$$

so we need only prove the upper bound. To do this, let $\xi \in J_p(T)$ with associated terminating optimal sequence $(n_j(\xi))_{j=1, \dots, l}$ and hyperbolic zooms $(r_j(\xi))_{j=1, \dots, l}$ such that $T^{n_l(\xi)}(\xi) = \omega$ for some $\omega \in \Omega$ with $p(\omega) = p_{\max}$. Then using Theorem 2.3, we have for all sufficiently small $r > 0$

$$\frac{m(B(\xi, r^\theta))}{m(B(\xi, r))} \lesssim \left(\frac{r^\theta}{r}\right)^h \left(\frac{r^\theta}{r}\right)^{(h-1)p(\omega)} = \left(\frac{r^\theta}{r}\right)^{h+(h-1)p_{\max}}$$

which proves $\dim_{\mathbb{L}}^{\theta} m \leq h + (h - 1)p_{\max}$, as required.

5.6.2 When $h \geq 1$

The upper bound here follows from the upper bound for the lower spectrum of $J(T)$, see Section 5.10.1. Therefore it remains to prove the lower bound.

- We show $\dim_{\mathbb{L}}^{\theta} m \geq h + \min \left\{ 1, \frac{\theta p_{\max}}{1 - \theta} \right\} (1 - h)$.

The case when $\theta \geq 1/(1 + p_{\max})$ follows easily, as $\dim_{\mathbb{L}}^{\theta} m \geq \dim_{\mathbb{L}} m \geq 1$, so we assume $\theta < 1/(1 + p_{\max})$. Let $\xi \in J_r(T)$, and assume that $r_{j+1}(\xi) \leq r^{\theta} < r_j(\xi)$, $r_{l+1}(\xi) \leq r < r_l(\xi)$, with $l \geq j$, $T^{n_j+1}(\xi) \in U_{\omega_1}$ and $T^{n_l+1}(\xi) \in U_{\omega_2}$ for some $\omega_1, \omega_2 \in \Omega$. The case $\xi \in J_p(T)$ is similar and omitted. Let $r_m = r_j(\xi) (r_{j+1}(\xi)/r_j(\xi))^{\frac{1}{1+p(\omega_1)}}$. If $r^{\theta} > r_m$, then by Theorem 2.3

$$\begin{aligned} \frac{m(B(\xi, r^{\theta}))}{m(B(\xi, r))} &\gtrsim \left(\frac{r^{\theta}}{r}\right)^h \left(\frac{r^{\theta}}{r_j(\xi)}\right)^{(h-1)p(\omega_1)} \geq \left(\frac{r^{\theta}}{r}\right)^h r^{\theta(h-1)p(\omega_1)} r_1(\xi)^{(1-h)p(\omega_1)} \\ &\gtrsim \left(\frac{r^{\theta}}{r}\right)^{h + \frac{\theta p_{\max}}{1-\theta}(1-h)} \end{aligned}$$

and if $r^{\theta} \leq r_m$, Theorem 2.3 gives

$$\begin{aligned} \frac{m(B(\xi, r^{\theta}))}{m(B(\xi, r))} &\gtrsim \left(\frac{r^{\theta}}{r}\right)^h \left(\frac{r_{j+1}(\xi)}{r^{\theta}}\right)^{h-1} \\ &\geq \left(\frac{r^{\theta}}{r}\right)^h \frac{r^{\theta(h-1)(1+p(\omega_1))}}{r^{\theta(h-1)}} r_j(\xi)^{(1-h)p(\omega_1)} \left(\text{using } r^{\theta}/r_j(\xi)^{\frac{p(\omega_1)}{1+p(\omega_1)}} \leq r_{j+1}(\xi)^{\frac{1}{1+p(\omega_1)}} \right) \\ &\gtrsim \left(\frac{r^{\theta}}{r}\right)^{h + \frac{\theta p_{\max}}{1-\theta}(1-h)}. \end{aligned}$$

In either case, we have

$$\frac{m(B(\xi, r^{\theta}))}{m(B(\xi, r))} \gtrsim \left(\frac{r^{\theta}}{r}\right)^{h + \frac{\theta p_{\max}}{1-\theta}(1-h)}$$

which proves

$$\dim_{\mathbb{L}}^{\theta} m \geq h + \frac{\theta p_{\max}}{1 - \theta} (1 - h)$$

as required.

5.7 The Assouad dimension of $J(T)$

The lower bound will follow from our lower bound for the Assouad spectrum of $J(T)$, see Section 5.9. Therefore we only need to prove the upper bound.

- We show $\dim_{\mathbb{A}} J(T) \leq \max\{1, h\}$.

Note that when $h \leq 1$, we have $\dim_{\mathbb{A}} J(T) \leq \dim_{\mathbb{A}} m \leq 1$, so throughout we assume that $h > 1$. Let $\xi \in J(T)$, $\varepsilon > 0$, and $R > r > 0$ with $R/r \geq \max\{e^{\varepsilon^{-1}}, 10\}$. Let $\{B(x_i, r)\}_{i \in X}$ be a

centred r -packing of $B(\xi, R) \cap J(T)$ of maximal cardinality. We assume for convenience that each $x_i \in J_r(T)$, which we may do since $J_r(T)$ is dense in $J(T)$. This is not really necessary but allows for efficient application of Lemma 5.2. Each x_i has a particular $\omega = \omega(i) \in \Omega$ associated with it, coming from the global measure formula for $m(B(x_i, r))$. In particular, x_i belongs to an associated canonical ball $B(c(\omega), r_{c(\omega)})$. Decompose X as

$$X = X_0 \cup X_1 \cup \bigcup_{n=2}^{\infty} X_n$$

where

$$\begin{aligned} X_0 &= \{i \in X \mid x_i \in B(c(\omega), r_{c(\omega)}) \text{ with } r_{c(\omega)} \geq 5R\} \\ X_1 &= \{i \in X \setminus X_0 \mid \phi(x_i, r) \geq (r/R)^\varepsilon\} \\ \text{and } X_n &= \{i \in X \setminus (X_0 \cup X_1) \mid e^{-n} \leq \phi(x_i, r) < e^{-(n-1)}\}. \end{aligned}$$

To study those $i \in X_0$, we decompose X_0 further as

$$X_0 = X_0^0 \cup \bigcup_{n=1}^{\infty} X_0^n$$

where

$$\begin{aligned} X_0^0 &= \{i \in X_0 \mid \phi(x_i, r) \geq \phi(\xi, R)\} \\ X_0^n &= \{i \in X_0 \mid e^{-n}\phi(\xi, R) \leq \phi(x_i, r) < e^{-(n-1)}\phi(\xi, R)\}. \end{aligned}$$

If $i \in X_0^0$, then by Theorem 2.3

$$R^h \phi(\xi, R) \gtrsim m(B(\xi, R)) \gtrsim m\left(\bigcup_{i \in X_0^0} B(x_i, r)\right) \gtrsim \min_{i \in X_0^0} |X_0^0| r^h \phi(x_i, r) \geq |X_0^0| r^h \phi(\xi, R)$$

which implies that

$$|X_0^0| \lesssim \left(\frac{R}{r}\right)^h.$$

Turning our attention to X_0^n , for $c(\omega) \in J_p(T)$, write $X_0^n(c(\omega))$ to denote the set of all $i \in X_0^n$ which are associated with $c(\omega)$ (that is, $\phi(x_i, r)$ is defined via $c(\omega)$ in the context of Theorem 2.3). In particular, Lemma 5.2 ensures that

$$B(x_i, r) \subseteq B(c(\omega), C(\phi(\xi, R)e^{-(n-1)})^{\frac{1}{(h-1)p(\omega)}} r_{c(\omega)})$$

for all $i \in X_0^n(c(\omega))$, where $C \geq 1$ is the constant coming from Lemma 5.2. Temporarily fix $c(\omega) \in J_p(T)$ such that $X_0^n(c(\omega)) \neq \emptyset$. We have

$$|c(\omega) - z| \approx \phi(z, \rho)^{\frac{1}{(h-1)p(\omega)}} r_{c(\omega)} \tag{5.7}$$

for all $z \in J(T)$ and $\rho > 0$ such that $\phi(z, \rho)$ is defined via $c(\omega)$ in the context of Theorem 2.3. This is proved in [18]. Specifically, [18, Equations (5.3) and (5.5)] give

$$\phi(z, \rho)^{\frac{1}{(h-1)p(\omega)}} \approx |T^n(z) - \omega|$$

where $n \in \mathbb{N}$ is such that $T^n(c(\omega)) = \omega$ and $|(T^n)'(c(\omega))| \approx r_{c(\omega)}^{-1}$ (we note that the ϕ used in [18] is different than the notation we are using, so we have translated the equation into our notation which is consistent with [45],[46]). Then, applying the Koebe Distortion Theorem,

$$|T^n(z) - \omega| \approx r_{c(\omega)}^{-1} |z - c(\omega)|$$

establishing (5.7).

Suppose $i \in X_0^N(c(\omega))$ for some large N , which implies $\phi(x_i, r) \leq e^{-(N-1)}\phi(\xi, R)$. Recall that $r_{c(\omega)} \geq 5R$. Let $j \in \mathbb{N}$ be such that $n_{j+1} = n_{j+1}(x_i)$ satisfies $|(T^{n_{j+1}})'(x_i)|^{-1} = r_{j+1}(x_i) \leq r < r_j(x_i)$ and $T^{n_{j+1}-1}(x_i) \in U_\omega$. Moreover, for n such that $T^n(c(\omega)) = \omega$ and $|(T^n)'(c(\omega))| \approx r_{c(\omega)}^{-1}$, we have $T^n(\xi) \in U_\omega$. Then, since $|(T^{n_{j+1}})'(x_i)|^{-1} = r_{j+1}(x_i) \leq r < R \leq r_{c(\omega)}/5 \approx |(T^n)'(c(\omega))|^{-1}$, we have $T^k(\xi) \in U_\omega$ for all $n < k < n_{j+1}$ and hence $\phi(\xi, aR)$ is also defined via $c(\omega)$ in the context of Theorem 2.3 for some $a \approx 1$. Then by (5.7)

$$|\xi - c(\omega)| \gtrsim \phi(\xi, aR)^{\frac{1}{(h-1)p(\omega)}} r_{c(\omega)} \gtrsim \phi(\xi, R)^{\frac{1}{(h-1)p(\omega)}} r_{c(\omega)}$$

since m is doubling, and

$$|x_i - c(\omega)| \lesssim \phi(x_i, r)^{\frac{1}{(h-1)p(\omega)}} r_{c(\omega)} \lesssim e^{-\frac{N}{(h-1)p(\omega)}} \phi(\xi, R)^{\frac{1}{(h-1)p(\omega)}} r_{c(\omega)}$$

and therefore (see Figure 17)

$$R \geq |\xi - c(\omega)| - |x_i - c(\omega)| \gtrsim \phi(\xi, R)^{\frac{1}{(h-1)p(\omega)}} r_{c(\omega)} \quad (5.8)$$

for N chosen large enough depending only on various implicit constants. We fix such N in the following discussion.

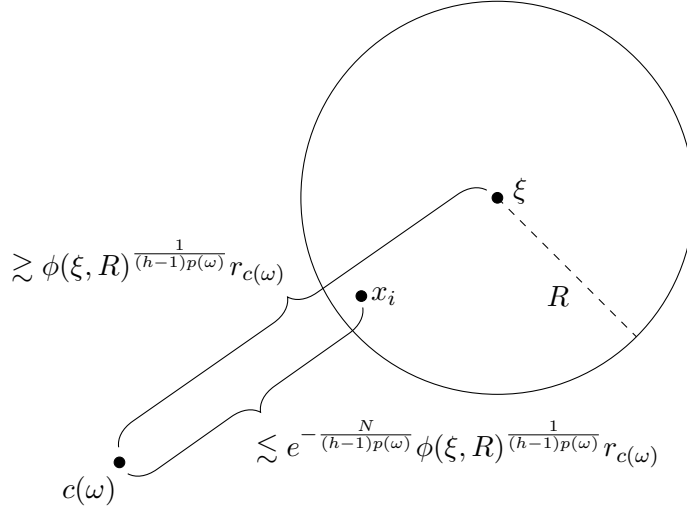

Figure 17: Bounding R from below.

We may assume $X_0^n(c(\omega)) \neq \emptyset$ for some $n \geq N$, since otherwise $\phi(x_i, r) \gtrsim \phi(\xi, R)$ for all $i \in X_0$ and the argument bounding $|X_0^0|$ also applies to bound $|X_0|$.

By Theorem 2.3

$$\begin{aligned} m\left(\bigcup_{i \in X_0^n(c(\omega))} B(x_i, r)\right) &\lesssim m\left(B(c(\omega), C(\phi(\xi, R)e^{-(n-1)})^{\frac{1}{(h-1)p(\omega)}} r_{c(\omega)})\right) \\ &\lesssim (e^{-n}\phi(\xi, R))^{\frac{h}{(h-1)p(\omega)}} r_{c(\omega)}^h e^{-n}\phi(\xi, R). \end{aligned}$$

In the other direction, as $\{x_i\}_{i \in X_0^n(c(\omega))}$ is an r -packing,

$$m\left(\bigcup_{i \in X_0^n(c(\omega))} B(x_i, r)\right) \geq \sum_{i \in X_0^n(c(\omega))} m(B(x_i, r)) \gtrsim |X_0^n(c(\omega))| r^h e^{-n}\phi(\xi, R)$$

and so

$$|X_0^n(c(\omega))| \lesssim (e^{-n}\phi(\xi, R))^{\frac{h}{(h-1)p(\omega)}} r_{c(\omega)}^h r^{-h} \lesssim e^{\frac{-nh}{(h-1)p_{\max}}} \left(\frac{R}{r}\right)^h$$

by (5.8). The number of distinct squeezed canonical balls giving rise to non-empty $X_0^n(c(\omega))$ with $n \geq N$ is $\lesssim 1$ since $\phi(\xi, aR)$ is defined via $c(\omega)$ for some $a \approx 1$ and any such $c(\omega)$ (see the argument leading up to (5.7)). Therefore

$$|X_0^n| \lesssim e^{\frac{-nh}{(h-1)p_{\max}}} \left(\frac{R}{r}\right)^h.$$

Pulling these estimates together, we get

$$|X_0| = |X_0^0| + \sum_{n=1}^{\infty} |X_0^n| \lesssim \left(\frac{R}{r}\right)^h + \sum_{n=1}^{\infty} e^{\frac{-nh}{(h-1)p_{\max}}} \left(\frac{R}{r}\right)^h \lesssim \left(\frac{R}{r}\right)^h. \quad (5.9)$$

If $i \in X_1$, then

$$R^h \phi(\xi, R) \gtrsim m(B(\xi, R)) \gtrsim \min_{i \in X_1} |X_1| r^h \phi(x_i, r) \gtrsim |X_1| r^h \left(\frac{r}{R}\right)^\varepsilon$$

which proves

$$|X_1| \lesssim \left(\frac{R}{r}\right)^{h+\varepsilon}. \quad (5.10)$$

Finally, we turn our attention to X_n . If $i \in X_n$ for $n \geq 2$, then $\phi(x_i, r) < e^{-(n-1)}$, and therefore by Lemma 5.2 the ball $B(x_i, r)$ is contained in the squeezed canonical ball

$$B(c(\omega), C e^{\frac{-(n-1)}{(h-1)p(\omega)}} r_{c(\omega)})$$

for some $c(\omega) \in J_p(T)$. Therefore, $r/C \leq r_{c(\omega)} < 5R < 6CR$ and, noting that $h > 1$,

$$|c(\omega) - \xi| \leq |c(\omega) - x_i| + |x_i - \xi| \leq Cr_{c(\omega)} + R \leq 5CR + R \leq 6CR$$

and so $c(\omega) \in B(\xi, 6CR)$. For $p \in \{p_{\min}, \dots, p_{\max}\}$, let

$$X_n^p = \{i \in X_n \mid p(\omega) = p\}$$

and let

$$I_p = \bigcup_{\substack{\omega \in \Omega \\ p(\omega) = p}} I$$

where I is defined in the same way as in Lemma 5.1. Then we have

$$\begin{aligned} m \left(\bigcup_{i \in X_n^p} B(x_i, r) \right) &\leq m \left(\bigcup_{\substack{c(\omega) \in I_p \cap B(\xi, 6CR) \\ 6CR > r_{c(\omega)} \geq r/C}} B(c(\omega), Ce^{\frac{-(n-1)}{(h-1)p}} r_{c(\omega)}) \right) \\ &\leq \sum_{\substack{c(\omega) \in I_p \cap B(\xi, 6CR) \\ 6CR > r_{c(\omega)} \geq r/C}} m \left(B(c(\omega), Ce^{\frac{-(n-1)}{(h-1)p}} r_{c(\omega)}) \right) \\ &\lesssim \sum_{\substack{c(\omega) \in I_p \cap B(\xi, 6CR) \\ 6CR > r_{c(\omega)} \geq r/C}} e^{\frac{-nh}{(h-1)p}} r_{c(\omega)}^h \phi(c(\omega), Ce^{\frac{-(n-1)}{(h-1)p}} r_{c(\omega)}) \quad \text{by Theorem 2.3} \\ &\lesssim \sum_{\substack{c(\omega) \in I_p \cap B(\xi, 6CR) \\ 6CR > r_{c(\omega)} \geq r/C}} e^{\frac{-nh}{(h-1)p}} r_{c(\omega)}^h e^{-(n-1)} \quad \text{by Theorem 2.3 (ii)} \\ &\lesssim e^{-n} e^{\frac{-nh}{(h-1)p}} (\log(R/r) + \log(6C^2)) m(B(\xi, R)) \quad \text{by Lemma 5.1} \\ &\lesssim e^{-n} e^{\frac{-nh}{(h-1)p}} \log(R/r) R^h \phi(\xi, R) \\ &\lesssim e^{-n} e^{\frac{-nh}{(h-1)p}} \varepsilon^{-1} n R^h. \end{aligned}$$

The final line uses the estimate $(r/R)^\varepsilon > e^{-n}$ which holds whenever X_n is non-empty. On the other hand, by Theorem 2.3

$$m \left(\bigcup_{i \in X_n^p} B(x_i, r) \right) \geq \sum_{i \in X_n^p} m(B(x_i, r)) \gtrsim |X_n^p| r^h e^{-n}.$$

Therefore

$$|X_n^p| \lesssim \varepsilon^{-1} n e^{\frac{-nh}{(h-1)p}} \left(\frac{R}{r} \right)^h \lesssim \varepsilon^{-1} n e^{\frac{-nh}{(h-1)p_{\max}}} \left(\frac{R}{r} \right)^h$$

which gives

$$|X_n| \leq \sum_{p=p_{\min}}^{p_{\max}} |X_n^p| \lesssim \varepsilon^{-1} n e^{\frac{-nh}{(h-1)p_{\max}}} \left(\frac{R}{r} \right)^h. \quad (5.11)$$

Combining (5.9), (5.10) and (5.11), we have

$$\begin{aligned} |X| = |X_0| + |X_1| + \sum_{n=2}^{\infty} |X_n| &\lesssim \left(\frac{R}{r} \right)^h + \left(\frac{R}{r} \right)^{h+\varepsilon} + \sum_{n=2}^{\infty} \varepsilon^{-1} n e^{\frac{-nh}{(h-1)p_{\max}}} \left(\frac{R}{r} \right)^h \\ &\lesssim \left(\frac{R}{r} \right)^{h+\varepsilon} + \varepsilon^{-1} \left(\frac{R}{r} \right)^h \end{aligned}$$

which proves that $\dim_{\mathbb{A}} J(T) \leq h + \varepsilon$, and letting $\varepsilon \rightarrow 0$ proves that $\dim_{\mathbb{A}} J(T) \leq h$, as required.

5.8 The lower dimension of $J(T)$

The upper bound will follow from our upper bound for the lower spectrum of $J(T)$, see Section 5.10. Therefore we only need to prove the lower bound.

- We show $\dim_{\mathbb{L}} J(T) \geq \min\{1, h\}$.

Note that when $h \geq 1$, we have $\dim_{\mathbb{L}} J(T) \geq \dim_{\mathbb{L}} m \geq 1$ so we may assume throughout that $h < 1$.

Let $\xi \in J(T)$, and $R > r > 0$ with $R/r \geq 10$. Let $\{B(y_i, r)\}_{i \in Y}$ be a centred r -covering of $B(\xi, R) \cap J(T)$ of minimal cardinality. We assume for convenience that each $y_i \in J_r(T)$, which we may do since $J_r(T)$ is dense in $J(T)$. Each y_i has a particular $\omega = \omega(i) \in \Omega$ associated with it, coming from the global measure formula for $m(B(x_i, r))$. In particular, y_i belongs to an associated canonical ball $B(c(\omega), r_{c(\omega)})$.

Decompose Y as $Y = Y_0 \cup Y_1$ where

$$\begin{aligned} Y_0 &= \{i \in Y \mid y_i \in B(c(\omega), r_{c(\omega)}) \text{ with } r_{c(\omega)} \geq 5R\} \\ Y_1 &= Y \setminus Y_0. \end{aligned}$$

As $\{B(y_i, r)\}_{i \in Y}$ is a covering of $B(\xi, R) \cap J(T)$, we have

$$\begin{aligned} m(B(\xi, R)) &\leq m(\cup_{i \in Y} B(y_i, r)) \\ &= m(\cup_{i \in Y_0} B(y_i, r)) + m(\cup_{i \in Y_1} B(y_i, r)) \end{aligned} \quad (5.12)$$

and therefore one of the terms in (5.12) must be at least $(m(\xi, R))/2$.

Suppose that the term involving Y_0 is at least $(m(\xi, R))/2$. Then we write

$$Y_0^0 = \{i \in Y_0 \mid \phi(y_i, r) \leq K\phi(\xi, R)\}$$

where $K > 0$ is a constant chosen according to the following lemma.

Lemma 5.3. *We may choose $K > 0$ independently of R and r sufficiently large such that*

$$\frac{m(\cup_{i \in Y_0 \setminus Y_0^0} B(y_i, r))}{m(B(\xi, R))} \leq \frac{1}{100}. \quad (5.13)$$

Proof. Write $Y(c(\omega))$ to denote the set of all $i \in Y_0 \setminus Y_0^0$ such that

$$B(y_i, r) \subseteq B(c(\omega), C\phi(y_i, r)^{\frac{1}{(h-1)p(\omega)}} r_{c(\omega)}) \subseteq B(c(\omega), C(K\phi(\xi, R))^{\frac{1}{(h-1)p(\omega)}} r_{c(\omega)}) \quad (5.14)$$

using the definition of $Y_0 \setminus Y_0^0$ and where $C \geq 1$ is the constant from Lemma 5.2. By Lemma 5.2, all $i \in Y_0 \setminus Y_0^0$ belong to some $Y(c(\omega))$. Consider non-empty $Y(c(\omega))$. Since $r_{c(\omega)} \geq 5R$ we may follow the proof of (5.8) to show that, provided $Y(c(\omega)) \neq \emptyset$, $\phi(\xi, aR)$ is defined via $c(\omega)$ in the context of Theorem 2.3 for some $a \approx 1$ and that K can be chosen large enough such that $|c(\omega) - \xi| \lesssim R$. Then, since m is doubling, by Theorem 2.3

$$R^h \phi(\xi, R) \approx m(B(\xi, R)) \approx m(B(c(\omega), R)) \approx R^h \phi(c(\omega), R) \approx R^h \left(\frac{R}{r_{c(\omega)}} \right)^{(h-1)p(\omega)}$$

and so

$$r_{c(\omega)}\phi(\xi, R)^{\frac{1}{(h-1)p(\omega)}} \approx R. \quad (5.15)$$

Applying Theorem 2.3 and (5.14),

$$\begin{aligned} \frac{m\left(\cup_{i \in Y(c(\omega))} B(y_i, r)\right)}{m(B(\xi, R))} &\lesssim \frac{\left((K\phi(\xi, R))^{\frac{1}{(h-1)p(\omega)}}\right)^{h+(h-1)p(\omega)} r_{c(\omega)}^h}{\phi(\xi, R)R^h} \\ &= K^{1+\frac{h}{(h-1)p(\omega)}} \left(\frac{\phi(\xi, R)^{\frac{1}{(h-1)p(\omega)}} r_{c(\omega)}}{R}\right)^h \\ &\lesssim K^{1+\frac{h}{(h-1)p(\omega)}} \end{aligned}$$

by (5.15). Note that the number of distinct squeezed canonical balls giving rise to non-empty $Y(c(\omega))$ is $\lesssim 1$. This is because $\phi(\xi, aR)$ is defined via $c(\omega)$ for some $a \approx 1$ and any such $c(\omega)$. Using the general bound $h > p_{\max}/(1 + p_{\max})$, we see $1 + h/((h-1)p(\omega)) < 0$, and therefore we may choose K large enough to ensure (5.13). \square

Applying (5.13), we have

$$m\left(\cup_{i \in Y_0^0} B(y_i, r)\right) \approx m\left(\cup_{i \in Y_0} B(y_i, r)\right) \geq m(B(\xi, R))/2$$

which gives

$$R^h \phi(\xi, R) \lesssim m(B(\xi, R)) \lesssim m\left(\cup_{i \in Y_0^0} B(y_i, r)\right) \lesssim |Y_0^0| r^h \phi(\xi, R)$$

where the last inequality uses the definition of Y_0^0 . Therefore

$$|Y_0| \geq |Y_0^0| \gtrsim \left(\frac{R}{r}\right)^h. \quad (5.16)$$

Now, suppose that the second term of (5.12) is at least $m(B(\xi, R))/2$. Let $\varepsilon > 0$ and write

$$Y_1^0 = \left\{ i \in Y_1 \mid \phi(y_i, r) \leq \left(\frac{R}{r}\right)^\varepsilon \right\}.$$

If $i \in Y_1 \setminus Y_1^0$, then this implies that $\phi(y_i, r) > (R/r)^\varepsilon$, and therefore by Lemma 5.2 the ball $B(y_i, r)$ is contained in the squeezed canonical ball

$$B\left(c(\omega), C\left(\frac{R}{r}\right)^{\frac{\varepsilon}{(h-1)p(\omega)}} r_{c(\omega)}\right)$$

for some $c(\omega) \in J_p(T)$. Therefore, recalling the definition of Y_1 , $r/C \leq r_{c(\omega)} < 5R < 6CR$ and, using $h < 1$,

$$|c(\omega) - \xi| \leq |c(\omega) - y_i| + |y_i - \xi| \leq Cr_{c(\omega)} + R \leq 5CR + R \leq 6CR$$

and so $c(\omega) \in B(\xi, 6CR)$. Therefore

$$\begin{aligned}
m\left(\cup_{i \in Y_1 \setminus Y_1^0} B(y_i, r)\right) &\lesssim \sum_{\substack{c(\omega) \in J_p(T) \cap B(\xi, 6CR) \\ 6CR > r_{c(\omega)} \geq r/C}} m\left(B(c(\omega), C\left(\frac{R}{r}\right)^{\frac{\varepsilon}{(h-1)p(\omega)}} r_{c(\omega)})\right) \\
&\lesssim \sum_{\substack{c(\omega) \in J_p(T) \cap B(\xi, 6CR) \\ 6CR > r_{c(\omega)} \geq r/C}} \left(\frac{R}{r}\right)^{\frac{\varepsilon h}{(h-1)p(\omega)}} r_{c(\omega)}^h \phi\left(c(\omega), \left(\frac{R}{r}\right)^{\frac{\varepsilon}{(h-1)p(\omega)}} r_{c(\omega)}\right) \\
&\lesssim \sum_{\substack{c(\omega) \in J_p(T) \cap B(\xi, 6CR) \\ 6CR > r_{c(\omega)} \geq r/C}} \left(\frac{R}{r}\right)^{\frac{\varepsilon h}{(h-1)p(\omega)}} r_{c(\omega)}^h \left(\frac{R}{r}\right)^\varepsilon \quad (\text{since } c(\omega) \in J_p(T)) \\
&\lesssim (\log(R/r) + \log(6C^2)) \left(\frac{R}{r}\right)^{\frac{\varepsilon(h+(h-1)p_{\max})}{(h-1)p_{\max}}} m(\xi, R)
\end{aligned}$$

where the last inequality uses Lemma 5.1 and the fact that m is doubling. Note that the exponent of the term involving R/r is negative, recalling that $h > p_{\max}/(1 + p_{\max})$, so for sufficiently large R/r , balls with centres in $Y_1 \setminus Y_1^0$ cannot carry a fixed proportion of $m(B(\xi, R))$, and so

$$m\left(\cup_{i \in Y_1^0} B(y_i, r)\right) \approx m\left(\cup_{i \in Y_1} B(y_i, r)\right) \geq m(B(\xi, R))/2.$$

Therefore, we have

$$R^h \phi(\xi, R) \lesssim m(B(\xi, R)) \lesssim m\left(\cup_{i \in Y_1^0} B(y_i, r)\right) \lesssim |Y_1^0| r^h \left(\frac{R}{r}\right)^\varepsilon$$

where the last inequality uses the definition of Y_1^0 . Therefore

$$|Y_1| \geq |Y_1^0| \gtrsim \left(\frac{R}{r}\right)^{h-\varepsilon} \phi(\xi, R) \geq \left(\frac{R}{r}\right)^{h-\varepsilon}. \quad (5.17)$$

We have proven that at least one of (5.16) and (5.17) must hold, and therefore

$$|Y| = |Y_0| + |Y_1| \gtrsim \left(\frac{R}{r}\right)^{h-\varepsilon}$$

which proves that $\dim_L J(T) \geq h - \varepsilon$, and letting $\varepsilon \rightarrow 0$ proves the desired result.

5.9 The Assouad spectrum of $J(T)$

5.9.1 When $h < 1$

- We show $\dim_A^\theta J(T) = h + \min\left\{1, \frac{\theta p_{\max}}{1-\theta}\right\}(1-h)$.

The upper bound follows from

$$\dim_A^\theta J(T) \leq \dim_A^\theta m \leq h + \min\left\{1, \frac{\theta p_{\max}}{1-\theta}\right\}(1-h)$$

and for the lower bound, we can apply Proposition 4.7. As $h < 1$, we have $\dim_{\mathbb{L}} J(T) = \overline{\dim}_{\mathbb{B}} J(T) = h$ and the upper bound for $\dim_{\mathbb{A}}^{\theta} J(T)$ shows that $\rho \geq 1/(1 + p_{\max})$, so we need only show that $\rho \leq 1/(1 + p_{\max})$. To do this, let $\omega \in \Omega$ such that $p(\omega) = p_{\max}$, and recall that there exists some sufficiently small neighbourhood $U_{\omega} = B(\omega, r_{\omega})$ such that there exists a unique holomorphic inverse branch T_{ω}^{-1} of T on U_{ω} such that $T_{\omega}^{-1}(\omega) = \omega$. Using [17, Lemma 1], we have that for $\xi \in U_{\omega} \cap (J(T) \setminus \{\omega\})$ and $n \in \mathbb{N}$,

$$|T_{\omega}^{-n}(\xi) - \omega| \approx n^{\frac{-1}{p_{\max}}}$$

which, using T -invariance of $J(T)$ and bi-Lipschitz stability of the Assouad spectrum, implies that

$$\dim_{\mathbb{A}}^{\theta} J(T) \geq \dim_{\mathbb{A}}^{\theta} \{n^{-1/p_{\max}} : n \in \mathbb{N}\} = \min \left\{ 1, \frac{p_{\max}}{(1 + p_{\max})(1 - \theta)} \right\}$$

by [25, Corollary 6.4]. This is enough to ensure $\rho \leq 1/(1 + p_{\max})$. Therefore, by Proposition 4.7, for $\theta \in (0, 1/(1 + p_{\max}))$ we have

$$\dim_{\mathbb{A}}^{\theta} J(T) \geq h + \frac{(1 - 1/(1 + p_{\max}))\theta}{(1 - \theta)/(1 + p_{\max})}(1 - h) = h + \frac{\theta p_{\max}}{1 - \theta}(1 - h)$$

as required.

5.9.2 When $h \geq 1$

- We show $\dim_{\mathbb{A}}^{\theta} J(T) = h$.

This follows easily, since $h = \overline{\dim}_{\mathbb{B}} J(T) \leq \dim_{\mathbb{A}}^{\theta} J(T) \leq \dim_{\mathbb{A}} J(T) = h$.

5.10 The lower spectrum of $J(T)$

5.10.1 When $h < 1$

- We show $\dim_{\mathbb{L}}^{\theta} J(T) = h$.

This follows easily, since $h = \dim_{\mathbb{L}} J(T) \leq \dim_{\mathbb{L}}^{\theta} J(T) \leq \underline{\dim}_{\mathbb{B}} J(T) = h$.

5.10.2 When $h \geq 1$

- We show $\dim_{\mathbb{L}}^{\theta} J(T) = h + \min \left\{ 1, \frac{\theta p_{\max}}{1 - \theta} \right\} (1 - h)$.

Note that we have

$$\dim_{\mathbb{L}}^{\theta} J(T) \geq \dim_{\mathbb{L}}^{\theta} m \geq h + \min \left\{ 1, \frac{\theta p_{\max}}{1 - \theta} \right\} (1 - h)$$

and so it suffices to prove the upper bound. To do this, we require the following technical lemma, which is a quantitative version of the Leau-Fatou flower theorem (see [30, 325–363] and [40]). This was not known to us initially, but seems to be standard in the complex dynamics community. We thank Davoud Cheraghi for explaining this version to us. We note that the non-quantitative version, e.g. that stated in [1, 18], is enough to bound the lower dimension from above, but not the lower spectrum.

Lemma 5.4. *Let $\omega \in \Omega$ be a parabolic fixed point with petal number $p(\omega)$. Then there exists a constant $C > 0$ such that for all sufficiently small $r > 0$, $B(\omega, r) \cap J(T)$ is contained in a $Cr^{1+p(\omega)}$ -neighbourhood of the set of $p(\omega)$ lines emanating from ω in the repelling directions.*

Proof. We only sketch the proof. We may assume via standard reductions that $\omega = 0$ and that the repelling directions are $e^{n2\pi i/p(\omega)}$ for $n = 0, 1, \dots, p(\omega) - 1$. By the (non-quantitative) Leau-Fatou flower theorem, $B(0, r) \cap J(T)$ is contained in a cuspidal neighbourhood of the repelling directions. Apply the coordinate transformation $z \mapsto 1/z^{p(\omega)}$ which sends the fixed point to infinity and the repelling directions to 1. The linearisation of the conjugated map at infinity is a (real) translation and this linearisation can be used to show that the Julia set is contained in a half-infinite horizontal strip of bounded height. It is instructive to compare this to Bowditch's theorem (Lemma 4.8). The pre-image of this strip under the coordinate transformation consists of cuspidal neighbourhoods of the $p(\omega)^{\text{th}}$ roots of unity, and an easy calculation gives the desired result. \square

We can use our work on the lower spectrum of m to show that the exponent used in Lemma 5.4 is sharp. Again, this seems to be well-known in the complex dynamics community (even a stronger form of sharpness than we give) but we mention it since we provide a new approach.

Corollary 5.5. *In the case where $\omega \in \Omega$ is of maximal rank, the expression $Cr^{1+p(\omega)}$ in Lemma 5.4 cannot be replaced by $Cr^{1+p(\omega)+\varepsilon}$ for any $\varepsilon > 0$.*

Proof. Suppose that such an ε -improvement was possible for some $\omega \in \Omega$ of maximal rank. Then, taking efficient r -covers of the improved cuspidal neighbourhood of $B(\omega, r^{1+p_{\max}+\varepsilon}) \cap J(T)$, we would obtain $\dim_{\mathbb{L}}^{\theta} J(T) \leq 1$ for all $\theta > 1/(1+p_{\max}+\varepsilon)$. This contradicts the lower bound for the lower spectrum of m , proved in Section 5.6.2. \square

We can now prove the upper bound. Note that when $\theta \geq 1/(1+p_{\max})$, we immediately have $\dim_{\mathbb{L}}^{\theta} J(T) \leq 1$ by Lemma 5.4, so we may assume that $\theta \in (0, 1/(1+p_{\max}))$. Let $\omega \in \Omega$ be such that $p(\omega) = p_{\max}$, and let $r > 0$ be sufficiently small. Then we can estimate $N_r(B(\omega, r^{\theta}) \cap J(T))$ by first covering $B(\omega, r^{\theta}) \cap J(T)$ with balls of radius $r^{\theta(1+p_{\max})}$, and then covering each of those balls with balls of radius r . Using the fact that $\dim_{\mathbb{A}} J(T) = h$, we have

$$\begin{aligned} N_r(B(\omega, r^{\theta}) \cap J(T)) &\lesssim N_{r^{\theta(1+p_{\max})}}(B(\omega, r^{\theta}) \cap J(T)) \left(\frac{r^{\theta(1+p_{\max})}}{r} \right)^h \\ &\lesssim \frac{r^{\theta}}{r^{\theta(1+p_{\max})}} \left(\frac{r^{\theta(1+p_{\max})}}{r} \right)^h \quad \text{by Lemma 5.4} \\ &= r^{-\theta p_{\max} + h(\theta(1+p_{\max}) - 1)} = \left(r^{\theta-1} \right)^{h + \frac{\theta p_{\max}}{\theta-1}(h-1)} \end{aligned}$$

which proves that

$$\dim_{\mathbb{L}}^{\theta} J(T) \leq h + \frac{\theta p_{\max}}{1-\theta}(1-h)$$

as required.

Acknowledgements. The authors thank Davoud Cheraghi and Mariusz Urbański for helpful discussions.

References

- [1] Aaronson, J., Denker, M., and Urbański, M. (1993). Ergodic theory for Markov fibred systems and parabolic rational maps. *Trans. Amer. Math. Soc.*, 337(2):495–548.
- [2] Anderson, J. W. (2005). *Hyperbolic geometry*. Springer-Verlag, London, 2nd edition.
- [3] Anderson, T. C., Hughes, K., Roos, J., and Seeger, A. (2019). $L^p \rightarrow L^q$ bounds for spherical maximal operators. preprint, available at: <https://arxiv.org/abs/1909.05389>.
- [4] Beardon, A. F. (1983). *The geometry of discrete groups*, volume 91 of *Graduate Texts in Mathematics*. Springer Verlag, New York.
- [5] Beardon, A. F. (1991). *Iteration of rational maps*. Springer Verlag, New York.
- [6] Beardon, A. F. and Maskit, B. (1974). Limit points of Kleinian groups and finite sided fundamental polyhedra. *Acta Math.*, 132:1–12.
- [7] Bishop, C. J. (1996). On a theorem of Beardon and Maskit. *Ann. Acad. Sci. Fenn. Math.*, 21:383–388.
- [8] Bishop, C. J. and Jones, P. W. (1997). Hausdorff dimension and Kleinian groups. *Acta Math.*, 179(1):1–39.
- [9] Bishop, C. J. and Peres, Y. (2017). *Fractals in Probability and Analysis*, volume 162 of *Cambridge Studies in Advanced Mathematics*. Cambridge.
- [10] Bowditch, B. H. (1993). Geometrical finiteness for hyperbolic groups. *J. Funct. Anal.*, 113(2):245–317.
- [11] Bowen, R. (1979). Hausdorff dimension of quasi-circles. *Pub. Math. IHES*, 50:11–25.
- [12] Carleson, L. and Gamelin, T. W. (1993). *Complex dynamics*. Springer Verlag, New York.
- [13] Chang, Y., Chen, H., and Wu, M. (2018). Lower Assouad type dimensions of uniformly perfect sets in doubling metric spaces. preprint, available at: <https://arxiv.org/abs/1807.11629>.
- [14] Chen, H., Du, Y., and Wei, C. (2017). Quasi-lower dimension and quasi-Lipschitz mapping. *Fractals*, 25.
- [15] Denker, M. and Urbański, M. (1991). Absolutely continuous invariant measures for expansive rational maps with rationally indifferent periodic points. *Forum Math.*, 3(6):561–580.
- [16] Denker, M. and Urbański, M. (1991). Hausdorff and conformal measures on Julia sets with a rationally indifferent periodic point. *J. Lond. Math. Soc.*, 2(1):107–118.
- [17] Denker, M. and Urbański, M. (1992). Geometric measures for parabolic rational maps. *Erg. Theo. & Dyn. Syst.*, 12(1):53–66.

- [18] Denker, M. and Urbański, M. (1992). The capacity of parabolic Julia sets. *Math. Z.*, 211(1):73–86.
- [19] Falconer, K. J. (2014). *Fractal geometry: mathematical foundations and applications*. John Wiley & Sons, Hoboken, NJ, 3rd edition.
- [20] Falconer, K. J., Fraser, J. M., and Käenmäki, A. (2020). Minkowski dimension for measures. preprint, available at: <https://arxiv.org/abs/2001.07055>.
- [21] Fraser, J. M. (2019). Regularity of Kleinian limit sets and Patterson-Sullivan measures. *Trans. Amer. Math. Soc.*, 372:4977–5009.
- [22] Fraser, J. M. (2020). *Assouad Dimension and Fractal Geometry*. Tracts in Mathematics Series (in press). Cambridge University Press.
- [23] Fraser, J. M., Hare, K. E., Hare, K. G., Troscheit, S., and Yu, H. (2019). The Assouad spectrum and the quasi-Assouad dimension: a tale of two spectra. *Ann. Acad. Sci. Fenn. Math.*, 44:379–387.
- [24] Fraser, J. M. and Yu, H. (2018). Assouad type spectra for some fractal families. *Indiana Univ. Math. J.*, 67:2005–2043.
- [25] Fraser, J. M. and Yu, H. (2018). New dimension spectra: finer information on scaling and homogeneity. *Adv. Math.*, 329:273–328.
- [26] Geyer, L. (1999). Porosity of parabolic julia sets. *Complex Variables Theory Appl.*, 39(3):191–198.
- [27] Hare, K. E. and Troscheit, S. (2019). Lower Assouad dimension of measures and regularity. *Math. Proc. Camb. Philos. Soc.*, to appear, available at: <https://arxiv.org/abs/1812.05573>.
- [28] Käenmäki, A. and Lehrbäck, J. (2017). Measures with predetermined regularity and inhomogeneous self-similar sets. *Ark. Mat.*, 55(1):165–184.
- [29] Käenmäki, A., Lehrbäck, J., and Vuorinen, M. (2013). Dimensions, Whitney covers, and tubular neighborhoods. *Indiana Univ. Math. J.*, 62(6):1861–1889.
- [30] Lei, T. (Ed.). (2000). *The Mandelbrot set, theme and variations*, volume 274 of *London Mathematical Society Lecture Note Series*. Cambridge University Press, Cambridge.
- [31] Lü, F. and Xi, L.-F. (2016). Quasi-Assouad dimension of fractals. *J. Fractal Geom.*, 3:187–215.
- [32] Luukkainen, J. (1998). Assouad dimension: antifractal metrization, porous sets, and homogeneous measures. *J. Korean Math. Soc.*, 35(1):23–76.
- [33] Mackay, J. M. and Tyson, J. T. (2010). *Conformal dimension: Theory and application*, volume 54 of *University Lecture Series*. American Mathematical Society.
- [34] Manning, A. and McCluskey, H. (1993). Hausdorff dimension for horseshoes. *J. Funct. Anal.*, 113(2):245–317.

- [35] Maskit, B. (1988). *Kleinian groups*, volume 287 of *Grundlehren der Mathematischen Wissenschaften*. Springer Verlag, Berlin.
- [36] Mattila, P. (1995). *Geometry of Sets and Measures in Euclidean Spaces: Fractals and Rectifiability*, volume 44 of *Cambridge Studies in Advanced Mathematics*. Cambridge University Press.
- [37] McMullen, C. T. (1995). The classification of conformal dynamical systems. *Curr. Dev. Math.*, 1995(1):323–360.
- [38] McMullen, C. T. (2000). Hausdorff dimension and conformal dynamics ii: Geometrically finite rational maps. *Comm. Math. Helv.*, 75(4):535–593.
- [39] McMullen, C. T. (2008). Thermodynamics, dimension and the Weil-Petersson metric. *Invent. Math.*, 173:365–245.
- [40] Milnor, J. (2006). *Dynamics in one complex variable*, volume 160 of *Annals of Mathematics Studies*. Princeton University Press, Princeton, NJ, 3rd edition.
- [41] Patterson, S. J. (1976). The limit set of a Fuchsian group. *Acta Math.*, 136:241–273.
- [42] Robinson, J. C. (2011). *Dimensions, Embeddings, and Attractors*, volume 186 of *Tracts in Mathematics*. Cambridge University Press.
- [43] Roos, J. and Seeger, A. (2020). Spherical maximal functions and fractal dimensions of dilation sets. preprint, available at: <https://arxiv.org/abs/2004.00984>.
- [44] Stratmann, B. O. and Urbański, M. (1996). The box-counting dimension for geometrically finite Kleinian groups. *Fund. Math.*, 149(1):83–93.
- [45] Stratmann, B. O. and Urbański, M. (2000). The geometry of conformal measures for parabolic rational maps. *Math. Proc. Camb. Philos. Soc.*, 128(1):141–156.
- [46] Stratmann, B. O. and Urbański, M. (2002). Jarník and Julia; a Diophantine analysis for parabolic rational maps for geometrically finite Kleinian groups with parabolic elements. *Math. Scan.*, 91:27–54.
- [47] Stratmann, B. O. and Velani, S. L. (1995). The Patterson measure for geometrically finite groups with parabolic elements, new and old. *Proc. Lond. Math. Soc.*, 3(1):197–220.
- [48] Sullivan, D. (1984). Entropy, Hausdorff measures old and new, and limit sets of geometrically finite Kleinian groups. *Acta Math.*, 153:259–277.
- [49] Sullivan, D. (1985). Quasiconformal homeomorphisms and dynamics I. Solution of the Fatou-Julia problem on wandering domains. *Ann. Math.*, 122(2):401–418.
- [50] Tukia, P. (1984). The Hausdorff dimension of the limit set of a geometrically finite Kleinian group. *Acta Math.*, 152:127–140.