

Parameterized Complexity of Scheduling Chains of Jobs with Delays

Hans L. Bodlaender 

Department of Information and Computing Sciences, Utrecht University, the Netherlands
H.L.Bodlaender@uu.nl

Marieke van der Wegen 

Department of Information and Computing Sciences, Utrecht University, the Netherlands
Mathematical Institute, Utrecht University, the Netherlands
M.vanderWegen@uu.nl

Abstract

In this paper, we consider the parameterized complexity of the following scheduling problem. We must schedule a number of jobs on m machines, where each job has unit length, and the graph of precedence constraints consists of a set of chains. Each precedence constraint is labelled with an integer that denotes the exact (or minimum) delay between the jobs. We study different cases; delays can be given in unary and in binary, and the case that we have a single machine is discussed separately. We consider the complexity of this problem parameterized by the number of chains, and by the thickness of the instance, which is the maximum number of chains whose intervals between release date and deadline overlap.

We show that this scheduling problem with exact delays in unary is $W[t]$ -hard for all t , when parameterized by the thickness, even when we have a single machine ($m = 1$). When parameterized by the number of chains, this problem is $W[1]$ -complete when we have a single or a constant number of machines, and $W[2]$ -complete when the number of machines is a variable. The problem with minimum delays, given in unary, parameterized by the number of chains (and as a simple corollary, also when parameterized by the thickness) is $W[1]$ -hard for a single or a constant number of machines, and $W[2]$ -hard when the number of machines is variable.

With a dynamic programming algorithm, one can show membership in XP for exact and minimum delays in unary, for any number of machines, when parameterized by thickness or number of chains. For a single machine, with exact delays in binary, parameterized by the number of chains, membership in XP can be shown with branching and solving a system of difference constraints. For all other cases for delays in binary, membership in XP is open.

2012 ACM Subject Classification Computing methodologies → Planning and scheduling; Theory of computation → Fixed parameter tractability; Theory of computation → Parameterized complexity and exact algorithms

Keywords and phrases Scheduling, parameterized complexity

Acknowledgements We would like to thank Sukanya Pandey for helpful discussions.

1 Introduction

In this paper, we study a problem in the field of parameterized complexity of scheduling problems. Here, we look at scheduling jobs with precedence constraints with exact or minimum delays, and assume that jobs have unit length. We study one of the simplest types of precedence constraint graphs: we assume that the precedences form a collection of disjoint chains. Chains have a release date and deadline. It is not hard to see (by a simple reduction from 3-PARTITION) that this problem is NP-hard, even when all delays are 0. In this paper, we study the parameterized complexity of the problem, and look at two different parameters: the number of chains, and the thickness of the instance — that is, the maximum number of chains that have overlapping intervals from release time to deadline. We look at different variants: a constraint gives an exact bound or a lower bound on the delay between successive jobs; we can have one, a constant, or a variable number of machines, and the delays can be given in unary or binary notation. If delays are given in unary, then each of the studied variants belongs to XP, and is hard for $W[1]$ (or classes higher in the W -hierarchy.) For one variation (see below), we also show membership in XP when delays are given in binary. We call the studied problems CHAIN SCHEDULING WITH EXACT DELAYS and CHAIN SCHEDULING WITH MINIMUM DELAYS, for details see Section 2.

1.1 Related literature.

Looking at variants of scheduling problems with special attention to parameters (like the number of available machines) is a common approach in the rich field of study of scheduling problems. Studying such parameterizations using techniques and terminology from the field of parameterized algorithms and complexity was pioneered in 1995 [3], but recently receives growing attention, e.g. [2, 10, 12].

The scheduling of chains of jobs (without delays) was studied by Woeginger [14] and Bruckner [4], who gave respectively a 2-approximation algorithm, and a linear time algorithm for two machines. General precedence graphs with delays between jobs was studied already in 1992 by Wikum et al. [13]; this was followed by a large body of literature, studying different variations and approaches, including theoretical and experimental studies.

1.2 A different interpretation

The problem we studied can also be interpreted as another type of scheduling problem. Now, we let each chain represent *one* job: this job only occasionally needs to use the machine (or some specific resource) — at the other time steps, the job is running but does not need a resource. E.g., if we have a chain with delays 2 and 3, then, we can interpret this as a job that needs a resource at its first, fourth, and eighth time step. The variant with minimum delays now has as interpretation that we allow pre-emption, i.e., jobs can be halted at some time steps and resumed later.

1.3 Our results

In this paper, we give a number of hardness results, which are summarized in Table 1. All variants are already hard when the (exact or minimum) delays are given in unary. We also give the following algorithmic results:

- With a dynamic programming algorithm, one can show that the CHAIN SCHEDULING WITH EXACT DELAYS and CHAIN SCHEDULING WITH MINIMUM DELAYS belong to XP,

	parameter	exact delays	minimum delays
Single machine	thickness	$W[t]$ -hard for all t	$W[1]$ -hard
	chains	$W[1]$ -complete	$W[1]$ -hard
Constant number of machines	thickness	$W[t]$ -hard for all t	$W[1]$ -hard
	chains	$W[1]$ -complete	$W[1]$ -hard
Variable number of machines	thickness	$W[t]$ -hard for all t	$W[2]$ -hard
	chains	$W[2]$ -complete	$W[2]$ -hard

■ **Table 1** Hardness results for different variants of the problem. Exact and minimum delays are given in unary.

when delays are given in unary, and parameterized by either thickness or number of chains, for any number of machines.

- Combining branching with solving a set of difference constraints shows XP-membership of CHAIN SCHEDULING WITH EXACT DELAYS when parameterized by number of chains, for the case of one machines, when delays are given in binary.

For all other cases, the membership in XP when delays are given in binary is open.

1.4 Organization of this paper

In Section 2, we give a number of preliminary definitions. Section 3 gives hardness proofs for CHAIN SCHEDULING WITH EXACT DELAYS when parameterized by the thickness. The complexity of CHAIN SCHEDULING WITH EXACT DELAYS parameterized by the number of chains is established in Section 4; a relatively simple modification then gives hardness for the corresponding problems with minimum delays. Section 5 gives our algorithmic results (membership in XP). Some conclusions are given in Section 6.

2 Preliminaries

We first describe the problems we study in more details. We have a number of identical machines m . In the paper, we study separately the cases that we have a single machine ($m = 1$), the number of machines is some fixed constant, or the number of machines is variable.

On these machines, we must schedule n jobs. Each job has unit length. On the set of jobs, we have a collection of precedence constraints. Each precedence constraint is an ordered pair of jobs (i, i') : it tells that job i' cannot be started before job i is completed. We say that i is a *direct predecessor* of i' , and i is a *predecessor* of i' if there is a directed path from i to i' in the graph formed by the precedence constraints; i' then is a *successor* of i .

The precedence constraints have associated with them a *delay*, denoted $l_{i,i'}$: each delay is a non-negative integer. We study two variations of the problem: exact delays and minimum delays. If we consider exact (resp. minimum) delays, then if constraint (i, i') has delay $l_{i,i'}$ then job i' must be started exactly (resp. at least) $l_{i,i'}$ time steps after job i was finished. That is: when job i starts at time t , then job i' starts at time exactly (resp. at least) $t + l_{i,i'} + 1$. (Note that jobs run directly after each other, only if the delay is 0.) It is allowed to schedule a job on a different machine than its predecessor — thus, we do not need to specify on what machine a job is running, but only ensure that at each time step, the number of scheduled jobs is at most the number of available machines.

In this paper, we consider the case that the graph of the precedence constraints consists of a set of chains. I.e., each job has at most one direct predecessor and at most one direct successor. Chains are the maximal sets of jobs that are predecessors or successors of each other.

Each chain C has a *release date* r_C and a *deadline* d_C . We have that the first job in the chain cannot start before time r_C and the last job in the chain should be completed at or before time d_C .

In this paper, we consider the following two parameterizations of the problem. The first is the number of chains, denoted by c . The second is the *thickness*, denoted by τ , defined as follows. We say that two chains *overlap*, when their intervals $[r_C, d_C)$ have a non-empty intersection. We define the thickness τ to be the maximum size of a collection of chains that mutually overlap. That is, for any time t , there are at most τ chains C for which we have that $r_C \leq t$ and $d_C > t$.

CHAIN SCHEDULING WITH EXACT DELAYS is the problem where we are given as input the set of jobs with chains of precedence constraints, delays for each precedence constraint, release dates and deadlines of chains, and number of machines, and ask whether there exists a schedule that fulfills all the demands: at each time step, the number of jobs scheduled is at most the number of machines; jobs in a chain are not scheduled before the release date or after the deadline, and for each precedence constraint (i, i') the delay between i and i' is exactly $l_{i,i'}$.

As said, we study several variants of this problem: delays can be given in unary or binary, the number of machines can be 1, fixed or variable, and we can parameterize by the number of chains or by thickness. If we require that the stated delays are lower bounds, we obtain the CHAIN SCHEDULING WITH MINIMUM DELAYS problem: here, when we have a precedence constraint (i, i') with delay $l_{i,i'}$, we must have that job i' starts at least $l_{i,i'}$ time steps after job i is finished.

For the $W[t]$ -hardness proofs, we use reductions from the following version of the SATISFIABILITY problem. A Boolean formula is said to be *t-normalized*, if it is the conjunction of the disjunction of the conjunction of \dots of literals, with t alternations of AND's and OR's.

The following parameterized problem was considered by Downey and Fellows [6].

WEIGHTED t -NORMALIZED SATISFIABILITY

Given: A t -normalized Boolean formula F and a positive integer $k \in \mathbb{N}$.

Parameter: k

Question: Can F be satisfied by setting exactly k variables to true?

► **Theorem 2.1** (Downey and Fellows [6, 7]). *For every $t \geq 2$, WEIGHTED t -NORMALIZED SATISFIABILITY is $W[t]$ -complete.*

For the $W[1]$ - and $W[2]$ -completeness results, we use reductions from INDEPENDENT SET and DOMINATING SET. It is known that INDEPENDENT SET is $W[1]$ -complete [7] and DOMINATING SET is $W[2]$ -complete [6].

3 Parameterization by thickness

In this section, we look at the CHAIN SCHEDULING WITH EXACT DELAYS problem, when parameterized by the thickness τ . We will show, for several variations, that the problem is hard for the class $W[t]$, for all integers t .

3.1 Parallel machines

We consider the version with m parallel machines, where m is part of the input. The delays are assumed to be exact.

We will give a reduction from WEIGHTED t -NORMALIZED SATISFIABILITY. Assume we have a t -normalized Boolean formula F and integer k . Let t' be the number of ‘levels’ of disjunction. We assume the variables of F to be x_0, \dots, x_{n-1} .

We make an instance of the CHAIN SCHEDULING WITH EXACT DELAYS problem, with $m = k + t'$ machines and thickness $\tau = 2k + t'$.

An *element* of the formula is either a literal, or a disjunction or conjunction of smaller elements. We will first assign to each element a size s , and then to each element an integer interval. To each element, we associate an *interval size*; the interval size of formula F' is denoted by $s(F')$.

The *interval size* of a literal (i.e., a formula of the form x_i or $\neg x_i$) is $2n$. The interval size of a conjunction is the sum of the size of the terms, i.e., $s(F_1 \wedge F_2 \wedge \dots \wedge F_q) = \sum_{i=1}^q s(F_i)$. For each disjunction F' of q terms, its size is $2q + 1$ times the maximum size of its terms: define $s_{\max}(F') = \max_{1 \leq i \leq q} s(F_i)$, and then $s(F_1 \vee F_2 \vee \dots \vee F_q) = (2q + 1) \cdot s_{\max}(F')$.

To each element F' of F we assign an integer interval $[\ell(F'), r(F')]$ with $s(F') = r(F') - \ell(F')$. We will do this top-down: first we assign an interval to F , then we define a subinterval for every term of F , etc.

To F , we assign the interval $[n, n + s(F)]$. To elements of a conjunction and disjunction, we assign subintervals of the intervals assigned to the conjunction or disjunction, in such a way that these intervals have the same nesting as the elements in the formula.

Consider an element F' that is the conjunction $F_1 \wedge F_2 \wedge \dots \wedge F_s$. Then assign F_1 the interval $[\ell(F'), \ell(F') + s(F_1)]$; F_2 the interval $[\ell(F') + s(F_1), \ell(F') + s(F_1) + s(F_2)]$, etc. I.e., F_i is assigned the interval $[\ell(F') + \sum_{j=1}^{i-1} s(F_j), \ell(F') + \sum_{j=1}^i s(F_j)]$.

Suppose element F' is the disjunction $F_1 \vee F_2 \vee \dots \vee F_s$. The construction is similar to that of conjunctions, but now we assign each term the same length interval and keep unused intervals between the terms. Recall that $s_{\max}(F') = \max_{1 \leq i \leq s} s(F_i)$. Assign to F_i the interval $[\ell(F') + (2i - 1) \cdot s_{\max}(F'), \ell(F') + 2i \cdot s_{\max}(F')]$.

Note the nesting of intervals, and that we assigned to each element an interval equal to its size. Also note that we can compute all intervals and sizes in polynomial time.

We now can describe the jobs, precedence constraints and release dates and deadlines.

For each i , $1 \leq i \leq k$, we start a chain c_i . Each of those chains start with a job and then a delay of $n - 1$. The first job of the chain is released at time 0. We will add jobs and specify delays between jobs in the chain such that the total processing time including the delay times is $n + s(F) + 1$. Set the deadline of those chains to $2n + s(F)$, so that the first job can start at times $0, 1, \dots, n - 1$.

These chains reflect the variables that are set to true; more precisely, when the first job of one of the chains starts at a time i , then this corresponds to setting x_i to true. We call these the *true variable chains*.

To prevent two chains selecting the same variable, we add $m - 1$ chains, each with n jobs with delay 0, release date 0 and deadline n . We call those chains *fill chains*. Those chains have to be scheduled from time 0 until time n . This implies that at each time $0, 1, \dots, n - 1$ at most one other job can be scheduled, thus at most one true variable chain starts. Hence, the true variable chains select exactly k variable to be set to true.

We will now extend the true variable chains. Consider the interval $[n, n + s(F)]$ from left to right.

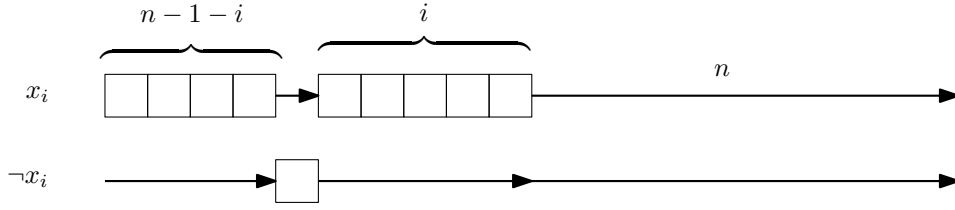

■ **Figure 1** The variable gadgets.

- For each timestep that we encounter that is not part of an interval that corresponds to a literal, we add a delay of 1 at the end of the chain.
- For each interval $[\ell(F'), r(F')]$ that corresponds to a positive literal x_i , we add the following gadget to the chain: $n - 1 - i$ jobs with delay 0, then a delay of 1, then i jobs with delay 0 and then a delay of n . (See Figure 1.) Notice that no job is scheduled from $\ell(F') + n - 1$ until $\ell(F') + n$ if the chain starts at time i , and there is a job scheduled at this time otherwise.
- For each element F' of F that is a negative literal $\neg x_i$, we make the following gadget: a delay of $n - 1 - i$, a job, then a delay of i , and then a delay of n . (See Figure 1.) Notice that a job is scheduled from $\ell(F') + n - 1$ until $\ell(F') + n$ if the chain starts at time i , and there is no job scheduled at this time otherwise.

Add one job at the end of the chain. Notice that the total processing time of those chains is indeed $n + s(F) + 1$.

To check whether variables are true, we add some chains that consist of a single job. We call those chains *variable check chains*.

- For each element F' of F that consists of a single positive literal (i.e., is of the form x_i), we make a chain with one job, that is released at time $\ell(F') + n - 1$ and has deadline $\ell(F') + n$.
- For element F' of F that consists of a single negative literal (i.e., is of the form $\neg x_i$), we make a k chains with one job, release date $\ell(F') + n - 1$ and deadline $\ell(F') + n$.

The intuition behind this construction is as follows: suppose that we have k machines. For each element F' of F that is of the form x_i , there is one job scheduled from $\ell(F') + n - 1$ until $\ell(F') + n$. So for at least one of the true variable chains, we need that no job of this chain to be scheduled from $\ell(F') + n - 1$ until $\ell(F') + n$. This means that one of the true variable chains starts at time i . For each element F' of F that is of the form $\neg x_i$, there are k job scheduled from $\ell(F') + n - 1$ until $\ell(F') + n$. So for none of the true variable chains we can schedule a job of this chain from $\ell(F') + n - 1$ until $\ell(F') + n$. This means that none of the true variable chains starts at time i . The other t' machines take care of the disjunctions.

For each element $F' = F_1 \vee F_2 \vee \dots \vee F_q$ of F that is a disjunction, we make one chain. This chain has $3 \cdot s_{\max}(F')$ jobs with delay 0. The chain will be released at time $\ell(F')$ and has deadline $r(F')$. We call those chains *disjunction chains*. Notice that for every element F' of F that is a literal, there are exactly t' disjunction chains that overlap the interval $[\ell(F'), r(F')]$, that is, there are exactly t' disjunction chains C with release time at most $\ell(F')$ and deadline at least $r(F')$.

We now have specified all jobs and the machines they run on. Note that the thickness of this construction is $2k + t'$.

▷ **Claim 3.1.** If F is satisfiable by setting exactly k variables to true, then the CHAIN SCHEDULING WITH EXACT DELAYS scheduling problem has a solution.

Proof. Suppose F is satisfiable by making variables x_{i_1}, \dots, x_{i_k} true. For each j , with $1 \leq j \leq k$, we let one true variable chain start at time i_j .

First we introduce a notion *satisfying*, intuitively, this will be the elements that make F true. We define this top-down. First we call F satisfying. For each element F' of F :

- If F' is satisfying and F' is a conjunction $F' = F_1 \wedge \dots \wedge F_q$, then all terms F_i are satisfying.
- If F' is satisfying and F' is a disjunction $F' = F_1 \vee \dots \vee F_q$, then at least one F_i is satisfied, say F_j . We say that F_j is satisfying, and the other term F_i with $i \neq j$ are not satisfying.
- If F' is not satisfying, all its terms are not satisfying.

For each element F' of F that is a disjunction $F' = F_1 \vee \dots \vee F_q$, consider the disjunction chain C associated with this element. If F' is not satisfying, then start this chain C arbitrarily, say at its release time. If F' is satisfying, let F_j be its term that is satisfying. Now, start this chain C at time $\ell(F') + (2j - 2)s_{\max}(F')$, where $s_{\max}(F')$ is again the maximum interval size of the terms F_i .

Now we will verify that is a feasible schedule, that is, that we never use more than m machines.

First consider a time step α from i to $i + 1$, with $0 \leq i \leq n - 1$. At this time step there are $m - 1$ jobs of fill chains scheduled. Since the variables x_{i_1}, \dots, x_{i_k} are different, the true variable chains start at different times. Hence, there is at most one job of a true variable chain scheduled at α . Thus, there are at most m jobs scheduled at time α .

Consider a time step α from i to $i + 1$ with $i \geq n$, such that $i \neq \ell(F') + n - 1$ for all elements F' of F that are literals. Notice that at those times no jobs of fill chains and variable check chains are scheduled. There are at most k jobs of true variable chains scheduled at time step α , since there are only k true variable chains. And there are at most t' jobs of disjunction chains scheduled, since there are t' levels of disjunction. It follows that there are at most $k + t' = m$ jobs scheduled at time step α .

Consider a time step α from i to $i + 1$ with $i \geq n$, such that $i = \ell(F') + n - 1$ for an element F' of F that is a literal. We distinguish three cases.

Suppose that F' is satisfying, and F' is a positive literal $F' = x_j$. Then we know that there are t' machines used for the disjunction chains. Besides, there is one machine used for the variable check chains. Since we know that F' is satisfying, x_j is true. Thus one of the true variable chains starts at time j . So this chain has no job scheduled from i until $i + 1$. So at most $k - 1$ true variable chains have a job scheduled from i until $i + 1$. In total there are at most $t' + 1 + k - 1 = m$ machines used.

Suppose that F' is satisfying, and F' is a negative literal, say $F' = \neg x_j$. Then we know that there are t' machines used for the disjunction chains. There are k machines used for the variable check chains. Since we know that F' is satisfying, x_j is false. Thus none of the true variable chains starts at time j . Hence, no true variable chain has a job scheduled from i until $i + 1$. In total there are at most m machines used from i until $i + 1$.

Suppose that F' is not satisfying. Let F'' be the last satisfying element on the path from F to F' . The disjunction chain that corresponds to F'' has no job that is scheduled from i until $i + 1$. Hence, there are at most $t' - 1$ machines used for the disjunction chains from time i until $i + 1$. It follows that there are $k + 1$ machines for the true variable chains and the variable check chains. Since all true variable chains start at different times, those chains together have $k + 1$ jobs that can be scheduled from i until $i + 1$. We conclude that we used at most m machines from time i until $i + 1$. ◀

▷ **Claim 3.2.** Suppose the CHAIN SCHEDULING WITH EXACT DELAYS scheduling problem has a solution, then F can be satisfied by setting exactly k variables to true.

Proof. For each true variable chain, if it starts at time i , then set x_i to true. All other variables are set to false, i.e., x_i is true, if and only if there is a true variable chain that starts at time i .

Note that all variable chains must start at different times, and they must start at times $0, 1, \dots, n-1$. If two of these start at the same time i , then both have a job scheduled from i until $i+1$, but there are $m-1$ fill chains that have a job scheduled from i until $i+1$ as well, which is a contradiction with the total number of machines. Thus, we have set exactly k variables to true.

We claim that this setting makes F true. We define elements of F to be *demonstrated* in the following way, recursively. We say that F is demonstrated.

- If a conjunction is demonstrated, then all its terms are demonstrated.
- If a disjunction $F' = F_1 \vee \dots \vee F_q$ is demonstrated, then we consider the corresponding disjunction chain C . If for every time step in $[l(F_j), r(F_j)]$ a job of C is scheduled, we say that F_j is demonstrated.

After this top-down definition of demonstrated elements, we will now inductively show bottom-up that demonstrated elements are satisfied by the setting of variables described above.

Consider a demonstrated element F' that is a literal. By the definition of demonstrated, t' of the disjunction chains have a job scheduled at each time step of $[l(F'), r(F')]$. Consider the time step from $l(F') + n - 1$ until $l(F') + n$. We know that t' machines process a job of a disjunction chain at this time step, so at most k machines process jobs of true variable chains and variable check chains.

Suppose that F' is a positive literal, say x_i . Notice that one machine processes a check variable chain from $l(F') + n - 1$ until $l(F') + n$. So at most $k-1$ machines process a job of a true variable chain. Hence there must be at least one true variable chain that does not have a job scheduled at this time. By construction of the true variable chains, such a chain must start at time i ; and thus we set x_i to true, i.e., our setting satisfies the formula consisting of the single positive literal x_i .

If F' is a negative literal $\neg x_i$, k machines are processing check variable chains from $l(F') + n - 1$ until $l(F') + n$; thus no true variable chain can have a job scheduled at this step. By construction of the true variable chains, this implies that no true variable chain starts at time i , and thus x_i is set to false. Hence, F' is satisfied.

Now consider a demonstrated element F' and assume, by induction, that for all its terms F_i holds: if F_i is demonstrated, then F_i is true.

Suppose that F' that is a conjunction. All its terms are demonstrated, and by the induction hypothesis, all its terms are true. Thus the conjunction is also true.

Suppose that F' is a disjunction. Since the corresponding disjunction chain has length $3s_{\max}(F')$, there is at least one F_j such that for every time step in $[l(F_j), r(F_j)]$ a job of C is scheduled. By definition, this F_j is demonstrated. By induction, F_j is true, and thus F' is true.

We conclude that F is satisfied. ◀

We now have shown:

► **Theorem 3.3.** *The CHAIN SCHEDULING WITH EXACT DELAYS problem, parameterized by the thickness τ , is $W[t]$ -complete for all $t \in \mathbb{N}$.*

3.2 Single machine

Again, assume the delays are exact. We now show that the problem stays hard when there is only one machine.

► **Theorem 3.4.** *The CHAIN SCHEDULING WITH EXACT DELAYS problem, parameterized by the thickness τ , is $W[t]$ -complete for all $t \in \mathbb{N}$, when only 1 machine is available.*

Let τ be the thickness of the original instance. The main idea of the transformation is to replace each time step on m machines by τ time steps on a single machine. Every chain will be assigned a number $i \in \{0, 1, \dots, \tau - 1\}$ and its jobs will be scheduled at times $i \pmod{\tau}$, this will make sure that at every timestep only one job is scheduled. For every interval $[i\tau, (i+1)\tau]$, we will have $\tau - m$ chains that have one job; this ensures that at at most m time steps of the interval a job of a regular chain is scheduled. We now proceed with the formal description.

We transform from the case with m machines (Theorem 3.3). Suppose we have an instance with m machines. For every interval $[i\tau, (i+1)\tau]$, we add $\tau - m$ additional chains, with a single job, release date $i\tau$ and deadline $(i+1)\tau$. We call those chains *extra*.

We copy the chains from the given instance, except that:

- If a chain has release date α , then it now has release date $\alpha \cdot \tau$.
- If a chain has deadline β , then it now has deadline $\beta \cdot \tau$.
- Every delay d is replaced by a delay $\tau d + \tau - 1$.

We call these chains *regular*.

▷ **Claim 3.5.** Suppose we have a solution for the transformed instance with one machine. Then we have a solution for the original instance with m machines.

Proof. For each regular chain, let it start at time $\lfloor t/\tau \rfloor$, when its transformed instance starts at time t . This implies that for every job in the chain it will start at time $\lfloor t/\tau \rfloor$, when its transformed instance starts at time t . We know that for each time interval $[t\tau, (t+1)\tau]$, $\tau - m$ steps are used for extra jobs, so m time steps are available for jobs of regular chains. Thus, at every time step t in the original instance, at most m jobs are scheduled. ◀

▷ **Claim 3.6.** Suppose we have a solution for the original instance with m machines. Then we have a solution for the transformed instance with 1 machine.

Proof. We start with assigning a number $0, 1, \dots, \tau - 1$ to every chain such that for every time step all the chains that overlap this time step have different number. We denote this assignment by c . We can do this as follows: go through time $0, 1, 2, \dots$, and every time a chain is released, assign a number that is currently unused, if a deadline passes, the number of the corresponding chain becomes available again. We can do this with τ numbers, since by definition for every timestep there are at most τ chains that overlap this timestep.

For every regular chain C , let C start at time $t\tau + c(C)$, where t is the starting time of the corresponding original chain. Then chains of thickness number i only have jobs starting at times t with $t \equiv i \pmod{\tau}$. For every time t , all jobs that are scheduled to start at time t in the original instance, will now be scheduled in the interval $[t\tau, (t+1)\tau]$ in the transformed instance. Those jobs are in different chains and those chains are assigned different numbers. Thus those jobs are scheduled at different times in the transformed instance.

In the original instance, at each time t at most m chains have a job scheduled to start at t , so, in the transformed instance, for each interval $[t\tau, (t+1)\tau]$, at most m regular chains have a job scheduled in this interval. Thus, we can schedule the $\tau - m$ extra chains in this time interval at the time steps where no job of a regular chain is scheduled. ◀

As the transformation can be carried out in polynomial time, Theorem 3.4 follows from the transformation and Theorem 3.3.

3.3 Constant number of parallel machines

We can easily transform the single machine instance to an instance with a constant number m of parallel machines. Let T be the maximum deadline of all chains. Introduce $m - 1$ new chains with T jobs each and 0 delays. The $m - 1$ new machines will be processing those $m - 1$ new chains, while the original machine processes the original chains. We conclude the following result.

► **Theorem 3.7.** *The CHAIN SCHEDULING WITH EXACT DELAYS problem with a fixed number of machines, parameterized by the thickness τ , is $W[t]$ -complete for all $t \in \mathbb{N}$.*

3.4 Minimum delays

The proof above seems not to be modifiable to the CHAIN SCHEDULING WITH MINIMUM DELAYS problem. In Section 4.4, we show that CHAIN SCHEDULING WITH MINIMUM DELAYS, parameterized by the number of chains is $W[1]$ -hard when $m = 1$, and $W[2]$ -hard when the number of machines m is variable. As the thickness is at most the number of chains, it follows that CHAIN SCHEDULING WITH MINIMUM DELAYS, parameterized by the thickness is $W[1]$ -hard for one machine, and $W[2]$ -hard for a variable number of machines. Membership in $W[1]$ or $W[2]$ is open, however.

4 Parameterization by the number of chains

We now give the complexity results when we use the number of chains as parameter. In Sections 4.1, 4.2, and 4.3, we consider CHAIN SCHEDULING WITH EXACT DELAYS, with the number of machines respectively 1, a constant, or variable. In Section 4.4, we consider CHAIN SCHEDULING WITH EXACT DELAYS.

4.1 Single machine

In this section, we consider the variant where the number of chains c is a parameter, and at each step in time, there is one machine available. We assume that the delays are exact.

► **Theorem 4.1.** *The CHAIN SCHEDULING WITH EXACT DELAYS problem, parameterized by the number of chains c is $W[1]$ -complete, when there is one machine.*

Theorem 4.1 is proven by two transformations: from and to INDEPENDENT SET with standard parameterization.

► **Lemma 4.2.** *The CHAIN SCHEDULING WITH EXACT DELAYS problem with one machine, parameterized by the number of chains c , is $W[1]$ -hard.*

Proof. A set of integers S is said to be a *Golomb ruler* if all differences $a - b$ of two elements $a, b \in S$ are unique, that is, $s_1 - s_2 \neq s_3 - s_4$ for $s_1, s_2, s_3, s_4 \in S$ with $s_1 \neq s_2$ and $s_3 \neq s_4$.

Erdős and Turán [9] gave the following explicit construction of a Golomb ruler. Let $p > 2$ be a prime number. Then the set $\{2pk + (k^2 \bmod p) \mid k \in \{0, 1, \dots, p - 1\}\}$ is a Golomb ruler with p elements. We can build a Golomb ruler of size n in $O(n\sqrt{n})$ time: with help of the Sieve of Eratosthenes, we find a prime number p between n and $2n$ (such a number always exist, by the classic postulate of Bertrand (see [1]), and then follow the

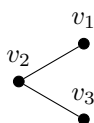

■ **Figure 2** An example graph G . If we pick $p = 3$, the corresponding Golomb ruler is $\{0, 7, 13\}$.

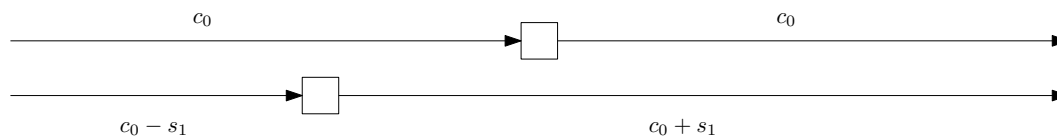

■ **Figure 3** The part of the chains C_a and C_b for the interval I_{v_1, v_2, C_a, C_b} for the graph in Figure 2.

Erdős-Turán-construction with this value of p , and take the first n elements of this set. Notice that the elements in this set are smaller than $4n^2$.

Suppose we have an input of INDEPENDENT SET $G = (V, E)$ and k . Assume $V = \{v_1, \dots, v_n\}$ and let m be the number of edges. First, build a Golomb ruler S^n of size n . Denote the elements by $s_0 \leq s_1 \leq \dots \leq s_{n-1}$. Notice that $s_0 = 0$. Write $c_0 = s_{n-1} + 1$.

We will construct an instance of CHAIN SCHEDULING WITH EXACT DELAYS. We will make $k + 1$ chains. We call one chain the *start time forcing chain*, the other k chains are the *vertex selection chains*.

The start time forcing chain has release date 1, deadline c_0 and total execution time (including delays) $c_0 - 1$. I.e., it must start at time 1. The chain will have a job starting at every time in $[1, c_0 - 1]$ except the times s_1, s_2, \dots, s_{n-1} .

The vertex selection chains have release date 0. They have deadline $c_0 + T - 1$ and total execution time T , where $T = (m \cdot k(k - 1))(2c_0 + 1) + 1$. So, they can start at times $0, 1, \dots, c_0 - 1$. The vertex selection chains start with a job and then a delay of $c_0 - 1$. Note that as a result of this, in order not to conflict with the start time forcing chain, they have to start at an element of S^n .

Now, for each edge $\{v_i, v_j\} \in E$, and each ordered pair of vertex selection chains C_a, C_b with $a, b \in \{1, 2, \dots, k\}$ we dedicate an interval I_{v_i, v_j, C_a, C_b} of $2c_0 + 1$ time steps. More precisely, we have $m \cdot k(k - 1)$ intervals $[c_0 + i(2c_0 + 1), c_0 + (i + 1)(2c_0 + 1)]$ for $i = 0, 1, \dots, m \cdot k(k - 1) - 1$. And to each interval we assign a unique label I_{v_i, v_j, C_a, C_b} where $v_i v_j \in E$ and $a, b \in \{1, 2, \dots, k\}$. In the interval I_{v_i, v_j, C_a, C_b} we will check whether the chains C_a and C_b did not select the edge $v_i v_j$, that is, whether C_a does not start at s_i or C_b does not start at s_j .

We will now extend the vertex selection chains. Consider the interval $[c_0, c_0 + c_0 + (m \cdot k(k - 1))(2c_0 + 1)]$ from left to right. For each interval I_{v_i, v_j, C_a, C_b} that we encounter, we extend the vertex selection chains as follows.

- For each chain C , with $C \neq C_a, C \neq C_b$, add a delay of $2c_0 + 1$.
- Add the following gadget to the chain C_a : a delay of $c_0 - s_i$, a job, and then a delay if $c_0 + s_i$.
- Add the following gadget to the chain C_b : a delay of $c_0 - s_j$, a job, and then a delay if $c_0 + s_j$.

Add one job at the end of all chains. See Figures 2, 3 and 4 for an example of the construction and a feasible schedule.

We claim that there is a feasible schedule, if and only if G has an independent set of size at least k .

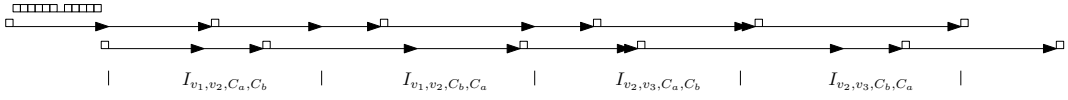

■ **Figure 4** The instance of the scheduling problem constructed from the graph in Figure 2 and $k = 2$.

▷ **Claim 4.3.** If G has an independent set of size at least k , then there is a feasible schedule.

Proof. Suppose v_{i_1}, \dots, v_{i_k} form an independent set in G . Let the vertex selection chain C_a start at times s_{i_a} for $a = 1, 2, \dots, k$.

Notice that for the first c_0 time steps, at most one resource is used. The same holds for the last c_0 time steps. We show that this is a feasible scheduling by contradiction. Suppose that there are two resources needed at some time step β , and that β is in the interval $I = I_{v_i, v_j, C_a, C_b}$ for checking whether the chains C_a and C_b do not select the edge $v_i v_j$. Write $I = [\ell(I), r(I)]$. Notice that job of C_a in the interval I starts at time $\ell(I) + c_0 - s_i + s_{i_a}$. And the job of C_b in the interval I starts at time $\ell(I) + c_0 - s_j + s_{i_b}$. Thus $\ell(I) + c_0 - s_i + s_{i_a} = \beta = \ell(I) + c_0 - s_j + s_{i_b}$. Equivalently, $s_{i_a} - s_i = s_{i_b} - s_j$. Since S^n is a Golomb ruler, it follows that either $s_{i_a} = s_i$ and $s_{i_b} = s_j$ or $s_{i_a} = s_{i_b}$ and $s_i = s_j$.

In the first case, $s_{i_a} = s_i$ and $s_{i_b} = s_j$, we see that $v_i = v_{i_a}$ and $v_j = v_{i_b}$. But there is no edge $v_{i_a} v_{i_b}$, since v_{i_a} and v_{i_b} are in an independent set. This yields a contradiction.

In the second case, $s_{i_a} = s_{i_b}$ and $s_i = s_j$, we see that $v_{i_a} = v_{i_b}$, but this yields a contradiction with the fact that the vertices of the independent set are distinct.

We conclude that this schedule always uses at most one machine. ◁

▷ **Claim 4.4.** If there is a feasible schedule, then G has an independent set of size at least k .

Proof. Suppose that there is a feasible schedule. Notice that the time of the first step of a vertex selection chains must be an element of S^n , otherwise the job conflicts with the start time forcing chain. Now, set $W = \{v_i \mid \text{there is a vertex selection chain that starts at time } s_i\}$. Notice that $|W| = k$, as otherwise two vertex selection chains start at the same time, and conflict with each other for their first job.

We prove that W is an independent set by contradiction. Suppose that there exists an edge $v_i v_j$, with $v_i, v_j \in W$. Let C_a be the chain that starts at s_i and C_b the chain that starts at s_j . Now consider the interval $I = I_{v_i, v_j, C_a, C_b}$, and write $I = [\ell(I), r(I)]$. By the construction of the chains, it follows that C_a starts its job of the interval I at time $\ell(I) + c_0 - s_i + s_i = \ell(I) + c_0$. The job of C_b in the interval starts at time $\ell(I) + c_0$ as well. This yields a contradiction. We conclude that W is an independent set. ◁

This shows that the CHAIN SCHEDULING WITH EXACT DELAYS problem with a single machine, parametrized by the number of chains, is $W[1]$ -hard. ◀

► **Lemma 4.5.** *The CHAIN SCHEDULING WITH EXACT DELAYS problem with one machine, parametrized by the number of chains c is in $W[1]$.*

Proof. We show that the problem belongs to $W[1]$ by a transformation to INDEPENDENT SET. Suppose we are given an instance of the CHAIN SCHEDULING WITH EXACT DELAYS problem with a single machine. We now build a graph as follows: for each chain C and each possible starting time t of this chain, we take one vertex $v_{C,t}$. We now add edges as follows: each pair of vertices that represent the same chain with different starting times is adjacent (i.e., for each chain, its vertices form a clique). For each pair of vertices $v_{C,t}, v_{C',t'}$, $C \neq C'$,

we add an edge if and only if starting chain C on time t and starting chain C' on time t' will cause that there is a time step where a job of both chains is scheduled.

It is not hard to see that the given instance of the CHAIN SCHEDULING WITH EXACT DELAYS problem has a solution, if and only if the constructed graph has an independent set of size at least k (with k the number of chains). Indeed, if there is an independent set of size at least k , then for every chain C there is a vertex $v_{C,t}$ in the independent set, since for every chain C we can have at most one vertex $v_{C,t}$ in an independent set. Scheduling chain C at time t gives a feasible schedule. On the other hand, if we have a feasible schedule, then the set $\{v_{C,t} \mid C \text{ a chain, } t \text{ its starting time in the schedule}\}$ is an independent set of size k . ◀

4.2 Constant number of parallel machines

If we assume that there are m machines, but m is considered to be a constant (i.e., not a fixed parameter; m is part of the problem description), then the problem is $W[1]$ -complete.

► **Theorem 4.6.** *The CHAIN SCHEDULING WITH EXACT DELAYS problem with m machines, parameterized by the number of chains, is $W[1]$ -complete.*

Hardness follows easily from the case that $m = 1$: add $m - 1$ chains with maximum length that consist of jobs with 0 delay.

Membership follows by formulating the problem as a WEIGHTED CNF-SAT problem, i.e., giving a CNF-SAT formula that has a solution with at most k (parameter) variables true, if and only if the scheduling problem has a solution.

We have a variable for each chain C and each time t that it can start, say $x_{C,t}$.

We have a number of clauses that force that each chains starts at some time: for each chain C , we have clause $\bigvee x_{C,t}$, ranging over all starting times t of chain C . We call those clauses *chain clauses*. This forces that each chain has one of its variables to be true.

The parameter k is set to the number of chains. It follows that for each chain, exactly one of its variables is true.

Then, we have clauses that check that we never use more than m machines. For each time t' , look at the set

$$S_{t'} = \{x_{C,t} \mid \text{if } C \text{ starts at time } t, \text{ then one of its jobs starts at time } t'\}.$$

For each subset $X \subset S_{t'}$ of $m + 1$ of these variables, we take a clause $\bigvee_{x_{C,t} \in X} \neg x_{C,t}$. We call those clauses the *time clauses*.

► **Claim 4.7.** Suppose there is a solution for the WEIGHTED CNF-SAT instance, then the CHAIN SCHEDULING WITH EXACT DELAYS scheduling problem has a solution.

Proof. Let $x_{C_1,t_1}, x_{C_2,t_2}, \dots, x_{C_k,t_k}$ be a solution for the CNF-SAT instance. The chain clauses guarantee that for every chain C there is at least one variable $x_{C,t}$ true. Since k equals the number of chains, we have that for every chain C there is exactly one variable $x_{C,t}$ true. Let chain C_i start at time t_i for all $i = 1, 2, \dots, k$.

We show that this is a feasible schedule by contradiction. Suppose that at time t more than m jobs are scheduled to start. Let X be the set of chains that those jobs are in. Let $X' \subseteq X$ be a subset of size $m + 1$. Then the time clause $\bigvee_{C_i \in X'} \neg x_{C_i,t_i}$ is not satisfied. This yields a contradiction. ◀

► **Claim 4.8.** If there exists a solution for the scheduling problem, then we have a solution for the WEIGHTED CNF-SAT instance.

Proof. Suppose we have a feasible schedule. For each chain C set the variable $x_{C,t}$ to true, where t is the starting time of C in the schedule. Notice that there are exactly k variables set to true.

For every chain C we set one variable $x_{C,t}$ to true, so the chain clauses are satisfied.

For every time t , at most m jobs start at t . Consider the set S_t . At most m variables in this set are set to true. So, for every subset $X \subseteq S_t$ of $m + 1$ variables, there is at least one variable false. Hence, the clause is satisfied. \blacktriangleleft

4.3 Variable number of parallel machines

In this section, we show that CHAIN SCHEDULING WITH EXACT DELAYS problem with m machines, where m is part of the input, is $W[2]$ -complete.

► **Theorem 4.9.** *The CHAIN SCHEDULING WITH EXACT DELAYS problems with a variable number of machines, parameterized by the number of chains c , is $W[2]$ -complete.*

We prove this by reductions from and to DOMINATING SET problems.

► **Lemma 4.10.** *The CHAIN SCHEDULING WITH EXACT DELAYS problems with a variable number of machines, parameterized by the number of chains c , is $W[2]$ -hard.*

Proof. Let $G = (V, E)$, k be an instance of DOMINATING SET. Assume that $V = \{v_1, v_2, \dots, v_n\}$. We will make an instance of the scheduling problem with k machines and $k + 1$ chains.

The first chain will have release date $2n - 1$ and deadline $n(n + 1)$. It will consist of n jobs, with delay $n - 1$ between each pair of consecutive jobs. Notice that this chain has to start at time $2n - 1$. We will call this chain the *check chain*.

The other k chains will be identical, we call them the *vertex selection chains*. They have release date 0 and deadline $(n + 1)n + n - 1$. They will have total execution time $(n + 1)n$, so they can start at times $0, 1, \dots, n - 1$. Start each chain with a job and then a delay of $n - 1$.

Consider the interval $[n, (n + 1)n]$ from left to right. For each integer $in + j$ with $0 \leq j \leq n - 1$, add the following to the vertex selection chains:

- a delay of 1 if $i = n - j$,
- a delay of 1 is $v_i \sim v_{n-j}$,
- a job otherwise.

Notice that for each interval $[in, (i + 1)n]$, we made a gadget that represents the adjacencies of vertex v_i : there is no job at time $(i + 1)n - j$ of the execution of the chain if $i = j$ or $v_i \sim v_j$ for $j = 1, 2, \dots, n$. See Figure 5.

▷ **Claim 4.11.** If G has a dominating set of size at most k , then there is a feasible schedule.

Proof. Let $v_{j_1}, v_{j_2}, \dots, v_{j_k}$ be a dominating set. Let the vertex selection chains start at times $j_1 - 1, j_2 - 1, \dots, j_k - 1$. We will show that this is a feasible schedule.

Notice that at each time that is not of the form $in - 1$ at most k jobs are scheduled to start, since the check chain has no job starting at this time.

Now consider the time $in - 1$, for some $i = 1, 2, \dots, n$. The check chain has a job scheduled to start at this time. We will show that there is a vertex selection chain that has no job starting at this time. Let v_{j_a} be the vertex that dominates v_i . Then we know that $i = j_a$ or $v_i \sim v_{j_a}$. So the vertex selection chains have a delay of 1 starting at time $(i + 1)n - j_a$ of their execution time. Let C be the chain that starts at time $j_a - 1$. It follows that C has a delay of 1 starting at time $(i + 1)n - j_a + (j_a - 1) = (i + 1)n - 1$. \blacktriangleleft

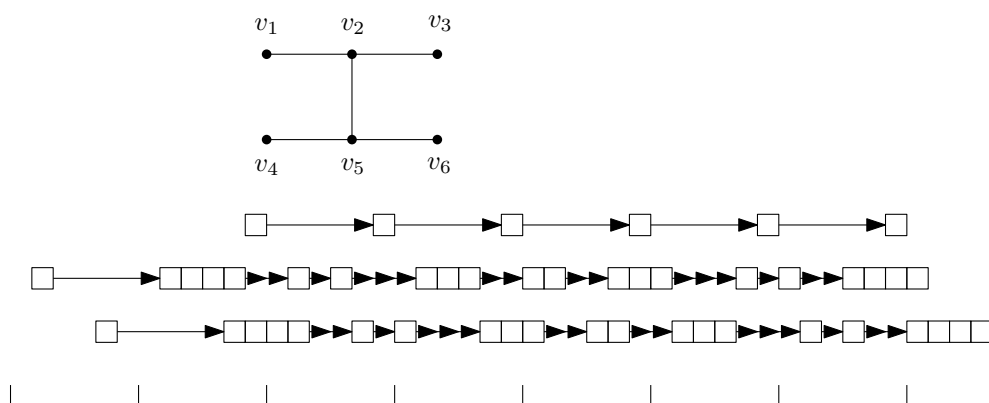

■ **Figure 5** A graph and the corresponding instance of the scheduling problem with $k = 2$.

▷ **Claim 4.12.** If there is a feasible schedule, then G has a dominating set of size at most k .

Proof. Let j_1, j_2, \dots, j_k be the starting times of the vertex selection chains in a feasible schedule. Consider the set $U = \{v_{j_1+1}, v_{j_2+1}, \dots, v_{j_k+1}\}$. We will show that this is a dominating set.

Let v_i be a vertex. Consider the time $(i + 1)n - 1$. Notice that a job of the check chain is scheduled to start at this time, so one of the vertex selection chains C has no job starting at this time. Let j_a be the starting time of the chain C . It follows that C has no job at time $(i + 1)n - 1 - j_a$ of its execution time. Hence $j_a + 1 = i$ or $v_{j_a+1} \sim v_i$. We conclude that v_i is dominated. ◁

We conclude that the CHAIN SCHEDULING WITH EXACT DELAYS problem with a variable number of machines is $W[2]$ -hard, when parametrized by the number of chains. ◀

► **Lemma 4.13.** *The CHAIN SCHEDULING WITH EXACT DELAYS problems with a variable number of machines, parameterized by the number of chains c , is in $W[2]$.*

Proof. We use a reduction to THRESHOLD DOMINATING SET. In the THRESHOLD DOMINATING SET problem, we are given a graph G and integers k and r , and ask for a set of at most k vertices, such that each vertex in G is dominated at least r times.

Downey and Fellows [8] showed that THRESHOLD DOMINATING SET, parameterized by k and r is $W[2]$ -complete.

Suppose we have an instance of the CHAIN SCHEDULING WITH EXACT DELAYS scheduling problem with m machines and c chains. Let t_{\max} the largest deadline in this instance. We will distinguish three cases: $c - m \leq 0$, $c - m = 1$, and $c - m > 1$. If $c \leq m$, any schedule is feasible, so we reduce to a trivial dominating set instance.

Suppose that $c - m = 1$. We will construct an instance of THRESHOLD DOMINATING SET where we look for a set of c vertices that dominates each vertex at least once.

We construct a graph G with three types of vertices:

- For each chain C and each time step t , we have vertex $x_{C,t}$ if and only if it is possible to start chain C at time t (i.e., t is not before the release date of C and t plus the execution time of C is at most the deadline of C).
- We have an independent set with for each time t , with $0 \leq t < t_{\max}$, a vertex y_t .
- For each chain C we have $c + 1$ vertices $z_{z,\alpha}$, with $\alpha = 1, 2, \dots, c + 1$.

We have the following edges:



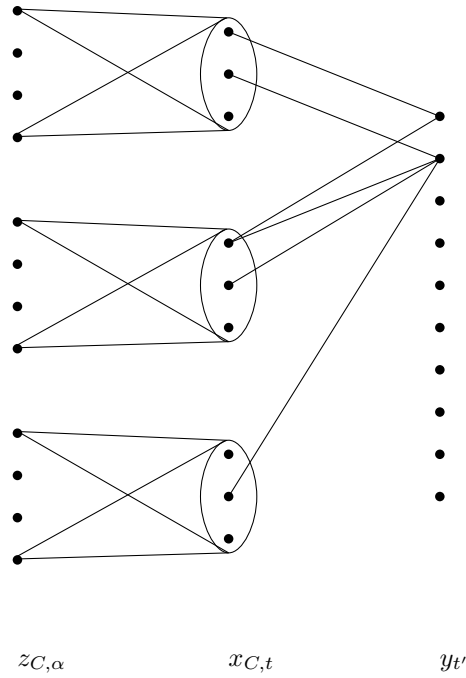

■ **Figure 6** The construction described in Lemma 4.13 for the case $c - m = 1$.

- For each chain C , the set of vertices of the form $x_{C,t}$ forms a clique.
 - There is an edge between $x_{C,t}$ to $y_{t'}$, if and only if starting chain C at time t makes that no job of C starts at time t' .
 - Each vertex $z_{C,\alpha}$ is adjacent to all vertices of the form $x_{C,t}$.
- See Figure 6.

▷ **Claim 4.14.** If G contains a threshold dominating set of size at most c that dominates every vertex at least once, then there is a feasible schedule.

Proof. Let U be a threshold dominating set with $|U| \leq c$, such that each vertex is dominated at least once.

We will show that U consists of vertices of the form $x_{C,t}$, one for each chain C .

Consider a chain C . Notice that there are $c + 1$ vertices $z_{C,\alpha}$, so U does not contain all of them. Let α be such that $z_{C,\alpha} \notin U$. Since $z_{C,\alpha}$ is dominated by U , at least one vertex of the form $x_{C,t}$ is contained in U . Since we have c chains and U has size c , it follows that for every chain C , U contains exactly one vertex of the form $x_{C,t}$ and no vertex of the form $z_{C,\alpha}$. Moreover, U does not contain vertices of the form $y_{t'}$.

Make a schedule as follows: for every chain C , start this chain at time t , for t such that $x_{C,t} \in U$. Consider a time t' . Since vertex $y_{t'}$ is dominated by a vertex $x_{C,t}$, we know that there is an edge from $x_{C,t}$ to $y_{t'}$. By the construction of G , it follows that chain C has no job starting at time t' . It follows that at most $c - 1 = m$ jobs start at time t . We conclude that this is a feasible schedule. ◁

▷ **Claim 4.15.** If there is a feasible schedule, then G has a threshold dominating set of size at most c that dominates every vertex at least once.

Proof. Consider the set U , that contains for every chain C the vertex $x_{C,t}$, where t is the starting time of C in the schedule.

It is clear that all vertices of the form $x_{C,t'}$ and $z_{C,\alpha}$ are dominated. Now consider a vertex $y_{t'}$. Since we have a feasible schedule, there is at least one chain that does not have a job starting at time t' . It follows that $y_{t'}$ is dominated by the corresponding vertex $x_{C,t}$. \triangleleft

Consider the last case $c - m > 1$.

We will construct an instance of THRESHOLD DOMINATING SET where we look for a set of $2c - m$ vertices that dominates each vertex at least $c - m$ times.

We construct a graph G with five types of vertices, this graph will be similar to the graph in the previous case.

- For each chain C and each time step t , we have vertex $x_{C,t}$ if and only if it is possible to start chain C at time t (i.e., t is not before the release date of C and t plus the execution time of C is at most the deadline of C).
- We have an independent set with for each time t , with $0 \leq t < t_{\max}$, a vertex y_t .
- For each chain C we have $c + 1$ vertices $z_{z,\alpha}$, with $\alpha = 1, 2, \dots, c + 1$.
- We have a clique of $c - m - 1$ vertices w_i , $1 \leq i \leq c - m - 1$.
- We have a vertex v .

We have the following edges:

- For each chain C , the set of vertices of the form $x_{C,t}$ forms a clique.
- There is an edge between $x_{C,t}$ to $y_{t'}$, if and only if starting chain C at time t makes that no job of C starts at time t' .
- Each vertex $z_{C,\alpha}$ is adjacent to all vertices of the form $x_{C,t}$.
- As written above, the vertices w_i form a clique.
- There is an edge vw_i for every i .
- Each vertex w_i is adjacent to all vertices of the form $x_{C,t}$.
- Each vertex w_i is adjacent to all vertices of the form $z_{C,\alpha}$.

See Figure 7.

▷ **Claim 4.16.** If G has a threshold dominating set of size at most $2c - m$ that dominates every vertex at least $c - m$ times, then there is a feasible schedule.

Proof. Suppose that G a threshold dominating set U with $|U| \leq 2c - m$, such that each vertex is dominated at least $c - m$ times.

First, notice that, as v has degree $c - m - 1$, U needs to contain v and all its neighbours, i.e., all vertices of the form w_i . It follows that U contains at most c other vertices.

As in the proof of Claim 4.14, it follows that U contains exactly one vertex of the form $x_{C,t}$ for every chain C .

Again as in the proof of Claim 4.14, we make a schedule by starting every chain at the time t for which $x_{C,t} \in U$. Now consider a time t' . We know that $y_{t'}$ is dominated at least $c - m$ times. It follows that there are $c - m$ chains that have no job starting at time t' . We conclude that at most m chains have a job starting at time t' , hence we use at most m machines. \triangleleft

▷ **Claim 4.17.** If there is a feasible schedule, then G has a threshold dominating set of size at most $2c - m$ that dominates every vertex at least $c - m$ times.

Proof. Consider the set U that contains v , all vertices w_i and for every chain C the vertex $x_{C,t}$, where t is the starting time of C in the schedule.

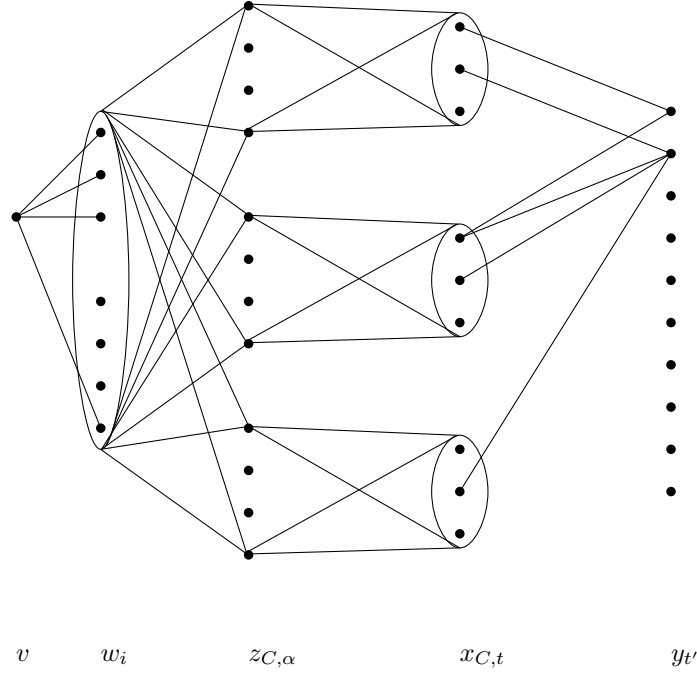

■ **Figure 7** The construction described in Lemma 4.13 for the case $c - m > 1$. The edges from w_i to $x_{C,t}$ are omitted.

It is clear that v and every vertex w_i is dominated at least $c - m$ times. Notice that every vertex $z_{C,\alpha}$ is dominated by every vertex w_i , and by one vertex $x_{C,t}$, so $z_{C,\alpha}$ is dominated at least $c - m$ times. The same holds for all vertices $x_{C,t}$.

Now consider a vertex $y_{t'}$. We know that at most m chains start a job at time t' . Hence, at least $c - m$ chains do not start a job at time t' . We conclude that $y_{t'}$ is dominated at least $c - m$ times. ◁

We conclude that the CHAIN SCHEDULING WITH EXACT DELAYS problem parametrized by the number of chains is in $W[2]$. ◀

4.4 Minimum delays

With a simple modification, the hardness proofs for exact delays in unary can be modified to hardness proofs for minimum delays (still in unary). The modification consists of taking a number of copies of the instance, as described below.

Suppose we have an instance for CHAIN SCHEDULING WITH MINIMUM DELAYS with exact delays with c chains and m machines. The C th chain has jobs $j_1^C, j_2^C, \dots, j_{s_C}^C$, with precedence constraints (j_i^C, j_{i+1}^C) , release date r_C and deadline d_C .

We define the *minimum duration* of a chain C to be $\ell_C = s_C + \sum_{i=1}^{s_C-1} l_{j_i^C, j_{i+1}^C}$. Thus, when the first job of C is executed at a time t , then the last job is executed at time $t + \ell_C - 1$ or later, and thus the minimum duration ℓ_C denotes the minimum number of time steps from the first till the last execution of a job in the chain.

Set $T = \max_{1 \leq C \leq c} d_C$ to be the maximum deadline of all chains.

We now build an instance for CHAIN SCHEDULING WITH MINIMUM DELAYS. The intuition behind the construction is the following: we build $cT + 1$ identical copies of the original instance after each other. Each is executed in its own slot of T consecutive time steps, in the

same way as a solution of the original instance. If we have a solution of the new instance, then one of the copies has no preemption, *i.e.*, must have delays equal to the minimum, and this gives a solution of the original instance.

For each chain C from the original instance, we make a new chain C' in the new instance. This chain C' has jobs $j_{i,a}^C$ with $1 \leq i \leq s_C$ and $1 \leq a \leq cT + 1$. We have precedence constraints $(j_{i,a}^C, j_{i+1,a}^C)$ ($1 \leq i < s_C$) whose minimum delay equals the exact delay for the original jobs (j_i^C, j_{i+1}^C) . The last job of the a th copy precedes the first job of the $(a+1)$ st copy: we have a precedence constraint $(j_{s_C,a}^C, j_{1,a+1}^C)$, for $1 \leq a < cT + 1$. We set the minimum delay for this precedence in such a way that the minimum execution time between a job and its next copy equals T : the precedence constraint $(j_{s_C,a}^C, j_{1,a+1}^C)$ goes with a minimum delay of $T - \ell_C$. The release date of the the new chain C' equals r_C and the deadline equals $cT^2 + d_C$.

▷ **Claim 4.18.** The instance of the CHAIN SCHEDULING WITH EXACT DELAYS problem has a solution, if and only if the instance of the CHAIN SCHEDULING WITH MINIMUM DELAYS problem has a solution.

Proof. Suppose we have a solution of the CHAIN SCHEDULING WITH EXACT DELAYS problem with exact delays, where jobs j_i^C are executed at time $t(j_i^C)$. Now, schedule for the instance with minimum delays, jobs $j_{i,a}^C$ on time $t'(j_{i,a}^C) = (a-1) \cdot T + t(j_i^C)$.

One can easily verify that this schedule fulfills the constraints. Note that all delays equal the minimum delays.

Now, suppose we have a solution of the CHAIN SCHEDULING WITH MINIMUM DELAYS problem with minimum delays. Note that the total execution time of a chain is at least $cT^2 + l_C$: the total execution time from a job $j_{1,a}^C$ till $j_{1,a+1}^C$ is constructed to be at least T , for $1 \leq a < cT + 1$. The total number of time steps from the release time till the deadline is $cT^2 + d_C - r_C$. Thus, the total slack in a chain, *i.e.*, the sum of the differences between the scheduled delay time and the stated minimum delay, cannot be larger than $cT^2 + d_C - r_C - cT^2 - l_C = d_C - r_C - l_C$. Notice that this is at most T .

Say copy a is *tainted* when there is at least one job $j_{i,a}^C$ for some C and $i < s_C$ where the delay from $j_{i,a}^C$ to $j_{i+1,a}^C$ is larger than the stated minimum delay. As each chain has at most T jobs of this type, we can have at most cT tainted copies.

Thus, there is a copy a that is not tainted. From the times that the jobs of copy a are scheduled, we build a solution.

Notice that the first job $j_{1,1}^C$ is scheduled at the earliest at time r_C and that $j_{1,a}^C$ is scheduled at least $(a-1)T$ time steps after $j_{1,1}^C$. So $j_{1,a}^C$ is scheduled at the earliest at time $(a-1)T + r_C$. Analogously, we find that $j_{s_C,a}^C$ is scheduled before $(a-1)T + d_C$. Hence, every job $j_{i,a}^C$ is scheduled between $(a-1)T + r_C$ and $(a-1)T + d_C$. Suppose that job $j_{i,a}^C$ is scheduled to start at time $(a-1)T + t(j_{i,a}^C)$, then schedule the corresponding job j_i^C to start at time $t(j_{i,a}^C)$. Notice that this is a feasible schedule, and that the exact delays are satisfied since the copy a is not tainted. ◀

By Theorems 4.1, 4.6 and 4.9, we conclude the following results.

▶ **Theorem 4.19.** *The CHAIN SCHEDULING WITH MINIMUM DELAYS problem with one machine, parameterized by the number of chains c , is $W[1]$ -hard.*

▶ **Theorem 4.20.** *The CHAIN SCHEDULING WITH MINIMUM DELAYS problem with m machines, parametrized by the number of chains, is $W[1]$ -hard.*

▶ **Theorem 4.21.** *The CHAIN SCHEDULING WITH MINIMUM DELAYS problems with a variable number of machines, parameterized by the number of chains c , is $W[2]$ -hard.*

Since the tickness is upper bounded by the number of chains, the same results follow when parametrized by the tickness.

5 XP algorithms

In this section, we give two positive results. First, we show membership in XP for all studied variants, when delays are given in unary, with a relatively straightforward dynamic programming algorithm. Then, in the case of one machine, we show that SCHEDULING WITH EXACT DELAYS is in XP, when parameterized by the number of chains, even when delays are given in binary.

► **Lemma 5.1.** *Given an instance of CHAIN SCHEDULING WITH EXACT DELAYS or CHAIN SCHEDULING WITH MINIMUM DELAYS, one can build in polynomial time an equivalent instance, where all release dates and deadlines of chains are nonnegative integers, bounded by $cn(D+1)$, where c is the number of chains, n the number of jobs, and D the maximum delay between two successive jobs in a chain. In addition, for each chain C , we have $d_C - r_C \leq n(D+1)$.*

Proof. We first look at CHAIN SCHEDULING WITH MINIMUM DELAYS. Consider the following operations. If we have a pair of successive jobs j and j' in a chain with minimum delay d , if job j is scheduled to start at time t , job j' is scheduled to start at time t' , and there is a time t'' with $t + d + 1 \leq t'' < t'$, and less than m jobs are starting at time t'' (with m the number of machines), then we obtain a valid schedule when we reschedule job j' at t'' and do not change the time for any other job. If the first job in a chain C is scheduled at time t , and there is a time step t' with $r_C \leq t' < t$, then we obtain a valid schedule when we reschedule this first job at time t' and do not change the time for any other job. Call a schedule *left-adjusted* when these steps are not possible. If there is a valid schedule, then there is also a valid left-adjusted schedule: just take any valid schedule, and perform the steps above while possible.

In a left-adjusted schedule, for each chain C , there is a job (of this or another chain) starting at time r_C , and we cannot have an interval with $D+1$ successive time steps between r_C and the scheduled time of the last job in the chain without any job (of any chain) scheduled. Thus, the last job of a chain is scheduled to start at time $r_C + n + (n-1)D - 1 \leq r_C + (n-1)(D+1)$ or earlier. This shows that we obtain an equivalent instance if we set for all chains the deadline to $\min\{d_C, r_C + (n-1)(D+1) + 1\}$. Since $r_C + (n-1)(D+1) + 1 \leq r_C + n(D+1)$, we obtain an equivalent instance if we set all deadlines to $\min\{d_C, r_C + n(D+1)\}$.

In the case of CHAIN SCHEDULING WITH EXACT DELAYS, valid schedules are trivially left-adjusted, so setting deadlines to $\min\{d_C, r_C + n(D+1)\}$ again gives an equivalent instance.

Now, consider the interval graph where each chain is a vertex, with edges between vertices if the chains overlap, here, the intervals associated with chain vertices C are the intervals $[r_C, d_C)$. We consider the different connected components of this interval graph. Take the component that contains the chain with minimum release date, and call this r_{\min} . For each chain in the component, subtract r_{\min} from its release date and deadline. We obtain an equivalent instance, with at least one release date equal to 0. We say that this first component is *handled*.

We now handle the other components, one by one as follows. Set δ to be the maximum deadline of all chains in handled components. Take, among all components that are not yet handled, the one with minimum release date of a chain in it. Say this minimum release

date is $r_{\min'}$. Subtract from all chains in the component $r_{\min'} - \delta$ from the release date and deadline. Thus, the earliest release date in the component is now δ . It is easy to see that this gives an equivalent schedule.

The algorithm thus consists of two steps: first, we set deadlines to $\min\{d_C, r_C + n(D+1)\}$, and then we handle the components. Now, order the chains by release date: C_1, C_2, \dots, C_c . Notice that $r_{C_{i+1}} \leq d_{C_i}$. Since $d_{C_i} \leq r_C + n(D+1)$, it follows that the maximum deadline is at most $cn(D+1)$. ◀

► **Theorem 5.2.** CHAIN SCHEDULING WITH EXACT DELAYS *and* CHAIN SCHEDULING WITH MINIMUM DELAYS *belong to XP, when delays are given in unary, and parameterized by the number of chains or thickness, for any number of machines.*

Proof. As the thickness is never larger than the number of chains, it suffices to give the result for the thickness.

The first step is to build the equivalent instance with deadlines and release dates in unary, and for all chains $d_C - r_C \leq n(D+1)$, as in Lemma 5.1.

We give now the dynamic programming algorithm; there are only small differences between the algorithms for CHAIN SCHEDULING WITH EXACT DELAYS and CHAIN SCHEDULING WITH MINIMUM DELAYS.

The algorithm uses the notion of a *state*. A state consists of a time step t , and for each chain C with $t \in [r_C, d_C)$, we have a bool $\text{started}(C)$. If $\text{started}(C) = \text{true}$, then the state also contains a job j_C and a time $t_C \in [r_C, t]$. (The intuition is as follows: j_C is the last job of chain C that is scheduled at or before time t ; j_C is scheduled at time t_C . If no job of C is scheduled at or before time t , then $\text{started}(C)$ is *false*.)

We say a state is *possible*, when there is a schedule with the following properties:

- The schedule assigns a time to all jobs in a chain whose deadline is before t , and for all chains C with $t \in [r_C, d_C)$ and $\text{started}(C)$ is true, a time is assigned to all jobs in the chain from the first job up to job j_C — i.e., we do not assign times for jobs preceded by j_C .
- Jobs j_C are scheduled at time t_C , for all chains C with $t \in [r_C, d_C)$ and $\text{started}(C)$ is true.
- The schedule respects the conditions on (minimum or exact) delays, and number of machines.

The dynamic programming algorithm now consists of computing for each time step t , in order of increasing t , the set of possible states for time t . Let D be the maximum over all chains C of $d_C - r_C$. Note that the number of states at time t is bounded by $(1 + n^2(D+1))^\tau$: each of the at most τ chains C with $t \in [r_C, d_C)$, we either have $\text{started}(C)$ false, or select one of the (at most n) jobs in the chain, and one of the (at most $n(D+1)$) timesteps in $[r_C, d_C)$. So, for fixed τ , the number of states is polynomial in the input size.

It is not hard to see, that given a set of all possible states at time t , we can compute in polynomial time the set of all possible states at time $t+1$. (The details are somewhat tedious: for all possible states at time t , consider all decisions of the form where for each machine we decide if we schedule a job on this machines, and if so, what job. For each of these, check whether delay and deadline conditions are still fulfilled; if so, add this to the possible states for time $t+1$. The check is different for exact or minimum delays; apart from that, these variants are handled in the same way.)

Continue computing this set for the time step that equals the maximum deadline minus 1. If it has a possible state, then this state reflects a schedule where all jobs are scheduled, and we decide positively; otherwise, no valid schedule exists. ◀

► **Theorem 5.3.** CHAIN SCHEDULING WITH EXACT DELAYS with $m = 1$, parameterized by the number of chains, with delays in binary belongs to XP .

Proof. Suppose we have chains C_1, \dots, C_c . Suppose chain C_i has jobs $j_{i,1}, j_{i,2}, \dots, j_{i,\ell_i}$, with $j_{i,a}$ directly preceding $j_{i,a+1}$; we write the exact delay of this constraint as $l_{i,a}$. Write $s(i, a) = \sum_{b=1}^{a-1} (l_{i,b} + 1)$. Note that $j_{i,a}$ has to be scheduled exactly $s(i, a)$ time after $j_{i,1}$ starts.

For each chain C_i , we take a variable x_i that denotes the time that the first job of C_i is scheduled.

▷ **Claim 5.4.** Variables x_1, x_2, \dots, x_c give a valid schedule, if and only if the following constraints are fulfilled.

1. For each i , $x_i \geq r_{C_i}$.
2. For each i , $x_i + s(i, \ell_i) < d_{C_i}$.
3. For each i and i' with $i \neq i'$, and each j, j' with $1 \leq j \leq \ell_i, 1 \leq j' \leq \ell_{i'}$, we have $x_i + s(i, j) \neq x_{i'} + s(i', j')$.

Proof. Suppose we have a valid schedule where chain C_i starts at time x_i . As the first job in a chain does not start before the release date, we have $x_i \geq r_{C_i}$. As the last job of the chain starts at time $x_i + s(i, \ell_i)$, we have $x_i + s(i, \ell_i) < d_{C_i}$. If the third condition would not hold for a 4-tuple i, i', j, j' , then both the j th job of chain C_i and the j' th job of $C_{i'}$ would be scheduled at time $x_i + s(i, j)$; this gives a conflict as we have only one machine.

The other direction is (also) simple: the first condition ensures that chains do not start before the release date; the second that they finish before the deadline, and the third that no two jobs are scheduled at the same time. ◀

The first step of the algorithm is to compute for each pair i, i' with $i \neq i'$ a set $U(i, i') = \{s(i', j') - s(i, j) \mid 1 \leq j \leq \ell_i, 1 \leq j' \leq \ell_{i'}\}$. Note that each of these sets has size $O(n^2)$, or more precisely, is at most the product of the sizes of the two chains. Now, sort each set $U(i, i')$.

Suppose $U(i, i') = \{a_1, a_2, \dots, a_r\}$ with $a_1 < a_2 < \dots < a_r$. Condition 3 of Claim 5.4 for the pair i, i' can be expressed as

$$(x_i - x_{i'} < a_1) \vee (a_1 < x_i - x_{i'} < a_2) \vee (a_2 < x_i - x_{i'} < a_3) \vee \dots \\ \dots \vee (a_{r-1} < x_i - x_{i'} < a_r) \vee (a_r < x_i - x_{i'})$$

Our algorithm now branches on these $O(n^2)$ possibilities. For each of the $O(c^2)$ pairs of chains, we have $O(n^2)$ branches, which gives a total of $O(n^{O(c^2)})$ subproblems.

Each of these subproblems asks to solve a set of inequalities. These inequalities are of the form $x_i - x_{i'} < a$ or $x_i \geq a$ (Condition 1 of Claim 5.4) or $x_i \leq a$ (Condition 2 of Claim 5.4), for some integers a . As we work with integers and look for integer solutions, we reformulate constraints of the form $x_i - x_{i'} < a$ as $x_i - x_{i'} \leq a - 1$. We now have a system of linear inequalities which can be solved in polynomial time with text book (shortest paths) methods, see e.g., [5, Section 24.4]. If at least one of the subproblems has a solution, then this solution gives starting times for the chains that gives a valid schedule; otherwise, there is no valid schedule.

We have $O(n^{O(c^2)})$ branches, each taking polynomial time, and this gives a running time of $O(n^{O(c^2)})$. ◀

6 Conclusions

In this paper, we have shown a number of results on the parameterized complexity of CHAIN SCHEDULING WITH EXACT DELAYS and CHAIN SCHEDULING WITH MINIMUM DELAYS. In a few cases, we obtained $W[1]$ -completeness or $W[2]$ -completeness; in the other cases, we only showed hardness results, often together with XP-membership. We expect that the problems, parameterized by the thickness do not belong to $W[P]$ — for the same ‘compositionality’ reason as why one can believe that GRAPH BANDWIDTH does not belong to $W[P]$: see the discussion in [11, Section 4]. The machinery to prove such results currently is not available, but we conjecture that also the variants with minimum delays inhibit some form of compositionality and do not belong to $W[P]$.

We end this paper with mentioning some open problems. In this paper, we proved for the case that delays are given in binary, for only one of the cases membership in XP. What is the complexity of the other cases when delays are given in binary? Also, an interesting question is to study the variant where we have maximum delays, with all of its subcases.

References

- 1 Martin Aigner and Günter M. Ziegler. Bertrand’s postulate. In *Proofs from THE BOOK*, pages 7–12. Springer, 2001. doi:10.1007/978-3-662-04315-8_2.
- 2 S. Bessy and R. Giroudeau. Parameterized complexity of a coupled-task scheduling problem. *Journal of Scheduling*, 22(3):305–313, 2019. doi:10.1007/s10951-018-0581-1.
- 3 Hans L. Bodlaender and Michael R. Fellows. $W[2]$ -hardness of precedence constrained K -processor scheduling. *Oper. Res. Lett.*, 18(2):93–97, 1995. doi:10.1016/0167-6377(95)00031-9.
- 4 Peter Brucker, Johann Hurink, and Wieslaw Kubiak. Scheduling identical jobs with chain precedence constraints on two uniform machines. *Mathematical Methods of Operations Research*, 49:211–219, 1999. doi:10.1007/PL00020913.
- 5 Thomas H. Cormen, Charles E. Leiserson, Ronald L. Rivest, and Clifford Stein. *Introduction to Algorithms, 3rd Edition*. MIT Press, 2009. URL: <http://mitpress.mit.edu/books/introduction-algorithms>.
- 6 Rodney G. Downey and Michael R. Fellows. Fixed-parameter tractability and completeness I: Basic results. *SIAM Journal on Computing*, 24:873–921, 1995. doi:10.1137/S0097539792228228.
- 7 Rodney G. Downey and Michael R. Fellows. Fixed-parameter tractability and completeness II: On completeness for $W[1]$. *Theoretical Computer Science*, 141(1-2):109–131, 1995. doi:10.1016/0304-3975(94)00097-3.
- 8 Rodney G. Downey and Michael R. Fellows. Threshold dominating sets and an improved characterization of $W[2]$. *Theoretical Computer Science*, 209(1-2):123–140, 1998. doi:10.1016/S0304-3975(97)00101-1.
- 9 P. Erdős and P. Turán. On a problem of Sidon in additive number theory, and on some related problems. *Journal of the London Mathematical Society*, s1-16(4):212–215, 1941. doi:10.1112/jlms/s1-16.4.212.
- 10 Michael R. Fellows and Catherine McCartin. On the parametric complexity of schedules to minimize tardy tasks. *Theoretical Computer Science*, 298(2):317–324, 2003. doi:10.1016/S0304-3975(02)00811-3.
- 11 Michael R. Fellows and Frances A. Rosamond. Collaborating with Hans: Some remaining wonderments. In Fedor V. Fomin, Stefan Kratsch, and Erik Jan van Leeuwen, editors, *Treewidth, Kernels, and Algorithms — Essays Dedicated to Hans L. Bodlaender on the Occasion of His 60th Birthday*, volume 12160 of *Lecture Notes in Computer Science*, pages 7–17. Springer, 2020. doi:10.1007/978-3-030-42071-0_2.

- 12 Matthias Mnich and Andreas Wiese. Scheduling and fixed-parameter tractability. *Mathematical Programming*, 154(1):533–562, 2015. doi:10.1007/s10107-014-0830-9.
- 13 Erick D. Wikum, Donna C. Llewellyn, and George L. Nemhauser. One-machine generalized precedence constrained scheduling problems. *Operations Research Letters*, 16(2):87–99, 1994. doi:10.1016/0167-6377(94)90064-7.
- 14 Gerhard J. Woeginger. A comment on scheduling on uniform machines under chain-type precedence constraints. *Operations Research Letters*, 26(3):107–109, 2000. doi:10.1016/S0167-6377(99)00076-0.