

Design of Puncturing for Length-Compatible Polar Codes Using Differential Evolution

Kuntal Deka¹ and Sanjeev Sharma²

¹ Indian Institute of Technology Goa, India ²Indian Institute of Technology (BHU) Varanasi, India

Abstract—This paper presents a puncturing technique to design length-compatible polar codes. The punctured bits are identified with the help of differential evolution (DE). A DE-based optimization framework is developed where the sum of the bit-error-rate (BER) values of the information bits is minimized. We identify a set of bits which can be avoided for puncturing in the case of additive white Gaussian noise (AWGN) channels. This reduces the size of the candidate puncturing patterns. Simulation results confirm the superiority of the proposed technique over other state-of-the-art puncturing methods.

Index Terms—Polar codes, puncturing, length-compatibility, successive cancellation decoder.

I. INTRODUCTION

Polar code, proposed by Arikan [1], is an important milestone in coding theory and has undoubtedly completed the long quest for capacity-achieving codes. In the original version [1], the polarizing or the generator matrix was constructed by the Kronecker power of the binary 2×2 kernel $\mathbf{F}_2 = \begin{bmatrix} 1 & 0 \\ 1 & 1 \end{bmatrix}$. Due to this choice, the lengths are limited to powers of 2. Various polarizing kernels of larger size and defined over non-binary alphabets have been proposed [2, 3]. However, these kernels do not ensure low-complexity decoding methods as in the case of \mathbf{F}_2 . Therefore, designing polar codes of arbitrary lengths with reasonable decoding complexity is a vital problem.

Puncturing is a simple and effective technique to modify the rate and the length of a code. The rate of a polar code can be conveniently adapted by varying the number of frozen or information bits. Puncturing is not required for the rate-adaptability of a polar code. However, to attain length-compatibility for the polar codes, puncturing is very helpful. In [4], an efficient method is proposed to design length-compatible polar codes. This method is referred to as the quasi-uniform puncturing (QUP). Suppose, one needs to puncture n_p bits of a polar code of length N . In QUP, the bit-reversed versions of the first n_p consecutive integers $\{1, 2, \dots, n_p\}$ are considered for puncturing. The method in [5] selects the bit-reversed versions of the last n_p consecutive integers $\{N - n_p + 1, \dots, N\}$ as the puncturing bits. The authors in [6] have proposed a puncturing technique by analyzing the reduced polarization matrix after the removal of the columns and the rows corresponding to the punctured and the frozen bits respectively. In [7], the authors have partitioned the puncturing patterns into various equivalent classes and proposed a method to find the optimum pattern by examining only one representative of each class.

Contributions

In this paper, the determination of the best puncturing pattern is formulated as an optimization problem. Differential evolution (DE) is used for the optimization process.

DE is a popular and simple evolutionary algorithm which is used to solve complex optimization problems with real-valued parameters [8]. The suitability of various figures of merit or parameters for the objective function is studied. After analyzing the behaviors of these parameters during the decoding process under puncturing, we decide to consider the sum of the bit-error-rate (BER) values of the information bits as the objective function. The selection of the information bits depends heavily on the puncturing pattern. We propose a DE-based search algorithm to find the optimum pair of the sets of the punctured and the information bits simultaneously by minimizing the sum of the BER values for the information bits. A technique to reduce the search-space for punctured bits is presented where the even-indexed bits are overlooked.

II. PRELIMINARIES

Consider a polar code with the block length $N = 2^m$, $m \in \mathbb{Z}^+$. The generator matrix is given by $\mathbf{G}_N = \mathbf{B}_N \mathbf{F}_2^{\otimes m}$ where, \mathbf{B}_N is the bit-reversal permutation matrix and \otimes^m is the Kronecker power [1]. For a binary data vector $u_1^N = (u_1, u_2, \dots, u_N)$, the codeword x_1^N is obtained by $x_1^N = u_1^N \mathbf{G}_N$. This encoding process produces a set of N polarized synthetic bit-channels. For a rate $R = \frac{K}{N}$ code, the K information bits are carried over the best K bit-channels by putting them into the respective slots \mathcal{I} in u_1^N . The bits in the other locations \mathcal{I}^c are frozen to 0 and these values are known perfectly to the decoder. The decoding is done by the successive cancellation (SC) algorithm [1].

In order to derive a length- N' polar code from a mother code of length N , a total of $n_p = N - N'$ bits of the codeword x_1^N need to be punctured. The rate of the modified code is given by $R' = \frac{K}{N - n_p}$. Let \mathcal{P} denote the set of puncturing bits with $|\mathcal{P}| = n_p$. The coded bits corresponding to \mathcal{P} are not transmitted. The decoder knows only the location of the punctured bits and sets their initial log-likelihood ratio (LLR) values to zero. Because of the puncturing of the bits in \mathcal{P} , the quality of the synthesized bit-channels get modified and the information set \mathcal{I} should be re-selected.

III. DESIGN OF PUNCTURING PATTERN BASED ON DIFFERENTIAL EVOLUTION

Suppose the objective is to derive a length- N' polar code from a length- N one. For that, one needs to puncture $n_p = N - N'$ bits. The number of candidate bits is $D = N$ and we have to select the best n_p bits amongst these D bits. The optimization problem can be formulated as:

$$[\mathcal{P}_m, \mathcal{I}_m] = \arg \min_{\mathcal{P}, \mathcal{I}} f \left(\mathcal{P}, \mathcal{I}, \frac{E_b}{N_0} \right) \quad (1)$$

where, the objective function is $f\left(\mathcal{P}, \mathcal{I}, \frac{E_b}{N_0}\right)$ and $\frac{E_b}{N_0}$ is the signal-to-noise-ratio (SNR). There are many figures of merit which can be considered as the objective function. Some of these are Bhattacharyya parameters of the bit-channels, the BER values of the individual bits computed by Monte Carlo simulation, the mean of the LLRs etc. These parameters are also taken into consideration in the construction step [9]. In order to find the best figure of merit for puncturing, we analyze the evolution of various parameters during decoding under the influence of puncturing.

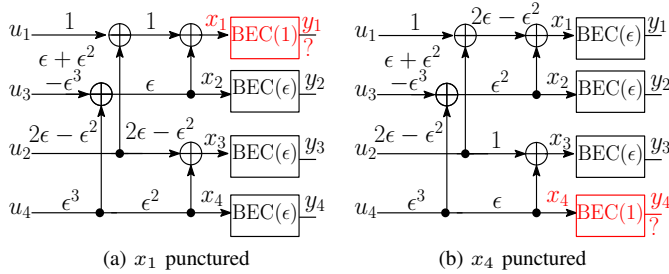

Fig. 1: Bhattacharyya parameters for $N' = 3$ polar code over BEC with erasure probability ϵ .

Consider the generation of $N' = 3$ polar code from $N = 4$ mother polar code by puncturing one bit in the case of binary erasure channel (BEC). In Fig. 1(a), the coded-bit x_1 is punctured. Since, this bit is completely erased, the first channel effectively becomes a BEC with erasure probability 1. The other channels are identical and equal to BEC with erasure probability ϵ . By applying Proposition 6 of [1], the evolution of these parameters at different layers is shown in Fig. 1(a) when x_1 is punctured. These are found to be $\{1, 2\epsilon - \epsilon^2, \epsilon + \epsilon^2 - \epsilon^3, \epsilon^3\}$ for the bit-channels. Consider the case when x_4 is punctured instead of x_1 as shown in Fig. 1(b). The Bhattacharyya parameters are the same as that in the previous case. This means that the puncturing patterns

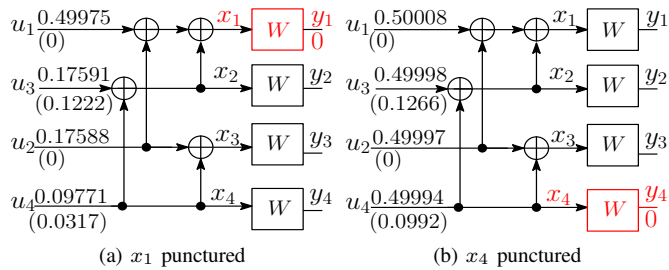

Fig. 2: BER values for $N' = 3$ polar code over AWGN channel at 1 dB.

$\{1\}$ and $\{4\}$ are equivalent when the underlying channel is BEC. However, for other channels, these two puncturing patterns may not be equivalent. Fig. 2 shows such a situation when the underlying channel is AWGN (represented by W). The BER values of the input bits as computed from Monte Carlo simulation are $\{0.49975, 0.17588, 0.17591, 0.09771\}$ and $\{0.50008, 0.49997, 0.49998, 0.49994\}$ for the puncturing

patterns $\{1\}$ and $\{4\}$ respectively at $\frac{E_b}{N_0} = 1$ dB¹. This shows that $\{1\}$ is better than $\{4\}$ and in fact $\{4\}$ should be avoided for puncturing. Observe that here, we have considered all the input bits to be the information bits.

The BER values after the selection of the information bits are also analyzed here. These BER values are more appropriate measures and are shown within brackets in Fig. 2 when the rate $R = 0.5$. It can be safely concluded that $\{x_1\}$ is a better puncturing pattern than $\{x_4\}$. The above examples show that

Algorithm 1: Puncturing based on differential evolution

input : $N, K, n_p, \frac{E_b}{N_0}, F, C_r,$ and S_P
output: Puncturing bits \mathcal{P}_m and information bits \mathcal{I}_m

Initialize the population matrix \mathbf{P} to a matrix of size $S_P \times D$ having random numbers uniformly distributed over $[0, 1]$ where $D = N$ // Initialization;

while termination criteria not fulfilled **do**

for $i \leftarrow 1$ **to** S_P **do**

Select three distinct vectors (rows) $\mathbf{z}_{r_0}, \mathbf{z}_{r_1}$ and \mathbf{z}_{r_2} uniformly at random from \mathbf{P} such that they are also different from \mathbf{z}_i ;

Generate an integer j_{rand} uniformly at random from $\{1, 2, \dots, D\}$;

/* Generation of trial vector \mathbf{u} */

for $j \leftarrow 1$ **to** D **do**

if $rand[0, 1] \leq C_r$ or $j = j_{rand}$ **then**

$\mathbf{w}_{j,i} = \mathbf{z}_{j,r_0} + F \times (\mathbf{z}_{j,r_1} - \mathbf{z}_{j,r_2})$

// Crossover and Mutation

else

$\mathbf{w}_{j,i} = \mathbf{z}_{j,i}$

/* Evaluation and Selection */

Suppose \mathbf{w}^p and \mathbf{z}_i^p are the first n_p arguments/indices of the sorted (descending) version of \mathbf{w} and \mathbf{z}_i respectively.

With the help of GA method, find the sets $\mathcal{I}_{\mathbf{w}^p}$ and $\mathcal{I}_{\mathbf{z}_i^p}$ of the information bits when the code bits in \mathbf{w}^p and \mathbf{z}_i^p are punctured respectively;

Run Monte Carlo simulation with the chosen information or frozen sets. Suppose, $f(\mathbf{w}^p)$ and $f(\mathbf{z}_i^p)$ are the sums of the BER values for the information bits in $\mathcal{I}_{\mathbf{w}^p}$ and $\mathcal{I}_{\mathbf{z}_i^p}$ respectively ;

if $f(\mathbf{w}^p) < f(\mathbf{z}_i^p)$ **then**

$\mathbf{z}_i = \mathbf{w}$ // Replace the i th row of \mathbf{P} by \mathbf{w} ;

From the updated population matrix \mathbf{P} , find the vector (row) \mathbf{z}_{min} (or equivalently \mathbf{z}_{min}^p) which yields the minimum value of objective function;

If $f(\mathbf{z}_{min}^p)$ is not changing significantly from the previous iteration or the maximum number of iterations are exhausted, then break from loop;

Set \mathcal{P}_m to \mathbf{z}_{min}^p ;

Assign the set $\mathcal{I}_{\mathbf{z}_{min}^p}$ of information bits to \mathcal{I}_m ;

the Bhattacharyya parameters are not suitable for designing puncturing patterns for general channels. The BER values computed from Monte Carlo simulation are more reliable

¹ The Monte Carlo method in [1] was used to find the estimates for the Bhattacharyya parameters of the bit channels. As these parameters are related to the probability of error for the input bits, we consider the Monte Carlo simulation to estimate the probability of bit error.

features. Therefore, in (1), we consider the objective function $f\left(\mathcal{P}, \mathcal{I}, \frac{E_b}{N_0}\right)$ as the sum of the BER values of the bits in the information set \mathcal{I} at SNR $\frac{E_b}{N_0}$ when the coded bits in \mathcal{P} are punctured. For brevity, $f\left(\mathcal{P}, \mathcal{I}, \frac{E_b}{N_0}\right)$ will be substituted by $f(\mathcal{P})$ with the understanding that \mathcal{I} is the optimum information set for \mathcal{P} at a fixed SNR $= \frac{E_b}{N_0}$.

In order to solve (1), we adopt DE. The detailed steps are shown in Algorithm 1. In DE, a population \mathbf{P} of vectors is updated iteratively. The number of vectors in the population is denoted by S_P . The length of a vector is $D = N$ in this case. At first, \mathbf{P} is initialized as a matrix of dimension $S_P \times D$ whose elements are chosen uniformly at random from $[0, 1]$. For each vector \mathbf{z}_i , $i = 1, \dots, S_P$ in \mathbf{P} , a trial vector \mathbf{w} is generated with the given values of crossover rate (C_r) and scaling factor (F). The details of the generation of the trial vector are presented in Algorithm 1. Here, we consider the convention that, for any candidate vector $\mathbf{z}_i = (\mathbf{z}_{1,i}, \dots, \mathbf{z}_{D,i})$, if $\mathbf{z}_{j,i} > \mathbf{z}_{k,i}$, then it is preferable to puncture the j th bit compared to the k th bit as per that candidate. Based on this convention, the vectors \mathbf{w} and \mathbf{z}_i are sorted in descending order and the arguments are stored in $\mathbf{w}^{\text{sorted, arg}}$ and $\mathbf{z}_i^{\text{sorted, arg}}$ respectively. Then the first n_p indices are stored in \mathbf{w}^p and \mathbf{z}_i^p . By using Gaussian approximation (GA) method [10], the information bits $\mathcal{I}_{\mathbf{w}^p}$ and $\mathcal{I}_{\mathbf{z}_i^p}$ are found out against the puncturing patterns \mathbf{w}^p and \mathbf{z}_i^p respectively. Note that the information bits need to be re-selected for every distinct puncturing pattern. GA is considered for the construction step as it provides good performance with low complexity [9]. Now, by carrying out Monte Carlo simulation, the values of the objective functions $f(\mathbf{w}^p)$ and $f(\mathbf{z}_i^p)$ are computed. If $f(\mathbf{w}^p) < f(\mathbf{z}_i^p)$, then the i th row of \mathbf{P} is replaced by the trial vector \mathbf{w} . In this way, every vector in \mathbf{P} is examined and updated if needed. From the updated \mathbf{P} , the best vector \mathbf{z}_{\min}^p with the minimum objective value is found out. If there is negligible change in this objective value from the previous iteration or the maximum number of iterations are completed, the algorithm is stopped. The puncturing pattern \mathbf{z}_{\min}^p and the corresponding set of the information bits $\mathcal{I}_{\mathbf{z}_{\min}^p}$ are returned as the outputs \mathcal{P}_m and \mathcal{I}_m .

Reduction of the search space: For length-compatible polar codes, the search space for the punctured bits can be reduced by ignoring the set F_P of forbidden bits as given by

$$F_P = \mathcal{E} \cup \{N - 1\}$$

where, $\mathcal{E} = \{2, 4, \dots, N - 2, N\}$ is the set of even-indexed bits. Polar codes of any arbitrary length can be obtained without resorting to puncturing of these forbidden bits. We set $D = \frac{N}{2} - 1$ in Algorithm 1.

Justification: The polar encoding structure for length- N code contains $\log_2 N$ layers with each layer containing $N/2$ basic butterfly structures. The structure contains N branches corresponding to the coded bits. The situation is explained in Fig. 3 for the case $N = 8$. The input bits comprising of the frozen and the information bits are fed to the first layer. The last layer is connected directly to the channels. Consider the SC

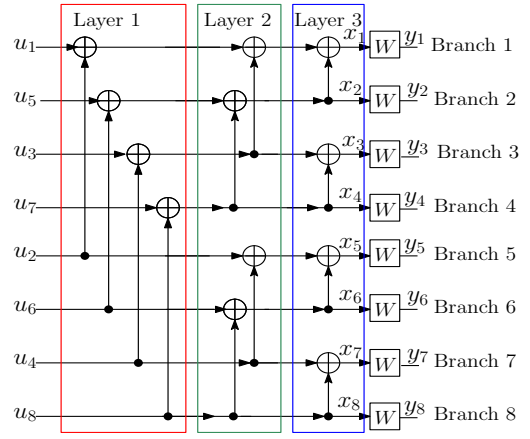

Fig. 3: Encoding structure for $N = 8$ polar code.

decoding in LLR domain over a particular basic structure in the last layer as shown in Fig. 4.

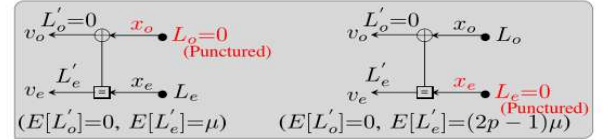

Fig. 4: LLR-based SC decoding under puncturing at the last layer (v_o and v_e are typically intermediate bits and not the frozen/information bits).

The input LLRs to the upper (odd) and the lower (even) branch of the basic structure are L_o and L_e respectively. The outputs are given by:

$$L'_o = 2 \tanh^{-1} \left[\tanh \left(\frac{L_o}{2} \right) \tanh \left(\frac{L_e}{2} \right) \right] \quad (2)$$

$$L'_e = (1 - 2\hat{v}_o)L_o + L_e$$

where, \hat{v}_o is the most recent estimate found regarding the bit v_o while computing L'_e .

We take insight from the GA method where the mean of the LLR messages is updated across the layers [10]. Consider the transmission of all-zero codeword. Suppose, μ is the mean of the channel LLR values. As shown in Fig. 4, if the upper or the odd bit x_o is punctured, then $L_o = 0$. Subsequently, by (2), the output LLRs become $L'_o = 0$, $L'_e = L_e$. Thus we have the following pair of mean values ($E[L'_o] = 0$, $E[L'_e] = \mu$). On the other hand, if the lower or the even bit x_e is punctured, then $L_e = 0$. In that case, $L'_o = 0$. Note that the computation of \hat{v}_o may benefit from the known values of a few frozen bits by the time L'_e is computed. Suppose, p is the probability that \hat{v}_o is correct i.e., $\Pr(\hat{v}_o = v_o = 0) = p$. In that case, the pair of mean values are given by ($E[L'_o] = 0$, $E[L'_e] = (2p - 1)\mu$). As $p \leq 1$, we have $(2p - 1)\mu \leq \mu$. Therefore, when x_e is punctured, the evolution of the mean is slower compared to case where x_o is punctured. In GA, the probability of bit

TABLE I: Number of appearances

Bit/ Branch	x_1	x_2	x_3	x_4	x_5	x_6	x_7	x_8
As upper branch	3	2	2	1	2	1	1	0
As lower branch	0	1	1	2	1	2	2	3

error is inversely proportional to the mean value. This implies that the probability of error for the information bits will be higher when x_e is punctured. Moreover, both the upper and the lower bits of a basic structure should not be punctured simultaneously because it will fully disturb the structure. Therefore, the search space may be reduced by rejecting all even bits ($\mathcal{E} = \{2, 4, \dots, N\}$). The total number of even bits is $N/2$. The maximum number of bits to be punctured is $N/2 - 1$. Amongst the odd bits, the bit or branch ' $N - 1$ ' appears as the lower branch in the maximum number of basic structures in various layers. The number of involvements of a bit as lower and upper branch are shown in TABLE I. The set F_P of the forbidden bits is given by $F_P = \mathcal{E} \cup \{N - 1\}$. There is no need to puncture any of the bits in F_P as any lower-length code can be derived from a code of length $N/2$ or less. ■

Example 1. Consider the case of deriving $N' = 6$ polar code from $N = 8$ polar code by puncturing $n_p = 2$ coded bits. The DE-based algorithm is invoked to find the best $n_p = 2$ bits for puncturing. We consider a population matrix \mathbf{P} of size 4×3 with $S_P = 4$ and $D = \frac{8}{2} - 1 = 3$. \mathbf{P} is initialized to a random matrix where an element is selected uniformly at random from $[0, 1]$. Suppose \mathbf{P} is initialized to the following matrix:

$$\mathbf{P} = \begin{bmatrix} 0.68471631 & 0.144816 & 0.26360207 \\ 0.0790236 & 0.40264467 & 0.13473581 \\ 0.59553136 & 0.57930957 & 0.77943687 \\ 0.96593194 & 0.03113405 & 0.83083448 \end{bmatrix}. \quad (3)$$

For every row of \mathbf{P} , a trial vector is generated by carrying out the mutation and the crossover operations. For the selection step, we consider the sum of the BER values of the information bits as the objective function. The punctured bits are identified from the indices of the sorted rows of \mathbf{P} . The first column refers to puncturing of bit 1, the second column refers to puncturing of bit 3 and the third column refers to puncturing of bit 5. For example, consider the first row (0.68471631, 0.144816, 0.26360207) of \mathbf{P} in (3). As we need to select two bits for puncturing, we consider the indices of the first two highest row elements. The first two highest elements are (0.68471631, 0.26360207) and they refer to puncturing of (1, 5). For these punctured bits, the information bits are selected using GA. Monte Carlo simulation for SC decoding is carried out. The sum of the BER values of the information bits is considered as the objective function during the selection process. If the value of objective function for the first row is higher than that for the trial vector, then the first row is replaced by the trial vector. In this way, every row of \mathbf{P} is examined and updated iteratively if required. When the stopping criteria are met, the best row or vector (having the lowest sum of the BER values) from \mathbf{P} is selected and the corresponding set of punctured bits is considered as the optimum pattern.

IV. SIMULATION RESULTS

In recent communication standards, polar codes of short blocklengths have been considered [11]. We present the simulation results for two cases. The short codes are considered

so that the punctured bits and the information bits can be explicitly mentioned. Due to space constraint, we provide only the block-error-rate (BLER) performances although the BER results are found to be equally impressive.

Case 1: In this case, we puncture $n_p = 28$ bits of polar code of length $N = 128$ and rate $R = 0.5$. This puncturing will produce a code of length $N' = 100$ and rate $R' = 0.64$. The DE-based algorithm is run to find the optimum punctured bits and information bits with the parameters $S_P = 100$, $C_r = 0.8$ and $F = 0.6$ at $\frac{E_b}{N_0} = 6$ dB. These bits are shown in Table II. The DE-based search algorithm is run to find the optimum puncturing pattern at an SNR such that the BER is around 10^{-5} . The pattern determined in this way is found to work well at different SNR values.

TABLE II: \mathcal{P}_m and \mathcal{I}_m for Case 1

Punctured bits	1 3 5 7 9 11 13 17 21 25 33 37 41 45 49 53 57
\mathcal{P}_m	65 69 73 77 81 85 89 97 101 105 113
Information bits	32 46 47 48 52 54 55 56 58 59 60 61 62 63 64
\mathcal{I}_m	72 76 78 79 80 84 85 86 87 88 89 90 91 92 93
	94 95 96 98 99 100 101 102 103 104 105 106
	107 108 109 110 111 112 113 114 115 116 117
	118 119 120 121 122 123 124 125 126 127 128

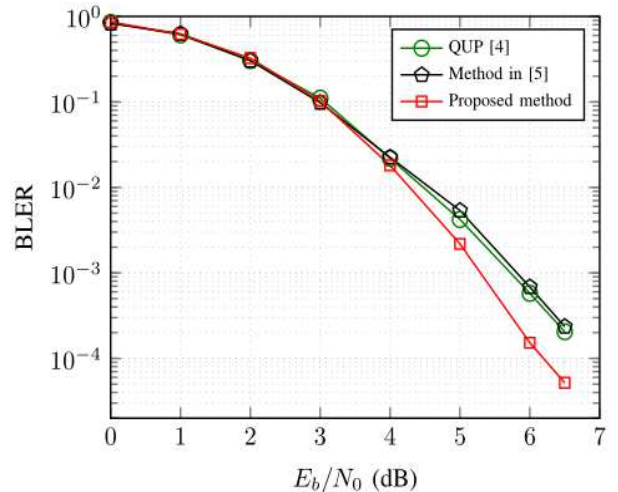

Fig. 5: Comparison under SC decoding, Case 1.

The BLER performances of the puncturing methods under SC decoding are shown in Figure 5. Observe that the proposed puncturing pattern yields the best result and offers a coding gain of about 0.8 dB at $\text{BLER} = 10^{-4}$. The high value of the coding gain confirms the superiority of the DE-based puncturing strategy over the existing methods.

We also evaluate the performances of these puncturing schemes under cyclic-redundancy-check (CRC) aided SC list decoding [12]. The size of a list is set to $L = 8$. We consider an outer CRC code of length 16 with generator polynomial $g(x) = x^{16} + x^{12} + x^5 + 1$. This code is known as CRC-16-CCITT. The CRC coded bits are put in the locations of the last 16 information bits as per the recommendation given in [12]. The performances of the puncturing schemes under

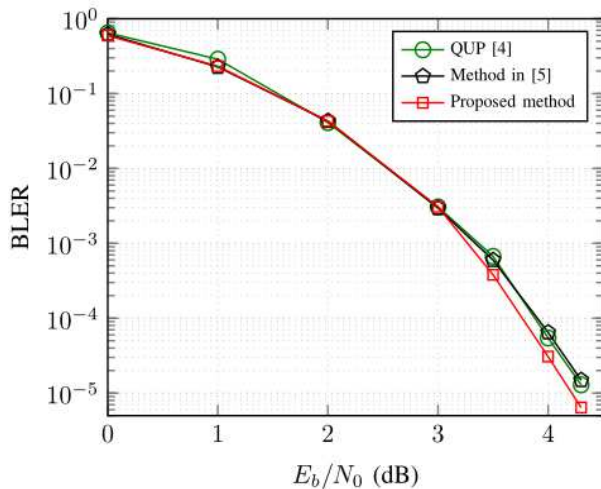

Fig. 6: Comparison under CRC-aided SC list decoding, Case 1.

CRC-aided SC list decoding are shown in Figure 6. Observe that, the proposed puncturing method performs better than the QUP [4] and method in [5]. However, unlike in the case of SC decoding, the coding gain is relatively small and it is around 0.25 dB at $\text{BLER}=10^{-4}$. This reduction of the coding gain is due to the presence of a powerful CRC code as the outer code in the concatenated encoding scheme. Nevertheless, the proposed puncturing method performs significantly better than the existing methods in a purely polar coding environment.

Case 2: In this case, we puncture $n_p = 24$ bits of a polar code of length $N = 64$ and rate $R = 0.5$. This puncturing will produce a code of length $N' = 40$ and rate $R' = 0.8$. The DE-based algorithm is run to find the optimum punctured bits and information bits with $S_P = 50$, $C_r = 0.8$ and $F = 0.6$ at $\frac{E_b}{N_0} = 8$ dB. These bits are shown in Table III. The BLER

TABLE III: \mathcal{P}_m and \mathcal{I}_m for Case 2

Punctured bits \mathcal{P}_m	1, 3, 5, 7, 9, 11, 13, 15, 17, 19, 21, 23, 27, 29, 33, 37, 39, 41, 45, 51, 53, 55, 59, 61
Information bits \mathcal{I}_m	24 28 30 31 32 36 38 39 40 42 43 44 45 46 47 48 49 50 51 52 53 54 55 56 57 58 59 60 61 62 63 64

performances of the puncturing methods under SC decoding are shown in Figure 7. Observe that the proposed puncturing pattern yields the best result and offers a coding gain of about 0.3 dB at $\text{BLER}=10^{-4}$. This coding gain is smaller than that in the previous case. This is due to the fact that a higher number of bits are punctured which, in turn, produces a code with a high rate of $R' = 0.8$.

The performances of the puncturing schemes under CRC-aided SC list decoding are shown in Figure 8. The CRC coded bits are put in the locations of the last 16 information bits. Observe that, in this case also, the proposed puncturing method performs better than the QUP [4] and the method in [5]. Similar to the previous case, we have experienced a reduction in the coding gain. The coding gain is around 0.2 dB at $\text{BLER}=10^{-4}$.

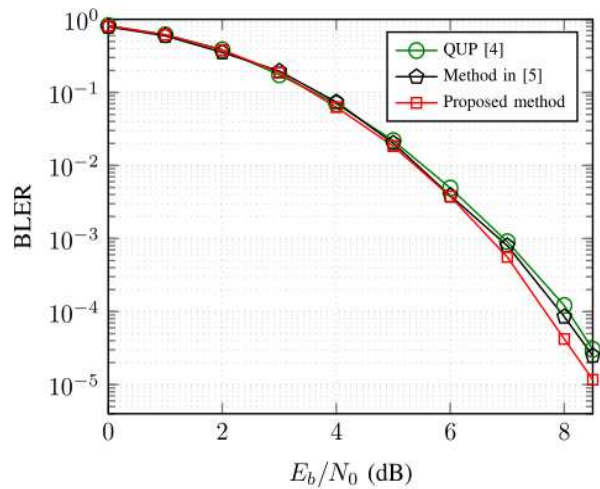

Fig. 7: Comparison under SC decoding, Case 2.

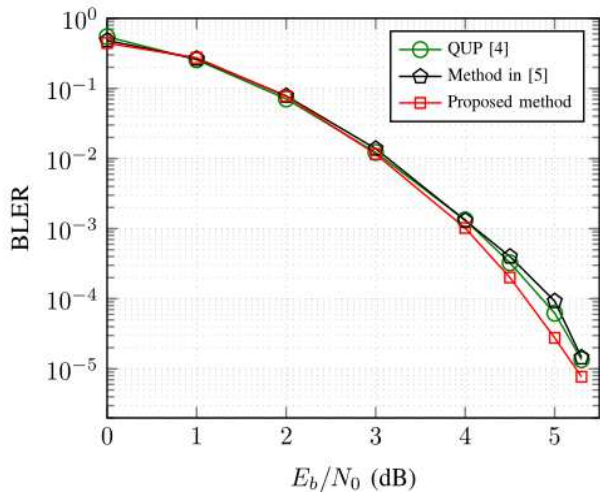

Fig. 8: Comparison under CRC-aided SC list decoding, Case 2.

V. CONCLUSIONS

This paper presented a DE-based technique to search for the optimum pair of the puncturing and the information bits for length-compatible polar codes. By analyzing the decoding progression under puncturing, the even-indexed bits and the last odd-indexed bit are excluded from the search space. DE-based optimization is carried over this reduced space. Simulation results are provided to compare the proposed method with other methods in literature.

REFERENCES

- [1] E. Arıkan, "Channel Polarization: A Method for Constructing Capacity-Achieving Codes for Symmetric Binary-Input Memoryless Channels," *IEEE Transactions on Information Theory*, vol. 55, no. 7, pp. 3051–3073, July 2009.
- [2] R. Mori and T. Tanaka, "Non-binary Polar Codes Using Reed-Solomon codes and Algebraic Geometry Codes," in *IEEE Information Theory Workshop, 2010*, Aug 2010, pp. 1–5.
- [3] S. B. Korada, E. Sasoglu, and R. Urbanke, "Polar Codes: Characterization of Exponent, Bounds, and Constructions," *IEEE Transactions on Information Theory*, vol. 56, no. 12, pp. 6253–6264, Dec 2010.
- [4] K. Niu, K. Chen, and J. Lin, "Beyond Turbo Codes: Rate-compatible Punctured Polar Codes," in *IEEE International Conference on Communications (ICC)*, June 2013, pp. 3423–3427.

- [5] R. Wang and R. Liu, "A Novel Puncturing Scheme for Polar Codes," *IEEE Communications Letters*, vol. 18, pp. 2081–2084, Dec 2014.
- [6] D. Shin, S. Lim, and K. Yang, "Design of Length-Compatible Polar Codes Based on the Reduction of Polarizing Matrices," *IEEE Transactions on Communications*, vol. 61, no. 7, pp. 2593–2599, July 2013.
- [7] L. Chandesaris, V. Savin, and D. Declercq, "On Puncturing Strategies for Polar Codes," in *2017 IEEE International Conference on Communications Workshops (ICC Workshops)*, May 2017, pp. 766–771.
- [8] R. Storn and K. Price, "Differential Evolution – A Simple and Efficient Heuristic for global Optimization over Continuous Spaces," *Journal of Global Optimization*, vol. 11, no. 4, pp. 341–359, Dec 1997. [Online]. Available: <https://doi.org/10.1023/A:1008202821328>
- [9] Harish Vangala, Emanuele Viterbo, Yi Hong, "A comparative study of polar code constructions for the AWGN channel," *arxiv.org*, 2015.
- [10] P. Trifonov, "Efficient Design and Decoding of Polar Codes," *IEEE Transactions on Communications*, vol. 60, no. 11, November 2012.
- [11] Peiyang Zhu, "Polar Code for 5G NR," ITW 2018 Keynote, available online: <http://itw2018.org/static/resource/Keynote-Peiyang.pdf>.
- [12] I. Tal and A. Vardy, "List Decoding of Polar Codes," *IEEE Transactions on Information Theory*, vol. 61, no. 5, pp. 2213–2226, May 2015.

