A SYSTEMATIC REVIEW ON CONTEXT-AWARE RECOMMENDER SYSTEMS USING DEEP LEARNING AND EMBEDDINGS

A PREPRINT

Igor André Pegoraro Santana
Department of Informatics (DIN)
State University of Maringá
Maringá, Paraná, Brazil
pg400816@uem.br

Marcos Aurelio Domingues
Department of Informatics (DIN)
State University of Maringá
Maringá, Paraná, Brazil
madomingues@uem.br

ABSTRACT

Recommender Systems are tools that improve how users find relevant information in web systems, so they do not face too much information. In order to generate better recommendations, the context of information should be used in the recommendation process. Context-Aware Recommender Systems were created, accomplishing state-of-the-art results and improving traditional recommender systems. There are many approaches to build recommender systems, and two of the most prominent advances in area have been the use of Embeddings to represent the data in the recommender system, and the use of Deep Learning architectures to generate the recommendations to the user. A systematic review adopts a formal and systematic method to perform a bibliographic review, and it is used to identify and evaluate all the research in certain area of study, by analyzing the relevant research published. A systematic review was conducted to understand how the Deep Learning and Embeddings techniques are being applied to improve Context-Aware Recommender Systems. We summarized the architectures that are used to create those and the domains that they are used.

Keywords Systematic review · Recommender systems · Context-aware recommender systems · Embeddings · Deep learning

1 Introduction

The use of Recommender Systems (RS) as a technique to filter information that matches the preferences from a user has increased as the amount of information available to the user grow as well. Traditional RS use only information about users and items to generate the recommendations, and they do not take into consideration any contextual information, such as time and place that a user has rated an item [1]. Context-Aware Recommender Systems (CARS) are algorithms that use information beyond users and items to generate those recommendations, and have been developed by academic researchers and applied in a variety of different applications settings [1].

In the past few years due to the decrease in computational cost, Deep Learning (DL) has been applied in many areas of research, due to its capability in solving many complex tasks [2]. In [3], DL shows its strength because it “discovers intricate structure in large data sets by using the backpropagation algorithm to indicate how a machine should change its internal parameters that are used to compute the representation in each layer from the representation in the previous layer”. These representations of the input may have features that describe the input value. As well as DL, Representation Learning (RL) techniques, in special Word Embeddings, has been getting attention due to its effectiveness in storing valuable syntactic and semantic information [4]. Embeddings are a set of techniques that are used to reduce the dimensionality and generate an alternate representation of the input. Both areas are being used to build RS that tries to solve some of the well-known problems (i.e. cold-start and data sparsity) while obtaining state-of-the-art results. Although there are surveys that review DL based RS [2, 5, 6], there are a lack of systematic reviews that reviews CARS that have been built using DL techniques and that use information that is obtained by Embeddings models. The goal of this systematic review is to review literature that proposes DL and Embeddings models to advance the state-of-the-art of CARS in different domains. The remaining of this paper is organized as follows: The section

Background Concepts contain concepts about Embeddings, Deep Learning, CARS and Systematic Reviews that are needed to understand how the systematic review was applied in this work. Then, the protocol used in the review is detailed in the Systematic Review section, followed by the section Results, which discloses the results obtained in the review. Finally, we present some conclusions.

2 Background Concepts

In this section, we present some key concepts that are related to our systematic review, as well as the concepts that are related to the systematic review itself.

2.1 Deep Learning

DL techniques are making major advances in problems that machine learning did not have good results. They are good at discovering intrinsic structures in data that are high-dimensional and applicable to many domains [3]. A neural network is said to be *deep* if it has layers between the input and output layer. Although we call the technique DL, there are different models to be applied to each individual problem.

A model that achieve state-of-the-art results [7] is the Convolutional Neural Network (CNN). It is designed to process multiple arrays as input, with arrays ranging from 1 dimension (signals and sequences) to 3 dimensions (video or volumetric images). In [3], the architecture for a CNN is structured as a series of stages, being the first stages with two types of layers: convolutional and pooling layers. The role of the convolutional layer is to detect local conjunctions of features from the previous layer, and the pooling layer is to merge semantically similar features into one.

A DL model that is usually applied to RS is the Recurrent Neural Network (RNN), and they are specialized in dealing with tasks that involve sequential inputs. They process an input sequence one element at a time, maintaining information about the information that was already processed in the hidden units. Hence, they use information from past iterations to predict the output [3].

2.2 Embeddings

Vector representations of discrete items are being used in distinct areas of studies, mainly because they help solve the problem of the curse of dimensionality [8], which happens when the number of data available grows, increasing the sparsity of the data set, requiring more storage and processing time. The curse of dimensionality can be seen in different areas, as Natural Language Processing [8], RS [9] and Data Mining [10].

One of the first works that tackled the problem of the curse of dimensionality by generating distributed representations is [8], which used a FeedForward Neural Network with a linear projection layer to jointly learn the representations of words and a statistical language model. A common model that is used to generate the representations are the Autoencoders networks. Autoencoders are networks with n units in the input and the output layer, and p units in the hidden layer, where $p < n$ and the main goal is to produce the same result in the output that was used as input. With one linear hidden layer and an error criteria (e.g. mean squared error) to train the network, the p hidden units learn how to project the input value to the output layer. The weights of the p hidden units can be used as representation of the input with less dimensions [11].

Recent advances in Embeddings were presented by [12], with a model called Word2Vec. It was seen that beyond the distributed representations, the model proposed was able to generate representations that are semantically valuable. If algebraic operations are performed on the word vectors, it results in a vector representation closest to what is desirable. As an example, the following operation $\text{vector}(\text{"King"}) - \text{vector}(\text{"man"}) + \text{vector}(\text{"woman"})$ results in the vector representation of the word vector("Queen").

2.3 Context-Aware Recommender Systems

Traditional Recommender Systems only use information about the user and the items which were visited by the user in order to recommend new items. Thus, they do not take into account contextual information to generate those recommendations, such as time, place and the sequence of items visited by the user [1]. The use of contextual information is important because a user may prefer different kinds of items depending on which time of the day he/she is, or with whom he/she is with. In [13], it is said that "accurate prediction of consumer preferences undoubtedly depends upon the degree to which the recommender system has incorporated the relevant contextual information into a recommendation method."

There are multiple ways to incorporate the contextual information into the recommendations process that can be categorized based on two main aspects [1]:

1. What a recommender system may know about the contextual factors;
2. How contextual factors change over time.

The first aspect presumes that a recommender system has information about the contextual factors, and the recommenders are classified depending on how much they know about the factors. For the first aspect, there are three categories:

- *Fully observable*: All the contextual factors, as well as their structure and values that are relevant to the application are known explicitly by the recommender system;
- *Partially observable*: Only some of the information are known explicitly. As an example, the recommender system may know the contextual factors, but not know their structure;
- *Unobservable*: The recommender system has no information about the contextual factor, and it makes the recommendations by using latent knowledge about the data.

The second aspect is whether and how the structure of the contextual factors change over time. There are two categories that the recommenders can be classified depending on how the factors change:

- *Static*: The relevant contextual factors do not change over time;
- *Dynamic*: The contextual factors can change over time. As an example, the recommender system may realize that some factors are not relevant to generate recommendations over time, and not use it anymore.

These categories are used to describe how the CARS interacts with the contextual information, and how it will obtain those information.

2.4 Systematic Review

A systematic literature review (often called systematic review), as described in [14], is adopted to identify, evaluate and to interpret the relevant research available in a particular research area. A systematic review must follow pre-defined phases to review the literature, with the intent of being reproducible. It has three defined phases: planning the review, conducting the review and reporting the results obtained. In the first phase, a research protocol is defined that contains the questions that the systematic review wants to answer as well as the research strategies. The second phase is responsible for applying the research protocol and extracting the results from it. Finally, the results are obtained and it is defined how they will be reported. Systematic reviews only review *primary works*, that are references that contribute or modify the state-of-the art of a research area. Surveys and systematic reviews are called *secondary works*, and they are not reviewed in the systematic review.

2.4.1 Planning

The planning phase of a systematic review is responsible for the identification of the need of the review and the development of the review protocol. In [14], the tasks in the planning phase are described as:

- Identification of the need of the review: the need for a systematic review comes from the requirement to summarize information in a thorough and unbiased manner;
- Formulation of the research question: the most important part of a systematic review, because it guides the entire process. A critical issue in any systematic review is to ask the right question, based on the need;
- Development of the protocol: the critical element of any systematic review, because the review must be reproducible. So, the protocol must have well-defined information.

2.4.2 Conduction

After the protocol is completed, the actual review starts. The tasks that comprehend the conduction phase are described in [14] as the following:

- Searching the references: in this task the research question are applied in data sources that contains references, by using search queries;

- Research selection: once the relevant references has been gathered, they need to be assessed for their relevance. Works that were found in the search must be selected based on inclusion/exclusion criteria;
- Quality assessment (optional): in addition to the inclusion/exclusion criteria, the quality of the reference can be assessed;
- Data extraction: the objective of this task is to obtain useful information from the obtained work. These extracted information must answer the research questions defined previously;
- Data synthesis: this task involves summarizing the results of the data extraction task.

2.4.3 Report

After all the references are obtained from the conduction phase, the results must be communicated. As seen in [14], there are at least two formats in which the review can be reported:

1. Technical report or in a section of a PhD thesis;
2. Journal or conference paper.

Moreover, the results and the information obtained by the systematic review must be understandable to the reader, with insights about the references and graphs so the reader can visualize what is in the references.

3 Systematic Review

The application of the systematic review in this work has the objective of studying how DL and Embeddings are being applied in state-of-the-art CARS algorithms. Every systematic review has questions that the obtained works must answer. In this work, our research questions are the following:

- What models are being used to generate Embeddings for CARS?
- What models are being used to recommend items with DL based CARS?
- In which domains are those models being applied?

After defining the research questions that the systematic review must answer, we begin the planning phase of the systematic review. The main intent of this work, is to summarize the results published in the CARS area that use DL and Embeddings models. There are reviews that summarize works done in traditional RS [2, 5, 6], but not reviews on CARS. To the best of our knowledge, there are no reviews done in the area of Embeddings and DL on CARS.

As the research questions are created and the need for the systematic review is justified, the development of the protocol can start. The protocol must have information about how the references are going to be searched, and the first step is to create research queries that are used to search the data sources for the references. To create those questions, we enumerated terms that are necessary to be found in the references: *deep learning*, *context-aware recommender systems* and *embeddings*. The data sources used to perform the reference search have slightly differences in their syntax, but a generic query can be seen as the following:

(“*deep learning*” AND “*context-aware recommender systems*”) OR (“*embeddings*” AND “*context-aware recommender systems*”)

The objective of this query is to retrieve references that contains the words *context-aware recommender systems* together with *deep learning* or *embeddings*. The search query was applied in different data sources that contains references in the computer science area. The data sources used in this work are the following:

- ACM Digital Library <https://dl.acm.org>
- IEEE Xplore Digital Library <https://ieeexplore.ieee.org>
- ScienceDirect <https://www.sciencedirect.com>
- Springer Link <https://link.springer.com>

Then, the next step of the protocol is to define the selection criteria that is used in the conduction phase. These criteria are applied to the references retrieved from the data sources in order to filter the references that did not match our goal. Only the references that did not match the following exclusion criteria are maintained:

- **C1:** References that have restricted access or that are not written in English;

- **C2:** References that have less than 4 pages, posters, presentations, and tutorials;
- **C3:** References that are secondary works (reviews and surveys);
- **C4:** References that do not propose an approach that aims to improve a context-aware recommender system by using DL or Embeddings.

To finish the planning protocol, it is important to define a set of information that is going to be extracted from each reference that was retrieved, as follows:

- Basic information about the reference, e.g. title, authors, year and where it was published;
- Which dataset was used to perform the experiments;
- If it was used DL or Embeddings;
- Architecture used on DL and Embedding models;
- Domains that the recommendations are made;
- Contextual information used in the recommendation process;
- How the contextual information was used (contextual approach);
- How the results were evaluated (evaluation protocol, metrics, etc);
- Which algorithms were used as baseline.

Once the research protocol was defined, the conduction phase of the systematic review was started. The first step of the conduction phase is to apply the search query to the data sources that contain the references. The results of the search in the data sources can be seen in Table 1. As we can see in the results, ACM Digital Library has the most amount of works found in every data source. This can be explained due to the most famous conference in the RS area, RecSys¹ is hosted by ACM, therefore it is expected to have more results.

Data source	Number of works
ACM Digital Library	193
IEEE Xplore Digital Library	30
ScienceDirect	29
Springer Link	20
Total	272

Table 1: Number of works found in each data source.

To organize the references obtained from the data sources, an application that manages references called Mendeley² was used. The application is useful for removing duplicates, organizing and downloading the references as a PDF file.

After all the references were placed in Mendeley, we started to select the references that did not match with the exclusion criteria. Before that process, the duplicate references were removed, as there was an intersection of works between the data sources. We have removed 41 duplicated references, with a new total of 231 references. Table 2 summarizes the number of references obtained after applying the exclusion criteria defined in the planning phase.

Exclusion criteria	References
Total of References	272
After elimination of duplicates	231
After applying the exclusion criteria C1	227
After applying the exclusion criteria C2	184
After applying the exclusion criteria C3	156
After applying the exclusion criteria C4	16

Table 2: Number of references after each step of the selection.

As we can see in Table 2, most references were removed due to they do not have any proposal of a Context-Aware Recommender System. This check was done by searching the abstract of the references to understand the proposal made by the authors. In some cases, the abstract did not have enough information, so the full text was read to confirm the exclusion.

¹<https://recsys.acm.org>

²<https://www.mendeley.com>

4 Results

In this section, we focus on the 16 references that were obtained as the results of the application of our systematic review. Prior to the research questions, we will discuss some insights obtained by the references.

The references tallied by our systematic review are all recent, with the first work [15] being published in the year of 2014, which is explained by the fact that Embeddings were only proposed in 2013 by [12]. In Figure 1, we can see the growth in the usage of DL and Embeddings techniques to improve CARS.

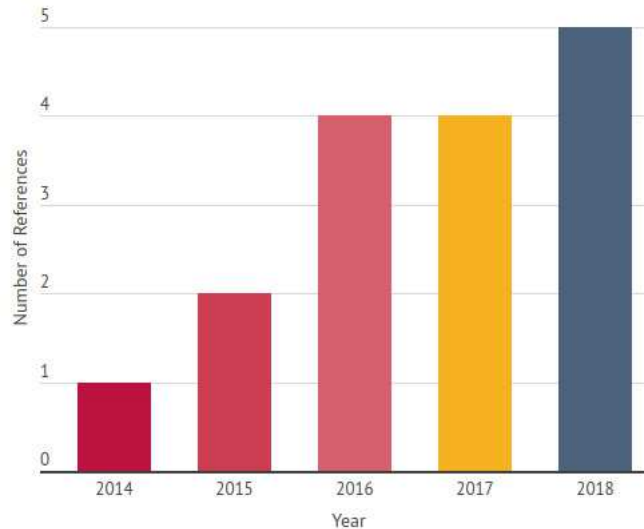

Figure 1: Number of references per year.

The techniques that are being used in the publications are fairly new, and because of that, we can see an increase growth of publications with CARS. The year of 2018 has reached the peak in the number of publications so far, which show us that studies in the area tends to grow even more.

In [16], RS are defined as “tools or techniques that are capable of providing items that the user may like”. Item is a generic definition of what can be recommended by the RS, and it varies according to the domain that the RS is used. Although the references found are in different domains of application, they are mainly focused on dealing with sessions. Sessions are a sequence of interactions that a user have in a web application, and CARS that uses session mostly tries to obtain implicit contextual information about the user behavior. However, most of the references do not exploit the session by itself, but the combination of session and another domain (e.g. music, video) in order to make the recommendations. In Figure 2 we can see the domains in which the recommendations are made, with the Point of Interest (POI) domain being the one that is most explored, in which the recommendation item is a place or a location that the user may find useful or interesting.

The main focus of research from 9 out of 16 references obtained was to deal with sessions paired with different domains. The E-commerce was the most explored domain amongst the other domains, with 3 references [17, 18, 19], followed by Music [20, 21], POI [22], Fashion [23], News [24] and Video [25].

From the references obtained, we can see that Embeddings is more popular than DL for building CARS, as we could gather much more references. As shown in Figure 3, in 10 out of 16 references used Embeddings to build its CARS, 4 used DL techniques and 2 references explored the combination of both techniques.

Although there are more references that use Embeddings than Deep Learning, an interest in the combination of both techniques are rising as they become more popular. [17] and [19] used Embeddings techniques as input to the DL architecture, resulting in better results that pure DL architectures.

In the following subsections, we will discuss the Embeddings and DL models that were used in the references obtained by the systematic review. A brief discussion of the model and how it was applied in each reference is presented. In Table 3, we present a summary of the references that were obtained by the systematic review, which contains the datasets that were used by the references, the domain that was explored and what contextual information where used in the CARS.

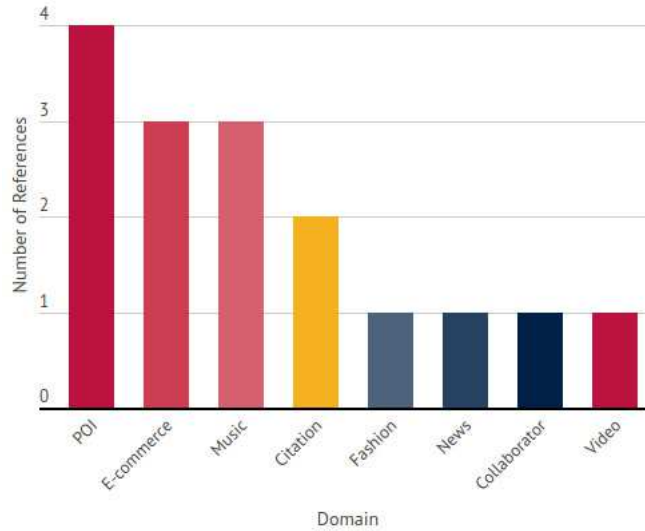

Figure 2: Reference’s domains.

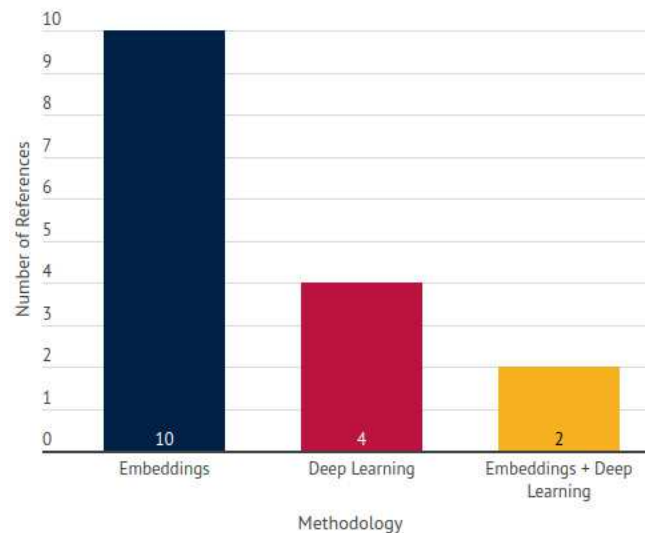

Figure 3: Reference’s techniques.

Embeddings models

The models in the references are used to obtain a distributed representation that will be used as the input of the CARS. From the references, it is possible to obtain three main categories of models that are used: Graph-based models, that explore the weights of the edges of a graph, Neural Networks Embeddings models, that obtain the representations through a process of optimization done by a neural network, and Natural Language Processing (NLP) based models, that use techniques that are used to represent texts and documents as vectors.

The only reference that proposed a model to generate embeddings by using graphs is [29]. They proposed to generate recommendations by using a bipartite graph. A graph $G = (V, E)$ is called bipartite if its vertices V can be partitioned in 2 classes such that every edge has its ends in different classes [32]. As bipartite graphs have 2 classes, [29] built four bipartite graphs: POI-POI, POI-Region, POI-Time and POI-Word. Those graphs map POI to different contextual information, and the embeddings that are generated represent different types of vertices in those graphs. Thus, they captured sequential effect with the POI-Time graph, the geographical influence with the POI-Region and the semantic effect with the POI-Word by embedding the graphs into a share low dimensional space, and using the

Reference	Dataset	Type of model	Domain	Contextual Information
[15]	Chinese Journal of Computers	Embeddings	Citation	Words around citation
[26]	SinaWeibo	Embeddings	Music	Emotion
[27]	POIs em Bersebá, Israel	Embeddings	POI	Mobile sensor data
[28]	Library of Quotes	Embeddings	Citation	Words around citation
[17]	RecSys 2015 Challenge	Embeddings and Deep Learning	E-commerce	Click sequence
[29]	Foursquare e Gowalla	Embeddings	POI	Geo-referenced data, Time and Semantic Information
[20]	Xiami Music	Embeddings	Music	Sequence, Time and Location
[30]	Gowalla e Yelp	Embeddings	POI	Geo-referenced data and Social Network Information
[18]	YooChose e proprietary data	Deep Learning	E-commerce	Time and Type of interaction
[22]	Foursquare e Gowalla	Embeddings	POI	Sequence of POIs
[23]	Zalando	Deep Learning	Fashion	Features and Click sequence
[24]	Adressa 16G e Last.fm	Deep Learning	News	Time
[31]	AMiner	Embeddings	Collaborator	Collaboration topics
[25]	Youtube	Deep Learning	Video	Time, Device and page
[19]	Tianchi e JD	Embeddings and Deep Learning	E-commerce	Time
[21]	Xiami Music	Embeddings	Music	Time and Device

Table 3: Summary of the references obtained by the Systematic Review.

relations between the nodes to generate the recommendations. Those effects influence the recommendation, just like in a traditional CARS.

The references that proposed approaches based on Neural Networks used different types of neural networks to generate the distributed representations. [27] used Autoencoder neural networks, that are unsupervised learning algorithms that applies backpropagation to reduce the error. The main goal is to produce in the output layer the same value given as input, and using the weights in the inner layer to represent the input with fewer dimensions, as it can be seen in Figure 5a.

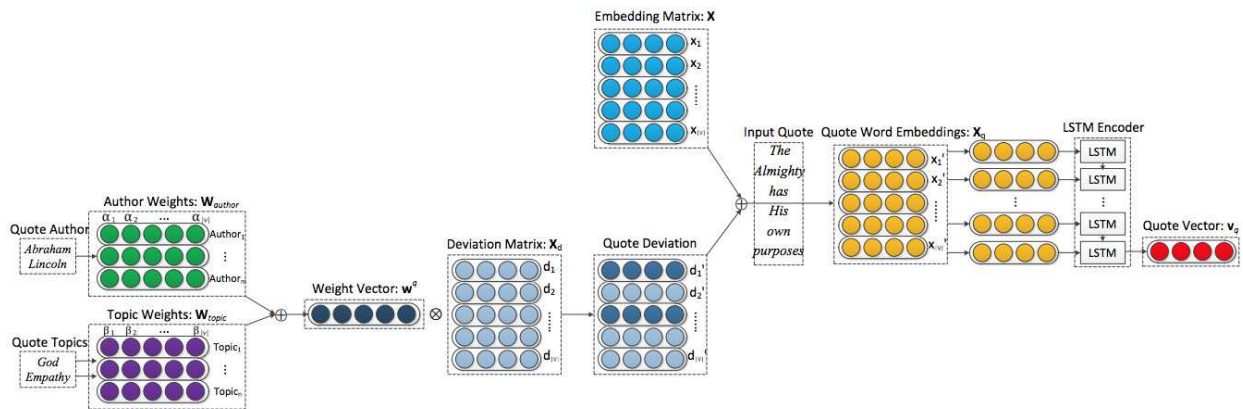
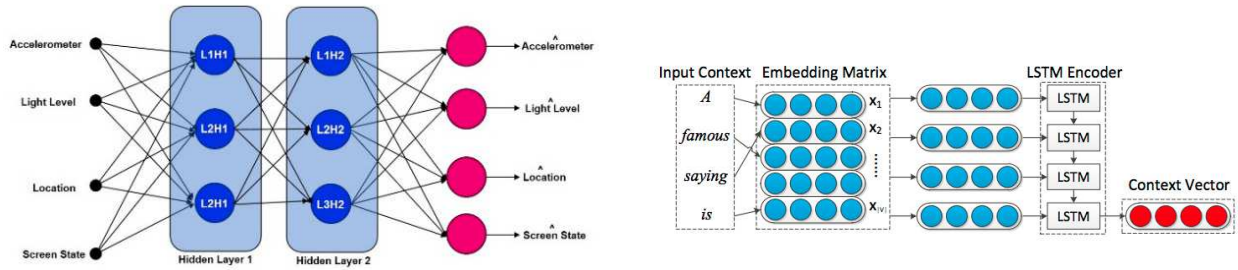

Figure 4: The entire Embeddings architecture, that converts a quote into a vector [28].

In [28], an LSTM encoder was proposed to learn the semantic representations of quotes in the context in which they could be used. It used two different encoders: a context encoder Figure 5b, which encodes the sequence of words in a paragraph into a fixed-dimensional representation vector, and a quote encoder Figure 4, that maps an quote into a fixed-dimensional representation vector. Quotes as slightly different from paragraphs, as the words used in it might have different meanings.

The work developed by [31] tries to recommend collaborators that are likely to work with a researcher in a given topic. It does so by using a model called Collaborative Entity Embedding, which maps topics and researchers in compact

vector spaces. These vector spaces contain the researchers collaboration tendencies and topics underlying semantics. It adopts a dual-structure, as it can be seen in Figure 5d, which preserves the mutual-dependency while modeling entities' (i.e. researchers and topics) co-occurrence relationship.



(a) Usage of an Autoencoder to generate the Embeddings vector [27]. (b) Architecture of the model that converts the context into a vector [28].

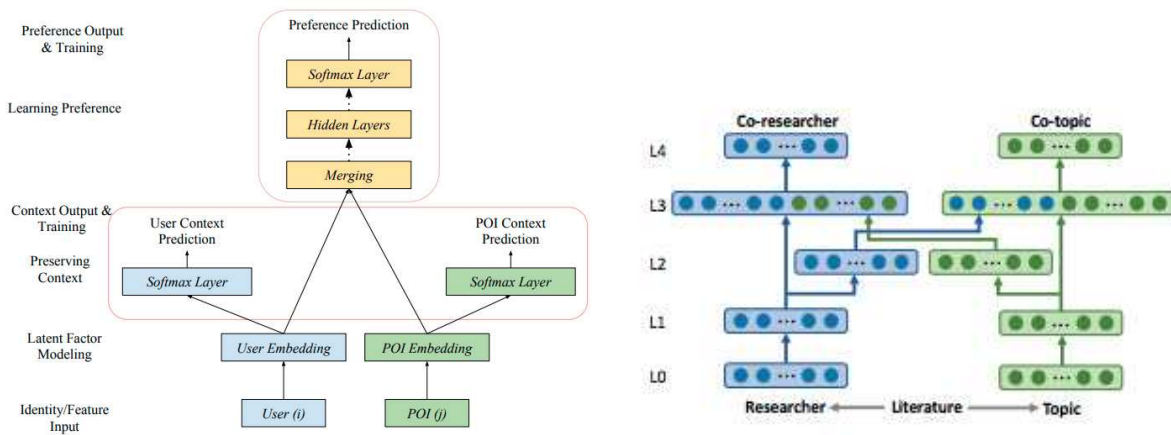

(c) Merging of the embeddings from an user and a POI to generate the recommendations [30]. (d) Dual-architecture of the recommender, in which the embedding vector is generated in layer L1 [31].

Figure 5: Models that use Embeddings to generate the recommendations.

Finally, the work developed by [30] uses Deep neural networks to model the user preference for a given POI. Although they generate representations to represent the users and the items, the context preference is obtained by a NLP-based model called Skip-gram. In Figure 5c we have the overall architecture used to generate the recommendations.

The remaining references that use Embeddings are based on NLP models. Most of the works are based on the models proposed by [12], which maps words into word vectors. However, the references [15, 26] that were first published regarding the usage of embeddings in CARS used the Bag-of-Words technique to create the vectors. [15] extends a model proposed by [33], which uses bags-of-visual terms to represent images. Instead of using visual terms, they obtain terms by the annotations, which are then used in the process of recommending citation in scientific articles. The reference maps the contexts and the citations into the same low dimensional space, with the assumption that if a context cites several papers, the papers should have the similar topic and be mapped into similar vectors.

In [26], the bag-of-words model is used to map emotions obtained by a classification system into a vector representation, and the length of the vector is based on the number of emotions that can be classified by the system. That way, they use the emotions as context to improve the music recommendation process.

The remaining models are based on the Word Embeddings models proposed by [12]: Continuous Bag-of-Words (CBOW) and Continuous Skip-Gram. In Figure 6, we show the architecture used on both models. In the CBOW model, the projection layer is shared for all words, and, because of that, all words are projected into the same position and their vectors are averaged. In this model, the order of the words does not influence the projection. The Continuous Skip-gram model is similar to the CBOW, but instead of predicting the word based on the context that the word is, it tries to predict the context based on the word. Each word is used as input to a log-linear classifier with a continuous projection layer to predict words within a certain range.

In [17] the authors developed a model similar to the one proposed by [12], and it was used to generate the embeddings that were used as input and output to an DL model. In this case, embeddings were used to reduce the dimensionality of the data from one-hot encoding to a much smaller vector. That way, the goal of the DL model is to predict the embedding which will represent item to be recommended.

In [20], the authors propose a Music Embedding Model, which is based on the CBOW. The model includes metadata from music and additional context information to CBOW, with the goal of predicting the music based on its local context (the words on the input), metadata and additional context information. This model was used to generate the embeddings for the songs and the user preference, that is the average of the embeddings of all songs he/she listened to. Then, the top-N most similar songs were recommended to the user by using the cosine similarity.

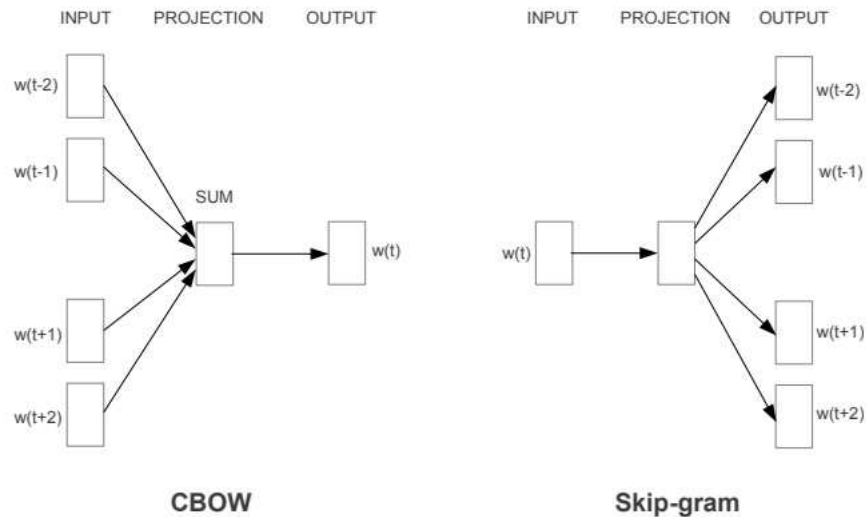

Figure 6: Models proposed by [12]

The model proposed by [22] extends the Skip-gram model to generate the Embeddings according to the sequence of POIs visited by the user. What could be seen as a sentence in the models presented by [12] are treated as the sequence of check-ins that a user made. In addition to the POIs, the temporal state (weekday and weekend) in which the check-in is made was also added to the model.

The work done by [19] to generate the Embeddings is an extension of the method proposed by [34] called item2vec, which maps items for Collaborative Filtering RS into a vector representation. [19] extended the method by using the frequency in which the items appeared within a sequence as a weighted factor in the process of generating the Embeddings.

Finally, the work method proposed in [21] uses the Skip-gram model as well, but it does so in two distinct ways: an user and a session-based. The user-based is used by feeding all the musics that the user has listened to as a sequence to the Skip-gram model, and the session-based splits the data into sessions, feeding them as sequence instead of the user's listening history.

Deep Learning Models

In order to generate contextual recommendations using DL models, all of the works used information about the time in which the ratings were given, by using the Timestamp itself as an attribute or the sequence in which the ratings are in the data, using that order to extract the intrinsic behavior of the user.

The most used models to deal with sequence of data are the RNN, which were used in the following references [17, 18, 24, 25, 19]. The only reference that didn't use a RNN was [23]. However, only the work done by [17] used a pure RNN to generate the recommendations while all the others did modifications in the model. [17] also used embeddings to represent the data in the input, as pointed in Figure 9b.

The work proposed by [18] changed the model of the RNN in two ways: (1) By changing the representation of the item, creating a representation that contained both contextual information and information about the item, in order to capture context-dependent item similarities, and (2) They conditioned the hidden dynamics of the RNN to work with

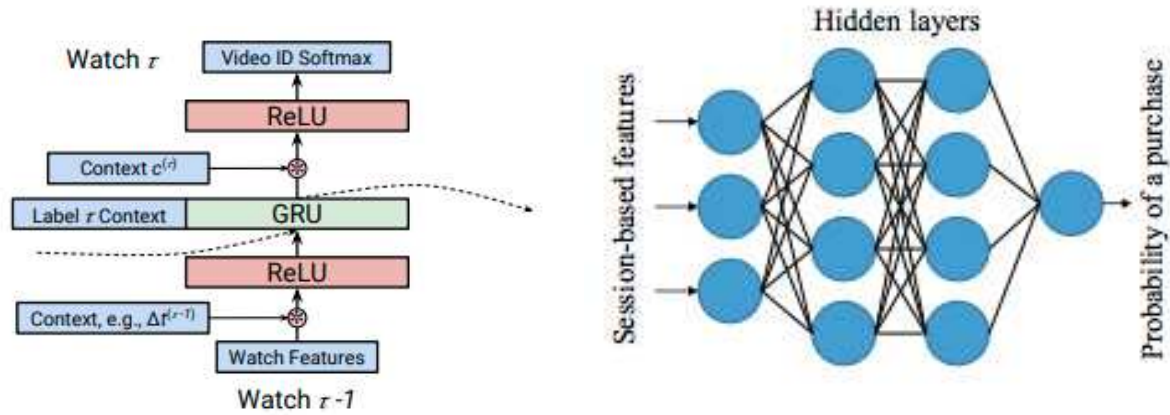

(a) How the context was used in the diagram of the RNN [25]. (b) Feed forward Network that outputs the probability of a purchase [23].

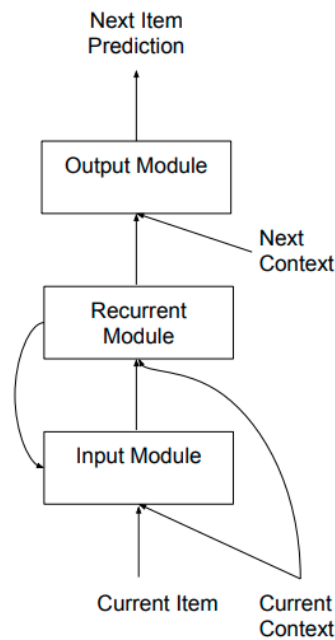

(c) How the contextual sequence is modeled in the recurrent architecture [18].

Figure 7: Models that use DL to generate the recommendations

contextual information. How the contextual information was used can be seen in Figure 7c. This model was used to deal with a recommendation strategy called Next-Item Prediction, in which the recommender must predict the next item that a user will most-likely enjoy, based on the past interactions of the user.

The work proposed by [25] used RNNs with a technique known as *Latent Cross*, which first uses different contextual information in the RNN model. The Latent Cross technique embed the contextual information before and after the hidden states, by performing an element-wise product of the context embedding with model’s hidden states. They used this model in the video domain, using contextual information about which page and device the video was played, as well as the time. Figure 7a presents the general architecture of the model.

In [24], a combination of two DL techniques (presented in Figure 8) were used: CNN and RNN. The model that unified both techniques to generate the recommendation was called DeepJoNN, and it is used to recommend news to users. Their model first encodes the input data in a character-level representation of a matrix. Then, a CNN is used to extract patterns of features from streams of click events within sessions. Finally, the RNNs are used to generate the recommendations from the patterns found by the CNN, predicting the top-N most valuable items to the user. In

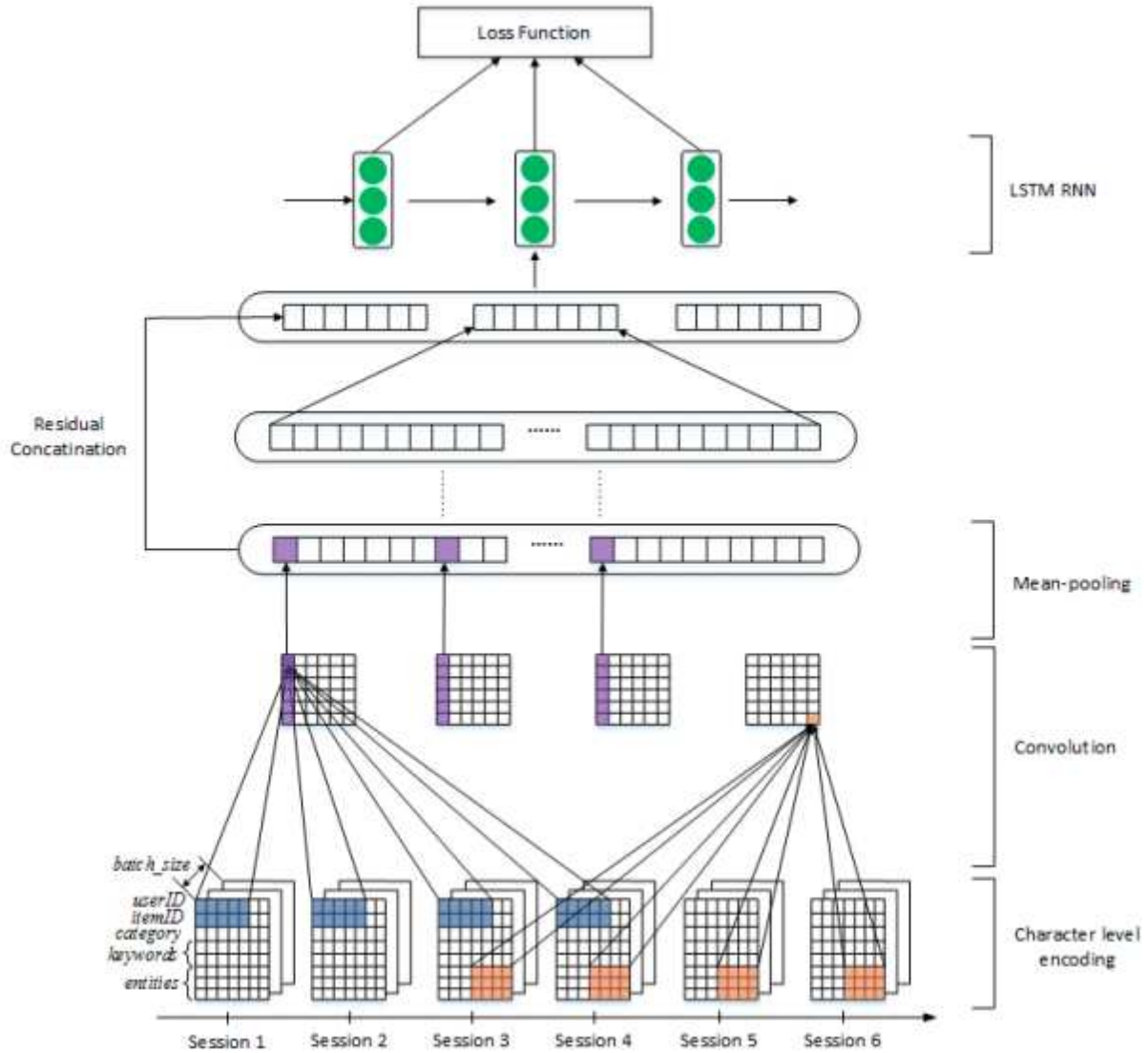
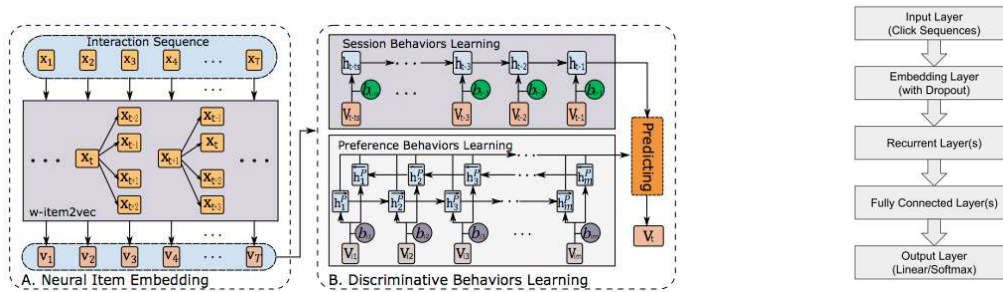

Figure 8: The architecture with a convolutional layer and an LSTM network [24].

order to address the problem of exploding/vanishing gradient when learning long-term dependencies, Long Short-Term Memory (LSTM) units were used to optimize the traditional RNN.

In the work done by [19], they have used both Embeddings and DL models to improve their CARS, as shown in Figure 9a. The output of the Embeddings phase is used as the input of the DL model, which consists in two RNNs with LSTM units. The first RNN, called *Preference Behaviors Learning*, is used to learn what part of the user's behavior imply its stable historical preferences. It does so by using a Bi-Contextual LSTM (B-CLSTM), inspired by the Bi-directional RNN proposed in [35], to make use of the long-term representation of the context in both forward and backward direction. The second RNN is called *Session Behaviors Learning*, and its goal is to learn short-term session behavior of the user, that represents the user present's motivation. As they only want to learn the present user's preferences, they use a simple Contextual LSTM instead of a B-CLSTM.

The only work found that used DL models that did not use any type of RNNs is the one proposed by [23], which uses Feed Forward Neural Networks (FFNN), as displayed in Figure 7b. In this work, the DL model was applied as a post-processing phase to a traditional RS that take into account features of the items, in order to re-rank the results obtained by the RS. The model consider each item as an unlabeled example and then generate values for all the features given



(a) The embeddings model converts the sequence of input to the Deep Learning architecture [19]. (b) Architecture using Embeddings as input to the RNN [17].

Figure 9: Models that used both Embeddings and Deep Learning

the current session, with an output as to the probability that the user will buy the item. The top-N results generated by the RS are re-ranked accordingly to the probability obtained in the output of the FFNN.

5 Conclusion

Recommender Systems are tools to filter the information that is available to a user by using its preferences. The use of contextual information in the process of generating the recommendations can improve the algorithm because the preferences and the behavior of a user depends on the context in which he/she is. In this work, a systematic review was conducted with the goal of understanding how CARS are using techniques that accomplished state-of-the-art results in different research areas to improve its recommendations, either by using it to obtain the context or to generate the recommendations. We analyzed 16 references from different data sources, and from them we can conclude that the area of Context-Aware Recommender Systems has recently been using Deep Learning, Embeddings and even further the combination of both techniques to improve the recommendations, obtaining great success, especially in the applications that deal with recommending items to an user by analyzing the user's session.

From our systematic review, we can conclude that there are some trends in the models used, both in Deep Learning and Embeddings. The most used DL model are the Recurrent Neural Networks, which are designed to be effective when dealing with sequences of data. The RNN models were effective to obtain contextual information from the sequence of input data, and outperformed the baseline models in different domains, showing that those models can be used as CARS. Word2Vec was the most used model, and was modified by the almost all of the references, according to the domain. Distributed representations, generated both by Embeddings or Deep Learning models were capable of extracting contextual information from the data, improving the recommendations obtained by CARS. One of the reasons of its success is the possibility to calculate the similarity between the items more easily, as they are presented as vectors of real numbers.

Acknowledgements

The authors would like to thanks CAPES/CNPq for financial support.

References

- [1] Gediminas Adomavicius, Bamshad Mobasher, Francesco Ricci, and Alexander Tuzhilin. Context-Aware Recommender Systems. In *AI Magazine*, volume 32, page 67. oct 2011.
- [2] Shuai Zhang, Lina Yao, Aixin Sun, and Yi Tay. Deep Learning based Recommender System: A Survey and New Perspectives. *arXiv e-prints*, 2017.
- [3] Yann LeCun, Yoshua Bengio, and Geoffrey E Hinton. Deep learning. *Nature*, 521(7553):436–444, 2015.
- [4] Jose Camacho-Collados and Mohammad Taher Pilehvar. From Word to Sense Embeddings: A Survey on Vector Representations of Meaning. *arXiv e-prints*, 2018.
- [5] Juntao Liu and Caihua Wu. Deep learning based recommendation: A survey. In *Lecture Notes in Electrical Engineering*, volume 424, pages 451–458. Springer, Singapore, 2017.

- [6] Basiliyos Tilahun, Charles Awono, and Bernabe Batchakui. Deep Learning Methods on Recommender System: A Survey of State-of-the-art. *International Journal of Computer Applications*, 162(10):17–22, 2017.
- [7] Alex Krizhevsky and Geoffrey E. Hinton. ImageNet Classification with Deep Convolutional Neural Networks. In F Pereira, C J C Burges, L Bottou, and K Q Weinberger, editors, *Neural Information Processing Systems*, pages 1–9. Curran Associates, Inc., 2012.
- [8] Yoshua Bengio, Réjean Ducharme, Pascal Vincent, and Christian Janvin. A neural probabilistic language model. *Journal of Machine Learning Research*, 3:1137–1155, 2001.
- [9] X. Amatriain and J. M. Pujol. Data mining methods for recommender systems. In *Recommender Systems Handbook, Second Edition*, pages 227–262. Springer US, Boston, MA, 2015.
- [10] Michel Verleysen and Damien François. The Curse of Dimensionality in Data Mining and Time Series Prediction. In *Computational Intelligence and Bioinspired Systems*, pages 758–770. Springer, Berlin, Heidelberg, 2005.
- [11] H. Bourlard and Y. Kamp. Auto-association by multilayer perceptrons and singular value decomposition. *Biological Cybernetics*, 59(4-5):291–294, 1988.
- [12] Tomas Mikolov, Kai Chen, Greg Corrado, and Jeffrey Dean. Efficient Estimation of Word Representations in Vector Space. *Computing Research Repository*, abs/1301.3, 2013.
- [13] Gediminas Adomavicius, Ramesh Sankaranarayanan, Shahana Sen, and Alexander Tuzhilin. Incorporating contextual information in recommender systems using a multidimensional approach. *ACM Transactions on Information Systems*, 23(1):103–145, jan 2005.
- [14] Barbara Kitchenham. Procedures for performing systematic reviews. Keele University. Technical Report TR/SE-0401 TR/SE-0401, Department of Computer Science, Keele University, UK, 2004.
- [15] Xuewei Tang, Xiaojun Wan, and Xun Zhang. Cross-language context-aware citation recommendation in scientific articles. In *Proceedings of the 37th international ACM SIGIR conference on Research & development in information retrieval - SIGIR '14*, pages 817–826, New York, New York, USA, 2014. ACM Press.
- [16] Francesco Ricci, Bracha Shapira, and Lior Rokach. Recommender systems: Introduction and challenges. In Francesco Ricci, Lior Rokach, and Bracha Shapira, editors, *Recommender Systems Handbook, Second Edition*, pages 1–34. Springer US, Boston, MA, 2015.
- [17] Yong Kiam Tan, Xinxing Xu, and Yong Liu. Improved Recurrent Neural Networks for Session-based Recommendations. *Proceedings of the 1st Workshop on Deep Learning for Recommender Systems - DLRS 2016*, pages 17–22, 2016.
- [18] Elena Smirnova and Flavian Vasile. Contextual Sequence Modeling for Recommendation with Recurrent Neural Networks. In *Proceedings of the 2Nd Workshop on Deep Learning for Recommender Systems*, DLRS 2017, pages 2–9, New York, NY, USA, 2017. ACM.
- [19] Zhi Li, Hongke Zhao, Qi Liu, Zhenya Huang, Tao Mei, and Enhong Chen. Learning from History and Present: Next-item Recommendation via Discriminatively Exploiting User Behaviors. In *Proceedings of the 24th ACM SIGKDD International Conference on Knowledge Discovery & Data Mining*, KDD '18, pages 1734–1743, New York, NY, USA, 2018. ACM.
- [20] Dongjing Wang, Shuiguang Deng, Xin Zhang, and Guandong Xu. Learning Music Embedding with Metadata for Context Aware Recommendation. In *Proceedings of the 2016 ACM on International Conference on Multimedia Retrieval*, ICMR '16, pages 249–253, New York, NY, USA, 2016. ACM.
- [21] Dongjing Wang, Shuiguang Deng, and Guandong Xu. Sequence-based context-aware music recommendation. *Information Retrieval Journal*, 21(2-3):230–252, jun 2018.
- [22] Shenglin Zhao, Tong Zhao, Irwin King, and Michael R. Lyu. Geo-Teaser: Geo-Temporal Sequential Embedding Rank for Point-of-interest Recommendation. In *Proceedings of the 26th International Conference on World Wide Web Companion - WWW '17 Companion*, pages 153–162, New York, New York, USA, 2017. ACM Press.
- [23] Dietmar Jannach, Malte Ludewig, and Lukas Lerche. Session-based item recommendation in e-commerce: on short-term intents, reminders, trends and discounts. *User Modeling and User-Adapted Interaction*, 27(3-5):351–392, dec 2017.
- [24] Lemei Zhang, Peng Liu, and Jon Atle Gulla. A Deep Joint Network for Session-based News Recommendations with Contextual Augmentation. In *Proceedings of the 29th on Hypertext and Social Media - HT '18*, pages 201–209, New York, New York, USA, 2018. ACM Press.
- [25] Alex Beutel, Paul Covington, Sagar Jain, Can Xu, Jia Li, Vince Gatto, and Ed H. Chi. Latent Cross: Making Use of Context in Recurrent Recommender Systems. In *Proceedings of the Eleventh ACM International Conference on Web Search and Data Mining - WSDM '18*, pages 46–54, New York, New York, USA, 2018. ACM Press.

- [26] Shuiguang Deng, Dongjing Wang, Xitong Li, and Guandong Xu. Exploring user emotion in microblogs for music recommendation. *Expert Systems with Applications*, 42(23):9284–9293, 2015.
- [27] M. Unger. Latent context-aware recommender systems. In *RecSys 2015 - Proceedings of the 9th ACM Conference on Recommender Systems*, RecSys '15, pages 383–386, New York, NY, USA, 2015. ACM.
- [28] Jiwei Tan, Xiaojun Wan, and Jianguo Xiao. A Neural Network Approach to Quote Recommendation in Writings. In *Proceedings of the 25th ACM International on Conference on Information and Knowledge Management - CIKM '16*, CIKM '16, pages 65–74, New York, NY, USA, 2016. ACM.
- [29] Min Xie, Hongzhi Yin, Hao Wang, Fanjiang Xu, Weitong Chen, and Sen Wang. Learning Graph-based POI Embedding for Location-based Recommendation. In *Proceedings of the 25th ACM International on Conference on Information and Knowledge Management - CIKM '16*, CIKM '16, pages 15–24, New York, NY, USA, 2016. ACM.
- [30] Carl Yang, Lanxiao Bai, Chao Zhang, Quan Yuan, and Jiawei Han. Bridging Collaborative Filtering and Semi-Supervised Learning. In *Proceedings of the 23rd ACM SIGKDD International Conference on Knowledge Discovery and Data Mining - KDD '17*, pages 1245–1254, New York, New York, USA, 2017. ACM Press.
- [31] Zheng Liu, Xing Xie, and Lei Chen. Context-aware Academic Collaborator Recommendation. In *Proceedings of the 24th ACM SIGKDD International Conference on Knowledge Discovery & Data Mining - KDD '18*, pages 1870–1879, New York, New York, USA, 2018. ACM Press.
- [32] Reinhard Diestel. The Basics. In *Graph Theory*, Graduate Texts in Mathematics, chapter 1, pages 1–34. Springer-Verlag Berlin Heidelberg, 5 edition, 2017.
- [33] Jason Weston, Samy Bengio, and Nicolas Usunier. Large scale image annotation: Learning to rank with joint word-image embeddings. *Machine Learning*, 81(1):21–35, 2010.
- [34] Oren Barkan and Noam Koenigstein. ITEM2VEC: Neural item embedding for collaborative filtering. In *IEEE International Workshop on Machine Learning for Signal Processing, MLSP*, volume 2016-Novem, pages 1–6, 2016.
- [35] Mike Schuster and Kuldip K. Paliwal. Bidirectional recurrent neural networks. *IEEE Transactions on Signal Processing*, 45(11):2673–2681, 1997.

This figure "orcid.png" is available in "png" format from:

<http://arxiv.org/ps/2007.04782v1>