

# Common equivalence and size after forgetting

Paolo Liberatore\*

## Abstract

Forgetting variables from a propositional formula may increase its size. Introducing new variables is a way to shorten it. Both operations can be expressed in terms of common equivalence, a weakened version of equivalence. In turn, common equivalence can be expressed in terms of forgetting. An algorithm for forgetting and checking common equivalence in polynomial space is given for the Horn case; it is polynomial-time for the subclass of single-head formulae. Minimizing after forgetting is polynomial-time if the formula is also acyclic and variables cannot be introduced, NP-hard when they can.

## 1 Introduction

Logical forget is done to: reduce the space needed to store information [EKI19]; simplify reasoning [DW15, EF07, WSS05]; clarify the relationship between variables [Del17]; formalize the limited knowledge of agents [FHMV95, RHPT14]; ensure privacy [GKLW17]; merge information coming from different sources [WZZZ14]; restore consistency [LM10].

The first four aims are missed if the result is too large. The space needed to store information increases instead of reducing. Reasoning from larger knowledge bases is likely harder rather than simpler. The relationships between variables are probably obfuscated by an increase in size. A limit in knowledge storage ability is never enforced by enlarging a formula. Regardless of the aim, a large formula poses problems of storage, reasoning and ease of interpretation.

That forgetting increases size is counterintuitive since forgetting is removing facts or objects from consideration. Yet, it is known to be possible in various logics [EW06, KWW09, DW15, GKL16, Lib20]. To complicate the matter, what results from forgetting may be large or small depending on the original formula; and may be equivalent to small formulae or not. For example, the classical syntactic definition of forget in propositional logic always doubles the size of the formula for each forgotten variables, but size may often be reduced.

Besides forgetting, this is the old problem of logic minimization [Cou94, CS02, UVSV06]. It originates from electronic circuit synthesis: given a Boolean function, design a circuit that realizes it. The simpler the circuit, the better. Various solutions have been developed like the Karnaugh maps [Kar53], the Quine-McCluskey method [McC56] and the Espresso algorithm [RSV87].

A way to make a formula smaller is to introduce new variables [BB10, BDMT10, CDLS00, CMLLM04]. This may look like a vicious circle: variables are first removed, then added back.

---

\*DIIAG, Sapienza University of Rome. liberato@diag.uniroma1.it

But is not. Variables that are unneeded or unwanted are forgotten; if the result is too big, other variables are introduced to make it smaller. The key is “other”: other variables, other meanings. The original variables are removed because they have to. They are not relevant to a certain context, they cause inconsistencies, they have to be hidden for legal reasons, etc. If the result is too large, other variables are introduced to the sole aim of reducing size. They are not the same variables that were deleted in the first place. They should not, as otherwise forgetting was pointless.

Introducing variables also has epistemological motivations. If a variable condenses a formula, a question arises: does this happen by chance only? The variable has no meaning by itself, it just reduces the size of the formula by pure luck. It so happens. But simpler explanations are usually considered better than complicated ones. If the shorter formula is a better representation of knowledge, it may be so because it is closer to the situation it represents. The added variable represents a real fact, rather than being the prop of a magic trick to reduce size. It was missing from the original formula because the fact was hidden, not directly observable. Reducing size had the indirect benefit of uncovering it.

Forgetting and introducing variables have something in common: they both change the alphabet of the formula while retaining some of its consequences. This is formalized by restricted equivalence [FKL93], the equality of the consequences on a given subset of variables. When this subset comprises all variables, restricted equivalence is regular equivalence. When some variables are missing, only the consequences that do not contain those variables matter.

**Forgetting** is removing variables while retaining the consequences on the others; the result is equivalent to the original when restricting to the other variables.

**Introducing** is adding variables while retaining the consequences on the original variables; the result is equivalent to the original when restricting to the original variables.

**Forgetting and introducing** is removing and adding variables while retaining the consequences on the original variables not to be forgotten; the result is equivalent to the original when restricting to these variables.

Forgetting, introducing, forgetting and then introducing variables are all formalized by restricted equivalence. A subcase of it, actually: the restriction is on the variables that are shared between the input and the output formula. This is common equivalence: equality of the consequences on the common variables. Apart from the slight simplification of not explicitly requiring a set of variables, common equivalence forbids reintroducing a removed variable with a different meaning, which restricted equivalence allows.

Forget can be expressed in terms of restricted and common equivalence, but also the other way around. Both forms of equivalence amount to forget the variables that do not matter and then check regular equivalence. Theoretically, this can always be done. Computationally, it may not: if the result of forgetting is exponentially large, computing restricted or common equivalence this way requires exponential space while both problems can be solved in polynomial space. The size after forgetting matters again.

The exponentiality of forgetting is not just a possibility nor is due to a specific method of forgetting. For certain formulae and variables to forget, it is a certainty: the result of forgetting cannot be represented in polynomial space. While reducing its size is important, it is not always possible. In such cases, a forgetting algorithm takes exponential time just

because its output is always exponentially large. The time needed to produce it is alone exponential. Yet, the required memory space may not. An algorithm for the Horn case is shown that runs in polynomial space even when it produces an exponential output. As a consequence, checking common equivalence takes polynomial space in the Horn case.

This algorithm unearths a polynomial Horn subclass: it runs in polynomial time when each variable is at most the head of a single clause.

Polynomial running time means polynomially-sized output. Fast enough, but not always small enough. A polynomial output may be quadratic. But even if it is only twice the size of the input, it is still a size increase. Forgetting fails at making the formula smaller. But this is again the output of a specific algorithm. Equivalent but smaller formulae may exist. Surprisingly, it depends on whether they are required to be single-head or not. Either way, the minimal formula can be found in polynomial time if the formula is acyclic [HK95]. Otherwise, a sufficient condition directs the search for the clauses of the minimal formula.

Adding new variables allows reducing size. An algorithm for Horn formulae is given. It is polynomial but unable to always find the minimal formula. Not a fault of the algorithm, however: the problem is NP-complete. It is NP-hard even in the single-head acyclic case. In the same conditions, the problem is polynomial without new variables. The reason is that the new variables may shorten the formula in many ways, and exploring them takes time.

Three implementations of the forgetting algorithm have been developed. They are all based on the same algorithm, but they differ in how they realize nondeterminism. The first is correct only in the single-head case, which does not require nondeterminism. The second is based on using sets to represent the possible outcomes of a nondeterministic choice; it is always correct but may take exponential space. The third employs multiple processes; it is always correct and works in polynomial space. A script uses the third for checking common equivalence. The algorithm for minimizing with new variables is implemented as well.

Most of the examples formulae used in this article are made into test files for these programs.

The next section defines variables forgetting and introduction in terms of restricted and common equivalence and gives some general and complexity results about common equivalence. Section 3 formally proves that forget may exponentially increase size even when equivalent formulae are allowed and when restricting to the definite Horn case. Section 4 presents the algorithms for forgetting and checking common equivalence for definite Horn formulae. They are extended to all Horn formulae in Section 5. The problem of minimizing the formula after forgetting in the single-head case is analyzed in Section 6. Section 7 presents the algorithm for reducing size when variables can be introduced and shows that the problem is NP-hard even in the acyclic single-head case. Section 8 presents the implementations of the algorithms.

## 2 Common equivalence

Forgetting a variable  $x$  from a propositional formula  $F$  is traditionally defined as  $F[\text{true}/x] \vee F[\text{false}/x]$  [Del17]: either the formula holds when  $x = \text{true}$  or it holds when  $x = \text{false}$ . Since  $x$  could only be either true or false anyway, this operation does not change the meaning of the formula, except that it removes  $x$ .

This definition is problematic for at least four reasons: first, it is a mechanism for per-

forming forgetting instead of a semantics for it [Del17]; second, it does not extend outside propositional logic [vdHLM09, EK19, DW15, EF07, EIS+06, AEW12, LR94]; third, it always doubles the size of the formula for each forgotten variable; fourth, it only defines one of the many ways to forget.

The formula that results from forgetting according to this definition is always made of two copies of the original formula; it is double its size. For example, forgetting  $x$  from  $F$  produces  $F'$ :

$$\begin{aligned} F &= (x \vee y) \wedge (\neg x \vee \neg y) \wedge (a \vee b \vee c \vee d) \\ F' &= ((\text{true} \vee y) \wedge (\neg \text{true} \vee \neg y) \wedge (a \vee b \vee c \vee d)) \vee \\ &\quad ((\text{false} \vee y) \wedge (\neg \text{false} \vee \neg y) \wedge (a \vee b \vee c \vee d)) \end{aligned}$$

The resulting formula is double the size of the original. Just applying some simple rules such as  $\text{false} \vee A = A$  simplifies it to  $(\neg y \wedge (a \vee b \vee c \vee d)) \vee (y \wedge (a \vee b \vee c \vee d))$ . Which simplifies to  $(\neg y \vee y) \wedge (a \vee b \vee c \vee d)$  by factorization. Removing the tautology turns it into  $F'' = a \vee b \vee c \vee d$ . Summarizing: forgetting  $x$  from  $F$  produces a larger formula  $F'$  equivalent to the smaller formula  $F''$ .

Being equivalent,  $F'$  and  $F''$  have the same meaning. That meaning is the meaning of the original formula except for the forgotten variable. The first formula  $F'$  tells that forgetting can be done by doubling size, which is always the case. The second formula  $F''$  tells that this can be avoided. This is what matters when evaluating size after forgetting: how small the formula can be, not how large. Logical formulae can always be inflated by adding useless parts such as  $a \vee \neg a$ . How large a formula can be is trivial: any size. What counts is how small it can be.

The two formulae,  $F[\text{true}/x] \vee F[\text{false}/x]$  and its size-reduced version, have the same meaning. They both express forgetting  $x$  from  $F$ . Defining forgetting as the first and then allowing the second to take its place is only a semantical complication. Rather, both formulae express forgetting  $x$  from  $F$  [Lib20].

The question of size after forgetting is: given a formula  $F$  and some of its variables  $X$ , is forgetting  $X$  from  $F$  expressed by some sufficiently small formulae? How small depends on the application, so the maximal allowed size is part of the problem.

When this bound is exceeded, adding variables may take size back down. The resulting formula still expresses forgetting, somehow. Not by equivalence, however. Not strictly, at least.

An example is forgetting  $x$  from  $F = \{ab \rightarrow x, xc \rightarrow d, xc \rightarrow e, xc \rightarrow f\}$ . A minimal formula equivalent to  $F' = F[\text{true}/x] \vee F[\text{false}/x]$  is  $F'' = \{abc \rightarrow d, abc \rightarrow e, abc \rightarrow f\}$ . This formula contains twelve literal occurrences, the same as  $F$ . No further reduction is possible. Not unless variables are introduced. A new variable  $z$  allows for  $F''' = \{abc \rightarrow z, z \rightarrow d, z \rightarrow e, z \rightarrow f\}$ , which only contains ten literal occurrences, two less than the original.

While  $F'''$  has the same meaning of  $F''$ , it is not equivalent to it. Both say that  $abc$  imply  $d$ ,  $e$  and  $f$ . But  $F''$  only says this. Instead,  $F'''$  also predicates about  $z$ . Its value depends on the value of  $z$ , which is not the case for  $F''$ . For example, the model that evaluates all variables to true satisfies both formulae, but the model that evaluates  $z$  to false and all other variables to true satisfies  $F''$  but not  $F'''$ . These formulae are not equivalent.

They are only equivalent when disregarding  $z$ . For example, they entail the same consequences that do not contain  $z$ . They are satisfied by the same partial models that do not evaluate  $z$ . Excluding variables from the comparison is restricted equivalence [FKL93].

**Definition 1 (Restricted equivalence [FKL93])** *Two formulae  $A$  and  $B$  are restricted-equivalent on the variables  $X$  if  $A \models C$  holds if and only if  $B \models C$  holds for every formula  $C$  over the alphabet  $X$ .*

Restricted equivalence formalizes the addition of new variables to the aim of reducing size [BB10, BDMT10]: the generated formulae are equivalent to the original formula on the original variables. Given a formula  $A$  over variables  $X$ , the aim is to produce a smaller formula  $B$  over variables  $X \cup Y$  that is restricted-equivalent to  $A$  over the variables  $X$ .

This is forgetting in reverse: instead of forgetting  $Y$  from  $B$  to produce  $A$ , it adds  $Y$  from  $A$  to produce  $B$ . It can indeed be reformulated in terms of forgetting: given  $A$  over  $X$ , search for a formula  $B$  of the given size such that forgetting  $Y$  from  $B$  produces  $A$ .

In the other way around, restricted equivalence formalizes forgetting: the result of forgetting  $X$  from  $A$  is a formula  $B$  over the variables  $Var(A) \setminus X$  that is restricted-equivalent to  $A$  over the variables  $Var(A) \setminus X$ .

In the way around the other way around:  $A$  and  $B$  are restricted-equivalent over  $X$  if forgetting  $Var(A) \setminus X$  from  $A$  is equivalent to forgetting  $Var(B) \setminus Y$  from  $B$ .

While restricted equivalence formalizes variable forgetting, introduction and forgetting followed by introduction, it is too powerful in one respect: it allows comparing formulae where the same variables have different meanings. In other applications such as databases this makes sense: two databases may contain the same attribute names with different meanings. As an example, a scientific database has the “paper” attribute to tell an article from a book, a typographic database has the “paper” attribute for a sheet size (like A4, letter, etc.). This often happens with databases coming from different sources. The conflict between variables comes from the data itself.

This is not the case when introducing variables to reduce size. They are created on purpose. Choosing some already used for something else is searching for troubles. In the example above, the variable introduced to reduce size is  $z$ , but restricted equivalence allows it to be  $x$ , the same that was forgotten in the first place. The result is  $F''' = \{abc \rightarrow x, x \rightarrow d, x \rightarrow e, x \rightarrow f\}$ . This is still equivalent to  $F = \{ab \rightarrow x, xc \rightarrow d, xc \rightarrow e, xc \rightarrow f\}$  when restricting to the variables  $\{a, b, c, d, e, f\}$  but  $x$  has different meanings in the two formulae: in  $F$ , it is some fact entailed by  $ab$ ; in the second, it is a shorthand for  $abc$ .

A restriction that avoids such discrepancies is to compare formulae on the common variables instead of an arbitrary set of variables. This way, a forgotten variable can only be reintroduced with its original meaning. This is allowed in certain applications of forgetting but not in others. For example, if forgetting is only aimed at reducing size, reintroducing a variable is allowed as long as it reduces size; if it instead aimed at privacy preserving, the original variables are forbidden in the result; if they can be recreated starting from the formulae after forgetting only, forgetting failed at hiding information.

**Definition 2** *Two formulae  $A$  and  $B$  are common-equivalent, denoted  $A \equiv \equiv B$ , if  $A \models C$  if and only if  $B \models C$  for every formula  $C$  such that  $Var(C) \subseteq Var(A) \cap Var(B)$ .*

Common equivalence is: same consequences on the common alphabet.

Forgetting variables  $X$  from a formula  $A$  results in a formula  $B$  such that  $Var(B) = Var(A) \setminus X$  and  $B \equiv A$ . Adding new variables to a formula  $A$  produces a formula  $B$  such that  $Var(A) \subseteq Var(B)$  and  $B \equiv A$ . Forgetting followed by adding is  $Var(A) \setminus X \subseteq Var(B)$  and  $B \equiv A$ . All three operations are defined in terms of common equivalence and some simple condition over the variables.

A caveat on variable forgetting and introducing defined in terms of common equivalence is that the formulae they produce are not always strictly minimal. For example, forgetting  $x$  from a formula built over the alphabet  $\{x, y, z\}$  using this definition always produces a formula that contains  $y$  and  $z$ ; yet, a formula that is minimal among the ones that contain  $y$  and  $z$  may be equivalent to a smaller one that only contains  $z$ . Forcing the use of  $y$  is necessary to employ common equivalence, but may artificially increase size. However, this presence is easily accomplished by subformulae such as  $y \vee \neg y$ . They only increase size linearly in the number of variables.

Common equivalence is in line with the view of forgetting as language reduction [Del17]. It is not syntactical, but based on the consequences on the common alphabet. Viewing the consequences of a formula as an explicit representation of what the formula tells,  $\equiv$  compares two formulae on what they say about the things they both talk about.

Common equivalence can be defined in alternative ways based on consistency rather than entailment.

**Theorem 1** *The condition  $A \equiv B$  is equivalent to  $A \cup S$  and  $B \cup S$  being equisatisfiable for every set of literals  $S$  over  $Var(A) \cap Var(B)$ .*

*Proof.* The definition of common equivalence is that  $A \models C$  equates  $B \models C$  for every  $C$  such that  $Var(C) \subseteq Var(A) \cap Var(B)$ . This holds in particular if  $C = \neg S$  where  $S$  is a conjunction of variables in  $Var(A) \cap Var(B)$ . The entailments  $A \models \neg S$  and  $B \models \neg S$  are the same as the inconsistency of  $A \cup S$  and  $B \cup S$ , which therefore coincide.

The other direction is proved by assuming that  $A \cup S$  is equisatisfiable with  $B \cup S$  for every conjunction of variables in  $Var(A) \cap Var(B)$ . The claim is that  $A \models C$  equates  $B \models C$  whenever  $Var(C) \subseteq Var(A) \cap Var(B)$ . Every formula is equivalent to one in CNF on the same variables; let  $C_1 \wedge \dots \wedge C_m$  be a formula equivalent to  $C$ , where each  $C_i$  is a disjunction of literals. By assumption,  $A \cup \neg C_i$  is equisatisfiable with  $B \cup \neg C_i$  since  $\neg C_i$  is equivalent to the conjunction of the variables in  $C_i$  and  $Var(C_i) \subseteq Var(C) \subseteq Var(A) \cap Var(B)$ . This proves that  $A \models C_i$  if and only if  $B \models C_i$ . Therefore,  $A \models C$  if and only if  $B \models C$ .  $\square$

This condition can be further restricted: instead of checking consistency over all sets of literals over the common alphabet, the ones that contain all common variables are enough. In other words, the models over the common alphabet are partial models of both formulae or none, if the formulae are common equivalent.

**Theorem 2** *The condition  $A \equiv B$  is equivalent to  $A \cup S$  and  $B \cup S$  being equisatisfiable for every set of literals  $S$  that contains exactly all variables that are common to  $A$  and  $B$ .*

*Proof.* By Lemma 1, if  $A \equiv B$  then  $A \cup S$  and  $B \cup S$  are equisatisfiable for every set of literals  $S$  on the common variables; this includes the sets that contain all common variables.

In the other direction,  $A \cup S$  is satisfiable if and only if it has a model  $M$ . Let  $S'$  be the set of literals over  $\text{Var}(A) \cap \text{Var}(B)$  that are satisfied by  $M$ . Since both  $A$  and  $S'$  are satisfied by  $M$ , the set  $A \cup S'$  is satisfiable. This proves that  $A \cup S$  is satisfiable if and only if  $A \cup S'$  is satisfiable for some set of literals over  $\text{Var}(A) \cap \text{Var}(B)$ . As a result, if  $A \cup S'$  and  $B \cup S'$  are equisatisfiable for every  $S'$ , then  $A \cup S$  and  $B \cup S$  are equisatisfiable as well. This implies common equivalence by Lemma 1.  $\square$

A situation of particular interest is when one of the two formulae contains only some variables of the other. It is the case when forgetting some variables. It is also the case when introducing new variables. It is not when first forgetting and then introducing variables.

**Lemma 1** *If  $A \equiv B$  and  $\text{Var}(B) \subseteq \text{Var}(A)$ , then  $A \models B$ .*

*Proof.* Since  $\text{Var}(B) \subseteq \text{Var}(A)$ , the common variables are  $\text{Var}(A) \cap \text{Var}(B) = \text{Var}(B)$ . By common equivalence,  $A \models C$  holds if and only if  $B \models C$  holds for every formula over the common variables. Formula  $B$  is over the common alphabet in this case. As a result,  $A \models B$  and  $B \models B$  are the same. Since the latter holds, the first follows.  $\square$

The converse of this lemma does not hold. For example,  $B = \{x\}$  does not entail  $A = \{x, y\}$  in spite of their common equivalence. Contrary to regular equivalence, common equivalence is not the same as mutual implication. It only contains implication in one direction, and only when the variables of a formula are all in the other.

This particular case allows for a slight simplification of the definition.

**Theorem 3** *If  $\text{Var}(B) \subseteq \text{Var}(A)$ , then  $A \equiv B$  holds if and only if  $A \models B$  and the satisfiability of  $B \cup S$  implies that of  $A \cup S$  for every consistent set of literals  $S$  that contains exactly all variables in  $\text{Var}(B)$ .*

While equivalence is transitive, common equivalence is not. An example where both  $A \equiv B$  and  $B \equiv C$  hold but  $A \equiv C$  does not is:

$$\begin{aligned} A &= x \wedge y \\ B &= x \\ C &= x \wedge \neg y \end{aligned}$$

Transitivity does not hold because  $A$  and  $C$  share the variable  $y$  while imposing different values on it, violating common equivalence; this variable is not in  $B$ , and is therefore not shared between  $B$  and  $A$  and between  $B$  and  $C$ ; the different values of  $y$  in  $A$  and  $C$  do not prevent their common equivalence to  $B$ .

This cannot happen if all variables of  $A$  and  $C$  are shared with  $B$ . This is a general result: transitivity holds in these cases.

**Lemma 2** *If  $\text{Var}(A) \cap \text{Var}(C) \subseteq \text{Var}(B)$  then  $A \equiv B$  and  $B \equiv C$  imply  $A \equiv C$ .*

*Proof.* By Theorem 1, the claim holds if  $A \cup S$  and  $C \cup S$  are equisatisfiable for every set of literals  $S$  over  $\text{Var}(A) \cap \text{Var}(C)$ .

By assumption,  $\text{Var}(A) \cap \text{Var}(C) \subseteq \text{Var}(B)$ . Intersecting a set with one of its supersets does not change it:  $\text{Var}(A) \cap \text{Var}(C) = \text{Var}(A) \cap \text{Var}(C) \cap \text{Var}(B)$ . Removing a set from an intersection may only enlarge the result:  $\text{Var}(A) \cap \text{Var}(C) \cap \text{Var}(B)$  is contained in both  $\text{Var}(A) \cap \text{Var}(B)$  and  $\text{Var}(C) \cap \text{Var}(B)$ . Therefore, the variables of  $S$  are all contained in these two sets: the variables shared between  $A$  and  $B$  and the variables shared between  $B$  and  $C$ .

By common equivalence, the consistency of  $A \cup S$  is the same as that of  $B \cup S$ , which is the same as that of  $C \cup S$ . This proves that  $A \cup S$  and  $C \cup S$  are equisatisfiable.  $\square$

A following proof employs a formula that is not in CNF. Turning a formula in CNF requires adding new variables, as otherwise size may increase exponentially. Does such an addition affect common equivalence? The following lemma answers: it does not. If a formula is the result of adding new variables to another, all properties related to common equivalence are preserved.

**Lemma 3** *If  $A \equiv \equiv A'$ ,  $\text{Var}(A) \subseteq \text{Var}(A')$  and  $(\text{Var}(A') \setminus \text{Var}(A)) \cap \text{Var}(B) = \emptyset$ , then  $A \equiv \equiv B$  if and only if  $A' \equiv \equiv B$ .*

*Proof.* The claim is proved by applying the limited transitivity of common equivalence shown by Lemma 2: if  $A \equiv \equiv B$  and  $B \equiv \equiv C$  then  $A \equiv \equiv C$  if  $\text{Var}(A) \cap \text{Var}(C) \subseteq \text{Var}(B)$ . This lemma is applied twice, the first time with  $A', A, B$ , the second with  $A, A', B$ .

- $A \equiv \equiv B$  is assumed and  $A' \equiv \equiv B$  proved;

By standard set theory properties, it holds  $\text{Var}(A') \cap \text{Var}(B) = ((\text{Var}(A') \setminus \text{Var}(A)) \cup \text{Var}(A)) \cap \text{Var}(B) = (((\text{Var}(A') \setminus \text{Var}(A)) \cap \text{Var}(B)) \cup (\text{Var}(A) \cap \text{Var}(B))) = \emptyset \cup (\text{Var}(A) \cap \text{Var}(B)) = \text{Var}(A) \cap \text{Var}(B) \subseteq \text{Var}(A)$ .

Since  $\text{Var}(A') \cap \text{Var}(B) \subseteq \text{Var}(A)$ , common equivalence is transitive in this case:  $A' \equiv \equiv A$  and  $A \equiv \equiv B$  imply  $A' \equiv \equiv B$ .

- $A' \equiv \equiv B$  is assumed and  $A \equiv \equiv B$  proved; since  $\text{Var}(A) \subseteq \text{Var}(A')$ , it holds  $\text{Var}(A) \cap \text{Var}(B) \subseteq \text{Var}(A') \cap \text{Var}(A) \subseteq \text{Var}(A')$ . Common equivalence is transitive also in this case:  $A \equiv \equiv A'$  and  $A' \equiv \equiv B$  imply  $A \equiv \equiv B$ .

This proves that the assumptions of the lemma imply that  $A \equiv \equiv B$  is the same as  $A' \equiv \equiv B$ .  $\square$

A formula that entails a literal is not equivalent to the formula with the literal replaced by true. Yet, they only differ on that literal: the first formula entails it, the second does not mention it; their consequences are otherwise the same. This is exactly what common equivalence formalizes. It is able to express that adding a literal to a formula and setting its value in the formula are essentially the same. Regular equivalence it too picky.

**Lemma 4** *For every formula  $F$  and variable  $x$ , the common equivalence  $F \cup \{\neg x\} \equiv \equiv F[\perp/x]$  holds.*



*Proof.* Since  $F[\perp/x]$  does not contain  $x$ , the variables shared between  $F$  and  $F[\perp/x]$  are a subset of  $\text{Var}(F) \setminus \{x\}$ . In other words,  $x$  is not a shared variable. The claim holds if  $F \cup \{\neg x\} \models C$  is the same as  $F[\perp/x] \models C$  for every formula  $C$  over  $\text{Var}(F) \setminus \{x\}$ .

If  $F \cup \{\neg x\} \models C$  then  $(F \cup \{\neg x\})[\perp/x] \models C[\perp/x]$ . The formula in the left-hand side of this entailment can be rewritten  $F[\perp/x] \cup \{\neg x\}[\perp/x]$ , which is the same as  $F[\perp/x] \cup \{\neg \perp\}$ , or  $F[\perp/x]$ . The formula in the right-hand side  $C[\perp/x]$  is the same as  $C$  since  $C$  does not contain  $x$  by assumption. The entailment is therefore the same as  $F[\perp/x] \models C$ .

The other direction is proved by expressing  $F \cup \{\neg x\}$  by the Shannon identity and rewriting it.

$$\begin{aligned}
F \cup \{\neg x\} &\equiv (x \wedge (F \cup \{\neg x\})[\top/x]) \vee (\neg x \wedge (F \cup \{\neg x\})[\perp/x]) \\
&\equiv (x \wedge (F[\top/x] \cup \{\neg \top\})) \vee (\neg x \wedge (F[\perp/x] \cup \{\neg \perp\})) \\
&\equiv (x \wedge (F[\top/x] \cup \{\perp\})) \vee (\neg x \wedge (F[\perp/x] \cup \{\top\})) \\
&\equiv (x \wedge \perp) \vee (\neg x \wedge F[\perp/x]) \\
&\equiv \neg x \wedge F[\perp/x]
\end{aligned}$$

Since  $F[\perp/x] \models C$  implies  $\neg x \wedge F[\perp/x] \models C$  by monotonicity of entailment, it also implies  $F \cup \{\neg x\} \models C$ .  $\square$

Regular equivalence is not only transitive but also monotonic: if two formulae are equivalent, they remain equivalent after conjoining both with the same formula. The same holds for common equivalence when conjoining with a formula on the shared variables.

**Lemma 5** *If  $A \equiv B$  then  $A \cup C \equiv B \cup C$  if  $\text{Var}(C) \subseteq \text{Var}(A) \cap \text{Var}(B)$ .*

*Proof.* Since the variables of  $C$  are already shared between  $A$  and  $B$ , the addition of  $C$  to  $A$  and  $B$  does not change their shared variables. In formulae,  $\text{Var}(A \cup C) \cap \text{Var}(A \cup B) = (\text{Var}(A) \cap \text{Var}(B)) \cup (\text{Var}(C) \cap \text{Var}(B)) \cup (\text{Var}(A) \cap \text{Var}(C)) \cup (\text{Var}(C) \cap \text{Var}(C))$ . Factoring out  $\text{Var}(C)$  from the last three sets of this union turns it into  $(\text{Var}(A) \cap \text{Var}(B)) \cup (\text{Var}(C) \cap \dots)$ . Since  $\text{Var}(C) \subseteq \text{Var}(A) \cap \text{Var}(B)$ , the second part of this union is a subset of the first, which is therefore the same as the whole:  $\text{Var}(A) \cap \text{Var}(B)$ .

By Lemma 2, the claim is the same as  $A \cup C \cup S$  being equisatisfiable with  $B \cup C \cup S$  for every set of literals  $S$  that contains exactly all variables  $\text{Var}(A) \cap \text{Var}(B)$ . If  $C \cup S$  is unsatisfiable, then both  $A \cup C \cup S$  and  $B \cup C \cup S$  are unsatisfiable and the claim is proved. Otherwise,  $C \cup S$  is equivalent to  $S$  since  $S$  is a set of literals and the variables of  $C$  are a subset of those of  $S$ . Therefore,  $A \cup C \cup S \equiv A \cup S$  and  $B \cup C \cup S \equiv B \cup S$ . Since  $A$  and  $B$  are common equivalent,  $A \cup S$  and  $B \cup S$  are either both satisfiable or both unsatisfiable.  $\square$

Flogel et al. [FKL93] proved restricted equivalence coNP-complete if the two formulae are Horn. The complexity of the general case does not appear to have been established, but is easy to show in  $\Pi_2^2$ : two formulae are restricted equivalent on some variables if and only if they are equiconsistent with every set of literals over these variables. Formally, “for all sets of literals” is a universal quantification while equiconsistency is an existential quantification over models.

Hardness is proved by the following theorem. It holds even when the variables are the shared ones (common equivalence) and the alphabet of a formula is a subset of the other. This is the case with variables forgetting alone and with variable introduction alone.

**Theorem 4** *The problem of establishing whether  $A \equiv B$  is  $\Pi_2^p$ -complete. Hardness holds even if  $\text{Var}(B) \subseteq \text{Var}(A)$ .*

*Proof.* Common equivalence of  $A$  and  $B$  can be formulated as:

$$A \equiv B \text{ iff } \forall C . \text{Var}(C) \subseteq \text{Var}(A) \cap \text{Var}(B) \Rightarrow (A \models C \text{ iff } B \models C)$$

The problem is in  $\Pi_2^p$  because it can be reduced to  $\forall \exists \text{QBF}$ .

Hardness is proved by reduction from the validity of a formula  $\forall X \exists Y . F$  where  $F$  is in DNF. The formulae  $A$  and  $B$  that correspond to this QBF are:

$$\begin{aligned} A &= (a \vee F) \wedge (\neg a \vee X) \\ B &= \neg a \vee X \end{aligned}$$

The variables of these formulae are  $\text{Var}(A) = \{a\} \cup X \cup Y$  and  $\text{Var}(B) = \{a\} \cup X$ . The condition  $\text{Var}(B) \subseteq \text{Var}(A)$  is met.

By Lemma 2,  $A$  and  $B$  are common equivalent if and only if  $A \cup S$  and  $B \cup S$  are equisatisfiable for every set of literals  $S$  that contains all variables of  $\text{Var}(A) \cap \text{Var}(B)$ . In this case,  $\text{Var}(A) \cap \text{Var}(B) = (\{a\} \cup X \cup Y) \cap (\{a\} \cup X) = \{a\} \cup X = \text{Var}(B)$ .

If  $S$  is not consistent with  $B$  it is not consistent with  $A$  either, since  $A$  entails  $B$ . Therefore, the claim holds if every set  $S$  consistent with  $B$  is also consistent with  $A$ , if the QBF is valid.

Being a disjunction,  $B$  is consistent with all sets of literals  $S$  that contain  $\neg a$  and arbitrary literals over  $X$  and with the single set  $S$  that contains  $a$  and all of  $X$ . The latter is consistent with  $A$  because  $a$  satisfies its first conjunct and  $X$  its second.

What remains to be proved is that  $A$  is consistent with all sets of literals  $S$  that contain  $\neg a$  and arbitrary literals over all variables of  $X$  if and only if the QBF is valid. Since  $S$  contains  $\neg a$ , the union  $A \cup S$  simplifies to  $((a \vee F) \wedge (\neg a \vee X)) \cup S = ((\text{false} \vee F) \wedge (\text{true})) \cup S = F \cup S$ . This formula is satisfiable if and only if a truth evaluation over  $Y$  makes  $F \cup S$  true. This happens for all sets  $S$  that contain literals over all variables  $X$  if it happens for all truth evaluations over  $X$ : for every  $X$ , there exists  $Y$  that makes  $F$  true.  $\square$

The two formulae  $A$  and  $B$  used in the hardness proof are not both in CNF:  $B$  is,  $A$  is not. However, Lemma 3 states that adding new variables to a formula does not change its common equivalence with other formulae. In this case,  $A$  can be turned into CNF without an exponential increase in size by adding new variables [LC09]. Let  $A'$  be the result of this transformation. By Lemma 3,  $A' \equiv B$  is the same as  $A \equiv B$ . Since  $\forall X \exists Y . F$  is valid if and only if  $A \equiv B$ , it is also valid if and only if  $A' \equiv B$ . This proves the  $\Pi_2^p$  hardness of the problem  $A' \equiv B$  where both  $A'$  and  $B$  are in CNF.

Restricted equivalence was proved coNP-complete in the Horn case by Flögel et al. [FKL93]. Being a restriction of restricted equivalence, common equivalence is in coNP as well. In spite of being a restriction, it is also still coNP-hard. It remains coNP-hard even when a formula is a subset of the other, which implies that its variables are a subset of those of the other. This is the case with variable forgetting: the result is a common-equivalent

formula on a subset of the variables. Therefore, establishing whether a formula is a valid way of forgetting variables from another is coNP-hard in the Horn case. This is the same problem as checking whether a formula is a valid way of introducing variables in the other since forgetting is the opposite of introducing. Both problems are therefore coNP-hard.

**Theorem 5** *If  $A$  and  $B$  are Horn, establishing whether  $A \equiv B$  is coNP-complete. Hardness holds even if  $B \subseteq A$ .*

*Proof.* Membership:  $A$  and  $B$  are not common-equivalent if:

$$\exists S . \text{Var}(S) \subseteq \text{Var}(A) \cap \text{Var}(B) \text{ and } A|_S \not\models \perp \text{ and } B|_S \models \perp \text{ or } A|_S \models \perp \text{ and } B|_S \not\models \perp$$

Since the size of  $S$  is bounded by the number of variables, this condition is in NP. This is the converse of common equivalence, which means that common equivalence is in coNP.

Hardness is proved by showing that the satisfiability of a general formula  $F = \{f_1, \dots, f_m\}$  over variables  $X = \{x_1, \dots, x_n\}$  is the same as the non-common equivalence of two Horn formulae  $A$  and  $B$  with  $\text{Var}(B) \subseteq \text{Var}(A)$ . The satisfiability problem is NP-hard because  $F$  is not restricted to the Horn form.

$$\begin{aligned} A &= \{ \neg x_i \vee \neg n_i \mid x_i \in X \} \cup \{ \neg x_i \vee t_i, \neg n_i \vee t_i \mid x_i \in X \} \\ &\quad \{ \neg x_i \vee c_j \mid x_i \in f_j \} \cup \{ \neg n_i \vee c_j \mid \neg x_i \in f_j \} \cup \\ &\quad \{ \neg t_1 \vee \dots \vee \neg t_n \vee \neg c_1 \vee \dots \vee \neg c_m \} \\ B &= \{ \neg x_i \vee \neg n_i \mid x_i \in X \} \end{aligned}$$

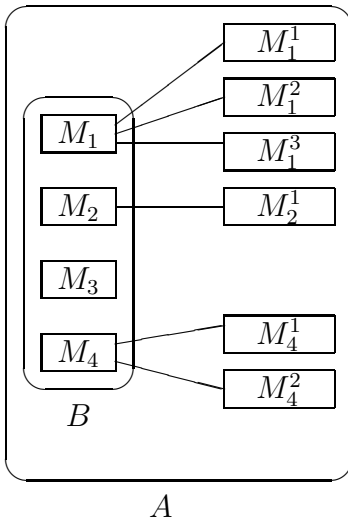

This figure shows how the overall reduction works. Common equivalence requires every model of  $B$  to be extendable to form a model of  $A$  with the addition of the values for the variables not in  $B$ . For example,  $M_1$  can be extended by the addition of  $M_1^1$ ,  $M_1^2$  and  $M_1^3$  while  $M_3$  cannot. If a model of  $B$  can always be extended this way regardless of  $F$ , it is irrelevant to common equivalence; this way, some models can be disregarded as irrelevant to common equivalence. The only models that matter are those that have an extension or not depending on  $F$ . This particular reduction has the models with  $x_i = n_i = \text{false}$  for some  $i$

being always extendable, and therefore irrelevant. Instead, the models where  $n_i$  is opposite to  $x_i$  for every  $i$  can be extended to satisfy  $A$  if and only if the values of  $X$  falsify  $F$ .

That was an outline of the proof, which is now technically detailed. Since  $B$  only comprises  $\neg x_i \vee \neg n_i$ , its models are exactly those setting either  $x_i$  or  $n_i$  to false for each  $i$ . Common equivalence is achieved if every such evaluation can be extended to form a model of  $A$ .

The models where  $x_i = n_i = \text{false}$  for some  $i$  can be extended by adding  $t_i = \text{false}$  and all other  $t_i$  and  $c_j$  to true.

The other models have  $n_i$  opposite to  $x_i$  for every  $i$ . As a result, the clauses  $\neg n_i \vee c_j$  are the same as  $x_i \vee c_j$ .

If the truth evaluation over  $X$  falsifies  $F$ , at least a clause  $f_j$  is false: all its literals are false. If  $x_i \in f_j$  the variable  $x_i$  is false, and the clause  $\neg x_i \vee c_j$  is satisfiable with  $c_j = \text{false}$ ; if  $\neg x_i \in f_j$  then  $x_i$  is true and  $x_i \vee c_j$  is satisfiable with  $c_j = \text{false}$ . By setting all  $t_i = \text{false}$  and all other  $c_j = \text{false}$ , all clauses of  $A$  are satisfied.

If the truth evaluation over  $X$  satisfies  $F$ , for each clause  $f_j$  at least one of its literals is true. If  $A$  contains  $\neg x_i \vee c_j$  then  $x_i$  is true, and if  $A$  contains  $x_i \vee c_j$  then  $x_i$  is false. The only way to satisfy these clauses is to set  $c_j = \text{true}$ . Since  $A$  also contains  $\neg x_i \vee t_i$  and  $x_i \vee t_i$ , also  $t_i = \text{true}$  is necessary. The last clause  $\neg t_1 \vee \dots \vee \neg t_n \vee \neg c_1 \vee \dots \vee \neg c_m$  is therefore falsified.

This means that equisatisfiability is lost only if the truth evaluation over  $X$  falsifies  $F$ . Globally,  $A \equiv B$  only if  $F$  is unsatisfiable. This proves that common equivalence in the Horn case is coNP-hard.  $\square$

A similar proof shows that the problem remains coNP-hard even if the formulae are definite Horn.

**Theorem 6** *Checking  $A \equiv B$  is coNP-hard even if  $A$  and  $B$  are definite Horn and  $B \subseteq A$ .*

*Proof.* The reduction is a variant of that in Theorem 5, where a new variable  $z$  is added to all negative clauses of  $A$  and  $B$ , making them definite.

$$\begin{aligned}
A &= \{z \vee \neg x_i \vee \neg n_i \mid x_i \in X\} \cup \{\neg x_i \vee t_i, \neg n_i \vee t_i \mid x_i \in X\} \\
&\quad \{\neg x_i \vee c_j \mid x_i \in f_j\} \cup \{\neg n_i \vee c_j \mid \neg x_i \in f_j\} \cup \\
&\quad \{z \vee \neg t_1 \vee \dots \vee \neg t_n \vee \neg c_1 \vee \dots \vee \neg c_m\} \\
B &= \{z \vee \neg x_i \vee \neg n_i \mid x_i \in X\}
\end{aligned}$$

The models that assign false to  $z$  satisfy these formulae if and only if they satisfy the formulae in the proof of Theorem 5, since the added literal  $z$  is false.

The claim is proved by showing that all models of  $B$  with  $z = \text{true}$  can be extended to form a model of  $A$ . Such a model contains  $z = \text{true}$  and an arbitrary evaluation for the variables  $x_i$  and  $n_i$ . The value of  $z$  satisfies all clauses containing it. The only remaining clauses are  $\neg x_i \vee t_i$ ,  $\neg n_i \vee t_i$ ,  $\neg x_i \vee c_j$  and  $\neg n_i \vee c_j$ . All of them are satisfied by setting all  $t_i$  and  $c_j$  to true.  $\square$

Complexity of common equivalence is established when the problem is formalized as a decision: are two Horn formulae common-equivalent? The two formulae are both assumed

Horn, excluding the case when forgetting turns a Horn formula into a non-Horn formula. Or when variable introduction make a Horn formula non-Horn.

These cases are both possible, in the sense that a specific procedure for forgetting may generate non-Horn clauses. As an example, the non-Horn formula  $F' = \{x, y, x \vee y\}$  is a way of forgetting  $z$  from the Horn formula  $F = \{x, y, z\}$ . Not a natural way to do so, but still a valid way. Yet, a better way of forgetting is  $F'' = \{x, y\}$ , which is Horn (incidentally,  $F''$  is also the result of minimizing  $F'$ ).

This is not specific to the example, tells the next theorem.

**Theorem 7** *If  $A$  is Horn,  $A \equiv B$  and  $\text{Var}(B) \subseteq \text{Var}(A)$ , then  $B$  is equivalent to a Horn formula.*

*Proof.* A Horn formula is satisfied by the intersection of every pair of its models, where the intersection is the model that assigns true to a variable if and only if both models assigns it to true.

This holds for  $A$  by assumption. It is proved for  $B$  as a consequence. Let  $M_1$  and  $M_2$  be two models over the alphabet of  $B$ . Let  $S_1$  be the sets of the literals over  $\text{Var}(B)$  that are satisfied by  $M_1$ , and the same for  $M_2$ . The union  $B \cup S_1$  is satisfiable because  $M_1$  satisfies  $B$  by assumption and  $S_1$  by construction. The same holds for  $B \cup S_2$ . Let  $M_1$  be a model of  $B \cup S_1$  and  $M_2$  of  $B \cup S_2$ .

By Lemma 1, the satisfiability of  $B \cup S_1$  implies that of  $A \cup S_1$ . Let  $M'_1$  be a model of  $A \cup S_1$ . For the same reason,  $A \cup S_2$  has at least a model  $M'_2$ .

Since  $S_1$  and  $S_2$  contain a literal for each variable of  $\text{Var}(B)$ , they are only satisfied by models that assign the same values of  $M_1$  and  $M_2$  to all variables of  $\text{Var}(B)$ . As a result,  $M'_1$  and  $M'_2$  respectively coincide with  $M_1$  and  $M_2$  on the variables of  $B$ .

Since  $A$  is Horn and is satisfied by  $M'_1$  and  $M'_2$ , it is also satisfied by their intersection  $M'_3$ . Let  $M_3$  be the restriction of  $M'_3$  to the variables of  $B$ , and  $S_3$  be the only set of literals that contains all variables of  $B$  and is satisfied by  $M_3$ . The union  $A \cup S_3$  is satisfiable because  $M'_3$  satisfies it. By Lemma 1,  $B \cup S_3$  is also satisfiable. This implies  $M_3 \models B$  since  $M_3$  is the only model of  $S_3$  on the variables  $\text{Var}(B)$ .

This proves that if  $M_1$  and  $M_2$  are models of  $B$ , then  $B$  is also satisfied by their intersection. Therefore,  $B$  is equivalent to a Horn formula.  $\square$

The converse does not hold. For example, the Horn formula  $B = \{x\}$  is common-equivalent to  $A = \{x, y \vee z\}$ , which is not Horn and is not equivalent to any Horn formula. In practice: forgetting variables may turn a non-Horn formula into a Horn formula. Also: introducing variables may generate a non-Horn formula.

### 3 Size of forgetting

Forgetting may not only fail at reducing size. It may increase it. Even exponentially. Even with equivalence: the result of forgetting is only equivalent to exponentially-sized formulae.

An example of size increase is forgetting  $x$  from  $A = \{abc \rightarrow x, x \rightarrow l, x \rightarrow m, x \rightarrow n\}$ . This formula tells that  $abc$  imply  $x$  and  $x$  implies  $l$ . Therefore, it also tells that  $abc$  implies  $l$ . This implication survives forgetting since it does not involve  $x$ . The same holds for  $abc$  implying  $m$  and  $n$ . Forgetting indeed produces  $B = \{abc \rightarrow l, abc \rightarrow m, abc \rightarrow n\}$ , which contains more literal occurrences than  $A$ . This example is in the test file `enlarge.py`.

This is a way to forget variables: generate all minimal clauses entailed by the original formula and select only the ones that do not contain the variables to be forgotten. It is a way to forget, but is not the only one. And not always the minimal. For example, forgetting  $x$  from  $\{a \rightarrow x, x \rightarrow b, b \rightarrow c\}$  this way produces  $\{a \rightarrow b, a \rightarrow c, b \rightarrow c\}$ , where the second clause is not necessary. The test file `redundant.py` indeed generates the first and the third clauses only.

This applies to the previous example as well:  $B$  is a way of forgetting  $x$ , but it may be equivalent to smaller formulae. Such formulae would be alternative ways to forget  $x$  from  $A$ . If they are not only smaller than  $B$  but also smaller than  $A$ , they would invalidate the claim that forgetting may enlarge size. They would prove that the enlargement is due to how forgetting is done rather than forgetting itself.

The following lemma shows that this is not the case:  $B$  is minimal. No equivalent formula is smaller.

**Lemma 6** *No CNF formula over variables  $\{a, b, c, l, m, n\}$  is equivalent to  $B = \{abc \rightarrow l, abc \rightarrow m, abc \rightarrow n\}$  and shorter than it.*

*Proof.* Let  $C$  be a formula equivalent to  $B$ . This implies  $B \models C$ . Therefore, every clause of  $C$  is entailed by  $B$ . All clauses entailed by  $B$  are supersets of clauses resulting from resolving some clauses of  $B$  [Pel16]. In other words, every clause of  $C$  can be obtained by resolving clauses of  $B$  and then adding literals. But the clauses of  $B$  do not resolve since  $a, b$  and  $c$  only occur negative and  $l, m$  and  $n$  only positive. Therefore,  $C$  may only contain supersets of clauses of  $B$ .

Since the alphabet of  $B$  is  $\{a, b, c, l, m, n\}$ , the only possible supersets of  $abc \rightarrow l$  are  $abc \rightarrow l \vee m$ ,  $abc \rightarrow l \vee n$ ,  $abc \rightarrow l \vee m \vee n$ ,  $abcm \rightarrow l$ ,  $abcn \rightarrow l$  and  $abcnm \rightarrow l$ .

If  $C$  only contains some of the first three clauses, it is satisfied by the model setting  $\{a, b, c, m, n\}$  to true and  $l$  to false. Since  $B$  is falsified by this model, it is not equivalent to  $C$ . This proves that every formula  $C$  that is equivalent to  $B$  contains either the original clause  $abc \rightarrow l$  or at least one of the last three supersets of it:  $abcm \rightarrow l$ ,  $abcn \rightarrow l$  and  $abcnm \rightarrow l$ .

The same holds for the other two clauses of  $B$ . None of the three supersets of  $abc \rightarrow l$  is also a superset of these other two clauses  $abc \rightarrow m$  and  $abc \rightarrow n$ , which contain either  $m$  or  $n$  positive while  $abc \rightarrow l$  and its three superset do not. This proves that the supersets of  $abc \rightarrow l$  and the supersets of the other two clauses of  $B$  are all different. Therefore,  $C$  contains at least three clauses, each one being the same size or larger than a clause of  $B$ .  $\square$

This proves that  $B$  is minimal in its own alphabet. The aim is proving that forgetting  $x$  from  $A$  always produces a formula larger than  $A$ . What is missing is proving that  $B$  is actually the result of forgetting  $x$  from  $A$ . Formally:  $Var(B) = Var(A) \setminus \{x\}$  and  $B \equiv A$ . The first holds because  $Var(A) \setminus \{x\} = \{a, b, c, x, l, m, n\} = \{a, b, c, l, m, n\} = Var(B)$ . The second is proved by the following lemma.

**Lemma 7** *Formulae  $A$  and  $B$  are common equivalent:*

$$\begin{aligned} A &= \{abc \rightarrow x, x \rightarrow l, x \rightarrow m, x \rightarrow n\} \\ B &= \{abc \rightarrow l, abc \rightarrow m, abc \rightarrow n\} \end{aligned}$$

*Proof.* The common alphabet of  $A$  and  $B$  is  $\text{Var}(A) \cap \text{Var}(B) = \{a, b, c, l, m, n\}$ .

The clauses entailed by these formulae are obtained by resolution and literal adding. Since the clauses of  $B$  do not resolve, the consequences of  $B$  are the supersets of the clauses of  $B$ . The clauses of  $A$  only resolve on variable  $x$ . The result are exactly the clauses of  $B$ .  $\square$

Since  $\text{Var}(B) = \text{Var}(A) \setminus \{x\}$ , proving  $B \equiv A$  shows that  $B$  is the result of forgetting  $x$  from  $A$ . Since  $B$  is minimal and is larger than  $A$ , the claim that forgetting  $x$  from  $A$  always increases size is proved.

**Theorem 8** *There exists a definite Horn formula  $A$  and a variable  $x$  such that for every CNF formula  $B$  if  $\text{Var}(B) = \text{Var}(A) \setminus \{x\}$  and  $B \equiv A$  then  $B$  is larger than  $A$ .*

The central point of this theorem is “for every formula  $B$ ”. No way of forgetting  $x$  from  $A$  may reduce size or keep it the same.

Looking at these results in the opposite direction,  $B$  may be taken as the original formula and  $A$  as a way of reducing its size by adding the new variable  $x$ . This size reduction is only due to the addition of  $x$ , since  $B$  is minimal in its own alphabet. In other words, variable introduction may reduce the size of otherwise minimal formulae. Such a reduction is unachievable on the original alphabet.

The analogous result for forgetting is straightforward:  $A = \{x, y\}$  is minimal, but forgetting  $x$  reduces it to  $\{y\}$ , which is smaller. Forgetting unavoidably enlarges certain formulae, but also shrinks others, even some that are minimal on their own alphabets.

The size increase or decrease is not limited to a handful of literal occurrences. In some cases, it may be exponential.

**Lemma 8** *There exists a definite Horn formula  $A$  and a set of variables  $X$  such that for every CNF formula  $B$  if  $\text{Var}(B) = \text{Var}(A) \setminus X$  and  $A \equiv B$  then  $B$  is exponentially larger than  $A$ .*

*Proof.* The proof is given for a set  $X = \{a, b, c\}$  of three variables, but extends to  $n$  variables. The formula is the following, also in the test file `exponential.py` with variables renamed.

$$A = \{a_1 \rightarrow a, a_2 \rightarrow a, b_1 \rightarrow b, b_2 \rightarrow b, c_1 \rightarrow c, c_2 \rightarrow c, abc \rightarrow x\}$$

This formula entails all clauses  $a_i b_j c_k \rightarrow x$  for every three indexes  $i, j, k$  in  $\{1, 2\}$ . The number of such clauses is exponential in the size of  $A$ . They only contain variables in  $\text{Var}(A) \setminus X$ ; therefore, if  $B$  is common equivalent to  $A$  and  $\text{Var}(B) = \text{Var}(A) \setminus X$ , it entails all of them.

A clause whose body is a proper subset of  $\{a_i, b_j, c_k\}$  is not entailed by  $B$  because it is not by  $A$ . For example,  $A$  is consistent with the model where  $a_i$  and  $b_j$  are true and all other variables are false except  $a$  and  $b$ ; therefore,  $A$  entails no clause  $a_i b_j \rightarrow y$  for any other variable  $y$ . Neither does  $B$  because of common equivalence.

Since  $B$  does not entail any clause whose body is a proper subset of  $\{a_i, b_j, c_k\}$ , it does not contain any of them as well. Contrary to the claim,  $B$  is assumed not to contain any clause of body  $a_i b_j c_k$  either. Let  $M$  be the truth assignment that sets  $a_i, b_j$  and  $c_k$  to true and all other variables to false. Let  $C$  be the body of an arbitrary clause of  $B$ . Since  $C$  is not a subset (proper or not) of  $\{a_i, b_j, c_k\}$ , it contains at least a variable not in  $\{a_i, b_j, c_k\}$ . As a result, it is falsified by  $M$ . The clause of body  $C$  is therefore satisfied by  $M$  regardless

of its head. This holds for every clause of  $B$ , making this formula satisfied by  $M$ . Since  $M$  satisfies  $B$  but not  $a_i b_j c_k \rightarrow x \in A$ , it disproves the common equivalence of  $B$  and  $A$ .

The assumption leading to contradiction was that  $B$  does not contain any clause of body  $a_i b_j c_k$ . Its opposite is that  $B$  contains some. This holds for every three indexes  $i, j$  and  $k$ , proving that  $B$  contains an exponential number of clauses.  $\square$

This lemma proves that forgetting  $X$  from  $A$  always produces an exponential increase in size. At the same time, it proves that  $B$  can be exponentially compacted by introducing new variables.

The take-away of this section is that forget may increase size, even exponentially. This is sometimes due to the way forgetting is done but is sometimes unavoidable, and happens regardless of how forgetting is done. This is relevant to the following sections, which show algorithms for forgetting.

## 4 Algorithm for definite Horn formulae

Given that forget may produce formulae of exponentially size, no algorithm for forgetting is always polynomial in time. Yet, it may be polynomial in space. A way of forgetting a variable from a CNF formula is to resolve all clauses on that variable and then delete all clauses containing it [Lib20]. This algorithm may not only require exponential time but also exponential working space. Even if the result is polynomial.

This section shows an algorithm for the definite Horn case that does not: it only requires polynomial working space. The result may be exponentially large, but this is unavoidable in general. Yet, the memory needed to produce it is always polynomial.

An example showing the difference between the two methods is forgetting all variables but  $a$  and  $b$  from the following formula, which is also in the test file `compare.py` with variables renamed.

$$F = \{a \rightarrow c_1, a \rightarrow c_2, c_1 \rightarrow d_1, c_1 \rightarrow d_2, c_2 \rightarrow d_3, c_2 \rightarrow d_4, d_1 \rightarrow e_1, d_2 \rightarrow e_1, d_3 \rightarrow e_2, d_4 \rightarrow e_2, e_1 e_2 \rightarrow b\}$$

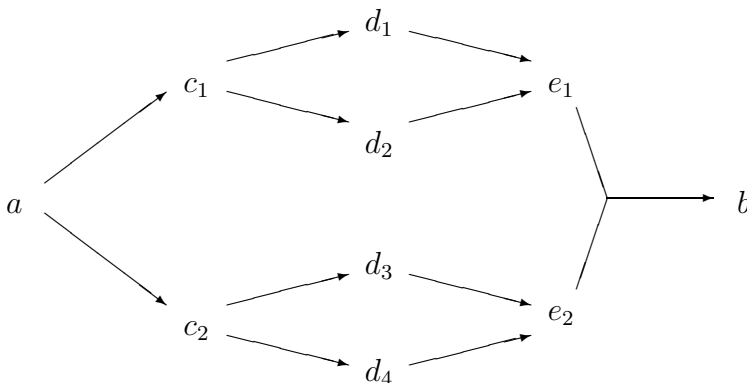

The only consequence of  $F$  surviving forgetting is  $a \rightarrow b$ . Following the implications in  $F$ , the premise  $a$  entails  $c_1$  and  $c_2$ , which entail  $d_1, d_2, d_3$  and  $d_4$ . Resolution generates four clauses:  $a \rightarrow d_i$  with  $i \in \{1, 2, 3, 4\}$ . Yet, they are not in the result because they



contain variables to forget. In this example, resolution generates four clauses; in general, exponentially many.

In contrast, the algorithm below starts from the last clause  $e_1e_2 \rightarrow b$  and nondeterministically tries to replace its two premises  $e_1$  and  $e_2$  with other variables implying them until only variables not to forget remain. The key is non-determinism:  $e_1$  is replaced through either  $d_1 \rightarrow e_1$  or  $d_2 \rightarrow e_1$ , but only one at a time is tried: first  $d_1 \rightarrow e_1$  with  $d_2 \rightarrow e_1$  on hold; also  $e_2$  is on hold while replacing  $e_1$ . At any given time, some variables and clauses are worked on (like  $e_1$  and  $d_1 \rightarrow e_1$ ), others on hold (like  $d_2 \rightarrow e_1$  and  $e_2$ ) and others still unmet (like  $c_2 \rightarrow d_4$ ).

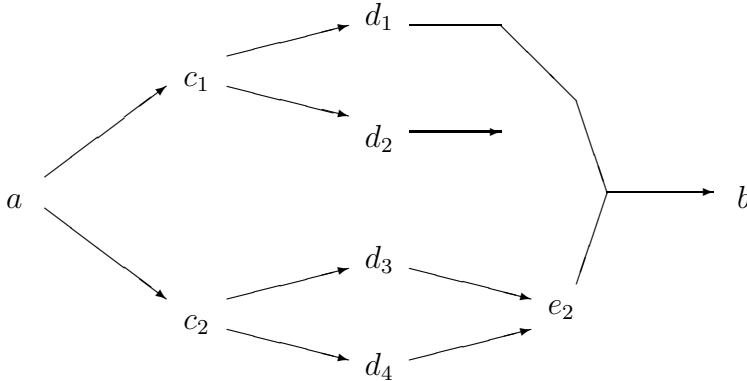

In the following step,  $d_1$  is replaced thanks to  $c_1 \rightarrow d_1$ . The process continues until variables not to forget are met or no further replacement is possible. Since  $c_1$  can be replaced by  $a$ , which is not to be forgotten this line of substitution ends and the procedure goes back to  $e_2$  and tries to replace it.

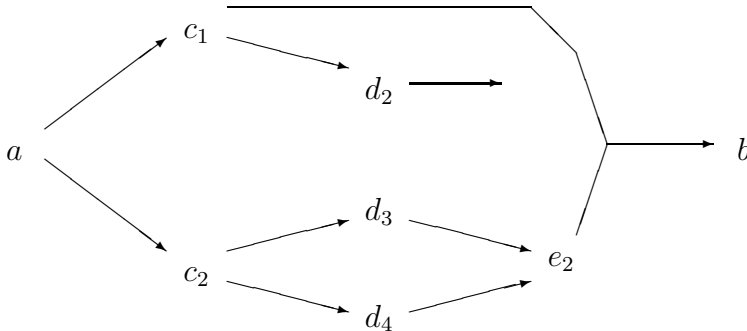

This procedure is still a form of resolution, but resolves clauses in a certain order and discards them while running.

No variable or clause is reconsidered twice in the same branch of execution. The needed memory is therefore polynomial.

While the required memory is polynomial, the produced output may be exponential. This is unavoidable in general. Also, while the required working space is polynomial, the running time may be exponential in the size of the output. This is because the same output clause may be obtained in more than one way.

$$F = \{k \rightarrow a, k \rightarrow b, l \rightarrow d, l \rightarrow e, m \rightarrow g, m \rightarrow h, \\ a \rightarrow c, b \rightarrow c, d \rightarrow f, e \rightarrow f, g \rightarrow i, h \rightarrow i, cfi \rightarrow j\}$$

Forgetting  $\{a, b, c, d, e, f, i\}$  from  $F$  results in the single clause  $klm \rightarrow j$ . Yet, this clause is generated in eight different ways. Starting from  $cfi \rightarrow j$ , the first premise  $c$  can be replaced by either  $a$  or  $b$ , the second  $f$  by either  $d$  or  $e$ , and the third  $i$  by either  $g$  or  $h$ , for a total of eight nondeterministic branches. All of them eventually produce  $klm \rightarrow j$ , but none could be cut short before realizing that the generated clause is already generated. This example is in the test file `branches.py`.

## 4.1 Set implies set

The base of the algorithm for forgetting is the following lemma. It states that every implication from a Horn formula requires its conclusion to be the head of some clause whose body is entailed by its premises and the formula. This result can be pushed a little further, because the latter implication only requires a subset of the formula.

**Definition 3** *For every set of clauses  $F$ , the set  $F^x$  contains all clauses of  $F$  that contain neither  $x$  nor  $\neg x$ .*

In this article, clauses are assumed not to be tautologies: unless otherwise noted, writing  $P \rightarrow x$  implicitly presumes  $x \notin P$ . This condition is sometimes stated explicitly when important.

**Lemma 9** *If  $F$  is a definite Horn formula, the following three conditions are equivalent, where  $P' \rightarrow x$  is not a tautology ( $x \notin P'$ ).*

1.  $F \models P' \rightarrow x$ ;
2.  $F^x \cup P' \models P$  where  $P \rightarrow x \in F$ ;
3.  $F \cup P' \models P$  where  $P \rightarrow x \in F$ .

*Proof.* The second condition implies the third by monotonicity of entailment.

The third entails the first because  $P \rightarrow x \in F$  implies  $F \models P \rightarrow x$ , which in turn implies  $F \cup P \models x$ . With  $F \cup P' \models P$ , it implies  $F \cup P' \models x$  by transitivity of entailment. By the deduction theorem,  $F \models P' \rightarrow x$  follows.

What remains to be proved is that the first condition implies the second. The assumption is  $F \models P' \rightarrow x$ ; the claim is  $F^x \cup P' \models P$  where  $P \rightarrow x \in F$ .

If  $F$  does not contain a positive occurrence of  $x$ , it is satisfied by the model that assigns all variables to true but  $x$ , since every clause of  $F$  contains a positive variable that is not  $x$ . This model falsifies  $P' \rightarrow x$ , contrary to the assumption. This proves that  $F$  contains at least a clause  $P \rightarrow x$ .

The claim is that  $F^x \cup P' \models P$  holds for some clause  $P \rightarrow x \in F$ . Its contrary is that  $F^x \cup P' \not\models P$  holds for every clause  $P \rightarrow x \in F$ . This is proved impossible.

The condition  $F^x \cup P' \not\models P$  implies the existence of a model  $M_P$  such that  $M_P \models F^x \cup P'$  and  $M_P \not\models P$ . Let  $M$  be the intersection of all these models  $M_P$  for every  $P \rightarrow x \in F$ : the model that evaluates to true exactly the variables that are true in all these models  $M_P$ . Alternatively, it is the model that sets to false exactly the variables that are false in at least one model  $M_P$ .

Since  $F^x \cup P'$  is Horn and is satisfied by all models  $M_P$ , it is also satisfied by their intersection  $M$ . Since  $M_P$  does not satisfy  $P$ , which is a set of positive literals,  $M_P$  assigns at least a variable of  $P$  to false; by construction, that variable is also false in  $M$ . Therefore,  $M \not\models P$  for all  $P \rightarrow x \in F$ .

Let  $M_{x=\text{false}}$  be the model that assigns  $x$  to false and all other variables to the same value  $M$  does. This model will be proved to satisfy  $F \cup P'$  but not  $x$ , contradicting the assumption  $F \models P' \rightarrow x$ .

Since  $M \models F^x$  and  $F^x$  does not contain  $x$ , the condition  $M_{x=\text{false}} \models F^x$  follows. Since  $M \not\models P$  and  $x \notin P$ , it follows  $M_{x=\text{false}} \not\models P$ , which implies  $M_{x=\text{false}} \models P \rightarrow x$ ; this holds for every  $P \rightarrow x \in F$ . Since  $x$  is false in  $M_{x=\text{false}}$ , this model also satisfies all clauses of  $F$  containing  $x$  in the body. This proves that  $M_{x=\text{false}}$  implies all clauses of  $F^x$ , all clauses of  $F$  containing  $x$  in the head and all containing  $x$  in the body. As a result,  $M_{x=\text{false}} \models F$ . Since  $x$  is not in  $P'$  and  $M \models P'$ , also  $M_{x=\text{false}} \models P'$  holds. Since  $M_{x=\text{false}}$  sets  $x$  to false,  $F \cup P' \not\models x$  holds. By the deduction theorem,  $F \not\models P' \rightarrow x$ , contrary to the assumption.  $\square$

This lemma proves that all clauses  $P' \rightarrow x$  entailed by  $F$  are either themselves in  $F$ , or are consequences of another clause  $P \rightarrow x \in F$  thanks to  $F^x$  implying  $P' \rightarrow P$ . Seen from a different angle, all derivations of  $x$  from  $P'$  use  $P \rightarrow x \in F$  as the last step, and only clauses of  $F^x$  in the previous.

The condition  $F^x \cup P' \models P$  can be rewritten as  $F^x \models P' \rightarrow y$  for every  $y \in P$ . This allows applying the lemma again, to  $P' \rightarrow y$ : there exists  $P'' \rightarrow y \in F$  such that  $F^{xy} \models P' \rightarrow P''$ .

This recursion is not infinite: it ends when  $P' = P$ ; not only the lemma does not rule this case out, it is its base case. More generally, it does not forbid  $P$  and  $P'$  to intersect. Rather the opposite: at some point back in the recursion they must coincide. Indeed,  $F$  becomes  $F^x$ , then  $F_{xy}$  and so on; infinite recursion is not possible because the formula becomes smaller at every step and therefore it ends up empty, and the lemma implies that the formula contains at least a clause.

## 4.2 body\_replace()

The recursive application of Lemma 9 allows for repeatedly replacing unwanted variables with others implying them. When forgetting  $y$ , every entailed clause  $F \models P' \rightarrow x$  not containing  $y$  must survive. By Lemma 9, the entailment implies  $F^x \models P' \rightarrow P$  and  $P \rightarrow x \in F$ . If  $y \notin P$ , clause  $P \rightarrow x$  survives the removal of  $y$ . If  $y \in P$ , Lemma 9 kicks in:  $F^x \models P' \rightarrow y$  requires some clauses  $P'' \rightarrow y \in F$ . Each can be combined with  $P \rightarrow x$  to obtain  $P'' \cup P \setminus \{y\} \rightarrow x$ , which does not contain  $y$ . This combination leaves  $P' \rightarrow x$  entailed in spite of the removal of  $P \rightarrow x$ . The same procedure allows forgetting other variables at the same time.

set, set **body\_replace**(formula  $F$ , set  $R$ , set  $D$ )

1. choose  $R' \subseteq R \setminus D$
2.  $S' = \emptyset$
3.  $E' = \emptyset$
4. foreach  $y \in R'$

- (a) if  $y \in D \cup E'$  continue
  - (b) choose  $P \rightarrow y \in F$  else **fail**
  - (c)  $S, E = \mathbf{body\_replace}(F^y, P, D \cup E')$
  - (d)  $S' = S' \cup S$
  - (e)  $E' = E' \cup E \cup \{y\}$
5. return  $R \setminus D \setminus R' \cup S', E'$

The choice of the initial values of  $R$  and  $D$  and the choice of  $R'$  is left open at this point because it simplifies some proofs, but the intention is that initially  $R$  is the body of some clause  $R \rightarrow x$  where  $x$  is a variable not to be forgotten,  $D$  is initially empty and  $R'$  contains exactly all variables of  $R \setminus D$  to forget. In each call:

- $R$  is the body some clause  $R \rightarrow x$  where  $x$  is a variable not to forget;
- $\mathbf{body\_replace}(F, R, D)$  tries to replace the variables of  $R$  to forget with others that entail them and are not to forget;
- the first return value is the set of replacing variables;
- $D$  contains the variables that have already been replaced;
- the second return value contains the variables that have been replaced in this call.

This procedure hinges around its second parameter  $R$ , a set of variables. It replaces some of its elements with variables that entail them according to  $F$ ; the replacing variables are the first return value. In the base case,  $y \in R$  is replaced by some  $P$  with  $P \rightarrow y \in F$ , but then some elements of  $P$  may be recursively replaced in the same way. This is how forgetting happens: if all variables to be forgotten are replaced by all sets of variables that entail them, they disappear from the formula while leaving all other consequences intact.

The last parameter  $D$  is empty in the first call, and changes at each recursive call. It is the set of variables already replaced. Every time a variable  $y \in R$  is replaced, it is added to  $E'$ , which is then passed to every subsequent recursive call and eventually returned as the second return value. This way, if  $y$  has already been replaced it is removed instead of replaced again; this is correct because its replacing variables are already in  $S'$ , which is part of the first return value.

The two return values have the same meaning of  $R$  and  $D$  but after the replacement:  $R \setminus D \setminus R' \cup S'$  is  $R$  with some variables replaced;  $E'$  is the set of these replaced variables; to be precise, these are only the variables replaced in this call and its subcalls, not in some previous recursive call.

Termination is guaranteed by the use of  $F^y$  in the recursive calls and by the set of already-replaced variables  $D$ . The first makes the formula used in the subcalls smaller and smaller; when it is empty, the nondeterministic choice of a clause in the loop fails. The second makes replacing  $y$  when  $y \in D$  just a matter of removing  $y$  without a recursive call.

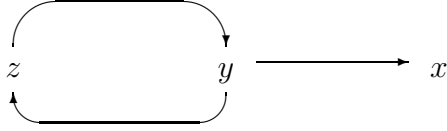

The first condition breaks loops like in  $\{y \rightarrow z, z \rightarrow y, y \rightarrow x\}$  when forgetting  $y$  and  $z$ : after replacing  $y$  by  $z$ , the clause  $y \rightarrow z$  is removed from the formula used in the subcall. This disallows replacing  $z$  by  $y$ , which would create an infinite chain of replacements.

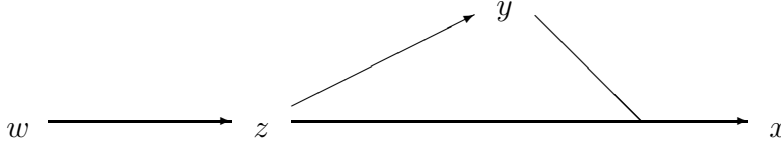

The second condition forbids multiple replacements, like in  $\{w \rightarrow z, z \rightarrow y, yz \rightarrow x\}$  when forgetting  $y$  and  $z$ : after  $y$  is replaced by  $z$  and  $z$  by  $w$  in  $yz \rightarrow x$ , the clause  $yz \rightarrow x$  becomes  $wz \rightarrow x$ , and the procedure moves to replacing  $z$ ; this is recognized as unnecessary because  $z$  have already been replaced (by  $w$ ), so it is simply deleted.

While termination is guaranteed, success is not. The set  $R'$  may contain a variable  $y$  with no clause  $P \rightarrow y$  in  $F$ . In such cases,  $y$  cannot be replaced by its preconditions in  $F$ . For example, when replacing  $\{y, z\}$  in  $F = \{w \rightarrow y, yz \rightarrow x\}$ , the first variable  $y$  can be replaced by  $w$ , but the second variable  $z$  cannot be replaced by anything, since no clause has  $z$  as its head. Running `body_replace(F, {y, z}, ∅)` fails if  $R'$  is chosen to contain  $z$ . This is correct because no subset of the other variables  $\{x, w\}$  entail  $z$  with  $F$ . Failure indicates that no such replacement is possible.

The first step of proving that the procedure always terminates tells when no recursive subcall is done. This is the base case of recursion.

**Lemma 10** *A successful call to `body_replace()` does not perform any recursive subcall if and only if  $R' = \emptyset$ .*

*Proof.* If  $R' = \emptyset$  no loop iteration is executed; therefore, no recursive subcall is performed.

The other direction is proved in reverse:  $R' \neq \emptyset$  implies that some recursive subcall is performed. Let the first variable chosen in the loop be  $y \in R'$ . Since  $R'$  is a subset of  $R \setminus D$ , it does not contain any element of  $D$ . Initially,  $E'$  is empty. As a result,  $y \notin D \cup E'$ . Therefore, the iteration is not cut short at the check  $y \in D \cup E'$ . Since the call does not fail, the iteration is not cut short at the check  $P \rightarrow y \in F$  either. The next step is the recursive call. □

The main component of the proofs about `body_replace()` are its two invariants. The first is recursive, a relation between parameters and return values. The second is iterative, a relation between the local variables at each iteration of the loop. All properties of the procedure are consequences of the first, which requires the second to be proved. More precisely, each proves the other. This is why they are in the same lemma.

**Lemma 11** *The following two invariants hold when running `body_replace(F, R, D)`:*

**recursive invariant:** *if it returns  $S, E$ , then  $F \cup S \cup D \models R \cup E$ ;*

**loop invariant:** *at the beginning and end of each iteration of its loop (Step 4), it holds  $F \cup S' \cup D \models E'$ .*

*Proof.* The two invariants are first shown to hold in their base cases. Then, they are shown to each imply the other in an arbitrary call.

The base case for the loop invariant is the start of the first iteration of the loop. Since  $E'$  is initially empty, the condition  $F \cup S' \cup D \models E'$  holds.

The base case for the recursive invariant is a call where no recursive subcall is done. This is only possible if  $R' = \emptyset$  by Lemma 10. Since no loop iteration is executed,  $S'$  and  $E'$  retain their initial value  $\emptyset$ . The return values are  $R \setminus D \setminus R' \cup S' = R \setminus D$  and  $E' = \emptyset$ . The recursive invariant is therefore  $F \cup (R \setminus D) \cup D \models R \cup \emptyset$ , which is equivalent to the trivially true proposition  $F \cup R \cup D \models R$ .

The two invariants are now inductively proved in the general case.

The loop invariant is proved true at the end of each iteration of the loop. The inductive assumptions are that it is true at the start of the iteration and that the recursion invariant is true after each recursive subcall. Formally, the two assumptions and the conclusion to be proved are:

$$\begin{aligned} \text{assumption (loop):} & \quad F \cup S' \cup D \models E' \\ \text{assumption (recursion):} & \quad F^y \cup S \cup (D \cup E') \models P \cup E \\ \text{conclusion to be proved (loop):} & \quad F \cup (S' \cup S) \cup D \models (E' \cup E \cup \{y\}) \end{aligned}$$

The three parts of  $E' \cup E \cup \{y\}$  are proved to follow from  $F \cup S' \cup S \cup D$  one at time:

- since  $F \cup S' \cup D \models E'$ , it holds  $F \cup S' \cup S \cup D \models E'$ ;
- The formula  $F \cup S' \cup S \cup D$  is a superset of  $F \cup S' \cup D$ , which entails  $E'$  by the loop assumption. Therefore,  $F \cup S' \cup S \cup D \models E'$ . This implies the equivalence of  $F \cup S' \cup S \cup D$  and  $F \cup S' \cup S \cup D \cup E'$ . The latter formula is a superset of  $F^y \cup S \cup D \cup E'$ , which implies  $E \cup P$  by the recursion assumption. This proves the second part of the conclusion:  $F \cup S' \cup S \cup D \models E$ ;
- the previous point also proves that  $F \cup S' \cup S \cup D \models P$ ; since  $P \rightarrow y \in F$ , it follows  $F \cup S' \cup S \cup D \models y$ .

What remains to be proved is the recursion invariant in the general case. Since the return values are  $R \setminus D \setminus R' \cup S'$  and  $E'$ , the invariant to be proved is  $F \cup (R \setminus D \setminus R' \cup S') \cup D \models R \cup E'$ , which can be rewritten as  $F \cup (R \setminus R' \cup S') \cup D \models R \cup E'$ . The subset  $R \setminus R'$  of the consequent  $R$  is entailed because it is also in the antecedent. Therefore, the invariant is equivalent to  $F \cup (R \setminus R' \cup S') \cup D \models R' \cup E'$ . This is a consequence of  $F \cup S' \cup D \models R' \cup E'$ , which is now proved to hold. First  $E'$  and then  $R'$  are shown to be consequences of  $F \cup S' \cup D$ .

- $F \cup S' \cup D \models E'$  is the loop invariant, which is assumed to hold;
- what remains to be proved is  $F \cup S' \cup D \models R'$ ; this is proved for every element of  $R'$ , that is,  $F \cup S' \cup D \models y$  holds for every  $y \in R'$ ; the loop is run on every  $y \in R'$ ; the iteration is cut short if  $y \in D \cup E'$ ; otherwise, iteration continues and  $E' = E' \cup E \cup \{y\}$  is executed; in both cases,  $y \in D \cup E'$  holds at the end of the iteration; since  $D$  is never changed and  $E'$  monotonically increases,  $y \in D \cup E'$  also holds at the end of the loop; if  $y \in D$  then  $F \cup S' \cup D \models y$  is tautological; otherwise,  $y \in E'$ ; the loop invariant  $F \cup S' \cup D \models E'$  implies  $F \cup S' \cup D \models y$ .

Since the loop invariant and the recursion invariant are both true in their base cases, and are both proved to hold in the induction cases, they are both always true.  $\square$

The aim of **body\_replace**( $F, R, D$ ) is to replace some variables of  $R$  with others implying them according to  $F$ . The recursive invariant after  $S, E = \mathbf{body\_replace}(F, R, D)$  is  $F \cup S \cup D \models R \cup E$ . The first return value entails the variables to be replaced according to  $F$ , when  $D = \emptyset$  as it should be in the first recursive call. Otherwise,  $D$  is a set of variables that have already been replaced; their replacements are in the set  $S$  for some call somewhere in the recursive tree. Since all first return values are accumulated, they are returned by the first call.

All of this happens if the recursive call returns.

Forgetting maintains all consequences on the non-forgotten variables. Let  $P' \rightarrow x$  be such a consequence:  $F \models P' \rightarrow x$ . This condition is the same as  $F^x \models P' \rightarrow P$  and  $P \rightarrow x$  by Lemma 9. While  $x$  is not one of the variables to forget by assumption,  $P$  may contain some. If it does, they can be replaced by their preconditions, as **body\_replace**( $F, P, \emptyset$ ) does. But variables may have more than one set of possible preconditions, and some may not be useful to ensure the entailment of  $P' \rightarrow x$ . Only the ones entailed by  $P'$  are. The others are not: if a replacing variable is not entailed by  $P'$ , the result of replacement cannot be used to entail  $P' \rightarrow x$ , still because of Lemma 9. The following lemma confirms that the right choice of preconditions is always possible.

**Lemma 12** *If  $F \cup P' \models P$ , some nondeterministic choices of clauses in **body\_replace**( $F, P, \emptyset$ ) and its subcalls ensure their successful termination and the validity of the following invariants for every recursive call  $S, E = \mathbf{body\_replace}(F, R, D)$  and every possible choices of  $R'$  that do not include a variable in  $P'$ :*

$$\begin{aligned} F \cup P' &\models R \\ F \cup P' &\models S \end{aligned}$$

*Proof.* The first invariant is proved from calls to subcalls, the second in the other direction.

The assumption  $F \cup P' \models P$  of the lemma is the first invariant on the first call **body\_replace**( $F, P, \emptyset$ ). This proves the first invariant in the base case. Given that it is true for an arbitrary call, it is proved true for all recursive subcalls. The inductive assumption is  $F \cup P' \models R$  at the beginning of the call **body\_replace**( $F, R, D$ ). Since  $R' \subseteq R$ , it holds  $F \cup P' \models y$  for every  $y \in R'$ . If  $y \in D \cup E'$ , no recursive subcall is done. Otherwise, the clause  $P \rightarrow y$  is chosen according to Lemma 9: since  $F \cup P' \models y$  and  $y$  is not in  $P'$  because  $R' \cap P' = \emptyset$ , there exists  $P \rightarrow y \in F$  such that  $F^y \cup P' \models P$ . The recursive subcall is **body\_replace**( $F^y, P, D \cup E'$ ); the invariant is therefore  $F^y \cup P' \models P$ , which has just been shown to hold. This proves that the first invariant is true for all recursive calls.

This first invariant  $F \cup P' \models R$  proves that the procedure always terminates. Since  $R'$  does not contain any element of  $P'$ , it holds  $F \cup P' \models y$  and  $y \notin P'$  for every  $y \in R'$ . Therefore, for every such  $y \in R'$  Lemma 9 tells that  $F$  contains a clause  $P \rightarrow y$ . This means that failure never occurs. The contrary of the claim is the existence of an infinite chain of recursive calls. Since the formula  $F^y$  used in the recursive subcall is a strict subset of the formula of the call  $F$ , at some point the formula that is the argument of the call is empty.

The condition  $P \rightarrow y \in F$  for every  $y \in R'$  is possible when  $F = \emptyset$  only if  $R' = \emptyset$ . By Lemma 10, no recursive subcall is done, contrary to assumption.

The second invariant is proved to hold for the same choices of clauses. Since the choices are the same, the first invariant holds for every call:  $F \cup P' \models R$ . The base case for the second invariant are the calls when no recursive subcall is done. This is only possible if  $R' = \emptyset$  by Lemma 10. No loop iteration is performed; therefore,  $S' = \emptyset$ . The first return value is  $R \setminus D \setminus R' \cup S' = R \setminus D \setminus \emptyset \cup \emptyset = R \setminus D$ . The second invariant is true if this set is entailed by  $F \cup P'$ . This holds because of the first invariant,  $F \cup P' \models R$ . This proves the base case for the second invariant.

For a general recursive call, the inductive assumption is that the second invariant holds for the recursive subcalls. In formulae,  $F^y \cup P' \models S$  in every loop iteration. Since  $S'$  accumulates the sets  $S$ , this implies  $F \cup P' \models S'$ . Since  $F \cup P' \models R$  by the first invariant,  $F \cup P' \models R \cup S'$ . The return value  $R \setminus D \setminus R' \cup S'$  is a subset of  $R \cup S'$ , and is therefore also entailed by  $R \cup S'$ .  $\square$

Since the invariants hold for all calls, they hold for the first:  $F \cup P'$  implies the first return value of **body\_replace**( $F, P, \emptyset$ ) for appropriate nondeterministic choices. In the other way around, the nondeterministic choices can be taken so to realize this implication.

The second requirement of forgetting is that all variables to be forgotten are removed from the formula. Calling **body\_replace**( $F, P, \emptyset$ ) replaces the variables in  $R'$  from  $P$ . Forgetting is obtained by choosing  $R'$  as the variables to be forgotten in  $P$  in the first call. In an arbitrary call **body\_replace**( $F, R, D$ ), the variables in  $D$  have already been replaced, so they are not to be replaced again. Therefore,  $R'$  comprises the variables to be forgotten of  $R \setminus D$ .

The following lemmas concern **body\_replace**( $F, R, D$ ) when  $R'$  is always  $R \setminus D \setminus V$  for some set of variables  $V$ . Forgetting is achieved if  $V$  is the set of variables to be retained.

**Lemma 13** *If  $R'$  is always chosen equal to  $R \setminus D \setminus V$  for a given set of variables  $V$ , the first return value of **body\_replace**( $F, P, \emptyset$ ) and every recursive subcall is a subset of  $V$ , if the call returns.*

*Proof.* As proved by Lemma 10, the base case of recursion is  $R' = \emptyset$ . Since no loop iteration is performed,  $S'$  retains its initial value  $\emptyset$ . The return value  $R \setminus D \setminus R' \cup S'$  is therefore the same as  $R \setminus D$ . Since  $R' = R \setminus D \setminus V$  and  $R' = \emptyset$ , the set  $R' = R \setminus D \setminus V$  is empty. This is only possible if  $R \setminus D$  contains only elements of  $V$ .

In the induction case, all return values  $S$  are subsets of  $V$ . Since  $S'$  accumulates the sets  $S$ , also  $S' \subseteq V$  holds. Since  $R'$  contains all variables of  $R \setminus D$  that are not in  $V$ , the set  $R \setminus D \setminus R'$  contains only variables in  $V$ . The return value  $R \setminus D \setminus R' \cup S'$  is therefore a subset of  $V$ .  $\square$

Termination is not guaranteed by this lemma; for example, a failure is generated by **body\_replace**( $F, \{y\}, \emptyset$ ) when  $F = \{y \rightarrow x\}$  with  $V = \{x\}$ , since  $R' = R \setminus \emptyset \setminus \{x\} = \{y\}$ , but no clause of  $F$  has  $y$  in the head. The claim of the lemma only concerns the case of termination, as the words “if this call returns” clarify.

The following lemma shows that Lemma 12 holds even if  $R'$  is always chosen to be  $R \setminus D \setminus V$ . This is not obvious because that lemma only states that its claim holds for some nondeterministic choices.



**Lemma 14** *For some nondeterministic choices of clauses the call  $S, E = \mathbf{body\_replace}(F, P, \emptyset)$  returns and the first return value satisfies  $F \cup P' \models S$ , provided that  $F \cup P' \models P$ ,  $P' \subseteq V$  and the nondeterministic choices of variables are always  $R' = R \setminus D \setminus V$ .*

*Proof.* The choices  $R' = R \setminus D \setminus V$  satisfy the condition  $R' \cap P' = \emptyset$  of Lemma 12 since it does not contain any variable of  $V$  while  $P'$  only contains variable of  $V$ . The other condition  $F \cup P' \models P$  of that lemma is one of the assumptions of this one. Lemma 12 tells that a suitable sequence of nondeterministic choices of clauses makes  $S, E = \mathbf{body\_replace}(F, P, \emptyset)$  returns and that the first return value satisfies  $F \cup P' \models S$ .  $\square$

The conclusion of this string of lemmas is that suitable nondeterministic choices make  $S, E = \mathbf{body\_replace}(F, R, \emptyset)$  return a set  $S \subseteq V$  such that  $F \models S \rightarrow R$  and  $F \models R \rightarrow P$ .

### 4.3 head\_implicates

Forgetting requires all consequences  $P' \rightarrow x$  on the variables not to forget to be retained while all variables to forget disappear. By Lemma 9,  $F \models P' \rightarrow x$  is the same as  $F^x \models P' \rightarrow P$  and  $P \rightarrow x$ . A way to entail  $P' \rightarrow x$  from another formula  $G$  is by ensuring  $G \models P' \rightarrow S$  and  $S \rightarrow x \in G$ . The lemmas in the previous section tells how to obtain this condition from a common-equivalent formula  $G$  over the variables  $V$  not to forget: by running  $S, E = \mathbf{body\_replace}(F, P', \emptyset)$  so that  $S \subseteq V$ ,  $F \models P' \rightarrow S$  and  $F \models S \rightarrow P$ . Since  $P', S$  and  $x$  are common variables,  $G$  may entail  $P' \rightarrow S$  and it may contain  $S \rightarrow x$ . Therefore,  $S \rightarrow x$  is a valid choice for a clause in  $G$ , and allows entailing  $P' \rightarrow x$  if  $G \models P' \rightarrow S$ . The latter condition is achieved by ensuring  $G \models P' \rightarrow s$  for each  $s \in S$  in a similar way. In other words, if every  $P \rightarrow x \in F$  is turned into  $S \rightarrow x$  for all  $S$  that are the first return value of  $\mathbf{body\_replace}(F, P', \emptyset)$ , all common consequences are retained while all variables to forget are removed.

This is what the following procedure does.

clause **head\_implicates**( $F$ )

1. nondet  $x \in \mathit{Var}(F)$
2. nondet  $P \rightarrow x \in F$  else **fail**
3.  $S, E = \mathbf{body\_replace}(F^x, P, \emptyset)$
4. return  $S \rightarrow x$

In order to derive all common consequences  $P' \rightarrow x$  from the resulting formula, replacing every  $P \rightarrow x$  with  $S \rightarrow x$  is not enough. The same is required for  $P' \rightarrow s$  for every  $s \in S$ . Common equivalence is achieved only when the replacement is done to all clauses, not only the ones with head  $x$ .

A first required lemma is that no tautology is returned. It looks obvious, and could also be shown as a consequence of a condition on  $\mathbf{body\_replace}(F, R, D)$  always returning a subset of  $\mathit{Var}(F) \cup R$ , but that would require a recursive proof. Instead, it is obvious when  $D = \emptyset$ .

**Lemma 15** *No run of `head_implicates`( $F$ ) produces a tautological clause.*

*Proof.* The call `body_replace`( $F^x, P, \emptyset$ ) may only generate sets of variables contained in  $\text{Var}(F^x) \cup P$  since the only other sets of variables involved in the procedure are  $D$  and  $V$ , but  $D$  is empty in this case and  $V$  is only used in set subtractions.

Since  $F$  does not contain tautologies and  $P \rightarrow x \in F$ , the variable  $x$  is not in  $P$ . It is also not in  $F^x$  by construction. The first return value of `body_replace`( $F^x, P, \emptyset$ ) is a set of variables  $S$  (positive literals) contained in  $\text{Var}(F^x) \cup P$ , which does not contain  $x$ . Since  $x \notin S$ , the final result  $S \rightarrow x$  is not a tautology.  $\square$

The following lemma proves that `head_implicates`( $F$ ) produces the required clause  $S \rightarrow x$ . It may also produce other clauses, depending on the nondeterministic choices.

**Lemma 16** *If  $F \models P' \rightarrow x$ ,  $P' \subseteq V$  and  $x \notin P'$  then `head_implicates`( $F$ ) outputs a clause  $S \rightarrow x$  such that  $F^x \cup P' \models S$ , provided that  $R'$  is always chosen as  $R \setminus D \setminus V$  for some given set of variables  $V$ .*

*Proof.* The variable chosen in `head_implicates`( $F$ ) is  $x$ . Since  $F \models P' \rightarrow x$  and  $x \notin P'$ , Lemma 9 implies the existence of a clause  $P \rightarrow x \in F$  such that  $F^x \cup P' \models P$ . This clause is the second nondeterministic choice in `head_implicates`( $F$ ). Therefore, `body_replace`( $F^x, P, \emptyset$ ) is called with  $F^x \cup P' \models P$ . By Lemma 14, some nondeterministic choices of clauses makes the call return with a first return value that satisfies  $F^x \cup P' \models S$  with the given choices of  $R'$ . The clause returned by `head_implicates`( $F$ ) is  $S \rightarrow x$ , where  $F^x \cup P' \models S$ .  $\square$

The reason why the above is a lemma and not a theorem is that the conclusion that all common consequences are maintained requires its repeated application: not only  $P \rightarrow x$  is replaced by  $S \rightarrow x$ , but also  $P'' \rightarrow s$  is similarly replaced for every  $s \in S \setminus V$ .

**Theorem 9** *With the nondeterministic choices  $x \in V$  and  $R' = R \setminus D \setminus V$ , `head_implicates`( $F$ ) returns only clauses  $S \rightarrow x$  that are on the alphabet  $V$  and are consequences of  $F$ . If  $F \models P' \rightarrow x$  and  $\text{Var}(P' \rightarrow x) \subseteq V$  then  $P' \rightarrow x$  is entailed by some clauses produced by `head_implicates`( $F$ ) with the nondeterministic choices  $x \in V$  and  $R' = R \setminus D \setminus V$ .*

*Proof.* Let  $S \rightarrow x$  be a clause returned by `head_implicates`( $F$ ). Since  $x$  is the result of its first nondeterministic choice,  $x \in V$  holds by assumption. If `head_implicates`( $F$ ) returns, it chose a clause  $P \rightarrow x \in F$ . By Lemma 13, the first return value of `body_replace`( $F^x, P, \emptyset$ ) satisfies  $S \subseteq V$ . This proves that  $S \rightarrow x$  only contains variables of  $V$ . By the first invariant in Lemma 11, it holds  $F^x \cup S \cup \emptyset \models P \cup E$ . Since  $P \rightarrow x \in F$ , the entailment  $F \cup S \models x$  follows. By the deduction theorem,  $F \models S \rightarrow x$ .

The long part of the proof is to show that if  $P' \rightarrow x$  is a consequence of  $F$  then it is also a consequence of some clauses generated by `head_implicates`( $F$ ) if  $\text{Var}(P' \rightarrow x) \subseteq V$ .

If  $x \in P'$  the clause  $P' \rightarrow x$  is tautological and the claim is proved. Otherwise, Lemma 16 tells that `head_implicates`( $F$ ) produces a clause  $S \rightarrow x$  with  $F^x \cup P' \models S$ .

If  $S \subseteq P'$  holds the claim is proved. It is now proved that all  $y \in S \setminus P'$  can be resolved out by some other clauses generated by the algorithm. Since  $F^x \cup P' \models S$ , the entailment

$F^x \cup P' \models y$  holds for every  $y \in S$ , including the variables  $y \in S \setminus P'$ . This entailment can be rewritten as  $F^x \models P' \rightarrow y$ . Since  $y \notin P'$ , Lemma 16 tells that **head\_implicates**( $F^x$ ) outputs a clause  $S' \rightarrow y$  such that  $F^{xy} \cup P' \models S'$ . The clauses  $S' \rightarrow y$  and  $S \rightarrow x$  resolve on  $y \in S$ , producing  $S' \cup (S \setminus \{y\}) \rightarrow x$ .

This process can be iterated as long as the antecedent of the clause obtained by resolution contains some elements that are not in  $P'$ . In the other way around, this process terminates only when the body of the clause is a subset of  $P'$ .

The process terminates because the formula shrinks at every step: first is  $F$ , then  $F^x$ , then  $F^{xy}$ . Non-termination would imply a call to **head\_implicates**( $\emptyset$ ) that produces a clause by Lemma 16. This clause is a consequence of  $\emptyset$  as shown in the first paragraph of this proof, and is non-tautological by Lemma 15. This is a contradiction. As a result, the process terminates. As proved in the previous paragraph, if the process terminates the clause that is the result of resolution has the form  $P'' \rightarrow x$  where  $P'' \subseteq P'$ . This clause entails  $P' \rightarrow x$  because it is a subset of it.

The final step of the proof accounts for the calls where the formula is not  $F$  but  $F^x$ ,  $F^{xy}$ , etc. Every clause generated by **head\_implicates**( $F'$ ) with  $F' \subseteq F$  is also produced by **head\_implicates**( $F$ ). This is the case because the same variables and clauses chosen in a run **head\_implicates**( $F'$ ) can also be chosen in the run **head\_implicates**( $F$ ), and the result is the same.  $\square$

This lemma ensures the correctness of **head\_implicates**( $F$ ) to forget variables and check common equivalence, as it produces clauses not containing variables in  $V$  but still entailing the same consequences of  $F$  among the ones not containing  $V$ .

What about its efficiency? It works in polynomial space.

**Theorem 10** *For every set of nondeterministic choices, **head\_implicates**( $F$ ) works in polynomial space.*

*Proof.* The lemma holds because each individual recursive call only takes polynomial space, and only a linear number of recursive calls are made in each nondeterministic branch.

The first claim holds because the data used in each call is the formula  $F$ , a clause  $P \rightarrow x$  or  $P' \rightarrow x$  at time, a subset  $F^x$  or  $F^y$  at time and a constant number of sets of variables. The size of  $F$  polynomially bounds all of this.

The second claim holds because of the decreasing size of the formula used in the recursive subcalls: **head\_implicates**( $F$ ) calls **body\_replace**( $F^x, \dots$ ), which calls **body\_replace**( $F^{xy}, \dots$ ), which calls **body\_replace**( $F^{xyz}, \dots$ ) and so on. Each variable  $x, y, z, \dots$  is the head of a clause of the formula. All such clauses are removed from the formula before the recursive call. Therefore, the same variable cannot be chosen again in the same nondeterministic branch. This implies that the formula is smaller at each recursive subcall. After at most  $|Var(F)|$  calls the formula is empty, and recursion stops.

This proves that **common\_equivalence**( $A, B$ ) runs in nondeterministic polynomial space, which is the same as deterministic polynomial space [Sav70].  $\square$

## 4.4 common equivalence

The algorithm **head\_implicates**( $F$ ) generates a formula over  $V$  that has the same consequences of  $F$  on  $V$ . It is a way to forget the variables of  $Var(F) \setminus V$  from  $F$ . Common

equivalence could be checked by forgetting all non-shared variables and then verifying regular equivalence:  $\mathbf{head\_implicates}(A) \equiv \mathbf{head\_implicates}(B)$  with  $V = \text{Var}(A) \cap \text{Var}(B)$ . This is correct but may take not only exponential time but also exponential space because the output of  $\mathbf{head\_implicates}()$  may be exponentially larger than  $A$ .

This is avoided by generating and checking a clause at time: every clause produced by  $\mathbf{head\_implicates}(A)$  is checked against  $B$  for entailment, and the other way around.

boolean  $\mathbf{common\_equivalence}(A, B)$

1. for each  $S \rightarrow x$  generated by  $\mathbf{head\_implicates}(A)$  with  $x \in V$  and  $R' = R \setminus D \setminus V$  where  $V = \text{Var}(A) \cap \text{Var}(B)$ 
  - (a) if  $B \not\models S \rightarrow x$  return false
2. for each  $S \rightarrow x$  generated by  $\mathbf{head\_implicates}(B)$  with  $x \in V$  and  $R' = R \setminus D \setminus V$  where  $V = \text{Var}(A) \cap \text{Var}(B)$ 
  - (a) if  $A \not\models S \rightarrow x$  return false
3. return true

The following theorem proves the correctness of the algorithm.

**Theorem 11** *Algorithm  $\mathbf{common\_equivalence}(A, B)$  returns whether  $A$  and  $B$  are common equivalent.*

*Proof.* By Theorem 9,  $\mathbf{head\_implicates}(A)$  returns some clauses on  $V = \text{Var}(A) \cap \text{Var}(B)$  that are entailed by  $A$ . If  $B$  does not entail one of them, that clause is a formula on  $V$  that is entailed by  $A$  but not by  $B$ , violating the definition of common equivalence. The same holds if  $A$  does not entail a clause of  $\mathbf{head\_implicates}(B)$ .

The other case is that  $A$  entails  $\mathbf{head\_implicates}(B)$  and  $B$  entails  $\mathbf{head\_implicates}(A)$ . The claim is  $A \equiv B$ : if  $A \models C$  then  $B \models C$  and vice versa for all formulae  $C$  over  $V$ . Let  $C$  be a formula on  $V$ , and  $C_1, \dots, C_m$  the clauses in its conjunctive normal form. If  $A \models C$  then  $A$  entails all clauses  $C_i$ . By Theorem 9,  $\mathbf{head\_implicates}(A)$  entails all clauses on  $V$  that are entailed by  $A$ , including all clauses  $C_i$ . Therefore, it entails  $C$ . Since  $B$  entails  $\mathbf{head\_implicates}(A)$ , it entails all  $C$ . The same argument with  $A$  and  $B$  swapped proves the converse.  $\square$

While  $\mathbf{head\_implicates}()$  runs in polynomial space by Theorem 10, its output may be exponentially large. Therefore, it cannot be stored in full. Rather, it has to be generated a clause at time, which is then checked for entailment from the other formula. Section 8.2 digs into such implementation details.

## 4.5 forget

What `head_implicates(F)` does is to nondeterministically produce the clauses of  $F$  after replacing all variables not in  $V$ . The common equivalence procedure uses it, as it checks whether every such clause is entailed by the other formula. Just collecting the output of `head_implicates(F)` is a way of forgetting variables.

formula `forget(F, X)`

1.  $G = \emptyset$
2. for each  $S \rightarrow x$  generated by `head_implicates(F)` with  $x \in \text{Var}(F) \setminus X$  and  $R' = R \setminus D \setminus (\text{Var}(F) \setminus X)$ :
  - (a)  $G = G \cup \{S \rightarrow x\}$
3. return  $G$

Both `body_replace()` and `head_implicates()` depend on nondeterministic choices. Those of  $x$  and  $R'$  are specified in `forget()`, the others only affect the order of generated clauses, which is irrelevant to `forget()` as it was to `common_equivalence()`.

The following lemma proves that `forget(F, X)` produces the expected result: a formula that is common equivalent to  $F$  and contains only the variables of  $F$  but  $X$ .

**Theorem 12** *Algorithm `forget(F, X)` returns a formula on alphabet  $\text{Var}(F) \setminus X$  that has the same consequences of  $F$  on this alphabet.*

*Proof.* By Theorem 9, the given nondeterministic choices of  $x$  and  $R'$  make `head_implicates(F)` return only clauses on  $V = \text{Var}(F) \setminus X$  that are entailed by  $F$ , and each clause on  $V = \text{Var}(F) \setminus X$  that is entailed by  $F$  is a consequence of some clauses returned by `head_implicates(F)`. This means that the set of returned clauses is on the alphabet  $\text{Var}(F) \setminus X$  and entails every consequence of  $F$  on this alphabet.  $\square$

The definition of forgetting in terms of common equivalence constrains the variables to be exactly  $\text{Var}(F) \setminus X$ . This may not be the case for `forget(F, X)`. For example, when forgetting  $d$  from  $F = \{a \rightarrow b, c \rightarrow d\}$ , it produces  $\{a \rightarrow b\}$ , which does not contain  $c \in \text{Var}(F) \setminus \{d\}$ . This example is in the file `disappear.py`. The addition of  $\neg c \vee c$  solves the problem. This is done in general by the following slight variant of the forgetting algorithm.

formula `forget_ce(F, X)`

return `forget(F, X) ∪ {∨{x, ¬x | x ∈ Var(F) \ X}}`.

The formula returned by this algorithm is equivalent to the one returned by `forget(F, X)` since the added clause is a tautology. As a result, it has the same consequences: the same of  $F$  on the alphabet  $\text{Var}(F) \setminus X$  by Lemma 12. This alphabet is also the set of their common variables.

**Corollary 1** *Algorithm `forget_ce(F, X)` returns a formula that contains exactly the variables  $\text{Var}(F) \setminus X$  and is common equivalent to  $F$ .*

Since `head_implicates()` works in nondeterministic polynomial space by Theorem 10, so does `forget()`. As for the common equivalence algorithm, this requires the clauses to be generated one at time rather than all together. Each of them is then output rather than being accumulated in a set  $G$ .

While `common_equivalence()` is polynomial in space, `forget()` is only polynomial in working space; its output may be exponentially large. In such cases, both algorithms are exponential in time. An example hitting these upper bounds is the following, shown for  $i = 3$  in `exponential.py`.

$$F = \{x_i \rightarrow z_i, y_i \rightarrow z_i \mid 1 \leq i \leq n\} \cup \{z_1 \dots z_n \rightarrow w\}$$

The call `body_replace(Fw, {z1, ..., zn}, ∅)` with  $V = \{x_1, \dots, x_n\} \cup \{y_1, \dots, y_n\} \cup \{w\}$  has two ways to replace  $z_1$ : by  $x_1$  or by  $y_1$ . For each of these two nondeterministic choices, other two are generated for replacing  $z_2$  by either  $x_2$  or  $y_2$ . The same for  $z_3$  and the other variables up to  $z_n$ . Doubling for each  $i$  from 1 to  $n$  means exponential in  $n$ : the final number of nondeterministic branches is  $2^n$ . This means exponential time for `common_equivalence()` and exponential output for `forget()`.

However, the algorithms are not guilty of this. Forgetting  $\{z_1, \dots, z_n\}$  from  $F$  always produces an exponential number of clauses. The formula  $F' = \{P \rightarrow w \mid P \in \text{body\_replace}(F^w, \{z_1, \dots, z_n\}, \emptyset)\}$  is not just a way of forgetting, it is the minimal one. It is a minimal formula since all its clauses are superredundant [Lib20]. All formulae equivalent to it are the same size or larger. Being exponentially large, they cannot be generated in less than exponential time.

In this sense, `forget()` does not waste time: exponential output, exponential running time; nothing better can be done.

Yet, a small variant is backbreaking for `forget()`: removing  $x_n$  and  $y_n$  from  $V$  makes `body_replace(Fw, {z1, ..., zn}, ∅)` output nothing, but still take exponential time if the variables are replaced in increasing order of  $i$ . The same exponential number of nondeterministic branches are produced, but they all eventually fail because  $z_n$  cannot be replaced.

A simple entailment check would have avoided them. The aim of `body_replace(Fw, {z1, ..., zn}, ∅)` is to find a set  $P' \subseteq V$  such that  $F \cup P' \models \{z_1, \dots, z_n\}$ . The largest possible set  $P'$ , the one having the most consequences, is  $V$  itself. If  $F \cup V$  does not entail  $\{z_1, \dots, z_n\}$ , no proper subset of  $V$  does. Computation can be cut short when this happens. Since  $F$  is Horn, this check only takes polynomial time:

if  $F \cup V \not\models P$  then **fail**

This check is added right before each call to `body_replace`, both the first and the recursive ones.

In the example,  $F \cup V$  does not entail  $z_n$ ; therefore, it does not entail  $\{z_1, \dots, z_n\}$  either. The very first call of `body_replace` is skipped. As it should: no subset of  $V$  can ever replace  $\{z_1, \dots, z_n\}$  according to  $F$ .

Not only this check is useful in avoiding a call that would fail anyway. It otherwise guarantees its success — its usefulness. If  $F \cup V \models P$  then `body_replace()` can replace  $P$  with some variables of  $V$  entailing it.

All of this is now formally proved: the added check does not harm the algorithm, but ensures the usefulness of the following call.

The proof of the following lemma requires that the first recursive call is done with an empty third argument:  $\mathbf{body\_replace}(F, P, \emptyset)$ . This is what happens anyway, but is specified because the lemma does not work if the third argument is not empty.

**Lemma 17** *If  $R'$  is always chosen to be  $R \setminus D \setminus V$  within a call  $\mathbf{body\_replace}(F, P, \emptyset)$ , then  $F \cup V \models R \cup D \cup E$  holds after every successful subcall  $S, E = \mathbf{body\_replace}(F', R, D)$ .*

*Proof.* The claim is proved by top-down induction. The base case is the first call of recursion, which by assumption is done with formula  $F$  and an empty third argument:  $S, E = \mathbf{body\_replace}(F, P, \emptyset)$ . Lemma 11 states  $F \cup S \cup \emptyset \models P \cup E$ . Lemma 13 states  $S \subseteq V$ . These two facts prove  $F \cup V \models P \cup E$ , which implies  $F \cup V \models P \cup D \cup E$  since  $D = \emptyset$ .

The induction case assumes the claim for a recursive call and its return values and proves it for every one of its recursive subcalls.

The assumption is about an arbitrary recursive call  $\mathbf{body\_replace}(F, R, D)$ , and states that if its second return value is  $E'$  then  $F \cup V \models R \cup D \cup E'$

The claim is that after every subcall  $S, E = \mathbf{body\_replace}(F^y, P, D \cup E')$  it holds  $F \cup V \models P \cup (D \cup E') \cup E$ .

The first statement of Lemma 11 is that after  $S, E = \mathbf{body\_replace}(F^y, P, D \cup E')$  it holds  $F^y \cup S \cup (D \cup E') \models P \cup E$ . By Lemma 13, also  $S \subseteq V$  holds. By definition,  $F^y \subseteq F$ . The entailment can therefore be turned into  $F \cup V \cup (D \cup E') \models P \cup E$ . The induction assumption is  $F \cup V \models R \cup D \cup E'$  for the value of  $E'$  at the end of the call. Since  $E'$  never loses elements, its value at the end of the subcall is at most as large as the final one. Therefore,  $F \cup V \models R \cup D \cup E'$  still holds there. Together with  $F \cup V \cup (D \cup E') \models P \cup E$ , this implication proves the claim  $F \cup V \models P \cup (D \cup E') \cup E$ .  $\square$

This lemma requires the first recursive call to have an empty third argument, which is the case when forgetting and checking common equivalence. If so, adding the instruction “if  $F \cup V \not\models P$  then **fail**” before the recursive call does not affect the final result.

**Lemma 18** *If  $F \cup V \not\models P$ , the recursive call  $\mathbf{body\_replace}(F^y, P, D \cup E')$  fails if  $R'$  is always chosen equal to  $R \setminus D \setminus V$ .*

*Proof.* By contradiction,  $\mathbf{body\_replace}(F^y, P, D \cup E')$  is assumed successful. Lemma 17 implies  $F \cup V \models P \cup (D \cup E') \cup E$ , which contradicts the assumption  $F \cup V \not\models P$ .  $\square$

This lemma proves that the additional check “if  $F \cup V \not\models P$  then **fail**” before a recursive subcall does not change the result of the algorithm, since the following subcall would fail anyway.

The contrary also holds: if the check succeeds, the following call does not fail.

**Lemma 19** *If  $F \cup V \models P$  then  $\mathbf{body\_replace}(F^y, P, D \cup E')$  succeeds if  $R'$  is always chosen equal to  $R \setminus D \setminus V$ .*

*Proof.* Lemma 12 states that if  $F \cup P' \models P$  and  $R'$  is always chosen not to include a variable in  $P'$ , the recursive call  $S, E = \mathbf{body\_replace}(F, R, D)$  succeeds for some nondeterministic choices. The preconditions of the lemma hold for  $P' = V$ , since  $P \cup V \models P$  by assumption

and  $R' = R \setminus D \setminus V$ . Its consequence therefore follows: the recursive call succeeds for some nondeterministic choices.  $\square$

The check  $F \cup V \models P$  improves efficiency because it requires polynomial time (being  $F$  Horn) but may save an exponential amount of recursive calls. It may look like it makes the running time polynomial in the size of the output [Tar73], since every call succeeds and therefore produces some clauses. Yet, these are not guaranteed to be different from the previously generated ones. A counterexample is the following.

$$F = \{a_i \rightarrow x_i \mid 1 \leq i \leq n\} \cup \{x_i \rightarrow z_i, y_i \rightarrow z_i \mid 1 \leq i \leq n\} \cup \{z_1 \dots z_n \rightarrow w\}$$

When replacing  $\{z_1, \dots, z_n\}$  with  $V = \{a_i \mid 1 \leq i \leq n\} \cup \{w\}$ , every  $z_i$  is replaced by either  $x_i$  or  $y_i$ , leading to exponentially many combinations. The additional check does not avoid them, since  $F \cup V \models \{z_1, \dots, z_n\}$  holds. They all produce the same replacement  $\{a_1, \dots, a_n\}$ . This is correct because the only consequence of  $F$  on the alphabet of  $V$  is  $a_1 \dots a_n \rightarrow w$ . Forgetting takes exponential time to produce a single clause. This example with  $i = 3$  is in `branches.py`; as expected, the same clause is produced eight times.

A simple test similar to  $F \cup V \models P$  does not suffice. A recursive call searching for a replacement for  $P$  is useful only if it produces a set which has not been found so far. If these are  $A_1, \dots, A_m$ , one needs to check whether an element of each  $A_i$  can be removed from  $V$  so that the result still implies  $P$  with  $F$ . The problem is not that  $m$  may be exponential, since the aim is to bound the running time by a polynomial in  $m$ . It is the choice of the elements, since these may be  $2^m$  even if each  $A_i$  only contains two variables.

## 4.6 single-head

The source of exponentiality in `body_replace`( $F, R, D$ ) is the nondeterministic choice of the clause  $P \rightarrow y$ . Many such clauses may exist, each spawning a branch of execution. This is not the case if each variable  $y$  is the head of at most a clause  $P \rightarrow y$ . Formulae with this property are called *single-head*.

This restriction removes nondeterminism in the algorithm. The choice  $R' \subseteq R \setminus D$  is forced to be  $R' = R \setminus D \setminus V$  and  $x \in \text{Var}(F)$  can be turned into a loop over the variables of  $F$ . The remaining nondeterministic choices are  $P \rightarrow x \in F$  and  $P \rightarrow y \in F$ , which becomes deterministic since only a single such clause may exist for each given  $x$  and  $y$ .

The algorithm simplifies to: for each variable  $x \notin V$ , remove the only clause  $P \rightarrow x \in F$  and replace all remaining occurrences of  $x$  with  $P$ . This takes polynomial time because once a variable is replaced, it disappears from the formula; it is never replaced again. While the polynomiality of this case looks obvious, it still requires a formal proof.

**Lemma 20** *If  $F$  is a single-head definite Horn formula and  $V$  a set of variables, computing all possible return values of `head_implicates`( $F$ ) with the nondeterministic choices  $x \in V$  and  $R' = R \setminus D \setminus V$  only takes time polynomial in the size of  $F$ .*

*Proof.* Since  $F$  is single-head, at most one choice of a clause  $P \rightarrow x \in F$  and  $P \rightarrow y \in F$  is possible. Since  $R'$  is always  $R \setminus D \setminus V$ , this nondeterministic choice becomes deterministic. The only remaining nondeterministic choice is the variable  $x \in V$ , but only a linear number of such variables exist. Replacing this nondeterministic choice with a loop over all variables of  $V$  makes the algorithm deterministic.



To prove it polynomial suffices to show that it only performs a polynomial number of recursive calls, since each call only takes at most a linear amount of time being a loop over a set of variables.

A recursive subcall **body\_replace**( $F^y, P, D \cup E'$ ) is only performed if  $P \rightarrow y \in F$  is the only clause of  $F$  having  $y$  as its head. The claim is proved by showing that this may only happen once during the whole run of the algorithm. In particular, it may not happen again for the same variable  $y$ :

1. in the subcall **body\_replace**( $F^y, P, D \cup E'$ );
2. in the subsequent subcalls of the loop;
3. after the current call returns.

The first argument of the call **body\_replace**( $F^y, P, D \cup E'$ ) is a formula  $F^y$  non containing  $y$ . Therefore, choosing a clause with  $y$  as its head fails.

After this subcall returns,  $y$  is added to  $E'$ . The subsequent subcalls of the loop  $y$  are done with  $E'$  as part of the second argument. These subcalls receive their second argument in  $D$ ; therefore,  $y$  can never be in  $R' = R \setminus D \setminus V$ ; since  $D$  is passed to the sub-subcalls, the same happens there.

Finally,  $y$  is not chosen again after the recursive call that calls **body\_replace**( $F^y, P, D \cup E'$ ) returns. By assumption, **body\_replace**( $F^y, P, D \cup E'$ ) was called because  $P \rightarrow y \in F$  and  $y$  was a variable of the loop. This implies that  $y$  is added to  $E'$  after **body\_replace**( $F^y, P, D \cup E'$ ) returns. After the loop ends, the call returns  $E'$  containing  $y$  as its second return value. In the caller, the second return value is added to  $E'$  and then returned. This means that  $y \in E'$  holds from this point on. Even if  $y \in R'$  at some point, the test  $y \in D \cup E'$  succeeds, and the iteration is cut short before selecting  $P \rightarrow y \in F$  again.

This proves that once  $P \rightarrow y$  is selected in a call to **body\_replace**( $\phantom{}$ ), it is never selected again in the rest of the run. Since a recursive call is done only after this selection, and the number of clauses is linear in the size of the input, the total number of recursive calls is linear as well. Since each run requires polynomial time, the overall running time is polynomial.  $\square$

This proves that both forgetting and checking common equivalence take polynomial time in the single-head restriction.

**Theorem 13** *Checking whether  $F \equiv G$  holds can be verified in polynomial time if both  $F$  and  $G$  are single-head definite Horn formulae.*

## 5 Non-definite Horn formulae

What about general Horn formulae, where negative clauses like  $\neg x \vee \neg y$  may occur? Restricting to definite Horn clauses simplifies algorithms and proofs as they all have the form “variables imply variable”. A head variable is guaranteed, unlike in negative Horn clauses.

Somehow, a head exists anyway:  $\neg x \vee \neg y$  is the same as  $xy \rightarrow \perp$ . The head of a negative clause is the truth value of false. In this form, a negative clause is a definite clause, only with a special symbol as its head. The algorithm for common equivalence still works taking  $\perp$  as a variable. Or it is a variable, one always forced to be false.

Technically, a general Horn formula  $F$  can be translated into a normal form where the only negative clauses are unary, that is, they only comprise a single (negative) literal. This translation is only needed for negative clauses, the definite ones stay the same.

**Definition 4** *The definite Horn part  $def(F)$  of a Horn formula  $F$  is the set of definite clauses of  $F$  — the clauses of  $F$  that contain exactly a positive literal.*

By definition,  $def(F) \subseteq F$  holds in general and  $def(F) = F$  if  $F$  is definite Horn. The negative clauses  $F \setminus def(F)$  can be made definite in two ways: adding the same positive literals to all of them, or a different one to each. Both work. The second keeps formulae single-head, but they are both correct. More importantly, they are both compatible with the common equivalence algorithm. For this reason, the translation is defined in a general form; the new heads are taken from a set  $Z$ , how they are associated to the negative clauses is not constrained.

$$Z(F) = def(F) \cup \{C \vee z \mid C \in F \setminus def(F), z \in Z\}$$

An arbitrary set of new variables  $Z$  is used as a pool of heads for the clauses that need one. This definition allows the same variable for all of them, or one for each. Nothing is said about which  $z \in Z$  is chosen for  $C \in F \setminus def(F)$ .

Of course,  $C$  and  $C \vee z$  are not the same; the first is satisfied regardless of  $z$ , the second depends on it. Adding  $z$  is harmless if  $z$  is guaranteed to be false. For example,  $\{C \vee z, \neg z\}$  is common equivalent to  $\{C\}$ . At the scale of formulae,  $Z(F) \cup \{\neg z \mid z \in Z\}$  is common equivalent to  $F$ .

The addition of  $\{\neg z \mid z \in Z\}$  may look unnecessary when looking for common equivalence and the same variable  $z$  is the added head of all negative clauses: if  $C \in A$  and  $A \equiv B$ , then  $B$  implies  $C$ . Therefore,  $Z(A)$  contains  $C \vee z$  and  $Z(B)$  implies  $C \vee z$ . The other direction is not so easy to prove, and is indeed false. The problem is that  $Z(A)$  and  $Z(B)$  may differ on whether they entail a definite clause  $P \rightarrow x$ , but this difference is leveled by another clause  $P' \rightarrow z$  with  $P' \subseteq P$ . When  $z$  is not constrained to be false these two clauses are independent; when it is, the second supersedes the first, making it redundant and canceling the difference.

Checking formulae for redundancy is not the solution, as the differing clause may be entailed rather than present in a formula. The following is an example.

$$\begin{aligned} A &= \{\neg a \vee \neg b, a \rightarrow a', b \rightarrow b', a'b' \rightarrow c, c \rightarrow d\} \\ B &= \{\neg a \vee \neg b, c \rightarrow d\} \end{aligned}$$

When switching from  $A$  and  $B$  to  $Z(A)$  and  $Z(B)$ , the first formula  $Z(A)$  entails  $ab \rightarrow c$  while the second  $Z(B)$  does not. This is a clause on their common variables  $Var(A) \cap Var(B) = \{a, b, c, d\}$ . It proves that  $Z(A)$  and  $Z(B)$  are not common equivalent. Yet,  $A$  and  $B$  are common equivalent. The differing clause  $ab \rightarrow c$  is entailed by  $\neg a \vee \neg b$ , which is in both formulae. This is the only possible case where inequivalence in the definite part of the formulae does not entail equivalence in the whole: a differing definite clause is superseded by a negative clause that is entailed by both formulae.

The solution is to make this negative clause stand out from the definite. It does as soon as its new head is forced to be false: since  $Z(B)$  contains  $ab \rightarrow z$  for some  $z \in Z$ , adding  $\neg z$  makes this clause equivalent to  $\neg a \vee \neg b$ , which entails  $ab \rightarrow z$ .

The general solution is to set all new heads  $z \in Z$  to false.

The replacement of the non-shared variables is done on the definite Horn version  $Z(A)$  and  $Z(B)$  since **head\_implicates**() only works on definite Horn clauses; the negation of the new heads is virtually added to the resulting formula. Some propositional manipulations show that this addition is only necessary to the other, original formula.

boolean **common\_equivalence\_horn**( $A, B$ )

1. for each  $P \rightarrow x$  generated by **head\_implicates**( $Z(A)$ ) with  $x \in V$  and  $R' = R \setminus D \setminus V$ , where  $V = \text{Var}(A) \cap \text{Var}(B)$ 
  - (a) if  $B \cup \{\neg z \mid z \in Z\} \not\models P \rightarrow x$  return false
2. for each  $P \rightarrow x$  generated by **head\_implicates**( $Z(B)$ ) with  $x \in V$  and  $R' = R \setminus D \setminus V$ , where  $V = \text{Var}(A) \cap \text{Var}(B)$ 
  - (a) if  $A \cup \{\neg z \mid z \in Z\} \not\models P \rightarrow x$  return false
3. return true

The following lemma proves that no matter how  $Z()$  chooses the heads to attach to the negative clauses, the result of this algorithm is correct.

**Lemma 21** *The condition  $A \equiv B$  is equivalent to  $B \cup \{\neg z \mid z \in Z\} \models \mathbf{head\_implicates}(Z(A))$  and  $A \cup \{\neg z \mid z \in Z\} \models \mathbf{head\_implicates}(Z(B))$  if  $V = Z \cup (\text{Var}(A) \cap \text{Var}(B))$ .*

*Proof.* The proof comprises two parts: the first condition implies the other two, and they imply it.

The first part of the proof begins assuming  $A \equiv B$  and  $C \in \mathbf{head\_implicates}(Z(A))$  and ends concluding  $B \cup \{\neg z \mid z \in Z\} \models C$ . By symmetry, the same holds swapping  $A$  and  $B$ .

By Theorem 9, all clauses of **head\_implicates**( $Z(A)$ ) are entailed by  $Z(A)$ . Therefore,  $Z(A) \models C$ . By monotonicity of entailment,  $Z(A) \cup \{\neg z \mid z \in Z\} \models C$ . Since  $Z(A) \cup \{\neg z \mid z \in Z\}$  is equivalent to  $A \cup \{\neg z \mid z \in Z\}$ , it follows  $A \cup \{\neg z \mid z \in Z\} \models C$ . This implies  $A \models \{\neg z \mid z \in Z\} \rightarrow C$ , which is the same as  $A \models (\vee Z) \vee C$ .

Since  $(\vee Z) \vee C$  is a consequence of  $A$ , resolution from  $A$  produces a subset  $C' \subseteq (\vee Z) \vee C$ . By soundness of resolution,  $A \models C'$ . Since  $A$  does not contain any variable in  $Z$  and resolution does not introduce literals, this clause  $C'$  does not contain any variable in  $Z$  either. Therefore,  $C' \subseteq C$ .

Since  $C$  is generated by **head\_implicates**( $Z(A)$ ) with  $V = Z \cup (\text{Var}(A) \cap \text{Var}(B))$ , Theorem 9 tells  $\text{Var}(C) \subseteq Z \cup (\text{Var}(A) \cap \text{Var}(B))$ . Since  $C'$  is a subset of  $C$  and does not contain any variable in  $Z$ , this containment can be refined as  $\text{Var}(C') \subseteq \text{Var}(A) \cap \text{Var}(B)$ .

Common equivalence between  $A$  and  $B$  applies:  $A \models C'$  implies  $B \models C'$ . As a result,  $B \models C$  since  $C' \subseteq C$ . By monotonicity of entailment,  $B \cup \{\neg z \mid z \in Z\} \models C$ .

This proves that  $C \in \mathbf{head\_implicates}(Z(A))$  implies  $B \cup \{\neg z \mid z \in Z\} \models C$  if  $A \equiv B$ . By symmetry, the same holds with  $A$  in place of  $B$  and vice versa, concluding the first part of the proof.

The second part of the proof begins assuming  $A \models C$  and  $B \cup \{\neg z \mid z \in Z\} \models \mathbf{head\_implicates}(Z(A))$  with  $Var(C) \subseteq Var(A) \cap Var(B)$  and ends concluding  $B \models C$ . Once this is proved, the same holds when swapping  $A$  and  $B$ , proving  $A \equiv B$ .

By monotonicity of entailment,  $A \models C$  implies  $A \cup \{\neg z \mid z \in Z\} \models C$ . Since  $A \cup \{\neg z \mid z \in Z\}$  is equivalent to  $Z(A) \cup \{\neg z \mid z \in Z\}$ , the entailment  $Z(A) \cup \{\neg z \mid z \in Z\} \models C$  follows. This is the same as  $Z(A) \models \{\neg z \mid z \in Z\} \rightarrow C$ , which can be rewritten as  $Z(A) \models (\forall Z) \vee C$ .

Since  $Var(C) \subseteq Var(A) \cap Var(B)$ , it follows  $Var((\forall Z) \vee C) \subseteq Z \cup (Var(A) \cap Var(B)) = V$ . Theorem 9 states that  $\mathbf{head\_implicates}(Z(A))$  implies all consequences of  $Z(A)$  on the alphabet  $V$ . Since  $Z(A) \models (\forall Z) \vee C$  and  $Var((\forall Z) \vee C) \subseteq V$ , this applies to  $(\forall Z) \vee C$ : it is entailed by  $\mathbf{head\_implicates}(Z(A))$ .

By transitivity,  $\mathbf{head\_implicates}(Z(A)) \models (\forall Z) \vee C$  and the assumption  $B \cup \{\neg z \mid z \in Z\} \models \mathbf{head\_implicates}(Z(A))$  imply  $B \cup \{\neg z \mid z \in Z\} \models (\forall Z) \vee C$ . This entailment can be rewritten as  $B \models \{\neg z \mid z \in Z\} \rightarrow ((\forall Z) \vee C)$ , which is the same as  $B \models (\forall Z) \vee ((\forall Z) \vee C)$ , or  $B \models (\forall Z) \vee C$ .

Since  $B \models (\forall Z) \vee C$ , a subset of  $(\forall Z) \vee C$  is generated by resolving clauses of  $B$ . Since  $B$  does not contain any variable in  $Z$  and resolution does not introduce literals, this subset  $C'$  of  $(\forall Z) \vee C$  does not contain any variable in  $Z$ : it is a subset of  $C$ . By soundness of resolution,  $B \models C'$ . Since  $C'$  is a subset of  $C$ , this implies  $B \models C$ , the claim.

By symmetry, the same holds in the other direction, proving that every consequence of  $B$  on the alphabet  $V$  is also a consequence of  $A$ .  $\square$

The first step of  $\mathbf{common\_equivalence\_horn}(A, B)$  checks whether every clause generated by  $\mathbf{head\_implicates}(Z(A))$  is entailed by  $B \cup \{\neg z \mid z \in Z\}$ . This is the same as  $B \cup \{\neg z \mid z \in Z\} \models \mathbf{head\_implicates}(Z(A))$ . By symmetry, the second step checks  $A \cup \{\neg z \mid z \in Z\} \models \mathbf{head\_implicates}(Z(B))$ . The lemma proves these two conditions equivalent to  $A \equiv B$ .

Negative clauses are not a problem. When present, they are turned into definite clauses before running the replacement algorithm and the newly introduced heads negated afterwards. If the formula is single-head it remains so as long as  $Z()$  assigns a different head to each clause.

The same mechanism works for forgetting: negative clauses are turned into definite clauses by adding new variables as heads, the definite Horn algorithm for forgetting is run and the new variables are replaced with false. The shorthand  $[\perp/Z]$  stands for the set of substitutions  $[\perp/z]$  for all  $z \in Z$ .

formula  $\mathbf{forget\_horn}(F, X)$

1.  $F' = \mathbf{forget\_ce}(Z(F), X)$
2. return  $F'[\perp/Z]$

This algorithm is proved correct by the following lemma regardless of how  $Z(F)$  assigns the new heads to the negative clauses.

**Lemma 22** *For every formula  $F$  and set of variables  $X$ , if  $F' = \mathbf{forget\_ce}(Z(F), X)$  then  $F'[\perp/Z]$  contains exactly the variables  $\text{Var}(F) \setminus X$  and is common equivalent to  $F$ .*

*Proof.* The alphabet of  $Z(F)$  is  $Z \cup \text{Var}(F)$  by construction. Since  $Z(F)$  is a definite Horn formula and  $\mathbf{forget\_ce}()$  is correct on these formulae by Theorem 1, the variables of  $F'$  are  $\text{Var}(Z(F)) \setminus X = Z \cup \text{Var}(F) \setminus X$ . Since  $Z$  is a set of new variables, it does not intersect  $X$ . As a result, the variables of  $F'$  are  $Z \cup \text{Var}(F) \setminus X = Z \cup (\text{Var}(F) \setminus X)$ . The substitution  $F'[\perp/Z]$  removes exactly the variables  $Z$ , leaving  $\text{Var}(F) \setminus X$ . This proves the first part of the claim: the return value of the algorithm is a formula on the alphabet  $\text{Var}(F) \setminus X$ .

The second part of the claim is  $F'[\perp/Z] \equiv F$ . The correctness of  $\mathbf{forget\_ce}()$  on definite Horn formulae like  $Z(F)$  includes  $F' \equiv Z(F)$ . Lemma 5 tells that  $F' \equiv Z(F)$  still holds if adding the same formula on the shared variables to both sides of the equivalence. Since all variables  $z \in Z$  are in both formulae, it implies  $F' \cup \{\neg z \mid z \in Z\} \equiv Z(F) \cup \{\neg z \mid z \in Z\}$ .

Lemma 4 proves that adding literals is common equivalent to replacing the same literals with true. This applies to both  $Z(F)$  and  $F'$ , proving  $Z(F)[\perp/Z] \equiv Z(F) \cup \{\neg z \mid z \in Z\}$  and  $F'[\perp/Z] \equiv F' \cup \{\neg z \mid z \in Z\}$ .

The following chain of common equivalences are proved:

$$\begin{aligned} Z(F)[\perp/Z] &\equiv Z(F) \cup \{\neg z \mid z \in Z\} \\ Z(F) \cup \{\neg z \mid z \in Z\} &\equiv F' \cup \{\neg z \mid z \in Z\} \\ F' \cup \{\neg z \mid z \in Z\} &\equiv F'[\perp/Z] \end{aligned}$$

The variables in these formulae are  $\text{Var}(F)$ ,  $Z \cup \text{Var}(F)$ ,  $Z \cup (\text{Var}(F) \setminus X)$  and  $\text{Var}(F) \setminus X$ .

Lemma 2 tells that common equivalence is transitive if the variables shared by the formulae on the sides are all in the formula in the middle:  $A \equiv B$  and  $B \equiv C$  implies  $A \equiv C$  if  $\text{Var}(A) \cap \text{Var}(C) \subseteq \text{Var}(B)$ . This is the case for the first three alphabets:

$$\text{Var}(F) \cap (Z \cup (\text{Var}(F) \setminus X)) = \text{Var}(F) \setminus X \subseteq Z \cup \text{Var}(F)$$

Transitivity implies  $Z(F)[\perp/Z] \equiv F' \cup \{\neg z \mid z \in Z\}$ . The alphabets of these two formulae are  $\text{Var}(F)$  and  $Z \cup (\text{Var}(F) \setminus X)$ . The same containment among alphabets applies with the last formula of the chain  $F'[\perp/Z]$ :

$$\text{Var}(F) \cap (\text{Var}(F) \setminus X) = \text{Var}(F) \setminus X \subseteq Z \cup (\text{Var}(F) \setminus X)$$

By transitivity,  $Z(F)[\perp/Z] \equiv F'[\perp/Z]$ . Since the first formula is identical to  $F$ , its common equivalence with  $F'[\perp/Z]$  is proved.  $\square$

This lemma ensures the correctness of  $\mathbf{forget\_horn}()$  regardless of how  $Z(F)$  adds the heads to the negative clauses. It may add the same head to all clauses. Or a different head to each. It works in both cases. The first involves a slightly simpler formula, but the second keeps the formula single-head if it was. This proves that forgetting from single-head Horn formulae is still polynomial in time even when they contain negative clauses.

## 6 Single-head minimization

The algorithm for forgetting outputs a polynomially large formula since it is polynomial in time. Is this enough? Polynomial may be linear, or quadratic, or cubic. Linear is best. Linear may be double the size, ten times the size, thirty times the size. Double is best. In a best case of a best case, forgetting doubles the size of the formula. If the goal of forgetting is to reduce size, doubling size misses it. Even the same size is too large. The aim is to reduce size, not to increase it; not even to keep it the same.

Not all is lost, however. The algorithm only generates a formula expressing forgetting, a formula  $B$  over the variables  $Var(A)\setminus X$  that is common equivalent to  $A$ . Other such formulae may exist. Every formula on the same variables that is equivalent to  $B$  fits the definition. The question is whether such a formula is smaller than  $B$ . Still better, whether it is small enough.

The same problem without forgetting has been studied for decades [Vei52, McC56, RSV87, TNW96]. For example, checking whether a Horn formula is equivalent to another of a certain size is NP-complete [HK93]. When the formula is single-head, forgetting and minimization can be done separately: first forget, in polynomial time; then minimize. The problem of forgetting within a certain size reduces to the classic Boolean minimization problem, when the formula is single-head.

Yet, the single-head case has some specificity:

- the minimally sized formula equivalent to a given single-head one may not be single-head;
- therefore, minimizing is actually two distinct problems: find a minimal formula or a minimal single-head formula;
- acyclic formulae are easy to minimize, clause by clause;
- this cannot be done in the cyclic case;
- a sufficient condition to minimality exists; it provides directions for minimizing when a formula is not minimal.

The first point is that minimizing a single-head formula depends on whether the minimal formula is required to be single-head or not. This is proved by an example, a single-head formula that is equivalent to a non-single-head one of size  $k$  but to no single-head one of the same or lower size.

It hinges on how equivalences are achieved in single-head formulae: by loops of implications. If  $F$  implies  $A \equiv B$  and  $B \equiv C$  for three disjoint sets of variables  $A$ ,  $B$  and  $C$ , single-headness requires each set to imply another in a loop. An example is  $A \rightarrow B$ ,  $B \rightarrow C$  and  $C \rightarrow A$ . This is not the case in general, where the same equivalences can be realized by entailments centered on one set, for example  $A$ , like  $A \rightarrow B$ ,  $B \rightarrow A$ ,  $A \rightarrow C$  and  $C \rightarrow A$ . Such an alternative may be smaller. An example is the following.

$$F = \{a \rightarrow b_1, a \rightarrow b_2, a \rightarrow b_3, b_1b_2b_3 \rightarrow c_1, b_1b_2b_3 \rightarrow c_2, b_1b_2b_3 \rightarrow c_3, c_1c_2c_3 \rightarrow a\}$$

This formula is a specific case of the example above where  $A = \{a\}$ ,  $B = \{b_1, b_2, b_3\}$  and  $C = \{c_1, c_2, c_3\}$ . It is a single-head formula that entails the equivalence of  $A$ ,  $B$  and  $C$  by a loop of entailments:

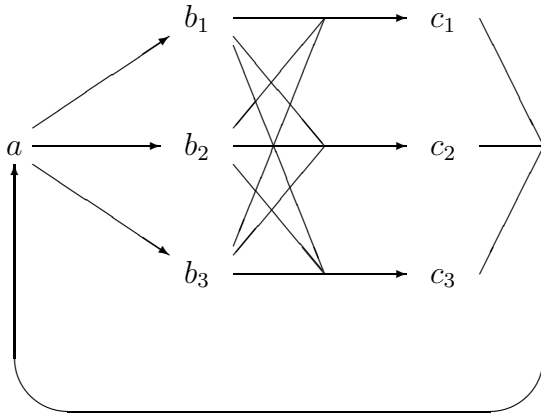

This formula has 22 literal occurrences. The three clauses  $a \rightarrow b_i$  have size two each (total:  $3 \times 2 = 6$ ); the three clauses  $b_1 b_2 b_3 \rightarrow c$  have size four each (total:  $3 \times 4 = 12$ ); the single clause  $c_1 c_2 c_3 \rightarrow a$  has size four. The total is  $6 + 12 + 4 = 22$ .

Every other single-head equivalent formula has the same size: the equivalences being realized as a loop, every loop of sets of size 1, 3 and 3 is a closed sequence with a 1 – 3 edge, a 3 – 3 edge and a 3 – 1 edge.

An alternative that is not single-head is  $A \rightarrow B$ ,  $B \rightarrow A$ ,  $A \rightarrow C$  and  $C \rightarrow A$ :

$$F' = \{a \rightarrow b_1, a \rightarrow b_2, a \rightarrow b_3, b_1 b_2 b_3 \rightarrow a, a \rightarrow c_1, a \rightarrow c_2, a \rightarrow c_3, c_1 c_2 c_3 \rightarrow a\}$$

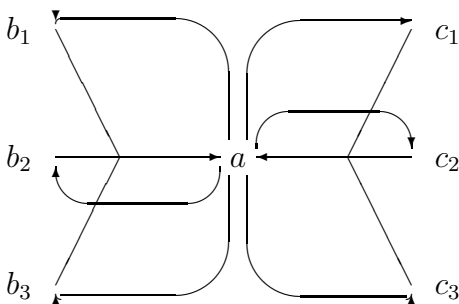

This formula is smaller because it centers around the small set  $A = \{a\}$ , saving from the costly entailment from a set of size three to another of size three. The size of  $F'$  is the sum of the size the clause  $b_1 b_2 b_3 \rightarrow a$ , four, of the three clauses  $a \rightarrow b_i$ , two each, and the same for  $c_1 c_2 c_3$ . The total is  $2 \times (4 + 3 \times 2) = 2 \times 10 = 20$ .

This formula is not single-head as it contains two clauses with head  $a$ . The answer to the question “is the single-head formula  $F$  equivalent to a formula of size 20 or less” is “yes”. The answer to the similar question “... equivalent to a *single-head* formula of size 20 or less” is “no”.

That the second formula is the minimal form of the first is proved by running `minimize.py` on the first. Running it on the second proves that the second is not only minimal, but that no other formula of the same size is equivalent to it. It is the only minimal formula equivalent to itself. This proves that the only minimal-size formula equivalent to the first formula is single-head.

```

minimize.py -f -minimal 'a->b' 'a->c' 'a->d' 'bcd->e' 'bcd->f' 'bcd->g' 'efg->a'
minimize.py -f -minimal 'a->b' 'a->c' 'a->d' 'bcd->a' 'a->e' 'a->f' 'a->g' 'efg->a'

```

The variables are renamed from  $b_1, b_2, b_3, \dots$  to  $b, c, d, \dots$  because the program only allows for single-letter variables. The `minimize.py` program is described in a previous article [Lib20]. It can currently be retrieved at <https://github.com/paololibertore/minimize.py>.

Regardless of whether the minimal formula has to be single-head or not, finding it is polynomial if the clauses form no loop, where each clause  $P \rightarrow x$  links every variable in  $P$  to  $x$  [HK95]. Acyclicity is a subcase of inequivalence: no two minimally-sized different sets of variables are equivalent.

**Condition 1** *A formula  $F$  is inequivalent if  $F \models A \equiv B$  for two sets of variables  $A$  and  $B$  implies  $F \models A \equiv A \cap B$ .*

The minimal form of an inequivalent single-head formula  $F$  can be determined from the order such that  $B \leq_F A$  if  $F$  entails  $A \rightarrow B$ . The strict part of this order  $B <_F A$  is as usual:  $B \leq_F A$  but not  $A \leq_F B$ . The set  $MIN(F)$  is built from this order.

$$MIN(F) = \{A \rightarrow x \mid F \models A \rightarrow x \text{ and } \nexists B . x \notin B, F \models B \rightarrow x \text{ and } B <_F A \text{ or } B \subset A\}$$

Every formula equivalent to  $F$  implies  $MIN(F)$  since the clauses in  $MIN(F)$  are all entailed by  $F$ . In the case of inequivalence, this fact can be pushed further: every formula equivalent to  $F$  contains either a clause of  $MIN(F)$  or a superclause of it.

**Lemma 23** *If  $F$  is inequivalent, it contains a superset of every clause in  $MIN(F)$ .*

*Proof.* Let  $A \rightarrow x$  be an arbitrary clause of  $MIN(F)$ . The definition of this set includes  $F \models A \rightarrow x$ . By Lemma 9,  $F$  contains a clause  $B \rightarrow x$  such that  $F \models A \rightarrow B$ . This entailment defines  $B \leq_F A$ . The converse  $A \leq_F B$  may hold or not: either  $B <_F A$  or  $B \equiv_F A$ .

In the first case,  $B <_F A$  contradicts the assumption  $A \rightarrow x \in MIN(F)$  since  $F$  entails  $B \rightarrow x$  with  $B <_F A$ .

In the second case,  $A \equiv_F B$  and the assumption of inequivalence imply  $A \equiv_F A \cap B$ . Since  $F \models A \rightarrow x$ , this implies  $F \models A \cap B \rightarrow x$ . The intersection of two sets is always contained in each, but this containment may be strict or not: either  $A \cap B \subset A$  or  $A \cap B = A$ . The first case  $A \cap B \subset A$  contradicts the assumption  $A \rightarrow x \in MIN(F)$  because  $F$  entails  $A \cap B \rightarrow x$  with  $A \cap B \subset A$ . The other case is  $A \cap B = A$ . It implies  $A \subseteq B$ : the formula  $F$  contains a clause  $B \rightarrow x$  with  $A \subseteq B$ . This holds for every  $A \rightarrow x \in MIN(F)$ .  $\square$

Another important property of  $MIN(F)$  is that it is equivalent to  $F$  if  $F$  is single-head.

**Lemma 24** *If  $F$  is single-head, then  $F \equiv MIN(F)$ .*

*Proof.* Since  $MIN(F)$  only contains clauses entailed by  $F$ , it is entailed by  $F$ . The claim requires proving the converse: if  $F$  is single-head, it is entailed by  $MIN(F)$ .



This is the same as showing  $MIN(F) \models A \rightarrow x$  for every  $A \rightarrow x \in F$ . It is proved by contradiction, assuming  $MIN(F) \not\models A \rightarrow x$ .

By definition of  $MIN(F)$ , since  $F \models A \rightarrow x$ , there exists a clause  $B \rightarrow x$  such that  $F \models B \rightarrow x$  and either  $B <_F A$  or  $B \subset A$ .

The first case is  $B <_F A$ , which is defined as  $F \models A \rightarrow B$  and  $F \not\models B \rightarrow A$ . By Lemma 9,  $F \models B \rightarrow x$  implies the existence of a clause  $C \rightarrow x \in F$  such that  $F \models B \rightarrow C$ . If  $C$  were the same as  $A$ , this would contradict  $F \not\models B \rightarrow A$ . As a result,  $A \neq C$ . As a result,  $F$  contains two different clauses  $A \rightarrow x$  and  $C \rightarrow x$  with the same head, contradicting the assumption that it is single-head. This proves that  $B <_F A$  impossible.

Since either  $B <_F A$  or  $B \subset A$  hold and the first is ruled out, the second must be true:  $B \subset A$ . It implies  $B \rightarrow x \models A \rightarrow x$ . If  $B \rightarrow x \in MIN(F)$ , the claim is proved. Otherwise, since  $F \models B \rightarrow x$  there exists another clause  $B_1 \rightarrow x$  with  $F \models B_1 \rightarrow x$  and either  $B_1 <_F B$  or  $B_1 \subset B$ . The same argument applies, proving that  $B_1 \subset B$ .

This process iterates: either  $B_i \rightarrow x \in MIN(F)$  or there exists  $B_{i+1} \subset B_i$  with  $F \models B_{i+1} \rightarrow x$ . Since the sets  $B_i$ 's decrease in size at each step, at some point the second possibility is ruled out and  $B_m \rightarrow x \in MIN(F)$ . Since  $B_m \subset B_{m-1} \subset \dots \subset B_1 \subset B$  holds, it follows  $B_m \subset B$ . Therefore,  $B_m \rightarrow x \models B \rightarrow x$  holds. Since  $MIN(F)$  contains the first clause, it implies the second.  $\square$

If  $F$  is single-head then  $MIN(F)$  is single-head as well. This makes the problems of the minimal formula and the minimal single-head formula coincide. Since  $MIN(F)$  can be determined in polynomial time if  $F$  is inequivalent, both problems are polynomial in time in the single-head inequivalent case.

Does tractability extend from inequivalent single-head formulae to the general case? A counterexample suggests it does not.

Building  $MIN(F)$  is easy because it can be done clause by clause: each  $P \rightarrow x \in F$  is minimized by repeatedly replacing it with  $P' \rightarrow x$  if such a clause is entailed by  $F$  and either  $P' <_F P$  or  $P' \subset P$ . This is not in general possible on formulae containing loops.

As an example, four equivalent sets of variables of size 1, 1, 3 and 3 are realized by a loop of clauses that makes a one-variable set entail a three-variable one, that entail the other one-variable set and so on. A concrete formula for this case is the following.

$$F = \{a \rightarrow b, b \rightarrow c_1, b \rightarrow c_2, b \rightarrow c_3, c_1c_2c_3 \rightarrow d_1, c_1c_2c_3 \rightarrow d_2, c_1c_2c_3 \rightarrow d_3, d_1d_2d_3 \rightarrow a\} \quad (1)$$

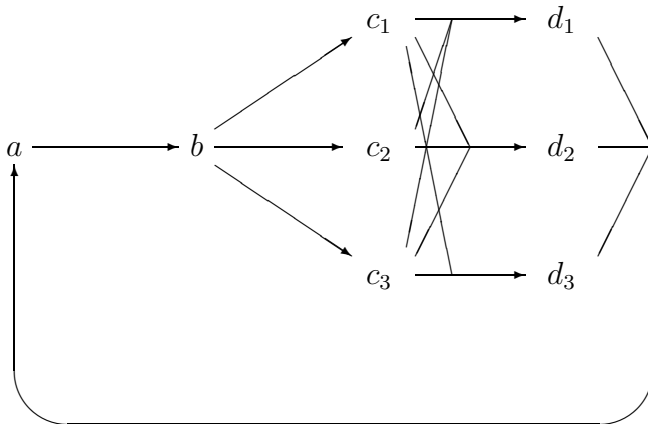

This formula entails the equivalence of the sets  $\{a\}$ ,  $\{b\}$ ,  $\{c_1, c_2, c_3\}$  and  $\{d_1, d_2, d_3\}$  by a loop:  $\{a\}$  entails  $\{b\}$  which entails  $\{c_1, c_2, c_3\}$  which entails  $\{d_1, d_2, d_3\}$  which entails  $\{a\}$ . Its size is  $2 + 2 \times 3 + 4 \times 3 + 4 = 2 + 6 + 12 + 4 = 24$  variable occurrences.

A smaller way to entail the same equivalences is by a loop where  $\{a\}$  entails  $\{c_1, c_2, c_3\}$ , which entails  $\{b\}$  which entails  $\{d_1, d_2, d_3\}$  which entails  $\{a\}$ . The formula is the following.

$$F' = \{a \rightarrow c_1, a \rightarrow c_2, a \rightarrow c_3, c_1c_2c_3 \rightarrow b, b \rightarrow d_1, b \rightarrow d_2, b \rightarrow d_3, d_1d_2d_3 \rightarrow a\} \quad (2)$$

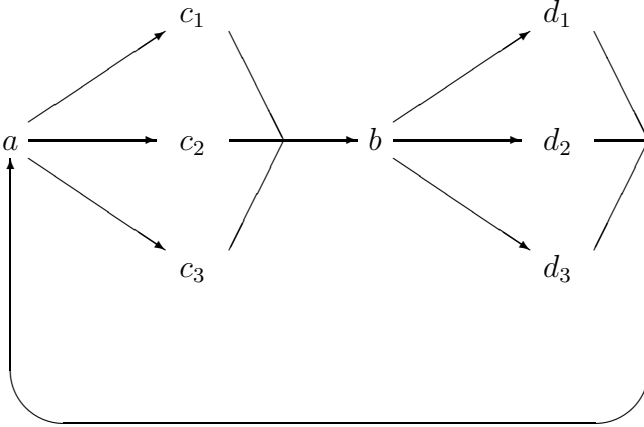

This formula  $F'$  is equivalent to  $F$  because it entails the same equivalences between the four sets and nothing else. It contains the same four sets of variables, each entailing another to form a single loop encompassing all of them.

Yet, it is smaller:  $2 \times 3 + 4 + 2 \times 3 + 4 = 6 + 4 + 6 + 4 = 20$  instead of 24.

This shows that minimizing cannot be done clause by clause as in the inequivalent case. Every clause of  $F$  is minimal by itself. For example,  $a \rightarrow b$  is minimal; the only sets that are strictly less than  $\{a\}$  are  $\emptyset$ , the proper subsets of  $\{c_1, c_2, c_3\}$  and  $\{d_1, d_2, d_3\}$  and their union, but none of them entail  $b$ ; the only set that is strictly contained in  $\{a\}$  is  $\emptyset$ , which again does not entail  $b$ . While  $a \rightarrow b$  is minimal by itself, it is not in the minimal single-head formula equivalent to  $F$ . This formula cannot be minimized by minimizing each clause it contains; it needs a global restructuring.

The question is: how to minimize a single-head formula that is not inequivalent? The target is a formula that is single-head but minimal: no other single-head formula is smaller. A simple sufficient condition is based on the following property.

**Lemma 25** *If  $F$  is equivalent to a single-head formula  $F'$  that contains the clause  $P \rightarrow x$ , then  $F$  contains  $P' \rightarrow x$  with  $F \models P \equiv P'$ .*

*Proof.* Since  $F'$  contains  $P \rightarrow x$  it also entails it:  $F' \models P \rightarrow x$ . By the equivalence of the considered formulae,  $F$  entails  $P \rightarrow x$ . Lemma 9 implies the existence of a set of variables  $P'$  such that  $x \notin P'$ ,  $F \models P \rightarrow P'$  and  $P' \rightarrow x \in F$ . The latter condition implies  $F \models P' \rightarrow x$ . By equivalence,  $F' \models P' \rightarrow x$ . Again, Lemma 9 implies that  $F' \models P' \rightarrow P''$  for some  $P'' \rightarrow x \in F'$ . Since  $F'$  is single-head and contains  $P \rightarrow x$ , this is only possible if  $P'' = P$ . As a result,  $F' \models P' \rightarrow P''$  is the same as  $F' \models P' \rightarrow P$ . Since  $F \models P \rightarrow P'$  and the two formulae are equivalent,  $F \models P \equiv P'$  is proved.  $\square$

The sufficient condition not only tells when a formula is not minimal, but also shows how clauses can be replaced.

**Lemma 26** *If a single-head definite Horn formula  $F$  is not minimal then it contains a clause  $P \rightarrow x$  such that  $F \models (BCN(P, F) \setminus \{y\}) \rightarrow y$  where  $y \in P$  and  $BCN(P, F) = \{x \mid F \cup P \models x\}$ .*

*Proof.* Let  $F$  be a non-minimal single-head definite Horn formula: some other single-head definite Horn formula is shorter but equivalent. Let  $F'$  be the shortest single-head definite Horn formula equivalent to  $F$ . Since it is shorter than  $F$ , it does not contain a clause of  $F$ , as otherwise  $F \subseteq F'$ . Let  $P \rightarrow x \in F$  be that clause.

By Lemma 25,  $F'$  contains a clause  $P' \rightarrow x$  with  $F \models P \equiv P'$ . If  $P = P'$  then  $P \rightarrow x \in F'$ , contrary to assumption. If  $P \subset P'$  then  $F'$  is not minimal:  $F \models P \rightarrow x$  implies  $F' \models P \rightarrow x$ , which implies  $F' \equiv F' \cup \{P \rightarrow x\}$ ; in this new formula  $P' \rightarrow x$  is redundant because it is entailed by  $P \rightarrow x$ ; therefore,  $F' \cup \{P \rightarrow x\} \equiv F' \cup \{P \rightarrow x\} \setminus \{P' \rightarrow x\}$ . The latter formula is still single-head because it replaces a clause with another with the same head. It is also equivalent to  $F'$  but smaller than it, contrary to the assumption of minimality of  $F'$ . This proves  $P \not\subseteq P'$  by contradiction.

This condition  $P \not\subseteq P'$  can be rewritten as:  $P$  contains an element  $y$  that is not in  $P'$ . A consequence of  $F \models P \equiv P'$  is  $F \cup P \models P'$ , which implies  $P' \subseteq BCN(P, F)$ . Since  $y \notin P'$ , this containment strengthens to  $P' \subseteq BCN(P, F) \setminus \{y\}$ . Since  $F \models P \equiv P'$  and  $P \rightarrow x \in F$ , it follows  $F \models P' \rightarrow x$ . By monotonicity,  $F \models P' \rightarrow x$  implies  $F \models (BCN(P, F) \setminus \{y\}) \rightarrow y$ .  $\square$

If  $F$  is not minimal, it contains a clause  $P \rightarrow x$  such that  $F \models (BCN(P, F) \setminus \{y\}) \rightarrow y$  with  $y \in P$ . This condition can be checked easily: for each clause  $P \rightarrow x$ , determine the set of all its consequences  $BCN(P, F)$  by iteratively adding  $x$  to  $P$  whenever a clause  $P' \rightarrow x$  is in  $F$  with  $P' \subseteq P$ . When no such clause remains, check  $F \models (BCN(P, F) \setminus \{y\}) \rightarrow y$  for each  $y \in P$ . Such an entailment suggests that  $P \rightarrow x$  could be replaced by a clause  $P' \rightarrow x$  where  $P'$  does not contain  $y$ . In other words, it not only tells that the formula is not minimal, but it also gives some directions for minimizing it.

## 7 Reducing size by extending the alphabet

Some formulae cannot be reduced size by adding new variables, others can. For example,  $F = \{a \vee b\}$  is already minimal: no variable addition shortens it. On the other hand,  $F = \{abcd \rightarrow e, abcd \rightarrow f, abcd \rightarrow g\}$  is common equivalent to the shorter formula  $F' = \{abcd \rightarrow n, n \rightarrow e, n \rightarrow f, n \rightarrow g\}$ , whose size  $5 + 2 + 2 + 2 = 11$  is less than  $5 + 5 + 5 = 15$ .

In this case, size reduction is obtained by summarizing a large body by a single variable. The new clause  $body \rightarrow newvariable$  allows replacing each occurrence of the body with the single new variable.

Even if a formula contains no whole-body repetition it may still be amenable to shortening because it contains many repeated body subsets. An example is  $F = \{abcd \rightarrow e, abch \rightarrow f, abci \rightarrow g\}$ , which contains no duplicated body, but three of its bodies contain  $abc$ . A new clause  $abc \rightarrow n$  allows shortening it to  $F' = \{abc \rightarrow n, nd \rightarrow e, nh \rightarrow f, ni \rightarrow g\}$ , reducing size from  $5 + 5 + 5 = 15$  to  $4 + 3 + 3 + 3 = 13$ .

This mechanism is made an algorithm for formula compression by new variable addition. A large set of variables contained into many bodies is summarized by a new variable thanks to an added clause; all previous occurrences of the set are replaced by the new variable. This summarization is repeated as long as it shortens the formula. The complete algorithm is not optimal for two reasons: it is greedy (only works a single subset at time) and does not always find the best set of variable to compress (because finding that is NP-hard).

The core of the algorithm is the set/variable replacement: given a formula  $F$  and a set of variables  $P$ , replace every occurrence of  $P$  by a new variable  $x$ . This is what the  $\text{newvar}(P, F)$  subroutine does.

### Algorithm 1

*formula newvar(set  $P$ , formula  $F$ )*

1. create a new variable  $x$
2.  $G_1 = \{A \setminus P \cup \{x\} \rightarrow y \mid A \rightarrow y \in F \text{ and } P \subseteq A\}$
3.  $G_2 = \{A \rightarrow y \mid A \rightarrow y \in F \text{ and } P \not\subseteq A\}$
4. return  $G_1 \cup G_2 \cup \{P \rightarrow x\}$

No matter which set  $P$  is passed to  $\text{newvar}(P, F)$ , the result is common-equivalent to  $F$ . This is the basement for building the correctness proof of the whole algorithm.

**Lemma 27** *For every formula  $F$  and set of variables  $A$ , it holds  $F \equiv \equiv \text{newvar}(A, F)$ .*

*Proof.* By Theorem 2, common equivalence holds if and only if  $S \cup F$  is equisatisfiable with  $S \cup \text{newvar}(P, F)$  for every set  $S$  of literals containing all variables the two formulae share. In this case all variables of  $F$  are shared, and the only other variable is  $x$ , the new variable.

Let  $M$  be the only model of  $S$  over variables  $\text{Var}(F)$ . Only one such model exists because  $S$  contains either  $y$  or  $\neg y$  for every variable  $y \in \text{Var}(F)$ . Let  $M'$  be the model over  $\text{Var}(\text{newvar}(P, F)) = \text{Var}(F) \cup \{x\}$  that evaluates every  $y \in \text{Var}(F)$  as  $M$  and  $x$  to true if and only if  $M$  satisfies  $P$ .

The claim is proved by showing that  $M \models F$  is equivalent to  $M' \models \text{newvar}(P, F)$  for all models  $M$  over  $\text{Var}(F)$ . This is proved by considering every kind of clause of  $\text{newvar}(P, F)$  in turn.

If  $M \models P$  then  $M' \models P$  and  $M' \models x$  by construction. Therefore,  $M' \models P \rightarrow x$ . If  $M \not\models P$  then  $M' \models P \rightarrow x$ . This proves that  $M'$  always satisfies  $P \rightarrow x$ . This clause of  $\text{newvar}(P, F)$  can be excluded from the proof of equivalence of  $M \models F$  and  $M' \models \text{newvar}(P, F)$  since it is always satisfied by  $M'$ .

The clauses of  $G_2$  are in both  $F$  and  $\text{newvar}(P, F)$  and do not contain  $x$ . Therefore, they are satisfied by  $M$  if and only if they are satisfied by  $M'$ , since the only difference between these two models is the value of  $x$ .

The only remaining clauses are  $A \rightarrow x \in F$  with  $P \subseteq A$  and  $A \setminus P \cup \{x\} \rightarrow y \in G_1$ . If  $M \not\models P$  then  $M' \not\models x$ ; as a result,  $M \models A \rightarrow y$  since  $P \subseteq A$  and  $M' \models A \setminus P \cup \{x\} \rightarrow y$  since  $M' \not\models x$ . Otherwise,  $M \models P$ , which implies  $M' \models x$ . As a result,  $M \models A \rightarrow y$  if and only

if  $M \models A \setminus P \rightarrow y$  since  $P$  is true in  $M$ . For the same reason,  $M' \models A \setminus P \cup \{x\} \rightarrow y$  if and only if  $M' \models A \setminus P \rightarrow y$ . These conditions coincide, proving the equivalence of  $M \models A \rightarrow y$  and  $M' \models A \setminus P \cup \{x\} \rightarrow y$ .  $\square$

Calling  $\text{newvar}(P, F)$  as many times as needed is not a problem, since it is linear-time. Therefore, it can be called to assess the gain from summarizing a set of variables  $P$  before doing that. A complete algorithm would first call it over all subsets  $P$  and check how large the result is, then replace  $F$  with the shortest formula obtained from it and repeat.

The problem is the exponential number of sets of variables. Yet, many can be excluded based on the formula. Only the sets that are contained in a body need to be checked. Still better, since the aim is to reduce size, only the sets that are contained in at least two bodies may be useful. Two bodies are sometimes enough, for example  $F = \{abcdefg \rightarrow i, abcdefh \rightarrow j\}$  is common equivalent to the shorter formula  $F' = \{abcdef \rightarrow n, ng \rightarrow i, nh \rightarrow j\}$ .

**Lemma 28** *If  $|\text{newvar}(A, F)| \leq |F|$  for some set of variables  $A$  then  $|\text{newvar}(B, F)| \leq |\text{newvar}(A, F)|$  for some intersection  $B$  of the bodies of some clauses of  $F$ .*

*Proof.* Let  $F_1 = \{P \rightarrow y \in F \mid A \subseteq P\}$  be the set of clauses of  $F$  whose bodies include  $A$ . These are the clauses  $\text{newvar}(A, F)$  replaces with  $P \setminus A \cup \{x\} \rightarrow y$ . The claim is proved for  $B = \cap\{P \mid P \rightarrow y \in F_1\}$ . This set contains  $A$  because it is the intersection of some sets  $P$  that all contain  $A$ . If  $B$  is equal to  $A$  the claim trivially holds. Therefore, only the case of strict containment  $A \subset B$  is considered.

If  $F_1$  is empty then no clause of  $F$  contains  $A$  in its body. Therefore,  $\text{newvar}(A, F) = \{A \rightarrow x\} \cup F$ . This implies  $|\text{newvar}(A, F)| = |A| + 1 + |F| > |F|$ , contrary to the assumption  $|\text{newvar}(A, F)| \leq |F|$ . As a result,  $F_1$  contains at least a clause:  $|F_1| \geq 1$ .

Both  $\text{newvar}(A, F)$  and  $\text{newvar}(B, F)$  contain  $F \setminus F_1$ . They however differ in two other ways: they respectively contain  $A \rightarrow x$  and  $B \rightarrow x$ , and they respectively contain  $P \setminus A \cup \{x\} \rightarrow y$  and  $P \setminus B \cup \{x\} \rightarrow y$  for each  $P \rightarrow y \in F_1$ .

Since  $A \subset B$ , the first clause  $A \rightarrow x$  is smaller than  $B \rightarrow x$ . The difference in size is  $|B| - |A|$ .

The opposite difference exists between  $P \setminus A \cup \{x\} \rightarrow y$  and  $P \setminus B \cup \{x\} \rightarrow y$ , where  $P \rightarrow y \in F_1$ . Since both  $A$  and  $B$  are contained in  $P$  and  $x$  is not (because it is a new variable), the size of these clauses can be computed by simple additions and subtractions:  $|P| - |A| + 1 + 1$  and  $|P| - |B| + 1 + 1$ . The difference is negative:  $|A| - |B|$ .

The overall size difference between  $\text{newvar}(A, F)$  and  $\text{newvar}(B, F)$  is  $|B| - |A|$  for the first clause and  $|A| - |B|$  for each clause of  $F_1$ , and is therefore  $|B| - |A| + |F_1| * (|A| - |B|) = (|F_1| - 1) * (|A| - |B|)$ . Since  $|F_1| \geq 1$ , this amount is negative, meaning that  $|\text{newvar}(B, F)|$  is smaller than  $|\text{newvar}(A, F)|$ .  $\square$

This lemma gives directions to the algorithm by restricting to sets  $P$  that are intersections of bodies of the formula.

This is not enough for polynomiality because the number of intersections is still exponential. A further consideration reduces search still more: size tends to decrease more for large sets  $P$  than for small, and the intersection of few sets tends to be larger than the intersection of many. Following this principle, the algorithm searches for the best intersection of two bodies and then tries to improve it by intersecting it with a third body and so on.

This procedure is always correct because it repeatedly applies  $\text{newvar}(P, F)$ , which is proved common-equivalent to  $F$  by Lemma 28. Since it only performs a replacement with a shorter formula, it is guaranteed to reduce size.

**Algorithm 2**

*formula minimize(formula F)*

1.  $F' = F$
2. for each  $A \rightarrow x, B \rightarrow y \in F$ 
  - (a) if  $|\text{newvar}(A \cap B, F)| < |F'|$ 
    - i.  $N = A \cap B$
    - ii.  $F' = \text{newvar}(N, F)$
3. if  $F' = F$  return  $F$
4.  $F'' = F'$
5. for each  $C \rightarrow x \in F'$ 
  - (a) if  $|\text{newvar}(N \cap C, F')| < |F''|$ 
    - i.  $M = N \cap C$
    - ii.  $F'' = \text{newvar}(M, F')$
6. if  $F'' \neq F'$ 
  - (a)  $N = M$
  - (b) goto Step 4
7.  $F = F''$
8. goto 1

This algorithm is implemented by the `newvar.py` program. It is proved correct by the following lemma. It does not always reduce the size of the input formula, which may already be minimal. Yet, it never increases size. That is optimal is later disproved by a counterexample.

**Lemma 29** *The formula returned by Algorithm 2 is common-equivalent to the input formula and not larger than it.*

*Proof.* The only return instruction in the algorithm is Step 3, which returns  $F$ . This variable  $F$  initially contains the input formula and is only changed in Step 7, which copies formula  $F''$  into it. In turn,  $F''$  is initialized to  $F$  and is only changed in Step 5(a)ii to  $\text{newvar}(M, F)$ . Therefore, the return value is the same as the last of a sequence of instructions  $F = \text{newvar}(M, F)$  for some sets of variables  $M$ .

Every formula produced by such a sequence is proved by induction to be common equivalent to the first. The claim trivially holds if the sequence is empty. This is the base case. In the inductive case, the initial formula is assumed common equivalent to the current; it is proved common equivalent to the next. These three formulae are called  $F_i$ ,  $F_c$  and  $F_n$ . The assumption is that the initial formula  $F_i$  is common equivalent to the current  $F_c$ . The next is  $F_n = \text{newvar}(M, F_c)$ . It is common equivalent to  $F_c$  by Lemma 27. Its variables are the same as these of the initial formula  $F_i$  and some new ones. Therefore, The variables shared between  $F_n$  and the initial formula  $F_i$  are the variables of  $F_i$ . These are also in the current formula  $F_c$ . Lemma 2 shows that common equivalence is transitive in this case: the new formula  $F_n$  is common equivalent to the initial  $F_i$ . This proves the claim in the inductive case.

Since  $M = N \cap C$ , Step 5(a)ii, replaces  $F''$  with  $\text{newvar}(N \cap C, F)$ . Since this instruction falls within the scope of the conditional  $|\text{newvar}(N \cap C, F)| < |F''|$ , this replacement may only decrease the size of  $F''$ . Since  $F''$  is initialized to  $F$ , and  $F$  is then assigned  $F''$ , the size of  $F$  monotonically decreases or stays the same during the execution of the algorithm. This proves the second part of the claim: the return value is a formula that is smaller than or equal to the input formula.  $\square$

This lemma proves that Algorithm 2 meets the minimal requirements for correctness and usefulness: it outputs a formula that is the same as the input apart from the new variables and is shorter or the same size. Hopefully, it is shorter. Ideally, it is as short as possible. This is not always the case, as the following counterexample shows.

$$F = \{x_1x_2x_3x_4x_5x_6 \rightarrow z_1, \\ x_1x_2x_3x_4x_5x_6 \rightarrow z_2, \\ x_1x_2x_3 \rightarrow z_3, \\ x_4x_5x_6 \rightarrow z_4\}$$

The intersections of the bodies of this formula are  $A = \{x_1, x_2, x_3, x_4, x_5, x_6\}$ ,  $B = \{x_1, x_2, x_3\}$  and  $C = \{x_4, x_5, x_6\}$ . The first step the algorithm takes is determining the minimum between  $\text{newvar}(A, F)$ ,  $\text{newvar}(B, F)$  and  $\text{newvar}(C, F)$ .

The result of  $\text{newvar}(A, F)$  is the following formula, of size  $7 + 2 + 2 + 4 + 4 = 19$ .

$$\text{newvar}(A, F) = \{x_1x_2x_3x_4x_5x_6 \rightarrow y, \\ y \rightarrow z_1, \\ y \rightarrow z_2, \\ x_1x_2x_3 \rightarrow z_3, \\ x_4x_5x_6 \rightarrow z_4\}$$

The result of  $\text{newvar}(B, F)$  is the following formula, of size  $4 + 5 + 5 + 2 + 4 = 20$ . By symmetry, this is also the size of  $\text{newvar}(C, F)$ .

$$\begin{aligned} \text{newvar}(B, F) = \{ & x_1x_2x_3 \rightarrow y, \\ & yx_4x_5x_6 \rightarrow z_1, \\ & yx_4x_5x_6 \rightarrow z_2, \\ & y \rightarrow z_3, \\ & x_4x_5x_6 \rightarrow z_4 \} \end{aligned}$$

Since  $\text{newvar}(A, F)$  has size 19 while  $\text{newvar}(B, F)$  and  $\text{newvar}(C, F)$  have size 20 each, the algorithm chooses  $A$ . It then checks whether intersecting  $A = \{x_1, x_2, x_3, x_4, x_5, x_6\}$  with another body further reduces size. These intersections are equal to  $B$  and  $C$ , which have been proved to produce a larger formula instead. Therefore, the first step ends with  $\text{newvar}(A, F)$  replacing  $F$ .

The second step tries to further reduce the size of  $\text{newvar}(A, F)$  by an intersection of its bodies. The intersections are the same as  $B = \{x_1, x_2, x_3\}$  and  $C = \{x_4, x_5, x_6\}$ . By symmetry, only  $\text{newvar}(B, \text{newvar}(A, F))$  is analyzed. Its size is  $4 + 5 + 2 + 2 + 2 + 4 = 19$ , the same as  $\text{newvar}(A, F)$ .

$$\begin{aligned} \text{newvar}(B, \text{newvar}(A, F)) = \{ & x_1x_2x_3 \rightarrow y', \\ & y'x_4x_5x_6 \rightarrow y, \\ & y \rightarrow z_1, \\ & y \rightarrow z_2, \\ & y' \rightarrow z_3, \\ & x_4x_5x_6 \rightarrow z_4 \} \end{aligned}$$

This formula is not shorter than the current. Therefore, the algorithm returns the current:  $\text{newvar}(A, F)$ . This is a formula of size 19.

A shorter common equivalent formula exists, and can even be found by a sequence of  $\text{newvar}()$  calls. Using  $B$  and  $C$  on  $F$  produces the following formula, of size  $4+4+3+3+2+2 = 18$ .

$$\begin{aligned} \text{newvar}(B, \text{newvar}(C, F)) = \{ & x_1x_2x_3 \rightarrow y, \\ & x_4x_5x_6 \rightarrow y', \\ & yy' \rightarrow z_1, \\ & yy' \rightarrow z_2, \\ & y \rightarrow z_3, \\ & y' \rightarrow z_4 \} \end{aligned}$$

In summary: the algorithm first finds the single best intersection  $A$  of two bodies; it then tries to intersect it with another body, but none further reduces size; it therefore replaces  $F$  with  $\text{newvar}(A, F)$ ; on this new formula, it searches all intersections of two bodies but



none reduces size. Yet, a smaller formula exists, and is obtainable by two non-minimal intersections.

The problem is with the greedy procedure: the bird in the hand  $A$  is not worth the two  $B$  and  $C$  in the bush. Every algorithm driven by the best immediate gain falls in this trap.

The counterexample is single-head and acyclic (inequivalent). Even in this very restrictive case, the greedy algorithm may fail to find the shortest common-equivalent formula. In fairness, this is not the fault of the algorithm: the problem itself is NP-complete.

Membership to NP is relatively easy to prove.

**Lemma 30** *Given a single-head formula  $F$  and an integer  $l$ , deciding the existence of a common-equivalent single-head formula  $G$  such that  $\text{Var}(F) \subseteq \text{Var}(G)$  and  $|G| \leq l$  is in NP.*

*Proof.* If  $l \geq |F|$  the answer is trivial: yes,  $G = F$ . Otherwise,  $G$  is found by guessing a formula that contains at most  $l$  variables which include  $\text{Var}(F)$  and then checking  $F \equiv G$ . Since  $l < |F|$ , such a guessing can be done in nondeterministic polynomial time. Theorem 13 proves that checking  $F \equiv G$  is also polynomial in time since both  $F$  and  $G$  are single-head. As a result, the whole problem can be solved in nondeterministic polynomial time.  $\square$

Hardness holds even in the subcase of single-head acyclic definite Horn formulae. It does not require the output formula to be single-head. In other words, whether a single-head acyclic definite Horn has a common-equivalent formula of a certain size is NP-hard, regardless of whether such an equivalent formula is required be single-head or not.

**Lemma 31** *Given a single-head minimal-size acyclic definite Horn formula  $A$  and an integer  $m$ , deciding the existence of a common equivalent definite Horn formula  $B$  such that  $\text{Var}(A) \subseteq \text{Var}(B)$  and the size of  $B$  is bounded by  $m$  is NP-hard. The same holds if  $B$  is constrained to be acyclic or single-head.*

*Proof.* The claim is proved by reduction from the vertex cover problem. A vertex cover of a graph  $(V, E)$ , where  $V = \{v_1, \dots, v_n\}$  and  $E = \{e_1, \dots, e_m\}$ , is a subset  $C \subseteq V$  such that either  $v_i \in C$  or  $v_j \in C$  for every  $e_l = (v_i, v_j) \in E$ . The vertex cover problem is to establish whether a given graph has a vertex cover of size  $k$  or less.

Given a graph, the corresponding formula and integer are as follows. For each node  $v_i$  of the graph the formula contains five variables  $v_i, r_i, r'_i, s_i$  and  $s'_i$ ; for each edge  $e_l$  it contains two variables  $e_l$  and  $e'_l$ ; finally, it contains a single other variable  $w$ .

$$\begin{aligned} A &= \{v_i w v_j \rightarrow e_l, v_i w v_j \rightarrow e'_l \mid e_l = (v_i, v_j) \in E\} \cup \\ &\quad \{v_i w r_i \rightarrow s_i, v_i w r'_i \rightarrow s'_i \mid v_i \in V\} \\ m &= 6 \times |E| + 8 \times |V| + k \end{aligned}$$

This formula is acyclic and single-head. It can be shortened by introducing new variables. In particular, the clause  $v_i w \rightarrow y_i$  allows for the following replacements:

$$\begin{aligned} v_i w v_j \rightarrow e_l &\Rightarrow y_i v_j \rightarrow e_l \\ v_i w v_j \rightarrow e'_l &\Rightarrow y_i v_j \rightarrow e'_l \\ v_i w r_i \rightarrow s_i &\Rightarrow y_i r_i \rightarrow s_i \\ v_i w r'_i \rightarrow s'_i &\Rightarrow y_i r'_i \rightarrow s'_i \end{aligned}$$

The new clause  $v_i w \rightarrow y_i$  contains three literals. The clauses  $v_i w r_i \rightarrow s_i$  and  $v_i w r'_i \rightarrow s'_i$  are shortened by one literal each, leaving the balance at plus one. Therefore, the new implication is only convenient if it shortens some clauses  $v_i w v_j \rightarrow e_l$  and  $v_i w v_j \rightarrow e'_l$ . It can unless they have already been shortened to  $v_i y_j \rightarrow e_l$  and  $v_i y_j \rightarrow e'_l$  by the other clause  $v_j w \rightarrow y_j$ .

For each edge  $e_l = (v_i, v_j)$  in the graph, introducing either  $v_i w \rightarrow y_i$  or  $v_j w \rightarrow y_j$  is always convenient because it allows shortening the clauses  $v_i w v_j \rightarrow e_l$  and  $v_i w v_j \rightarrow e'_l$  of  $e_l$  by one literal each, overmatching the increase of one due to the new clause. The variables  $v_i$  and  $v_j$  of the new clauses of the minimal formula that is common-equivalent to  $A$  form a vertex cover of the graph.

The formal proof comprises three acts:

1.  $A$  is a minimal formula; it cannot be shortened without introducing new variables;
2. if a formula is common-equivalent to  $A$ , it can be put in a certain form without a size increase while maintaining common equivalence; this form is what used in the proof sketch above: new clauses  $v_i w \rightarrow y_i$  are introduced to shorten other clauses by replacing  $v_i w$  with  $y_i$ ; it is acyclic and single-head, proving that at least an acyclic single-head formula is minimal;
3. such formulae correspond to vertex covers.

The first part of the proof shows that  $A$  is minimal. The variables in  $A$  occur either only negative (like  $v_i$ ) or only positive (like  $e_l$ ). As a result, the clauses of  $A$  do not resolve. Since no clause is contained in another,  $A$  is equal to the set of its prime implicates, and none of them is a consequence of the others. Therefore,  $A$  is minimal. Reducing its size is not possible without introducing new variables.

The second part of the proof shows that if  $B$  is common-equivalent to  $A$  and  $Var(A) \subseteq Var(B)$ , then  $B$  is at least as large as a formula obtained from  $A$  by introducing some clauses  $v_i w \rightarrow y_i$  and replacing some occurrences of  $v_i w$  with  $y_i$ .

Since  $Var(A) \subseteq Var(B)$ , Lemma 1 tells that  $B \models A$ , that is,  $B$  entails every clause of  $A$ . For example,  $B \models v_i w v_j \rightarrow e_l$ . If some clauses of  $B$  are not involved in any such an entailment, they are unnecessary and can be removed from  $B$  without affecting common equivalence.

This is a consequence of Theorem 3, which tells that if  $Var(A) \subseteq Var(B)$ , then  $A \equiv B$  is the same as  $B \models A$  and the satisfiability of  $A \cup S$  entails that of  $B \cup S$  for every consistent set of literals over the common alphabet that contains all its variables. If a clause  $c$  of  $B$  is not involved in any implication of a clause of  $A$  from  $B$ , then  $c$  can be removed from  $B$  without affecting common equivalence. Indeed,  $B \setminus \{c\} \models A$  still holds because  $c$  was not involved in  $B \models A$ , and the satisfiability of  $A \cup S$  still entails that of  $B \setminus \{c\} \cup S$  since it entails that of  $B \cup S$ .

The entailment  $B \models v_i w v_j \rightarrow e_l$  is equivalent to  $B \cup \{v_i, w, v_j\} \models e_l$ . Since  $B$  is definite Horn and contains no unit clauses,  $e_l$  is obtained by propagating  $\{v_i, w, v_j\}$  on the clauses of  $B$ .

Let  $n$  be the first variable derived in this propagation. Since it is derived, a clause  $S \rightarrow n$  is in  $B$ . Since it is the first derived from  $\{v_i, w, v_j\}$ , the premise of this clause may only contain these three variables:  $S \subseteq \{v_i, w, v_j\}$ .

The clause  $S \rightarrow n$  is used for deriving  $e_l$  from  $\{v_i, w, v_j\}$ , but may be used in other derivations as well. However, since  $S \subseteq \{v_i, w, v_j\}$ , it can only be used in derivations where the premises contain  $S$ , since otherwise it would be possible to derive a variable of  $S \subseteq \{v_i, w, v_j\}$  from other variables of  $A$ , which is not possible since  $A$  does not contain any positive occurrences of these variables.

What has been said for  $v_i w v_j \rightarrow e_l$  happens for the other clauses of  $A$  as well. These will be mentioned only when they significantly differ from  $v_i w v_j \rightarrow e_l$ .

The possible cases are analyzed by the size of  $S$ .

$|S| = 0$  : the clause  $S \rightarrow n$  is  $n$  alone; since  $A$  does not contain unit clauses,  $n$  is not a variable of it:  $n \in \text{Var}(B) \setminus \text{Var}(A)$ ; removing the clause  $n$  and each negative occurrence of  $n$  does not affect common-equivalence while reducing size, disproving  $B$  minimal;

$|S| = 1$  : the clause  $S \rightarrow n$  is binary; since  $A$  does not contain binary clauses,  $n$  cannot be one of its variables:  $n \in \text{Var}(B) \setminus \text{Var}(A)$ ; removing this clause and replacing each negative occurrence of  $n$  by the only variable of  $S$  reduces size without affecting common equivalence, disproving  $B$  minimal;

$|S| = 3$  : the only subset of  $\{v_i, w, v_j\}$  having size three is  $S = \{v_i, w, v_j\}$ ; the clause is therefore  $v_i, w, v_j \rightarrow n$ ; this is the only case where  $n$  may be a variable of  $A$ ; it may not as well;

- $n$  is a new variable:  $n \in \text{Var}(B) \setminus \text{Var}(A)$ ; as shown above, such a clause can only be used in derivations from sets of literals that contain  $\{v_i, w, v_j\}$ ; only the derivations of  $e_l$  and  $e'_l$  have such premises; since  $n$  is a new variable, it is neither  $e_l$  nor  $e'_l$ ; as a result, at least two other clauses are necessary to derive  $e_l$  and  $e'_l$ ; none of them can be unary, since otherwise  $A$  would imply either  $e_l$  or  $e'_l$ ; as a result, the derivations of  $e_l$  and  $e'_l$  require at least two binary clauses, in addition to  $v_i w v_j \rightarrow n$ ; their total size is  $4+2+2$ ; replacing them with the two original clauses  $v_i w v_j \rightarrow e_l$  and  $v_i w v_j \rightarrow e'_l$  does not change size nor affect common equivalence;

- $n$  is a variable of  $A$ ; the clause  $v_i w v_j \rightarrow n$  only comprises variables of  $A$ ; as a result, it is entailed by  $A$ ; the only two clauses of  $A$  with these premises are  $v_i w v_j \rightarrow e_l$  and  $v_i w v_j \rightarrow e'_l$ ; if  $B$  contains both then the derivations of  $e_l$  and  $e'_l$  require two clauses of four literals each, like in  $A$ ;

otherwise,  $B$  contains only one of them, for example  $v_i w v_j \rightarrow e'_l$ ; this clause alone allows deriving  $e'_l$  from  $\{v_i, w, v_j\}$ ; as shown above, it can also be used in other derivations, but only those having premises that contain  $\{v_i, w, v_j\}$ ; the only other one is the derivation of  $e_l$  from  $\{v_i, w, v_j\}$ ;

if this derivation uses  $v_i, w, v_j \rightarrow e'_l$ , then  $e_l$  is obtained by propagating  $\{v_i, w, v_j, e'_l\}$  on the clauses of  $B \setminus \{v_i w v_j \rightarrow e'_l\}$ ; if  $v_i$  is not used in this propagation, then  $B \models w v_j e'_l \rightarrow e_l$ ; since this clause only contains variables of  $A$ , it is entailed by it; this is not the case; the same applies to  $w$  and  $v_j$ , and proves that the derivation of  $e_l$  from  $\{v_i, w, v_j, e'_l\}$  uses all three variables  $\{v_i, w, v_j\}$ ; it also contains  $e_l$ , meaning that the size of the clauses involved in it is at least four;

the derivations of  $e_l$  and  $e'_l$  require  $v_i w v_j \rightarrow e'_l$  and other clauses of size at least four; this is the same as in  $A$ , which contains  $v_i w v_j \rightarrow e_l$  and  $v_i w v_j \rightarrow e'_l$

this shows that no clause  $v_i w v_j \rightarrow n$  allows decreasing size;  $B$  may contain other clauses of size four:  $v_i w r_i \rightarrow n$  and  $v_i w r'_i \rightarrow n$ ; the analysis is the same, except that the first clause may only be used in the derivation of  $s_i$ ; therefore, either  $n = s_i$  and then  $B$  contains the original clause  $v_i w r_i \rightarrow s_i$  of  $A$  or  $n$  is a new variable and then  $B$  contains another clause comprising  $s_i$ ; in both cases, the clauses used in this derivation have at least the same size of the original clause of  $A$ ; the same for the derivation of  $s'_i$ ;

$|S| = 2$  : the clause  $S \rightarrow n$  is ternary; since  $A$  does not contain ternary clauses,  $n$  is not one of its variables:  $n \in \text{Var}(B) \setminus \text{Var}(A)$ ; since  $S \subseteq \{v_i, w, v_j\}$ , only three cases are possible:  $S$  is either  $\{v_i, w\}$ ,  $\{v_i, v_j\}$  or  $\{w, v_j\}$ ; the third case is analogous to the first, so it is not considered;

a step back is necessary: this is the analysis of the first clause  $S \rightarrow n$  of the derivation of  $e_l$  from  $v_i w v_j$  in  $B$ , which is necessary since  $A$  contains  $v_i w v_j \rightarrow e_l$ ; the cases where  $|S|$  is not 2 are the same for the other clauses of  $A$ ; this one is not; the derivation of  $s_i$  from  $v_i w r_i$  involves  $S = \{v_i, r_i\}$  and  $S = \{w, r_i\}$ , and the same for  $s'_i$ ;

- $w r_i \rightarrow n$  and  $v_i r_i \rightarrow n$ ; the only derivation whose premises contain either  $\{w, r_i\}$  or  $\{v_i, w\}$  is that of  $s_i$  from  $\{v_i, w, r_i\}$ ; since  $n$  is a new variable, it is not  $s_i$ ; as a result, another clause comprising  $s_i$  is necessary; this clause cannot be unary, as otherwise  $B$  would entail  $s_i$  while  $A$  does not; therefore, the derivation requires a clause of size two in addition to  $S \rightarrow n$ , of size three; the total size is  $3 + 2 = 5$ , while the same derivation can be done in size four with the original clause  $v_i w r_i \rightarrow s_i$ ;
- $v_i v_j \rightarrow n$ ; the only derivations having  $\{v_i, v_j\}$  in their premises are those of  $e_l$  and  $e'_l$ ; since  $n$  is a new variable it is neither  $e_l$  nor  $e'_l$ ; as a result, other two clauses are necessary to entail them:  $S' \rightarrow e_l$  and  $S'' \rightarrow e'_l$ ; none of these two clauses may be unary since otherwise  $B$  would entail either  $e_l$  or  $e'_l$  while  $A$  does not; if either  $|S'| > 1$  or  $|S''| > 1$ , the total size is at least  $3 + 3 + 2 = 8$ , the same as the original clauses of  $A$ ;

otherwise, the size of both  $S'$  and  $S''$  is one: the two clauses have the form  $m \rightarrow e_l$  and  $k \rightarrow e'_l$ ; by symmetry, only the first needs to be analyzed;  $m$  cannot be one of the original variables since  $A$  does not entail any binary clauses; it cannot be  $n$  as otherwise  $B$  would imply  $v_i v_j \rightarrow e_l$  while  $A$  does not; as a result,  $B$  contains another clause  $S''' \rightarrow m$  as otherwise  $m$  would not be involved in the derivation of  $e_l$ ;

if the size of  $S'''$  is one, the same argument applies to its only variable; it has size two or more, the total size for  $e_l$  alone is at least  $3 + 3 + 2 = 8$ , regardless of how  $e'_l$  is generated; this is the same size as the clauses of  $A$  for deriving both;

- $v_i w \rightarrow n$ ; changing the name of  $n$  to  $y_i$ , this is the clause  $v_i w \rightarrow y_i$

All of this shows that every formula that is common-equivalent to  $A$  can be transformed without a size increase into a formula  $B$  where the first clause used in each derivation

$B \cup \{v_i, w, v_j\} \models e_l$  is either the original clause  $v_i w v_j \rightarrow e_l$  of  $A$  or  $v_i w \rightarrow y_i$  or  $v_j w \rightarrow y_j$ . The derivations of  $s_i$  and  $s'_i$  are similar but with the first two choices only.

What is required to complete the proof is to pinpoint the other clauses involved in the derivations. If  $B$  contains  $v_i w v_j \rightarrow e_l$ , no other clause is necessary to derive  $e_l$  from  $\{v_i, w, v_j\}$  in  $B$ . If it contains either  $v_i w \rightarrow y_i$  or  $v_j w \rightarrow y_j$ , another clause with head  $e_l$  is required.

This clause may be  $y_i v_j \rightarrow e_l$  if  $v_i w \rightarrow y_i \in B$ ,  $v_i y_j \rightarrow e_l$  if  $v_j w \rightarrow y_j \in B$ , and  $y_i y_j \rightarrow e_l$  if both clauses are in  $B$ . In the third case,  $y_i y_j \rightarrow e_l$  can be replaced by  $y_i v_j \rightarrow e_l$  with no increase in size. All these clauses have size three.

Shorter clauses  $P \rightarrow e_l$  do not work. If  $P \rightarrow e_l$  has size one then  $B$  implies  $e_l$  while  $A$  does not.

If  $P \rightarrow e_l$  has size two, it is  $n \rightarrow e_l$  for some variable  $n$ . Since  $A$  does not contain binary clauses,  $n$  is not a variable of  $A$ . Since  $n \rightarrow e_l$  is the last clause used in the derivation of  $e_l$  from  $\{v_i, w, v_j\}$ , its precondition  $n$  is entailed exactly by  $\{v_i, w, v_j\}$ . It is not entailed by any other group of variables of  $A$ , since otherwise that group would entail  $e_l$  in  $A$ . Therefore,  $n$  may only be used in the derivations from  $\{v_i, w, v_j\}$ , which are those producing  $e_l$  and  $e'_l$ . However,  $n$  is neither  $y_i$  nor  $y_j$ , as otherwise  $B$  would imply  $v_i w \rightarrow e_l$  or  $v_j w \rightarrow e'_l$ . Therefore,  $n$  is derived by another clause  $P' \rightarrow n$ . The precondition  $P'$  of this clause may not be empty, as otherwise  $B$  would imply  $e_l$  alone while  $A$  does not. Therefore, this clause has at least a precondition:  $m \rightarrow n$ . If it is used in the derivation of  $e_l$  alone, the two clauses  $m \rightarrow n$  and  $n \rightarrow e_l$  can be replaced by  $m \rightarrow e_l$ . Otherwise, the three clauses  $m \rightarrow n$ ,  $n \rightarrow e_l$  and  $n \rightarrow e'_l$  have the same size (6) of  $v_i y_i \rightarrow e_l$  and  $v_i y_i \rightarrow e'_l$  and the same size of  $v_j y_j \rightarrow e_l$  and  $v_j y_j \rightarrow e'_l$ .

The conclusion is that if a formula that is common equivalent to  $A$  has a certain size, another exists that implies  $v_i w v_j \rightarrow e_l$  through either  $\{v_i w v_j \rightarrow e_l\}$  or  $\{v_i w \rightarrow y_i, y_i v_j \rightarrow e_l\}$  or  $\{v_j w \rightarrow y_j, y_j v_j \rightarrow e_l\}$ , and similarly for the derivations of the clauses with head  $e'_l$ ,  $s_i$  or  $s'_i$ . If this formula contains other clauses, these are not necessary for common equivalence and can be removed. All remaining clauses of  $B$  are redundant since they do not contribute to entail any clause of  $A$ .

The first case  $v_i w v_j \rightarrow e_l \in B$  is now excluded for minimal formulae  $B$ . This only applies to the clauses having  $e_l$  or  $e'_l$  as their head, not  $s_i$  or  $s'_i$ . If  $B$  already contains  $v_i w \rightarrow y_i$ , the clause  $v_i w v_j \rightarrow e_l$  can be replaced by  $y_i w \rightarrow e_l$ , reducing size by one. The same if  $B$  contains  $v_j w \rightarrow y_j$ . If  $B$  contains neither, then it contains  $v_i w v_j \rightarrow e_l$ ,  $v_i w v_j \rightarrow e'_l$ ,  $v_i w r_i \rightarrow s_i$  and  $v_i w r'_i \rightarrow s'_i$ . These clauses have total size 16, but are common equivalent to  $v_i w \rightarrow y_i$ ,  $y_i v_i \rightarrow e_l$ ,  $y_i v_i \rightarrow e'_l$ ,  $y_i r_i \rightarrow s_i$ , and  $y_i r'_i \rightarrow s'_i$ , which have total size 15.

This bans the original clauses  $v_i w v_j \rightarrow e_l$  from being in  $B$ . This is instead possible for the clauses  $v_i w r_i \rightarrow s_i$ . However, such a clause cannot be in a minimal  $B$  if this formula also contains  $v_i w \rightarrow y_i$ , since  $v_i w r_i \rightarrow s_i$  could be replaced by the shorter clause  $y_i r_i \rightarrow s_i$ . The same applies to the clause containing  $s'_i$ .

In summary, the formulae  $B$  common equivalent to  $A$  built over a superset of  $\text{Var}(A)$  are either:

1. formulae that contain

- either  $\{v_i w \rightarrow y_i, y_i v_j \rightarrow e_l\}$  or  $\{v_j w \rightarrow y_j, y_j v_j \rightarrow e_l\}$  for each clause  $v_i w v_j \rightarrow e_l \in A$ , and similarly for the clauses that contain  $e'_l$ ;
- $v_i w \rightarrow y_i$  if  $y_i r_i \rightarrow s_i \in B$  and  $v_i w r_i \rightarrow s_i$  otherwise, and similarly for clauses that contain  $s'_i$ ;

2. formulae that are as large as the formulae of the first kind or larger.

The formulae of the first kind are single-head because their clauses have either the same heads as the original single-head formula or heads  $y_i$ . Since no  $y_i$  is in the original formula and only one clause is introduced with each head  $y_i$ , no two clauses have the same head. The formula is also acyclic because all its edges are from the variables  $V$ ,  $R$  and  $\{w\}$  to  $Y$ , and from all of these to  $E$  and  $S$ ; no edge back means acyclic.

The third part of the proof shows that the minimal formulae  $B$  have size linear in the size of the minimal vertex covers of the graph.

According to the conclusion of the previous part of the proof, every minimal formula that is common equivalent to  $A$  can be rewritten without size increase as a formula  $B$  that contains either  $\{v_i w \rightarrow y_i, y_i v_j \rightarrow e_l\}$  or  $\{v_j w \rightarrow y_j, y_j v_j \rightarrow e_l\}$  for each clause  $v_i w v_j \rightarrow e_l \in A$ . A consequence of this condition is that  $B$  contains either  $v_i w \rightarrow y_i$  or  $v_j w \rightarrow y_j$  for each  $e_l \in E$ . Therefore,  $C = \{v_i \mid v_i w \rightarrow y_i \in B\}$  is a vertex cover of the graph  $G$ .

The size of the formula and the cover are related as follows:

- for each clause  $v_i w v_j \rightarrow e_l$  of  $A$  a clause  $y_i v_j \rightarrow e_l$  or  $y_j v_j \rightarrow e_l$  is in  $B$ , and the same for the clause containing  $e'_l$ ; their literal occurrence count is  $3 + 3$ ; since a pair of such clause is in  $A$  for every  $e_l \in E$ , this part of  $B$  has size  $|E| \times 6$ ;
- $B$  contains a clause  $v_i w \rightarrow y_i$  for each  $v_i \in C$ ; total size is  $|C| \times 3$ ;
- $B$  contains  $v_i w r_i \rightarrow s_i$  if  $v_i w \rightarrow y_i \notin B$ , which is the same as  $v_i \notin C$ ; otherwise, it contains  $y_i r_i \rightarrow s_i$ , if  $v_i \in C$ ; total size is  $|C| \times 3 + (|V| - |C|) \times 4 = |C| \times 3 + |V| \times 4 - |V| \times 4 = |V| \times 4 - |C| \times 2$ . Adding the clauses with  $s'_i$  doubles this size to  $|V| \times 8 - |C| \times 2$ .

The overall size is therefore  $|E| \times 6 + |C| \times 3 + 8 \times |V| - |C| \times 2 = |E| \times 6 + |C| + |V| \times 8$ . The part  $|E| \times 6 + |V| \times 8$  depends only on the graph and not on the cover. The size of the formula and the cover are therefore linearly related: the formula contains as many literals as the nodes in the cover, apart a constant.

Having proved that each formula corresponds to a cover, what is missing is that every cover corresponds to a formula  $B$  of the considered kind.

Let  $C$  be a vertex cover for  $(V, E)$  such that  $|C| = k$ . A formula  $B$  of size bounded by  $m$  is proved to be common equivalent to  $A$  with  $\text{Var}(A) \subseteq \text{Var}(B)$ :

$$\begin{aligned}
B = & \{y_i v_j \rightarrow e_l, y_i v_j \rightarrow e'_l \mid v_i \in C \text{ and } (v_j \notin C \text{ or } i < j)\} \cup \\
& \{v_i y_j \rightarrow e_l, v_i y_j \rightarrow e'_l \mid v_j \in C \text{ and } (v_i \notin C \text{ or } j < i)\} \cup \\
& \{v_i w \rightarrow y_i, y_i r_i \rightarrow s_i, y_i r'_i \rightarrow s'_i \mid v_i \in C\} \cup \\
& \{v_i w r_i \rightarrow s_i, v_i w r'_i \rightarrow s'_i \mid v_i \notin C\}
\end{aligned} \tag{3}$$

This formula is common equivalent to  $A$  because resolving out all new variables  $y_i$  produces  $A$ . For example,  $y_i v_j \rightarrow e_l$  is in  $B$  only if  $v_i \in C$ , which implies that  $B$  also contains  $v_i w \rightarrow y_i$ ; resolving these two clauses produces the original  $v_i w v_j \rightarrow e_l$ .

The number of occurrences of literals in the formula is now determined. For each edge  $e_l \in E$ , the formula contains either  $y_i v_j \rightarrow e_l$  or  $v_i y_j \rightarrow e_l$ , and the same for  $e'_l$ ; the total size of these clauses is 6. For each node  $v_i \in C$ , the formula contains three implications of three literals each. For each node  $v_i \notin C$ , the formula contains two implications of size four each. The total is therefore:

$$6 \times |E| + 9 \times |C| + 8 \times (|V| - |C|) = 6 \times |E| + 8 \times |V| + |C| = 6 \times |E| + 8 \times |V| + k$$

This proves the last part of the claim: if the graph has a vertex cover of size  $k$ , then  $A$  has a common-equivalent formula of size  $m = 6 \times |E| + 8 \times |V| + k$ .  $\square$

Minimizing a formula by introducing new variables is NP-complete in the single-head case, and remains hard in the acyclic case even releasing the constraint on the minimal formula to be acyclic or single-head. The problem hardness excuses the greedy mechanism of Algorithm 2 for not being optimal. Being polynomial and correct, it cannot also be optimal unless  $P = NP$ .

## 8 Implementations

The algorithms presented in this article have been implemented in Python [VRD11] and Bash [bas07]: forgetting, common equivalence verification and minimization by variable introduction. They can currently be retrieved from <https://github.com/paololiberatore/forget>.

Formulae are sets of clauses; each clause is written `abc->d`. Implications and equivalences between sets of variables like `ab->cd` and `ab=cd` are allowed, and are internally translated into clauses. In order to allow this simple way of writing clauses, variables can only be single characters. This limits their number to the character range in Python, currently about a million.

Most formulae used in the article are made into test files for these programs. They can be checked by passing the name of the file to the programs as their only commandline argument.

### 8.1 Forget

Forgetting hinges around `body_replace()` and `head_implicates()`. The main issue in their implementation is how to realize their nondeterministic choices: the variable  $x$  in `head_implicates()` and the choice of a clause in both `body_replace()` and `head_implicates()`.

The two choices in `head_implicates()` can be realized by a single loop over the clauses of  $F$ : the clauses  $P \rightarrow x \in F$  with  $x \notin V$  are disregarded, the others are changed by calling `body_replace()` on their bodies to replace the variables to be forgotten in all possible ways.

Variables may be forgotten in many ways. For example,  $a$  in  $a \rightarrow x$  may be replaced by  $b$ ,  $cd$  and  $e$  if the formula contains  $b \rightarrow a$ ,  $cd \rightarrow a$  and  $e \rightarrow a$ . If some of the replacing variables  $b$ ,  $c$ ,  $d$  and  $e$  are to be forgotten as well, they are also recursively replaced in all possible ways. This is what nondeterminism does in `body_replace()`: each nondeterministic choice is a possible way of replacing a variable.

The first implementation of nondeterminism restricts to formulae that do not need it: the single-head ones. The second iterates over all nondeterministic choices, collecting the

results in a set. The third exploits operating systems multitasking primitives. These three implementations are in three separate programs:

**forget-singlehead.py:** when the input formula is single-head, the choice of a clause  $P \rightarrow y \in P$  with head  $y$  becomes deterministic since only zero or one such clause may exist; it is still realized as a loop, but only the first clause with head  $y$  is used; this is correct as long as the formula is single-head; the algorithm is simple as it does not implement any special mechanism for nondeterminism, but is only correct on single-head formulae;

**forget-set.py:** the function **body\_replace()** returns a set of pairs instead of a pair as in the algorithm; this set contains the possible return values of all nondeterministic choices; a recursive call to **body\_replace()** no longer returns a pair  $S, E$  but a set of such pairs; these are the possible ways to replace the variables to forget in the set  $P$ ; each such replacement is further pursued by the caller, possibly leading to other replacements; these are collected in a set of pairs, which is returned;

the increased complication of the code was to be expected, but this implementation suffers from a more serious drawback: since the nondeterministic choices are realized by sets, these may grow exponential even if the output is not; an extreme example is in the test file **branches.py**, where large sets are built to produce the single clause  $klm \rightarrow j$  when forgetting  $V$  in  $F$ .

$$\begin{aligned} F &= \{k \rightarrow a, k \rightarrow b, l \rightarrow d, l \rightarrow e, m \rightarrow g, m \rightarrow h, \\ &\quad a \rightarrow c, b \rightarrow c, d \rightarrow f, e \rightarrow f, g \rightarrow i, h \rightarrow i, cfi \rightarrow j\} \\ V &= \{k, l, m, j\} \end{aligned}$$

**forget-fork.py:** this implementation exploits multitasking; each nondeterministic possible choice is made into a branch of execution; the step “choose  $P \rightarrow y \in F$ ” is turned into a loop over the clauses of  $F$  with head  $y$ ; for each such clause, execution is forked; the first branch continues as if the clause were the only possible choice, the other waits the first to terminate; only when the original call to **head\_implicates()** ends the other branch continues the loop; if other clauses  $P \rightarrow y \in F$  exists, it repeats on one of them;

this solution may look complicated but its implementation is quite simple: in the **body\_replace()** function, the instruction “choose  $P \rightarrow y \in F$ ” is implemented as `c = choose(h)` where `h` is the set of clauses with head  $y$  and `choose()` is as follows;

```
def choose(s):
    sys.stdout.flush()
    for i,c in enumerate(s):
        if i == len(s) - 1 or os.fork() == 0:
            return c
        else:
            os.wait()
    else:
```



```
fail()
```

```
def fail():
    sys.stdout.flush()
    os._exit(0)
```

the `choose()` function receives an arbitrary collection, not only a set of clauses; if for example it is called on the list `[1,2,3]`, it iterates over its elements 1, 2 and 3; the first iteration is on 1; execution branches into a parent and child processes; the child cuts the loop short by immediately returning 1, the parents waits for the child to terminate; only when the whole child process terminates the parent continues with the second iteration of the loop, over the element 2; the same happens again: the child returns 2, the parent waits for it to finish; overall, `choose([1,2,3])` returns 1 in a branch of execution; when that finishes it returns 2 in another branch of execution; when that finishes it returns 3; in general, it creates a branch of execution for each element of the set passed as its first argument;

the `nondeterministic.py` program shows a similar example: `choose()` is called two times in a row; in the first it is passed the list of strings `['I', 'you', 'they']`, in the second the list `['go', 'wait', 'jump', 'sleep']`; what follows the two calls is executed in a separate branch for each string of the first list and each of the second; for example, a branch runs on 'I' and 'sleep', another on 'they' and 'wait' and so on for all possible combinations;

each branch of execution terminates when the program ends, not when the calling function ends; this is required: a nondeterministic branch ends when the computation ends;

while it works as required, this creates a problem: everything executed after `head_implicates()` runs in all successful branches of execution; for example, calling `head_implicates()` on a second formula processes the second formula once for each clause generated on the first; the solution is to begin `head_implicates()` by forking, returning only when the child ends;

```
def forget(f, v):
    a = choose(['run', 'wait'])
    if a == 'wait':
        return
    # run and print result
    fail()
```

currently, the program just outputs the result of forgetting; using it in the same program is not obvious, as each clause is output in a separate branch of execution; collecting them in the parent introduces the slight complication of managing a memory area shared by processes;

the run/wait split saves from the danger of exponentially growing branches: at each nondeterministic fork, only one choice is pursued; only when done the next road is taken;

while this solution may superficially appear to be also realizable by the `setjmp/longjmp` Linux system calls, it is not; neither by Posix threads; these two mechanisms only allow branches to remain separated until they return to the branching point; nondeterministic choices last until the end of the main call to `head_implicates()`;

the cost of forking is small in operating systems implementing the copy-on-write mechanism [SMJ88], such as Linux: only when memory pages start differing between the child and the parent processes they are duplicated; the creation of the child process is cheap by itself;

the number of processes in simultaneous execution is also small: each nondeterministic choice generates a waiting parent and a running child; since the parent is waiting it does not spawn any other process until the child terminates; overall, only one process is running while a polynomial number of other processes are waiting; polynomiality is guaranteed by the second parameter of `body_replace()`, which forbids replacing the same variable twice; so no, this is not a fork bomb.

## 8.2 Common equivalence

The `commonequivalent` bash script takes two formulae and tells whether they are common equivalent. It first computes their shared variables, then runs the `forget-fork.py` program on the first formula and checks whether each produced clause is entailed by the second formula by calling `entail.py`, then does the same with reversed formulae.

While the number of generated clauses may be exponential, `forget-fork.py` runs in polynomial space. Collecting all these clauses in a formula and then calling `entail.py` to check for equivalence or entailment may require exponential space. Instead, each clause produced by `forget-fork.py` is immediately piped to `entail.py` as soon as it is generated. As soon as an execution branch of `forget-fork.py` successfully ends, the clause it outputs is passed to `entail.py` and immediately discarded. Since each branch of execution takes polynomial space and `entail.py` does the same, the whole mechanism only requires polynomial space.

```
forget-fork.py $V $A | \
grep -v '[= ]' | \
{
while read F;
do
echo -n "$B |= $F"
entail.py $F $B && echo " no" && exit 1
echo " yes"
done
exit 0;
}

[ $? = 1 ] && echo "no" && exit
```

This is the check in the first direction: each clause obtained by forgetting  $V$  from  $A$  is entailed by  $B$ . The two `exit` instructions do not terminate the script but only the pipeline. They are needed to provide it a return value that can then be retrieved in the variable  `$?` .

A single Python program for checking common equivalence can be made by extending `forget-fork.py`. It requires some mechanism for terminating execution as soon as a generated clause is not entailed by the other formula.

### 8.3 Reducing size by variables addition

The `newvar.py` Python program implements Algorithm 1, the greedy algorithm for reducing formula size by introducing new variables. It works in the definite Horn case, not necessarily single-head or acyclic, but is not optimal even in the most restrictive case. The counterexample showing that the algorithm is not optimal is in the testing file `greedy.py`.

## 9 Conclusions

Summarizing the technical content of this article: variable forgetting and introducing are expressed by restricted and common equivalence, which are expressed by variable forgetting and regular equivalence; common equivalence is  $\Sigma_2^P$ -complete even in the case where it expresses forgetting; it is coNP-complete for the same case on Horn formulae; forgetting may exponentially increase size even when formula minimization is allowed; algorithms for Horn clauses running in polynomial space for forgetting and checking common equivalence are presented; they run in polynomial time if no variable is the head of two or more clauses, the single-head restriction; the problem of finding the shortest possible formula after forgetting is polynomial if the formula is also acyclic; the problem changes depending on whether the shortest formula is required to be single-head or not; an algorithm for minimizing a formula when new variables can be introduced is shown; it is not optimal, but the problem itself is NP-hard even in the single-head acyclic case.

An open question is whether minimization is polynomial-time or NP-hard in the single-head cyclic case with no variable introduction. It is polynomial-time for acyclic formulae, but is NP-hard with variable introduction. The open case is in the middle: not acyclic, but no new variables either. Some preliminary results hint it is NP-hard.

All of this applies to propositional logic, mostly in the Horn case. An open question is what extends to answer set programming and description logics, where logical forgetting is applied the most. The overall principles probably apply, such as the connection with restricted and common equivalence. Something like the replacing algorithm for forgetting may exist as well, but likely with very different computational properties.

In the other direction, different restrictions of the propositional formulae may simplify the problem. Binary clauses is a common subclass with good computational properties. Other subclasses are in Post's lattice [CHS07].

A different kind of solution is to cap the size of the formulae produced by forgetting while maintaining the consequences of the original formula as much as possible. If the size bound is a hard constraint, something which cannot be overcome, this may be the only possible solution when no formula expressing forgetting is sufficiently small. The problem is changed by this variant, similar to how approximation changes formula minimization [HK93, BDMT10], bounding the number of quantifiers changes first-order forgetting [ZZ11] and limiting size changes several PSPACE problems [Lib05].

Given that single-head formulae allow for a simple algorithm for forgetting, another

question is whether a formula that is not single-head can be turned in this form. For example,  $\{a \rightarrow b, b \rightarrow a, b \rightarrow c, c \rightarrow b\}$  is not single-head, but is equivalent to the single-head formula  $\{a \rightarrow b, b \rightarrow c, c \rightarrow a\}$ . The problem of identifying such formula is not trivial as it may look, and is analyzed in a followup article.

## References

- [AEW12] G. Antoniou, T. Eiter, and K. Wang. Forgetting for defeasible logic. In *Proceedings of the eighteenth conference on Logic for Programming, Artificial Intelligence, and Reasoning (LPAR-18)*, volume 7180 of *Lecture Notes in Computer Science*, pages 77–91. Springer, 2012.
- [bas07] *Bash reference manual*, 2007.
- [BB10] U. Bubeck and H.K. Büning. The power of auxiliary variables for propositional and quantified boolean formulas. *Studies in Logic*, 3(3):1–23, 2010.
- [BDMT10] A. Bhattacharya, B. DasGupta, D. Mubayi, and G. Turán. On approximate Horn formula minimization. In *Proceedings of the Thirtyseventh International Colloquium on Automata, Languages and Programming (ICALP 2010)*, pages 438–450, 2010.
- [CDLS00] M. Cadoli, F. M. Donini, P. Liberatore, and M. Schaerf. Space efficiency of propositional knowledge representation formalisms. *Journal of Artificial Intelligence Research*, 13:1–31, 2000.
- [CHS07] P. Chapdelaine, M. Hermann, and I. Schnoor. Complexity of default logic on generalized conjunctive queries. In *Proceedings of the Ninth International Conference on Logic Programming and Nonmonotonic Reasoning (LPNMR 2007)*, pages 58–70. Springer, 2007.
- [CMLLM04] S. Coste-Marquis, J. Lang, P. Liberatore, and P. Marquis. Expressive power and succinctness of propositional languages for preference representation. In *Proceedings of the Ninth International Conference on Principles of Knowledge Representation and Reasoning (KR 2004)*, pages 203–212, 2004.
- [Cou94] O. Coudert. Two-level logic minimization: an overview. *Integration*, 17(2):97–140, 1994.
- [CS02] O. Coudert and T. Sasao. Two-level logic minimization. In *Logic Synthesis and Verification*, pages 1–27. Springer, 2002.
- [Del17] J.P. Delgrande. A knowledge level account of forgetting. *Journal of Artificial Intelligence Research*, 60:1165–1213, 2017.
- [DW15] J.P. Delgrande and K. Wang. A syntax-independent approach to forgetting in disjunctive logic programs. In *Proceedings of the Twenty-Ninth Conference on Artificial Intelligence (AAAI 2015)*, pages 1482–1488. AAAI Press, 2015.

- [EF07] E. Erdem and P. Ferraris. Forgetting actions in domain descriptions. In *Proceedings of the Twenty-Second AAAI Conference on Artificial Intelligence (AAAI 2007)*, pages 409–414. AAAI Press, 2007.
- [EIS<sup>+</sup>06] T. Eiter, G. Ianni, R. Schindlauer, H. Tompits, and K. Wang. Forgetting in managing rules and ontologies. In *2006 IEEE / WIC / ACM International Conference on Web Intelligence (WI 2006), 18-22 December 2006, Hong Kong, China*, pages 411–419. IEEE Computer Society Press, 2006.
- [EKI19] T. Eiter and G. Kern-Isberner. A brief survey on forgetting from a knowledge representation and perspective. *KI - Kuenstliche Intelligenz*, 33(1):9–33, 2019.
- [EW06] T. Eiter and K. Wang. Forgetting and conflict resolving in disjunctive logic programming. In *Proceedings of the Twenty-First National Conference on Artificial Intelligence (AAAI 2006)*, pages 238–243, 2006.
- [FHMV95] R. Fagin, J.Y. Halpern, Y. Moses, and M. Vardi. *Reasoning about knowledge*. The MIT Press, 1995.
- [FKL93] A. Flögel, H. Kleine Büning, and T. Lettmann. On the restricted equivalence subclasses of propositional logic. *Informatique Théorique et Applications*, 27(4):327–340, 1993.
- [GKL16] R. Gonçalves, M. Knorr, and J. Leite. The ultimate guide to forgetting in answer set programming. In *Proceedings of the Fifteenth International Conference on Principles of Knowledge Representation and Reasoning (KR 2016)*, pages 135–144. AAAI Press, 2016.
- [GKLW17] R. Gonçalves, M. Knorr, J. Leite, and S. Woltran. When you must forget: Beyond strong persistence when forgetting in answer set programming. *Theory and Practice of Logic Programming*, 17(5-6):837–854, 2017.
- [HK93] P.L. Hammer and A. Kogan. Optimal compression of propositional horn knowledge bases: Complexity and approximation. *Artificial Intelligence*, 64(1):131–145, 1993.
- [HK95] P.L. Hammer and A. Kogan. Quasi-acyclic propositional horn knowledge bases: Optimal compression. *IEEE Transactions on Knowledge and Data Engineering*, 7(5):751–762, 1995.
- [Kar53] M. Karnaugh. The map method for synthesis of combinational logic circuits. *Transactions of the American Institute of Electrical Engineers, Part I: Communication and Electronics*, 72(5):593–599, 1953.
- [KWW09] B. Konev, D. Walther, and F. Wolter. Forgetting and uniform interpolation in extensions of the description logic EL. In *Proceedings of the 22nd International Workshop on Description Logics (DL 2009)*, volume 9, 2009.
- [LC09] S. Lescuyer and S. Conchon. Improving Coq propositional reasoning using a lazy CNF conversion scheme. In *International Symposium on Frontiers of Combining Systems*, pages 287–303. Springer, 2009.

- [Lib05] P. Liberatore. Complexity issues in finding succinct solutions of PSPACE-complete problems. Technical Report abs/cs/0503043, CoRR, 2005.
- [Lib20] P. Liberatore. The ghosts of forgotten things: A study on size after forgetting. *Computing Research Repository (CoRR)*, abs/2005.04123, 2020.
- [LM10] J. Lang and P. Marquis. Reasoning under inconsistency: A forgetting-based approach. *Artificial Intelligence*, 174(12-13):799–823, 2010.
- [LR94] F. Lin and R. Reiter. Forget it! In *Proceedings of the AAAI Fall Symposium on Relevance*, pages 154–159, 1994.
- [McC56] E.J. McCluskey. Minimization of boolean functions. *The Bell System Technical Journal*, 35(6):1417–1444, 1956.
- [Pel16] N. Peltier. Propositional resolution and prime implicates generation. *Archive of Formal Proofs*, 2016.
- [RHPT14] D. Rajaratnam, Levesque. H.J., M. Pagnucco, and M. Thielscher. Forgetting in action. In *Proceedings of the Fourteenth International Conference on Principles of Knowledge Representation and Reasoning (KR 2014)*. AAAI Press, 2014.
- [RSV87] R.L. Rudell and A. Sangiovanni-Vincentelli. Multiple-valued minimization for pla optimization. *IEEE Transactions on Computer-Aided Design of Integrated Circuits and Systems*, 6(5):727–750, 1987.
- [Sav70] W.J. Savitch. Relationships between nondeterministic and deterministic tape complexities. *Journal of Computer and System Sciences*, 4(2):177–192, 1970.
- [SMJ88] J.M. Smith and G.Q. Maguire Jr. Effects of copy-on-write memory management on the response time of UNIX fork operations. *Computing Systems*, 1(3):255–278, 1988.
- [Tar73] R. Tarjan. Enumeration of the elementary circuits of a directed graph. *SIAM Journal on Computing*, 2(3):211–216, 1973.
- [TNW96] M. Theobald, S.M. Nowick, and T. Wu. Espresso-HF: a heuristic hazard-free minimizer for two-level logic. In *Proceedings of the Thirtythird Design Automation Conference*, pages 71–76, 1996.
- [UVSV06] C. Umans, T. Villa, and A.L. Sangiovanni-Vincentelli. Complexity of two-level logic minimization. *IEEE Transactions on Computer-Aided Design of Integrated Circuits and Systems*, 25(7):1230–1246, 2006.
- [vDHLM09] H. van Ditmarsh, A. Herzig, J. Lang, and P. Marquis. Introspective forgetting. *Synthese*, 169:809–827, 2009.
- [Vei52] E.W. Veitch. A chart method for simplifying truth functions. In *Proceedings of the 1952 ACM national meeting (Pittsburgh)*, pages 127–133, 1952.

- [VRD11] G. Van Rossum and F.L. Drake. *The Python language reference manual*. Network Theory Ltd., 2011.
- [WSS05] K. Wang, A. Sattar, and K. Su. A theory of forgetting in logic programming. In *Proceedings of the Twentieth National Conference on Artificial Intelligence and the Seventeenth Innovative Applications of Artificial Intelligence*, pages 682–688. AAAI Press/The MIT Press, 2005.
- [WZZZ14] Y. Wang, Y. Zhang, Y. Zhou, and M. Zhang. Knowledge forgetting in answer set programming. *Journal of Artificial Intelligence Research*, 50, 05 2014.
- [ZZ11] Y. Zhou and Y. Zhang. Bounded forgetting. In *Proceedings of the Twenty-Fifth AAAI Conference on Artificial Intelligence (AAAI 2011)*. AAAI Press, 2011.