

CedrusDB: Persistent Key-Value Store with Memory-Mapped Lazy-Trie

Maofan Yin, Hongbo Zhang, Robbert van Renesse, Emin Gün Sirer
Cornell University

Abstract

As RAM is becoming cheaper and growing abundant, it is time to revisit the design of persistent key-value storage systems. Most of today’s persistent key-value stores are based either on a write-optimized Log-Structured Merge tree (LSM) or a read-optimized B⁺-tree. Instead, this paper introduces a new design called “lazy-trie” to index the persistent storage, a variant of the hash-trie data structure. A lazy-trie achieves near-optimal height and has practical storage overhead. Unlike other balanced data structures, it achieves this without the need for expensive reorganization of subtrees, allowing improved write performance.

We implemented CedrusDB, a lazy-trie-based persistent key-value store that supports point lookup and updates. CedrusDB outperforms both popular LSM- and B⁺-tree-based key-value stores in mixed workloads. The implementation of CedrusDB uses memory-mapping. The lazy-trie organization in virtual memory allows CedrusDB to better leverage concurrent processing than other organizations.

1 Introduction

Persistent key-value stores have become an indispensable part of applications such as web servers [5], cloud storage [17, 46], machine learning [35], mobile apps [22], and even blockchain infrastructures [39, 43]. There are two main on-disk data structures that are used extensively for a general-purpose persistent key-value store: B⁺-trees and Log-Structured Merge Trees (LSMs). B⁺-trees have stable, predictable degradation as the data set grows large and supports fast read access, but they incur non-sequential small writes that sometimes get amplified in order to maintain balance. LSMs, on the other hand, are optimized for write-intensive workloads. They usually have high write-throughput as most of the writes are sequential and the resulting storage space is compact. An LSM-tree, unlike the name suggests, does not have an explicit tree structure that organizes nodes as in B⁺-trees. Instead, the merge tree serves as a conceptual hierarchy that directs how to merge-sort user data. The amount of merge-sorted data gets amplified as the level goes deeper and thus may cause severe write amplification during log compaction. Compared to B⁺-trees, LSMs also have higher read amplification.

Both designs are intended for scenarios where the data set cannot fit in memory and the underlying secondary storage is much slower than memory. But servers and consumer devices have increasingly larger memories. Today, servers may have

tens to thousands of gigabytes of memory with a secondary storage using flash or non-volatile memory technology. As a result, more applications can have all or at least most of their data set fully reside in memory, and this has ignited interest in exploring new data structures that better utilize the characteristics of the abundant memory [14, 46] or even non-volatile main memory [26, 32]. At the same time, solid state devices (SSDs) may also require changes in data structures on secondary storage to take advantage of the much faster access times [29, 40].

We consider the design of a persistent key-value store that uses SSDs for persistence and where the volatile main memory is capable of storing most of the data set for high access demand. Some recent key-value store designs have eschewed on-disk indexes altogether, favoring a fast in-memory index and an unordered solution for persistence such as logging updates sequentially or slab allocation [9, 28, 31, 33]. While such designs can perform very well in the failure-free case, crash recovery involves reading large sections if not all of the disk, leading to lengthy recovery times. In practice, all popular persistent key-value stores use on-disk indexes.

This paper proposes *lazy-trie*, a storage-friendly data structure. All nodes in a lazy-trie have the same number of children slots, simplifying maintenance. To bound the depth of the trie and probabilistically balance the load, user keys are hashed to index into the trie. To further reduce the depth of the trie and improve utilization, the lazy-trie uses a path compression technique similar to radix trees [34]. Finally, some small subtrees are collapsed into linked lists at leaves, greatly reducing storage overhead and read/write amplification.

We use the lazy-trie data structure to implement a memory-mapped, persistent key-value store, *CedrusDB*. It supports point operations as a key-value store sorted by key hash. It is able to achieve near-optimal dynamic tree height with practical storage overhead. CedrusDB outperforms carefully engineered key-value stores such as LevelDB, RocksDB, and LMDB in nearly all read- or write-intensive mixed workloads.

Like LMDB [14], the implementation of CedrusDB uses memory-mapping, but, unlike LMDB, CedrusDB does not require that all of the data set fit in available memory—CedrusDB implements its own page replacement and does not rely on the operating system kernel to do so. The lazy-trie organization in virtual memory allows CedrusDB to better leverage concurrency.

A limitation of CedrusDB is that it does not support range queries (because the index is sorted by hash). CedrusDB

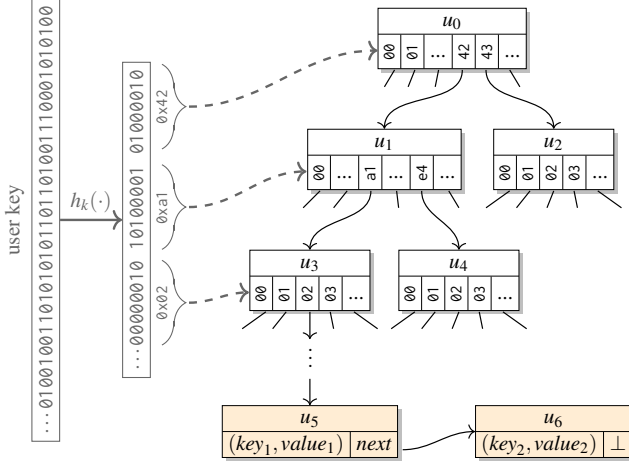

Figure 1: Basic structure of a hash-trie, with chained leaf nodes.

does not perform as well as some of its competitors for write-only workloads or if the working set size is much larger than available memory.

This paper makes the following contributions:

- The lazy-trie data structure, which dynamically grows with near-optimal tree height, has a practical storage footprint, and allows for efficient concurrent access.
- The design and implementation of CedrusDB, a high-performance key-value store that uses the lazy-trie.
- Evaluation results show that, compared to its most important competitors, CedrusDB provides superior performance for mixed workloads and is able to better leverage multi-core computing.

Section 2 introduces the lazy-trie data structure and its unique properties. Section 3 discusses the storage model, design decisions, and optimizations that went into building CedrusDB. Section 4 presents our evaluation of CedrusDB. Section 5 discusses related work, and Section 6 concludes.

2 The Lazy-Trie Data Structure

The design of CedrusDB is inspired by memory-mapped key-value stores like LMDB [14]. Instead of using B⁺-tree variants or other tree structures that require complex operations to move nodes across sibling subtrees for a logarithmic tree height, we propose *lazy-trie*, a trie-tree structure tailored for persistent storage. In this section, we describe the lazy-trie by progressively adding its crucial elements, along with a discussion of its properties and their implications for storage.

2.1 Hash-Trie for Persistent Storage

A *trie* is a tree structure that encodes all prefix paths of inserted key strings. Each key is treated as a sequence of con-

secutive fix-width *characters*. A trie stores paths of edges representing character sequences, collapsing all shared prefix into a tree topology.

A *hash-trie* is a trie indexed by a hash. CedrusDB uses a strong (well-distributed) and fast hash function (see Section 3) to map an arbitrary key string given by the user to a 256-bit hash. It then partitions the hash into equal-length characters. In the trie, a *tree node* consists of a character-indexed array of pointers to its child nodes and a pointer referring back to its parent node. We define the *height* of a given node to be the number of its ancestors. Thus, the root node has a height of zero. Each leaf node maintains a linked list of user key-value pairs. Figure 1 depicts the basic structure of a hash-trie, where the user key *key*₁ and *key*₂ in data node *u*₅ and *u*₆ have the same hash prefixed by 0x42a102. The size of the hash should be chosen so that the probability of such collisions is small.

The insertion algorithm starts from the root node. It first visits the child indexed by the first character of the key hash, proceeds to the next child by the second character, and recursively walks down the trie until the entire key sequence is consumed. Child nodes are created as needed. At the leaf node, the algorithm adds a *data node* containing the original key-value data of the user to the linked list.

Lookup is similar to insertion. When reaching the leaf node, the linked list is scanned doing a full comparison using the original, unhashed user key to locate the value.

There are some similarities between the hash-trie and the B⁺-tree data structures. First, both are balanced, n-ary tree structures. In practice, a typical B⁺-tree has a branching factor of several hundreds. As we show later in the evaluation, a good choice for the branching factor for the hash-trie is hundreds of children per node as well. Second, both B⁺-trees and hash-tries only store user data at the leaves—intermediate nodes only contain metadata for indexing.

That being said, the structures have important differences. The height of a B⁺-tree is logarithmic in the number of keys. When inserting data, a B⁺-tree has to constantly adjust its topology across sibling subtrees to maintain tree balance. In a hash-trie, the path to the leaf node for a specific key is *static*: there is no reorganization of this path when other data is inserted or deleted. This significantly reduces the I/O cost of maintaining the internal index structure and simplifies concurrent access or modification to the tree. Finally, all tree nodes of a hash-trie have an identical size and the same storage footprint, which simplifies the storage maintenance and reduces fragmentation. B⁺-tree nodes have a variable number of children, bounded by the branching factor.

A disadvantage of the hash-trie design is that operations always need to visit a fixed number of tree nodes even if the data store is small. Also, the utilization of child tables in tree nodes can be low, potentially resulting in significant write amplification. We next show, in two steps, how to improve upon the hash-trie structure to build a practical, dynamically grown

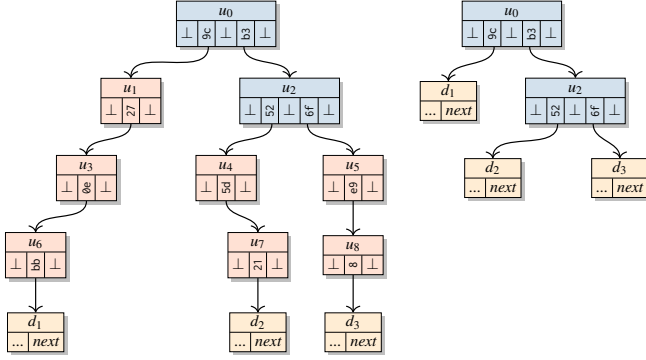

Figure 2: The tree structure without (left) and with (right) the path compression.

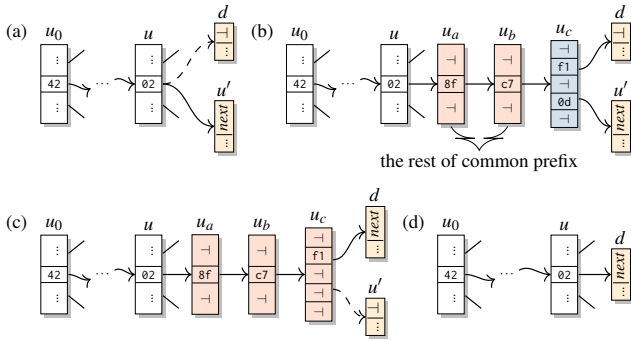

Figure 3: The bookkeeping operations required by lazy-trie. (a)(b) show a split operation, when a new data node d is inserted. (b)(c)(d) show a merge operation when the parent node u_c only has one child after the other child is removed.

lazy-trie with near-optimal height and small storage overhead by utilizing statistical properties of the hash function.

2.2 Path Compression

Let the branching factor be b . Then two keys have b^{-h} probability of sharing the same prefix of length h . The exponentially decreasing probability means that, as one descends into the tree, it becomes less likely to have forks in the tree. This led us to compress the suffix of paths in the hash-trie and only unroll the compressed path when necessary. Data nodes remain at the leaves, so the collision rate remains unchanged. Figure 2 illustrates the new design. Compared to radix trees, the difference is that we only compress the *suffixes* of paths—internal paths may still have nodes with only one child.

Whenever inserting a new node, we lazily create the minimum number of intermediate missing nodes just to distinguish data nodes with different hashes. During the insertion, we first follow the tree structure as usual. If we reach a data node that

is supposed to be a tree node, then we insert a tree node, uncompressing the path (see Figure 3).

The lookup algorithm stays essentially the same: *Ce-drusDB* traverses the lazy-trie according to the key hash until it reaches a data node, then it scans through the list of data nodes. In the delete algorithm, when a data node is removed, a *merge* operation checks whether it is the only child of its parent node. If so, it collapses the non-forking path repeatedly until reaching an ancestor having more than one child and stops there.

Unlike insertion or deletion in other tree structures, which require complex recursive reorganization, there is at most one non-recursive split for each insertion and one non-recursive merge for each deletion. In a split, a simple path of intermediate nodes is created as a chain, while, in a merge, the longest non-forking path is collapsed into a direct parent reference. These operations only happen on a *single path* of insertion and deletion, so they do not interfere with any other siblings or their subtrees.

As a result, lazy-trie dynamically adjusts the tree height depending on how frequently the prefixes of inserted key hashes conflict. The hash function offers uniformly distributed key hashes regardless of the order of insertion, statistically balancing the tree with a height of approximately $\log_b n$, where n is the number of keys. Since the probability of a shared prefix decreases exponentially with the length of the prefix, in expectation there will be few missing intermediate nodes in a split operation.

2.3 Sluggish Splitting

The lazy-trie structure has an average path length that grows logarithmically with the number of keys (Figure 5, top, $s = 1$). However, due to the probabilistic nature, the paths for different keys can have significantly different lengths and the height of the trie (the maximum path length) can be significantly larger than the average path length. Moreover, the child tables in the leaf nodes tend to be mostly empty, leading to significant space underutilization because the majority of the space in a node is its child table (Figure 5, middle, $s = 1$). The problem is that the lazy-trie must guarantee that keys with different hashes cannot be in the same linked list.

To reduce variance in path lengths and improve utilization, we will allow keys with different hashes to share the same linked list. We define *sluggishness* to be the maximum number of hash values that are allowed in a linked list of data nodes. A *sluggish lazy-trie* will only split the path when a linked list overflows. If so, the linked list will be replaced with a leaf node, and all data nodes in the linked list will be redistributed into the child table of the new leaf node. The redistribution is recursive and continues until the sluggishness constraint is met. Figure 4 shows an example of the steps in redistribution.

To demonstrate how sluggish splitting mitigates the problems of high path length variation and low utilization, Figure 5

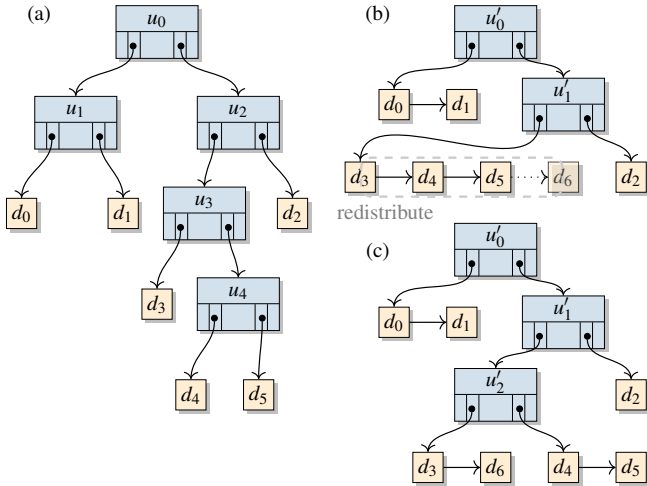

Figure 4: (a) a trie without sluggishness ($s = 1$). (b) in a sluggish lazy-trie, an insertion (d_6) can lead to overflowing the linked list of data nodes. (c) for a maximum sluggishness of 3, the data nodes are redistributed.

shows the average path length and child table utilization as the data store grows in size for different levels of sluggishness s . The periodic change of utilization is due to the statistical growth of the tree height. The bottom graph shows the number of bytes used by tree nodes as a function of the number of keys. With a sluggishness $s = 4$, the storage overhead is significantly reduced compared to no sluggish splitting ($s = 1$).

3 System Design and Implementation

In this section, we show how a lazy-trie can be used to build CedrusDB, a high-performance key-value store. CedrusDB has been fully implemented in ~6K lines of pure Rust. Rust is a modern systems programming language that provides statically checked memory- and thread-safety guarantees [4, 18, 42]. In addition to basic constructs offered by the standard library, it allows programmers to customize their building blocks with different safety guarantees [19]. For CedrusDB, we explored how to separate the lazy-trie algorithm from the underlying storage management. We also make use of native functionalities of Linux, some of which may not be available on other operating systems, such as `io_submit` for kernel-based asynchronous IO (AIO).

3.1 Logical Spaces

In some key-value stores, like LMDB [14], the entire store is always mapped in memory and the maximum size has to be predetermined at its creation. CedrusDB supports a dynamically growing data set that may not all fit in memory. To support this, it has *logical spaces*, one for each type of objects.

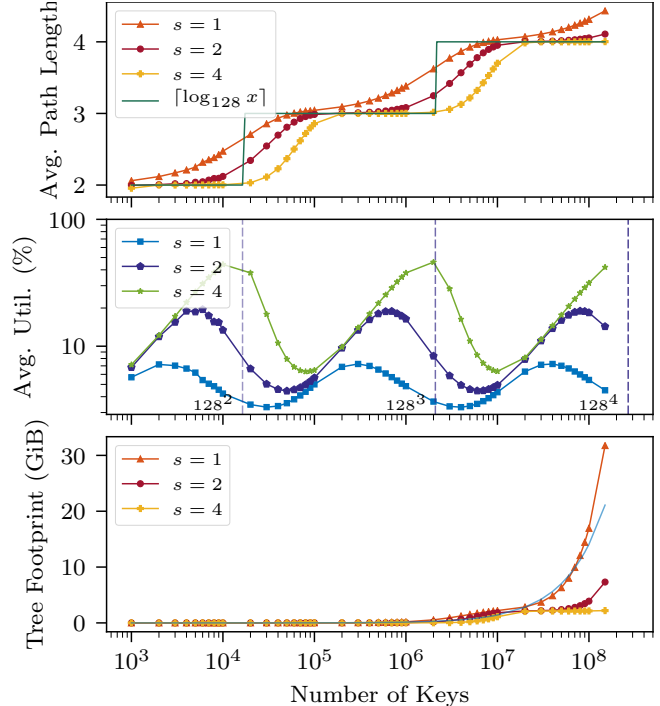

Figure 5: Average path length, child table utilization, and meta-data storage footprint for a 128-ary lazy-trie as a function of the number of keys, with different sluggishness values. The solid blue line in the bottom graph shows the user data footprint for 23-byte keys and 128-byte values.

A logical space is a 64-bit four layer virtual address space. A *logical address* is a 64-bit unsigned integer subdivided into four parts: a segment number, a region number, a page number, and a page offset. CedrusDB associates a file with each segment. Each region is either fully mapped or unmapped. When mapped, it can be accessed like ordinary memory, that is, regions are memory-mapped that allow zero-copy read access. Figure 6 shows the organization of storage units with different granularities.

Objects cannot span across regions. Regions can only be accessed by mapping them, and thus the number of mapped regions is effectively the cache size, blurring the boundary between the “cache-based” approach, used by stores like LevelDB and RocksDB, and the “memory-based” approach by stores like LMDB and Memcached. Ideally, the performance is optimal when regions can remain mapped as long as they are in active use, which is the main focus of this paper.

To map regions, we use `mmap`. While in theory we could let the kernel keep track of dirty pages and write them back to the underlying segment files, we found that this solution, while simple, did not provide good performance even when `madvise` is used. The kernel ends up writing the same, actively modified pages repeatedly, thus incurring prohibitively high write cost. Moreover, when the bounded kernel buffer of pending writes is full, the kernel slows down store instruc-

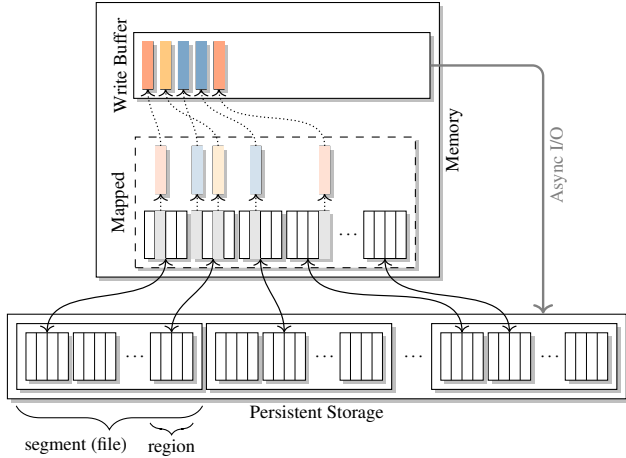

Figure 6: CedrusDB storage hierarchy with mapped memory and write buffer. The smallest rectangle represents a page.

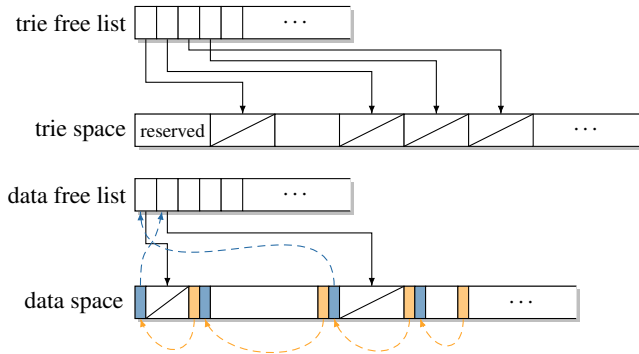

Figure 7: Four logical spaces used in CedrusDB.

tions (such as x86 mov) made to the virtual memory space, resulting in performance that is hard to predict.

The storage architecture of CedrusDB is therefore hybrid. We map the regions in memory but keep track of our own write buffer for dirty pages. Doing so also benefits write-ahead-logging.

Logical spaces allow the lazy-trie algorithm to operate transparently as if the entire data structure is in memory. CedrusDB maintains four logical spaces:

1. *trie space*: tree nodes in use;
2. *trie free list*: a stack of indexes (pointers) to unused tree nodes;
3. *data space*: data nodes in use;
4. *data free list*: an array of descriptors tracking the unused portion of data space.

Tree nodes have a fixed size, and thus the trie space contains an array of tree nodes. The trie free list contains a stack of indexes into the tree node array. To free a tree node, its index

is pushed onto the stack. To allocate a tree node, its index is popped from the stack.

In the data space, in-use and free data nodes of different sizes are stored continuously with a header at the front and a footer at the end. The footer of a data node is right before the header of the next data node and contains the size of the data node. It supports merging of two adjacent free data nodes (see below). Instead of maintaining a doubly-linked list of free data nodes like the free list in glibc’s malloc, CedrusDB maintains a separate, unsorted array of *hole descriptors* for better locality and therefore I/O efficiency (see Figure 7). Each descriptor points to a free data node, while the header of a free data node points back to its descriptor.

CedrusDB adopts a *next-fit allocation policy* [23, 25], using two indexes into the array of hole descriptors. *tailIdx* points to the first unused descriptor. *curIdx* points to the last descriptor visited by the allocator. To allocate a data node, the allocator starts at *curIdx* and scans (wrapping around at *tailIdx*) until it finds a free data node that is large enough. If the free data node is larger than needed, it is split into two. If the free data node is exactly the right size, it will be reused and its descriptor is replaced by the one before *tailIdx* and *tailIdx* is decremented. If there is no free data node large enough, the data space is enlarged to accommodate a new data node. As we show in Section 4.2.5, the allocator does not have to fully scan through the free list, allowing for better performance.

To free a data node, we first check if either or both of the adjacent data nodes are free. If so, we merge the data nodes (possibly reducing the number of hole descriptors if both adjacent data nodes are free). If not, we add a new hole descriptor at *tailIdx*. The *tailIdx* pointer, together with the trie root pointer and other tail pointers that indicate the boundary of logical spaces, are all stored within the first (reserved) 4KBytes page of the trie space, before the entire tree node array.

3.2 Memory Abstraction and Layout

To benefit from Rust’s memory-safety and thread-safety guarantees, we crafted our own memory-mapped object abstraction that fits in Rust’s idiom and thus utilizes its type checker. Rust does not come natively with a type-safe wrapper or primitive for memory-mapping. Although *nix* [36], a popular Rust library, provides related functions, they are exposed as Rust function signatures of the original POSIX interface in C. They are unsafe because the compiler makes normal assumptions about memory management and variable life-times without making accommodations for memory-mapped address space.

3.2.1 Space and Objects

The `MMapedSpace` struct is the core of implementing the logical space abstraction (Section 3.1). It can be created from file handles and exposes safe methods.

```

#[repr(C)]
union ChdRaw {
    node: ObjPtr<Node>,
    data: ObjPtr<Data>,
}

#[repr(C)]
pub struct Node {
    parent: ObjPtr<Node>, // parent node (for deletion)
    height: u8,
    pub pidx: NBranchType, // index in the parent node
    data_mask: [u64; NBRANCH / 64], // data node bitmask
    chd_mask: [u64; NBRANCH / 64], // validity bitmask
    children: [ChdRaw; NBRANCH], // child table
    // reserved field for late-initialization
    pub rwlock: std::mem::MaybeUninit<RwLock<>>
}

```

Figure 8: Tree Node Layout.

We use an opaque struct to represent a pointer into logical space so that either it can be reconstructed from persistent storage (like a pointer to an existing tree node) or allocated through `MMappedSpace`. The reason we need an abstraction for a pointer is two-fold. First, addresses in logical spaces do not directly correspond to virtual memory addresses even if the corresponding region is mapped. Second, using an integer indexing into logical space would be unsafe. Given a typed object pointer, `ObjPtr<T>`, it can dereference the pointer to the correspondingly typed object handle, `ObjRef<T>`. This allows manipulating the actual object typed `T` available in memory as if there is no memory-mapping. (It will auto-dereference to `&mut T`, which is an ordinary mutable access to a variable typed `T`.) The object handle is accessible throughout its lifetime by pinning the affected region in memory.

3.2.2 Tree Metadata

A lazy-trie tree node consists predominantly of a fixed-size array of pointers to its children, as shown in Figure 8. Two bitmasks indicate the validity and type of the pointer in a particular slot. To obtain child information, `chd_mask` is first examined to determine whether the slot contains a valid pointer. If so, `data_mask` specifies whether the pointer is to another tree node (`struct Node`) or a data node (`struct Data`). As the most accessed component in the node structure, both bitmasks are accessed using bitwise arithmetic. On x86-64 we use inline assembly with BMI quadword instructions such as `bsfq` and `bzhiq` for optimal performance.

We use the `#[repr(C)]` compiler directive to ensure a C-struct layout, guaranteeing that all memory-mapped objects can be correctly accessed even if the Rust compiler changes the default layout of `struct`. Unfortunately we cannot take advantage of the feature-rich Rust enum type. Thus, `ChdRaw` is hidden to other parts of the `CedrusDB`, which access the trie data structure through safe enum structs and methods.

```

#[repr(C)]
pub struct Data {
    lsize: u8, // the size of the linked list
    hkey: [u8; HASH_LEN], // bytes of the hashed key
    key_mode: KeyMode,
    key_size: u64, // number of bytes in user key
    val_size: u64, // number of bytes in value
    next: ObjPtr<Data> // the next item in the list
    // NOTE: the raw key-value bytes follow
}

```

Figure 9: Data Node Layout.

3.2.3 User Data

We use Google’s `HighwayHash` [3] to hash keys. For each user key-value pair, we use an object of `Data` struct (Figure 9) to hold the precomputed `HighwayHash` of the original arbitrary-length key in `hkey`, and size information for the original key and value in `key_size` and `val_size`. The actual user key and value are placed directly after the Rust structure. To support keys with colliding hashes and sluggish splitting, `Data` objects are chained together into a singly-linked list using the `next` pointer. We use `madvise` [1] to request that the kernel pre-fetches the memory pages storing data objects.

3.3 Disk I/O

As described in Section 3.1 and shown in Figure 6, `CedrusDB` uses a separate write buffer to serialize all changes and schedule them as *block writes* to the physical storage device. Each modification made to the internal lazy-trie data structure first writes directly to memory.¹ The state of the memory thus always reflects the latest changes. To update the underlying storage, the same write is also sent to a *disk thread* via a bounded buffer.

The changes generated by tree logic are short and frequent, which is not optimal for secondary storage. `CedrusDB` therefore aggregates the updates into blocks. The Linux `ext4` filesystem has the same block size as the page size, so `CedrusDB` is configured to use 4KBytes blocks.

While the lazy-trie data structure does not require log compaction such as used in LSMs and is arguably simpler to maintain than B^+ -trees, it suffers potentially from non-optimal locality and random writes when pointers need to be updated. To optimize storage updates, the `CedrusDB` disk thread uses Linux native *Asynchronous I/O* (AIO). Not to be confused with the POSIX AIO standard offered by `glibc` [37], Linux AIO performs concurrent writes if possible. We access AIO through `libaio`, a thin C ABI wrapper that is available on main-stream Linux distributions. AIO allows us to asynchronously manage reads and writes in a non-blocking style.

Because `CedrusDB` supports concurrent operations on the lazy-trie, it is possible that multiple user threads make changes

¹Due to limitations of `mmap`, we map the memory in copy-on-write mode even though we do not require that the original contents is saved.

to the same page (block). In CedrusDB it is the disk thread's responsibility to obtain the consistent state of a block from a file if it is not already available in the buffer, rather than copying the content from memory as there may be a data race. The disk thread can schedule such an infrequent block read while at the same time it can schedule other writes in the buffer without being blocked.

3.4 Concurrent Access

The lazy-trie design does not require tree re-balancing operations, simplifying concurrent access. Because walks down the tree diverge exponentially fast, gains from concurrent access can be significant.

3.4.1 Tree-Walk Parallelism

Locating the leaf node does not change the trie structure, while insertion or deletion only makes changes starting from a leaf node. We assign a reader-writer lock to each tree node to control any access that goes through that node.

First consider lookup operations. For each node visited on the path to the leaf node, a thread acquires the read lock. Knowing that once the thread holds a read lock, no concurrent updates can happen to the node or any node below, it is safe for the thread to release the lock on the parent node, allowing concurrent updates to other parts of the trie.

In theory, insertions could also obtain read locks the same as lookups, until the thread needs to update a node. At that time, the thread would have to upgrade its read lock to a write lock. In practice, Rust does support an upgradable reader-writer lock, but it allows at most one thread to hold an upgradable read lock at a time (while other threads may concurrently hold a regular read lock). The lock also supports a downgrade operation that converts an upgradable read lock into a regular read lock. We use it as follows: insertion proceeds as lookups but obtaining upgradable read locks. As soon as the thread determines that it will not need to update the node, it downgrades the lock before attempting to get an upgradable read lock on the next node down the path.

Deletion is more complex as it may remove a path that is being followed by other concurrent threads. CedrusDB assumes deletions are much less frequent than other operations. Based on this assumption, a thread performing a delete operation obtains write locks for the entire path, ruling out some concurrent access.

3.4.2 Fast Node Lock

The idiomatic way in Rust to add a lock to a type is `RwLock<T>`, a wrapper around type `T`. Because CedrusDB trie nodes are memory-mapped, we cannot use this facility directly. We maintain a `RwLock<()>` within every trie node (see Figure 8), wasting a negligible amount of space in the

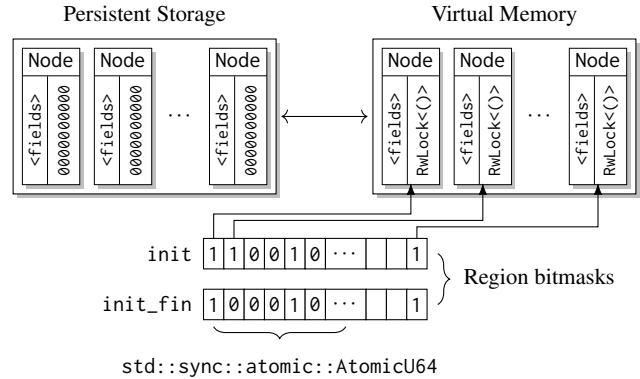

Figure 10: Implementation of trie node locks.

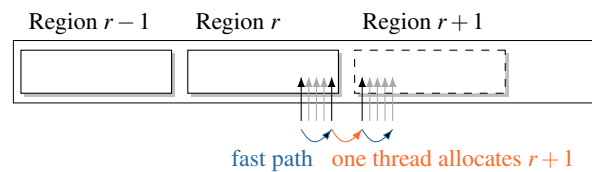

Figure 11: Using CAS operations to maintain logical space.

node (which is dominated by the table of child pointers), but need a way to initialize the locks after mapping their space from disk.

The lock objects are initialized on-the-fly as threads try to obtain them. We maintain two bitmaps with each region, each with one bit per trie node. For a region size of 16MBytes full of 256-child tree nodes, less than 2KBytes is needed for the bitmaps. `init_fin` indicates whether the corresponding lock is initialized. `init` indicates whether some thread is in the process of initializing the lock. The bitmaps are implemented by a fixed-length array of 64-bit atomic variables so that query and modification can be performed atomically using bit operations. We hide this fast node lock facility from other parts of the system, behind a safe interface.

3.4.3 Optimistic Logical Space Maintenance

The logical space could be another performance bottleneck for concurrent insertions, because its tail pointer is frequently written when new objects are pushed to the end of the space. Ideally, Fetch-And-Add (FAA) atomic operations allow updating the pointer concurrently. However, extra care should be taken when the pointer reaches the boundary of the last allocated region. In this case, we need to extend the underlying file or create a new file to ensure accessing the new region will not result in a SIGBUS fault.

We use the Linux `fallocate` system call to manipulate the allocated disk space for a file. To mitigate the overhead of `fallocate`, we grow a file at the granularity of regions. We use a tail pointer to keep track of the boundary of usable

space and increase the pointer to extend the usable space after the new region is ready to be mapped. Since regions are large compared to the contained objects, we use a Compare-And-Swap (CAS) loop to optimistically increase the tail pointer if it advances within the same region for the common case. A busy flag is used to synchronize the threads when a new region needs to be allocated. In this slower case, only one thread will extend the file and move the tail pointer forward to the next region, while other threads will yield and continue to the next iteration of the CAS loop. There might be threads holding some stale view of the tail pointer referring to some previous region; we avoid possible ABA problems with careful checks. Figure 11 describes how to optimistically grow logical space at a high-level.

4 Evaluation

We evaluate the implementation of CedrusDB in order to answer the following questions:

- How does branching factor of a lazy-trie affect its performance? Which value of sluggishness should one choose? Is 256-bit practical enough for hashing? (§4.2.1, §4.2.2)
- What is the performance for various types of CedrusDB operations? Is it practical enough compared to other stores? (§4.2.3)
- How does performance degrade when user data cannot fit entirely in memory? What is the impact of the region size? (§4.2.4) What is the performance of data space allocator and what is the overall storage footprint? (§4.2.5)
- How well does CedrusDB perform under various kinds of realistic workloads? How well does it leverage concurrency? (§4.3)

4.1 Setup

Unless otherwise noted, we use Dell R340 servers to conduct our experiments. The machine has a hexa-core Intel Xeon E-2176G 3.70GHz CPU with 64GB DDR4 memory. For the secondary storage medium, we use Intel Optane 905P SSD with PCIe NVMe 3.0×4 interface. All evaluations are done on Ubuntu 18.04 LTS with a dedicated ext4 filesystem for persistent files. We allow asynchronous writes in all stores. For most experiments, the whole data set can fit into the memory.

We use LMDB 0.9.23 and RocksDB 6.1.2 as baselines and also compare against LevelDB 1.20 in some experiments. In RocksDB, we enable the additional cache feature by setting the LRU cache to 50GB. CedrusDB also uses a 50GB LRU cache to determine which region to swap out to make space for the newly accessed regions. LMDB requires knowing the maximum data store size upon its creation to preallocate the storage space, so we also use the same limit for it. Data compression is disabled for a fairer comparison.

For most microbenchmarks, we use 32-byte keys and 128-byte values. In the graphs with error bars, we run the same

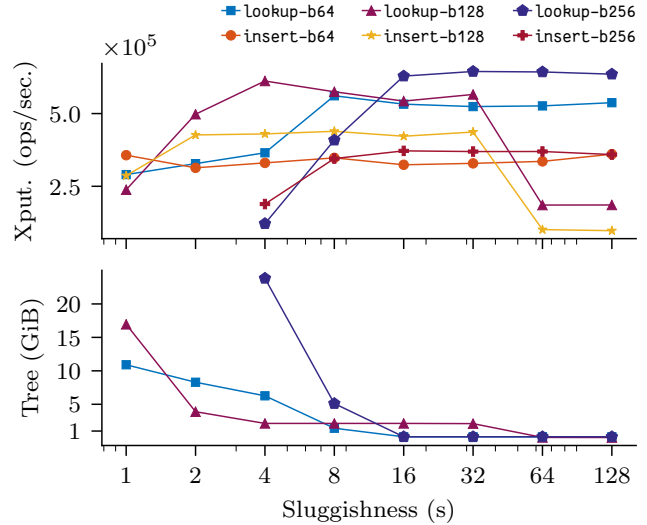

Figure 12: Lookup/insertion throughput (Xput.) and the tree footprint with different branching factors and sluggishness.

setup for 5 times and plot the mean in y-axis with standard deviation bars. For macrobenchmarks, we evaluate CedrusDB using YCSB [11]. YCSB is written in Java whereas CedrusDB is in Rust and the other key-value stores are in C or C++. To avoid overhead caused by incompatible interfacing, we created a C binding for CedrusDB and invoke the APIs from a unified C++ test program dedicated to executing the YCSB workload. For each run, we populate the data store with a certain number of key-value items before running the test workload. The data store is reopened when the test starts. Finally, for multi-threaded experiments, we run a separate YCSB workload generator for each thread in such a way that a thread only handles keys that were preloaded or keys that were inserted by the thread itself.

4.2 Microbenchmarks

4.2.1 Branching Factor and Sluggishness

There are two parameters required to instantiate a lazy-trie: the tree branching factor and sluggishness, together determining the shape of the tree and its statistical characteristics. In Figure 12, we use branching factors 64, 128, and 256. We vary the sluggishness from 1 (no sluggishness) to 128. For each run, a data store of 100 million items is used to perform 10 million uniformly random lookups or insertions.

As discussed in Section 2.3, we expect that a larger branching factor will make the efficacy of sluggishness more pronounced as having more slots in the child table leads to higher storage overhead and amplification. Indeed, we see that for a branching factor of 256, sluggishness significantly improves performance. Data points for $s < 4$ are not shown in the graphs because those runs end up with a tree footprint that exceeds the memory of our platform. Compared to (32+128)-byte key-values, each tree node with 256 children slots takes up

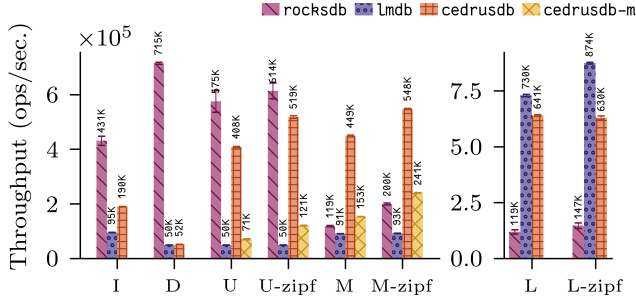

Figure 13: Microbenchmark with 10^8 items and 10^7 operations (single-threaded).

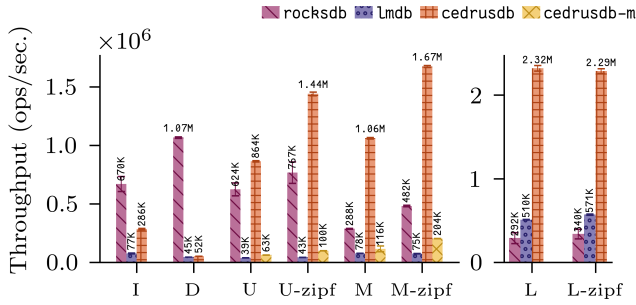

Figure 14: Concurrent microbenchmark with 10^8 items and 10^7 operations (4 threads).

around 2KBytes of space. By having more sluggishness, storage overhead is greatly mitigated and both lookup and insertion performance ramp up to reach or surpass those of other branching factors. When increasing sluggishness from 4 to 16, the memory footprint gets cut down from more than 23GBytes to 144MBytes.

When using a branching factor of 64, each tree node only takes around 512 bytes and it requires a lower sluggishness for comparable performance. On the other hand, because the data store can be fully cached in memory, the choice of branching factor does not significantly affect the maximum performance due to the low cost of memory access. To reduce the tree height and have the best lookup performance, we use a branching factor of 256 with sluggishness of 16 as a practical choice for all subsequent experiments.

4.2.2 Hash Length

In the prior experiments, we used 256-bit HighwayHash to hash the keys. HighwayHash also provides 64- and 128-bit hashing. While generating a shorter hash is faster, it increases the collision rate, amplifying the cost of scanning the linked list of data nodes. We experimented with all three hash lengths but found no difference in performance. We use 256-bit hashes for the remainder of the evaluation.

4.2.3 Throughput

We examine the performance of a read-only workload with a single client thread. We populate the store with 100 million

items and conduct 10 million uniformly random (L) or zipfian (L-zipf) reads. The right graph of Figure 13 shows that, using a single thread, LMDB outperforms CedrusDB, especially when reads have more locality (zipfian distribution). This is partly explained because CedrusDB requires hashing and scanning in the sluggish leaf list for each lookup. Moreover, for zipfian workloads, hashing in CedrusDB eliminates locality. However, shown on the right of Figure 14, CedrusDB significantly outperforms all key-value stores for concurrent lookup access with 4 client threads.

LSM-based key-value stores like RocksDB are optimized for write-only workloads. In Figure 13, we test 10 million pure insertions (I), deletions (D) or updates (U) with uniformly distributed keys. Additionally, we tested updates with a zipfian distribution (U-zipf) and a very write-intensive mixed workload with 50% lookups + 50% updates (M and M-zipf). As expected, RocksDB is significantly faster than LMDB for write-intensive operations.

CedrusDB has two kinds of updates: (i) in-place updates (as used in LMDB by default) when the new value can fit into the footprint of the current one, and (ii) emulated updates that remove the current value and insert the new one. We instrumented CedrusDB so we could test both individually. cedrusdb shows in-place update performance and cedrusdb-m shows the performance when all updates are treated as deletions followed by insertions. Unsurprisingly, in-place updates are fastest since they do not alter the tree topology. Insertions are faster than updates because the latter engages the data space allocator frequently to recycle data nodes. The current implementation of CedrusDB uses a mutex lock for the data space allocator that becomes a performance bottleneck in the concurrent setup, whereas the allocator for the trie space is wait-free. The performance of deletions is the lowest because they require frequent access to the data space allocator and also change the tree topology. Nonetheless, in these experiments CedrusDB is faster than LMDB.

4.2.4 Elastic Memory and Regions

While CedrusDB is optimized for the case that the entire data store fits within a given memory budget, the region-based mapping design of CedrusDB allows a larger data store. In this section we evaluate how performance degrades as CedrusDB runs out of the memory budget. We started with a baseline experiment using 100 million data items that did not have a memory budget, so the data store could utilize all the memory. We recorded the maximum number of regions and used that as the memory budget. We then experimented with 0%–50% of additional user data to see how performance changes.

Figure 15 shows lookup performance for region sizes ranging from 64KBytes (lookup16, 16-bit) to 16MBytes (lookup24, 24-bit). The figure that shows having larger region size results in better performance when all data fit in memory,

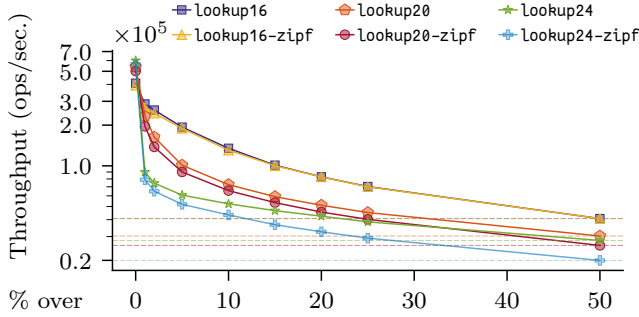

Figure 15: Read performance for different region sizes, with user data beyond the memory budget.

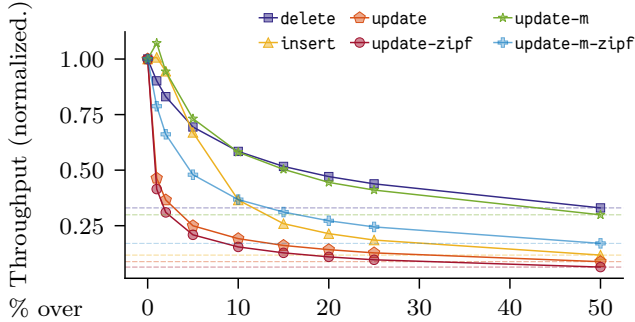

Figure 16: Normalized write performance with user data beyond the memory budget.

but degrades quickly when data exceeds the memory budget. When the whole data set fits in memory (0%), small region sizes hurt performance because there is more overhead for managing regions and their mapping. For large region sizes, the coarse granularity of mappings make it more likely that cold and hot items are collocated in the same region, resulting in increased swapping.

Figure 16 shows the results for write operations. In this figure, each line is normalized to the full memory budget performance. We see that faster operations like updates degrade more than slower ones like deletions, due to the high penalty of swapping compared to in-memory operations.

4.2.5 Variable-Length Values and Fragmentation

So far (and as is common practice in many key-value store evaluations), we used the same length for all values. For CedrusDB, this means that the data space allocator only needs to take one step to find the next-fit location that was previously freed to recycle. When allowing in-place updates, the allocator is not even engaged. Thus, to thoroughly examine our design and effectively evaluate the allocator, we generated a workload that mixes 128/256/1024 values uniformly. We first populated the store with 10 million items. To have each value updated many times on average, we ran 100 million operations with the mixed workload (M), changing the value of each key ~ 5 times throughout the entire run.

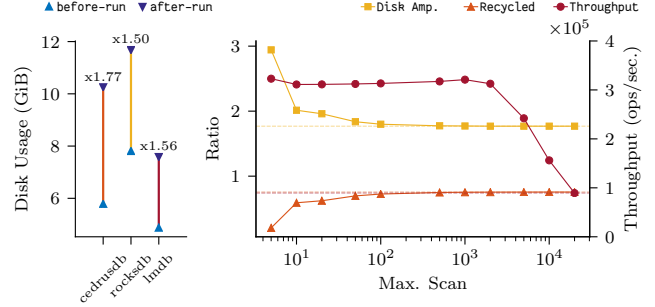

Figure 17: Data space allocator statistics and storage amplification due to fragmentation.

For the next-fit allocator, scanning through the entire free list before giving up is too expensive in practice. Instead of making sure to recycle a freed object whenever possible, allowing some slack in using the free list does not cause significant fragmentation. Therefore we limit the maximum number of steps in scanning the free list during an allocation.

In the right subgraph of Figure 17, we vary the scan step limit (Max. Scan) and show the change of the amplification factor (Disk Amp.) and the ratio of reusing freed space in an allocation (Recycled). The disk amplification factor is the final disk usage divided by the initial one. It is greater than 1 for all stores due to fragmentation. Once the limit exceeds 100 there is little difference compared to having no limit. Moreover, as shown in the left subgraph of Figure 17, we believe the fragmentation ratio of CedrusDB is reasonable compared to other key-value stores.

4.3 Macrobenchmarks

In this section, we evaluate CedrusDB using YCSB [11] workloads with zipfian distributions. We used a region size of 16 MBytes for all experiments.

4.3.1 Single-Threaded Performance

Figure 18 shows single-threaded throughput for different read/write ratios using 128-byte values; Figure 19 shows the same for 1KByte values. The data store is populated with 100 million keys. Two types of write operations are considered: updating the value of an existing key and to insert a value with a non-existing key. Although both use the same API, they trigger different code paths (as demonstrated in our microbenchmarks). The upper left graph shows results from runs where all writes are updates whereas the lower left shows insertions; in the right subgraph, all operations are lookups. CedrusDB achieves better performance than other stores in write-intensive mixed workloads. It also outperforms others in read-intensive cases, with the exception that LMDB has the highest throughput for pure lookups using 128-byte values.

To evaluate performance when values have varying sizes, we generated two workloads. In workload A, for each key, the

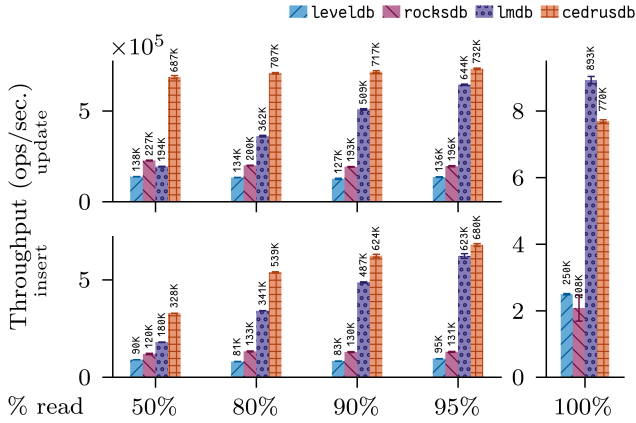

Figure 18: YCSB evaluation with 10^8 128-byte values and operations (single-threaded).

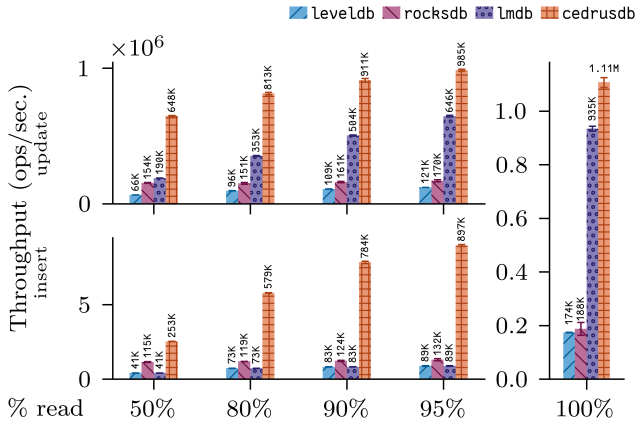

Figure 19: YCSB evaluation with 10^7 1024-byte values and operations (single-threaded).

value is 128, 256 or 1024 bytes chosen uniformly at random. This illustrates a scenario in which the key-value store has items with only a few but very different sizes. On the other hand, Workload B considers a scenario where most values have a similar size. The values are chosen between 128 and 256 bytes with zipfian distribution. Both workloads are run using 100 million mixed lookup/update operations given 10 million initial items. CedrusDB achieves better performance than others for read-intensive cases in both workloads (Figure 20), while it degrades faster with more updates. This is because variable-length values may not be updated in-place and thus trigger intensive access to the data space allocator. On the other hand, as shown at the bottom of Figure 20, even in the most write-intensive case the increase of disk usage caused by fragmentation of CedrusDB remains reasonable.

4.3.2 Concurrent Performance

Next we evaluate multi-threaded performance. Both LMDB and RocksDB have specific optimizations to take advantage of concurrency [12, 13]. Our lazy-trie requires no re-organization

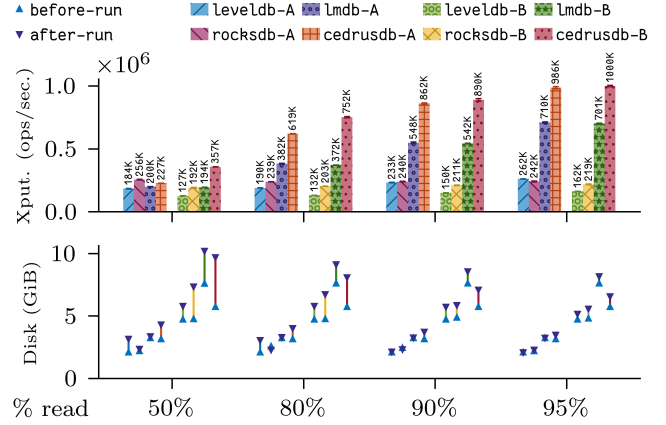

Figure 20: YCSB variable-length throughput (Xput.) with 128/256/1024 (*-A) or 128-256 (*-B) byte values (single-threaded).

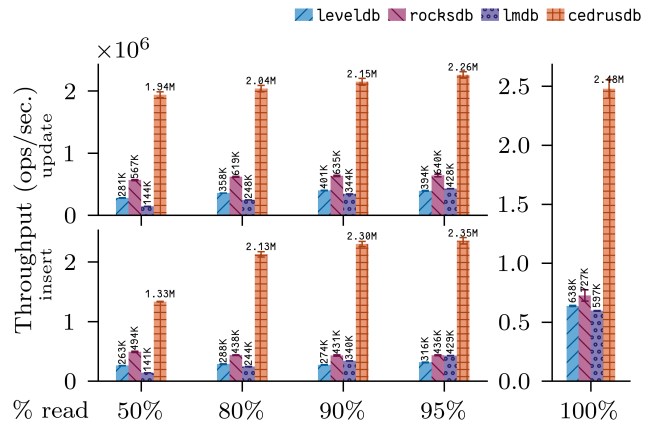

Figure 21: YCSB evaluation with 10^8 128-byte values and operations (4 threads).

when keys are inserted or deleted, simplifying concurrent access. Figure 21 shows the aggregated throughput when 4 client threads access the data store at the same time. CedrusDB outperforms others in all workloads.

To test the scalability in the number of threads, we conducted the same experiments on an Amazon AWS r5d.8xlarge instance. We used one NVMe SSD and run 80%–90% read and 20%–10% update/insert workloads with a varying number of client threads. Figure 22 shows that CedrusDB scales near-linearly until it hits the read lock bottleneck at 8 threads with throughputs between 2 and 3 million operations per second. When it does, it outperforms RocksDB by a factor of 3–5 and LMDB by over 10 times.

5 Related Work

Various prior systems have looked into better leveraging available memory to speed up performance of key-value stores. SILT [29] has a pipeline of three data structures to improve memory-efficiency and write-friendliness. LMDB [14]

is a popular open-source key-value store that leverages a memory-mapped, copy-on-write B⁺-tree. CedrusDB’s usage of memory-mapped storage is inspired by LMDB [14]. There are also persistent key-value stores that only keep a fast, concurrent hash table or other indexing data structures in-memory and pipe all writes directly into append-only logs [9, 28, 31, 33]. However, such architectures suffer from significant recovery overhead when a key-value store is restarted.

There has been extensive work to reduce write-amplification in LSM-based persistent key-value stores. RocksDB [8, 20] is a fork of LevelDB improved by developers at Facebook. It provides more features such as multi-threaded compaction and support for transactions. Inspired by skip lists and based on HyperLevelDB [21], PebblesDB [38] proposes the Fragmented LSM data structure, carefully choosing the SSTs during compaction to reduce amplification. LSM-trie [44] uses a static hash-trie merge structure that keeps re-organizing data for more efficient compaction. SuRF [45] uses an LSM design with a trie-based filter to optimize range queries. Accordion [7] improves the memory organization for LSM. Monkey [15] reduces the lookup cost for LSM by allocating memory to filter across different levels, minimizing the number of false positives. Dostoevsky [16] introduces lazy-leveling to remove superfluous merging. mLSM [39] is tailored for blockchain applications and significantly improves the performance of the Ethereum storage subsystem.

There are also recent proposals to combine LSM and B⁺-tree designs. Jungle [2] reduces update cost without sacrificing lookup cost in LSM using a B⁺-tree. SLM-DB [24] assumes persistent memory hardware. It uses a B⁺-tree for indexing and stages insertions to LSM.

Existing storage data structures have evolved in response to changes in hardware. wB⁺-tree [10] reduces transaction logging overhead for a B⁺-tree in non-volatile main memory. LB⁺-tree [30] optimizes the index performance using 3DX-Point persistent memory. S3 [46] uses an in-memory skip-list index for a customized version of RocksDB in Alibaba Cloud. RECIPE [26] offers a principled way to convert concurrent indexes on DRAM to the one on persistent-memory with crash-consistency.

Like CedrusDB, other systems have embraced the trie for in-memory indexes. ART [27] uses a radix tree, also compresses the non-diverging paths. HOT [6] uses an adaptive number of children for each node. Compared to these in-memory indexes, there are several major differences: (1) CedrusDB is designed to be persistent and has optimized lazy-trie for an on-disk index; for example, lazy-trie tree nodes have a fixed number of slots in their child table to improve persistent storage performance. (2) To ensure near-optimal tree height like a B⁺-tree, instead of directly using key strings to index the trie, lazy-trie uses fixed-length hashes, having different statistical properties. (3) In addition to path compression, lazy-trie employs sluggish splitting to reduce variance

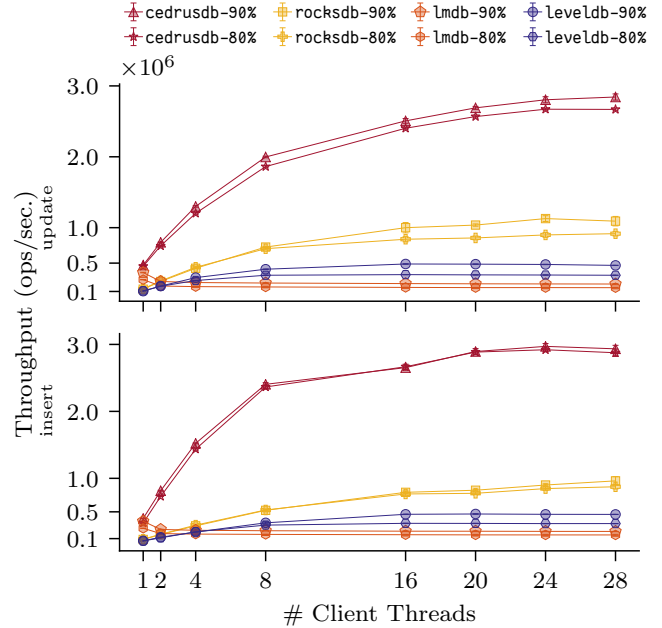

Figure 22: Concurrent YCSB evaluation with 10^8 128-byte values and operations (AWS NVMe SSD).

in tree height, making the tree storage footprint practical and even lower than that for a B⁺-tree.

6 Conclusion

In this paper, we propose a novel data structure, lazy-trie, for indexing on persistent storage. Lazy-trie has similar structural properties as a B⁺-tree and achieves comparable single-threaded lookup speed. Unlike a B⁺-tree, its maintenance does not require reorganization of the tree structure when items are inserted and therefore offers significant improvement in write throughput.

To demonstrate the advantages of the lazy-trie, we built CedrusDB, a memory-mapped persistent key-value store. With comparable storage overhead, CedrusDB outperforms popular LSM- and B⁺-tree-based key-value stores in mixed workloads. The persistent lazy-trie index also has significant advantages for concurrent access when mapped in virtual memory.

We are currently looking into various future directions. First, the data space allocator is a major source of fragmentation and can be improved. Second, the lazy-trie is indexed by key hashes, but improving locality may enable using CedrusDB when the data set that cannot reside mostly in memory. Finally, we are considering a copy-on-write version of the lazy-trie data structure to eliminate some node locking (e.g. read locks). A copy-on-write lazy-trie would also support multi-versioning [41], enabling fast snapshots and transaction isolation.

References

- [1] madvise(2) - linux manual page. <http://man7.org/linux/man-pages/man2/madvise.2.html>. Accessed: 2020-04-15.
- [2] Jung-Sang Ahn, Mohiuddin Abdul Qader, Woon-Hak Kang, Hieu Nguyen, Guogen Zhang, and Sami Ben-Romdhane. Jungle: Towards dynamically adjustable key-value store by combining lsm-tree and copy-on-write b+-tree. In Daniel Peek and Gala Yadgar, editors, *11th USENIX Workshop on Hot Topics in Storage and File Systems, HotStorage 2019, Renton, WA, USA, July 8-9, 2019*. USENIX Association, 2019.
- [3] Jyrki Alakuijala, Bill Cox, and Jan Wassenberg. Fast keyed hash/pseudo-random function using simd multiply and permute, 2016.
- [4] Brian Anderson, Lars Bergstrom, Manish Goregaokar, Josh Matthews, Keegan McAllister, Jack Moffitt, and Simon Sapin. Engineering the servo web browser engine using rust. In Laura K. Dillon, Willem Visser, and Laurie Williams, editors, *Proceedings of the 38th International Conference on Software Engineering, ICSE 2016, Austin, TX, USA, May 14-22, 2016 - Companion Volume*, pages 81–89. ACM, 2016.
- [5] Anirudh Badam, KyoungSoo Park, Vivek S. Pai, and Larry L. Peterson. Hashcache: Cache storage for the next billion. In Jennifer Rexford and Emin Gün Sirer, editors, *Proceedings of the 6th USENIX Symposium on Networked Systems Design and Implementation, NSDI 2009, April 22-24, 2009, Boston, MA, USA*, pages 123–136. USENIX Association, 2009.
- [6] Robert Binna, Eva Zangerle, Martin Pichl, Günther Specht, and Viktor Leis. HOT: A height optimized trie index for main-memory database systems. In Gautam Das, Christopher M. Jermaine, and Philip A. Bernstein, editors, *Proceedings of the 2018 International Conference on Management of Data, SIGMOD Conference 2018, Houston, TX, USA, June 10-15, 2018*, pages 521–534. ACM, 2018.
- [7] Edward Bortnikov, Anastasia Braginsky, Eshcar Hillel, Idit Keidar, and Gali Sheffi. Accordion: Better memory organization for LSM key-value stores. *PVLDB*, 11(12):1863–1875, 2018.
- [8] Zhichao Cao, Siying Dong, Sagar Vemuri, and David H.C. Du. Characterizing, modeling, and benchmarking rocksdb key-value workloads at facebook. In *18th USENIX Conference on File and Storage Technologies (FAST 20)*, pages 209–223, Santa Clara, CA, February 2020. USENIX Association.
- [9] Badrish Chandramouli, Guna Prasaad, Donald Kossmann, Justin J. Levandoski, James Hunter, and Mike Barnett. FASTER: A concurrent key-value store with in-place updates. In Gautam Das, Christopher M. Jermaine, and Philip A. Bernstein, editors, *Proceedings of the 2018 International Conference on Management of Data, SIGMOD Conference 2018, Houston, TX, USA, June 10-15, 2018*, pages 275–290. ACM, 2018.
- [10] Shimin Chen and Qin Jin. Persistent b+-trees in non-volatile main memory. *PVLDB*, 8(7):786–797, 2015.
- [11] Brian F. Cooper, Adam Silberstein, Erwin Tam, Raghu Ramakrishnan, and Russell Sears. Benchmarking cloud serving systems with YCSB. In Joseph M. Hellerstein, Surajit Chaudhuri, and Mendel Rosenblum, editors, *Proceedings of the 1st ACM Symposium on Cloud Computing, SoCC 2010, Indianapolis, Indiana, USA, June 10-11, 2010*, pages 143–154. ACM, 2010.
- [12] Symas Corporation. Lmdb: Lightning memory-mapped database manager (lmdb). <http://www.lmdb.tech/doc/>. Accessed: 2020-05-16.
- [13] Symas Corporation. Memtable - facebook/rocksdb wiki. <https://github.com/facebook/rocksdb/wiki/MemTable#concurrent-insert>. Accessed: 2020-05-16.
- [14] Symas Corporation. Symas lightning memory-mapped database. <https://symas.com/lmdb/>. Accessed: 2020-04-15.
- [15] Niv Dayan, Manos Athanassoulis, and Stratos Idreos. Monkey: Optimal navigable key-value store. In Semih Salihoglu, Wenchao Zhou, Rada Chirkova, Jun Yang, and Dan Suci, editors, *Proceedings of the 2017 ACM International Conference on Management of Data, SIGMOD Conference 2017, Chicago, IL, USA, May 14-19, 2017*, pages 79–94. ACM, 2017.
- [16] Niv Dayan and Stratos Idreos. Dostoevsky: Better space-time trade-offs for lsm-tree based key-value stores via adaptive removal of superfluous merging. In Gautam Das, Christopher M. Jermaine, and Philip A. Bernstein, editors, *Proceedings of the 2018 International Conference on Management of Data, SIGMOD Conference 2018, Houston, TX, USA, June 10-15, 2018*, pages 505–520. ACM, 2018.

- [17] Giuseppe DeCandia, Deniz Hastorun, Madan Jampani, Gunavardhan Kakulapati, Avinash Lakshman, Alex Pilchin, Swaminathan Sivasubramanian, Peter Vosshall, and Werner Vogels. Dynamo: amazon’s highly available key-value store. In Thomas C. Bressoud and M. Frans Kaashoek, editors, *Proceedings of the 21st ACM Symposium on Operating Systems Principles 2007, SOSP 2007, Stevenson, Washington, USA, October 14-17, 2007*, pages 205–220. ACM, 2007.
- [18] Redox OS Developers. Redox - your next(gen) os. <https://www.redox-os.org/>. Accessed: 2020-04-15.
- [19] The Rust Project Developers. The rustonomicon: the dark arts of advanced and unsafe rust programming. <https://doc.rust-lang.org/stable/nomicon/>. Accessed: 2020-04-15.
- [20] Siying Dong, Mark Callaghan, Leonidas Galanis, Dhruva Borthakur, Tony Savor, and Michael Strum. Optimizing space amplification in rocksdb. In *CIDR 2017, 8th Biennial Conference on Innovative Data Systems Research, Chaminade, CA, USA, January 8-11, 2017, Online Proceedings*. www.cidrdb.org, 2017.
- [21] Robert Escriva. Inside hyperleveldb. <https://hackingdistributed.com/2013/06/17/hyperleveldb/>. Accessed: 2020-04-20.
- [22] Nabil Hachicha. Snappydb: a fast and lightweight key/value database library for android. <https://www.snappydb.com/>. Accessed: 2020-04-15.
- [23] Mark S Johnstone and Paul R Wilson. The memory fragmentation problem: Solved? *ACM Sigplan Notices*, 34(3):26–36, 1998.
- [24] Olzhas Kaiyrakhmet, Songyi Lee, Beomseok Nam, Sam H. Noh, and Young-ri Choi. SLM-DB: single-level key-value store with persistent memory. In Arif Merchant and Hakim Weatherspoon, editors, *17th USENIX Conference on File and Storage Technologies, FAST 2019, Boston, MA, February 25-28, 2019*, pages 191–205. USENIX Association, 2019.
- [25] Donald Ervin Knuth. *The Art of Computer Programming, Volume 1: Fundamental Algorithms*, volume 1. Pearson Education, 1997.
- [26] Se Kwon Lee, Jayashree Mohan, Sanidhya Kashyap, Taesoo Kim, and Vijay Chidambaram. Recipe: converting concurrent DRAM indexes to persistent-memory indexes. In Tim Brecht and Carey Williamson, editors, *Proceedings of the 27th ACM Symposium on Operating Systems Principles, SOSP 2019, Huntsville, ON, Canada, October 27-30, 2019*, pages 462–477. ACM, 2019.
- [27] Viktor Leis, Alfons Kemper, and Thomas Neumann. The adaptive radix tree: Artful indexing for main-memory databases. In Christian S. Jensen, Christopher M. Jermaine, and Xiaofang Zhou, editors, *29th IEEE International Conference on Data Engineering, ICDE 2013, Brisbane, Australia, April 8-12, 2013*, pages 38–49. IEEE Computer Society, 2013.
- [28] Baptiste Lepers, Oana Balmau, Karan Gupta, and Willy Zwaenepoel. Kvell: the design and implementation of a fast persistent key-value store. In Tim Brecht and Carey Williamson, editors, *Proceedings of the 27th ACM Symposium on Operating Systems Principles, SOSP 2019, Huntsville, ON, Canada, October 27-30, 2019*, pages 447–461. ACM, 2019.
- [29] Hyeontaek Lim, Bin Fan, David G. Andersen, and Michael Kaminsky. SILT: a memory-efficient, high-performance key-value store. In Ted Wobber and Peter Druschel, editors, *Proceedings of the 23rd ACM Symposium on Operating Systems Principles 2011, SOSP 2011, Cascais, Portugal, October 23-26, 2011*, pages 1–13. ACM, 2011.
- [30] Jihang Liu, Shimin Chen, and Lujun Wang. Lb+-trees: Optimizing persistent index performance on 3dpoint memory. *PVLDB*, 13(7):1078–1090, 2020.
- [31] Yandong Mao, Eddie Kohler, and Robert Tappan Morris. Cache craftiness for fast multicore key-value storage. In Pascal Felber, Frank Bellosa, and Herbert Bos, editors, *European Conference on Computer Systems, Proceedings of the Seventh EuroSys Conference 2012, EuroSys ’12, Bern, Switzerland, April 10-13, 2012*, pages 183–196. ACM, 2012.
- [32] Leonardo Mármol, Jorge Guerra, and Marcos K. Aguilera. Non-volatile memory through customized key-value stores. In Nitin Agrawal and Sam H. Noh, editors, *8th USENIX Workshop on Hot Topics in Storage and File Systems, HotStorage 2016, Denver, CO, USA, June 20-21, 2016*. USENIX Association, 2016.
- [33] Alexander Merritt, Ada Gavrilovska, Yuan Chen, and Dejan S. Milojevic. Concurrent log-structured memory for many-core key-value stores. *PVLDB*, 11(4):458–471, 2017.
- [34] Donald R. Morrison. PATRICIA - practical algorithm to retrieve information coded in alphanumeric. *J. ACM*, 15(4):514–534, 1968.
- [35] Giang Nguyen, Stefan Dlugolinsky, Martin Bobák, Viet D. Tran, Álvaro López García, Ignacio Heredia, Peter Malík, and Ladislav Hluchý. Machine learning and deep learning frameworks and libraries for large-scale data mining: a survey. *Artif. Intell. Rev.*, 52(1):77–124, 2019.

- [36] The nix-rust Project Developers. nix — crates.io: Rust package registry. <https://crates.io/crates/nix>. Accessed: 2020-04-15.
- [37] The GNU Project. Asynchronous i/o (the gnu c library). https://www.gnu.org/software/libc/manual/html_node/Asynchronous-I_002f0.html. Accessed: 2020-04-15.
- [38] Pandian Raju, Rohan Kadekodi, Vijay Chidambaram, and Ittai Abraham. Pebblesdb: Building key-value stores using fragmented log-structured merge trees. In *Proceedings of the 26th Symposium on Operating Systems Principles, Shanghai, China, October 28-31, 2017*, pages 497–514. ACM, 2017.
- [39] Pandian Raju, Soujanya Ponnappalli, Evan Kaminsky, Gilad Oved, Zachary Keener, Vijay Chidambaram, and Ittai Abraham. mlsm: Making authenticated storage faster in ethereum. In Ashvin Goel and Nisha Talagala, editors, *10th USENIX Workshop on Hot Topics in Storage and File Systems, HotStorage 2018, Boston, MA, USA, July 9-10, 2018*. USENIX Association, 2018.
- [40] Zhaoyan Shen, Feng Chen, Yichen Jia, and Zili Shao. Optimizing flash-based key-value cache systems. In Nitin Agrawal and Sam H. Noh, editors, *8th USENIX Workshop on Hot Topics in Storage and File Systems, HotStorage 2016, Denver, CO, USA, June 20-21, 2016*. USENIX Association, 2016.
- [41] Yihan Sun, Guy E. Blelloch, Wan Shen Lim, and Andrew Pavlo. On supporting efficient snapshot isolation for hybrid workloads with multi-versioned indexes. *PVLDB*, 13(2):211–225, 2019.
- [42] The Rust Team. Rust programming language. <https://www.rust-lang.org/>. Accessed: 2020-05-26.
- [43] Sheng Wang, Tien Tuan Anh Dinh, Qian Lin, Zhongle Xie, Meihui Zhang, Qingchao Cai, Gang Chen, Beng Chin Ooi, and Pingcheng Ruan. Forkbase: An efficient storage engine for blockchain and forkable applications. *PVLDB*, 11(10):1137–1150, 2018.
- [44] Xingbo Wu, Yuehai Xu, Zili Shao, and Song Jiang. Lsm-trie: An lsm-tree-based ultra-large key-value store for small data items. In Shan Lu and Erik Riedel, editors, *2015 USENIX Annual Technical Conference, USENIX ATC '15, July 8-10, Santa Clara, CA, USA*, pages 71–82. USENIX Association, 2015.
- [45] Huanchen Zhang, Hyeontaek Lim, Viktor Leis, David G. Andersen, Michael Kaminsky, Kimberly Keeton, and Andrew Pavlo. Surf: Practical range query filtering with fast succinct tries. In Gautam Das, Christopher M. Jermaine, and Philip A. Bernstein, editors, *Proceedings of the 2018 International Conference on Management of Data, SIGMOD Conference 2018, Houston, TX, USA, June 10-15, 2018*, pages 323–336. ACM, 2018.
- [46] Jingtian Zhang, Sai Wu, Zeyuan Tan, Gang Chen, Zhushi Cheng, Wei Cao, Yusong Gao, and Xiaojie Feng. S3: A scalable in-memory skip-list index for key-value store. *PVLDB*, 12(12):2183–2194, 2019.