

Repeated Quantum Games and Strategic Efficiency

Shoto Aoki and Kazuki Ikeda

*Department of Physics, Osaka University,
Toyonaka, Osaka 560-0043, Japan*

E-mail: saoki@het.phys.sci.osaka-u.ac.jp, kazuki7131@gmail.com

ABSTRACT: Repeated quantum game theory addresses long term relations among players who choose quantum strategies. In the conventional quantum game theory, only single round quantum games or at most finitely repeated games have been studied, therefore nothing is known for infinitely repeated quantum game. Investigating infinitely repeated games is crucial since finitely repeated games does not much differ from single round games. In this work we establish the concept of general repeated quantum games and show the Quantum Folk Theorem, which claims that by iterating a game one can find an equilibrium strategy of the game and receive reward that is not obtained by a Nash equilibrium of the corresponding single round quantum game. A significant difference between repeated quantum prisoner's dilemma and repeated classical prisoner's dilemma is that the classical Pareto optimal solution is not always an equilibrium of the repeated quantum game when entanglement is sufficiently strong. In addition we present several concrete equilibrium strategies of the repeated quantum prisoner's dilemma.

Contents

1	Introduction and Summary	1
2	Single Round Quantum Games	2
2.1	Setup	2
2.2	Equilibria	4
2.2.1	Without Entanglement $\theta = 0$	4
2.2.2	Maximally Entangled $\theta = \pi/2$	5
2.2.3	In-between	7
3	Repeated Quantum Games	11
3.1	Setup	11
3.2	Equilibria	13
3.3	Folk Theorem	17
3.3.1	Pure Quantum Strategy	17
3.3.2	Mixed Quantum Strategy	19
4	Conclusion	22

1 Introduction and Summary

In our study on repeated quantum games, we aim at exploring long term relations among players and efficient quantum strategies that may make their payoff maximal and can become equilibria of the repetition of quantum games. The first work of an infinitely repeated quantum game was presented by one of the author in [1] and there are still many open questions on the repeated quantum games. For example the detail of the folk theorem of quantum games has not been explored yet. To investigate more on the quantum game theory, we address an infinitely repeated quantum prisoner's dilemma and show the folk theorem of the repeated quantum game. The main contributions of our work to quantum game are Theorem 3.7 and Theorem 3.8. By Theorem 3.7, we claim that mutual cooperation cannot be an equilibrium when players are maximally entangled and reward for cooperating is not enough. This fact distinguishes a repeated quantum game from a repeated classical game. Note that mutual cooperation is an equilibrium of the classical repeated prisoner's dilemma. By Theorem 3.8, we present the quantum version of the Folk theorem, which assures the existence of equilibrium strategies for any degree of entanglement.

In the sense of classical games, players try to maximize reward by choosing strategies based on opponents' signals obtained by measurement. In a single stage prisoner's dilemma, mutual cooperation is not a Nash equilibrium [2] but a Pareto optimal, however when repetition of the game is allowed, such a Pareto optimal strategy can be an equilibrium of the repeated game. A study on a repeated game aims at finding such a non-trivial equilibrium solution that can be established in a long term relationship. From this viewpoint repeated games play a fundamental role in a fairly large part of the modern economics. Hence repeated quantum games will become important when quantum systems become prevalent in many parts of the near future society.

There are various definitions of quantum game [3, 4] and it is as open to establish the foundation. Indeed, many authors work on quantum games with various motivations [5, 6]. Most of the conventional works on quantum games focus on some single stage quantum games, where each one plays a quantum strategy only one time. However, in a practical situation, a game is more likely played repeatedly, hence it is more meaningful to address repeated quantum games. Repeated games are categorized into (1) finitely repeated games and (2) infinitely repeated games. However, equilibria of finitely repeated games are completely the same as those of single round games. This is also true for at most finitely repeated quantum games [7, 8]. On the other hand, infinitely repeated (classical) games are very different from single stage games and therefore it is important [9, 10]. But nothing has been known for infinitely repeated quantum games.

This work is organized as follows. In Sec.2, we address single round quantum prisoner's dilemma and investigate equilibria of the game. We first prepare terminologies and concepts used for this work. We present novel relations between payoff and entanglement in Sec.2.2. In Sec.3 we establish the concept of a generic repeated quantum game (Definition 3.1) and present some equilibrium strategies (Lemma 3.3 and 3.5). Our main results (3.7 and 3.8) are described in Sec.3.3. This work is concluded in Sec.4.

2 Single Round Quantum Games

2.1 Setup

We consider the quantum prisoner's dilemma (Fig. 1) [3, 4]. Let $|C\rangle, |D\rangle$ be two normalized orthogonal states that represent "Cooperative" and "Defective" states, respectively. Then a general state of the game is a complex linear combination, spanned by the basis vectors $|CC\rangle, |CD\rangle, |DC\rangle, |DD\rangle$. Each player i chooses a unitary strategy U_i and the game is in a state

$$|\psi\rangle = \mathcal{J}^\dagger(U_A \otimes U_B)\mathcal{J}|CC\rangle, \quad (2.1)$$

where \mathcal{J} gives some entanglement. In what follows we use

$$\mathcal{J} = \exp \left[i \frac{\theta}{2} Y \otimes Y \right] = \cos \frac{\theta}{2} + i Y \otimes Y \sin \frac{\theta}{2}, \quad (2.2)$$

where θ represents entanglement and two states become maximally entangled at $\theta = \frac{\pi}{2}$. We assume a quantum strategy of a player i has a representation

$$U_i = \alpha_i I + i(\beta_i X + \gamma_i Y + \delta_i Z) \quad (\alpha_i, \dots, \delta_i \in \mathbb{R}) \quad (2.3)$$

where the coefficients obey $\alpha_i^2 + \dots + \delta_i^2 = 1$.

	Bob:C	Bob:D
Alice:C	(r,r)	(s,t)
Alice:D	(t,s)	(p,p)

Table 1. Pay-off matrix of the prisoner's dilemma. p,r,s and t satisfy $t > r > p > s \geq 0$.

Based on Fig.1, Alice receives payoff $\$A = \langle \psi | \hat{\$}_A | \psi \rangle$, where $\hat{\$}_A$ is her payoff matrix

$$\hat{\$}_A = r |CC\rangle \langle CC| + p |DD\rangle \langle DD| + t |DC\rangle \langle DC| + s |CD\rangle \langle CD|. \quad (2.4)$$

Without loss of generality, we can set $s = 0$. Taking into account of U_A (2.3), the average payoff $\hat{\$}_A = \hat{\$}_A(x_A, x_B)$ of Alice is a function of $x_i = (\alpha_i, \dots, \delta_i)$

$$\begin{aligned} \$A(x_A, x_B) = & r(\alpha_A \alpha_B - \delta_A \delta_B + \sin \theta (\beta_A \gamma_B + \gamma_A \beta_B))^2 \\ & + p(\beta_A \beta_B - \gamma_A \gamma_B + \sin \theta (\alpha_A \delta_B + \delta_A \alpha_B))^2 \\ & + t(\gamma_A \alpha_B + \beta_A \delta_B + \sin \theta (-\alpha_A \beta_B + \delta_A \gamma_B))^2 \\ & + \cos^2 \theta \left(r(\alpha_A \delta_B + \delta_A \delta_B)^2 + p(\beta_A \gamma_B + \gamma_A \beta_B)^2 \right. \\ & \left. + t(\beta_A \alpha_B - \gamma_A \delta_B)^2 \right). \end{aligned} \quad (2.5)$$

Since the game is symmetric for two players, $\$A(x_A, x_B) = \$B(x_B, x_A)$ is satisfied.

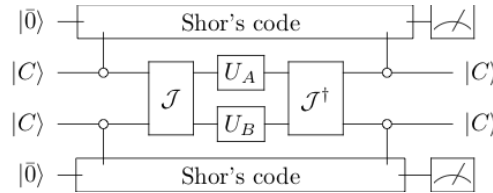

Figure 1. The setup of the quantum game.

Definition 2.1. A quantum strategy U is called pure if a player chooses one from $\{I, X, Y, Z\}$.

Definition 2.2. A quantum strategy U is called mixed if a player choose one from $\{I, X, Y, Z\}$ with some probability.

There are some references which define a pure quantum strategy by a general unitary group (see [11] for example). But as we will show, such a small set $\{I, X, Y, Z\}$ is powerful enough to obtain stronger results compared with classical games.

The classical pure strategic prisoner's dilemma allows players to choose one of $\{I, X\}$ and it becomes a mixed strategy game if the state is written as

$$|\psi\rangle = \sum_{i \in \{CC, CD, DC, DD\}} p_i |i\rangle, \quad (2.6)$$

where p_i is non-negative and satisfy $\sum_i p_i = 1$. Note that for a single round quantum game, a generic state is represented as

$$|\psi\rangle = \sum_{i \in \{CC, CD, DC, DD\}} c_i |i\rangle, \quad (2.7)$$

where c_i is a complex number and a state $|i\rangle$ is measured with the probability $|c_i|^2$. However as long as one considers a single round game, the quantum game is resemble to the classical mixed strategy game, where a strategy is chosen stochastically with a given probability distribution.

Considering repeated quantum games is a way to make quantum games much more meaningful, since transition of quantum states is different from that of classical states. To begin with, we first address single round quantum prisoner's dilemma and equilibria of the game.

2.2 Equilibria

2.2.1 Without Entanglement $\theta = 0$

The case without entanglement corresponds to the classical prisoner's dilemma. Table 2 presents the correspondence between operators and classical actions.

	I	X	Y	Z
I	(C,C)	(C,D)	(C,D)	(C,C)
X	(D,C)	(D,D)	(D,D)	(D,C)
Y	(D,C)	(D,D)	(D,D)	(D,C)
Z	(C,C)	(C,D)	(C,D)	(C,C)

Table 2. Operators and actions for the case without entanglement $\theta = 0$.

Then the strategy is simply a mixed strategy of the pure strategies $\{C, D\}$, therefore average payoff of Alice is

$$\begin{aligned} \$_A &= r(\alpha_A^2 + \delta_A^2)(\alpha_B^2 + \delta_B^2) \\ &\quad + p(\beta_A^2 + \gamma_A^2)(\beta_B^2 + \gamma_B^2) \\ &\quad + t(\beta_A^2 + \gamma_A^2)(\alpha_B^2 + \delta_B^2). \end{aligned} \quad (2.8)$$

As a result, $U_A = i(\beta_A X + \gamma_A Y)$, $U_B = i(\beta_B X + \gamma_B Y)$ is the equilibrium.

2.2.2 Maximally Entangled $\theta = \pi/2$

In contrast to the case without entanglement, the strategy part of the maximally entangled case becomes

$$\mathcal{J}^\dagger(I \otimes X)\mathcal{J} = (I \otimes X)\mathcal{J}^2 = -Y \otimes Z \quad (2.9)$$

$$\mathcal{J}^\dagger(I \otimes Y)\mathcal{J} = I \otimes Y. \quad (2.10)$$

Therefore the correspondence between the operators and actions becomes non-trivial as exhibited in Table 3.

	I	X	Y	Z
I	(C,C)	(D,C)	(C,D)	(D,D)
X	(C,D)	(D,D)	(C,C)	(D,C)
Y	(D,C)	(C,C)	(D,D)	(C,D)
Z	(D,D)	(C,D)	(D,C)	(C,C)

Table 3. Operators and actions for the maximal entangled case $\theta = \frac{\pi}{2}$.

Pure Quantum Strategy We first consider the pure strategy game, where each agent determines and plays one of $\{I, X, Y, Z\}$. The average payoff of Alice is

$$\begin{aligned} \$_A(x_A, x_B) &= r(\alpha_A \alpha_B - \delta_A \delta_B + \beta_A \gamma_B + \gamma_A \beta_B)^2 \\ &\quad + p(\beta_A \beta_B - \gamma_A \gamma_B + \alpha_A \delta_B + \delta_A \alpha_B)^2 \\ &\quad + t(\gamma_A \alpha_B + \beta_A \delta_B - \alpha_A \beta_B + \delta_A \gamma_B)^2. \end{aligned} \quad (2.11)$$

This can be written as

$$\$_A = r(\alpha'_A)^2 + p(\beta'_A)^2 + t(\gamma'_A)^2, \quad (2.12)$$

where

$$\begin{aligned} \alpha'_A &= \alpha_A \alpha_B - \delta_A \delta_B + \beta_A \gamma_B + \gamma_A \beta_B \\ \beta'_A &= \beta_A \beta_B - \gamma_A \gamma_B + \alpha_A \delta_B + \delta_A \alpha_B \\ \gamma'_A &= \gamma_A \alpha_B + \beta_A \delta_B - \alpha_A \beta_B + \delta_A \gamma_B \\ \delta'_A &= \gamma_B \alpha_A + \beta_B \delta_A - \alpha_B \beta_A + \delta_B \gamma_A \end{aligned} \quad (2.13)$$

Note that the equation (2.13) is a coordinate transformation on S^3 , hence there is a $x_A \in S^3$ that makes $\gamma'_A = 1$ for all $x_B \in S^3$. In other words, Alice can find a stronger strategy for any strategy of Bob, and vice versa. Therefore there is no equilibrium for this case. In this sense this looks like "Rock-paper-scissors" .

Mixed Quantum Strategy We can find equilibria when we allow Alice and Bob play mixed quantum strategies. That means Alice chooses a strategy from $\{I, X, Y, Z\}$ with probability $p^A = (p_I^A, p_X^A, p_Y^A, p_Z^A)$. The game will be played with a circuit shown in Fig.2. Alice can execute her strategy U_A in such a way that

$$U_A = \sqrt{p_I^A}I \otimes I + \sqrt{p_X^A}iX \otimes I + \sqrt{p_Y^A}iY \otimes X + \sqrt{p_Z^A}iZ \otimes X \quad (2.14)$$

Then the average payoff of Alice is given by

$$\$A = \begin{pmatrix} p_I^A & p_X^A & p_Y^A & p_Z^A \end{pmatrix} \begin{pmatrix} r & t & s & p \\ s & p & r & t \\ t & r & p & s \\ p & s & t & r \end{pmatrix} \begin{pmatrix} p_I^B \\ p_X^B \\ p_Y^B \\ p_Z^B \end{pmatrix} \quad (2.15)$$

We find that the above form can be written as

$$\begin{aligned} \$A &= rp_I^B + tp_X^B + sp_Y^B + pp_Z^B \\ &+ \begin{pmatrix} p_X^A & p_Y^A & p_Z^A \end{pmatrix} \begin{pmatrix} (r-s)(-p_I^B + p_Y^B) + (t-p)(-p_X^B + p_Z^B) \\ (t-r)(p_I^B - p_X^B) + (p-s)(p_Y^B - p_Z^B) \\ (r-p)(-p_I^B + p_Z^B) + (t-s)(p_Y^B - p_X^B) \end{pmatrix} \end{aligned} \quad (2.16)$$

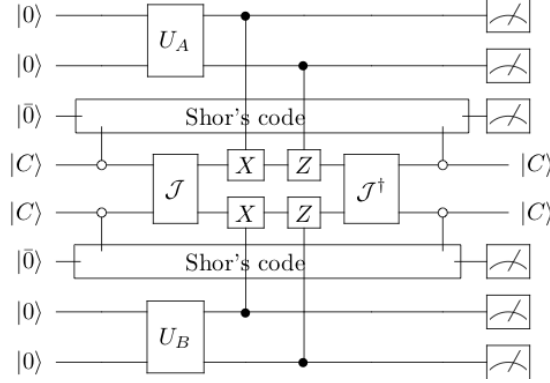

Figure 2. The setup of the mixed quantum game

If $p_I^B = p_X^B = p_Y^B = p_Z^B = \frac{1}{4}$, the average payoff of Alice does not depend on p^A and it becomes

$$\$A = \frac{r + t + s + p}{4}. \quad (2.17)$$

So one of the equilibria is

$$\begin{cases} p^{A*} = \left(\frac{1}{4}, \frac{1}{4}, \frac{1}{4}, \frac{1}{4}\right) \\ p^{B*} = \left(\frac{1}{4}, \frac{1}{4}, \frac{1}{4}, \frac{1}{4}\right) \end{cases} \quad (2.18)$$

In addition, we have another equilibrium.

Proposition 2.3. If $t + s > r + p$, then

$$\begin{cases} p^{A^*} = \left(0, \frac{1}{2}, \frac{1}{2}, 0\right) \\ p^{B^*} = \left(\frac{1}{2}, 0, 0, \frac{1}{2}\right) \end{cases} \quad \text{or} \quad \begin{cases} p^{A^*} = \left(\frac{1}{2}, 0, 0, \frac{1}{2}\right) \\ p^{B^*} = \left(0, \frac{1}{2}, \frac{1}{2}, 0\right) \end{cases} \quad (2.19)$$

is an equilibrium. The average payoff at the equilibrium is $\frac{t+s}{2}$.

Proof. It is enough to show one of (2.19). Using (2.16), we find that the average payoff of Alice respects

$$\$_A(p^A, p^{B^*}) = \frac{r+p}{2} + (p_X^A + p_Y^A) \frac{1}{2} (t - p - r + s) \quad (2.20)$$

$$\leq \frac{t+s}{2} = \$_A(p^{A^*}, p^{B^*}) \quad (2.21)$$

Similarly the average payoff of Bob satisfies

$$\$_B(p^{A^*}, p^B) = \frac{t+s}{2} - (p_X^B + p_Y^B) \frac{1}{2} (t - p - r + s) \quad (2.22)$$

$$\leq \frac{t+s}{2} = \$_B(p^{A^*}, p^{B^*}). \quad (2.23)$$

This ends the proof. \square

Repeating the same discussion, we can show the following statement.

Proposition 2.4. If $t + s < r + p$, then

$$\begin{cases} p^{A^*} = \left(0, \frac{1}{2}, \frac{1}{2}, 0\right) \\ p^{B^*} = \left(0, \frac{1}{2}, \frac{1}{2}, 0\right) \end{cases} \quad \text{or} \quad \begin{cases} p^{A^*} = \left(\frac{1}{2}, 0, 0, \frac{1}{2}\right) \\ p^{B^*} = \left(\frac{1}{2}, 0, 0, \frac{1}{2}\right) \end{cases} \quad (2.24)$$

is an equilibrium. The average payoff at the equilibrium is $\frac{r+p}{2}$.

2.2.3 In-between

Pure Quantum Strategy We consider a general case with entanglement $\theta \in (0, \pi/2)$. Without entanglement $\theta = 0$, both X, Y are always stronger than I , but I is sometimes stronger than X when there is some entanglement. Y is always stronger than I . So in what follows we first assume Bob plays $U_B = Y$, which corresponds to $x_B = (0, 0, 1, 0)$. In this case, the payoff of Alice is

$$\begin{aligned} \$_A(x_A, x_B) &= (r \sin^2 \theta + p \cos^2 \theta) \\ &\quad - (p \cos^2 \theta - (t - r) \sin^2 \theta) \delta_A^2 \\ &\quad - (r - p) \sin^2 \theta \gamma_A^2 \\ &\quad - (r \sin^2 \theta + p \cos^2 \theta) \alpha_A^2. \end{aligned}$$

Note that the first term is always positive, the third and fourth terms are always negative since $r > p > 0$. The second term could be positive if $\sin^2 \theta < \frac{p}{t-r+p}$.

Therefore Alice's best reaction to $U_B = Y$ is $x_A = (\alpha_A, \beta_A, \gamma_A, \delta_A) = (0, 1, 0, 0)$ and the corresponding payoff is

$$\$_A(x_A^*, x_B^*) = r \sin^2 \theta + p \cos^2 \theta. \quad (2.25)$$

Similarly one can find that Bob's best reaction to $x_A = (0, 1, 0, 0)$ is $x_B = (0, 0, 1, 0)$. So the pair of $x_A^* = (0, 1, 0, 0)$ and $x_B^* = (0, 0, 1, 0)$ is an equilibrium since they satisfy

$$\begin{aligned} \$_A(x_A^*, x_B^*) &\geq \$_A(x_A, x_B^*) \\ \$_B(x_A^*, x_B^*) &\geq \$_B(x_A^*, x_B) \end{aligned} \quad (2.26)$$

More generally one can find that

$$\begin{cases} x_A^* = (0, \cos \phi, \sin \phi, 0) \\ x_B^* = (0, \sin \phi, \cos \phi, 0) \end{cases} \quad (2.27)$$

is an equilibrium and the corresponding average payoff of Alice is

$$\$_A(x_A^*, x_B^*) = r \sin^2 \theta + p \cos^2 \theta. \quad (2.28)$$

Equilibrium strategies do not exist if $\sin^2 \theta > \frac{p}{t-r+p}$, which is consistent with our previous discussion that the maximal entanglement $\theta = \frac{\pi}{2}$ case does not have any equilibrium while only pure quantum strategies are played.

Mixed Quantum Strategy In general the average payoff of Alice can be written as

$$\begin{aligned} \$_A &= \begin{pmatrix} p_I^A & p_X^A & p_Y^A & p_Z^A \end{pmatrix} A \begin{pmatrix} p_I^B \\ p_X^B \\ p_Y^B \\ p_Z^B \end{pmatrix} \\ A &= \begin{pmatrix} r & s \cos^2 \theta + t \sin^2 \theta & s & r \cos^2 \theta + p \sin^2 \theta \\ t \cos^2 \theta + s \sin^2 \theta & p & p \cos^2 \theta + r \sin^2 \theta & t \\ t & p \cos^2 \theta + r \sin^2 \theta & p & t \cos^2 \theta + s \sin^2 \theta \\ r \cos^2 \theta + p \sin^2 \theta & s & s \cos^2 \theta + t \sin^2 \theta & r \end{pmatrix} \end{aligned} \quad (2.29)$$

We define

$$\begin{aligned} \bar{t} &= t \cos^2 \theta + s \sin^2 \theta \\ \bar{r} &= r \cos^2 \theta + p \sin^2 \theta \\ \bar{p} &= p \cos^2 \theta + r \sin^2 \theta \\ \bar{s} &= s \cos^2 \theta + t \sin^2 \theta \end{aligned} \quad (2.31)$$

and

$$\begin{aligned} p_I^* &= p_Z^* = \frac{1}{2} \frac{s + \bar{s} - p - \bar{p}}{t + \bar{t} - r - \bar{r} - p - \bar{p} + s + \bar{s}} \\ p_X^* &= p_Y^* = \frac{1}{2} \frac{t + \bar{t} - r - \bar{r}}{t + \bar{t} - r - \bar{r} - p - \bar{p} + s + \bar{s}} \end{aligned} \quad (2.32)$$

Proposition 2.5. $p^A = p^B = p^*$ is an equilibrium

Proof. The equation (2.30) can be decomposed into

$$\begin{aligned} \$A &= \begin{pmatrix} r & \bar{s} & s & \bar{r} \end{pmatrix} \begin{pmatrix} p_I^B \\ p_X^B \\ p_Y^B \\ p_Z^B \end{pmatrix} \\ &+ \begin{pmatrix} p_X^A & p_Y^A & p_Z^A \end{pmatrix} \begin{pmatrix} \bar{t} - r & p - \bar{s} & \bar{p} - s & t - \bar{r} \\ t - r & \bar{p} - \bar{s} & p - s & \bar{t} - \bar{r} \\ \bar{r} - r & s - \bar{s} & \bar{s} - s & r - \bar{r} \end{pmatrix} \begin{pmatrix} p_I^B \\ p_X^B \\ p_Y^B \\ p_Z^B \end{pmatrix} \end{aligned} \quad (2.33)$$

One can show that the second term vanishes at $p^B = p^*$. Therefore $\$A(p^A, p^*) = \$A(p^*, p^*)$ is satisfied for any p^A . Since the same argument is held for Bob's average payoff, $(p^A, p^B) = (p^*, p^*)$ is an equilibrium. \square

In addition, we can find another equilibrium for $t + s > r + p$ and $t + s < r + p$. We first address the case where $t + s > r + p$.

Proposition 2.6. If $t + s > r + p$, the following pairs of (p^A, p^B) are equilibria.

$$\begin{cases} p^{A^*} = \left(0, \frac{1}{2}, \frac{1}{2}, 0\right) \\ p^{B^*} = \left(0, \frac{1}{2}, \frac{1}{2}, 0\right) \end{cases} \quad \left(\sin^2 \theta < \frac{2(p-s)}{t-r+p-s} \right) \quad (2.34)$$

$$\begin{cases} p^{A^*} = \left(\frac{1}{2}, 0, 0, \frac{1}{2}\right) \\ p^{B^*} = \left(0, \frac{1}{2}, \frac{1}{2}, 0\right) \end{cases} \quad \left(\sin^2 \theta > \frac{2(p-s)}{t-r+p-s} \right) \quad (2.35)$$

Proof. We first consider the case where $\sin^2 \theta < \frac{2(p-s)}{t-r+p-s}$ holds. We write $p^{A^*} = p^{B^*} = \left(0, \frac{1}{2}, \frac{1}{2}, 0\right)$. Then Alice's average payoff is

$$\begin{aligned} \$A(p^A, p^{B^*}) &= \frac{1}{2} \left(s \cos^2 \theta + t \sin^2 \theta + s \right) \\ &+ \frac{1}{2} \left(-(t-r) \sin^2 \theta + (p-s)(\cos^2 \theta + 1) \right) (p_X^A + p_Y^A) \end{aligned} \quad (2.36)$$

Note that the second term is positive for $\left(\sin^2 \theta < \frac{2(p-s)}{t-r+p-s}\right)$. Therefore $\$A(p^{A^*}, p^{B^*}) \geq \$A(p^A, p^{B^*})$ for all p^A . In the same way, the average payoff of Bob also respects $\$B(p^{A^*}, p^{B^*}) \geq \$B(p^{A^*}, p^B)$.

For $\sin^2 \theta > \frac{2(p-s)}{t-r+p-s}$, we write $p^{A^*} = (\frac{1}{2}, 0, 0, \frac{1}{2})$, $p^{B^*} = (0, \frac{1}{2}, \frac{1}{2}, 0)$. Then the average payoff of Alice is exactly the same as (2.36). Since $\sin^2 \theta > \frac{2(p-s)}{t-r+p-s}$, the second term of (2.36) is negative. Hence it becomes maximal for $p_X^A = p_Y^A = 0$, namely $\$_A(p^{A^*}, p^{B^*}) \geq \$_A(p^A, p^{B^*})$ for all p^A . The average payoff of Bob is

$$\begin{aligned} \$_B(p^{A^*}, p^B) &= \frac{1}{2} (r \cos^2 \theta + p \sin^2 \theta + r) \\ &\quad + \frac{1}{2} (-(p-s) \sin^2 \theta + (t-r)(\cos^2 \theta + 1))(p_X^B + p_Y^B) \end{aligned} \quad (2.37)$$

Since $t+s > r+p$, the second term is always positive. Therefore $\$_B(p^{A^*}, p^{B^*}) \geq \$_B(p^{A^*}, p^B)$ for all p^B . This ends the proof. \square

Note that for $\sin^2 \theta > \frac{2(p-s)}{t-r+p-s}$ and at the equilibrium, the average payoff of Alice is smaller than that of Bob: $\$_A(p^{A^*}, p^{B^*}) < \$_B(p^{A^*}, p^{B^*})$.

In summary, the average payoff of Alice is exhibited in Fig.3.

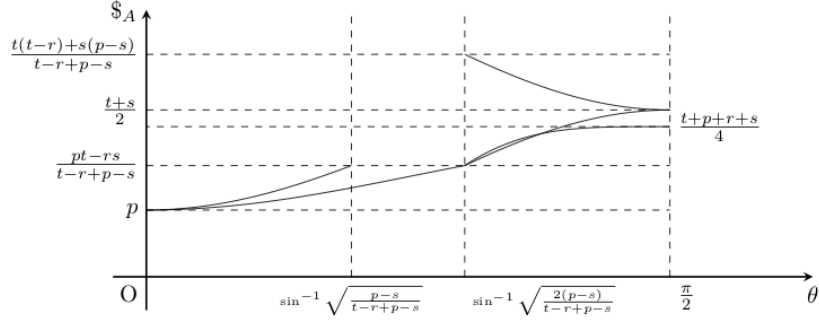

Figure 3. The average payoff of Alice at the Nash equivalent, when $t+s > r+p$

We next consider the case where $t+s < r+p$. One can show the following statement as we did before.

Proposition 2.7. If $t+s < r+p$, the following pairs of (p^A, p^B) are equilibria.

$$\begin{cases} p^{A^*} = (0, \frac{1}{2}, \frac{1}{2}, 0) \\ p^{B^*} = (0, \frac{1}{2}, \frac{1}{2}, 0) \end{cases} \quad \left(0 \leq \theta \leq \frac{\pi}{2}\right) \quad (2.38)$$

$$\begin{cases} p^{A^*} = (\frac{1}{2}, 0, 0, \frac{1}{2}) \\ p^{B^*} = (\frac{1}{2}, 0, 0, \frac{1}{2}) \end{cases} \quad \left(\sin^2 \theta > \frac{2(t-r)}{t-r+p-s}\right) \quad (2.39)$$

Since $1 < \frac{2(p-s)}{t-r+p-s}$ is always true, they satisfy $\sin^2 \theta < \frac{2(p-s)}{t-r+p-s}$. Therefore (2.38) is an equilibrium for all θ . In summary, the average payoff of Alice is exhibited in Fig.4 and 5.

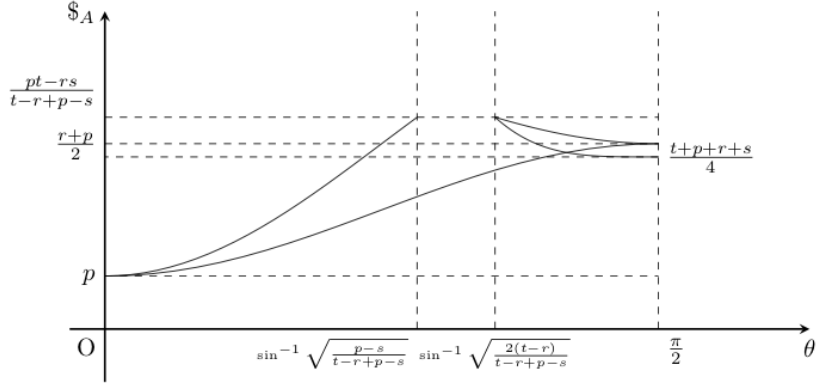

Figure 4. The average payoff of Alice at the Nash equivalent, when $t + s < r + p$ and $2(t - r) > p - s$.

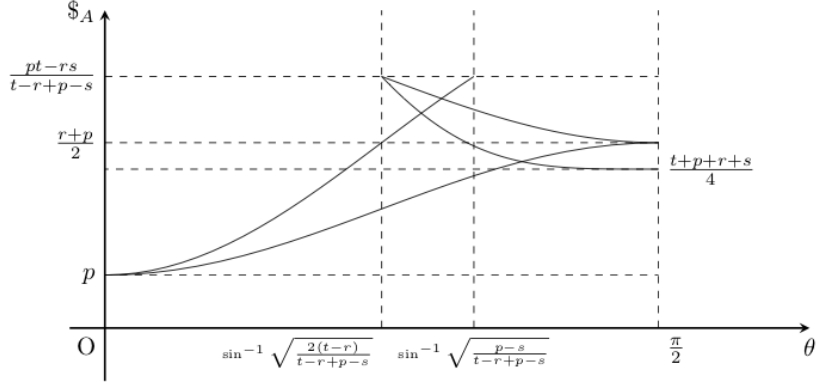

Figure 5. The average of Alice's payoff at the Nash equivalent, when $t + s < r + p$ and $2(t - r) < p - s$.

3 Repeated Quantum Games

3.1 Setup

A generic repeated quantum game is summarized as follows.

Definition 3.1 (Repeated Quantum Game). Let $\{\tau_i\}_{i=1,2,\dots}$ be a set of positive integers and $\{|\psi^t\rangle\}_{t=0,1,\dots}$ be a family of quantum states. For each i , put $t_i = \sum_k^i \tau_k$. Let $\{|i\rangle\}_i$ be an orthonormal basis and $\{c_i\}_i$ be a set of complex numbers such that $\sum_i |c_i|^2 = 1$. With respect to each $|i\rangle$, suppose that reward to a player n is given by a certain operator $\hat{\$}_n$ in such a way that $\langle i | \hat{\$}_n | i \rangle$ and $\langle i | \hat{\$}_n | j \rangle = 0$ for $i \neq j$. Then a general N -persons quantum repeated game proceeds as follows:

1. At any t , the game is in a state

$$|\psi^t\rangle = \sum_i c_i |i\rangle, \quad (3.1)$$

2. The time-evolution of the game is given by unitary operators U^t

$$|\psi^{t+1}\rangle = U^t |\psi^t\rangle \quad (3.2)$$

3. At time $t = t_i$, reward is evaluated and given to players n by a

$$\mathbb{S}_n^{t_i} = f(\tau_i) \langle \psi^{t_i} | \hat{\mathbb{S}}_n | \psi^{t_i} \rangle, \quad (3.3)$$

where $f(\tau_i)$ is a function such that $f(1) = 1$.

4. The total payoff of a player n at time $t \in [t_k, t_{k+1})$ is defined by

$$\mathbb{S}_n(t) = \sum_i^k \delta^{t_i} \mathbb{S}_n^{t_i} \quad (3.4)$$

and in the limit it is $\mathbb{S}_n = \lim_{t \rightarrow \infty} \mathbb{S}_n(t)$.

Now let us consider the repeated quantum prisoner's dilemma. Let $|\psi^t\rangle \in \mathcal{H}_A \otimes \mathcal{H}_B$ be a state at the t th round. Let $\{\tau_i\}_{i=1,2,\dots}$ be a set of positive integers. We assume measurement of quantum states is done at the end of the $t_i = \sum_{k=1}^i \tau_k$ round for each i . For example, $\tau_i = 1$ for all i means we measure quantum states every round. Suppose $V^{\tau_{i-1}+1}, \dots, V^{\tau_i}$ are operators of Alice, then her strategy is $U_A^{t_i} = V_A^{\tau_{i-1}+1} \otimes \dots \otimes V_A^{\tau_{i-1}+\tau_i}$ and the game is in a state

$$|\psi^{t_i}\rangle = \mathcal{J}^\dagger (U_A^{t_i} \otimes U_B^{t_i}) \mathcal{J} |\psi^{t_{i-1}}\rangle \quad (3.5)$$

which should be measured at the end of t_i round. The payoff could depend on τ_i :

$$\mathbb{S}_A^{t_i} = f(\tau_i) \langle \psi^{t_i} | \hat{\mathbb{S}}_A | \psi^{t_i} \rangle, \quad (3.6)$$

where $f(\tau_i)$ is a certain function of τ_i . In repeated games, the total payoff is written with discount factor $\delta \in (0, 1)$ and in our case it can be introduced in such a way that

$$\mathbb{S}_A = \sum_i \delta^{t_i} \mathbb{S}_A^{t_i}. \quad (3.7)$$

An interpretation of the discount factor is that the importance of the future payoffs decreases with time. The measurement periods $\{\tau_i\}$ can be defined randomly or predeterminedly. When game's state is measured every round, the probability of monitoring signals is classical (see (2.14)). In order to enjoy full quantum games, a game should evolve with unitary operation.

Since this work is the first study on infinitely repeated quantum games, we focus on the most fundamental case and investigate a role of entanglement. We will work on a generic case elsewhere. For this purpose, in what follows, we put $\tau_i = 1$ for all i and $f(1) = 1$. Then the game evolves in such a way that

$$|\psi^{t+1}\rangle = \mathcal{J}^\dagger (U_A^t \otimes U_B^t) \mathcal{J} |\psi^t\rangle, \quad (3.8)$$

where U_A^t is her quantum strategy for the t th round. Then her average payoff is

$$\mathbb{S}_A^t = \langle \psi^t | \hat{\mathbb{S}}_A | \psi^t \rangle. \quad (3.9)$$

3.2 Equilibria

We define a trigger strategy as follows.

Definition 3.2 (Trigger 1). 1. Alice and Bob play I at time τ if cooperative relation is maintained before time τ .

2. If Alice (Bob) deviates from this cooperative strategy at τ , then Bob (Alice) chooses either X or Y with equal probability at time $\tau + 1$.

We show that Trigger 1 is an equilibrium of the repeated quantum prisoner's dilemma.

Lemma 3.3. Trigger 1 is an equilibrium of the repeated quantum prisoner's dilemma if either one of the following conditions are satisfied:

1. $r + p > t + s$
2. $r + p < t + s$ and $\sin^2 \theta < \frac{2(p-s)}{t-r+p-s}$

Proof. Suppose they play I for all t . Then Alice's total payoff is

$$\begin{aligned} V_A &= r + \delta r + \delta^2 r + \dots \\ &= \frac{r}{1 - \delta} \end{aligned} \quad (3.10)$$

Now assume that they play I before t and Alice plays Y at τ . Since Bob plays I at τ , her maximal payoff is

$$\begin{aligned} V'_A &= t + \delta \$_A(p^A, p^{B^*}) + \delta^2 \$_A(p^A, p^{B^*}) + \dots \\ &= t + \frac{\delta}{1 - \delta} \$_A(p^A, p^{B^*}), \end{aligned} \quad (3.11)$$

where $p^{B^*} = (0, \frac{1}{2}, \frac{1}{2}, 0)$. Note that, according to Propositions 2.6 and 2.7, p^{B^*} is an equilibrium of the game.

Choosing Y cannot be her incentive if $V_A > V'_A$, which is equivalent to

$$r - t + \frac{\delta}{1 - \delta} (r - \$_A(p^A, p^{B^*})) > 0. \quad (3.12)$$

Since $r - \$_A(p^A, p^{B^*})$ is always positive, this inequality is satisfied for a large δ . The greatest lower bound δ_{inf} of such δ is obtained as

$$\delta_{\text{inf}} = \frac{t - r}{t - \frac{1}{2}(p + p \cos^2 \theta + r \sin^2 \theta)} \quad (3.13)$$

Since δ_{inf} is smaller than 1, no deviation will occurs.

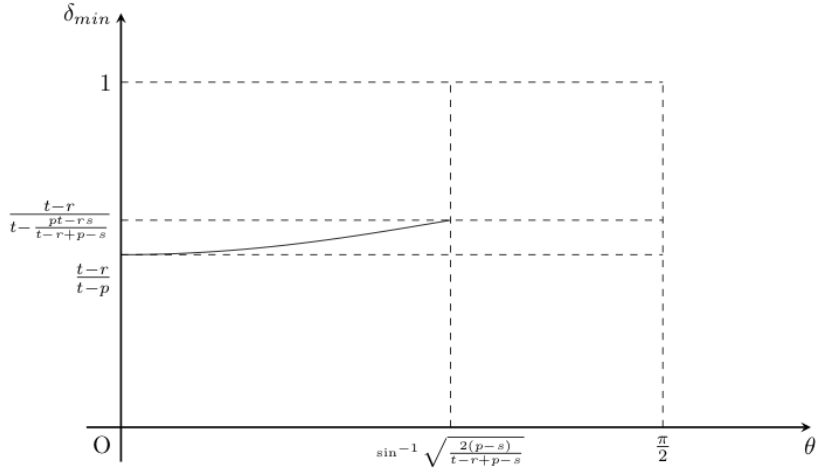

Figure 6. The greatest lower bound δ_{\inf} of discount factor as a function of the entangle parameter θ when $t + s > r + p$.

If Alice or Bob deviates from cooperative strategy, they choose X or Y with equal probability along trigger 1. According to Proposition 2.6 and 2.7, choosing X or Y with equal probability each other is an equilibrium when condition 1,2 are satisfied. So no deviation occurs, as long as Alice and Bob choose X or Y with equal probability.

Therefore, trigger 1 can be an equilibrium of the repeated game. \square

Fig.6 and 7 present the relation between δ_{\inf} and entanglement. The bigger θ becomes, the more profit the players can receive, therefore the discount factor δ should be sufficiently big in order to maintain the cooperative relation when their states are strongly entangled.

Definition 3.4 (Trigger 2). 1. Alice and Bob play I at time τ if cooperative relation is maintained before time τ .

2. If Bob (Alice) deviates from the cooperative strategy at time τ , then Alice (Bob) chooses either X or Y with the equal probability at time $\tau + 1$.
3. If Alice and Bob plays X and Y (or Y and X) respectively at time τ , then at time $\tau + 1$ Alice (Bob) repeats the same strategy, otherwise chooses either X or Y with the equal probability at time $\tau + 1$.
4. If Alice and Bob repeat X and Y (or Y and X) respectively before time τ and Bob (Alice) deviates from the repetition at time τ , then Alice (Bob) chooses either X or Y with the equal probability at time $\tau + 1$.

Deviation 1 means that Alice (Bob) deviates the cooperation and chooses X or Y . Deviation 2 means that Alice (Bob) chooses I or Z when they should choose

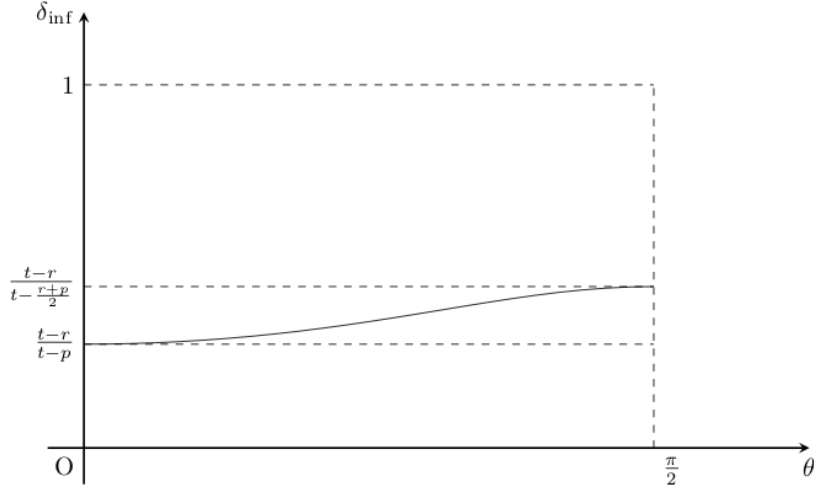

Figure 7. The greatest lower bound δ_{inf} as a function of the entangle parameter θ when $t + s < r + p$

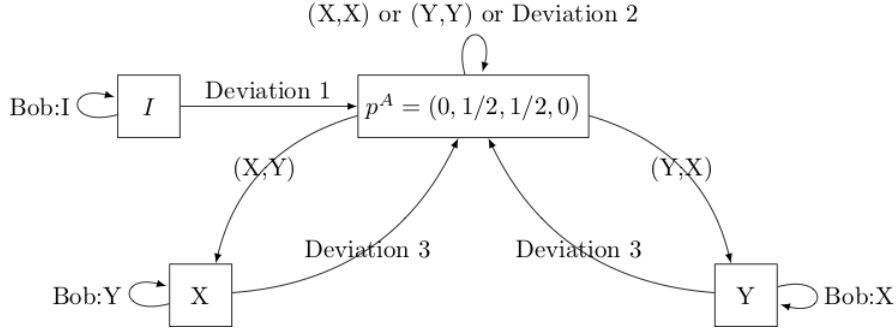

Figure 8. Alice's strategy diagram against Bob's strategies

X or Y with the equal probability. According to Proposition 2.6, it can happen when $\sin^2 \theta > \frac{2(p-s)}{t-r+p-s}$. Deviation 3 means that Alice (Bob) chooses I or Z when Alice should play X (Y) and Bob should play Y (X), respectively. It can happen at $\sin^2 \theta > \frac{p-s}{t-r+p-s}$. This is because that if an opponent chooses Y (X), choosing Z (I) against X (Y) can yield more profit.

We can modify Trigger 1 and redefine Trigger 2 so that for all θ , it can be a subgame perfect equilibrium.

Lemma 3.5 (Trigger 2). Trigger 2 is an equilibrium of the repeated game for $r > \frac{t+p}{2}$.

Proof. We first address the case where Alice choose deviation 1. Her total expected payoff when she plays I is $V_A = \frac{r}{1-\delta}$. If Alice chosen deviation 1, Alice and Bob choose X or Y with the equal probability. $(X, X), (X, Y), (Y, X), (Y, Y)$ can occur with the equal probability. In this round, the expected payoff is $\frac{1}{2}(p + p \cos^2 \theta + r \sin^2 \theta)$. If (X, X) or (Y, Y) is played, they should choose X or Y in the next round. If (X, Y) or (Y, X) is played, they should choose the same quantum strategy as last time in

the next round. Therefore her maximal expected payoff for choosing deviation 1 is

$$\begin{aligned} V'_A &= t + \sum_{t=1}^{+\infty} \delta^t \left(\frac{1}{2}\right)^t (\$A(X, X) + \$A(X, Y)) + \sum_{s=1}^{+\infty} \sum_{t=1}^{+\infty} \delta^{s+t} \left(\frac{1}{2}\right)^s \$A(X, Y) \\ &= t + \frac{\frac{\delta}{2}}{1 - \frac{\delta}{2}} \left(p + \frac{1}{1 - \delta} (p \cos^2 \theta + r \sin^2 \theta) \right) \end{aligned} \quad (3.14)$$

She does not have an incentive to choose deviation 1 when $V_A - V'_A > 0$, which can happen is δ is large.

Regarding deviation 2, Alice's total expected payoff when she choose either X or Y with the equal probability is

$$V_A = \frac{\frac{1}{2}}{1 - \frac{\delta}{2}} \left(p + \frac{1}{1 - \delta} (p \cos^2 \theta + r \sin^2 \theta) \right) \quad (3.15)$$

and her maximal expected payoff for choosing deviation 2 is

$$V'_A = \frac{s \cos^2 \theta + t \sin^2 \theta}{2} + \delta V_A. \quad (3.16)$$

She does not have an incentive to choose deviation 2 if $V_A - V'_A > 0$, which is satisfied for a large δ .

On deviation 3, Alice's total expected payoff for choosing X (Y) while Bob choosing Y (X) is

$$\begin{aligned} V_A &= \frac{\$A(X, Y)}{1 - \delta} \\ &= \frac{p \cos^2 \theta + r \sin^2 \theta}{1 - \delta} \end{aligned} \quad (3.17)$$

Her maximal expected payoff for choosing deviation 3 is

$$V'_A = s \cos^2 \theta + t \sin^2 \theta + \delta \left(\frac{\frac{1}{2}}{1 - \frac{\delta}{2}} \left(p + \frac{1}{1 - \delta} (p \cos^2 \theta + r \sin^2 \theta) \right) \right) \quad (3.18)$$

since Alice and Bob choose X or Y with the equal probability along trigger 2. She does not have an incentive to choose deviation 3 if $V_A - V'_A > 0$, which is satisfied for a large δ .

For all cases, one can find $\delta < 1$ that does not endows a player with an incentive for deviation. \square

The curves in Fig. 9 presents the relation between θ and the greatest lower bound δ_{inf} of δ that respects the condition $V_A - V'_A > 0$. Such δ lives in the colored region in the figure.

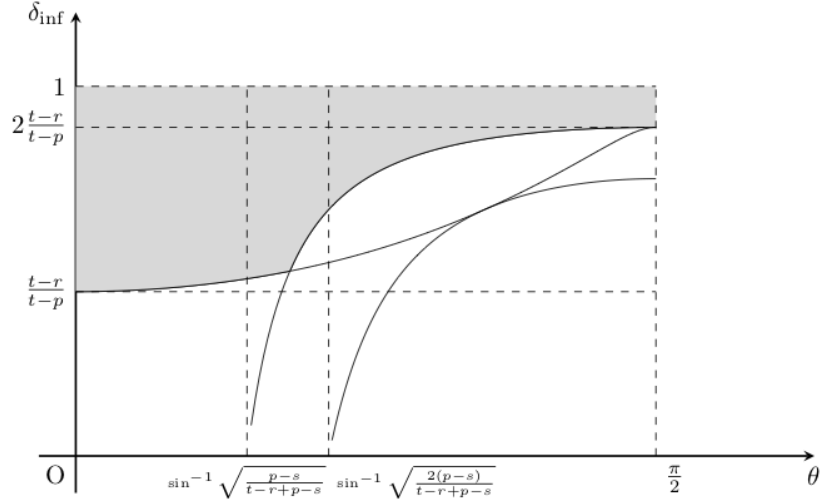

Figure 9. The region where trigger 2 becomes an equilibrium when $r > \frac{t+p}{2}$

3.3 Folk Theorem

3.3.1 Pure Quantum Strategy

We first consider both players choose pure strategies. Hence the set of strategies is $A = \{I, X, Y, Z\} \times \{I, X, Y, Z\}$. We write a pair of Alice and Bob's profit $\$(a) = (\$A(a), \$B(a))$ for a strategy $a \in A$. And let ν be the profit per single round of the repeated game. Then it turns out that they can receive profit ν in V (Fig.10 and 11).

$$V = \left\{ \nu \in \mathbb{R}^2 \mid \nu = \sum_{a \in A} p(a) \$(a), p(a) \geq 0, \sum_{a \in A} p(a) = 1 \right\} \quad (3.19)$$

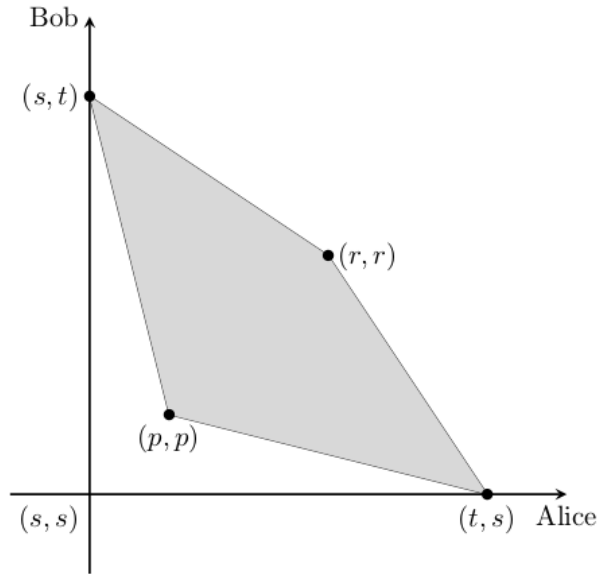

Figure 10. Domain of profit for $r > \frac{t+s}{2}$

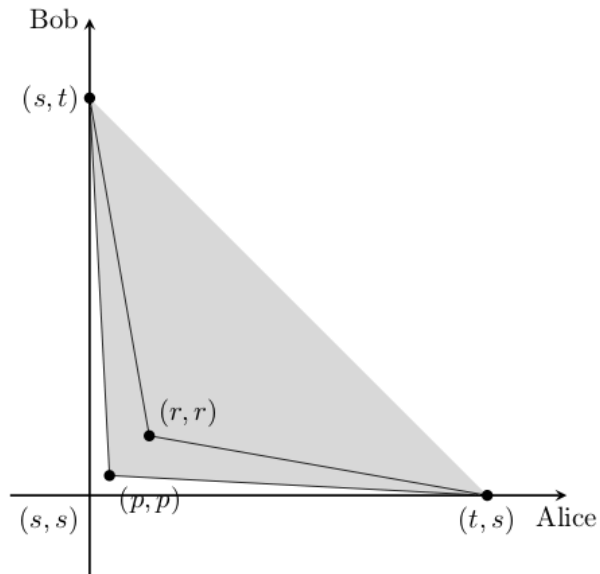

Figure 11. Domain of profit for $r < \frac{t+s}{2}$

Alice's mini-max value is defined as

$$\underline{\nu}_A = \min_{U_B} \max_{U_A} \$_A(U_A, U_B), \quad (3.20)$$

which is shown in Fig.12. If $\underline{\nu}_A$ is smaller than $\max\left\{r, \frac{t+s}{2}\right\}$, then there exists a subgame perfect equilibrium. This can be summarized as follows.

Theorem 3.6. While players choose pure quantum strategies, there exists a subgame perfect equilibrium of the repeated quantum prisoner's dilemma if

$$\sin^2 \theta < \frac{\max \left\{ r, \frac{t+s}{2} \right\} - s}{t - s}. \quad (3.21)$$

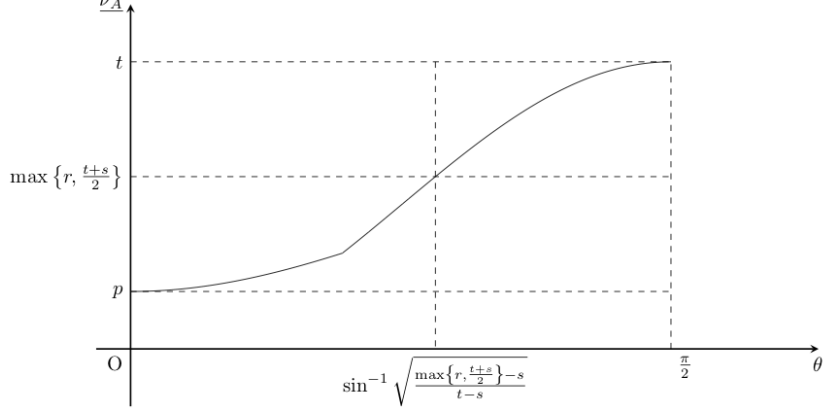

Figure 12. The mini-max value of Alice when both Alice and Bob choose only pure strategies.

3.3.2 Mixed Quantum Strategy

The mini-max value for the mixed strategy case is defined as

$$\underline{\nu}_A = \min_{P^B} \max_{p^A} \$A(p^A, p^B), \quad (3.22)$$

which is shown in Fig13 and 14. There is a subgame perfect equilibrium since $\underline{\nu}_A < \max \left\{ r, \frac{t+s}{2} \right\}$ is always satisfied. Note that, for all entanglement parameter θ there exists non-empty region

$$V^* = \left\{ \nu \in V \mid \nu_i > \underline{\nu}_i, i = A, B \right\}, \quad (3.23)$$

which we call the feasible and individually rational payoff set. If Alice and Bob are entangled, the mini-max value becomes large and the area of V^* gets small. Especially, the area of V^* becomes the smallest when states are maximally entangled $\theta = \frac{\pi}{2}$ and is exhibited as the dark parts of Fig.15 and 16. It does not contain (r, r) when $\theta = \frac{\pi}{2}$, therefore a notable difference between classical and quantum repeated prisoner's dilemma is the following.

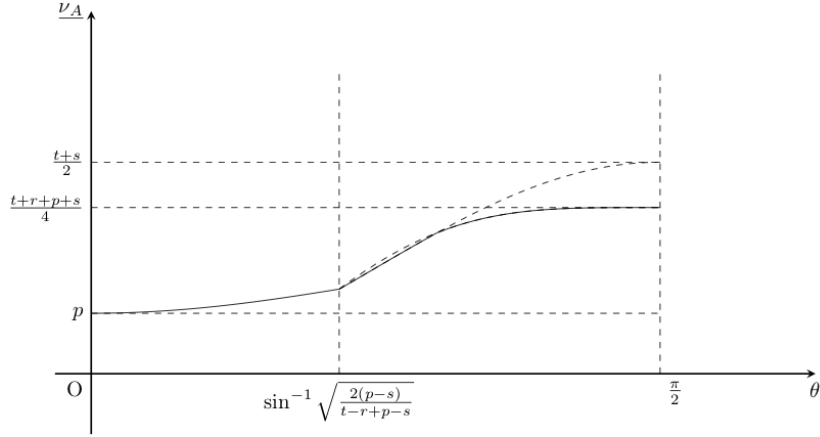

Figure 13. The mini-max value of Alice for $t + s > r + p$ when they play mixed strategies

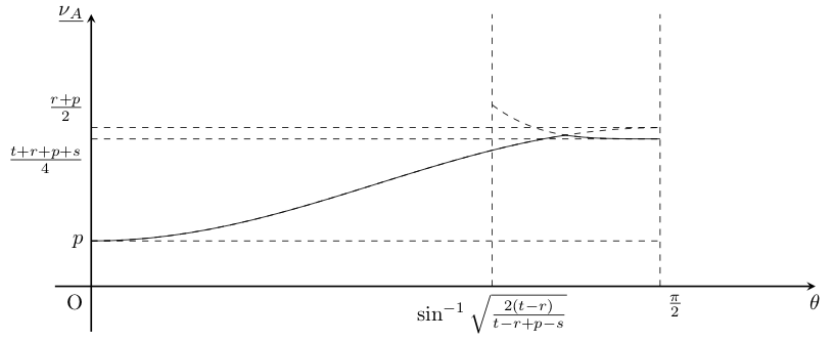

Figure 14. The mini-max value of Alice for $t + s < r + p$ when they play mixed strategies

Theorem 3.7 (Anti-Folk Theorem). When Alice and Bob are maximally entangled, cooperation and cooperation cannot be realized unless $r \geq \frac{t+s}{2}$.

In the classical repeated prisoner's game, cooperation and cooperation is the Pareto optimal solution and can be an equilibrium of the repeated game, called the Folk theorem, whereas it is not true for the quantum repeated game. For the case of our quantum game, one can always find a better solution that makes their payoff larger than choosing cooperation and cooperation. So in order to establish the cooperative relation, they require a sufficiently large reward r for cooperating.

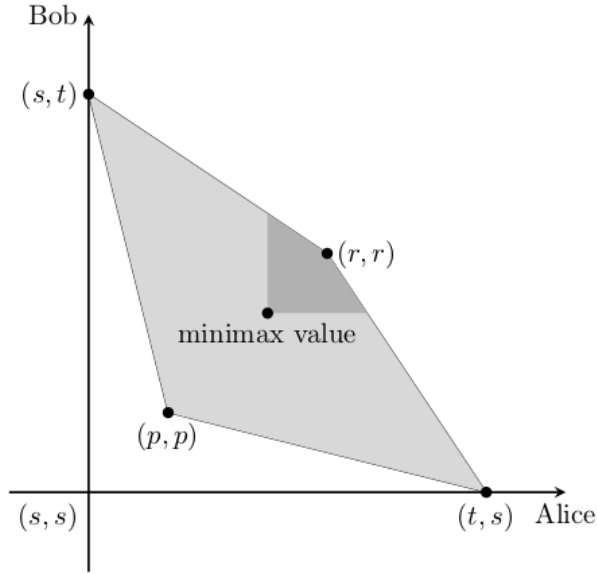

Figure 15. The feasible and individually rational payoff set for $r > \frac{t+s}{2}$

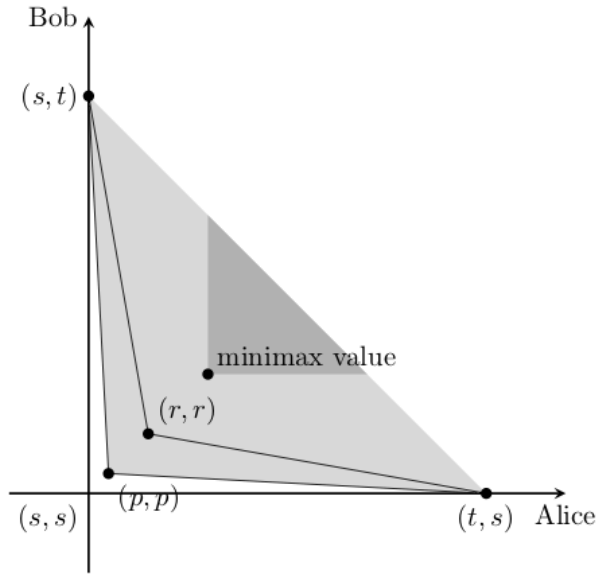

Figure 16. The feasible and individually rational payoff set for $r < \frac{t+s}{2}$

Based on a similar argument for the classical Folk theorem, we obtain its quantum version.

Theorem 3.8 (Quantum Folk Theorem). For all entanglement parameter θ , there exists an appropriate discount factor $\delta \in (0, 1)$ such that any payoff in the feasible and individually rational payoff set V^* .

Proof. Let m_A be Alice's mixed strategy that endows Bob with the mini-max value. Then if the round-average payoff for playing $a^* \in A$ is in V^* , the following is an equilibrium.

1. Choose $a^* \in A$ unless deviation occurs.
2. If deviation is observed, the both play $m = (m_A, m_B)$ for the next T rounds, then the both play a^* .
3. Once if m is not chosen in the T rounds, the both again choose m for the succeeding T rounds.

Here T is chosen as

$$d_i < T(\$_i(a^*) - \$_i(m)), \quad (i = A, B) \quad (3.24)$$

where $d_i = \max_{a_i} \{\$_i(a_i, a_{-i}^*) - \$_i(a^*)\}$.

One can complete the proof of the above as did in [10]. □

4 Conclusion

In this work we established the concept of a generic N -persons repeated quantum game and addressed repeated quantum prisoner's dilemma. Based on Definition 3.1, we addressed the repeated quantum prisoner's dilemma for the case of $\tau_i = 1$ for all i . Even though the game evolves in a classical manner, repetition of the quantum game is much different from the classical repeated prisoner's dilemma (Theorem 3.7) and obtained a novel feasible and individually rational set V^* for the repeated quantum prisoner's dilemma (Theorem 3.8).

There are many research directions of the repeated quantum games. For example, it will be interesting to address cases where $\tau_i \neq 1$. In this work we focused on the $\tau_i = 1$ case and as a result we clarified a role of entanglement θ . From a viewpoint of quantum computation, the complex probability coefficients c_i are important as well as entanglement. Taking into account of it, studying more on a generic time-evolution of the quantum game is crucial and it is necessary to introduce general review periods τ_i which the players should not know a priori.

Furthermore, it is important to address cooperative game theory from a viewpoint of repeated quantum games. A cooperative game has multiple Nash equilibria, whereas a non-cooperative game has at most one. The prisoner's dilemma is an example of non-cooperative games.

Moreover it is also interesting to apply quantum repeated games not only to economics but also to other fields. For example, machine learning can be regarded as a repeated game and we have a motivation to look at quantum machine learning from a viewpoint of repeated quantum games. Generative adversarial networks (GANs) could be a typical example of a repeated game.

References

- [1] K. Ikeda, *Foundation of quantum optimal transport and applications*, *Quantum Information Processing* **19** (2020) 25 [[1906.09817](#)].
- [2] J. F. Nash, *Equilibrium points in n-person games*, *Proceedings of the National Academy of Sciences* **36** (1950) 48 [<https://www.pnas.org/content/36/1/48.full.pdf>].
- [3] J. Eisert, M. Wilkens and M. Lewenstein, *Quantum games and quantum strategies*, *Phys. Rev. Lett.* **83** (1999) 3077 [[quant-ph/9806088](#)].
- [4] D. A. Meyer, *Quantum Strategies*, *Physical Review Letters* **82** (1999) 1052 [[quant-ph/9804010](#)].
- [5] Q. Li, M. Chen, M. Perc, A. Iqbal and D. Abbott, *Effects of adaptive degrees of trust on coevolution of quantum strategies on scale-free networks*, *Scientific Reports* **3** (2013) 2949 EP .
- [6] Q. Li, A. Iqbal, M. Perc, M. Chen and D. Abbott, *Coevolution of quantum and classical strategies on evolving random networks*, *PloS one* **8** (2013) e68423.
- [7] A. Iqbal and A. H. Toor, *Quantum repeated games*, *Physics Letters A* **300** (2002) 541 [[quant-ph/0203044](#)].
- [8] P. Frackiewicz, *Quantum repeated games revisited*, *Journal of Physics A Mathematical General* **45** (2012) 085307 [[1109.3753](#)].
- [9] D. Abreu, *On the theory of infinitely repeated games with discounting*, *Econometrica* **56** (1988) 383.
- [10] D. Fudenberg and E. Maskin, *The folk theorem in repeated games with discounting or with incomplete information*, *Econometrica* **54** (1986) 533.
- [11] F. Shah Khan, N. Solmeyer, R. Balu and T. Humble, *Quantum games: a review of the history, current state, and interpretation*, *arXiv e-prints* (2018) arXiv:1803.07919 [[1803.07919](#)].