

---

# COLLABORATION VS. CHOREOGRAPHY CONFORMANCE IN BPMN

FLAVIO CORRADINI, ANDREA MORICHETTA, ANDREA POLINI, BARBARA RE  
AND FRANCESCO TIEZZI

Computer Science Division, School of Science and Technology, University of Camerino  
*e-mail address:* {name.surname}@unicam.it

---

**ABSTRACT.** The BPMN 2.0 standard is a widely used semi-formal notation to model from different perspectives distributed information systems. Different diagrams are made available to represent such perspectives. *Choreography* diagrams represent global constraints concerning the interactions among system components without exposing their internal structure. *Collaboration* diagrams depict the internal behaviour of a component, also referred as process, when integrated with others so to represent a possible implementation of the distributed system.

This paper proposes a design methodology and a formal framework for checking conformance of choreographies against collaborations. In particular, the paper presents a direct formal operational semantics for both BPMN choreography and collaboration diagrams. Conformance aspects are proposed through two relations defined on top of the defined semantics. The approach benefits from the availability of a tool we have developed, named  $C^4$ , that permits to experiment the theoretical framework in practical context. The objective here is to make the exploited formal methods transparent to systems designers, thus fostering a wider adoption of them by practitioners.

## 1. INTRODUCTION

The BPMN 2.0 standard is a widely used semi-formal notation to model different perspectives of distributed information systems [OMG11]. Different diagrams are made available to represent relevant system perspectives, so to support even more engineering activities for such systems [Pas17, ABN<sup>+</sup>08]. In particular, *Choreography* diagrams are meant to represent the interactions among system components without exposing their internal structure. *Collaboration* diagrams, instead, can be used to describe the internal behaviour of multiple components integrated to compose a distributed system.

In such a setting, organisations that are willing to cooperate can refer to a choreography specification detailing how they should interact to reach specific objectives. On the other hand, the cooperation generally involves components of software systems for which the behaviour is specified, by the participating organisations, using specific process diagrams that will also include details on the internal actions of the system. The integration of such processes leads to a so-called collaboration. Nevertheless, a collaboration that integrates different processes to reach the objectives specified in a choreography should show a behaviour somehow related

---

*Key words and phrases:* BPMN, Choreography, Collaboration, Conformance, Tool Support.

to that defined by the global specification. The conformance of a given collaboration with respect to a pre-established choreography becomes then crucial, since it permits to ensure that the system components are able to successfully collaborate without invalidating the communication constraints imposed by the global specification, so to reach the objectives defined by the choreography. In the general context of service-oriented systems this problem has received a lot of attention [PTDL07, BBM<sup>+</sup>05, LMX07, EKdMSvdA08, RFG10, Mar03]. Notwithstanding this effort, there is still a lack of frameworks and tools supporting the conformance checking between collaboration and choreography models when the BPMN notation is considered.

Given such a gap and in order to fill it, we provide in this paper **a novel framework to check the conformance of BPMN choreography diagrams with respect to BPMN collaborations models**. In particular, in our approach we do not resort to a different intermediate language or formalism; instead we rely on a direct semantics describing the behaviour of both models. Clearly, such semantics embeds the peculiarities of the BPMN standard when used to model distributed systems (e.g., asynchronous communication among components). More specifically, to formally describe the behaviour of a system the operational semantics associates Labelled Transition Systems (LTSs) to its BPMN models. A collaboration and a choreography can then be compared to check the satisfaction of specific behavioural relations, considering the LTSs resulting from the defined semantic framework. We rely on a conformance relation (based on bisimulation [Mil89, Sec. 5]) that is sensitive to deadlocks and different forms of non-determinism, and on another relation (based on traces [Mil89, Sec. 9.4]) that instead is more relaxed on this respect. The support of both kinds of relations allows the system designer to decide the desired trade-off between the strength of the properties ensured by the system, and the breadth of choice among available system components.

The developed theoretical framework has been implemented in the  $C^4$  (*Collaboration vs Choreography Conformance Checker for BPMN*) tool. Standard input formats for the BPMN models are accepted by the tool so to enable its integration with external BPMN modelling environments (e.g., Camunda, Signavio and Eclipse BPMN2 Modeller). The tool permits to hide the underlying formal methods permitting to system designer, not accustomed with formalisms and formal reasoning, to access and use well established theories.

Summing up, the major contributions of this paper are as follows: (i) definition of a design methodology; (ii) definition, and implementation in Java, of a formal operational semantics for BPMN collaborations and choreographies; (iii) definition, and implementation, of two conformance relations; (iv) implementation of the  $C^4$  tool supporting the proposed methodology and conformance checking framework. This paper is a revised and extended version of [DBL]. Specifically, we extend our previous work by proposing a new dedicated design methodology; in consequence, both the formal framework and the related supporting tool have been revised accordingly.

*Outline.* Section 2 provides background notions on the BPMN modelling notation, with a particular emphasis on choreographies and collaborations diagrams. Moreover, in this section a running example is introduced, and it will be used in the rest of the paper to clarify various aspects of the proposed framework. Section 3 discusses the life cycle of a choreography specification, and how the developed theoretical framework, and the related tool, fits in such a setting. Section 4 introduces formal syntax and semantics for both choreographies and collaborations, and it includes the conformance relations we have defined.

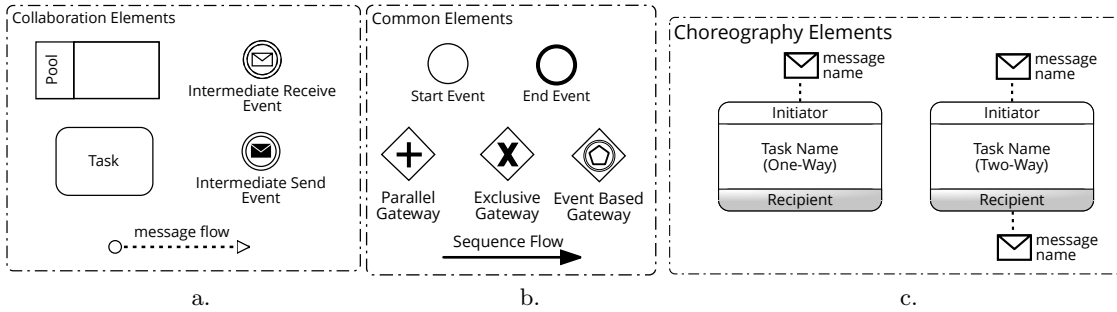

Figure 1: BPMN 2.0 Collaboration and Choreography Elements.

Successively, Section 5 presents the  $C^4$  tool and illustrates its practical usage, and then Section 6 discusses the scientific works much related to our proposal. Finally, Section 7 concludes the paper and discusses directions for future work.

## 2. BACKGROUND NOTIONS

This section first provides some basic notions on elements that can be included in BPMN choreography and collaboration diagrams, then it introduces a scenario that will be used as a running example.

**The BPMN Standard.** The focus of this section is not a complete presentation of the standard, but a discussion on the main concepts of BPMN we use in the following. These concepts are briefly described below and reported in Fig. 1.

Fig. 1.b depicts the modelling elements that can be included in both diagrams. **Events** are used to represent something that can happen. An event can be a *start event*, representing the point in which the choreography/collaboration starts, while an *end event* is raised when the choreography/collaboration terminates. **Gateways** are used to manage the flow of a choreography/collaboration both for parallel activities and choices. Gateways act as either join nodes (merging incoming sequence edges) or split nodes (forking into outgoing sequence edges). Different types of gateways are available. A *parallel gateway (AND)* in join mode has to wait to be reached by all its incoming edges to start, and respectively all the outgoing edges are started simultaneously in the split case. An *exclusive gateway (XOR)* describes choices; it is activated each time the gateway is reached in join mode and, in split mode, it activates exactly one outgoing edge. An *event based gateway* is similar to the XOR-split gateway, but its outgoing branches activation depends on the occurrence of a catching event in the collaboration and on the reception of a message in the choreography; these events/messages are in a race condition, where the first one that is triggered wins and disables the other ones. **Sequence Flows** are used to connect collaboration/choreography elements to specify the execution flow.

In a collaboration diagram, also the elements in Fig. 1.a can be included. **Pools** are used to represent participants involved in the collaboration. **Tasks** are used to represent specific works to perform within a collaboration by a participant. **Intermediate Events** represent something that happens during the flow of the process, such as sending or receiving of a message. **Message Edges** are used to visualize communication flows between different participants, by connecting communication elements within different pools.

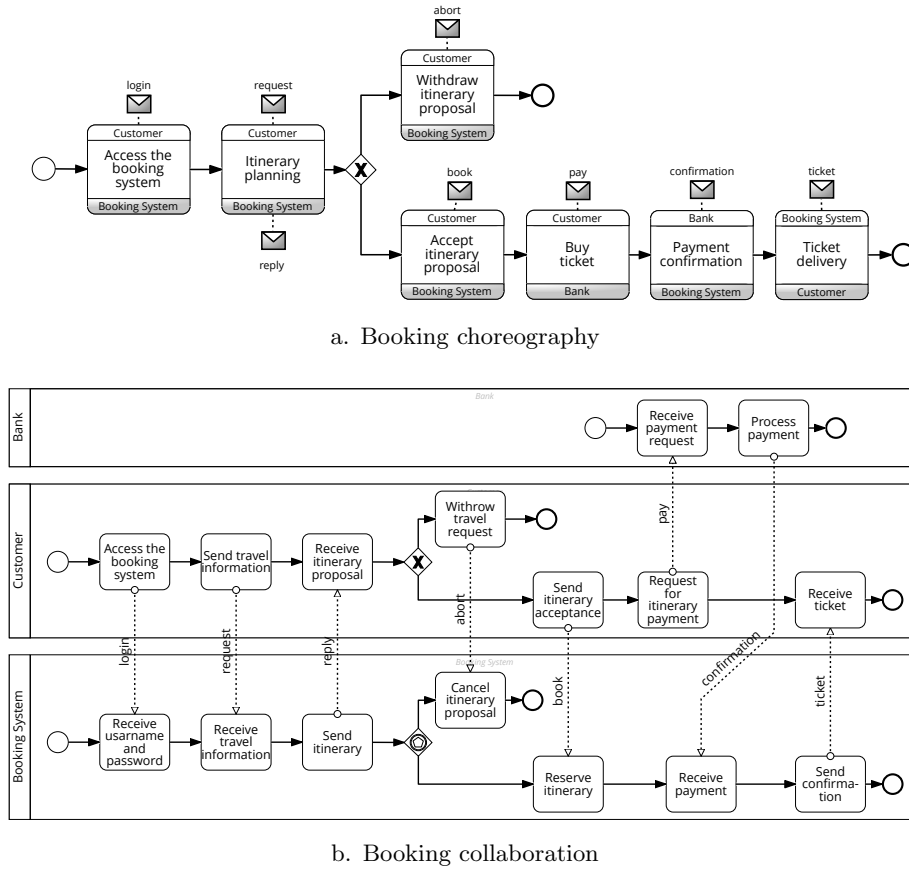

Figure 2: Booking Running Example.

Focusing on the choreography diagram, we underline its ability to specify the message exchanges between two or more participants. This is done by means of **Choreography Tasks** in Fig. 1.c. They are drawn as rectangles divided in three bands: the central one refers to the name of the task, while the others refer to the involved participants (the white one is the initiator (sender), while the gray one is the recipient). Messages can be sent either by one participant (One-Way tasks) or by both participants (Two-Way tasks).

**Running Example.** The collaboration and the choreography diagrams regarding a booking system introduced here are successively used in the paper to illustrate the various aspects of the proposed framework.

**Choreography Example.** The choreography in Fig. 2.a combines the work-activities of a booking system, a customer and a bank. They interact in order to book and pay for travel. After access to the booking system, the customer requests an itinerary and receives tentative planning. Then, the choreography can proceed following two different paths according to the customer decision. The upper path is triggered when the customer decides to withdraw the travel proposal; while the lower path is used for the proposal acceptance. In particular, when the proposal is accepted, the customer interacts with the bank for the payment of the ticket, and then the bank sends the confirmation to the booking system. The latter completes the procedure by sending the ticket to the customer.

*Collaboration Example.* The collaboration in Fig. 2.b shows the behaviour of the same participants of the choreography. After the customer login into the booking system, she requests some travel information, and she receives a proposal from the booking system. The customer then decides whether to withdraw or accept the proposal; this is represented through an XOR gateway. According to the decision, either the upper path, for the proposal withdraw, or the lower path, for the confirmation, is activated. The booking system waits for the decision of the customer and behaves accordingly. This is represented through an event-based gateway. In the case of withdrawing, the two participants terminate with end events. In case of confirmation, the customer sends the itinerary acceptance to the booking system and asks for payment to the bank. As soon as the bank processes the payment, and confirms it to the booking system, the customer receives the ticket.

### 3. THE $C^4$ METHODOLOGY

This section discusses the  $C^4$  design methodology we suggest to adopt concerning the phases of choreography specifications. The methodology paves the way toward the formal framework and contextualises the use of the related  $C^4$  tool with respect to systems design.

Choreographies have emerged in the context of distributed computing, and in particular of Service Oriented Computing, as an approach to describe/specify application-level protocols to be adopted by services willing to cooperate. In particular, the specification defines the messages and their mutual dependencies, that *are*, or *have to be*, exchanged by the participating parties in order to fulfil the choreography objectives.

In literature, two different approaches to choreography specifications have been adopted [HH08a, MM03]. The first one considers choreographies as emerging artefacts that relate to the integration of services that are composed and adapted to reach an objective collaboratively. The emerging models that then describe the messages that *are* exchanged can be successively considered in order to analyse properties of the composition and to possibly reason on it. Symmetrically, besides such a bottom-up approach, a top-down approach has also been proposed. In this case, a choreography acts as a blueprint defining which are the messages that *have to be* exchanged. The specification can be used to drive the development of services interested in taking part in possible choreography enactment. In particular, in such a case the participants, and their composition, have to abide by the communication constraints defined in the specification.

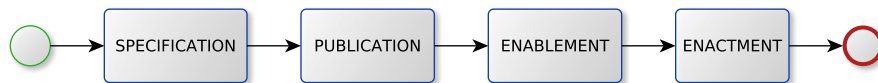

Figure 3:  $C^4$  methodology life process.

The  $C^4$  methodology fits with a top-down approach. Fig. 3 represents an ideal life process of a choreography specification in a top-down setting. In the first state (*specification*), given an application domain, a ‘super partes’ organisation defines a choreography specification that will act as a blueprint for those organisations interested in participating in possible choreography enactments. The specification reports the expected message exchanges, and the objectives that partners participating to the choreography can reach, both singularly and collectively. For instance, the choreography in Fig. 2.a defines precise prescriptions for a

*booking system*, a *customer* and a *bank* that would like to cooperate to perform a business transaction that will include a reservation for a resource in change of the corresponding price, to be paid via a bank.

Once the choreography has been completely specified, it is made available to interested parties (*publication*), and can be retrieved in order to implement services able to play the possibly foreseen roles. The publication can be as simple as a pdf file stored on a precise location, or be managed using specific service repositories (see, e.g., [AAP13, CFP<sup>+</sup>19]).

Once published, choreography can be seen as an opportunity for an organisation to integrate with others so to do business together (*enablement*). In such a sense, an organization is generally interested in choreographies in which it can play a role, and then it looks for potential partners in order to pursue the objectives of the choreography. The objective of such phase is to enable the choreography so that an instance of it can be successively enacted. Notably, all the roles foreseen by the specification must be played by a different organisation. To do this, each organisation develops a service among the one foreseen by the choreography and proposes it as a possible candidate. Different processes can be conceived to select the participants so to fill all the roles. In this paper, we do not make any assumption on such a selection; anyway, when all the roles are filled the choreography is enabled. Nevertheless, before enacting it is necessary to check that the composition of the selected services will conform to the one specified by the choreography. In a BPMN setting, the choreography specification will have been defined using a BPMN choreography diagram, while the different services will have been defined using process diagrams that when composed constitute a BPMN collaboration diagram.

Finally, the transition to the next state of the  $C^4$  methodology (*enactment*) will result in the execution of a choreography instance and then in the exchange of the prescribed messages, should be made possible only if the resulting collaboration diagram can reach the objectives specified by the choreography. Instead, if this is not the case, the enactment should be prevented, and the participants informed of possible issues in the composition. In fact, as it will be clarified in the next sections, this is where the  $C^4$  tool comes into play permitting to check if the participants involved in an enabled choreography produce a behaviour “respecting” the prescriptions of the choreography model.

Fig. 4 helps to clarify the steps of the  $C^4$  methodology in practice. In the figure, six different processes are represented, possibly implemented by services delivered by different organisations. In particular, in reference to the choreography reported in Fig. 2, different options could be admitted for each role to complete the specification. The process in Fig. 4.a has been defined to play the role of the bank, while the two processes in Fig. 4.b and Fig. 4.c have been both defined to play the role of the customer. Finally, the three processes in Fig. 4.d, Fig. 4.e, and Fig. 4.f have been defined to play the role of a booking system. In such a situation, six possible different compositions of processes are possible. Nevertheless, only few of them actually permit to achieve the objectives of the corresponding choreography, as it is detailed in Section 4 (see Table 1). In particular, possible composition problems can relate to structural issues (e.g., non correspondence on the sets of exchanged messages by the involved processes) or behavioural issues (e.g., non conformance with respect to specific behavioural relations of the resulting composition). In such a setting, the  $C^4$  tool then permits to prevent the enactment of enabled choreography instances that will successively result in the emergence of problems during the running stage.

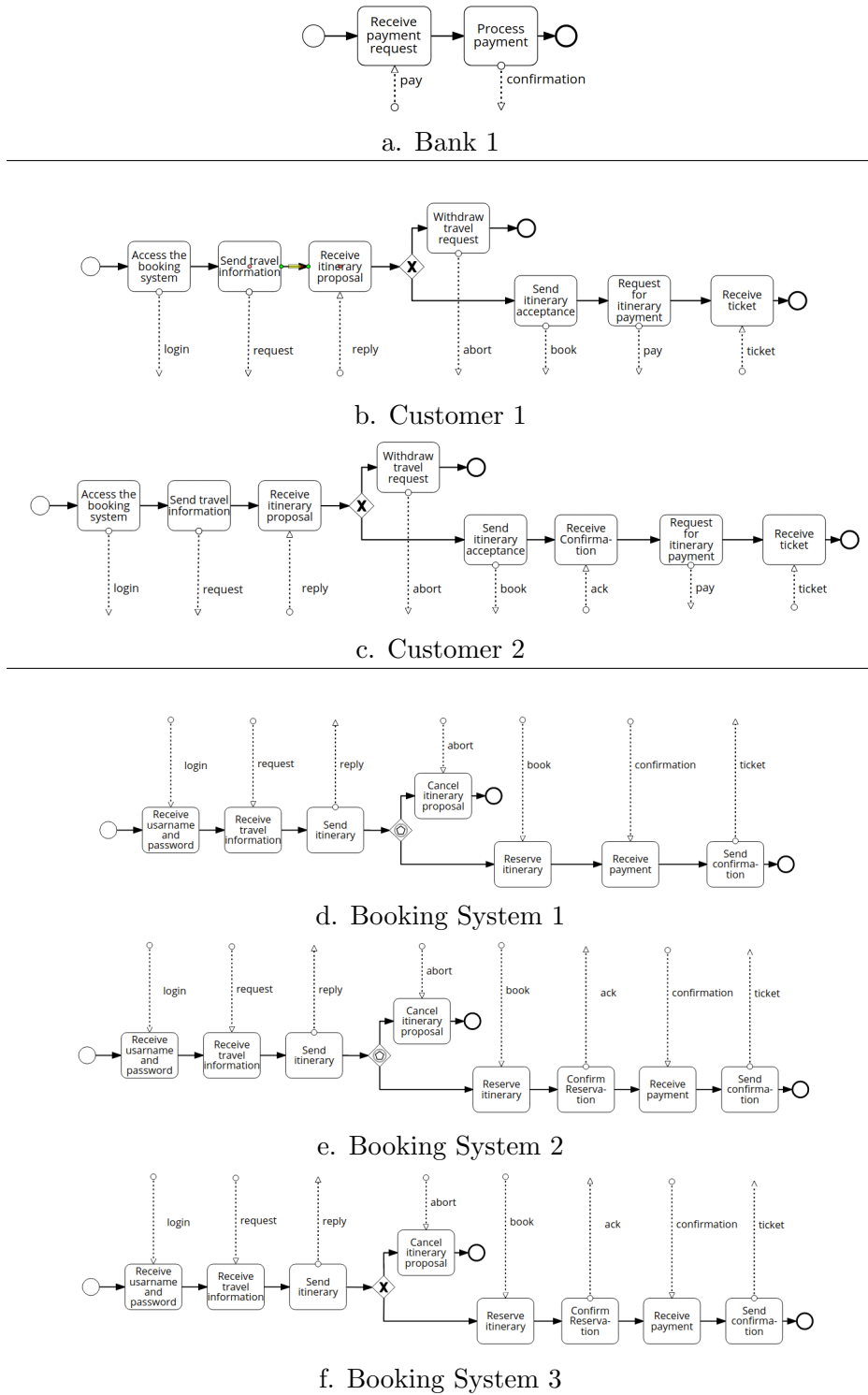

Figure 4: Possible processes for the roles in the choreography of Fig. 2.

#### 4. THE FORMAL FRAMEWORK

This section presents the formalisations at the basis of our framework, concerning the semantics of BPMN choreography and collaboration diagrams, and their conformance.

**Choreography and Collaboration Semantics.** We first summarise the distinctive aspects of the semantics of the choreographies and collaborations in relation to the BPMN modelling principles, and then we illustrate their formal definitions.

*Linguistic Aspects and Design Choices.* Concerning choreography diagrams, we made some specific design choices. In relation to the *Two-Way choreography task*, the OMG standard states that it is “an atomic activity in a choreography process” execution [OMG11, p. 323]. However, this does not mean that the task blocks the whole execution of the choreography. In fact, participants are usually distributed, and we assume that other choreography tasks involved in different parallel paths of the choreography can be executed. Thus, here we intend atomicity to mean that both messages exchanged in a Two-Way task have to be received before triggering the execution along the sequence flow outgoing from the task. Therefore, even if we allow Two-Way tasks in the choreography models, we safely manage them as pairs of One-Way tasks preserving the same meaning.

A further distinctive aspect of our formal semantics concerns the *communication model* that, to be compliant with the BPMN standard, is different for choreographies and collaborations. In the former case, the communication is expressed using synchronous messages. Indeed, according to the standard [OMG11, p. 315], a choreography task completes when the receiver participant reads the message. Synchronous communication requires choreography tasks to be blocking activities, which resume the execution only when an exchanged message is actually received. The communication model of collaborations, instead, is asynchronous. This means that a message sent by one participant is enqueued by the receiving one, which can then consume and process it subsequently, while the sender is free to proceed with its execution. This reflects the distributed nature of collaborations. The use of two different communication models also impacts on the definition of the conformance relations as illustrated below.

*Semantics of BPMN Choreographies.* To enable a formal treatment of a BPMN choreography we defined a Backus Normal Form (BNF) syntax of its model structure (Fig. 5). In the

$$\begin{array}{l}
 Ch ::= \text{start}(e_o) \mid \text{end}(e_i, e_c) \mid \text{andSplit}(e_i, E_o) \mid \text{andJoin}(E_i, e_o) \mid \text{xorSplit}(e_i, E_o) \mid \text{xorJoin}(E_i, e_o) \\
 \quad \mid \text{task}(e_i, e_o, p_1, p_2, m) \mid \text{eventBased}(e_i, T_1, T_2) \mid Ch_1 | Ch_2 \\
 T ::= (e_o, p_1, p_2, m) \mid T_1, T_2
 \end{array}$$

Figure 5: Syntax of BPMN Choreography Structures.

proposed grammar, the non-terminal symbol *Ch* represents *Choreography Structures*, while the terminal symbols, denoted by the sans serif font, are the considered elements of a BPMN model, i.e. events, tasks and gateways. We are not proposing a new modelling formalism, but we are only using a textual notation for the BPMN elements. With respect to the graphical notation, the textual one is more manageable for supporting the formal definition of the semantics and its implementation. Notably, even if our syntax would allow to write



terms that cannot be expressed in BPMN, we consider here only those terms of the syntax that can be derived from BPMN models.

Let  $\mathbb{E}$  be the set of edge names, in the following  $e \in \mathbb{E}$  denotes a sequence edge, while  $E \in 2^{\mathbb{E}}$  a set of edges; we require  $|E| > 1$  when  $E$  is used in joining and splitting gateways. For the convenience of the reader we refer with  $e_i$  the edge incoming into an element and with  $e_o$  the edge outgoing from an element.  $p$  and  $m$  denote names uniquely identifying a participant and a message, respectively. The correspondence between the syntax used here and the graphical notation of BPMN illustrated in Section 2 is as follows.

- $\text{start}(e_o)$  represents a start event with outgoing edge  $e_o$ .
- $\text{end}(e_i, e_c)$  represents an end event with incoming edge  $e_i$  and a (spurious) edge  $e_c$  representing the complete status of the end event.
- $\text{andSplit}(e_i, E_o)$  (resp.  $\text{xorSplit}(e_i, E_o)$ ) represents an AND (resp. XOR) split gateway with incoming edge  $e_i$  and outgoing edges  $E_o$ .
- $\text{andJoin}(E_i, e_o)$  (resp.  $\text{xorJoin}(E_i, e_o)$ ) represents an AND (resp. XOR) join gateway with incoming edges  $E_i$  and outgoing edge  $e_o$ .
- $\text{task}(e_i, e_o, p_1, p_2, m)$  represents a one-way task with incoming edge  $e_i$  and outgoing edge  $e_o$  sending a message  $m$  from  $p_1$  to  $p_2$ . As explained above, the two-way tasks are rendered in our formal framework as pairs of one-way tasks, hence they are not explicitly included in the syntax.
- $\text{eventBased}(e_i, T_1, T_2)$  represents an event-based gateway with incoming edge  $e_i$ , and a list of (at least two) tasks  $T_1, T_2$  to be processed. It is worth noticing that the definition of the task list  $T$  is composed by elements of the same structure of the one-way task except for the incoming edge, which is subsumed in the structure of the event-based gateway. When convenient, we shall regard a task list simply as a set.
- $Ch_1 | Ch_2$  represents a composition of elements in order to render a choreography structure in terms of a collection of elements.

To achieve a compositional definition, each sequence edge of the BPMN model is split in two parts: the part outgoing from the source element and the part incoming into the target element. The two parts are correlated by means of unique sequence edge names in the BPMN model.

**Example 1.** *Let us consider the BPMN choreography model in Fig 2.a. The textual representation of its structure is as follow (for reader's convenience, we use  $e_i$ , with  $i$  a natural number, to denote sequence edges, and  $p_c$  for Customer,  $p_{bs}$  for Booking System and  $p_{bk}$  for Bank):*

```

start(e1) | task(e1, e2, pc, pbs, login) | task(e2, e3, pc, pbs, request) |
task(e3, e4, pbs, pc, reply) | xorSplit(e4, {e5, e6}) | task(e5, e7, pc, pbs, abort) | end(e7, e8) |
task(e6, e9, pc, pbs, book) | task(e9, e10, pc, pbk, pay) | task(e10, e11, pbk, pbs, confirmation) |
task(e11, e12, pbs, pc, ticket) | end(e12, e13)

```

The operational semantics we propose is given in terms of configurations of the form  $\langle Ch, \sigma \rangle$ , where  $Ch$  is a choreography structure, and  $\sigma$  is the execution state storing for each edge the current number of tokens marking it. Specifically, a state  $\sigma : \mathbb{E} \rightarrow \mathbb{N}$  is a function mapping edges to numbers of tokens. The state obtained by updating in the state  $\sigma$  the number of tokens of the edge  $e$  to  $n$ , written as  $\sigma \cdot \{e \mapsto n\}$ , is defined as follows:  $(\sigma \cdot \{e \mapsto n\})(e')$  returns  $n$  if  $e' = e$ , otherwise it returns  $\sigma(e')$ . The *initial state*, where all edges are unmarked is denoted by  $\sigma_0$  formally,  $\sigma_0(e) = 0 \ \forall e \in \mathbb{E}$ . The transition relation over configurations, written  $\xrightarrow{l}$  and defined by the rules in Fig. 6, formalizes the execution

$\langle \text{start}(\mathbf{e}_o), \sigma_0 \rangle \xrightarrow{\tau} \text{inc}(\sigma_0, \mathbf{e}_o)$		$(Ch\text{-}Start)$
$\langle \text{end}(\mathbf{e}_i, \mathbf{e}_c), \sigma \rangle \xrightarrow{\tau} \text{inc}(\text{dec}(\sigma, \mathbf{e}_i), \mathbf{e}_c)$	$\sigma(\mathbf{e}_i) > 0$	$(Ch\text{-}End)$
$\langle \text{andSplit}(\mathbf{e}_i, E_o), \sigma \rangle \xrightarrow{\tau} \text{inc}(\text{dec}(\sigma, \mathbf{e}_i), E_o)$	$\sigma(\mathbf{e}_i) > 0$	$(Ch\text{-}AndSplit)$
$\langle \text{andJoin}(E_i, \mathbf{e}_o), \sigma \rangle \xrightarrow{\tau} \text{inc}(\text{dec}(\sigma, E_i), \mathbf{e}_o)$	$\forall \mathbf{e} \in E_i. \sigma(\mathbf{e}) > 0$	$(Ch\text{-}AndJoin)$
$\langle \text{xorSplit}(\mathbf{e}_i, \{\mathbf{e}\} \cup E_o), \sigma \rangle \xrightarrow{\tau} \text{inc}(\text{dec}(\sigma, \mathbf{e}_i), \mathbf{e})$	$\sigma(\mathbf{e}_i) > 0$	$(Ch\text{-}XorSplit)$
$\langle \text{xorJoin}(\{\mathbf{e}\} \cup E_i, \mathbf{e}_o), \sigma \rangle \xrightarrow{\tau} \text{inc}(\text{dec}(\sigma, \mathbf{e}), \mathbf{e}_o)$	$\sigma(\mathbf{e}) > 0$	$(Ch\text{-}XorJoin)$
$\langle \text{task}(\mathbf{e}_i, \mathbf{e}_o, \mathbf{p}_1, \mathbf{p}_2, \mathbf{m}), \sigma \rangle \xrightarrow{\mathbf{p}_1 \rightarrow \mathbf{p}_2 : \mathbf{m}} \text{inc}(\text{dec}(\sigma, \mathbf{e}_i), \mathbf{e}_o)$	$\sigma(\mathbf{e}_i) > 0$	$(Ch\text{-}Task)$
$\langle \text{eventBased}(\mathbf{e}_i, (\mathbf{e}_o, \mathbf{p}_1, \mathbf{p}_2, \mathbf{m}) \cup T), \sigma \rangle \xrightarrow{\mathbf{p}_1 \rightarrow \mathbf{p}_2 : \mathbf{m}} \text{inc}(\text{dec}(\sigma, \mathbf{e}_i), \mathbf{e}_o)$	$\sigma(\mathbf{e}_i) > 0$	$(Ch\text{-}EventG)$
$\frac{\langle Ch_1, \sigma \rangle \xrightarrow{l} \sigma'}{\langle Ch_1   Ch_2, \sigma \rangle \xrightarrow{l} \sigma'} \quad (Ch\text{-}Int_1)$		$\frac{\langle Ch_2, \sigma \rangle \xrightarrow{l} \sigma'}{\langle Ch_1   Ch_2, \sigma \rangle \xrightarrow{l} \sigma'} \quad (Ch\text{-}Int_2)$

Figure 6: Choreography Semantics.

of a choreography in terms of marking evolution and message exchanges. Labels  $l$  represent computational steps and are defined as:  $\tau$ , denoting internal computations; and  $\mathbf{p}_1 \rightarrow \mathbf{p}_2 : \mathbf{m}$ , denoting an exchange of message  $\mathbf{m}$  from participant  $\mathbf{p}_1$  to  $\mathbf{p}_2$ . Notably, despite the presence of labels, this has to be thought of as a reduction semantics, because labels are not used for synchronization (as instead it usually happens in labeled semantics), but only for keeping track of the exchanged messages in order to enable the conformance checking discussed later on. Since choreography execution only affects the current state, for the sake of presentation, we omit the choreography structure from the target configurations of transitions. Thus, a transition  $\langle Ch, \sigma \rangle \xrightarrow{l} \langle Ch, \sigma' \rangle$  is written as  $\langle Ch, \sigma \rangle \xrightarrow{l} \sigma'$ .

Before commenting on the rules, we introduce the auxiliary functions they exploit. Specifically, function  $\text{inc} : \mathbb{S} \times \mathbb{E} \rightarrow \mathbb{S}$  (resp.  $\text{dec} : \mathbb{S} \times \mathbb{E} \rightarrow \mathbb{S}$ ), where  $\mathbb{S}$  is the set of states, allows updating a state by incrementing (resp. decrementing) by one the number of tokens marking an edge in the state. Formally, they are defined as follows:  $\text{inc}(\sigma, \mathbf{e}) = \sigma \cdot \{\mathbf{e} \mapsto \sigma(\mathbf{e}) + 1\}$  and  $\text{dec}(\sigma, \mathbf{e}) = \sigma \cdot \{\mathbf{e} \mapsto \sigma(\mathbf{e}) - 1\}$ . These functions extend in a natural ways to sets of edges as follows:  $\text{inc}(\sigma, \emptyset) = \sigma$  and  $\text{inc}(\sigma, \{\mathbf{e}\} \cup E) = \text{inc}(\text{inc}(\sigma, \mathbf{e}), E)$ ; the cases for  $\text{dec}$  are similar.

We now briefly comment on the operational rules in Fig. 6. Rule  $Ch\text{-}Start$  starts the execution of a choreography when it is in its initial state (i.e., all edges are unmarked). The effect of the rule is to increment the number of tokens in the edge outgoing from the start event. Rule  $Ch\text{-}End$  instead is enabled when there is at least a token in the incoming edge of the end event, which is then moved to the spurious edge to keep track that a token ended up in the event. Rule  $Ch\text{-}AndSplit$  is applied when there is at least one token in the incoming edge of an AND split gateway; as result of its application the rule decrements the number of tokens in the incoming edge and increments that in each outgoing edge. Rule  $Ch\text{-}AndJoin$

$ \begin{aligned} P & ::= \text{start}(e_o) \mid \text{end}(e_i, e_c) \mid \text{andJoin}(E_i, e_o) \mid \text{xorSplit}(e_i, E_o) \mid \text{andSplit}(e_i, E_o) \mid \text{xorJoin}(E_i, e_o) \\ & \mid \text{task}(e_i, e_o) \mid \text{taskRcv}(e_i, e_o, m) \mid \text{taskSnd}(e_i, e_o, m) \mid \text{interRcv}(e_i, e_o, m) \mid \text{interSnd}(e_i, e_o, m) \\ & \mid \text{eventBased}(e_i, M_1, M_2) \mid P_1 \mid P_2 \\ M & ::= (m, e_o) \mid M_1, M_2 \end{aligned} $
--

Figure 7: Syntax of BPMN Processes Structures.

decrements the tokens in each incoming edge and increments the number of tokens of the outgoing edge, when each incoming edge has at least one token. Rule *Ch-XorSplit* is applied when a token is available in the incoming edge of an XOR split gateway, the rule decrements this token and increments the tokens in one of the outgoing edges. Rule *Ch-XorJoin* is activated every time there is a token in one of the incoming edges, which is then moved to the outgoing edge. Rule *Ch-Task* is activated when there is a token in the incoming edge of a choreography task, so that the application of the rule produces a message exchange label and moves the token from the incoming edge to the outgoing one. Rule *Ch-EventG* is activated each time there is a token in the incoming edge, which is moved to the outgoing edge of one task in the enclosed list, and produces a message exchange label. Different message exchanges can take place; the selection of the executed task from the list specified in the gateway is non-deterministic, in order to properly model the race condition regulating the behaviour of the event-based gateway. Finally, rules *Ch-Int<sub>1</sub>* and *Ch-Int<sub>2</sub>* deal with interleaving.

**Example 2.** Let  $Ch_i$  be the choreography structure defined in Example 1. The initial configuration of the collaboration is  $\langle Ch_i, \sigma_0 \rangle$ , where  $\sigma_0(e_i) = 0 \ \forall i \in \{1, \dots, 13\}$ . The state  $\sigma_1$  obtained by applying the rule *Ch-Start*, which marks the edge  $e_1$ , is obtained as follows:  $\sigma_1 = \text{inc}(\sigma_0, e_1)$ .

*From Processes to Collaborations.* According to the  $C^4$  methodology described in Section 3, a choreography is enacted by collaborations resulting from the combination of sets of processes. We formalise here the notions of process, collaboration, and process composition.

The BNF syntax of the process model structure is given in Fig. 7. The non-terminal symbol  $P$  represents *Process Structures*, while terminal symbols denote, as usual, the considered BPMN elements. In a process model there are three types of tasks, i.e. non-communicating (*task*), receiving (*taskRcv*) and sending (*taskSnd*), and also two intermediate events, i.e. receiving (*interRcv*) and sending (*interSnd*). Each receiving/sending elements specifies an exchanged message, while an event-based gateway specifies a list of (at least two) messages, each one enriched with the outgoing edge enabled by the message reception. When convenient, we shall regard a message list simply as a set.

**Example 3.** Let us consider the BPMN process model in Fig 4.b. The textual representation of its structure is as follow:

$$\begin{aligned}
& \text{start}(e'_1) \mid \text{taskSnd}(e'_1, e'_2, \text{login}) \mid \text{taskSnd}(e'_2, e'_3, \text{request}) \mid \text{taskRcv}(e'_3, e'_4, \text{reply}) \mid \\
& \text{xorSplit}(e'_4, \{e'_5, e'_6\}) \mid \text{taskSnd}(e'_5, e'_7, \text{abort}) \mid \text{end}(e'_7, e'_8) \mid \text{taskSnd}(e'_6, e'_9, \text{book}) \mid \\
& \text{taskSnd}(e'_9, e'_{10}, \text{pay}) \mid \text{taskRcv}(e'_{11}, e'_{12}, \text{ticket}) \mid \text{end}(e'_{12}, e'_{13})
\end{aligned}$$

The BNF syntax of the collaboration model structure is given in Fig. 8, where the non-terminal symbol  $C$  represents *Collaboration Structures*. Each process involved in a collaboration is identified by a participant name, denoted by  $p$ . The exchange of messages

$ \begin{aligned} C & ::= \text{start}(e_o) \mid \text{end}(e_i, e_c) \mid \text{andJoin}(E_i, e_o) \mid \text{xorSplit}(e_i, E_o) \mid \text{andSplit}(e_i, E_o) \mid \text{xorJoin}(E_i, e_o) \\ & \mid \text{task}(e_i, e_o) \mid \text{taskRcv}(e_i, e_o, (p_1, p_2, m)) \mid \text{taskSnd}(e_i, e_o, (p_1, p_2, m)) \\ & \mid \text{interRcv}(e_i, e_o, (p_1, p_2, m)) \mid \text{interSnd}(e_i, e_o, (p_1, p_2, m)) \mid \text{eventBased}(e_i, ME_1, ME_2) \mid C_1 \mid C_2 \\ ME & ::= (p_1, p_2, m, e_o) \mid ME_1, ME_2 \end{aligned} $
---

Figure 8: Syntax of BPMN Collaboration Structures.

in a collaboration is modeled by means of *message edges*. Here, they are represented by triples of the form  $(p_1, p_2, m)$  indicating, in order, the sending participant, the receiving participant and the message. Accordingly, an event-based gateway specifies a list of (at least two) message edges.

**Example 4.** *Let us consider the BPMN collaboration model in Fig 2.b. The textual representation of its structure is as follow:*

$$C_{bk} \mid C_{bs} \mid C_c$$

where:

$$\begin{aligned}
C_{bk} & ::= \text{start}(e_1''') \mid \text{taskRcv}(e_1''', e_2''', (p_c, p_{bk}, \text{pay})) \mid \\
& \text{taskSnd}(e_2''', e_3''', (p_{bk}, p_{bs}, \text{confirmation})) \mid \text{end}(e_3''', e_4''')
\end{aligned}$$

$$\begin{aligned}
C_{bs} & ::= \text{start}(e_1'') \mid \text{taskRcv}(e_1'', e_2'', (p_c, p_{bs}, \text{login})) \mid \text{taskRcv}(e_2'', e_3'', (p_c, p_{bs}, \text{request})) \mid \\
& \text{taskSnd}(e_3'', e_4'', (p_{bs}, p_c, \text{reply})) \mid \\
& \text{eventBased}(e_4'', (p_c, p_{bs}, \text{abort}, e_5''), (p_c, p_{bs}, \text{book}, e_6'')) \mid \text{end}(e_5'', e_7'') \mid \\
& \text{taskRcv}(e_6'', e_8'', (p_{bk}, p_{bs}, \text{confirmation})) \mid \text{taskSnd}(e_8'', e_9'', (p_{bs}, p_c, \text{ticket})) \mid \\
& \text{end}(e_9'', e_{10}'')
\end{aligned}$$

$$\begin{aligned}
C_c & ::= \text{start}(e_1') \mid \text{taskSnd}(e_1', e_2', (p_{p_{bk}}, p_{bs}, \text{login})) \mid \text{taskSnd}(e_2', e_3', (p_{p_{bk}}, p_{bs}, \text{request})) \mid \\
& \text{taskRcv}(e_3', e_4', (p_{bs}, p_{p_{bk}}, \text{reply})) \mid \text{xorSplit}(e_4', \{e_5', e_6'\}) \mid \\
& \text{taskSnd}(e_5', e_7', (p_{p_{bk}}, p_{bs}, \text{abort})) \mid \text{end}(e_7', e_8') \mid \text{taskSnd}(e_6', e_9', (p_{p_{bk}}, p_{bs}, \text{book})) \mid \\
& \text{taskSnd}(e_9', e_{10}', (p_{p_{bk}}, p_{bk}, \text{pay})) \mid \text{taskRcv}(e_{11}', e_{12}', (p_{bk}, p_{bs}, \text{ticket})) \mid \text{end}(e_{12}', e_{13}')
\end{aligned}$$

When composing processes in order to form collaborations, we must properly connect via a message edge each task (or intermediate event) of a process sending a given message with a corresponding receiving element belonging to another process, and vice versa. Hence, the resulting collaboration should not contain disconnected communicating elements. To formalise this property, we need to introduce the auxiliary functions  $out(C)$  and  $in(C)$ , which return, respectively, the (multi)sets of message edges outgoing from and incoming

into a communicating element in the collaboration  $C$ :

$$out(C) = \begin{cases} \{(p_1, p_2, m)\} & \text{if } C = \text{taskSnd}(e_i, e_o, (p_1, p_2, m)) \text{ or } C = \text{interSnd}(e_i, e_o, (p_1, p_2, m)) \\ out(C_1) \uplus out(C_2) & \text{if } C = C_1 | C_2 \\ \emptyset & \text{otherwise} \end{cases}$$

$$in(C) = \begin{cases} \{(p_1, p_2, m)\} & \text{if } C = \text{taskRcv}(e_i, e_o, (p_1, p_2, m)) \text{ or } C = \text{interRcv}(e_i, e_o, (p_1, p_2, m)) \\ in(ME) & \text{if } C = \text{eventBased}(e_i, ME) \\ in(C_1) \uplus in(C_2) & \text{if } C = C_1 | C_2 \\ \emptyset & \text{otherwise} \end{cases}$$

$$in((p_1, p_2, m, e_o)) = \{(p_1, p_2, m)\} \quad in(ME_1, ME_2) = in(ME_1) \uplus in(ME_2)$$

where  $\uplus$  denotes the multiset union operator.

We can now formally define the well-composedness property for collaborations.

**Definition 1** (Well-composed collaboration). *Let  $C$  be a collaboration,  $C$  is well-composed if  $out(C) = in(C)$  and  $\forall (p_1, p_2, m) \in out(C) \cup in(C) . p_1 \neq p_2$ .*

**Example 5.** *Let consider the processes a, b and d in Fig. 4. By associating them the participant names  $p_{bk}$ ,  $p_c$  and  $p_{bs}$ , respectively, and by composing them we obtain the collaboration model  $C_1$  in Fig 2.b. This is well-composed, because we have:*

$$out(C_1) = in(C_1) = \{(p_{bk}, p_{bs}, \text{confirmation}), (p_{bs}, p_c, \text{reply}), (p_{bs}, p_c, \text{ticket}), (p_c, p_{bs}, \text{login}), \\ (p_c, p_{bs}, \text{request}), (p_c, p_{bs}, \text{abort}), (p_c, p_{bs}, \text{book}), (p_c, p_{bk}, \text{pay})\}$$

*Now, let us consider to replace the process d by the process e in Fig 4, which adds an extra behaviour sending an acknowledge message that we suppose targeted to the customer participant. In this case, however, the resulting composition is the collaboration  $C_2$  that is not well-composed. Indeed, the set  $out(C_2)$  contains the message edge  $(p_{bs}, p_c, \text{ack})$  that is not in  $in(C_2)$ . Graphically, this corresponds to a malformed BPMN model with a message edge outgoing from a task of a pool but not connected with a task of another pool.*

Before presenting our formalisation of collaboration creation via processes composition, we need to introduce few notations and auxiliary functions. Firstly, notation  $\bar{\cdot}$  stands for tuples, with  $|\cdot|$  denoting the tuple length and  $\cdot \downarrow_i$  denoting the  $i$ -th element of the tuple. For example,  $\bar{p}$  represents a tuple of participant names  $\langle p_1, \dots, p_n \rangle$ , with  $n \geq 0$ , and hence  $|\bar{p}| = n$  and  $\bar{p} \downarrow_i = p_i$  for  $i \in \{1, \dots, n\}$ . Secondly, since the operator  $|$  is associative, we can generalise it to an  $n$ -ary operator and use the notation  $\prod$  to represent its iterated version. For example,  $\prod_{i=1}^n C_i = C_1 | \dots | C_n$ . Finally, we will resort to the auxiliary functions  $S$  and  $R$  that, given a message, return the sender and the receiver participant, respectively.  $S$  and  $R$  are written as collections of pairs of the form  $m \mapsto p$ . We use  $\emptyset$  to denote the empty message function (i.e.,  $\emptyset(m)$  is undefined for any  $m$ ), and  $S_1 \sqcup S_2$  (resp.  $R_1 \sqcup R_2$ ) to denote the union of  $S_1$  and  $S_2$  (resp.  $R_1$  and  $R_2$ ) when they have disjoint domain. We will also generalise  $\sqcup$  to the  $n$ -ary operator  $\bigsqcup$ .

Let us now to formally define how a set of processes can be associated to process names and composed together in order to form a collaboration, which is defined according to the syntax given in Fig. 8.

**Definition 2** (Processes composition function). *Let  $\bar{P}$  and  $\bar{p}$  be a tuple of processes and a tuple of participant names, respectively; their composition is defined by the function  $\mathcal{C}$  as follows:*

$$\mathcal{C}(\bar{P}, \bar{p}) = \prod_{i=1}^n \mathcal{N}(\bar{P} \downarrow_i, \mathcal{S}(\bar{P}, \bar{p}), \mathcal{R}(\bar{P}, \bar{p}))$$

with  $|\bar{P}| = |\bar{p}| = n$ . Functions  $\mathcal{S}$  and  $\mathcal{R}$ , computing the message functions for the given processes and the corresponding names, are defined as follows:

$$\mathcal{S}(\bar{P}, \bar{p}) = \bigsqcup_{i \in \{1, \dots, n\}} \mathcal{S}(\bar{P} \downarrow_i, \bar{p} \downarrow_i) \quad \text{with } |\bar{P}| = |\bar{p}| = n$$

$$\mathcal{S}(P_1 \mid P_2, \mathbf{p}) = \mathcal{S}(P_1, \mathbf{p}) \sqcup \mathcal{S}(P_2, \mathbf{p})$$

$$\mathcal{S}(\text{taskSnd}(e_i, e_o, m), \mathbf{p}) = \mathcal{S}(\text{interSnd}(e_i, e_o, m), \mathbf{p}) = \{m \mapsto \mathbf{p}\}$$

$$\mathcal{S}(P, \mathbf{p}) = \emptyset \quad \text{for any } P \text{ different from taskSnd and interSnd}$$

$$\mathcal{R}(\bar{P}, \bar{p}) = \bigsqcup_{i \in \{1, \dots, n\}} \mathcal{R}(\bar{P} \downarrow_i, \bar{p} \downarrow_i) \quad \text{with } |\bar{P}| = |\bar{p}| = n$$

$$\mathcal{R}(P_1 \mid P_2, \mathbf{p}) = \mathcal{R}(P_1, \mathbf{p}) \sqcup \mathcal{R}(P_2, \mathbf{p})$$

$$\mathcal{R}(\text{taskRcv}(e_i, e_o, m), \mathbf{p}) = \mathcal{R}(\text{interRcv}(e_i, e_o, m), \mathbf{p}) = \{m \mapsto \mathbf{p}\}$$

$$\mathcal{R}(\text{eventBased}(e_i, M), \mathbf{p}) = \mathcal{R}(M, \mathbf{p})$$

$$\mathcal{R}((m, e_o), \mathbf{p}) = \{m \mapsto \mathbf{p}\} \quad \mathcal{R}((M_1, M_2), \mathbf{p}) = \mathcal{R}(M_1, \mathbf{p}) \sqcup \mathcal{R}(M_2, \mathbf{p})$$

$$\mathcal{R}(P, \mathbf{p}) = \emptyset \quad \text{for any } P \text{ different from taskRcv, interRcv and eventBased}$$

Finally, the naming function  $\mathcal{N}$  is defined by the following relevant cases (in the remaining cases, the function acts as an homomorphism):

$$\mathcal{N}(P_1 \mid P_2, S, R) = \mathcal{N}(P_1, S, R) \mid \mathcal{N}(P_2, S, R)$$

$$\mathcal{N}(\text{taskSnd}(e_i, e_o, m), S, R) = \text{taskSnd}(e_i, e_o, (S(m), R(m), m)) \quad \text{if } S(m) \neq R(m)$$

$$\mathcal{N}(\text{interSnd}(e_i, e_o, m), S, R) = \text{interSnd}(e_i, e_o, (S(m), R(m), m)) \quad \text{if } S(m) \neq R(m)$$

$$\mathcal{N}(\text{taskRcv}(e_i, e_o, m), S, R) = \text{taskRcv}(e_i, e_o, (S(m), R(m), m)) \quad \text{if } S(m) \neq R(m)$$

$$\mathcal{N}(\text{interRcv}(e_i, e_o, m), S, R) = \text{interRcv}(e_i, e_o, (S(m), R(m), m)) \quad \text{if } S(m) \neq R(m)$$

$$\mathcal{N}(\text{eventBased}(e_i, M), S, R) = \text{eventBased}(e_i, \mathcal{N}(M, S, R))$$

$$\mathcal{N}((m, e_o), S, R) = (S(m), R(m), m, e_o) \quad \text{if } S(m) \neq R(m)$$

Intuitively, function  $\mathcal{C}$  extracts from the processes to be composed the information concerning sending and receiving participants for all exchanged messages, and uses this information for enriching the message edges of each process. Specifically, function  $\mathcal{S}$  identifies as a sender of a message a participant that performs a sending task or a sending intermediate event with that message as an argument, while function  $\mathcal{R}$  identifies as a receiver of a message a participant performing a receiving task, a receiving intermediate event or a an event-based gateway on the message. If the function  $\mathcal{C}$  returns a collaboration, this is well-composed;

$\langle \text{eventBased}(e_i, (p_1, p_2, m, e_o) \cup M), \sigma, \delta \rangle \xrightarrow{p_1 \rightarrow p_2: m} \langle \text{inc}(\text{dec}(\sigma, e_i), e_o), \text{dec}(\delta, (p_1, p_2, m)) \rangle$	$\sigma(e_i) > 0,$ $\delta(p_1, p_2, m) > 0$	$(C\text{-Event}G)$
$\langle \text{task}(e_i, e_o), \sigma, \delta \rangle \xrightarrow{\tau} \langle \text{inc}(\text{dec}(\sigma, e_i), e_o), \delta \rangle$	$\sigma(e_i) > 0$	$(C\text{-Task})$
$\langle \text{taskRcv}(e_i, e_o, (p_1, p_2, m)), \sigma, \delta \rangle \xrightarrow{p_1 \rightarrow p_2: m} \langle \text{inc}(\text{dec}(\sigma, e_i), e_o), \text{dec}(\delta, (p_1, p_2, m)) \rangle$	$\sigma(e_i) > 0,$ $\delta(p_1, p_2, m) > 0$	$(C\text{-TaskRcv})$
$\langle \text{taskSnd}(e_i, e_o, (p_1, p_2, m)), \sigma, \delta \rangle \xrightarrow{\tau} \langle \text{inc}(\text{dec}(\sigma, e_i), e_o), \text{inc}(\delta, (p_1, p_2, m)) \rangle$	$\sigma(e_i) > 0$	$(C\text{-TaskSnd})$
$\langle \text{interRcv}(e_i, e_o, (p_1, p_2, m)), \sigma, \delta \rangle \xrightarrow{p_1 \rightarrow p_2: m} \langle \text{inc}(\text{dec}(\sigma, e_i), e_o), \text{dec}(\delta, (p_1, p_2, m)) \rangle$	$\sigma(e_i) > 0,$ $\delta(p_1, p_2, m) > 0$	$(C\text{-InterRcv})$
$\langle \text{interSnd}(e_i, e_o, (p_1, p_2, m)), \sigma, \delta \rangle \xrightarrow{\tau} \langle \text{inc}(\text{dec}(\sigma, e_i), e_o), \text{inc}(\delta, (p_1, p_2, m)) \rangle$	$\sigma(e_i) > 0$	$(C\text{-InterSnd})$

Figure 9: Collaboration Semantics (excerpt of rules).

otherwise the function is undefined, meaning that the processes given in input cannot be correctly composed to form a collaboration. This is formalised by the following proposition.

**Proposition 1.** *Let  $\bar{P}$  and  $\bar{p}$  be a tuple of processes and a tuple of participant names, respectively; if  $\mathcal{C}(\bar{P}, \bar{p}) = C$  then  $C$  is well-composed.*

*Proof.* The proof proceeds by contradiction (see the Appendix).  $\square$

**Example 6.** *Let  $P_a, P_b$  and  $P_d$  be the textual representation of processes a, b and d in Fig. 4. Their composition is formally defined as  $\mathcal{C}(\langle P_a, P_b, P_d \rangle, \langle p_{bk}, p_c, p_{bs} \rangle) = (C_{bk} \mid C_{bs} \mid C_c)$ , with  $C_{bk}, C_{bs}$  and  $C_c$  defined in Example 4.*

*Semantics of BPMN Collaborations.* The operational semantics we propose for collaborations is given in terms of configurations of the form  $\langle C, \sigma, \delta \rangle$ , where:  $C$  is a collaboration structure;  $\sigma$  is the first part of the execution state, storing for each sequence edge the current number of tokens marking it; and  $\delta$  is the second part of the execution state, storing for each message edge the current number of message tokens marking it. Specifically,  $\delta : \mathbb{M} \rightarrow \mathbb{N}$  is a function mapping message edges to numbers of message tokens; so that  $\delta(p_1, p_2, m) = n$  means that there are  $n$  messages of type  $m$  sent by  $p_1$  and stored in the  $p_2$ 's queue. Update and initial state for  $\delta$  are defined in a way similar to  $\sigma$ 's definitions.

The transition relation  $\xrightarrow{l}$  over collaboration configurations formalizes the execution of a collaboration in terms of edge and message markings evolution. It is defined by the rules in Fig. 9; for the sake of presentation, we omit the rules concerning start/end events and gateways, as they are the same of those for choreographies (reported in Fig. 6). As usual, we omit the collaboration structure from the target configuration of transitions.

We now briefly comment on the operational rules. Rule  $C\text{-Event}G$  is activated when there is a token in the incoming edge of an event-based gateway and there is a message  $m$  to be consumed, so that the application of the rule moves the token from the incoming edge to the outgoing edge corresponding to the received message, whose number of message tokens in the meantime is decreased (i.e., a message from the corresponding queue is consumed). Rule  $C\text{-Task}$  deals with simple tasks, acting as a pass through. Rule  $C\text{-TaskRcv}$  is activated not

$$\boxed{\begin{array}{c} \frac{\langle C, \sigma, \delta \rangle \xrightarrow{l} \langle \sigma', \delta' \rangle}{\langle C/L, \sigma, \delta \rangle \xrightarrow{l} \langle \sigma', \delta' \rangle} \quad l \notin L \qquad \frac{\langle C, \sigma, \delta \rangle \xrightarrow{l} \langle \sigma', \delta' \rangle}{\langle C/L, \sigma, \delta \rangle \xrightarrow{\tau} \langle \sigma', \delta' \rangle} \quad l \in L \end{array}}$$

Figure 10: Hiding Operator.

only when there is a token in the incoming edge, like the one related to simple tasks, but also when there is a message to be consumed. Similarly, rule *C-TaskSnd*, instead of consuming, adds a message in the corresponding queue. Rule *C-InterRcv* (resp. *C-InterSnd*) follows the same behavior of rule *C-TaskRcv* (resp. *C-TaskSnd*).

**Conformance Checking.** This section discusses about the relations we propose for checking the conformance between choreographies and collaborations. We then present how they work in practice.

*Bisimulation-Based and Trace-Based Conformance.* Here we present the Bisimulation-Based Conformance (BBC) and the Trace-Based Conformance (TBC) relations we have defined. The two relations are inspired by well-established behavioural equivalences [Mil89], largely used in the literature and revised to deal with BPMN characteristics.

Before providing the formal definition of BBC, we introduce the necessary notation.  $\mathcal{Ch}$  and  $\mathbb{C}$  represents the sets of all choreography and collaboration configurations, respectively. Moreover, weak transitions are defined as follows:  $\Rightarrow$  denotes the reflexive and transitive closure of  $\xrightarrow{\tau}$ , i.e. zero or more  $\tau$ -transitions;  $\xRightarrow{l}$  denotes  $\Rightarrow \xrightarrow{l} \Rightarrow$ . We exploit functions  $labels(C)$  and  $labels(Ch)$  returning the sets of all communication labels that can be potentially generated by the collaboration  $C$  and the choreography  $Ch$ , respectively. These functions are inductively defined on the syntax of collaboration and choreography structures in a straightforward way. For example, in case of choreographies we have the definition case  $labels(\text{task}(e_i, e_o, p_1, p_2, m)) = \{o_1 \rightarrow o_2 : m\}$ , meaning that if a choreography contains a task element, then its label set contains the label corresponding the message exchange described by the task.

At the collaboration level the definition of conformance requires the use of the hiding operator  $C/L$ , defined by the rules in Fig. 10. This operator, as usual, transforms into  $\tau$  all the actions in the set  $L$ , in order to consider them as internal actions in the conformance relation.

**Definition 1. - BBC Relation.** A relation  $\mathcal{R} \subseteq (\mathcal{Ch} \times \mathbb{C})$  is a weak Bisimulation Conformance if, for any  $\langle Ch, \sigma_{ch} \rangle \in \mathcal{Ch}$  and  $\langle C, \sigma_c, \delta \rangle \in \mathbb{C}$  such that  $\langle Ch, \sigma_{ch} \rangle \mathcal{R} \langle C, \sigma_c, \delta \rangle$ , it holds:

- for all  $o_1, o_2, m$  and  $\sigma'_{ch}$ , if  $\langle Ch, \sigma_{ch} \rangle \xrightarrow{o_1 \rightarrow o_2 : m} \sigma'_{ch}$   
then  $\langle C, \sigma_c, \delta \rangle \xrightarrow{o_1 \rightarrow o_2 : m} \langle \sigma'_c, \delta' \rangle$  for some  $\sigma'_c, \delta'$  s.t.  $\langle Ch, \sigma'_{ch} \rangle \mathcal{R} \langle C, \sigma'_c, \delta' \rangle$ ;
- for all  $o_1, o_2, m, \sigma'_c$  and  $\delta'$ , if  $\langle C, \sigma_c, \delta \rangle \xrightarrow{o_1 \rightarrow o_2 : m} \langle \sigma'_c, \delta' \rangle$   
then  $\langle Ch, \sigma_{ch} \rangle \xrightarrow{o_1 \rightarrow o_2 : m} \sigma'_{ch}$  for some  $\sigma'_{ch}$  s.t.  $\langle Ch, \sigma'_{ch} \rangle \mathcal{R} \langle C, \sigma'_c, \delta' \rangle$ ;
- for all  $\sigma'_{ch}$ , if  $\langle Ch, \sigma_{ch} \rangle \xrightarrow{\tau} \sigma'_{ch}$   
then  $\langle C, \sigma_c, \delta \rangle \xRightarrow{} \langle \sigma'_c, \delta' \rangle$  for some  $\sigma'_c, \delta'$  s.t.  $\langle Ch, \sigma'_{ch} \rangle \mathcal{R} \langle C, \sigma'_c, \delta' \rangle$ ;
- for all  $\sigma'_c$  and  $\delta'$ , if  $\langle C, \sigma_c, \delta \rangle \xrightarrow{\tau} \langle \sigma'_c, \delta' \rangle$   
then  $\langle Ch, \sigma_{ch} \rangle \xRightarrow{} \sigma'_{ch}$  for some  $\sigma'_{ch}$  s.t.  $\langle Ch, \sigma'_{ch} \rangle \mathcal{R} \langle C, \sigma'_c, \delta' \rangle$ .



A choreography  $\langle Ch, \sigma_{ch} \rangle$  and a collaboration  $\langle C, \sigma_c, \delta \rangle$  conform if there exists a weak Bisimulation Conformance relation  $\mathcal{R}$  such that  $\langle Ch, \sigma_{ch} \rangle \mathcal{R} \langle C / (\text{labels}(C) \setminus \text{labels}(Ch)), \sigma_c, \delta \rangle$ .

The proposed BBC relation considers to conform collaborations that are able to simulate step by step choreographies, and vice versa. In particular, if the choreography performs a message exchange, in the collaboration we expect to observe the reception of the message, possibly preceded or followed by any number of internal actions, and then the two continuations have to be in relation. Analogously, if we observe a message reception in the collaboration, the choreography has to reply with the corresponding weak transition. Moreover, if one of the two models performs an internal action, the counterpart can react with a weak transition  $\Rightarrow$ . The definition of conformance is quite close to a standard bisimulation relation, except for the use of the hiding operator at the collaboration level. Specifically, the hiding is used to ignore all additional behaviors in the collaboration that are not explicitly expressed, and hence regulated, in the choreography. In this way, even if a collaboration performs some additional communications, if it is able to (bi)simulate with the given choreography, they do conform. The different communication models defined in the semantics of choreographies and collaborations significantly affects the conformance checking. Considering that collaborations rely on an asynchronous communication model, one may think that the collaboration actions to be observed should be the sending ones (as, e.g., in the labeled bisimulation introduced for asynchronous  $\pi$ -calculus [ACS98]). However, our aim here is to check the conformance with respect to a choreography model that, at a higher level of abstraction, prescribes that all interactions are synchronous. Since the non-blocking nature of message sending in the asynchronous collaborations may generate misalignment with the message exchanges defined in the synchronous choreography, we focus only on the message reception in the collaboration (see rules *C-EventG*, *C-TaskRcv* and *C-InterRcv* in Fig. 9). This permits to compare a choreography communication with the effective completion of the message exchange, defined by a message reception, in the collaboration.

BBC guarantees that the collaboration takes decisions, concerning the execution flow, exactly as what is specified in the choreography. Sometimes this condition may be too restrictive and the system designer would prefer to adopt a weaker relation. To this aim, in our work we also introduce the more relaxed TBC relation. Intuitively, in this case two models conform if and only if they can perform exactly the same weak sequences of actions. In the definition below, we deem a label to be *visible* if it is of the form  $o_1 \rightarrow o_2 : m$ . Notationally, the transition  $\langle Ch, \sigma \rangle \xrightarrow{s} \sigma'$ , where  $s$  is a sequence of visible labels  $l_1 l_2 \dots l_n$ , denotes the sequence  $\langle Ch, \sigma \rangle \xrightarrow{l_1} \langle Ch, \sigma_1 \rangle \xrightarrow{l_2} \langle Ch, \sigma_2 \rangle \dots \xrightarrow{l_n} \langle Ch, \sigma' \rangle$  of weak transitions. Transition  $\langle C, \sigma, \delta \rangle \xrightarrow{s} \langle \sigma', \delta' \rangle$  is similarly defined.

**Definition 2. - TBC Relation.** A choreography  $\langle Ch, \sigma_{ch} \rangle$  and a collaboration  $\langle C, \sigma_c, \delta \rangle$  trace conform if, given  $C' = C / (\text{labels}(C) \setminus \text{labels}(Ch))$ , for any sequence  $s$  of visible labels it holds:

- $\langle Ch, \sigma_{ch} \rangle \xrightarrow{s} \sigma'_{ch}$  implies  $\langle C', \sigma_c, \delta \rangle \xrightarrow{s} \langle \sigma'_c, \delta' \rangle$  for some  $\sigma'_c$  and  $\delta'$ ;
- $\langle C', \sigma_c, \delta \rangle \xrightarrow{s} \langle \sigma'_c, \delta' \rangle$  implies  $\langle Ch, \sigma_{ch} \rangle \xrightarrow{s} \sigma'_{ch}$ .

The TBC relation guarantees that the collaboration is able to produce the same sequences of messages of the choreography, and vice versa, without controlling presence of deadlock states and distinguishing different decision points and non-determinism forms. Concerning

Cases	Bank	Customer	Booking System	Well-composed	TBC	BBC
1	a	b	d	yes	false	false
2	a	b	e	no	-	-
3	a	b	f	no	-	-
4	a	c	d	no	-	-
5	a	c	e	yes	true	true
6	a	c	f	yes	true	false

Table 1: Possible Processes Combination

this latter point, BBC can recognize dominated non-determinism, where a participant (non-deterministically) takes a decision using a XOR gateway and the other behaves accordingly, from non-dominated non-determinism, based on a race condition among the messages managed by an event-based gateway. As it usually happens for these classes of behavioural relations, models that conform according to BBC also conform according to TBC.

*Conformance at work.* To demonstrate in practice the characteristics of the conformance relations, focusing on the management of non-determinism and asynchronous messages, we test them considering the various process model presented in Fig. 4, where three participants are involved.

Combining the processes reported in Fig. 4 we have six different possibilities to enable the choreography, according to different selections of the processes for the customer and the booking system roles. As shown in Table 1, these combinations will lead to different results with respect to the actual capability to enact the choreography. In particular, both syntactically and semantically related issues can emerge.

The combination of processes in cases 2, 3 and 4 violate the notion of well-composedness, since in cases 2 and 3 the Booking system  $e$  and  $f$  contain an extra *ack* message not correctly managed by Customer 1. Case 4 instead is in the opposite situation, where Customer 2 is expecting an ack message not correctly managed by Booking System 1. Cases 1, 5 and 6 are different, as the processes once combined satisfy the notion of well-composedness given in the Definition 1, which guarantees the correct matching of all messages between the processes. However, when compared to the choreography, just one of these cases satisfies the BBC, while the other two satisfy only the TBC conformance notion; the reader can deeply explore these concepts in the next section.

The conformance checking results reported in the table show in detail the differences between BBC and TBC. The designer can select the more appropriate relation that fits more his needs, taking into account that BBC provides more guarantees on the correct behaviour between the two models, while TBC ensures only that both models produce the same sequences of messages.

## 5. FROM THEORY TO PRACTICE: $C^4$ TOOL

The  $C^4$  formal framework presented so far it has been implemented as a web-based toolchain<sup>1</sup> that permits to cover the entire choreography life process. The tool supports system designers in modelling diagrams, and in the verification of conformance between a set of modelled

<sup>1</sup>The tool is available on-line at the following link <http://pros.unicam.it/c4/>

processes composed to form a collaboration and a prescribed choreography. A distinctive aspect of the tool is its ability to hide the underlining formal technicalities, so to be usable also to those BPMN designers and software engineers that are not familiar with formalisms and related verification techniques.

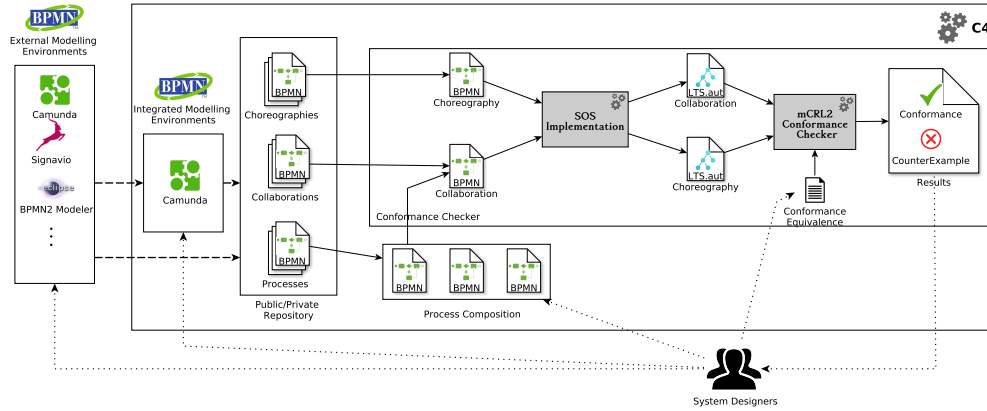
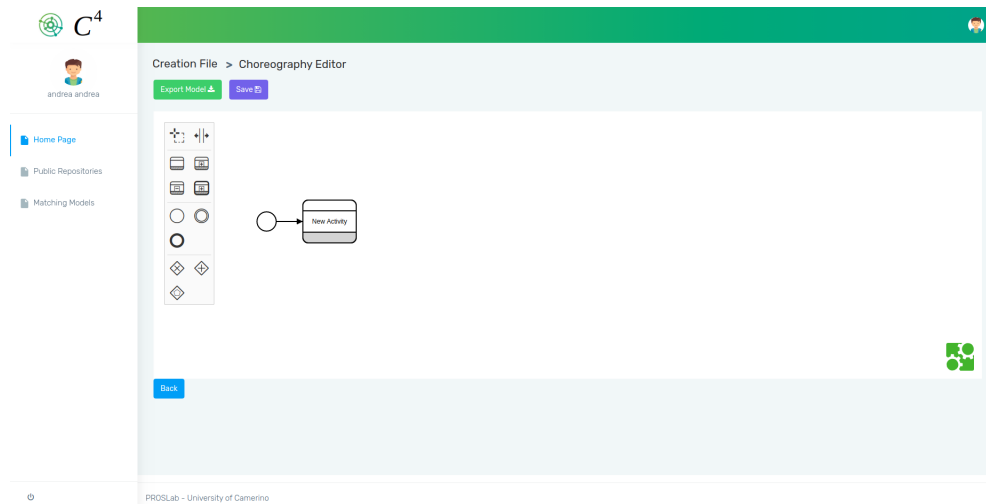

Figure 11:  $C^4$  Supporting Tool.

Fig. 11 depicts the internal components of the  $C^4$  tool, and its interfaces with the user. Specifically,  $C^4$  is able to manage choreography, collaboration and process models in the *.bpmn* format. These input models can be generated by a system designer using the Camunda modeller, which has been fully integrated in the  $C^4$  platform (Fig. 12(a)), or other external BPMN modelling environments. Indeed, the  $C^4$  platform is compatible with the most common modelling environments, such as Eclipse BPMN Modelling, Camunda and Signavio. Once the user has selected the models to consider, it is possible to further manipulate them. In particular the  $C^4$  framework permits to compose processes according to the approach formalised in Definition 2. The result of such an activity will be a new collaboration diagram containing the selected processes that are connected through messages matched with respect to their names and flow directions.

Generated collaborations can be then checked with respect to selected choreography diagrams. The access to such a functionality is provided via a dedicated GUI (Fig. 12(b)). Here the user can select both the choreography and the collaboration models that have to be compared. Designed models are saved by the editor on a remote folder based repository, and can then be loaded by the user selecting them through the dedicated GUI. At this point, clicking on the submit button, the  $C^4$  tool parses the models and generates the corresponding LTS graphs for both the choreography and the collaboration models. The parsing of the input files is based on the Camunda APIs, while the LTSs are generated by means of a Java implementation of the direct semantics defined in Section 4.

Once the LTSs are generated,  $C^4$  saves the results in two *.aut* files [FGK<sup>+</sup>96]. It is now possible to run the conformance checker with respect to a conformance relation that has to be selected by the user through a drop-down list. The conformance checking is implemented using mCRL2[GM14], which has been fully integrated in the  $C^4$  tool. Notably, the standard bisimulation and trace equivalences supported by mCRL2 can be directly used at this stage, as all the specific characteristics of our conformance relations (e.g., the use of hiding) have been already taken into account during the LTS generation. The verification results consists in a boolean message that reports the value `true` in case the collaboration



(a) Models Selection.

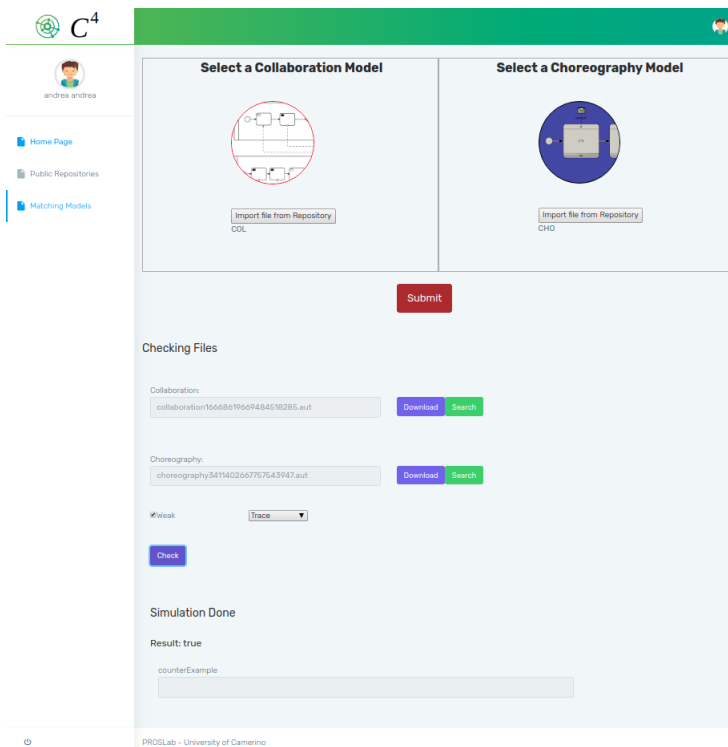

(b) Conformance Checker.

Figure 12:  $C^4$  Graphical User Interface.

confirms the choreography with respect to the selected conformance relation, or **false** in case the conformance does not hold. In the latter case, the corresponding counterexample is returned. Notably, the  $C^4$  conformance checker (Fig. 12(b)) allows to have a preview of the LTS graph or download it in the *.aut* format. This enables the possibility to run the

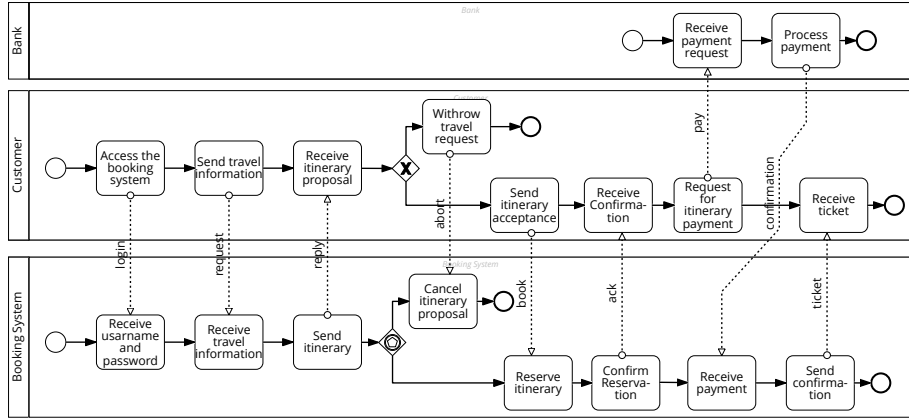

Figure 13: Booking Collaboration conformant to the Choreography.

verification using other model checkers. The tool is also available as a stand-alone solution, only with respect to the model checking functionality.

***C<sup>4</sup> tool at work on the booking example.*** In order to show the usage of the proposed approach, here we focus on the checking of the well-composed collaborations depicted in Table 1. The objective is to check if the generated collaborations are valid implementations of the choreography in Fig. 2.a, considering both the BBC and TBC relations.

Analysing the first case in Table 1 we realise that by combining the processes in Fig 4.a, Fig 4.b and Fig 4.d we obtain the collaboration in Fig. 2.b. Now checking the collaboration in Fig. 2.b with respect to the choreography in Fig. 2.a we obtain in return the violations for both conformance relations. More specifically, considering TBC the following counterexample is reported:

$$c \rightarrow bs:login, c \rightarrow bs:request, bs \rightarrow c:reply, c \rightarrow bk:pay$$

where  $c$ ,  $bs$  and  $bk$  stand for the customer, booking system and bank participant names, respectively. This trace is allowed by the collaboration model and not by the choreography model. It shows that the reasonable behaviour ‘book and then pay’ is not respected in the collaboration, which indeed permits to pay a reservation before booking it. This undesired behaviour is due to the non-blocking nature of the collaboration sending task, which permits to the customer to send the payment immediately after the booking request, without waiting for any acknowledgement from the booking system. This would not be a problem in case of a collaboration with only two participants, or more generally when the receiver of the two messages is the same. In this case the order in which the messages will be processed is managed by the behaviour of the receiver. Instead, in our running scenario the *book* and the *pay* messages are received by two different participants.

The problem, instead, does not manifest in the composition in case 5 of Table 1. The resulting collaboration is shown in Fig. 13. In this example an *ack* message between the *book* and *pay* messages has been included. This guarantees that the booking phase completes before giving to the customer the possibility to proceed with the payment. In fact, by checking the conformance between this collaboration and the choreography in Fig 2.a, the *C<sup>4</sup>* tool states that the collaboration is a correct implementation of the choreography, as the two models conform according to both TBC and BBC. Notably, the added message is not foreseen by the choreography specification, nonetheless it permits to further constrain the collaboration so to obtain a behaviour satisfying both conformance relations. In such a

case, before the conformance checking, the hiding operator (used in the definition of our conformance relations) will replace the *ack* message by a  $\tau$  action in the composition of the various participants in the collaboration.

The last well-composed collaboration is represented by case 6 of Table 1. This case differs from the previous case 5 just for the gateway in the booking system process. The resulting collaboration is not conformant to the choreography according to the BBC relation. The produced counterexample permits to detect a deadlock related to the presence of two external choices. Notice that the collaboration satisfies instead the TBC relation, since the produced traces are the ones expected in the choreography specification.

## 6. RELATED WORKS

This section discusses the advantages and differences in our approach with respect to alternative proposals. The discussion is organized over different paragraphs; each one devoted to a specific aspect considered relevant for  $C^4$ .

***On the Choice of the Modelling Notation.*** Researchers have worked in the definition and the study of modelling notations for the representation of collaborative systems for many years now. In particular, the topic has received much attention in the field of service-oriented applications, where many modelling languages have been proposed. Among the first proposal, we can certainly mention the OASIS standard WS-BPEL [OAS07]). This is a notation permitting to specify collaborations that were referred as “abstract orchestrations”, and the W3C standard WS-CDL [KBR04] for the representation of choreographies. These specifications have inspired the OMG standard BPMN [OMG11] that has inherited many concepts from those specifications. In literature, many proposals are available for conformance relations among models defined in different notations [PTDL07, BBM<sup>+</sup>05, LMX07, EKdMSvdA08, RFG10, Mar03]. However, the lack of a solid framework for the conformance verification related to the BPMN standard has motivated our effort.

***From Choreographies to Code.*** In the development of collaborative systems, much effort has been devoted to the study of model transformation approaches in particular in the line of model-driven engineering strategies. In particular, choreographies specifications have been fruitfully used in the generation of component stubs/skeletons embedding constraints of the message flow. In [HH08b], the authors propose a top-down approach, where, starting from a choreography they derive a UML profile respecting the global specification with the final aims to derive WS-BPEL processes. In [NWM17] the authors provide a semi-automatic RESTful implementation of BPMN choreographies interactions. Nevertheless considered approaches do not provide any formal guarantee to ensure that the resulting system conforms to the interactions prescribed by the specification.

***Conformance.*** In literature, conformance is referred with different terminologies depending on the context in which it is used. Possible synonymous are compliance or compatibility, but generally, they are never explicitly defined on the BPMN standard. Different works in literature [GMS06, MM03, SLM<sup>+</sup>10, ADW08, KRFRM13, LRMGD12, KR12, KRM<sup>+</sup>12] define notion of compliance between processes or collaborations exploiting domain-specific regulations and rules. In general, these works express behavioural constraints using some form of temporal logics, rather than using equivalences among models. The usage of additional languages requires the system designer to study further technicalities in order

to exploit the proposed checking technique. Alternative approaches base the analysis only considering local views [WDW12, HDvdA<sup>+</sup>05, DDGB09]. Somehow this is a simplification of the problem that does not guarantee the conformance for the composition.

Our work differs from the ones mentioned above since it relies on on BPMN models, at both global and local level, and propose a conformance check between a different layer of specification abstraction without requiring any formal knowledge to the system designer.

**Direct Semantics.** Many attempts in the literature are present, trying to give a semantics to a BPMN notation. The majority of these approaches provide semantics in terms of translation to other formalization languages such as Petri-nets or similar formalisms. Providing semantics by translation can generate divergences with the expected behaviour of the elements. Between the target specification languages, we found process algebras [BGG<sup>+</sup>06, SB09, SBS06], formal languages (e.g., LOTOS) [NPZ12, PS12, MS13, GPSY16], transition-based models (e.g., Petri Nets) [DDO08, BB11, BFF09, CPR15], or session types [CDP11].

In  $C^4$  we rely on a direct semantics for both collaboration and choreography models. The  $C^4$  semantics is given in terms of features and constructs of BPMN, rather than in terms of their low-level encoding into another formalism that is equipped with its own syntax and semantics. This permits to avoid any possible bias that would result from the encoding in another formalism. The direct semantics proposed in this paper is inspired by [CPRT15], and by its extended version in [CFP<sup>+</sup>18]. Differences mainly refer to configuration states that are here defined according to a global perspective. Moreover, the formalisation now includes choreography diagrams, which were overlooked in the previous semantics definition.

**Conformance vs Communication models.** The definition of semantics using other languages can bring to underspecified situations that can alter the conformance checking results. For this reason, we use a direct approach that permits to focus on specific features of BPMN that would be ignored by using available Petri Nets-based semantics. Evidence of this divergence can be noticed in the definition of gateways. Following the BPMN mapping to Petri Nets proposed in [DDO08], it is not possible to distinguish different types of non-determinism resulting from event-based or exclusive gateways [CMRT19]. Indeed these two BPMN elements have different effects: the event-based gateway produces non-dominated non-determinism (roughly, no one in the model has complete knowledge on the decision that will be taken), while the exclusive gateway produces dominated non-determinism (roughly, the decision is taken by one party and followed by the others). Differently from the translation-based approaches, our approach permits to distinguish the dominated and non-dominated non-determinism produced by the gateways, as prescribed by the BPMN standard. This is somehow similar to [BGG<sup>+</sup>06, QZCY07], which rely on the concept of internal and external choices defined in the CSP process algebra. Notably, the different kinds of non-determinism have an impact on the conformance relations, as detailed in Table 1.

Another fundamental aspect for the definition of the conformance is the asynchronous communication of collaborations versus the synchronous one of the choreographies. In literature, to deal with asynchronous communication, either additional constructs are used, such as buffers [PS12] or dedicate language structures [SB09, GPSY16], or simply reducing the asynchronous communication model to the synchronous one. The notions of conformances that we propose in  $C^4$  allows the user to compare models assuming different communication strategies without making any assumption on the different management of the messages. Our conformance notion directly manages this aspect.

**Tool Support.** Verchor [GPSY16] is a tool similar to  $C^4$ . In this case, the main objective is to use the conformance notion to check the realizability of a set of peers obtained from a projection of a given choreography. Another tool, more focused on business properties is VBPMN [KPS17]. Here the verification makes use of the well-known model checker CADP. While VBPMN can deal only with the analysis of single processes  $C^4$  is able to manage the conformance checking of collaborations w.r.t. choreographies.

## 7. CONCLUSIONS AND FUTURE WORK

This paper considers the theoretical and practical relevance of checking the conformance of models related to the global specification of application-level protocols (choreographies) and their possible implementation through the composition of processes (collaborations). The specific context is that of the BPMN standard, which nowadays is the most used notation for specifying inter-organisational processes. To perform such conformance checking, the paper proposes a direct semantics in the structural operational style, and defines two different equivalence relations between choreographies and process collaborations. The resulting formal framework has also been practically implemented in the  $C^4$  toolchain, which permits to support all phases needed to derive inter-organisational process-based systems. The tool is available as a web-based services, as well as a standalone application.

In the next future, we intend to extend the framework further, so to possibly check temporal properties on choreographies and collaborations. Another aspect we plan to investigate concerns the repository storing the published choreographies and the available processes; we foresee for this repository further developments and a better integration with  $C^4$ . Finally, an interesting line of research that we intend to follow refers to the usage of inter-organisational models to facilitate the integration of existing services, so to make easier the development of the considered collaborative systems.

## REFERENCES

- [AAP13] Midhat Ali, Guglielmo De Angelis, and Andrea Polini. Servicepot - an extensible registry for choreography governance. In *SOSE*, pages 113–124. IEEE Computer Society, 2013.
- [ABN<sup>+</sup>08] Aitor Aldazabal, Terry Baily, Felix Nanclares, Andrey Sadovykh, Christian Hein, and Tom Ritter. Automated model driven development processes. In *Model Driven Tool and Process Integration*, pages 361 – 375. Fraunhofer IRB Verlag, 2008.
- [ACS98] Roberto M. Amadio, Ilaria Castellani, and Davide Sangiorgi. On bisimulations for the asynchronous pi-calculus. *Theor. Comput. Sci.*, 195(2):291–324, 1998.
- [ADW08] Ahmed Awad, Gero Decker, and Mathias Weske. Efficient compliance checking using bpmn-q and temporal logic. In *BPM*, volume 5240 of *LNCS*, pages 326–341. Springer, 2008.
- [BB11] Samik Basu and Tevfik Bultan. Choreography conformance via synchronizability. In *World wide web*, pages 795–804. ACM, 2011.
- [BBM<sup>+</sup>05] Matteo Baldoni, Cristina Baroglio, Alberto Martelli, Viviana Patti, and Claudio Schifanella. Verifying the conformance of web services to global interaction protocols: A first step. In *Formal Techniques for Computer Systems and Business Processes*, volume 3670 of *LNCS*, pages 257–271. Springer, 2005.
- [BFF09] Tevfik Bultan, Chris Ferguson, and Xiang Fu. A tool for choreography analysis using collaboration diagrams. In *ICWS*, pages 856–863. IEEE, 2009.
- [BGG<sup>+</sup>06] Nadia Busi, Roberto Gorrieri, Claudio Guidi, Roberto Lucchi, and Gianluigi Zavattaro. Choreography and orchestration conformance for system design. In *Coordination*, volume 4038 of *LNCS*, pages 63–81. Springer, 2006.



- [CDP11] Giuseppe Castagna, Mariangiola Dezani, and Luca Padovani. On global types and multi-party sessions. In *FMOODS/FORTE*, volume 6722 of *LNCS*, pages 1–28. Springer, 2011.
- [CFP<sup>+</sup>18] F. Corradini, F. Fornari, A. Polini, B. Re, and F. Tiezzi. A formal approach to modeling and verification of business process collaborations. *Science of Computer Programming*, 166:35–70, 2018.
- [CFP<sup>+</sup>19] Flavio Corradini, Fabrizio Fornari, Andrea Polini, Barbara Re, and Francesco Tiezzi. Repository: a repository platform for sharing business process models. In *BPM (PhD/Demos)*, volume 2420 of *CEUR Workshop Proceedings*, pages 149–153. CEUR-WS.org, 2019.
- [CMRT19] Flavio Corradini, Andrea Morichetta, Barbara Re, and Francesco Tiezzi. Walking through the semantics of exclusive and event-based gateways in BPMN choreographies. In *The Art of Modelling Computational Systems: A Journey from Logic and Concurrency to Security and Privacy - Essays Dedicated to Catuscia Palamidessi on the Occasion of Her 60th Birthday*, pages 163–181, 2019.
- [CPR15] Flavio Corradini, Andrea Polini, and Barbara Re. Inter-organizational Business Process Verification in Public Administration. *Business Process Management Journal*, 21(5), 2015.
- [CPRT15] Flavio Corradini, Andrea Polini, Barbara Re, and Francesco Tiezzi. An operational semantics of BPMN collaboration. In *FACS*, volume 9539 of *LNCS*, pages 161–180. Springer, 2015.
- [DBL]
- [DDGB09] Remco Dijkman, Marlon Dumas, and Luciano García-Bañuelos. Graph matching algorithms for business process model similarity search. In *BPM*, volume 5701 of *LNCS*, pages 48–63. Springer, 2009.
- [DDO08] Remco M. Dijkman, Marlon Dumas, and Chun Ouyang. Semantics and analysis of business process models in BPMN. *Information and Software Technology*, 50(12):1281–1294, 2008.
- [EKdMSvdA08] Marwane El Kharbili, Ana Karla A de Medeiros, Sebastian Stein, and Wil MP van der Aalst. Business process compliance checking: Current state and future challenges. *MobIS*, 141:107–113, 2008.
- [FGK<sup>+</sup>96] Jean Fernandez, Hubert Garavel, Alain Kerbrat, Laurent Mounier, Radu Mateescu, and Mihaela Sighireanu. CADP a protocol validation and verification toolbox. In *CAV*, volume 1102 of *LNCS*. Springer, 1996.
- [GM14] Jan Friso Groote and Mohammad Reza Mousavi. *Modeling and analysis of communicating systems*. MIT press, 2014.
- [GMS06] Guido Governatori, Zoran Milosevic, and Shazia Sadiq. Compliance checking between business processes and business contracts. In *EDOC*, pages 221–232. IEEE, Computer Society, 2006.
- [GPSY16] Matthias GÜdemann, Pascal Poizat, Gwen Salaün, and Lina Ye. Verchor: a framework for the design and verification of choreographies. *IEEE Transactions on Services Computing*, 9(4):647–660, 2016.
- [HDvdA<sup>+</sup>05] Jan Hidders, Marlon Dumas, Wil MP van der Aalst, Arthur HM ter Hofstede, and Jan Verelst. When are two workflows the same? In *Australasian symposium on theory of computing*, volume 41, pages 3–11. Australian Computer Society, Inc., 2005.
- [HH08a] B. Hofreiter and C. Huemer. A model-driven top-down approach to inter-organizational systems: From global choreography models to executable bpel. In *2008 10th IEEE Conference on E-Commerce Technology and the Fifth IEEE Conference on Enterprise Computing, E-Commerce and E-Services*, pages 136–145, July 2008.
- [HH08b] Birgit Hofreiter and Christian Huemer. A model-driven top-down approach to inter-organizational systems: From global choreography models to executable BPEL. In *CEC/EEE*, pages 136–145. IEEE, IEEE Computer Society, 2008.
- [KBR04] N. Kavantzaz, D. Burdett, and G. Ritzinger. Web Services Choreography Description Language version 1.0. Technical report, W3C, 2004.
- [KPS17] Ajay Krishna, Pascal Poizat, and Gwen Salaün. Vbpmn: Automated verification of bpmn processes. In *iFM*, pages 323–331. Springer, 2017.
- [KR12] David Knuplesch and Manfred Reichert. Ensuring business process compliance along the process life cycle. Technical report, Universität Ulm, 2012.

- [KRFRM13] David Knuplesch, Manfred Reichert, Walid Fdhila, and Stefanie Rinderle-Ma. On enabling compliance of cross-organizational business processes. In *BPM*, volume 8094 of *LNCS*, pages 146–154. Springer, 2013.
- [KRM<sup>+</sup>12] David Knuplesch, Manfred Reichert, Jürgen Mangler, Stefanie Rinderle-Ma, and Walid Fdhila. Towards compliance of cross-organizational processes and their changes. In *BPM*, volume 132 of *LNCS*, pages 649–661. Springer, 2012.
- [LMX07] Ying Liu, Sebastian Muller, and Ke Xu. A static compliance-checking framework for business process models. *IBM Systems Journal*, 46(2):335–361, 2007.
- [LRMGD12] Linh Thao Ly, Stefanie Rinderle-Ma, Kevin Göser, and Peter Dadam. On enabling integrated process compliance with semantic constraints in process management systems. *Information Systems Frontiers*, 14(2):195–219, 2012.
- [Mar03] Axel Martens. On compatibility of web services. *Petri Net Newsletter*, 65(12-20):100, 2003.
- [Mil89] R. Milner. *Communication and Concurrency*, volume 84. Prentice-Hall, Inc., 1989.
- [MM03] Daniel J Mandell and Sheila A McIlraith. A bottom-up approach to automating web service discovery, customization, and semantic translation. In *WWW Workshop on E-Services and the Semantic Web*, 2003.
- [MS13] Carlos Molina and Santosh Shrivastava. Establishing conformance between contracts and choreographies. In *CBI*, pages 69–78. IEEE, 2013.
- [NPZ12] Huu Nghia Nguyen, Pascal Poizat, and Fatiha Zaïdi. A symbolic framework for the conformance checking of value-passing choreographies. In *ICSOC*, volume 2012 of *LNCS*, pages 525–532. Springer, 2012.
- [NWM17] Adriatik Nikaj, Mathias Weske, and Jan Mendling. Semi-automatic derivation of restful choreographies from business process choreographies. *Software & Systems Modeling*, pages 1–14, 2017.
- [OAS07] OASIS WSBPEL TC. Web Services Business Process Execution Language Version 2.0. Technical report, OASIS, April 2007.
- [OMG11] OMG. Business Process Model and Notation (BPMN V 2.0), 2011.
- [Pas17] Oscar Pastor. Model-driven development in practice: From requirements. In *Theory and Practice of Computer Science*, volume 10139 of *LNCS*, pages 405–410. Springer, 2017.
- [PS12] Pascal Poizat and Gwen Salain. Checking the realizability of BPMN 2.0 choreographies. In *Symposium on Applied Computing*, pages 1927–1934. ACM, 2012.
- [PTDL07] Michael P Papazoglou, Paolo Traverso, Schahram Dustdar, and Frank Leymann. Service-oriented computing: State of the art and research challenges. *Computer*, 40(11), 2007.
- [QZCY07] Zongyan Qiu, Xiangpeng Zhao, Chao Cai, and Hongli Yang. Towards the theoretical foundation of choreography. In *WWW*, pages 973–982. ACM, 2007.
- [RFG10] Mohsen Rouached, Walid Fdhila, and Claude Godart. Web services compositions modelling and choreographies analysis. *International Journal of Web Services Research (IJWSR)*, 7(2):87–110, 2010.
- [SB09] Gwen Salaün and Tefik Bultan. Realizability of choreographies using process algebra encodings. In *iFM*, volume 5423 of *LNCS*, pages 167–182. Springer, 2009.
- [SBS06] Gwen Salaün, Lucas Bordeaux, and Marco Schaerf. Describing and reasoning on web services using process algebra. *Int. J. of Business Process Integration and Management*, 1(2):116–128, 2006.
- [SLM<sup>+</sup>10] David Schumm, Frank Leymann, Zhilei Ma, Thorsten Scheibler, and Steve Strauch. Integrating compliance into business processes. *Multikonferenz Wirtschaftsinformatik 2010*, page 421, 2010.
- [WDW12] Matthias Weidlich, Remco Dijkman, and Mathias Weske. Behaviour equivalence and compatibility of business process models with complex correspondences. *The Computer Journal*, 55(11):1398–1418, 2012.

## APPENDIX

We report here the proof of the proposition concerning the well-composedness of the collaboration produced by the function  $\mathcal{C}$ .

**Proposition 1.** *Let  $\overline{P}$  and  $\overline{p}$  be a tuple of processes and a tuple of participant names, respectively; if  $\mathcal{C}(\overline{P}, \overline{p}) = C$  then  $C$  is well-composed.*

*Proof.* The proof proceeds by contradiction. Suppose that there exist  $\overline{P}$  and  $\overline{p}$  such that  $\mathcal{C}(\overline{P}, \overline{p}) = C$  and  $C$  is not well-composed. By Def. 1, we have six cases (below notation  $\in^n$  means that the number of times an element occurs in the multiset is  $n$ ):

- (1)  $\exists(p, p, m) \in out(C)$ . This means that  $C$  contains a term  $taskSnd(e_i, e_o, (p, p, m))$  or a term  $interSnd(e_i, e_o, (p, p, m))$ . Let us consider the former case, the other is similar. According to the definitions of  $\mathcal{C}$  and  $\mathcal{N}$ , the sending task results from the evaluation of  $taskSnd(e_i, e_o, (S(m), R(m), m))$  for some  $S$  and  $R$  such that  $S(m) = R(m) = p$ . However, by definition of  $\mathcal{N}$ ,  $S(m) \neq R(m)$ , which is a contradiction.
- (2)  $\exists(p_1, p_2, m) \in out(C) \cdot \exists(p_1, p_2, m) \in in(C)$ . This means that  $C$  contains a term  $taskSnd(e_i, e_o, (p_1, p_2, m))$  or a term  $interSnd(e_i, e_o, (p_1, p_2, m))$ . Let us consider the former case, the other is similar. According to the definitions of  $\mathcal{C}$  and  $\mathcal{N}$ , the sending task results from the evaluation of  $taskSnd(e_i, e_o, (S(m), R(m), m))$  for some  $S$  and  $R$  such that  $S(m) = p_1$  and  $R(m) = p_2$ . The latter means that  $R$  has the form  $\{m \mapsto p_2\} \sqcup R'$  for some  $R'$ ; according to the definition of  $\mathcal{R}$ , the pair  $\{m \mapsto p_2\}$  is produced by either  $\mathcal{R}(taskRcv(e'_i, e'_o, m), p_2)$ ,  $\mathcal{R}(interRcv(e'_i, e'_o, m), p_2)$  or  $\mathcal{R}(eventBased(e''_i, ((m, e''_o), M)), p_2)$ , with  $taskRcv$ ,  $interRcv$  or  $eventBased$  term in  $C$ . Let us consider the case where  $C$  contains the term  $taskRcv(e'_i, e'_o, m)$ ; the other two cases are similar. By definition of  $\mathcal{N}$ , and using the functions  $S$  and  $R$  above, we have  $\mathcal{N}(taskRcv(e'_i, e'_o, m), S, R) = taskRcv(e'_i, e'_o, (S(m), R(m), m)) = taskRcv(e'_i, e'_o, (p_1, p_2, m))$ . By applying function  $in$  to this term, we obtain  $in(taskRcv(e'_i, e'_o, (p_1, p_2, m))) = \{(p_1, p_2, m)\}$ , hence  $(p_1, p_2, m) \in in(C)$ , which is a contradiction.
- (3)  $\exists(p_1, p_2, m) \in out(C) \cdot \exists(p_1, p_2, m) \in^2 in(C)$ . According to the definition of function  $in$ , this means that two terms of the form  $taskRcv(e_i, e_o, (p_1, p_2, m))$ ,  $interRcv(e_i, e_o, (p_1, p_2, m))$  or  $eventBased(e_i, ((p_1, p_2, m, e_o), M))$  are in  $C$ . Thus, according to the definition of  $\mathcal{N}$ , two terms of the form  $taskRcv(e_i, e_o, m)$ ,  $interRcv(e_i, e_o, m)$  or  $eventBased(e_i, ((m, e_o), M))$  are in  $\overline{P}$ , and there exists  $S$  and  $R$  such that  $S(m) = p_1$  and  $R(m) = p_2$ . Function  $R$  must result from the application of function  $\mathcal{R}$  to  $\overline{P}$ . By applying  $\mathcal{R}$  to  $\overline{P}$ , since  $\overline{P}$  contains two terms of the form  $taskRcv(e_i, e_o, m)$ ,  $interRcv(e_i, e_o, m)$  or  $eventBased(e_i, ((m, e_o), M))$ , we obtain  $\{m \mapsto p_2\} \sqcup \{m \mapsto p_2\} \sqcup R'$  for some  $R'$ . However, operator  $\sqcup$  is defined only when they arguments have disjoint domain. Hence,  $\{m \mapsto p_2\} \sqcup \{m \mapsto p_2\}$  is undefined. As consequence,  $\mathcal{C}(\overline{P}, \overline{p})$  is undefined, which is a contradiction.
- (4)  $\exists(p, p, m) \in in(C)$ . Similar to case (1).
- (5)  $\exists(p_1, p_2, m) \in in(C) \cdot \exists(p_1, p_2, m) \in out(C)$ . Similar to case (2).
- (6)  $\exists(p_1, p_2, m) \in in(C) \cdot \exists(p_1, p_2, m) \in^2 out(C)$ . Similar to case (3).

□