

A Connection between Feedback Capacity and Kalman Filter for Colored Gaussian Noises

Song Fang and Quanyan Zhu

Department of Electrical and Computer Engineering, New York University, New York, USA

Email: {song.fang, quanyan.zhu}@nyu.edu

Abstract—In this paper, we establish a connection between the feedback capacity of additive colored Gaussian noise channels and the Kalman filters with additive colored Gaussian noises. In light of this, we are able to provide lower bounds on feedback capacity of such channels with finite-order auto-regressive moving average colored noises, and the bounds are seen to be consistent with various existing results in the literature; particularly, the bound is tight in the case of first-order auto-regressive moving average colored noises. On the other hand, the Kalman filtering systems, after certain equivalence transformations, can be employed as recursive coding schemes/algorithms to achieve the lower bounds. In general, our results provide an alternative perspective while pointing to potentially tighter bounds for the feedback capacity problem.

I. INTRODUCTION

The feedback capacity [1] of additive colored Gaussian noise channels has been an important and appealing research topic in information theory, and accordingly, numerous papers have been published to study the analytical formulae (or meaningful bounds) of feedback capacity as well as the coding schemes to achieve them. In general, we refer to the breakthrough paper [2] and the references therein for a very detailed survey; see also [3], [4] for possible complementary literature reviews. Meanwhile, we also notice the many papers on this topic that have come out after [2], including but certainly not restricted to [5]–[14]. In particular, this paper employs a control-theoretic (or estimation-theoretic, say, using Kalman filter) approach to analyze feedback channels, which, in a broad sense, has a flavor similar to those of, e.g., [5]–[7], [9]–[11], [13], [15]–[17]; see also [18] and the references therein.

The difference from the previous works, however, is that in this paper we adopt the method of dealing with first-order Markov or auto-regressive (AR) colored noises without extending the state to be estimated in Kalman filtering systems, as introduced in [19], and generalize the approach to cope with higher-order auto-regressive moving average (ARMA) colored noises. Subsequently, we establish the connection between the Kalman filtering systems and the feedback channels with ARMA colored noises by carrying out certain equivalence transformations. In light of this, the algebraic Riccati equations associated with the Kalman filters provide explicit lower bounds on the feedback capacity for ARMA colored noises. Meanwhile, the Kalman filtering systems (after the equivalence transformations), which are essentially feedback systems, nat-

urally feature recursive coding schemes/algorithms to achieve the lower bounds.

The lower bounds are consistent with various results existing in the literature. Specifically, explicit formulae of feedback capacity for the first-order ARMA colored noises have been obtained in [2]–[4]; accordingly, our bounds are then shown to be tight in such a case. On the other hand, our results are seen to reduce to the lower bounds for higher-order AR colored noises that have been derived in, e.g., [15], [20]. This being said, we are aware of the fact that the lower bounds obtained in this paper are in general not tight, and it is still unclear for what other classes of colored noises the bounds are also tight in addition to the first-order ARMA colored noises, beyond which analytical formulae of feedback capacity, if they exist, are yet to be discovered [2]. On the other hand, when the bounds are indeed tight, such as in the case of the first-order ARMA colored noises, the corresponding recursive coding schemes/algorithms developed in this paper will complement the existing ones in the literature (see, e.g., [2], [3], [5], [6], [13], [15]–[17]).

In addition, the results obtained in this paper represent only the relatively preliminary explorations under the current framework; particularly, the possibly simplest Kalman filtering systems have been considered herein, with a scalar, constant system matrix a as well as a scalar, constant output matrix c . For the next step, the cases, for instance, where the system matrix a_k and output matrix c_k are scalar but time-varying, and even where the system matrix A and output matrix C are literally matrices (or vectors), are ready to be considered and may potentially lead to tighter bounds as well as additional insights into the feedback capacity problem.

The remainder of the paper is organized as follows. Section II provides the necessary background knowledge on the feedback capacity and Kalman filter as required in this paper. In Section III, we establish the connection between the lower bounds on feedback capacity (as well as the corresponding recursive coding schemes/algorithms to achieve the bounds) for additive ARMA colored Gaussian noise channels and the Kalman filtering systems with ARMA colored Gaussian noises; we also examine the relations of our lower bounds to various existing results in the literature. Conclusions are given in Section IV.

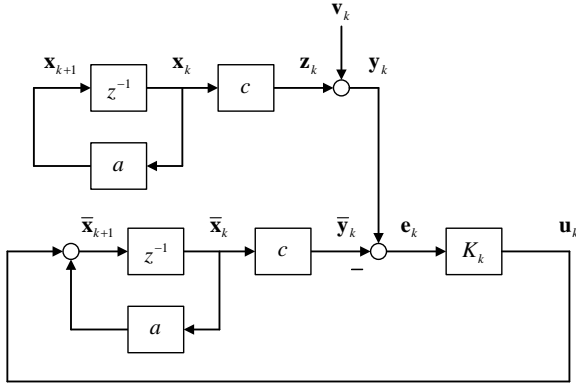

Fig. 1. The Kalman filtering system.

II. PRELIMINARIES

In this paper, we consider real-valued continuous random variables and discrete-time stochastic processes they compose. All random variables and stochastic processes are assumed to be zero-mean for simplicity and without loss of generality. We represent random variables using boldface letters. The logarithm is defined with base 2. A stochastic process $\{\mathbf{x}_k\}$ is said to be asymptotically stationary if it is stationary as $k \rightarrow \infty$, and herein stationarity means strict stationarity [21]. Definitions and properties of the information-theoretic notions such as entropy rate $h_\infty(\mathbf{x})$ can be found in, e.g., [22].

A. Feedback Capacity

Consider an additive colored Gaussian noise channel

$$\mathbf{y}_k = \mathbf{x}_k + \mathbf{z}_k,$$

where $\{\mathbf{x}_k\}$, $\mathbf{x}_k \in \mathbb{R}$ denotes the channel input, $\{\mathbf{y}_k\}$, $\mathbf{y}_k \in \mathbb{R}$ denotes the channel output, and $\{\mathbf{z}_k\}$, $\mathbf{z}_k \in \mathbb{R}$ denotes the additive noise which is assumed to be stationary colored Gaussian. The feedback capacity C_f [1] of such a channel with power constraint \bar{P} is given by [2]

$$C_f = \sup_{\{\mathbf{x}_k\}} [h_\infty(\mathbf{y}) - h_\infty(\mathbf{x})], \quad (1)$$

where the supremum is taken over all stationary channel input processes $\{\mathbf{x}_k\}$ of the form

$$\mathbf{x}_k = \sum_{i=1}^{\infty} b_i \mathbf{z}_{k-i}, \quad b_i \in \mathbb{R}, \quad (2)$$

while satisfying that $\mathbb{E}[\mathbf{x}_k^2] \leq \bar{P}$. Note that [2] provided a sequence of equivalent characterizations of the feedback capacity, and as in [5], the characterization of (1) and (2) will be adopted in this paper (see the proof of Theorem 2).

B. Kalman Filter with White Noises

We now give a brief review of (a special case of) the Kalman filter [19], [23]. Consider the Kalman filtering system

as depicted in Fig. 1, where the state-space model of the plant to be estimated is given by

$$\begin{cases} \mathbf{x}_{k+1} = a\mathbf{x}_k, \\ \mathbf{y}_k = c\mathbf{x}_k + \mathbf{v}_k. \end{cases} \quad (3)$$

Herein, $\mathbf{x}_k \in \mathbb{R}$ is the state to be estimated, $\mathbf{y}_k \in \mathbb{R}$ is the plant output, and $\mathbf{v}_k \in \mathbb{R}$ is the measurement noise (the process noise, normally denoted as $\{\mathbf{w}_k\}$ [19], [23], is assumed to be absent). The system matrix is $a \in \mathbb{R}$ while the output matrix is $c \in \mathbb{R}$, and we assume that $|a| > 1$ and $c \neq 0$; hence, the pair (a, c) is observable (and thus detectable) [24]. Suppose that $\{\mathbf{v}_k\}$ is white Gaussian with variance $\sigma_v^2 = \mathbb{E}[\mathbf{v}_k^2] > 0$ and the initial state \mathbf{x}_0 is Gaussian with variance $\mathbb{E}[\mathbf{x}_0^2]$ satisfying $0 < \mathbb{E}[\mathbf{x}_0^2] < \infty$. Furthermore, $\{\mathbf{v}_k\}$ and \mathbf{x}_0 are assumed to be uncorrelated. Correspondingly, the Kalman filter (in the observer form [24]) for (3) is given by

$$\begin{cases} \bar{\mathbf{x}}_{k+1} = a\bar{\mathbf{x}}_k + \mathbf{u}_k, \\ \bar{\mathbf{y}}_k = c\bar{\mathbf{x}}_k, \\ \mathbf{e}_k = \mathbf{y}_k - \bar{\mathbf{y}}_k, \\ \mathbf{u}_k = K_k \mathbf{e}_k, \end{cases} \quad (4)$$

where $\bar{\mathbf{x}}_k \in \mathbb{R}$, $\bar{\mathbf{y}}_k \in \mathbb{R}$, $\mathbf{e}_k \in \mathbb{R}$, and $\mathbf{u}_k \in \mathbb{R}$. Herein, K_k denotes the observer gain [24] given by

$$K_k = \frac{acP_k}{c^2P_k + \sigma_v^2},$$

where P_k denotes the state estimation error variance

$$P_k = \mathbb{E}[(\mathbf{x}_k - \bar{\mathbf{x}}_k)^2].$$

In addition, P_k can be obtained iteratively using the Riccati equation

$$P_{k+1} = a^2P_k - \frac{a^2c^2P_k^2}{c^2P_k + \sigma_v^2}$$

with $P_0 = \mathbb{E}[\mathbf{x}_0^2] > 0$.

It is known [19], [23] that since (a, c) is detectable, the Kalman filtering system converges, i.e., the state estimation error $\{\mathbf{x}_k - \bar{\mathbf{x}}_k\}$ and the ‘‘innovation’’ $\{\mathbf{e}_k\}$ are asymptotically stationary. Moreover, in steady state, the optimal state estimation error variance $P = \lim_{k \rightarrow \infty} \mathbb{E}[(\mathbf{x}_k - \bar{\mathbf{x}}_k)^2]$ attained by the Kalman filter is given by the non-zero root of the algebraic Riccati equation

$$P = a^2P - \frac{a^2c^2P^2}{c^2P + \sigma_v^2}, \quad (5)$$

whereas the steady-state Kalman gain is given by

$$K = \frac{acP}{c^2P + \sigma_v^2}. \quad (6)$$

In addition, the optimal steady-state innovation variance is

$$\sigma_e^2 = \lim_{k \rightarrow \infty} \mathbb{E}[\mathbf{e}_k \mathbf{e}_k^T] = \lim_{k \rightarrow \infty} \mathbb{E}[(\mathbf{y}_k - \bar{\mathbf{y}}_k)^2] = c^2P + \sigma_v^2.$$

It then follows from (5) that

$$\sigma_e^2 = c^2P + \sigma_v^2 = a^2\sigma_v^2,$$

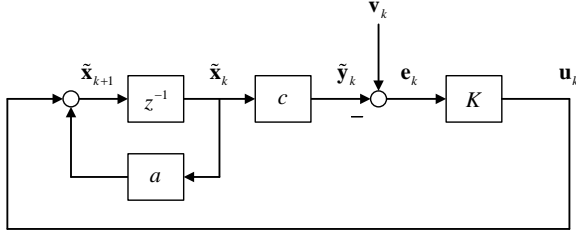

Fig. 2. The steady-state Kalman filtering system in integrated form.

and thus

$$P = \frac{a^2 - 1}{c^2} \sigma_v^2.$$

As such, (6) can be simplified as

$$K = \frac{acP}{c^2P + \sigma_v^2} = \frac{a^2 - 1}{ac}.$$

In fact, by letting $\tilde{\mathbf{x}}_k = \bar{\mathbf{x}}_k - \mathbf{x}_k$ and $\tilde{\mathbf{y}}_k = \bar{\mathbf{y}}_k - \mathbf{z}_k = \bar{\mathbf{y}}_k - c\mathbf{x}_k$, we may integrate the systems given in (3) and (4) in steady state into

$$\begin{cases} \tilde{\mathbf{x}}_{k+1} = a\tilde{\mathbf{x}}_k + \mathbf{u}_k, \\ \tilde{\mathbf{y}}_k = c\tilde{\mathbf{x}}_k, \\ \mathbf{e}_k = -\tilde{\mathbf{y}}_k + \mathbf{v}_k, \\ \mathbf{u}_k = K\mathbf{e}_k, \end{cases} \quad (7)$$

as depicted in Fig. 2. For the rest of this paper, we will adopt this equivalent, integrated form of the steady-state Kalman filtering system for simplicity.

III. LOWER BOUNDS ON FEEDBACK CAPACITY FOR ARMA COLORED NOISES

In this section, we will establish a connection between the feedback capacity of additive ARMA colored Gaussian noise channels and the Kalman filters with additive ARMA colored Gaussian noises, and then derive lower bounds on feedback capacity as well as investigate the recursive coding schemes/algorithms to achieve them. In order to do so, we shall first adapt the Kalman filter in a way so as to incorporate ARMA colored noises.

A. Kalman Filter with ARMA Colored Noises

Consider again the Kalman filtering system given in Fig. 1. Suppose that the plant to be estimated is

$$\begin{cases} \mathbf{x}_{k+1} = a\mathbf{x}_k, \\ \mathbf{y}_k = c\mathbf{x}_k + \mathbf{v}_k, \end{cases} \quad (8)$$

but this time with an ARMA colored Gaussian noise $\{\mathbf{v}_k\}$, $\mathbf{v}_k \in \mathbb{R}$ given by

$$\mathbf{v}_k = \sum_{i=1}^p f_i \mathbf{v}_{k-i} + \hat{\mathbf{v}}_k + \sum_{j=1}^q g_j \hat{\mathbf{v}}_{k-j}, \quad (9)$$

where $\{\hat{\mathbf{v}}_k\}$, $\hat{\mathbf{v}}_k \in \mathbb{R}$ is white Gaussian with $\sigma_{\hat{\mathbf{v}}}^2 = \mathbb{E}[\hat{\mathbf{v}}_k^2] > 0$. As such, $\{\mathbf{v}_k\}$ may be represented as the output of a linear

time-invariant (LTI) filter $F(z)$ driven by input $\{\hat{\mathbf{v}}_k\}$ [25], where

$$F(z) = \left(1 - \sum_{i=1}^p f_i z^{-i}\right)^{-1} \left(1 + \sum_{j=1}^q g_j z^{-j}\right). \quad (10)$$

In addition, we assume that $F(z)$ is stable and minimum-phase, that is, the inverse filter

$$F^{-1}(z) = \left(1 - \sum_{i=1}^p f_i z^{-i}\right) \left(1 + \sum_{j=1}^q g_j z^{-j}\right)^{-1} \quad (11)$$

is also stable and minimum-phase. Consequently, for $|z| \geq 1$ (see discussions in the proof of Proposition 1), we may expand

$$\left(1 - \sum_{i=1}^p f_i z^{-i}\right) \left(1 + \sum_{j=1}^q g_j z^{-j}\right)^{-1} = 1 - \sum_{i=1}^{\infty} h_i z^{-i}, \quad (12)$$

and thus $\{\hat{\mathbf{v}}_k\}$ can be reconstructed from $\{\mathbf{v}_k\}$ as [25]

$$\hat{\mathbf{v}}_k = \mathbf{v}_k - \sum_{i=1}^{\infty} h_i \mathbf{v}_{k-i}. \quad (13)$$

We may then employ the method of dealing with colored noises without extending the state of the Kalman filter, as introduced in [19] (Chapter 11), after certain modifications. In fact, since therein the process noise $\{\mathbf{w}_k\}$ is in general not absent, this approach is only applicable to first-order Markov (or first-order AR) colored noises; while in this paper, assuming that the process noise is absent, we may generalize the approach to higher-order ARMA colored noises.

Proposition 1: Denote

$$\hat{\mathbf{y}}_k = -\sum_{j=1}^q g_j \hat{\mathbf{y}}_{k-j} + \mathbf{y}_k - \sum_{i=1}^p f_i \mathbf{y}_{k-i}. \quad (14)$$

As such, the system to be estimated is equivalent to

$$\begin{cases} \mathbf{x}_{k+1} = a\mathbf{x}_k, \\ \hat{\mathbf{y}}_k = \hat{c}\mathbf{x}_k + \hat{\mathbf{v}}_k, \end{cases} \quad (15)$$

where

$$\hat{c} = c \left(1 - \sum_{i=1}^p f_i a^{-i}\right) \left(1 + \sum_{j=1}^q g_j a^{-j}\right)^{-1}. \quad (16)$$

Proof: Note first that

$$\begin{aligned} \hat{\mathbf{y}}_k &= -\sum_{j=1}^q g_j \hat{\mathbf{y}}_{k-j} + \mathbf{y}_k - \sum_{i=1}^p f_i \mathbf{y}_{k-i} = \mathbf{y}_k - \sum_{i=1}^{\infty} h_i \mathbf{y}_{k-i} \\ &= \mathbf{y}_k - \sum_{i=1}^{\infty} h_i (c\mathbf{x}_{k-i} + \mathbf{v}_{k-i}) \\ &= c\mathbf{x}_k - \sum_{i=1}^{\infty} h_i c\mathbf{x}_{k-i} + \mathbf{v}_k - \sum_{i=1}^{\infty} h_i \mathbf{v}_{k-i} \\ &= c\mathbf{x}_k - \sum_{i=1}^{\infty} h_i c\mathbf{x}_{k-i} + \hat{\mathbf{v}}_k. \end{aligned}$$

On the other hand, it holds that $\mathbf{x}_{k-i} = a^{-i}\mathbf{x}_k$ since $|a| > 1$. Hence,

$$\begin{aligned}\hat{\mathbf{y}}_k &= c\mathbf{x}_k - \sum_{i=1}^{\infty} h_i c\mathbf{x}_{k-i} + \hat{\mathbf{v}}_k \\ &= c \left(1 - \sum_{i=1}^{\infty} h_i a^{-i} \right) \mathbf{x}_k + \hat{\mathbf{v}}_k.\end{aligned}$$

Furthermore, we have to ensure that $1 - \sum_{i=1}^{\infty} h_i a^{-i}$ converges. To see this, note that

$$1 - \sum_{i=1}^{\infty} h_i z^{-i} = \left(1 - \sum_{i=1}^p f_i z^{-i} \right) \left(1 + \sum_{j=1}^q g_j z^{-j} \right)^{-1}$$

(i.e., $1 - \sum_{i=1}^{\infty} h_i z^{-i}$ converges) for $|z| \geq 1$, since $1 + \sum_{j=1}^q g_j z^{-j}$ is minimum-phase while $1 - \sum_{i=1}^p f_i z^{-i}$ is stable and hence

$$\left(1 - \sum_{i=1}^p f_i z^{-i} \right) \left(1 + \sum_{j=1}^q g_j z^{-j} \right)^{-1} \neq 0, \forall |z| \geq 1.$$

Stated alternatively, the region of convergence must include, though not necessarily restricted to, $|z| \geq 1$ (extending outward from the outermost zero of $1 + \sum_{j=1}^q g_j z^{-j}$). Therefore, since $|a| > 1$, we have

$$1 - \sum_{i=1}^{\infty} h_i a^{-i} = \left(1 - \sum_{i=1}^p f_i a^{-i} \right) \left(1 + \sum_{j=1}^q g_j a^{-j} \right)^{-1},$$

which completes the proof. \blacksquare

The system given in (15) is observable (and thus detectable).

Proposition 2: The pair (a, \hat{c}) , in which \hat{c} is given by (16), is observable.

Proof: Since $|a| > 1$ and $c \neq 0$, we only need to prove that

$$\left(1 - \sum_{i=1}^p f_i a^{-i} \right) \left(1 + \sum_{j=1}^q g_j a^{-j} \right)^{-1} \neq 0.$$

To see this, suppose that

$$\left(1 - \sum_{i=1}^p f_i a^{-i} \right) \left(1 + \sum_{j=1}^q g_j a^{-j} \right)^{-1} = 0.$$

This means that a , $|a| > 1$ is a zero of $1 - \sum_{i=1}^p f_i z^{-i}$ or a pole of $1 + \sum_{j=1}^q g_j z^{-j}$. In either case this will lead to a contradiction since $1 - \sum_{i=1}^p f_i z^{-i}$ is minimum-phase while the poles of $1 + \sum_{j=1}^q g_j z^{-j}$ are $z_j = 0, j = 1, \dots, q$. \blacksquare

As such, the Kalman filter for (15) is given by

$$\begin{cases} \bar{\mathbf{x}}_{k+1} &= a\bar{\mathbf{x}}_k + \mathbf{u}_k, \\ \bar{\mathbf{y}}_k &= \hat{c}\bar{\mathbf{x}}_k, \\ \mathbf{e}_k &= \hat{\mathbf{y}}_k - \bar{\mathbf{y}}_k, \\ \mathbf{u}_k &= \hat{K}\mathbf{e}_k, \end{cases} \quad (17)$$

where $\bar{\mathbf{x}}_k \in \mathbb{R}$, $\bar{\mathbf{y}}_k \in \mathbb{R}$, $\mathbf{e}_k \in \mathbb{R}$, and $\mathbf{u}_k \in \mathbb{R}$.

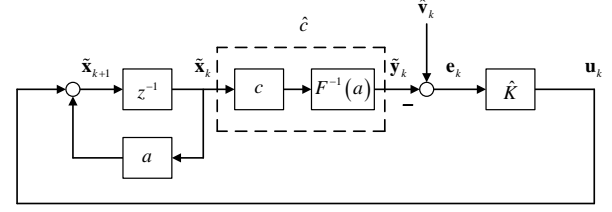

Fig. 3. The steady-state integrated Kalman filter for colored noises.

Since (a, \hat{c}) is detectable, the Kalman filtering system converges, i.e., the state estimation error $\{\mathbf{x}_k - \bar{\mathbf{x}}_k\}$ and the “innovation” $\{\mathbf{e}_k\}$ are asymptotically stationary. Moreover, in steady state, the optimal state estimation error variance $P = \lim_{k \rightarrow \infty} E[(\mathbf{x}_k - \bar{\mathbf{x}}_k)^2]$ attained by the Kalman filter is given by the non-zero root of the algebraic Riccati equation

$$P = a^2 P - \frac{a^2 \hat{c}^2 P^2}{\hat{c}^2 P + \sigma_{\hat{\mathbf{v}}}^2}, \quad (18)$$

whereas the steady-state Kalman gain is given by

$$\hat{K} = \frac{a\hat{c}P}{\hat{c}^2 P + \sigma_{\hat{\mathbf{v}}}^2}. \quad (19)$$

In addition, the optimal steady-state innovation variance is

$$\sigma_{\mathbf{e}}^2 = \lim_{k \rightarrow \infty} E[\mathbf{e}_k \mathbf{e}_k^T] = \lim_{k \rightarrow \infty} E[(\hat{\mathbf{y}}_k - \bar{\mathbf{y}}_k)^2] = \hat{c}^2 P + \sigma_{\hat{\mathbf{v}}}^2. \quad (20)$$

It then follows from (18) that

$$\sigma_{\mathbf{e}}^2 = \hat{c}^2 P + \sigma_{\hat{\mathbf{v}}}^2 = a^2 \sigma_{\hat{\mathbf{v}}}^2, \quad (21)$$

and thus

$$P = \frac{a^2 - 1}{\hat{c}^2} \sigma_{\hat{\mathbf{v}}}^2, \quad (22)$$

which may then be rewritten as

$$\frac{c^2 P}{\sigma_{\hat{\mathbf{v}}}^2} \left(1 - \sum_{i=1}^p f_i a^{-i} \right)^2 = (a^2 - 1) \left(1 + \sum_{j=1}^q g_j a^{-j} \right)^2. \quad (23)$$

On the other hand, (19) may be simplified as

$$\begin{aligned}\hat{K} &= \frac{a^2 - 1}{a\hat{c}} \\ &= \frac{a^2 - 1}{a} \left(1 - \sum_{i=1}^p f_i a^{-i} \right)^{-1} \left(1 + \sum_{j=1}^q g_j a^{-j} \right). \end{aligned} \quad (24)$$

Again, by letting $\tilde{\mathbf{x}}_k = \bar{\mathbf{x}}_k - \mathbf{x}_k$ and $\tilde{\mathbf{y}}_k = \bar{\mathbf{y}}_k - \hat{\mathbf{z}}_k = \bar{\mathbf{y}}_k - \hat{c}\mathbf{x}_k$, we may integrate the systems of (15) and (17) in steady state into

$$\begin{cases} \tilde{\mathbf{x}}_{k+1} &= a\tilde{\mathbf{x}}_k + \mathbf{u}_k, \\ \tilde{\mathbf{y}}_k &= \hat{c}\tilde{\mathbf{x}}_k, \\ \mathbf{e}_k &= -\tilde{\mathbf{y}}_k + \hat{\mathbf{v}}_k, \\ \mathbf{u}_k &= \hat{K}\mathbf{e}_k, \end{cases} \quad (25)$$

as depicted in Fig. 3. It may be verified that the closed-loop system given in (25) and Fig. 3 is stable [19], [24].

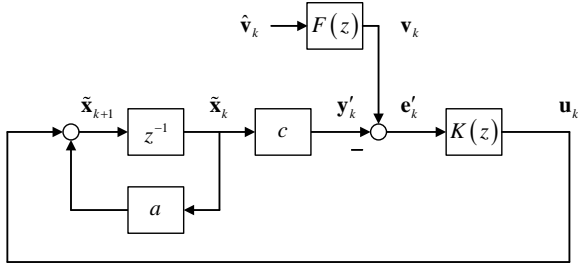

Fig. 4. The steady-state integrated Kalman filter for colored noises: Equivalent form.

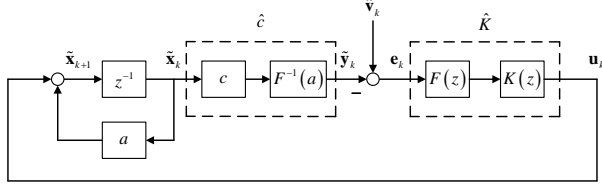

Fig. 5. The steady-state integrated Kalman filter for colored noises: Equivalent form 2.

B. Lower Bounds on Feedback Capacity

We may now obtain an equivalent form of the system in Fig. 3 as given by (25), where we denote

$$F^{-1}(a) = \left(1 - \sum_{i=1}^p f_i a^{-i}\right) \left(1 + \sum_{j=1}^q g_j a^{-j}\right)^{-1}. \quad (26)$$

Theorem 1: The system in Fig. 3 is equivalent to that in Fig. 4, where $K(z)$ is dynamic and is given by

$$\begin{aligned} K(z) &= F^{-1}(z) \hat{K} \\ &= \left(1 - \sum_{i=1}^p f_i z^{-i}\right) \left(1 + \sum_{j=1}^q g_j z^{-j}\right)^{-1} \hat{K}. \end{aligned} \quad (27)$$

Herein, \hat{K} is given by (24). In particular, the system in Fig. 4 is given by

$$\begin{cases} \tilde{\mathbf{x}}_{k+1} &= a\tilde{\mathbf{x}}_k + \mathbf{u}_k, \\ \mathbf{y}'_k &= c\tilde{\mathbf{x}}_k, \\ \mathbf{e}'_k &= -\mathbf{y}'_k + \mathbf{v}_k, \\ \mathbf{u}_k &= \hat{K} \left(\mathbf{e}'_k - \sum_{i=1}^p f_i \mathbf{e}'_{k-i} \right) - \sum_{j=1}^q g_j \mathbf{u}_{k-j}. \end{cases} \quad (28)$$

In addition, the closed-loop system given in (28) and Fig. 4 is stable.

Proof: To see this, note first that the system in Fig. 3 is equivalent to the one in Fig. 5 since $\hat{K} = F(z) K(z)$. Then, since

$$\tilde{\mathbf{x}}_k = \bar{\mathbf{x}}_k - \mathbf{x}_k = a(\bar{\mathbf{x}}_{k-1} - \mathbf{x}_{k-1}) = a\tilde{\mathbf{x}}_{k-1},$$

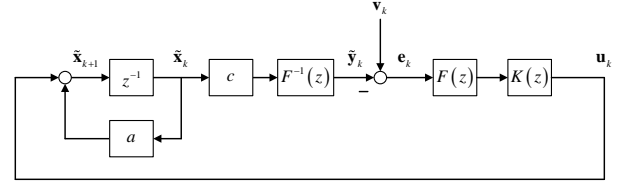

Fig. 6. The steady-state integrated Kalman filter for colored noises: Equivalent form 3.

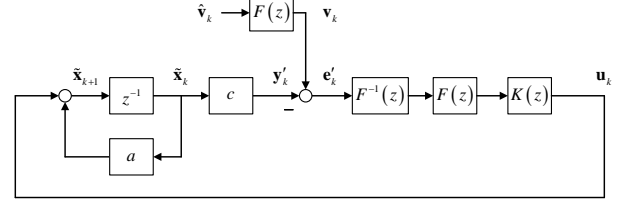

Fig. 7. The steady-state integrated Kalman filter for colored noises: Equivalent form 4.

we have

$$\begin{aligned} \tilde{\mathbf{y}}_k &= F^{-1}(a) \tilde{\mathbf{x}}_k \\ &= \left(1 - \sum_{i=1}^p f_i a^{-i}\right) \left(1 + \sum_{j=1}^q g_j a^{-j}\right)^{-1} \tilde{\mathbf{x}}_k \\ &= \left(1 - \sum_{i=1}^{\infty} h_i a^{-i}\right) \tilde{\mathbf{x}}_k = \left(1 - \sum_{i=1}^{\infty} h_i z^{-i}\right) \tilde{\mathbf{x}}_k \\ &= \left(1 - \sum_{i=1}^p f_i z^{-i}\right) \left(1 + \sum_{j=1}^q g_j z^{-j}\right)^{-1} \tilde{\mathbf{x}}_k \\ &= F^{-1}(z) \tilde{\mathbf{x}}_k. \end{aligned}$$

(Note that this “static-dynamic equivalence” transformation is a critical step.) As a result, the system in Fig. 5 is equivalent to that in Fig. 6. In addition, since all the sub-systems are linear, the system in Fig. 6 is equivalent to that in Fig. 7, which in turn equals to the one in Fig. 4 noting that $F(z)$ is stable as well as minimum-phase, and hence there will not be any issues caused by cancellations of unstable poles and nonminimum-phase zeros. In addition, the closed-loop stability of the system given in (28) and Fig. 4 is the same as that of (25) and Fig. 3, since they are essentially the same feedback system. ■

We next provide a key observation that enables relating the Kalman filtering system to the feedback capacity.

Observation 1: In the system of Fig. 4, or equivalently, in the system of Fig. 8, we may in fact view

$$\mathbf{e}'_k = -\mathbf{y}'_k + \mathbf{v}_k \quad (29)$$

as a feedback channel [2], [5] with additive colored Gaussian noise $\{\mathbf{v}_k\}$, whereas $\{-\mathbf{y}'_k\}$ is the channel input while $\{\mathbf{e}'_k\}$ is the channel output; cf. [5] with

$$L(z) = c(z - a)^{-1} K(z), \quad (30)$$

assuming that both $1 - f_1 z^{-1}$ and $1 + g_1 z^{-1}$ are minimum-phase, is given by

$$C_f = \log |\bar{a}|, \quad (38)$$

where \bar{a} denotes the root of

$$\frac{\bar{P}}{\sigma_v^2} (1 - f_1 a^{-1})^2 = (a^2 - 1) (1 + g_1 a^{-1})^2 \quad (39)$$

that is real and with the largest magnitude. Moreover, the lower bound may be rewritten as

$$C_f = \log \bar{a}, \quad (40)$$

where \bar{a} denotes the largest positive real root to be chosen among the roots of

$$\frac{\bar{P}}{\sigma_v^2} (1 - f_1 a^{-1})^2 = (a^2 - 1) (1 + g_1 a^{-1})^2 \quad (41)$$

as well as

$$\frac{\bar{P}}{\sigma_v^2} (1 + f_1 a^{-1})^2 = (a^2 - 1) (1 - g_1 a^{-1})^2. \quad (42)$$

Example 1 is consistent with the feedback capacity of such channels derived in [2]. (It is also worth mentioning that before [2], lower bounds on feedback capacity for first-order AR colored noises and first-order ARMA colored noises have been respectively obtained in [20], [27] and [16]. Meanwhile, see [3], [14] for further discussions on the feedback capacity for first-order moving average colored noises.) In fact, it has been shown in [2] that the feedback capacity (rather than a lower bound of it) is given by the unique (therefore, the largest) positive real root of

$$\frac{\bar{P}}{\sigma_v^2} (1 - f_1 a^{-1})^2 = (a^2 - 1) (1 + g_1 a^{-1})^2 \quad (43)$$

when $f_1 + g_1 \leq 0$, while when $f_1 + g_1 > 0$, the feedback capacity is given by the only positive real root of

$$\frac{\bar{P}}{\sigma_v^2} (1 + f_1 a^{-1})^2 = (a^2 - 1) (1 - g_1 a^{-1})^2. \quad (44)$$

Note that it may be verified that when $f_1 + g_1 \leq 0$, the positive real root of (43) is larger than or equal to that of (44), and vice versa. That is to say, the lower bound in Example 1 is indeed tight. Accordingly, the recursive coding scheme/algorithm is given by (cf. (28))

$$\begin{cases} \tilde{\mathbf{x}}_{k+1} = a\tilde{\mathbf{x}}_k + \mathbf{u}_k, \\ \mathbf{y}'_k = c\tilde{\mathbf{x}}_k, \\ \mathbf{e}'_k = -\mathbf{y}'_k + \mathbf{v}_k, \\ \mathbf{u}_k = \hat{K} (\mathbf{e}'_k - f_1 \mathbf{e}'_{k-1}) - g_1 \mathbf{u}_{k-1}, \end{cases} \quad (45)$$

which corresponds to (see Fig. 8)

$$L(z) = c(z - a)^{-1} (1 - f_1 z^{-1}) (1 + g_1 z^{-1})^{-1} \hat{K}, \quad (46)$$

while

$$\hat{K} = \frac{a^2 - 1}{a} (1 - f_1 a^{-1})^{-1} (1 + g_1 a^{-1}). \quad (47)$$

Furthermore, one might also compare (45) and (46) respectively with the coding scheme and $B(z)$ for the first-order ARMA colored noises as presented in [2] by noting that

$$B(z) = -L(z) [1 + L(z)]^{-1}. \quad (48)$$

On the other hand, we are aware of the fact that the lower bounds presented in this paper are in general not tight; cf. discussions in [3]. Meanwhile, there are still additional “degrees of freedom” that we may potentially exploit and make use of in the current framework. For instance, we may consider time-varying a_k and/or c_k with the same magnitudes but with alternating signs over time. For another example, we may also consider matrices $A \in \mathbb{R}^{n \times n}$ and $C \in \mathbb{R}^{1 \times n}$, and this might be related to our previous works in [18], [28], [29]; in fact, some preliminary derivations in this direction may already show that a potentially tighter lower bound of the feedback capacity with ARMA colored noise (9) and power constraint \bar{P} is given by

$$C_f = \bar{n} \log |\bar{a}|, \quad (49)$$

where \bar{a} denotes the root of

$$\frac{\bar{P}}{\sigma_v^2} \left(1 - \sum_{i=1}^p f_i a^{-i} \right)^2 = (a^{2n} - 1) \left(1 + \sum_{j=1}^q g_j a^{-j} \right)^2 \quad (50)$$

that is real and with the largest $|a|^n$ among all $n = 1, 2, \dots$, while \bar{n} denotes the corresponding n . Due to lack of space, we will leave detailed discussions on such topics to future research.

IV. CONCLUSION

In this paper, we have established a connection between the feedback capacity of additive ARMA colored Gaussian noise channels and the Kalman filters with additive ARMA colored Gaussian noises. By doing so, we have been able to derive lower bounds on feedback capacity of such channels, and the bounds are seen to be consistent with various existing results in the literature. On the other hand, the Kalman filtering systems, after certain equivalence transformations, can be employed as recursive coding schemes/algorithms to achieve the lower bounds. The preliminary results presented in this paper feature the first-step explorations under the current framework. Future research directions include the analysis of Kalman filtering systems with more complicated system and output matrices, which may potentially lead to tighter bounds as well as additional insights into the feedback capacity problem.

REFERENCES

- [1] T. M. Cover and S. Pombra, “Gaussian feedback capacity,” *IEEE Transactions on Information Theory*, vol. 35, no. 1, pp. 37–43, 1989.
- [2] Y.-H. Kim, “Feedback capacity of stationary Gaussian channels,” *IEEE Transactions on Information Theory*, vol. 56, no. 1, pp. 57–85, 2010.
- [3] —, “Feedback capacity of the first-order moving average Gaussian channel,” *IEEE Transactions on Information Theory*, vol. 52, no. 7, pp. 3063–3079, 2006.
- [4] —, “Gaussian feedback capacity,” Ph.D. dissertation, Stanford University, 2006.

- [5] E. Ardestanizadeh and M. Franceschetti, "Control-theoretic approach to communication with feedback," *IEEE Transactions on Automatic Control*, vol. 57, no. 10, pp. 2576–2587, 2012.
- [6] J. Liu and N. Elia, "Convergence of fundamental limitations in feedback communication, estimation, and feedback control over Gaussian channels," *Communications in Information and Systems*, vol. 14, no. 3, pp. 161–211, 2014.
- [7] J. Liu, N. Elia, and S. Tatikonda, "Capacity-achieving feedback schemes for Gaussian finite-state Markov channels with channel state information," *IEEE Transactions on Information Theory*, vol. 61, no. 7, pp. 3632–3650, 2015.
- [8] P. A. Stavrou, C. D. Charalambous, and C. K. Kourtellaris, "Sequential necessary and sufficient conditions for capacity achieving distributions of channels with memory and feedback," *IEEE Transactions on Information Theory*, vol. 63, no. 11, pp. 7095–7115, 2017.
- [9] C. K. Kourtellaris and C. D. Charalambous, "Information structures of capacity achieving distributions for feedback channels with memory and transmission cost: Stochastic optimal control & variational equalities," *IEEE Transactions on Information Theory*, vol. 64, no. 7, pp. 4962–4992, 2018.
- [10] A. R. Pedram and T. Tanaka, "Some results on the computation of feedback capacity of Gaussian channels with memory," in *Proceedings of the Annual Allerton Conference on Communication, Control, and Computing (Allerton)*, 2018, pp. 919–926.
- [11] A. Gattami, "Feedback capacity of Gaussian channels revisited," *IEEE Transactions on Information Theory*, vol. 65, no. 3, pp. 1948–1960, 2018.
- [12] T. Liu and G. Han, "Feedback capacity of stationary Gaussian channels further examined," *IEEE Transactions on Information Theory*, vol. 65, no. 4, pp. 2492–2506, 2018.
- [13] C. Li and N. Elia, "Youla coding and computation of Gaussian feedback capacity," *IEEE Transactions on Information Theory*, vol. 64, no. 4, pp. 3197–3215, 2018.
- [14] S. Ihara, "On the feedback capacity of the first-order moving average Gaussian channel," *Japanese Journal of Statistics and Data Science*, pp. 1–16, 2019.
- [15] N. Elia, "When Bode meets Shannon: Control-oriented feedback communication schemes," *IEEE Transactions on Automatic Control*, vol. 49, no. 9, pp. 1477–1488, 2004.
- [16] S. Yang, A. Kavcic, and S. Tatikonda, "On the feedback capacity of power-constrained Gaussian noise channels with memory," *IEEE Transactions on Information Theory*, vol. 53, no. 3, pp. 929–954, 2007.
- [17] S. Tatikonda and S. Mitter, "The capacity of channels with feedback," *IEEE Transactions on Information Theory*, vol. 55, no. 1, pp. 323–349, 2009.
- [18] S. Fang, J. Chen, and H. Ishii, *Towards Integrating Control and Information Theories: From Information-Theoretic Measures to Control Performance Limitations*. Springer, 2017.
- [19] B. D. O. Anderson and J. B. Moore, *Optimal Filtering*. Prentice-Hall, 1979.
- [20] S. Butman, "Linear feedback rate bounds for regressive channels," *IEEE Transactions on Information Theory*, vol. 22, no. 3, pp. 363–366, 1976.
- [21] A. Papoulis and S. U. Pillai, *Probability, Random Variables and Stochastic Processes*. New York: McGraw-Hill, 2002.
- [22] T. M. Cover and J. A. Thomas, *Elements of Information Theory*. John Wiley & Sons, 2006.
- [23] T. Kailath, A. H. Sayed, and B. Hassibi, *Linear Estimation*. Prentice Hall, 2000.
- [24] K. J. Åström and R. M. Murray, *Feedback Systems: An Introduction for Scientists and Engineers*. Princeton University Press, 2010.
- [25] P. P. Vaidyanathan, *The Theory of Linear Prediction*. Morgan & Claypool Publishers, 2007.
- [26] M. M. Seron, J. H. Braslavsky, and G. C. Goodwin, *Fundamental Limitations in Filtering and Control*. Springer, 1997.
- [27] S. Butman, "A general formulation of linear feedback communication systems with solutions," *IEEE Transactions on Information Theory*, vol. 15, no. 3, pp. 392–400, 1969.
- [28] S. Fang, H. Ishii, and J. Chen, "An integral characterization of optimal error covariance by Kalman filtering," in *Proceedings of the American Control Conference*, 2018, pp. 5031–5036.
- [29] S. Fang, M. Skoglund, K. H. Johansson, H. Ishii, and Q. Zhu, "Generic variance bounds on estimation and prediction errors in time series analysis: An entropy perspective," in *Proceedings of the IEEE Information Theory Workshop (ITW)*, 2019.