

The Assurance Monitor Pattern

ADAM DURACZ, Rice University

K. MANI CHANDY, Caltech

MOHAMED ABDELRAHMAN, Rice University

JUAN JOSE GONZALEZ ESPAÑA, Rice University

RYUICHI SAI, Rice University

YAO-HSIANG YANG, Rice University

ROBERT CARTWRIGHT, Rice University

KRISHNA V. PALEM, Rice University

Some applications require an assurance that certain criteria are violated with only low probability. An alert is generated when the current course of action is likely to violate assurance criteria and the alert results in corrective action. Assurance monitors fuse information from multiple data streams generated by sensors and other sources to estimate the probability distribution of system trajectories. This distribution is used to determine whether an assurance constraint is likely to be violated. The acquisition of data requires resources such as energy, computational power and communication bandwidth which are scarce in many applications. At each point in time the system must decide whether to expend these resources to get more data to improve the confidence in the probability distribution of trajectories. This paper presents a software-design pattern for assurance monitoring and gives examples of its uses, including an application of the pattern to the problem of autonomous navigation of a drone which is required to avoid no-fly zones while using limited resources.

Additional Key Words and Phrases: Software design patterns, Assurance, Monitoring, Prediction

INTRODUCTION

Software design patterns entered the vocabulary of the broad software engineering community with the publication of the classic book by Gamma, Vlissides, Johnson, and Helm [10]. The concept provided systems designers with a convenient way of describing solutions to common problems, along with an analysis of the consequences of adopting the prescribed solutions. More than two decades after its publication, the concept remains influential to the way software engineers think about problem solving. Today, design patterns have been adopted across a variety of domains beyond object-oriented design including security [9], generic programming [16], graphics [13] and distributed data processing [15], demonstrating the general appeal of the concept.

Though the term was originally borrowed from architecture [1], designing systems by composing well-understood elements is inherent to the practice of engineering. For example, control systems that use feedback can robustly maintain their behaviour under state changes, and controller patterns such as proportional-integral-derivative (PID) are used to construct systems with well-understood behavior.

Patterns play a particularly important role in distributed systems, whose design may be hard to change after they are deployed. Patterns such as communication over queues, message brokering [14], and publish/subscribe [4] provide systems with desirable qualities such as fault tolerance, scalability, loose coupling and guaranteed-once delivery [7]. Enterprise integration has long benefited from the availability of software platforms that support such patterns. Novel patterns are being discovered in several emerging domains that involve event-based systems. In cloud computing, immutable data storage [2] addresses the combined challenge of scale and latency. In IoT, shadowing and triggering [24] address intermittent availability of networked, energy-constrained

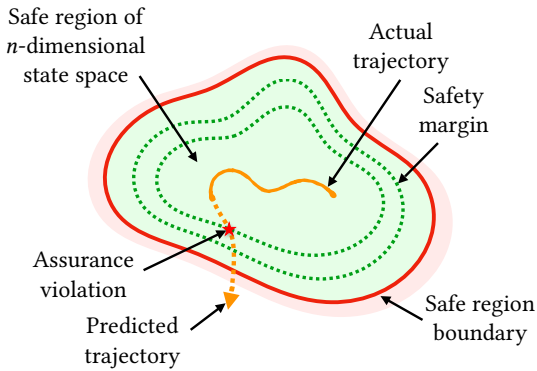

Fig. 1. Assurance Monitoring of a State Trajectory

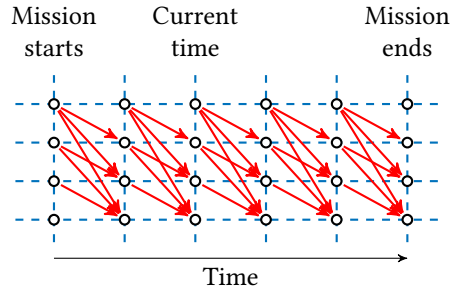

Fig. 2. Continuous prediction of probability of assurance violation. Red arrows represent possible transitions between states.

devices, and metering [23] enables associated business models. In cyber-physical systems, the way in which these systems are deployed and interact with one another gives rise to patterns to deal with time and synchronization [12] and the need to adapt to changes in resources and the operating environment [21].

Patterns can help to get more widespread adoption of event-based systems (EBS) ideas and software. A person developing an EBS application may not be able to use a program written by someone else exactly as the program is written. This could be because the programming language in the earlier application is different from the new one, or the libraries that the earlier application used may be different from those that the developer wants to use (e.g. MATLAB versus Python SciPy Toolkits). Nevertheless, many EBS applications have similar constructs, and often these constructs can be represented as reusable patterns. This paper proposes a pattern for applications that monitor and, if necessary, take steps to correct, the behavior of systems.

The structure of the pattern can be represented by a graph in which the vertices are agents and the edges represent information flow. The behavior of an agent is that it is asleep and not carrying out any computation until it is woken up by a clock or by the arrival of information from another agent. The agent can “pull” information; for example it can call a GPS sensor when it wants a GPS reading. Also, information can be “pushed” to agents; for example, an agent may receive a stream of accelerations. This structure has been described since the inception of EBS, and books on EBS [5, 8, 18] describe this pattern in one form or another.

The contribution of this paper is to use this structure to form a pattern that is used in a particular kind of EBS application: assurance monitoring. The pattern uses agents for Bayesian fusion of information from multiple sources, predicting future system behavior, and checking whether future behavior is likely to violate constraints. The way in which agents are connected can vary from application to application though all assurance monitors have the same essential structure to deal with the question: Is future behavior safe? The pattern is used for a specific application of drone navigation, which is discussed in detail; then the use of the same pattern in other applications is described briefly. An implementation of the pattern, in Python, is freely available [3].

The assurance monitor pattern arises often in event-based systems and, in particular, addresses the need to predict undesirable behavior in autonomous systems, whose behavior is difficult to analyze. Such systems are currently being introduced across all of the aforementioned domains, spurred by recent advances in machine learning. The rest of this paper describes the assurance monitor pattern (Section 2), describes an instance of the pattern implemented in Python (Section 3),

discusses experimental results based on this implementation (Section 4), and concludes with a discussion of its use in a second application (Section 5).

1 ASSURANCE MONITORING

Figure 1 illustrates the general problem solved by an assurance monitor, in terms of a system state space that consists of a safe region, where the system is intended to operate, and an unsafe region, where there is some risk of harm. The assurance monitor predicts the future trajectory of the system, and estimates when the probability of entering the unsafe region exceeds a threshold, which corresponds to a safety margin around the unsafe region. Assurance monitors can observe multiple thresholds, which may correspond to different behavior such as a warning, a request for more information, or a corrective action.

The state space of a system can include both discrete and continuous dimensions. Discrete states arise from computational aspects of the system's behavior, and include the number/type of processor cores or amount of memory available to distribute the system's computations over, and the maximal clock rate that can be utilized without overheating the system. Continuous dimensions arise from the physical aspects of the system, and include space, time, temperature, voltage and current.

Generally, to make computational analysis of such hybrid (discrete/continuous) systems tractable, continuous dimensions are discretized by dividing the space into a finite number of regions. One thus obtains a discrete representation of the system that can be reasoned about using traditional techniques. For example, by assuming that each state is a time-dependent random variable we obtain Markov model that, given a probability distribution over the system states at the current time, and probabilities for transitioning between each of the discrete states, can be used to predict future system state probability distributions. This process is illustrated in Figure 2, where each time instant is represented by a column of discrete states, with possible transitions from states at the current time contributing to the probability of states at the next time.

The problem of assurance monitoring of autonomous systems can be complex. Here we point out a few of the factors that make the problem difficult in the context of autonomous drone navigation. The no-fly zone can be a complex structure; if no-fly zones consist of densely populated areas in an urban region then the zones can form complex geometrical shapes. The optimal use of scarce resources is difficult in these situations because resources when flying over simpler shapes may have to be saved for later use, when flying over complex structures. One approach is to use a finite-horizon dynamic program and particle filters. This paper only considers simple no-fly geometries, does not use dynamic programs, and limits decision-making algorithms to simple heuristics.

A problem with visual navigation (using photographs) is that the drone may be estimated, with high probability, to be in multiple locations that are far apart. Consider the case of a drone flying east which is estimated, with high probability, to be in location A and with equal probability to be in a distant location B . If a no-fly zone abuts A to the north and a no-fly zone abuts B to the south, then optimal control can be complex. In this paper, we assume that the drone is in the (single) location with the maximum likelihood probability.

Much more work needs to be done on the code developed so far for use in visual autonomous navigation. We believe, however, that our continued development of the application will continue to use assurance monitoring patterns. Moreover, the pattern can be used with very different applications. As earlier papers and books on event processing have suggested implicitly, the use of EBS patterns can help the wider community develop event-processing applications.

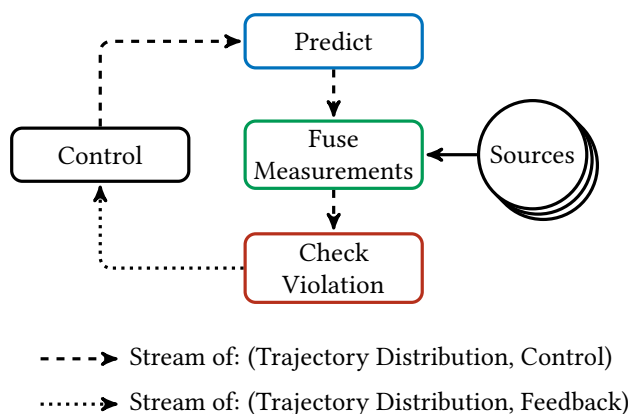

Fig. 3. Assurance Monitor Agent Network With One Fusion Agent

2 AN ASSURANCE MONITOR PATTERN

Some event-based applications require an assurance that certain criteria are satisfied at all times or are violated with only low probability. An alert is generated when the current course of action is likely to violate assurance criteria. The alert results in corrective action. This pattern concerns the detection of events that signal the probable violation of assurance criteria. The pattern can be summarized as follows:

Given limited knowledge about the behavior of an event-based application, avoid violating an assurance criterion by predicting future events, using data from multiple sources to improve the accuracy of the prediction.

2.1 Intent and Motivation

Assurance monitors fuse information from multiple data streams generated by sensors and other sources to estimate the probability distribution of system trajectories. This distribution is used to determine whether an assurance constraint is likely to be violated. The acquisition of data may require resources such as energy, computational power or communication bandwidth which are scarce in many applications, or incur charges which should be kept to a minimum. At each point in time the system must decide whether to expend these resources to get more data to improve the confidence in the probability distribution of trajectories.

Informally speaking, the system should not expend its resource budget to get more data when it is confident that the current trajectory will not violate assurance criteria for a specified time horizon. If, however, the system is not confident that the assurance criteria can be maintained, then if adequate resources are available the system should spend part of its resource budget to get additional data to get a better estimate of the state probability distribution. If the system is not confident that the assurance criteria can be maintained and its resources are depleted then it should generate an alert signaling the need for a course correction. The assurance monitor balances the need for ensuring that constraints are not violated while ensuring that resources are not depleted.

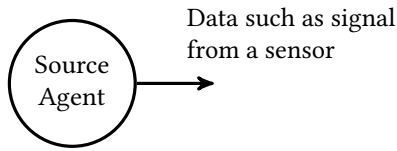

(a) Agent that Acquires Data

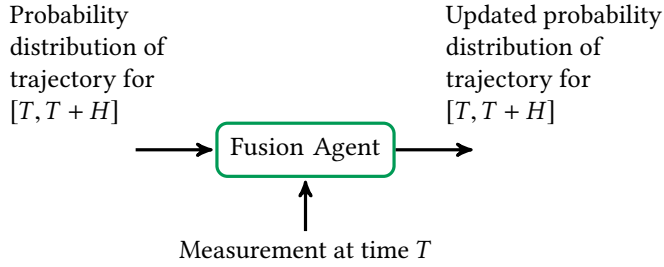

(b) Agent that Fuses Measurements

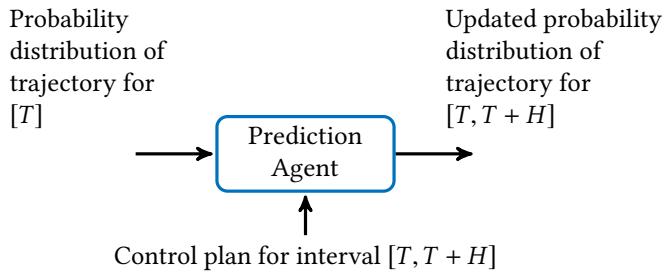

(c) Agent that Fuses Control Signals

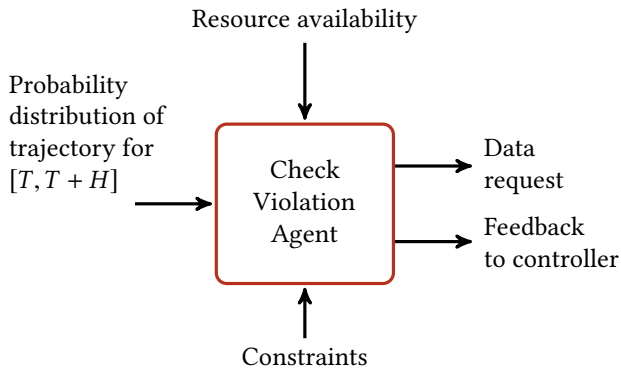

(d) Agent that Predicts Assurance Violations

Fig. 4. Assurance Monitor Agent Types

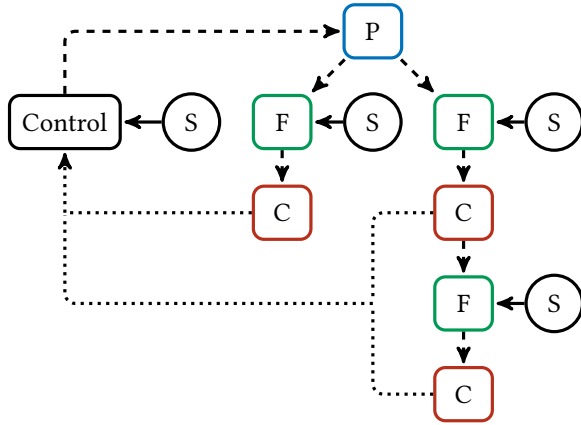

Fig. 5. Assurance Monitor Agent Network With Agents Composed Both Sequentially and in Parallel

2.2 Structure

An assurance monitor pattern is a network of different types of agents (Figure 3). Each agent is a smaller pattern in itself. A *data source* agent (Figure 4a) acquires data, for example from a sensor; this data is acquired when the agent is requested to do so by a decision maker agent or by a system clock. A *data fusion* agent (Figure 4b) reads an estimate of the probability distribution over system states and data from a set of sources and outputs a new estimate of the distribution. A *prediction* agent (Figure 4c) reads an estimate of the probability distribution over system states and a control signal and outputs a new estimate of the distribution. A *check violation* agent (Figure 4d) computes the probability of an assurance violation event. The input to a check-violation agent is a probability distribution on the trajectory; it outputs either:

- (1) an alert signaling the need for a course correction, or
- (2) a request to get additional data from a set of data sources, or
- (3) a continue message indicating that the current plan is safe.

Computation agents look up data repositories or carry out computations to add value to the data. For example, a computation agent may integrate stored historical data with raw sensor data.

The agent network in Figure 3 contains a single fusion agent. More complex networks can be constructed, where the signals of source agents are composed sequentially (as we will see in Section 3) or in parallel, where agents execute concurrently. The network in Figure 5 shows a network where agents are composed in both ways.

2.3 Consequences

Autonomous systems, particularly those whose behavior relies on components with partially unknown behavior such as those based on learned models, can incorporate an assurance monitor to retain some of the operational safety of manually controlled or manually programmed systems. The assurance monitor can aid in conserving scarce resources, by only activating system functions that consume these resources when necessary. The composition of fusion agents that propagate a stream of successive state estimates can increase the accuracy of the overall system beyond the accuracy of any individual agent, and compensate for several kinds of inaccuracies, including drift, noise and approximation.

These benefits come at the cost of runtime overhead of the computations that are required for assurance monitoring, which may be considerable. As with most predictive systems, the detection of future assurance violation events can yield false positives. Under unfavorable conditions, or if the violation criteria are too conservative, the resulting actions may cause unnecessary remedial actions or instability in a system that would otherwise remain both safe and stable.

Next, we describe applications constructed by networks of these agents.

3 EXAMPLE APPLICATION: RESOURCE-CONSTRAINED AUTONOMOUS DRONE NAVIGATION

To help understand what instances of the pattern can look like, we begin by reviewing an example that exhibits several characteristics that make the pattern useful. The application is a drone, that is required to travel over a region while staying away from no-fly zones. The drone operates autonomously using an on-board control system. Some recently proposed control systems for autonomous drones are entirely data-driven, meaning that the behavior of the drone is learned from a training set of sensor inputs [26], which may even be captured on a different system [17]. The potential for autonomy in this approach is promising, but the learned behavior is generally not combined with manual specifications, such as safety properties, meaning that the overall system may be unsafe if exposed to conditions not covered by the training set. An assurance monitor can serve as a bridge between these two worlds, yielding a system that is both autonomous and avoids assurance violations, for example by switching to a safe controller when the learned controller is predicted to take the system out of safety.

In our example, the drone has accelerometers and gyroscopes that enable it to estimate its 3-D acceleration. It takes photographs of the terrain periodically, and the drone may take additional photographs to improve location estimation. The drone may also activate other mechanisms, such as GPS, to improve its estimate. The use of these mechanisms consumes power and other resources, and so they must be used judiciously.

The state of the drone is given by its (3-D) acceleration, velocity and location. A network of agents computes a probability distribution of the drone's current state at a point in time. The distribution at time $t = 0$ is given. The drone's trajectory over a time interval is its state at each point in the interval. The agents compute the distribution of trajectories to detect events that trigger actions such as "get more data" or "change course."

Figure 6 shows the network of agents that make up the drone navigation assurance monitor. Next, we describe the behavior of its key agents.

3.1 Source Agents

The drone's inertial measurement unit (IMU, which consists of an accelerometer and/or gyroscope) are read by a source agent which produces a continuous stream of acceleration measurements. At time T a prediction agent computes a probability distribution of the drone's trajectory in an interval $[T, T + H]$, where H is a time horizon, given a probability distribution of the drone's state at time T and the drone's planned acceleration in the interval $[T, T + H]$. The true acceleration is the planned acceleration plus noise.

3.2 Fusion Agents

Many fusion agents use the Bayesian update formula, and for completeness, we give the equation. In this example, probabilities and time steps are assumed to be discrete. Let $a(t)$ be the planned acceleration at each point in the interval $[T, T + H]$, and let a be the vector of accelerations over

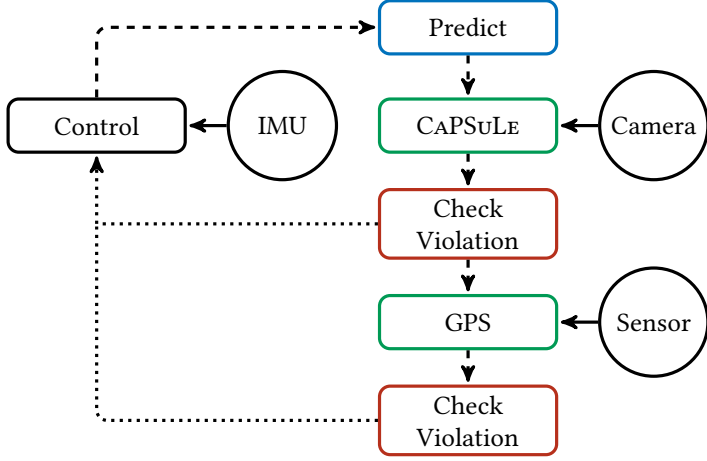

Fig. 6. Drone Navigation Assurance Monitor Agent Network

the interval. We do not discuss how a is calculated. Let random variable $e(t)$ be the acceleration noise at time t . The noise may be correlated with the state (location, velocity and acceleration) of the drone. Let $g(z, a)$ be the probability that the trajectory is z in the interval $[T, T + H]$ given the distribution of drone states at time T , the noise distribution e , and accelerations a .

$$g(z, a) \triangleq \sum_{s, e} p(\text{trajectory} = z | a, e, s) * p(\text{state}_t = s) * p(\text{noise} = e) \quad (1)$$

Since fusion agents update a probability distribution based on some additional data, the output of such an agent is a probability distribution, which can be used as the input to another fusion agent. Figure 6 shows an example of such a composition of fusion agents.

3.3 Fusion Agent: CAPSuLE

The CAPSuLE fusion agent implements a positioning system that approximates the location of the drone through an image-based matching algorithm [20] that utilizes the camera of that device. The location is approximated by matching the image, captured by the on-board camera, against a database of images stored on-board.

Figure 7b shows that the raw location distribution reported by CAPSuLE can be both uncertain and inaccurate under adverse conditions. This is a result of the input image that is fed to CAPSuLE, corresponding to the area under the yellow rectangle, which is mostly cloud-covered water and lacks the distinct features that are needed for accurate matching. The uncertainty and error are mitigated by the CAPSuLE fusion agent in the same simulation step, by fusing the CAPSuLE distribution with the previous location distribution, updated with respect to the previous control action. Given the location distribution $L_{T'}$ at the previous time T' , updated with respect to the control signal for the time interval $(T', T]$, and given the location distribution C_T obtained from CAPSuLE at the current time T , the location distribution L_T for T is computed as follows:

$$L_T^{x,y} = L_{T'}^{x,y} \cdot \sum_{(x',y') \in \text{dim}(C_T)} (C_T^{x',y'} \cdot K_{x,y}^{x',y'}) \quad (2)$$

where $L^{x,y}$ denotes the probability density at location (x, y) in the distribution L , $\text{dim}(C_T)$ is the set of coordinates of C_T , and $K_{x,y}^{x',y'}$ is the probability that an image taken at (x, y) matches location

(x', y') . The map K is estimated by feeding each image in the CAPSULE image database as a query to CAPSULE, thus obtaining a distribution for the corresponding location.

The resulting distribution is both more precise, and more accurate, as we can see in Figure 7c. The simulation suggests that accuracy of camera-based navigation can be improved substantially by taking into account other information that is available on-board a drone during a flight, even when the drone is controlled autonomously. We note that, even though Figure 7c shows fusion improving the CAPSULE location estimate, Figure 7b is a particularly imprecise example, and there are situations when the fusion will instead correct the location estimate obtained from the control signal. This is because the latter is subject to drift, due to external forces acting on the drone, aside from the actuation that the controller dictates.

A computation agent matches photos taken by the drone with the database to compute the conditional probability $p(s|q)$ that the drone is at location s given photo q . This probability is computed by CAPSULE [20] in the experiments reported in Section 4; we note that any program with a Python interface can be inserted easily into the the computation agent to replace CAPSULE with another localization algorithm.

Several factors contribute to uncertainty in the location distribution output by CAPSULE. If the query image depicts an area that does not possess unique features, then the resulting distribution will be spread out across the map, reflecting the locations where such features are present. However, physical constraints, such as the previous location of the drone and the plan that was used to control the drone since then, dictate that some of those possible locations are unrealistic. This intuition is realized in the updating scheme implemented by the fusion agent, whereby the previous location distribution, updated with respect to the control signal (by the Predict agent) is fused with the current CAPSULE location estimate.

3.4 Fusion Agent: GPS

The GPS fusion agent reads a signal from its sensor, which is assumed to coincide with the ground truth location with a high probability p_{GPS} . Thus, compared to the inexact information obtained from the CAPSULE agent, the GPS signal plays the role of an oracle for the location, but does so at the cost of consuming additional resources. The error is assumed to be uniformly distributed over its eight neighboring locations, which are each assigned a probability of $\frac{1-p_{\text{GPS}}}{8}$.

3.5 Check Violation Agents

A drone is a resource-constrained system. Aside from navigation, its on-board energy resources are used for propulsion, to power sensors and communications equipment, and to perform computation needed for the drone’s mission. Under these circumstances, it is of interest to use cheaper alternatives to resource-intensive processes, such as positioning, whenever possible. Yet, when the risk of some harm is deemed sufficiently high, resources should be used to mitigate the risk. Managing this tradeoff is the job of a check-violation agent.

A check-violation agent uses $g(z)$ (defined in Equation 1) to compute the probability that the drone will enter a no-fly zone in $[T, T + H]$. This agent also checks the availability of resources required to acquire and process additional sensor data. If the probability of violating constraints is low then the agent generates a continue signal and the drone continues its planned acceleration. Otherwise, if sufficient resources (energy, computational power) are available, the agent requests that the system acquire location information from the GPS sensor to improve the drone’s location estimate. If the probability of violating constraints is unacceptable and insufficient resources are available, the agent generates an event signaling that a correction is required.

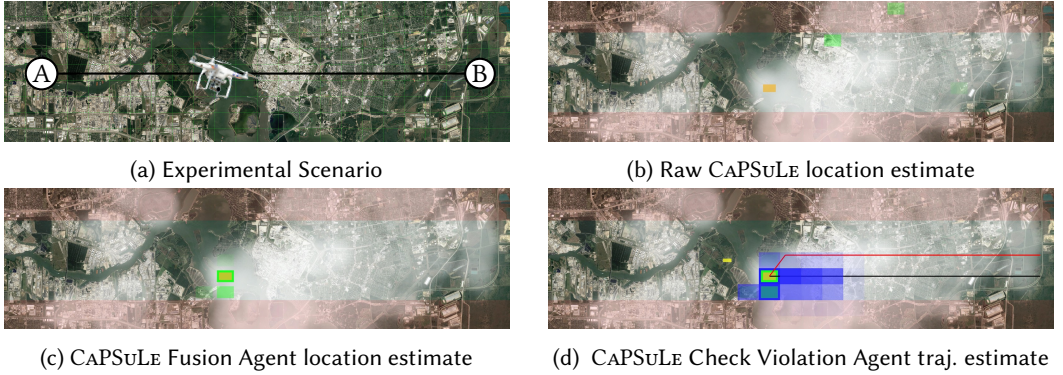

Fig. 7. Drone Navigation Simulation. Red areas represent the no-fly zone. A yellow rectangle represents the originally planned position. A yellow rectangle represents the ground truth, which is determined by both control and perturbations. Green rectangles represent the current location distribution. Blue rectangles represent planned trajectory distribution used by the assurance monitor to estimate probability of entering the no-fly zone.

The optimal strategy for the check-violation agent is complex and the experiments use a simpler heuristic. If the probability of violation is low then the agent outputs a continue message regardless of the availability of resources. Else, if the amounts of resources available exceed a threshold then the agent outputs a request to get additional data. This data should produce better estimates (in some cases, images may be taken for goals other than navigation; in these cases the agent requests use of the images). Finally, if the agent determines that violation is likely and that resources are insufficient, then the agent outputs a message instructing the drone to take corrective action.

Figure 7d illustrates the predictions (blue rectangles) generated by the Check Violation agent, and resulting corrective control action (red line). The assurance monitor makes decisions based on predictions over a time horizon H into the future. Based on H , and the location distribution L_T at the current time T obtained from the corresponding fusion agent, a sequence $F_{[T, T+H]}$ of location distributions for the time interval $[T, T+H]$ is computed from L_T by propagating the control plan $a(t)$, augmented by an estimate of future perturbations $b(t)$, up to time $T+H$. The trajectory map $F_{[T, T+H]}$ is a sequence of location distributions F_0, F_1, \dots, F_{H-1} , computed using the distribution propagation map G as follows:

$$\begin{aligned}
 F_0 &= L_T \\
 F_n &= G(F_{n-1}) \\
 G(L)^{x,y} &= L^{d(x,y)} + e(L, x, y) \\
 d(x, y) &= (x, y) - a(t) - b(t)
 \end{aligned}$$

where $a(t)$ and $b(t)$ are time-indexed sequences of spatial displacements, and $e(L, x, y)$ is a noise term by which the probability at location (x, y) dissipates into its neighboring locations with a given probability.

4 EXPERIMENTS IN ASSURANCE MONITORING

To demonstrate the behavior of an assurance monitor, we review a simulation of the drone navigation application described in the previous section. In this simulation, the drone should follow a straight-line trajectory between two points A and B , at either side of the known terrain illustrated in

Figure 7a. This terrain is represented as a grid of images in the database, constructed by partitioning a high-resolution aerial photograph of the terrain into 20×24 tiles. Each tile is associated with the location at its center point.

While the photograph is taken in good weather, the simulation assumes that the drone is flying in less favorable conditions. Thus, in the images that are available for navigation, parts of the terrain is obscured by clouds, making the camera-based navigation task harder, and the location distribution reported by CAPSULE more uncertain.

The controller’s planned actions are represented by a list of velocities for the remainder of the flight. During the flight, wind and actuation inaccuracies take the drone off its planned trajectory. This is simulated by a random perturbation that is added to the control velocities at every step of the simulation.

Locations more than two tiles away from the planned trajectory are considered a *no-fly zone*, colored in red. The job of the assurance monitor is to predict that the drone may enter this zone – as a result of incorrect control, the past history of perturbations – and initiate corrective control. To avoid unnecessary avoidance maneuvers due to uncertainty about the location of the drone, the assurance monitor implements a policy that activates the GPS when the remaining resources exceed a threshold, which is a function of the remaining energy resources and flight duration.





4.1 Assurance

The opacity of the blue rectangles in Figure 7d reflect the densities of locations in $F_{[T, T+H]}$. The probability of entering the no-fly zone is defined as the greatest density among all locations in $F_{[T, T+H]}$ that are also in the no-fly zone. Figure 7d shows a step in the simulation where this probability exceeds the 5% threshold for an assurance violation, causing the system to generate a corrective control action. To take into account uncertainty about the current state of the system, the assurance monitor performs its predictions based on distributions. However, a single control action must be passed to the controller. Thus, the revised control plan (red line) is computed based on the mean location, which can be seen to take the drone to the target location B along a safer trajectory, further away from the no-fly zone, compared to the original control plan (black line).

Table 1 shows an extract from an execution of the simulation that exhibits different signals produced by CAPSULE and GPS check violation (CV) agents. Up to time 12, the CAPSULE fusion actor’s location estimate suffices to yield a sequence of “Continue” decisions from the CAPSULE CV agent. At time 13 the drone is taken off-course by wind. The probability of entering the no-fly zone remains under the 5% threshold over the next two steps, which again yields “Continue” signals from the CAPSULE CV agent. At time 15, wind again moves the drone. This time, the trajectory distribution indicates a high (30.9%) probability of entering the no-fly zone. Because sufficient resources remain, the CAPSULE CV agent produces the “More Data” signal. The subsequent GPS reading is sufficiently precise that the probability of entering the no-fly zone falls back below the threshold, and the GPS CV agent produces a “Continue” signal. However, at the next step, both the CAPSULE and GPS CV agents predict a high risk of assurance violation, and the GPS CV agent produces a “Change” signal to redirect the drone to a safe trajectory. Over the next three steps, the drone moves away from the no-fly zone along the revised, safe trajectory. The trajectory estimates reflect the successively falling probability of entering the no-fly zone during these steps.

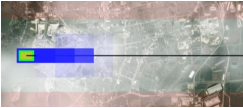
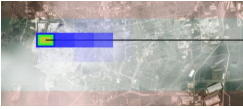
The experiment described in this section uses assurance criteria based on the system’s physical location. The assurance criterion could easily be extended to depend on more abstract states, such as temperature, current, power, latency or remaining resources, using the same pattern to avoid that it is violated.

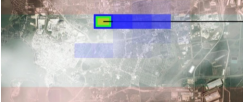
Table 1. Drone navigation simulation steps that exhibit different check violation agent decisions.

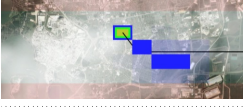
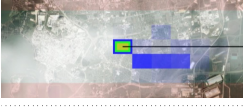
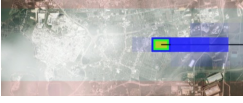
Predicted trajectory	Time	Resources	Probability	CV Agent	Signal
	12	12	0.1%	CAPSuLE	Continue
	13	12	1.9%	CAPSuLE	Continue
	14	12	2.0%	CAPSuLE	Continue
	15	12 11	30.9% 1.9%	CAPSuLE GPS	More Data Continue
	16	11 10	27.5% 34.1%	CAPSuLE GPS	More Data Change
	17	10	2.14%	CAPSuLE	Continue
	18	10	1.9%	CAPSuLE	Continue
	19	10	0.2%	CAPSuLE	Continue

5 EXAMPLE APPLICATION: TIMESTAMP SENSORS

The assurance monitoring pattern uses networks of agents including source, fusion, prediction and check-violation agents (Figure 3). Tracking airplanes and taking appropriate action using Kalman filters is an example of the assurance monitoring pattern that is very widely used. The pattern is also used in finance where the constraints are on deviation of the performance of a stock portfolio from benchmarks of the broad stock exchange. In this section, we review an example from sensor networks. Our goal is limited to showing how the same pattern occurs in a very different context from that covered in Section 3.

Some event-based applications require the assurance that events are timestamped accurately. For example, accurate timestamps are necessary in applications that analyze mechanical or seismological structures by computing relative accelerations of structural components [6]. In some cases, computers attached to sensors – such as those in utility closets in building basements – do

not have access to GPS, and in these cases, timestamps are obtained from local system clocks in the computer. The accuracy of timestamps can be improved by using NTP services; however, the use of such services requires communication and computation which can be scarce resources on embedded computers that also have to perform other tasks.

A constraint for the application is that the time reported by the local clock can deviate from the true time by no more than a specified limit. The application is required to provide the assurance that this constraint is never violated or is violated only with very low probability.

Using the local clock is inexpensive compared with using the NTP server, and so the application determines when to call NTP. In this application, the resource that has to be managed is the amount of bandwidth and computation used by the application whereas in drone navigation the resources were battery power and computational load.

Many different algorithms have been used to improve accuracy of timestamps; here we give an example to illustrate the use of the assurance monitor pattern. Figure 8 depicts an agent network for such an application, which uses two sources for time: a local computer clock and an NTP server. The Local clock source agent receives timestamps from the local clock and the NTP clock source agent receives more accurate timestamps from an NTP server. The fusion agent integrates the information it receives from both the local clock and the NTP server to estimate the deviation of the local clock from the true time at every instant.

A prediction agent gets parameters from the fusion agent and predicts the probability distribution of the deviation as it changes with time. A check-violation agent determines when the probability of violating constraints will become unacceptably high and it also keeps track of the amount of resources that are available. If sufficient resources (e.g. bandwidth) are available, then an NTP service is invoked before the constraint is violated. When resources are not scarce the service is called frequently whereas when resources are tight, the service is called only when needed.

Next, we discuss one of many possible algorithms for the agents in the application. The deviation of the true time from the local clock reading, illustrated in Figure 9, is a random variable W_t at time t . This random variable can be modeled as a Wiener process with drift μ and infinitesimal variance σ^2 . Then $W_{t+T} - W_t$ is a random variable which has a normal distribution with mean μT and variance $\sigma^2 T$. For example, if $\mu = -0.01$ and $\sigma^2 = 0.02$ then after 600 seconds have elapsed, the elapsed time according to the local clock is a random variable with a normal distribution with mean 594 and variance 12.

The fusion agent estimates μ and σ from a window of a fixed number of previous measurements. The calculation is based on the assumptions that the Network Time Protocol (NTP) server is perfectly accurate. Suppose the NTP server has been invoked when the local clock reads $[t_0, t_1, \dots, t_M]$. Let the NTP server reading be T_j when the local clock is at t_j . We focus on estimating the elapsed time between two events rather than on the absolute time. We use the set of data points (t_j, T_j) to estimate μ and σ of the Wiener process. This set of points is a moving window, and now we focus on the calculation for one window.

The elapsed time local clock times from the initial point (i.e. the point at which the local clock read t_0) are: $[(t_1 - t_0), (t_2 - t_0), \dots, (t_M - t_0)]$, and the elapsed times as given by the NTP server at these points are $[(T_1 - T_0), (T_2 - T_0), \dots, (T_M - T_0)]$. Plot the points $(t_j - t_0, T_j - T_0)$ on an $x - y$ plane, and obtain a regression line that passes through the origin. The slope of the regression line is an estimate of parameter μ of the Wiener process. Then,

$$T_j - T_{j-1} = \mu(t_j - t_{j-1}) + \epsilon_j$$

where ϵ_j is an error term.

Consider a time interval where the local clock reads t at the beginning of the interval and t' at the end of the interval, where $t_0 \leq t \leq t' \leq t_M$. Define the *corrected* elapsed local time for this

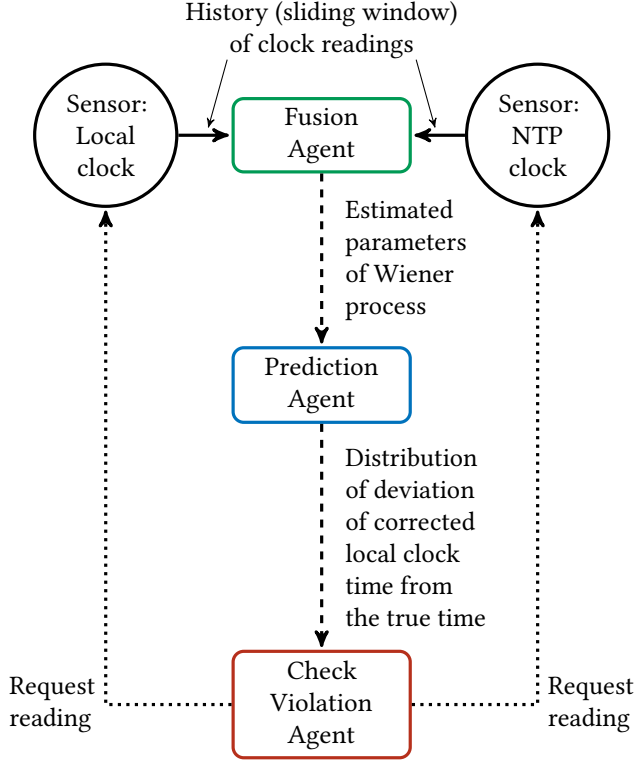

Fig. 8. Timestamp Sensors Assurance Monitor Agent Network

interval as:

$$c(t' - t) = \mu(t' - t)$$

For the interval in which the local clock reads t_{j-1} at the start of the interval and t_j at the end, we have:

$$T_j - T_{j-1} = c(t_j - t_{j-1}) + \epsilon_j$$

and therefore:

$$\epsilon_j = (T_j - T_{j-1}) - c(t_j - t_{j-1})$$

So ϵ_j is the error between the true and corrected local clock elapsed times for the j -th interval.

From the assumptions of a Wiener process, the random variables of non-overlapping intervals are independent. Each ϵ_j is a single sample value of a random variable which has a normal distribution with zero mean and variance $(T_j - T_{j-1})\sigma^2$. All these random variables are independent of each other because the intervals are non-overlapping. Hence, the probability density of getting all the sample values $\epsilon_1, \epsilon_2, \dots, \epsilon_M$, is the product of these probability densities. We estimate the variance to be the value σ^2 that maximizes the likelihood of the set of observations ϵ_j , all j . The maximum likelihood estimator for σ^2 is:

$$\sigma^2 = \sum_j \frac{\epsilon_j^2}{T_j - T_{j-1}}$$

The estimate of σ is passed from the fusion agent to the prediction agent.

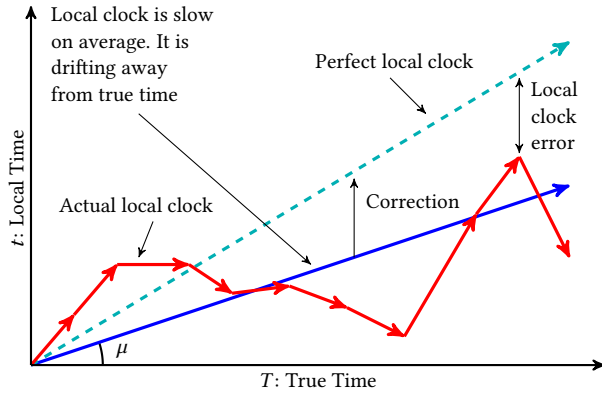

(a) Local Time Versus True (NTP) Time

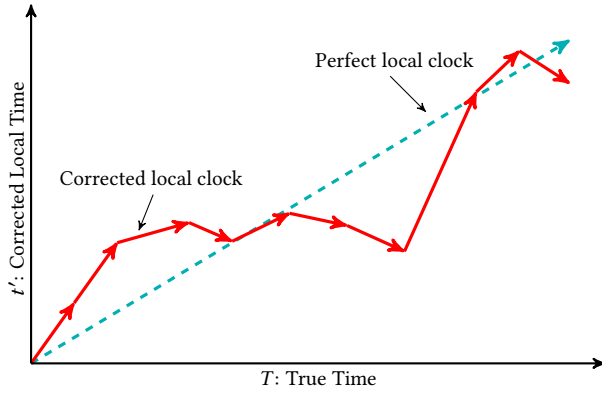

(b) Corrected Local Time Versus True Time

Fig. 9. Error and Correction of Local Time Versus True (NTP) Time

The prediction agent has the responsibility of predicting the distribution of the deviation ϵ of the corrected local time from the true time, for every instant in the future. The check-violation agent has the responsibility of computing the probability that the deviation will exceed a specified limit for every point in the future. The check-violation agent then determines the future time after which this probability exceeds a specified threshold. The NTP server must be read before this time to satisfy the assurance requirements.

In this example, the prediction agent and check-violation agent are simple and can be combined into a single, simple agent. Let t_M be the local clock time when the NTP server was read most recently and let T_M be the NTP value. Treat the point t_M, T_M as the new origin and compute elapsed time from that point. When the elapsed time according to the local clock is $t - t_M$ then the corrected elapsed time is $\mu(t - t_M)$ where μ is the estimate for the drift.

The deviation of the corrected time from the true time at a true time T is a random variable with zero mean and a variance of $(T - T_0)\sigma^2$ where σ is estimated as described earlier. The agent has access to the local clock but doesn't know the true time T until it reads an NTP server; so, we use the following approximation. The deviation of the corrected time from the true time when the *local clock* is at t is a random variable with zero mean and a variance of $(t - t_0)\sigma^2$. Computing the local clock time at which the constraint is violated is now straightforward.

6 RELATED AND FUTURE WORK

A simple related pattern that has already been identified by the event-based systems community is Event Monitor [19]. It describes a component that polls a system for state changes and notifies components that are registered with the event monitor, a variant of the observer pattern where the event monitor acts as an intermediary for multiple components interested in monitoring each other's state. In contrast, assurance monitors predict the occurrence of future events and *act preemptively to prevent unwanted events from occurring*. This trait is shared by the Event-based Learning pattern [22], though assurance monitors combine predictive models with control, that is, a means of enacting remedial actions, as well as means to stage these reactions to account for different event severity levels.

In our future work, we plan to investigate instances of the pattern that use more sophisticated prediction agents that rely on extensive offline training, such as deep neural networks. These models have impressive predictive power but whose accuracy can be hard to reason about. To address this, we also plan to explore the issue of quantifying the accuracy of predictions used by assurance monitors, which is currently an area of active research [11, 25].

7 CONCLUSION

We think a more formal use of design patterns for event processing will be helpful as more event processing applications are developed. We described one design pattern – the assurance monitor pattern – for a class of event processing applications. We described one application, drone navigation, in detail, and showed how the assurance monitor pattern can be used in other applications through a second example: time stamping. The pattern, documentation, and related code are freely available. Work by the EBS community on design patterns for event processing, including the development of an open library of patterns, will be of great service to all who want to develop event-processing applications.

Why talk about patterns when code that implements the pattern is available? The code is only one instantiation of the pattern. As we saw in the timestamp application, some components of the pattern may become so trivial that they can be combined with other components. In some applications we may want to execute collections of components in parallel; for example we may want sensors to execute concurrently and push their readings to fusion agents. In other applications, we may want the code to execute within a single process and where the application pulls data from sensors; we ask the sensors to measure data only when we need it, as in the case of the GPS sensor for drone navigation. The range of implementation options is huge – e.g., single process versus multiprocess, push versus pull – but the idea of a common pattern is helpful in developing each of the implementations.

Another reason for abstracting the pattern is that it helps in teaching. Indeed, the books on event processing describe patterns, though sometimes more implicitly than explicitly. We believe that more formal use of software design patterns for event processing will help in teaching event-based systems and in propagating the research done by the community.

REFERENCES

- [1] Christopher Alexander. *A pattern language: towns, buildings, construction*. Oxford university press, 1977.
- [2] Apache Foundation. Apache Kafka. <https://kafka.apache.org>.
- [3] Assurance Monitor proof-of-concept source code. <https://github.com/adamduracz/assurance-monitor-poc>.
- [4] Kenneth Birman and Thomas A. Joseph. Exploiting virtual synchrony in distributed systems. *SIGOPS Operating Systems Review*, 21(5):123–138, November 1987.
- [5] K. Mani Chandy and W. Roy Schulte. *Event Processing: Designing IT Systems for Agile Companies*. McGraw-Hill, Inc., New York, NY, USA, 1 edition, 2010.

- [6] Robert W Clayton, Thomas Heaton, Mani Chandy, Andreas Krause, Monica Kohler, Julian Bunn, Richard Guy, Michael Olson, Mathew Faulkner, MingHei Cheng, et al. Community Seismic Network. *Annals of Geophysics*, 54(6), 2012.
- [7] Thomas Erl. *SOA design patterns*. Pearson Education, 2008.
- [8] Opher Etzion, Peter Niblett, and David C Luckham. *Event processing in action*. Manning Greenwich, 2011.
- [9] Eduardo B Fernandez and Rouyi Pan. A pattern language for security models. In *In Proc. of PLoP*, volume 1, 2001.
- [10] Erich Gamma, Richard Helm, Ralph Johnson, and John Vlissides. *Design Patterns: Elements of Reusable Object-oriented Software*. Addison-Wesley Longman Publishing Co., Inc., Boston, MA, USA, 1995.
- [11] Timon Gehr, Matthew Mirman, Dana Drachler-Cohen, Petar Tsankov, Swarat Chaudhuri, and Martin Vechev. Ai2: Safety and robustness certification of neural networks with abstract interpretation. In *2018 IEEE Symposium on Security and Privacy (SP)*, pages 3–18. IEEE, 2018.
- [12] Imen Graja, Slim Kallel, Nawal Guermouche, and Ahmed Hadj Kacem. Time patterns for cyber-physical systems. In *Computers and Communication (ISCC), 2016 IEEE Symposium on*, pages 1208–1211. IEEE, 2016.
- [13] Jeffrey Heer and Maneesh Agrawala. Software design patterns for information visualization. *IEEE transactions on visualization and computer graphics*, 12(5):853–860, 2006.
- [14] Gregor Hohpe and Bobby Woolf. *Enterprise integration patterns: Designing, building, and deploying messaging solutions*. Addison-Wesley Professional, 2004.
- [15] Mariam Kiran, Peter Murphy, Inder Monga, Jon Dugan, and Sartaj Singh Baveja. Lambda architecture for cost-effective batch and speed big data processing. In *Proceedings of the 2015 IEEE International Conference on Big Data (Big Data), BIG DATA '15*, pages 2785–2792, Washington, DC, USA, 2015. IEEE Computer Society.
- [16] Ralf Lämmel and Simon Peyton Jones. *Scrap your boilerplate: a practical design pattern for generic programming*, volume 38. ACM, 2003.
- [17] Antonio Loquercio, Ana Isabel Maqueda, Carlos R Del Blanco, and Davide Scaramuzza. Dronet: Learning to fly by driving. *IEEE Robotics and Automation Letters*, 2018.
- [18] David Luckham. *The power of events*, volume 204. Addison-Wesley Reading, 2002.
- [19] Paul B Monday. Exploring the event monitor pattern. In *Web Services Patterns: Java™ Platform Edition*, pages 169–186. Springer, 2003.
- [20] Yongshik Moon, Soonhyun Noh, Daedong Park, Chen Luo, Anshumali Shrivastava, Seongsoo Hong, and Krishna Palem. Capsule: A camera-based positioning system using learning. In *System-on-Chip Conference (SOCC), 2016 29th IEEE International*, pages 235–240. IEEE, 2016.
- [21] Angelika Musil, Juergen Musil, Danny Weyns, Tomas Bures, Henry Muccini, and Mohammad Sharaf. Patterns for self-adaptation in cyber-physical systems. In *Multi-Disciplinary Engineering for Cyber-Physical Production Systems*, pages 331–368. Springer, 2017.
- [22] Adrian Paschke, Paul Vincent, Alex Alves, and Catherine Moxey. Tutorial on advanced design patterns in event processing. In *Proceedings of the 6th acm international conference on distributed event-based systems*, pages 324–334. ACM, 2012.
- [23] Soheil Qanbari, Samim Pezeshki, Rozita Raisi, Samira Mahdizadeh, Rabee Rahimzadeh, Negar Behinaein, Fada Mahmoudi, Shiva Ayoubzadeh, Parham Fazlali, Keyvan Roshani, et al. Iot design patterns: computational constructs to design, build and engineer edge applications. In *Internet-of-Things Design and Implementation (IoTDI), 2016 IEEE First International Conference on*, pages 277–282. IEEE, 2016.
- [24] Lukas Reinfurt, U Breitenbücher, M Falkenthal, F Leymann, and A Riegg. Internet of things patterns for devices. In *Proceedings of the Ninth International Confs. on Pervasive Patterns and Applications (PATTERNS)*, pages 117–126, 2017.
- [25] Gagandeep Singh, Timon Gehr, Markus Püschel, and Martin Vechev. An abstract domain for certifying neural networks. *Proceedings of the ACM on Programming Languages*, 3(POPL):41, 2019.
- [26] Nikolai Smolyanskiy, Alexey Kamenev, Jeffrey Smith, and Stan Birchfield. Toward low-flying autonomous mav trail navigation using deep neural networks for environmental awareness. *arXiv preprint arXiv:1705.02550*, 2017.