

REFINED MOVES FOR STRUCTURE-PRESERVING ISOMORPHISM OF GRAPH C^* -ALGEBRAS

SØREN EILERS AND EFREN RUIZ

ABSTRACT. We formalize eight different notions of isomorphism among (unital) graph C^* -algebras, and initiate the study of which of these notions may be described geometrically as generated by moves. We propose a list of seven types of moves that we conjecture has the property that the collection of moves respecting one of six notions of isomorphism indeed generate that notion, in the sense that two graphs are equivalent in that sense if and only if one may transform one into another using only these kinds of moves.

We carefully establish invariance properties of each move on our list, and prove a collection of generation results supporting our conjecture with an emphasis on the gauge simple case. In two of the six cases, we may prove the conjecture in full generality, and in two we can show it for all graphs defining gauge simple C^* -algebras. In the two remaining cases we can show the conjecture for all graphs defining gauge simple C^* -algebras provided that they are either finite or have at most one vertex allowing a path back to itself.

1. INTRODUCTION

The *geometric classification* of unital graph C^* -algebras obtained by the authors with Restorff and Sørensen gives a description of the equivalence relation induced on all directed graphs with finitely many vertices (but possibly countably infinitely many edges) by stable isomorphism of their associated graph C^* -algebras, as the coarsest equivalence relation containing a number of moves on the graphs. Thus, in a way resembling the role played by Reidemeister moves for homotopy of knots, two graphs define the same C^* -algebra up to stable isomorphism if and only if there is a finite number of such moves which leads from one graph to another. The moves are all local in nature – affecting only the graph in a small neighborhood of the vertex to which it is applied – and the basic moves have their origin in symbolic dynamics, viz. *in-splitting* and *out-splitting* as defined and studied by Williams ([Wil73]) as a way of characterizing conjugacy among shifts of finite type.

The emphasis on moves originally served as a vehicle of providing K -theoretical classification of this class of non-simple C^* -algebras, but we have found that such a characterization carries substantial weight in itself, by explaining many known phenomena and providing a convenient tool for establishing new insights.

In parallel with these efforts, it has recently been discovered in a movement pioneered by Kengo Matsumoto that the subclass of graph algebras associated in this way to finite essential graphs – the so-called Cuntz-Krieger algebras – have profound rigidity properties when one considers them not as C^* -algebras alone, but as C^* -algebras equipped with natural extra structure. More precisely, the symbolic dynamical systems defined as shifts of finite type associated to such graphs are remembered by the C^* -algebras at varying level of precision depending upon how much structure is considered. Key objects are the

<i>Notion</i>	<i>Data</i>	<i>Which SFTs?</i>	<i>Ref.</i>
Flow equivalence	$(\mathcal{O}_A \otimes \mathbb{K}, \mathcal{D}_A \otimes c_0)$	Irreducible All	[MM14] [CEOR19]
Conjugacy	$(\mathcal{O}_A \otimes \mathbb{K}, \mathcal{D}_A \otimes c_0, \gamma^A \otimes \text{id})$	All	[CR17]
Shift equivalence	$(\mathcal{O}_A \otimes \mathbb{K}, \gamma^A \otimes \text{id})$	Primitive	[BK00]
Continuous orbit equivalence (Period-preserving)	$(\mathcal{O}_A, \mathcal{D}_A)$	Irreducible No isolated points All	[Mat10] [BCW17] [AER18] [CW18]
Eventual conjugacy	$(\mathcal{O}_A, \mathcal{D}_A, \gamma^A)$	Irreducible All	[Mat17] [CR17]

FIGURE 1. Assorted results

diagonal and the gauge action either associated to the Cuntz-Krieger algebra \mathcal{O}_A itself (denoted \mathcal{D}_A and γ^A , respectively), or associated to the stabilization $\mathcal{O}_A \otimes \mathbb{K}$ ($\mathcal{D}_A \otimes c_0$ and $\gamma^A \otimes \text{id}$, respectively). Figure 1 lists a collection of such results presently known, showing that standard dynamical notions such as conjugacy and flow equivalence are indeed rigidly remembered by the operator algebras, and providing motivation for the study of new concepts of sameness of such dynamical systems.

To systematically address questions of this nature, we propose here a nomenclature to express isomorphisms of eight different type by means of 3-bit words that we always denote xyz with $x, y, z \in \{0, 1\}$. The first bit determines whether the isomorphism is exact ($x = 1$) or just stable ($x = 0$), the second whether it must commute with the gauge action (appropriately extended to the stabilization when $x = 0$), and the third whether it must send diagonals (again suitably extended when $x = 0$) to diagonals.

The eight cases are best considered as the corners of a cube

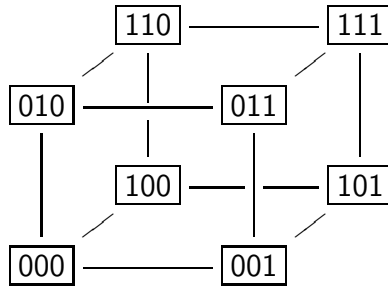

where the data considered by the indicated types of isomorphisms is

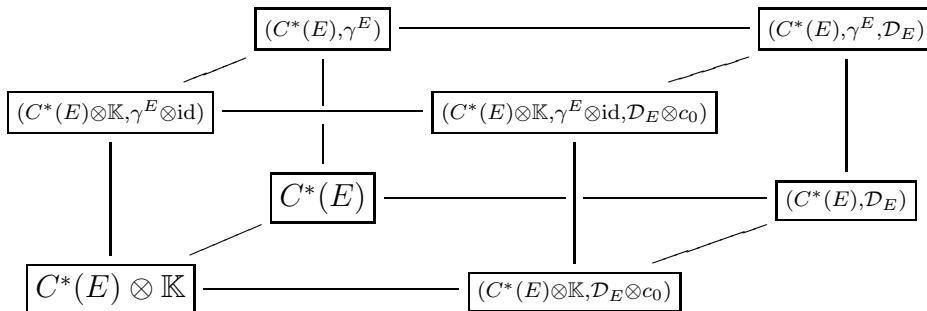

It is essential to note from the outset that since there must be a single isomorphism preserving all structure, it is strictly stronger to satisfy a relation with two bits set than two relations each with one bit set, and so on. For instance, we will give examples of graphs that are 101- and 011-equivalent, but fail to be 111-equivalent (Example 4.8).

Among the results in Figure 1, the result of Carlsen and Rout ([CR17]) that conjugacy of two-sided shifts of finite type is exactly reflected by the stabilized Cuntz-Krieger algebra equipped with the stabilized diagonal and the gauge action trivially extended to the stabilization is the foremost source of motivation for the present work, as it contains a corollary of direct relevance to geometric classification. Indeed, Williams established already in 1973 ([Wil73]) that when two shift of finite types are conjugate – i.e. when the two essential finite graphs are 011-equivalent – one may transform one to the other by a finite number of in- or out-splittings, or their inverses. Since such splitting moves are already on the list of moves considered in [ERRS], and may be seen to be 011-invariant, this begs the question of whether it is the case that the various kinds of sameness defined at the level of operator algebras to reflect the needs of rigidity results are generated as the smallest equivalence relations containing those moves that preserve the relevant notions.

It turns out that any result of this nature fails for the collection of moves previously considered, so the question must be recast as: Does there exist a list of moves generating stable isomorphism among unital graph C^* -algebras with the property that those moves that preserve further structure also generate the relevant refined equivalence relations? Obtaining such a list of moves is a key step towards a unified approach to understanding and comparing the various concepts of sameness, where open questions persist even restricted to the types of graphs considered in the purely dynamical cases. We are hopeful that it may even cast light on the Williams conjecture in symbolic dynamics, and the corresponding question of decidability of strong shift equivalence.

We present here a collection of moves

$$(O), (I+), (I-), (R+), (S), (C+), (P+)$$

that we strongly believe has the generating property in the six cases

$$000, 001, 011, 100, 101, 111$$

(see the end of the introduction for a discussion of the two remaining cases). We will systematically prove that the invariance properties of each type of move are as indicated in Figure 2, and establish – at varying level of generality – a portfolio of theorems of generation which to us serves as evidence for the conjecture that indeed the family of moves we present here have the desired properties. In one of the five new cases we are considering we are able to prove so in full generality, and the proof of this fact will be presented in [AER] jointly with Arklint, which is to be considered a companion paper to the present one. The remaining four we establish for all finite graphs defining gauge simple graph C^* -algebras, two even for all graphs with finitely many vertices defining gauge simple graph C^* -algebras. We also solve in full generality the case of gauge simple algebras defined by graphs with finitely many vertices, having at most one vertex allowing a path back to itself. This case is closely related to the *polycephaly* case considered in the setting of Leavitt path algebras by Hazrat ([Haz13]) and we draw on several ideas from this paper.

We freely concede that in most cases there is quite a lot of work left to develop the framework in which our conjectures can be proved.

	x	y	z	Definition	Invariance	Non-invariance
(O)	1	1	1	3.1	Theorem 3.2	–
(I+)	1	1	1	3.6	Corollary 3.7	–
(I-)	0	1	1	3.3	Theorem 3.4	Example 4.2
(R+)	1	0	1	3.9	Theorem 3.10	Example 4.2
(S)	0	0	1	3.11	Theorem 3.12	Example 4.2
(C+)	1	0	0	3.13	Theorem 3.14	Example 4.8
(P+)	1	0	0	3.15	Theorem 3.16	Example 4.10

FIGURE 2. Invariance properties of the seven moves

The new moves we are presenting are in all cases but one rather small variations of moves that are already in the literature, changed slightly by an addition of sources to ensure that the moves leaving the graph C^* -algebra rather than its stabilization invariant. The one true innovation in the collection of moves is a complete rethinking of the concept of **in-splitting**. The lack of symmetry between out- and insplitting in the setting of graph C^* -algebras was understood already in Bates and Pask’s trailblazing paper [BP04], where they showed that whereas Williams’ out-splitting can be transplanted to operator algebras in a way which does not change the graph C^* -algebra itself (or indeed, as we shall see, any other relevant structure), that is impossible for in-splitting which is only an invariant of the stabilization. But whereas this did not carry any further weight in [BP04] or [ERRS], as soon as one attempts to keep track of the C^* -algebras “on the nose”, or of information stored in the gauge action, it becomes clear that the definition of in-splitting in [BP04] is insufficient.

The solution we present here is to replace the traditional in-splitting move by two new types of moves, called (I-) and (I+). Here (I-) is a rather innocuous variation of Williams’ in-split allowing empty sets in the partition defining the in-splitting, thus introducing sources in a way that we shall see is 011-invariant. The more restrictive (I+) move specializes this to allow the passage between two graphs that result from two different in-splittings of the same graph *having the same number of sets in their partition*. This, as we shall prove, preserves all relevant structure of the graph C^* -algebra and is hence 111-invariant.

As an example, consider the graph

(1.1) 

and in-split the edges having the rightmost vertex as their ranges into two sets evenly and unevenly to obtain

(1.2) 

where as usual, the incoming edges are distributed according to the partition and the outgoing edges are duplicated. We will say one of these two graphs arises from the other by an (I+) move, and will see that their associated C^* -algebras are the same in our

strongest (111) sense. They are also (I+)- and 111-equivalent to

(1.3)

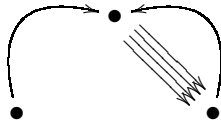

which is obtained by partitioning the four incoming vertices into two sets, one of which is empty. These three graphs are **not** 111-equivalent to that in (1.1).

We were led to (I+) by Example 3.6 of [BC] which exactly compares the two graphs in (1.2), but found that the idea of considering only pairs of partitions with the same number of nonempty set was too restrictive to be generating in any useful sense. Allowing empty sets seems to provide exactly the right level of generality. A good way of thinking of the (I+) move is that whenever two or more vertices have exactly the same future, one may *redistribute their pasts among them freely*. It is natural to consider the (I+) move as an operation on the class of one-sided shift spaces associated to finite graphs without sinks, and concurrent work by Kevin Aguyar Brix ([Bri]) shows that the (I+) move in conjunction with Williams' original out-split generates a notion of sameness of such shift spaces in the same way that Williams' original moves generate conjugacy of two-sided shift spaces.

The relations 010 and 110 have not been left out because they are uninteresting – quite the contrary – but because we have no good candidate for moves generating them at the moment. Indeed, we will see that the example of Kim and Roush disproving Williams' conjecture also show that 010-equivalence is not generated by the moves on our list preserving this notion. It seems likely that if we were to consider shift equivalence as a move, it would be 010-invariant and 010-generating, but this is not known in general at the time. More importantly, it is hard to justify shift equivalence a geometric move because of its inherently arithmetic nature involving all vertices at the same time, so we leave this particular stone unturned for the time being. It should be pointed out that we know almost nothing about the differences between the 110 and 111 cases, and that it remains a possibility that they coincide.

1.1. Acknowledgments. We would like to thank Sara E. Arklint, Kevin Aguyar Brix, Toke Meier Carlsen, Roozbeh Hazrat, Kengo Matsumoto, David Pask, Aidan Sims, and Lia Vas for sharing insights, references and ideas with us at crucial points in this project.

The first named author was supported by the DFF-Research Project 2 'Automorphisms and Invariants of Operator Algebras', no. 7014-00145B, and by the Danish National Research Foundation through the Centre for Symmetry and Deformation (DNRF92). The second named author was supported by a Simons Foundation Collaboration Grant, # 567380.

2. FUNDAMENTALS

2.1. Notation and conventions. We use the definition of graph C^* -algebras in [FLR00] in which sinks and infinite emitters are singular vertices, and always consider $C^*(E)$ as a universal C^* -algebras generated by Cuntz-Krieger families $\{s_e, p_v\}$ with e ranging over edges and v ranging over vertices in E .

Unless stated otherwise, graphs E, F will always be considered as having finitely many vertices and finitely or countably infinitely many edges. We generally follow notation from [ERRS, ERRS18], and in particular denote adjacency matrices by A_E . We especially

	000	001	010	011	100	101	110	111
000		÷ (4.11)	÷ (4.2)	÷ (4.2)	÷ (4.2)	÷ (4.2)	÷ (4.2)	÷ (4.2)
001			÷ (4.2)	÷ (4.2)	÷ (4.2)	÷ (4.2)	÷ (4.2)	÷ (4.2)
010		?		÷ (4.12)	÷ (4.3)	÷ (4.3)	÷ (4.3)	÷ (4.3)
011					÷ (4.3)	÷ (4.3)	÷ (4.3)	÷ (4.3)
100		÷ (4.11)	÷ (4.4)	÷ (4.4)		÷ (4.11)	÷ (4.4)	÷ (4.4)
101			÷ (4.4)	÷ (4.4)			÷ (4.4)	÷ (4.4)
110		?		?		?		?
111								

FIGURE 3. Relations among xyz-invariance

need \mathbf{A}_E^\bullet which is obtained by deleting all rows corresponding to singular vertices. It is convenient when working with K -theory to set $\mathbf{B}_E = \mathbf{A}_E - \mathbf{1}$ and define \mathbf{B}_E^\bullet by again deleting rows.

As usual, the diagonal of any graph C^* -algebra $C^*(E)$ is defined as

$$\mathcal{D}_E = \overline{\text{span}}\{s_\mu s_\mu^* \mid \mu \text{ a finite path in } E\}$$

and the gauge action defines $\gamma_z^E \in \text{Aut}(C^*(E))$ for each $z \in \mathbb{T}$ by

$$\gamma_z^E(s_e) = z s_e \quad \gamma_z^E(p_v) = p_v.$$

2.2. xyz-isomorphism. We are ready to formally state our basic notion of xyz-equivalence. ■

Definition 2.1. With $x, y, z \in \{0, 1\}$ we write

$$E \overset{\text{xyz}}{\rightsquigarrow} F$$

and say that E and F are xyz-equivalent when there exists a $*$ -isomorphism $\phi: C^*(E) \otimes \mathbb{K} \rightarrow C^*(F) \otimes \mathbb{K}$ which additionally satisfies

- $\phi(1_{C^*(E)} \otimes e_{1,1}) = 1_{C^*(F)} \otimes e_{1,1}$ when $x = 1$
- $\phi \circ (\gamma_z^E \otimes \text{id}_{\mathbb{K}}) = (\gamma_z^F \otimes \text{id}_{\mathbb{K}}) \circ \phi$ when $y = 1$
- $\phi(\mathcal{D}_E \otimes c_0) = \mathcal{D}_F \otimes c_0$ when $z = 1$.

We use the notation $\overline{\text{xyz}}$ to refer to the equivalence relation among graphs with finitely many vertices defined this way.

Of course xyz-invariance implies $x'y'z'$ -invariance when $\text{xyz} \geq x'y'z'$. In Figure 3 such automatic relations are indicated by shaded entries, and in all cases where counterexamples to non-trivial relations of this kind are known to us, a forward reference to it is indicated. In particular, we know that at least seven different relations are defined this way.

It does not seem completely unreasonable to us that 010-invariance implies 001-invariance ■ in general, whereas we find it hard to imagine that 110-equivalence implies 111, or indeed any of 011, 101. However, no counterexamples are known to us, and it remains a possibility that $\overline{110} = \overline{111}$.

Note that all the 1yz-relations may be formulated directly, as properties for $\phi: C^*(E) \rightarrow C^*(F)$. Note also that there is more than one reasonable way to extend γ^E to $C^*(E) \otimes \mathbb{K}$. Our choice is motivated by [CR17] and differs from the standard choice in Leavitt path algebras (cf. [Haz13]).

2.3. Distinguishing up to $\times_1\mathbb{Z}$. In this section we collect results which allow us to distinguish graphs up to $\times_1\mathbb{Z}$ -equivalence. These results are definitely known to experts, but we have not been able to locate them in the literature at the needed level of precision for dealing with $1\mathbb{Z}$ -equivalence.

It follows from our definitions that any $1\mathbb{Z}$ -equivalence among E and F implies that $\mathcal{F}_E \simeq \mathcal{F}_F$ and that any $0\mathbb{Z}$ -equivalence implies that $\mathcal{F}_E \otimes \mathbb{K} \simeq \mathcal{F}_F \otimes \mathbb{K}$, with \mathcal{F}_E the fixed point algebra

$$\mathcal{F}_E = \{a \in C^*(E) \mid \forall z \in \mathbb{T} : \gamma_z^E(a) = a\}.$$

This C^* -algebra is extremely well understood, in particular it is AF and can be described as a corner in a graph C^* -algebra as follows. Let $E \times_1 \mathbb{Z}$ denote the graph with vertices $E^0 \times \mathbb{Z}$ and edges $E^1 \times \mathbb{Z}$ with range and source maps given by

$$s(e, n) = (s(e), n - 1) \quad \text{and} \quad r(e, n) = (r(e), n).$$

Theorem 2.2 ([Cri08]). *Let E be a graph with finitely many vertices. Then*

$$\mathcal{F}_E \simeq p_0^E C^*(E^1 \times_1 \mathbb{Z}) p_0^E$$

where

$$p_0^E = \sum_{v \in E^0} p_{(v,0)}.$$

In most cases, however, knowing \mathcal{F}_E on its own is not sufficient to distinguish up to $1\mathbb{Z}$ -equivalence. It is easy to see that when $\{p_{(v,n)}, s_{(e,n)}\}$ is a Cuntz-Krieger $E \times_1 \mathbb{Z}$ -family, then so is $\{p_{(v,n+1)}, s_{(e,n+1)}\}$, and consequently a canonical (right) translation map $\text{rt} \in \text{Aut}(C^*(E \times_1 \mathbb{Z}))$ is defined. The key refinement is to retain information carried by rt , which is essentially a dual action $\widehat{\gamma}^E$.

For each $a \in C^*(E)$ and $f \in C(\mathbb{T})$, $f \otimes a$ will denote the continuous function $z \mapsto f(z)a \in C(\mathbb{T}, C^*(E))$. We will also consider $f \otimes a$ as an element of $C^*(E) \rtimes_{\gamma} \mathbb{T}$ in the canonical way inside the regular representation. For each $n \in \mathbb{Z}$, f_n will denote the function in $C(\mathbb{T})$ given by $f_n(z) = z^n$.

Proposition 2.3 ([Rae05, Lemma 7.10]). *Let E be a graph (possibly with a countably infinite number of vertices), let $\gamma: \mathbb{T} \rightarrow C^*(E)$ be the gauge action. There exists a $*$ -isomorphism $\phi: C^*(E \times_1 \mathbb{Z}) \rightarrow C^*(E) \rtimes_{\gamma} \mathbb{T}$ such that $\phi(p_{(v,n)}) = f_n \otimes p_v$, $\phi(s_{(e,n)}) = f_n \otimes s_e$, and $\widehat{\gamma} \circ \phi = \phi \circ \text{rt}$ for all $n \in \mathbb{Z}$, $e \in E^1$, $v \in E^0$, where $\widehat{\gamma} = \widehat{\gamma}(1)$ is the canonical generator for the dual \mathbb{Z} -action on $C^*(E) \rtimes_{\gamma} \mathbb{T}$.*

Proof. Let $\{s_e, p_v : e \in E^1, v \in E^0\}$ be a universal generating Cuntz-Krieger family for $C^*(E)$. Set

$$t_{(e,n)} = f_n \otimes s_e \quad \text{and} \quad q_{(v,n)} = f_n \otimes p_v.$$

We claim that $\{t_{(e,n)}, q_{(v,n)} : (e,n) \in E^1 \times \mathbb{Z}, (v,n) \in E^0 \times \mathbb{Z}\}$ is a Cuntz-Krieger $E \times_1 \mathbb{Z}$ family in $C^*(E) \rtimes_\gamma \mathbb{T}$. The projections are mutually orthogonal by

$$\begin{aligned} (q_{(v,n)}q_{(w,m)})(\zeta) &= \int_{\mathbb{T}} (f_n \otimes p_v)(z) \gamma_z((f_m \otimes p_w)(z^{-1}\zeta)) dz \\ &= \int_{\mathbb{T}} z^{n-m} \zeta^m p_v p_w dz \\ &= \begin{cases} \zeta^m p_w & \text{if } (v,n) = (w,m) \\ 0 & \text{otherwise} \end{cases} \\ &= \delta_{(v,n),(w,m)} q_{(w,m)}(\zeta) \end{aligned}$$

for all $\zeta \in \mathbb{T}$, and the two first Cuntz-Krieger relations are checked by

$$\begin{aligned} t_{(e,n)}^* t_{(g,m)}(\zeta) &= \int_{\mathbb{T}} (f_n \otimes s_e)^*(z) \gamma_z((f_m \otimes s_g)(z^{-1}\zeta)) dz \\ &= \int_{\mathbb{T}} \gamma_z((f_n \otimes s_e)(z^{-1})^*) z^{-m+1} \zeta^m s_g dz \\ &= \int_{\mathbb{T}} z^{n-1} s_e^* z^{-m+1} \zeta^m s_g dz \\ &= \begin{cases} \int_{\mathbb{T}} \zeta^m p_{r(g)} dz & \text{if } (e,n) = (g,m) \\ 0 & \text{otherwise} \end{cases} \\ &= \delta_{(e,n),(g,m)} (f_m \otimes p_{r(g)})(\zeta) \\ &= \delta_{(e,n),(g,m)} q_{r(g,m)}(\zeta), \end{aligned}$$

by

$$\begin{aligned} t_{(e,n)} t_{(e,n)}^*(\zeta) &= \int_{\mathbb{T}} (f_n \otimes s_e)(z) \gamma_z((f_n \otimes s_e)^*(z^{-1}\zeta)) dz \\ &= \int_{\mathbb{T}} z^n s_e \gamma_z(\gamma_{z^{-1}\zeta}((f_n \otimes s_e)(z\zeta^{-1})^*)) dz \\ &= \int_{\mathbb{T}} z^n s_e \gamma_\zeta(z^{-n} \zeta^n s_e^*) dz \\ &= \int_{\mathbb{T}} \zeta^{n-1} s_e s_e^* dz \\ &= (f_{n-1} \otimes s_e s_e^*)(\zeta), \end{aligned}$$

and

$$\begin{aligned}
t_{(e,n)}t_{(e,n)}^*q_{s(e,n)}(\zeta) &= \int_{\mathbb{T}} (f_{n-1} \otimes s_e s_e^*)(z) \gamma_z(f_{n-1} \otimes p_{s(e)}(z^{-1}\zeta)) dz \\
&= \int_{\mathbb{T}} z^{n-1} s_e s_e^* \gamma_z(z^{-n+1} \zeta^{n-1} p_{s(e)}) dz \\
&= \int_{\mathbb{T}} \zeta^{n-1} s_e s_e^* dz \\
&= (f_{n-1} \otimes s_e s_e^*)(\zeta) \\
&= t_{(e,n)}t_{(e,n)}^*(\zeta),
\end{aligned}$$

and by

$$\begin{aligned}
q_{s(e,n)}t_{(e,n)}t_{(e,n)}^*(\zeta) &= \int_{\mathbb{T}} (f_{n-1} \otimes p_{s(e)})(z) \gamma_z((f_{n-1} \otimes s_e s_e^*)(z^{-1}\zeta)) dz \\
&= \int_{\mathbb{T}} z^{n-1} p_{s(e)} \gamma_z(z^{-n+1} \zeta^{n-1} s_e s_e^*) dz \\
&= \int_{\mathbb{T}} \zeta^{n-1} s_e s_e^* dz \\
&= (f_{n-1} \otimes s_e s_e^*)(\zeta) \\
&= t_{(e,n)}t_{(e,n)}^*(\zeta)
\end{aligned}$$

for all $\zeta \in \mathbb{T}$.

For the last Cuntz-Krieger relation, note that $\{(e, m) \in E^1 \times \mathbb{Z} : s(e, m) = (v, n)\} = \{(e, n+1) \mid s(e) = v\}$. Consequently, (v, n) is a finite emitter in $E \times_1 \mathbb{Z}$ if and only if v is a finite emitter in E . Suppose v is a finite emitter in E . Then

$$\begin{aligned}
\left(\sum_{(e,m) \in s^{-1}(v,n)} t_{(e,m)}t_{(e,m)}^* \right) (\zeta) &= \sum_{e \in s^{-1}(v)} t_{(e,n+1)}t_{(e,n+1)}^*(\zeta) \\
&= \sum_{e \in s^{-1}(v)} (f_n \otimes s_e s_e^*)(\zeta) \\
&= \sum_{e \in s^{-1}(v)} \zeta^n s_e s_e^* \\
&= \zeta^n p_v \\
&= (f_n \otimes p_v)(\zeta) \\
&= q_{(v,n)}(\zeta)
\end{aligned}$$

for all $\zeta \in \mathbb{T}$, and this proves the claim.

It follows that there exists a homomorphism $\phi: C^*(E \times_1 \mathbb{Z}) \rightarrow C^*(E) \rtimes_{\gamma} \mathbb{T}$ such that $\phi(p_{(v,n)}) = q_{(v,n)} = f_n \otimes p_v$ and $\phi(s_{(e,n)}) = t_{(e,n)} = f_n \otimes s_e$. Since $E \times_1 \mathbb{Z}$ has no cycles and $q_{(v,n)} \neq 0$, we have that ϕ is injective. Since f_n 's span a dense subset of $C(\mathbb{T})$ and since

$$\text{span}\{f \otimes a : f \in C(\mathbb{T}), a \in C^*(E)\}$$

is dense in $C^*(E) \rtimes_{\gamma} \mathbb{T}$, we have that ϕ is surjective.

Let $\tau \in \widehat{\mathbb{T}}$. Then there exists $m \in \mathbb{Z}$ such that $\tau(z) = z^m$ for all $z \in \mathbb{T}$. Then $\widehat{\gamma}_\tau(t_{(e,n)})(z) = \tau(z)z^n s_e = z^{n+m} s_e = (f_{n+m} \otimes s_e)(z) = t_{(e,n+m)}(z)$ and $\widehat{\gamma}_\tau(q_{(v,n)})(z) = \tau(z)s^n p_v = z^{n+m} p_v = (f_{n+m} \otimes p_v)(z)$ for all $z \in \mathbb{T}$. Consequently, when identifying $\widehat{\mathbb{T}}$ with \mathbb{Z} , we have that

$$\phi \circ \text{rt}(s_{(e,n)}) = \phi(s_{(e,n+1)}) = t_{(e,n+1)} = \widehat{\gamma} \circ \phi(s_{(e,n)})$$

and

$$\phi \circ \text{rt}(p_{(v,n)}) = \phi(p_{(v,n+1)}) = q_{(v,n+1)} = \widehat{\gamma} \circ \phi(p_{(v,n)}).$$

Hence, $\phi \circ \text{rt} = \widehat{\gamma} \circ \phi$. \square

Corollary 2.4. *Suppose E and F are 110-equivalent. Then there exists a $*$ -isomorphism $\psi: C^*(E \times_1 \mathbb{Z}) \rightarrow C^*(F \times_1 \mathbb{Z})$ such that $\psi \circ \text{rt} = \text{rt} \circ \psi$ and $\psi(p_0^E) = p_0^F$.*

Proof. Let ϕ be a 110-isomorphism from $C^*(E)$ to $C^*(F)$. By [Wil07, Corollary 2.4.8], there exist homomorphisms $\phi \rtimes \text{id}: C^*(E) \rtimes_{\gamma_E} \mathbb{T} \rightarrow C^*(F) \rtimes_{\gamma_F} \mathbb{T}$ and $\phi^{-1} \rtimes \text{id}: C^*(F) \rtimes_{\gamma_F} \mathbb{T} \rightarrow C^*(E) \rtimes_{\gamma_E} \mathbb{T}$ such that $\phi \rtimes \text{id}(f)(z) = \phi(f(z))$ and $\phi^{-1} \rtimes \text{id}(g)(z) = \phi^{-1}(g(z))$ for all $f \in C(\mathbb{T}, C^*(E))$, $g \in C(\mathbb{T}, C^*(F))$, and $z \in \mathbb{T}$. Consequently, $(\phi^{-1} \rtimes \text{id}) \circ (\phi \rtimes \text{id})(f)(z) = f(z)$ and $(\phi \rtimes \text{id}) \circ (\phi^{-1} \rtimes \text{id})(g)(z) = g(z)$ for all $f \in C(\mathbb{T}, C^*(E))$, $g \in C(\mathbb{T}, C^*(F))$, and $z \in \mathbb{T}$. Since $C(\mathbb{T}, C^*(E))$ is dense in $C^*(E) \rtimes_{\gamma_E} \mathbb{T}$ and $C(\mathbb{T}, C^*(F))$ is dense in $C^*(F) \rtimes_{\gamma_F} \mathbb{T}$, we have that $(\phi \rtimes \text{id}) \circ (\phi^{-1} \rtimes \text{id}) = \text{id}$ and $(\phi^{-1} \rtimes \text{id}) \circ (\phi \rtimes \text{id}) = \text{id}$. Hence, $\phi \rtimes \text{id}$ is a $*$ -isomorphism.

Since

$$\begin{aligned} ((\phi \rtimes \text{id}) \circ (\widehat{\gamma^E})_\tau(f))(z) &= \phi((\widehat{\gamma^E})_\tau(f)(z)) \\ &= \phi(\tau(z)f(z)) = \tau(z)\phi(f(z)) \\ &= \tau(z)(\phi \rtimes \text{id})(f)(z) \\ &= (\widehat{\gamma^F})_\tau \circ (\phi \rtimes \text{id})(f)(z), \end{aligned}$$

for all $f \in C(\mathbb{T}, C^*(E))$ and $z \in \mathbb{T}$ and since $C(\mathbb{T}, C^*(E))$ is dense in $C^*(E) \rtimes_{\gamma_E} \mathbb{T}$, we have that $\phi \rtimes \text{id}$ is an equivariant $*$ -isomorphism from $(C^*(E) \rtimes \mathbb{T}, \widehat{\gamma^E})$ to $(C^*(F) \rtimes \mathbb{T}, \widehat{\gamma^F})$.

Let $\phi_E: C^*(E \times_1 \mathbb{Z}) \rightarrow C^*(E) \rtimes_{\gamma_E} \mathbb{T}$ and $\phi_F: C^*(F \times_1 \mathbb{Z}) \rightarrow C^*(F) \rtimes_{\gamma_F} \mathbb{T}$ be the $*$ -isomorphisms given in the above proposition for E and F respectively. Note that

$$\begin{aligned} \phi \rtimes \text{id} \left(\sum_{v \in E^0} f_0 \otimes p_v \right) (\zeta) &= \sum_{v \in E^0} (\phi \rtimes \text{id})(f_0 \otimes p_v)(\zeta) \\ &= \sum_{v \in E^0} \phi(p_v) \\ &= \phi(1_{C^*(E)}) \\ &= 1_{C^*(F)} \\ &= \sum_{w \in F^0} p_w \\ &= \sum_{w \in F^0} (f_0 \otimes p_w)(\zeta) \end{aligned}$$

for all $\zeta \in \mathbb{T}$. Thus, $\phi \rtimes \text{id} \left(\sum_{v \in E^0} f_0 \otimes p_v \right) = \sum_{w \in F^0} f_0 \otimes p_w$. Set $\psi = \phi_F^{-1} \circ (\phi \rtimes \text{id}) \circ \phi_E$. Then ψ is a $*$ -isomorphism from $C^*(E \times_1 \mathbb{Z})$ to $C^*(F \times_1 \mathbb{Z})$,

$$\psi(p_0^E) = \phi_F^{-1} \circ (\phi \rtimes \text{id}) \circ \left(\sum_{v \in E^0} f_0 \otimes p_v \right) = \phi_F^{-1} \left(\sum_{w \in F^0} f_0 \otimes p_w \right) = p_0^F,$$

and

$$\begin{aligned} \text{rt} \circ \psi &= \text{rt} \circ \phi_F^{-1} \circ (\phi \rtimes \text{id}) \circ \phi_E \\ &= \phi_F^{-1} \circ (\widehat{\gamma^F})_1 \circ (\phi \rtimes \text{id}) \circ \phi_E \\ &= \phi_F^{-1} \circ (\phi \rtimes \text{id}) \circ (\widehat{\gamma^E})_1 \circ \phi_E \\ &= \phi_F^{-1} \circ (\phi \rtimes \text{id}) \circ \phi_E \circ \text{rt} \\ &= \psi \circ \text{rt}. \end{aligned}$$

□

Since the C^* -algebras we consider here are AF, there is no loss of information in passing to K -theory. We note explicitly:

Corollary 2.5. *Suppose E and F are 110-equivalent. Then there exists an order isomorphism $h: K_0(C^*(E \times_1 \mathbb{Z})) \rightarrow K_0(C^*(F \times_1 \mathbb{Z}))$ such that $h \circ \text{rt}_* = \text{rt}_* \circ h$ and $h([p_0^E]) = [p_0^F]$.*

3. REFINED MOVES

In this section we define all seven types of moves and establish their invariance properties.

3.1. Outsplitting. Our first move is a standard outsplitting move, which is exactly as in [BP04]. We include the definition for completeness, and check that the moves preserve all relevant structure via the canonical $*$ -isomorphism studied in that paper.

Definition 3.1 (Move (O): Outsplit at a non-sink). *Let $E = (E^0, E^1, r, s)$ be a graph, and let $w \in E^0$ be a vertex that is not a sink. Partition $s^{-1}(w)$ as a disjoint union of a finite number of nonempty sets*

$$s^{-1}(w) = \mathcal{E}_1 \sqcup \mathcal{E}_2 \sqcup \cdots \sqcup \mathcal{E}_n$$

with the property that at most one of the \mathcal{E}_i is infinite. Let E_O denote the graph (E_O^0, E_O^1, r_O, s_O) defined by

$$\begin{aligned} E_O^0 &:= \{v^1 \mid v \in E^0 \text{ and } v \neq w\} \cup \{w^1, \dots, w^n\} \\ E_O^1 &:= \{e^1 \mid e \in E^1 \text{ and } r(e) \neq w\} \cup \{e^1, \dots, e^n \mid e \in E^1 \text{ and } r(e) = w\} \\ r_{E_O}(e^i) &:= \begin{cases} r(e)^1 & \text{if } e \in E^1 \text{ and } r(e) \neq w \\ w^i & \text{if } e \in E^1 \text{ and } r(e) = w \end{cases} \\ s_{E_O}(e^i) &:= \begin{cases} s(e)^1 & \text{if } e \in E^1 \text{ and } s(e) \neq w \\ s(e)^j & \text{if } e \in E^1 \text{ and } s(e) = w \text{ with } e \in \mathcal{E}_j. \end{cases} \end{aligned}$$

We say E_O is formed by performing move (O) to E .

Theorem 3.2 ($(0) \subseteq \overline{111}$). *Let $E = (E^0, E^1, r_E, s_E)$ be a graph and let $w \in E^0$ be a vertex that is not a sink. Partition $s^{-1}(w)$ as a finite disjoint union of subsets,*

$$s^{-1}(w) = \mathcal{E}_1 \sqcup \mathcal{E}_2 \sqcup \cdots \sqcup \mathcal{E}_n.$$

Define $\psi: C^(E) \rightarrow C^*(E_O)$ by $\psi(p_w) = \sum_{i=1}^n p_{w^i}$ and $\psi(p_v) = p_v$ for all $v \in E^0 \setminus \{w\}$ and*

$$\psi(s_e) = \begin{cases} s_{e^1} & \text{if } r_E(e) \neq w \\ \sum_{i=1}^n s_{e^i} & \text{if } r_E(e) = w. \end{cases}$$

Then ψ is a $$ -isomorphism such that $\gamma_z^{E_O} \circ \psi = \psi \circ \gamma_z^E$ and $\psi(\mathcal{D}_E) = \mathcal{D}_{E_O}$.*

Proof. Throughout the proof, if w is an infinite emitter, then \mathcal{E}_1 will be the element in the partition that contains infinitely many edges. By this choice, if w is an infinite emitter in E , then w^1 is an infinite emitter in E_O and each w^i , $2 \leq i \leq n$ is a finite emitter. Bates and Pask proved in [BP04, Theorem 3.2] that ψ is an $*$ -isomorphism. It is clear that $\gamma_z^{E_O} \circ \psi = \psi \circ \gamma_z^E$. It remains to show that $\psi(\mathcal{D}_E) = \mathcal{D}_{E_O}$.

To show that $\psi(\mathcal{D}_E) \subseteq \mathcal{D}_{E_O}$, we first show that for all $e \in E^1$, $\psi(s_e)$ normalize \mathcal{D}_{E_O} , i.e., $\psi(s_e)\mathcal{D}_{E_O}\psi(s_e)^* \in \mathcal{D}_{E_O}$. Let μ be a path in E_O and let $e \in E^1$. Without loss of generality, we may assume that $\psi(s_e)s_\mu s_\mu^* \psi(s_e)^* \neq 0$ since 0 is an element of \mathcal{D}_{E_O} . Suppose $r_E(e) \neq w$. Then $\psi(s_e)s_\mu s_\mu^* \psi(s_e)^* = s_{e^1} s_\mu s_\mu^* s_{e^1}^*$. Consequently, $r_{E_O}(e^1) = r_E(e)^1 = s_{E_O}(\mu)$. We now have $e^1 \mu$ is a path in E_O and $\psi(s_e)s_\mu s_\mu^* \psi(s_e)^* = s_{e^1} s_\mu s_\mu^* s_{e^1}^* \in \mathcal{D}_{E_O}$. Suppose $r_E(e) = w$. Then $\psi(s_e)s_\mu s_\mu^* \psi(s_e)^* = \sum_{i,j=1}^n s_{e^i} s_\mu s_\mu^* s_{e^j}^*$. Since $\psi(s_e)s_\mu s_\mu^* \psi(s_e)^* \neq 0$ and $r_{E_O}(e^i) = w^i$, $s_{E_O}(\mu) = w^{i_0}$ for some i_0 and $e^{i_0} \mu$ is a path in E_O . Consequently,

$$\psi(s_e)s_\mu s_\mu^* \psi(s_e)^* = \sum_{i,j=1}^n s_{e^i} s_\mu s_\mu^* s_{e^j}^* = s_{e^{i_0}} s_\mu s_\mu^* s_{e^{i_0}}^* = s_{e^{i_0} \mu} s_{e^{i_0} \mu}^* \in \mathcal{D}_{E_O}.$$

Since \mathcal{D}_{E_O} is the closed linear span of elements of the form $s_\mu s_\mu^*$, μ a path in E_O , we have that $\psi(s_e)$ normalize \mathcal{D}_{E_O} for all $e \in E^1$.

Using the fact that $\psi(s_e)$ normalize \mathcal{D}_{E_O} for all $e \in E^1$, we have that $\psi(s_\mu s_\mu^*) \in \mathcal{D}_{E_O}$ provided that $\psi(s_{\mu'} s_{\mu'}^*) \in \mathcal{D}_{E_O}$ where $\mu = e\mu'$. One can then show that $\psi(s_\mu s_\mu^*) \in \mathcal{D}_{E_O}$ for all paths μ in E by induction on the length of the path and by noting that $\psi(s_\mu s_\mu^*) \in \mathcal{D}_{E_O}$ for all paths in E of length zero.

The proof that $\psi^{-1}(\mathcal{D}_{E_O}) \subseteq \mathcal{D}_E$ goes in a similar way. To show that for all $f \in E_O^1$, $\psi^{-1}(s_f)$ normalize \mathcal{D}_E , we will need an explicit description of ψ^{-1} on the generators of $C^*(E_O)$. For $v \in E^0 \setminus \{w\}$ and $e \in E^1 \setminus r_E^{-1}(w)$, then $\psi^{-1}(p_{v^1}) = p_v$ and $\psi^{-1}(s_{e^1}) = s_e$. Suppose w^j is a finite emitter. Since

$$s_{E_O}^{-1}(w^j) = \left(\bigsqcup_{\substack{e \in \mathcal{E}_j \\ r_E(e)=w}} \{e^i : 1 \leq i \leq n\} \right) \sqcup \left(\bigsqcup_{\substack{e \in \mathcal{E}_j \\ r_E(e) \neq w}} \{e^1\} \right),$$

the Cuntz-Krieger relations on $C^*(E_O)$ implies that

$$\psi^{-1}(p_{w^j}) = \psi^{-1} \left(\sum_{\substack{e \in \mathcal{E}_j \\ r_E(e)=w}} \sum_{i=1}^n s_{e^i} s_{e^i}^* + \sum_{\substack{e \in \mathcal{E}_j \\ r_E(e) \neq w}} s_{e^1} s_{e^1}^* \right) = \sum_{e \in \mathcal{E}_j} s_e s_e^*.$$

Suppose w^j is an infinite emitter. Then by the choice of indexing of the partition, $j = 1$ and w^2, \dots, w^n are finite emitters. Therefore,

$$\psi^{-1}(p_{w^1}) = \psi^{-1} \left(\psi(p_w) - \sum_{i=2}^n p_{w^i} \right) = p_w - \sum_{i=2}^n \sum_{e \in \mathcal{E}_i} s_e s_e^* = p_w - \sum_{e \in s_E^{-1}(w) \setminus \mathcal{E}_1} s_e s_e^*.$$

For $e_0 \in E^1$ with $r_E(e_0) = w$,

$$\begin{aligned} \psi^{-1}(s_{e_0^j}) &= \psi^{-1} \left(\sum_{i=1}^n s_{e_0^i} p_{w^i} \right) \\ &= \begin{cases} \sum_{e \in \mathcal{E}_j} s_{e_0} s_e s_e^* & \text{if } w^j \text{ is a finite emitter} \\ s_{e_0} - \sum_{e \in s_E^{-1}(w) \setminus \mathcal{E}_1} s_{e_0} s_e s_e^* & \text{if } w^j \text{ is an infinite emitter.} \end{cases} \end{aligned}$$

We are now ready to show that that for all $f \in E_O^1$, $\psi^{-1}(s_f)$ normalize \mathcal{D}_E . Let $f \in E_O^1$ and μ be a path in E . Without loss of generality, we may assume that $\psi^{-1}(s_f) s_\mu s_\mu^* \psi^{-1}(s_f)^* \neq 0$. Suppose $r_{E_O}(f) \neq w^i$ for any i . Then $f = e^1$ for some $e \in E^1$ such that $r_E(e) \neq w$. Consequently, $\psi^{-1}(s_f) s_\mu s_\mu^* \psi^{-1}(s_f)^* = s_e s_\mu s_\mu^* s_e^*$. Since $\psi^{-1}(s_f) s_\mu s_\mu^* \psi^{-1}(s_f)^* \neq 0$, we must have $r_E(e) = s_E(\mu)$. Therefore, $e\mu$ is a path in E and

$$\psi^{-1}(s_f) s_\mu s_\mu^* \psi^{-1}(s_f)^* = s_e s_\mu s_\mu^* s_e^* = s_{e\mu} s_{e\mu}^* \in \mathcal{D}_E.$$

Suppose $r_{E_O}(f) = w^j$ for some j . Then $f = e_0^j$ for some $e_0 \in E^1$ with $r_E(e_0) = w$. Suppose w^j is a finite emitter. Then

$$\psi^{-1}(s_{e_0^j}) s_\mu s_\mu^* \psi^{-1}(s_{e_0^j})^* = \sum_{e, e' \in \mathcal{E}_j} s_{e_0} s_e s_e^* s_\mu s_\mu^* s_{e'} s_{e'}^* s_{e_0}^*.$$

Since $\psi^{-1}(s_{e_0^j}) s_\mu s_\mu^* \psi^{-1}(s_{e_0^j})^* \neq 0$, $\mu = e_1 \mu'$ for some $e_1 \in \mathcal{E}_j$ or $\mu \in E^0$. Consequently, $e_0 \mu = e_0 e_1 \mu'$ is a path in E (when $|\mu| \geq 1$) and

$$\psi^{-1}(s_{e_0^j}) s_\mu s_\mu^* \psi^{-1}(s_{e_0^j})^* = \sum_{e, e' \in \mathcal{E}_j} s_{e_0} s_e s_e^* s_\mu s_\mu^* s_{e'} s_{e'}^* s_{e_0}^* = \begin{cases} s_{e_0 \mu} s_{e_0 \mu}^* & \text{if } |\mu| \geq 1 \\ \sum_{e \in \mathcal{E}_j \cap r_E^{-1}(s_E(\mu))} s_{e_0 e} s_{e_0 e}^* & \text{if } |\mu| = 0. \end{cases}$$

In both cases, $\psi^{-1}(s_{e_0^j}) s_\mu s_\mu^* \psi^{-1}(s_{e_0^j})^* \in \mathcal{D}_E$. Suppose w^j is an infinite emitter. By the choice of indexing of the partition, $j = 1$. Since $\psi^{-1}(s_{e_0^j}) s_\mu s_\mu^* \psi^{-1}(s_{e_0^j})^* \neq 0$ and

$$\begin{aligned} &\psi^{-1}(s_{e_0^j}) s_\mu s_\mu^* \psi^{-1}(s_{e_0^j})^* \\ &= \left(s_{e_0} - \sum_{e \in s_E^{-1}(w) \setminus \mathcal{E}_1} s_{e_0} s_e s_e^* \right) s_\mu s_\mu^* \left(s_{e_0}^* - \sum_{e \in s_E^{-1}(w) \setminus \mathcal{E}_1} s_e s_e^* s_{e_0}^* \right) \\ &= s_{e_0} s_\mu s_\mu^* s_{e_0}^* - \sum_{e \in s_E^{-1}(w) \setminus \mathcal{E}_1} s_{e_0} s_e s_e^* s_\mu s_\mu^* s_{e_0}^* \\ &\quad - s_{e_0} s_\mu s_\mu^* \sum_{e \in s_E^{-1}(w) \setminus \mathcal{E}_1} s_e s_e^* s_{e_0}^* + \sum_{e, e' \in s_E^{-1}(w) \setminus \mathcal{E}_1} s_{e_0} s_e s_e^* s_\mu s_\mu^* s_{e'} s_{e'}^* s_{e_0}^*, \end{aligned}$$

we have that $s_E(\mu) = w$. Set $\mu = e_1\mu'$ where $e_1 \in s_E^{-1}(w)$ if $|\mu| \geq 1$. A computation shows that

$$\psi^{-1}(s_{e_0^j} s_\mu s_\mu^* \psi^{-1}(s_{e_0^j})^*) = \begin{cases} s_{e_0} s_{e_0}^* - \sum_{e \in s_E^{-1}(w) \setminus \mathcal{E}_1} s_{e_0} s_e s_e^* s_{e_0}^* & \text{if } |\mu| = 0 \\ s_{e_0} s_{e_1} s_{\mu'} s_{\mu'}^* s_{e_1}^* s_{e_0}^* & \text{if } |\mu| \geq 1 \text{ and } e_1 \in \mathcal{E}_1 \\ 0 & \text{if } |\mu| \geq 1 \text{ and } e_1 \notin \mathcal{E}_1. \end{cases}$$

Consequently, $\psi^{-1}(s_{e_0^j} s_\mu s_\mu^* \psi^{-1}(s_{e_0^j})^*) \in \mathcal{D}_E$. Since \mathcal{D}_E is the closed linear span of elements of the form $s_\mu s_\mu^*$, μ a path in E , $\psi^{-1}(s_f)$ normalize \mathcal{D}_E for all $f \in E_O^1$.

Since $\psi^{-1}(s_\mu s_\mu^*) \in \mathcal{D}_E$ for all μ of length zero, we can use the fact that for all $f \in E_O^1$, $\psi^{-1}(s_f)$ normalize \mathcal{D}_E and induction on the length of the paths in E_O to prove that $\psi^{-1}(s_\mu s_\mu^*) \in \mathcal{D}_E$ for all paths in E_O . Consequently, $\psi^{-1}(\mathcal{D}_{E_O}) \subseteq \mathcal{D}_E$ which implies that $\mathcal{D}_{E_O} \subseteq \psi(\mathcal{D}_E)$.

We now can conclude that $\psi(\mathcal{D}_E) = \mathcal{D}_{E_O}$. \square

3.2. Insplitting. We now move on to insplitting. The move (I) introduced in [BP04] can be seen to respect both diagonal and gauge action, but will usually not provide a *-isomorphism. We will replace it with two different moves called (I-) and (I+) so that (I-) is a generalization of (I), and (I+) is a specialization of (I-). We shall see that (I+) respects all structure under study – i.e. $(I+) \subseteq \underline{\mathbf{III}}$ – and that $(I-) \subseteq \overline{\mathbf{0II}}$. The added flexibility in (I-) compared to (I) is to allow some of the sets in the insplitting partition to be empty, and we need this in order to introduce sources in a gauge-invariant way.

Definition 3.3 (Move (I-): Insplitting). *Let $E = (E^0, E^1, r_E, s_E)$ be a graph and let $w \in E^0$ be a regular vertex. Partition $r^{-1}(w)$ as a finite disjoint union of (possibly empty) subsets,*

$$r^{-1}(w) = \mathcal{E}_1 \sqcup \mathcal{E}_2 \sqcup \cdots \sqcup \mathcal{E}_n.$$

Let $E_I = (E_I^0, E_I^1, r_{E_I}, s_{E_I})$ be the graph defined by

$$E_I^0 = \{v^1 : v \in E^0 \setminus \{w\}\} \cup \{w^1, w^2, \dots, w^n\}$$

$$E_I^1 = \{e^1 : e \in E^1, s_E(e) \neq w\} \cup \{e^1, e^2, \dots, e^n : e \in E, s_E(e) = w\}$$

$$s_{E_I}(e^i) = \begin{cases} s_E(e)^1 & \text{if } e \in E^1, s_E(e) \neq w \\ w^i & \text{if } e \in E^1, s_E(e) = w \end{cases}$$

$$r_{E_I}(e^i) = \begin{cases} r_E(e)^1 & \text{if } e \in E^1, r_E(e) \neq w \\ w^j & \text{if } e \in E^1, r_E(e) = w, e \in \mathcal{E}_j \end{cases}$$

We say E_I is formed by performing move (I-) to E .

Theorem 3.4. *Let $E = (E^0, E^1, r_E, s_E)$ be a graph and let $w \in E^0$ be a regular vertex. Partition $r^{-1}(w)$ as a finite disjoint union of (possibly empty) subsets,*

$$r^{-1}(w) = \mathcal{E}_1 \sqcup \mathcal{E}_2 \sqcup \cdots \sqcup \mathcal{E}_n$$

with $\mathcal{E}_1 \neq \emptyset$ if $r^{-1}(w) \neq \emptyset$. Define $\psi: C^*(E) \rightarrow C^*(E_I)$ by $\psi(p_v) = p_{v^1}$ for all $v \in E^0$ and

$$\psi(s_e) = \begin{cases} s_{e^1} & \text{if } r_E(e) \neq w \\ \sum_{f \in s_E^{-1}(w)} s_{e^1} s_{f^i} s_{f^1}^* & \text{if } r_E(e) = w \text{ and } e \in \mathcal{E}_i. \end{cases}$$

Then ψ is an injective $*$ -homomorphism such that $\gamma_z^{E_I} \circ \psi = \psi \circ \gamma_z^E$, $\psi(C^*(E)) = qC^*(E_I)q$, and $\psi(\mathcal{D}_E) = q\mathcal{D}_{E_I}$ where $q = \sum_{v \in E^0} p_{v^1}$.

Proof. Set $P_v = p_{v^1}$ for all $v \in E^1$ and

$$S_e = \begin{cases} s_{e^1} & \text{if } r_E(e) \neq w \\ \sum_{f \in s_E^{-1}(w)} s_{e^1} s_{f^i} s_{f^1}^* & \text{if } r_E(e) = w \text{ and } e \in \mathcal{E}_i \end{cases}$$

for all $e \in E^1$. We will show that $\{P_v, S_e\}$ is a Cuntz-Krieger E -family in $C^*(E_I)$.

Note that

$$\begin{aligned} S_e^* S_f &= \begin{cases} s_{e^1}^* s_{f^1} & \text{if } e, f \notin r_E^{-1}(w) \\ \sum_{g \in s_E^{-1}(w)} s_{g^1} s_{g^i}^* s_{e^1}^* s_{f^1} & \text{if } e \in \mathcal{E}_i \text{ and } f \notin r_E^{-1}(w) \\ \sum_{g \in s_E^{-1}(w)} s_{e^1}^* s_{f^1} s_{g^i} s_{g^1}^* & \text{if } f \in \mathcal{E}_i \text{ and } e \notin r_E^{-1}(w) \\ \sum_{g, h \in s_E^{-1}(w)} s_{g^1} s_{g^i}^* s_{e^1}^* s_{f^1} s_{h^j} s_{h^1}^* & \text{if } e \in \mathcal{E}_i \text{ and } f \in \mathcal{E}_j \end{cases} \\ &= \begin{cases} \delta_{e,f} P_{r_E(e)} & \text{if } e, f \notin r_E^{-1}(w) \\ \delta_{e,f} \sum_{g \in s_E^{-1}(w)} s_{g^1} s_{g^1}^* & \text{if } e, f \in \mathcal{E}_i \\ 0 & \text{otherwise} \end{cases} \\ &= \delta_{e,f} P_{r_E(e)} \end{aligned}$$

for all $e, f \in E^1$, and further

$$\begin{aligned} S_e S_e^* &= \begin{cases} s_{e^1} s_{e^1}^* & \text{if } r_E(e) \neq w \\ \sum_{f, g \in s_E^{-1}(w)} s_{e^1} s_{f^i} s_{f^1}^* s_{g^1} s_{g^i}^* s_{e^1} & \text{if } r_E(e) = w \text{ and } e \in \mathcal{E}_i \end{cases} \\ &= \begin{cases} s_{e^1} s_{e^1}^* & \text{if } r_E(e) \neq w \\ \sum_{f \in s_E^{-1}(w)} s_{e^1} s_{f^i} s_{f^1}^* s_{e^1} & \text{if } r_E(e) = w \text{ and } e \in \mathcal{E}_i \end{cases} \\ &= \begin{cases} s_{e^1} s_{e^1}^* & \text{if } r_E(e) \neq w \\ s_{e^1} p_{w^i} s_{e^1}^* & \text{if } r_E(e) = w \text{ and } e \in \mathcal{E}_i \end{cases} \\ &= s_{e^1} s_{e^1}^* \leq p_{s_{E_I}(e^1)} = P_{s_{E_I}(e)} \end{aligned}$$

for all $e \in E^1$. Let v be a regular vertex in E . Then v^1 is a regular vertex in E_I and $s_{E_I}^{-1}(v^1) = \{e^1 : e \in s_E^{-1}(v)\}$. Therefore,

$$P_v = p_{v^1} = \sum_{e \in s_E^{-1}(v)} s_{e^1} s_{e^1}^* = \sum_{e \in s_{E_I}^{-1}(v)} S_e S_e^*.$$

This proves that $\{P_v, S_e\}$ is a Cuntz-Krieger E -family in $C^*(E_I)$. By the universal property of $C^*(E)$, there exists a $*$ -homomorphism $\psi: C^*(E) \rightarrow C^*(E_I)$ such that $\psi(p_v) = P_v$ and $\psi(s_e) = S_e$. One easily checks that $\gamma_z^{E_I} \circ \psi = \psi \circ \gamma_z^E$ on $\{p_v, s_e\}$, hence $\gamma_z^{E_I} \circ \psi = \psi \circ \gamma_z^E$. Since $\psi(p_v) = p_{v^1} \neq 0$ for all $v \in E^0$, by the gauge-invariant uniqueness theorem, ψ is injective.

We now want to prove that $\psi(C^*(E)) = qC^*(E_I)q$ and $\psi(\mathcal{D}_E) = q\mathcal{D}_{E_I}$. To do this, we need to prove three claims.

CLAIM 1: For all finite path $\nu = e_1 e_2 \cdots e_m$ in E with $|\nu| \geq 1$, there exists a finite path μ in E_I such that $s_{E_I}(\mu) \in \{v^1 : v \in E^0\}$,

$$r_{E_I}(\mu) = \begin{cases} r_E(e_m)^1 & \text{if } e_m \notin r_E^{-1}(w) \\ w^k & \text{if } e_m \in \mathcal{E}_k, \end{cases}$$

and

$$\psi(s_\nu) = \begin{cases} s_\mu & \text{if } e_m \notin r_E^{-1}(w) \\ s_\mu \sum_{f \in s_E^{-1}(w)} s_{f^k} s_{f^1}^* & \text{if } e_m \in \mathcal{E}_k. \end{cases}$$

We will prove this by induction on the length of the paths. Suppose $\nu = e \in E^1$. Then

$$\psi(s_e) = \begin{cases} s_{e^1} & \text{if } e \notin r_E^{-1}(w) \\ s_{e^1} \sum_{f \in s_E^{-1}(w)} s_{f^k} s_{f^1}^* & \text{if } e \in \mathcal{E}_k. \end{cases}$$

Set $\mu = e^1$. Then $s_{E_I}(\mu) = s_E(e)^1$,

$$r_{E_I}(e^1) = \begin{cases} r_E(e)^1 & \text{if } r_E(e) \neq w \\ w^k & \text{if } e \in \mathcal{E}_k \end{cases},$$

and

$$\psi(s_e) = \begin{cases} s_\mu & \text{if } e \notin r_E^{-1}(w) \\ s_\mu \sum_{f \in s_E^{-1}(w)} s_{f^k} s_{f^1}^* & \text{if } e \in \mathcal{E}_k. \end{cases}$$

Suppose the claim is true for any path in E with length m . Let $\nu = e_1 \cdots e_m e_{m+1}$ be a path in E of length $m+1$. Suppose $r_E(e_m) \neq w$ and $r_E(e_{m+1}) \neq w$. Then $r_E(e_1 \cdots e_m) = s_E(e_{m+1}) = v \neq w$. By the induction hypothesis, there exists a finite path μ' in E_I such that $s_{E_I}(\mu') \in \{v^1 : v \in E^0\}$, $r_{E_I}(\mu') = v^1$, and $\psi(s_{e_1 \cdots e_m}) = s_{\mu'}$. Therefore, $r_{E_I}(\mu') = v^1 = s_{E_I}(e_{m+1}^1)$ which implies that $\mu = \mu' e_{m+1}^1$ is a finite path in E_I with $s_{E_I}(\mu) \in \{v^1 : v \in E^0\}$, $r_{E_I}(\mu) = r_{E_I}(e_{m+1}^1) = r_E(e_{m+1})^1$, and

$$\psi(s_\nu) = s_{\mu'} s_{e_{m+1}^1} = s_\mu.$$

Suppose $r_E(e_m) \neq w$ and $e_{m+1} \in \mathcal{E}_k$. By the induction hypothesis, there exists a finite path μ' in E_I such that $s_{E_I}(\mu') \in \{v^1 : v \in E^0\}$, $r_{E_I}(\mu') = r_E(e_m)^1$, and $\psi(s_{e_1 \cdots e_m}) = s_{\mu'}$. Note that $r_{E_I}(\mu') = r_E(e_m)^1 = s_E(e_{m+1})^1 = s_{E_I}(e_{m+1}^1)$. Thus, $\mu = \mu' e_{m+1}^1$ is a path in E_I such that $s_{E_I}(\mu) = s_{E_I}(\mu') \in \{v^1 : v \in E^0\}$, $r_{E_I}(\mu) = r_{E_I}(e_{m+1}^1) = w^k$, and

$$\psi(s_\nu) = s_{\mu'} \sum_{f \in s_E^{-1}(w)} s_{e_{m+1}^1} s_{f^k} s_{f^1}^* = s_\mu \sum_{f \in s_E^{-1}(w)} s_{f^k} s_{f^1}^*.$$

Suppose $e_m \in \mathcal{E}_k$ and $e_{m+1} \notin r_E^{-1}(w)$. By the induction hypothesis, there exists a finite path μ' in E_I such that $s_{E_I}(\mu') \in \{v^1 : v \in E^0\}$, $r_{E_I}(\mu') = w^k$, and $\psi(s_{e_1 \cdots e_m}) = s_{\mu'} \sum_{f \in s_E^{-1}(w)} s_{f^k} s_{f^1}^*$. Note that $r_{E_I}(\mu') = w^k = s_E(e_{m+1})^k = s_{E_I}(e_{m+1}^k)$. Thus, $\mu = \mu' e_{m+1}^k$ is a path in E_I such that $s_{E_I}(\mu) = s_{E_I}(\mu') \in \{v^1 : v \in E^0\}$, $r_{E_I}(\mu) = r_{E_I}(e_{m+1}^k) = r_E(e_{m+1})^1$, and

$$\psi(s_\nu) = s_{\mu'} \sum_{f \in s_E^{-1}(w)} s_{f^k} s_{f^1}^* s_{e_{m+1}^k} = s_{\mu'} s_{e_{m+1}^k} = s_\mu.$$

Suppose $e_m \in \mathcal{E}_l$ and $e_{m+1} \in \mathcal{E}_k$. By the induction hypothesis, there exists a finite path μ' in E_I such that $s_{E_I}(\mu') \in \{v^1 : v \in E^0\}$, $r_{E_I}(\mu') = w^l$, and $\psi(s_{e_1 \cdots e_m}) = s_{\mu'} \sum_{f \in s_E^{-1}(w)} s_{f^l} s_{f^1}^*$. Note that $r_{E_I}(\mu') = w^l = s_E(e_{m+1})^l = s_{E_I}(e_{m+1}^l)$. Thus, $\mu = \mu' e_{m+1}^l$

is a path in E_I such that $s_{E_I}(\mu) = s_{E_I}(\mu') \in \{v^1 : v \in E^0\}$, $r_{E_I}(\mu) = r_{E_I}(e_{m+1}^l) = r_E(e_{m+1})^k$, and

$$\begin{aligned} \psi(s_\nu) &= \left(s_{\mu'} \sum_{g \in s_E^{-1}(w)} s_{g^l} s_{g^1}^* \right) \left(\sum_{f \in s_E^{-1}(w)} s_{e_{m+1}^1} s_{f^k} s_{f^1}^* \right) \\ &= s_{\mu'} s_{e_{m+1}^l} \left(\sum_{f \in s_E^{-1}(w)} s_{f^k} s_{f^1}^* \right) = s_\mu \sum_{f \in s_E^{-1}(w)} s_{f^k} s_{f^1}^*. \end{aligned}$$

The above paragraphs prove CLAIM 1.

CLAIM 2: For all finite paths μ in E_I , then ν_μ is a finite path in E with $|\nu_\mu| = |\mu|$, where ν_μ is obtained by removing the superscripts of μ . Suppose $\mu = v^i$ for some $v \in E^0$. Then $\nu_\mu = v$ is clearly a path of length zero in E . Suppose $\mu = e_1^{i_1} e_2^{i_2} \cdots e_m^{i_m}$ in E_I . To show that $\nu_\mu = e_1 e_2 \cdots e_m$ is a path in E , we must show that $r_E(e_l) = s_E(e_{l+1})$ for all $l \in \{1, 2, \dots, m-1\}$. Suppose $s_E(e_{l+1}) \neq w$. Then $i_{l+1} = 1$ and $s_{E_I}(e_{l+1}^{i_{l+1}}) = s_E(e_{l+1})^1$. Since

$$r_{E_I}(e_l^{i_l}) = s_{E_I}(e_{l+1}^{i_{l+1}}) = s_E(e_{l+1})^1,$$

we conclude that $r_E(e_l) \neq w$ and

$$r_E(e_l)^1 = r_{E_I}(e_l^{i_l}) = s_{E_I}(e_{l+1}^{i_{l+1}}) = s_E(e_{l+1})^1.$$

Consequently, $r_E(e_l) = s_E(e_{l+1})$. Suppose $s_E(e_{l+1}) = w$. Then $s_{E_I}(e_{l+1}^{i_{l+1}}) = w^{i_{l+1}}$. Since

$$r_{E_I}(e_l^{i_l}) = s_{E_I}(e_{l+1}^{i_{l+1}}) = w^{i_{l+1}},$$

we have $e_i \in \mathcal{E}_{i_{l+1}}$ which implies that $r_E(e_l) = w$. Thus, ν_μ is a path in E . This proves CLAIM 2.

CLAIM 3:

$$\psi(s_{\nu_\mu}) = \begin{cases} s_\mu & \text{if } r_{E_I}(\mu) = v^1 \text{ with } v \neq w \\ s_\mu \sum_{f \in s_E^{-1}(w)} s_{f^k} s_{f^1}^* & \text{if } r_{E_I}(\mu) = w^k \end{cases}$$

where ν_μ is the corresponding path in E in CLAIM 2. (The ideas of the proof of CLAIM 3 come from the proof of [ALPS11, Proposition 1.11]). We prove the claim by induction on $|\mu|$. Suppose μ is a path of length zero. Hence, $\mu = v^1$ for some $v \in E^0$. Thus, $\nu_\mu = v$ and

$$\begin{aligned} \psi(p_{\nu_\mu}) &= p_{v^1} = \begin{cases} p_{v^1} & \text{if } v \neq w \\ p_{w^1} & \text{if } v = w \end{cases} \\ &= \begin{cases} p_{v^1} & \text{if } v \neq w \\ p_{w^1} \sum_{f \in s_E^{-1}(w)} s_{f^1} s_{f^1}^* & \text{if } v = w \end{cases} \\ &= \begin{cases} s_\mu & \text{if } r_{E_I}(\mu) = v^1, v \neq w, \\ s_\mu \sum_{f \in s_E^{-1}(w)} s_{f^1} s_{f^1}^* & \text{if } r_{E_I}(\mu) = w^1. \end{cases} \end{aligned}$$

Suppose the claim is true for all paths in E_I with length k . Let μ be a path in E_I of length $k+1$. Let $\mu = \mu' e^i$ where μ' is a path of length k . Let ν_μ be the corresponding path in E for μ and let $\nu_{\mu'}$ be the corresponding path in E for μ' . By construction of ν_μ and $\nu_{\mu'}$, $\nu_\mu = \nu_{\mu'} e$.

CASE 1: Suppose $r_{E_I}(\mu) = v^1$ with $v \neq w$ and $r_{E_I}(\mu') \neq w^j$. Then $r_E(\nu_{\mu'}) \neq w$ and $\psi(s_{\nu_{\mu'}}) = s_{\mu'}$. Since $s_E(e) = r_E(\nu_{\mu'}) \neq w$, $e^i = e^1$ and

$$\psi(s_{\nu_{\mu}}) = \psi(s_{\nu_{\mu'}})\psi(s_e) = s_{\mu'}s_{e^1} = s_{\mu'}s_{e^i} = s_{\mu}.$$

CASE 2: Suppose $r_{E_I}(\mu) = v^1$ with $v \neq w$ and $r_{E_I}(\mu') = w^k$. Then

$$\psi(s_{\nu_{\mu'}}) = s_{\mu'} \sum_{f \in s_E^{-1}(w)} s_{f^k} s_{f^1}^*$$

and $s_E(e)^i = s_{E_I}(e^i) = r_{E_I}(\mu') = w^k$. Hence, $s_E(e) = w$ and $i = k$. Consequently,

$$\psi(s_{\nu_{\mu}}) = \psi(s_{\nu_{\mu'}})\psi(s_e) = s_{\mu'} \sum_{f \in s_E^{-1}(w)} s_{f^i} s_{f^1}^* s_{e^1} = s_{\mu'} s_{e^i} = s_{\mu}.$$

CASE 3: Suppose $r_{E_I}(\mu) = w^l$ and $r_{E_I}(\mu') = v^1$ for some $v \neq w$. Then $r_E(\nu_{\mu'}) \neq w$, $\psi(s_{\nu_{\mu'}}) = s_{\mu'}$, and $r_{E_I}(e^i) = r_{E_I}(\mu) = w^l$. The last statement implies that $e \in \mathcal{E}_l$. Since $s_E(e) = r_E(\nu_{\mu'}) \neq w$, we have $e^i = e^1$ and

$$\psi(s_{\nu_{\mu}}) = \psi(s_{\nu_{\mu'}})\psi(s_e) = s_{\mu'} \sum_{f \in s_E^{-1}(w)} s_{e^1} s_{f^l} s_{f^1}^* = s_{\mu} \sum_{f \in s_E^{-1}(w)} s_{f^l} s_{f^1}^*.$$

CASE 4: Suppose $r_{E_I}(\mu) = w^l$ and $r_{E_I}(\mu') = w^k$. Then

$$\psi(s_{\nu_{\mu'}}) = s_{\mu'} \sum_{g \in s_E^{-1}(w)} s_{g^k} s_{g^1}^* \quad \text{and} \quad \psi(s_e) = \sum_{f \in s_E^{-1}(w)} s_{e^1} s_{f^l} s_{f^1}^*$$

since $r_{E_I}(\mu) = r_{E_I}(e^i) = w^l$. Hence,

$$\psi(s_{\nu_{\mu}}) = \psi(s_{\nu_{\mu'}})\psi(s_e) = s_{\mu'} \left(\sum_{g \in s_E^{-1}(w)} s_{g^k} s_{g^1}^* \right) \left(\sum_{f \in s^{-1}(w)} s_{e^1} s_{f^l} s_{f^1}^* \right).$$

Since $w^k = r_{E_I}(\mu') = s_{E_I}(e^i) = s_E(e)^i$, we have that $s_E(e) = w$, $i = k$, and

$$\begin{aligned} \psi(s_{\nu_{\mu}}) &= s_{\mu'} \left(\sum_{g \in s_E^{-1}(w)} s_{g^k} s_{g^1}^* \right) \left(\sum_{f \in s^{-1}(w)} s_{e^1} s_{f^l} s_{f^1}^* \right) \\ &= s_{\mu'} s_{e^k} \sum_{f \in s^{-1}(w)} s_{f^l} s_{f^1}^* \\ &= s_{\mu'} s_{e^i} \sum_{f \in s^{-1}(w)} s_{f^l} s_{f^1}^* \\ &= s_{\mu} \sum_{f \in s^{-1}(w)} s_{f^l} s_{f^1}^*. \end{aligned}$$

This proves CLAIM 3.

We now prove that $qC^*(E_I)q = \psi(C^*(E))$ and $q\mathcal{D}_{E_I} = \psi(\mathcal{D}_E)$. It is clear that $\psi(C^*(E)) \subseteq qC^*(E_I)q$. We will use CLAIM 1 to show that $\psi(\mathcal{D}_E) \subseteq q\mathcal{D}_{E_I}$. Let ν be a finite path in E . Suppose $\nu \in E^0$. Then $\psi(p_\nu) = p_{\nu^1} \in q\mathcal{D}_{E_I}$. Suppose $\nu = e_1 \cdots e_m$

is a path in E with positive length. From CLAIM 1, there exists a finite path μ in E_I of positive length such that $s_{E_I}(\mu) \in \{v^1 : v \in E^0\}$,

$$r_{E_I}(\mu) = \begin{cases} r_E(e_m)^1 & \text{if } e_m \notin r_E^{-1}(w) \\ w^k & \text{if } e_m \in \mathcal{E}_k \end{cases}$$

and

$$\psi(s_\nu) = \begin{cases} s_\mu & \text{if } e_m \notin r_E^{-1}(w) \\ s_\mu \sum_{f \in s_E^{-1}(w)} s_{fk} s_{f1}^* & \text{if } e_m \in \mathcal{E}_k. \end{cases}$$

Therefore,

$$\begin{aligned} \psi(s_\nu s_\nu^*) &= \begin{cases} s_\mu s_\mu^* & \text{if } e_m \notin r_E^{-1}(w) \\ \sum_{f \in s_E^{-1}(w)} s_\mu s_{fk} s_{f1}^* s_\mu^* & \text{if } e_m \in \mathcal{E}_k \end{cases} \\ &= \begin{cases} s_\mu s_\mu^* & \text{if } e_m \notin r_E^{-1}(w) \\ \sum_{f \in s_E^{-1}(w)} s_{\mu fk} s_{\mu fk}^* & \text{if } e_m \in \mathcal{E}_k \end{cases} \\ &= \begin{cases} q s_\mu s_\mu^* & \text{if } e_m \notin r_E^{-1}(w) \\ q \sum_{f \in s_E^{-1}(w)} s_{\mu fk} s_{\mu fk}^* & \text{if } e_m \in \mathcal{E}_k. \end{cases} \end{aligned}$$

since $s_{E_I}(\mu) \in \{v^1 : v \in E^0\}$. Hence, $\psi(\mathcal{D}_E) \subseteq q\mathcal{D}_{E_I}$.

We now use CLAIM 3 to show that $qC^*(E_I)q \subseteq \psi(C^*(E))$ and $q\mathcal{D}_{E_I} \subseteq \psi(\mathcal{D}_E)$. Let μ_1, μ_2 be paths in E_I such that $r_{E_I}(\mu_1) = r_{E_I}(\mu_2)$ and $s_{E_I}(\mu_1), s_{E_I}(\mu_2) \in \{v^1 : v \in E^0\}$. Let $\nu_1 = \nu_{\mu_1}, \nu_2 = \nu_{\mu_2}$ be the corresponding paths in E given in CLAIM 2. Note that $r_E(\nu_1) = r_E(\nu_2)$. By CLAIM 3

$$\begin{aligned} \psi(s_{\nu_1} s_{\nu_2}^*) &= \begin{cases} s_{\mu_1} s_{\mu_2}^* & \text{if } r_{E_I}(\mu_1) = r_{E_I}(\mu_2) = v^1 \text{ with } v \neq w \\ \sum_{f, g \in s_E^{-1}(w)} s_{\mu_1} s_{fk} s_{f1}^* s_{g1} s_{gk}^* s_{\mu_2}^* & \text{if } r_{E_I}(\mu_1) = r_{E_I}(\mu_2) = w^k \end{cases} \\ &= \begin{cases} s_{\mu_1} s_{\mu_2}^* & \text{if } r_{E_I}(\mu_1) = r_{E_I}(\mu_2) = v^1 \text{ with } v \neq w \\ \sum_{f \in s_E^{-1}(w)} s_{\mu_1} s_{fk} s_{fk}^* s_{\mu_2}^* & \text{if } r_{E_I}(\mu_1) = r_{E_I}(\mu_2) = w^k \end{cases} \\ &= s_{\mu_1} s_{\mu_2}^* \end{aligned}$$

since $r_{E_I}(\mu_1) = w^k$ and $p_{w^k} = \sum_{f \in s_E^{-1}(w)} s_{fk} s_{fk}^*$. Therefore, $qC^*(E)q \subseteq \psi(C^*(E))$ and $q\mathcal{D}_{E_I} \subseteq \psi(\mathcal{D}_E)$ which allows us to conclude that $qC^*(E)q = \psi(C^*(E))$ and $q\mathcal{D}_{E_I} = \psi(\mathcal{D}_E)$. \square

Theorem 3.5 ((I-) \subseteq 011). *Let $E = (E^0, E^1, r_E, s_E)$ be a graph and let $w \in E^0$ be a regular vertex. Partition $r^{-1}(w)$ as a finite disjoint union of (possibly empty) subsets,*

$$r^{-1}(w) = \mathcal{E}_1 \sqcup \mathcal{E}_2 \sqcup \cdots \sqcup \mathcal{E}_n$$

with $\mathcal{E}_1 \neq \emptyset$ if $r^{-1}(w) \neq \emptyset$. Let $\{e_{i,j}\}$ be a system of matrix units in $M_n(\mathbb{C})$. Set $p = \sum_{v \in E^0 \setminus \{w\}} p_v \otimes e_{1,1} + p_w \otimes 1_{M_n(\mathbb{C})}$. Then there exists a $*$ -isomorphism $\Phi: C^*(E_I) \rightarrow p(C^*(E) \otimes M_n(\mathbb{C}))p$ such that $\Phi(\mathcal{D}_{E_I}) = p(\mathcal{D}_E \otimes c_0(\{1, \dots, n\}))$, and $(\gamma_z \otimes \text{id}_{M_n}) \circ \Phi = \Phi \circ \gamma_z^{E_I}$ for all $z \in \mathbb{T}$.

Consequently, there exists a $*$ -isomorphism $\Theta: C^*(E_I) \otimes \mathbb{K} \rightarrow C^*(E) \otimes \mathbb{K}$ such that $\Theta(\mathcal{D}_{E_I} \otimes c_0) = \mathcal{D}_E \otimes c_0$ and $(\gamma_z^E \otimes \text{id}_{\mathbb{K}}) \circ \Theta = \Theta \circ (\gamma_z^{E_I} \otimes \text{id}_{\mathbb{K}})$.

Proof. Let $\psi: C^*(E) \rightarrow C^*(E_I)$ be the injective $*$ -homomorphism and q the projection given in Theorem 3.4. Set $\Psi = \psi \otimes \text{id}_{M_n(\mathbb{C})}$ and set

$$V = \sum_{v \in E^0 \setminus \{w\}} p_{v^1} \otimes e_{1,1} + \sum_{i=1}^n \sum_{f \in s_E^{-1}(w)} s_{f^1} s_{f^i}^* \otimes e_{i,1}.$$

Note that

$$\begin{aligned} V^*V &= \sum_{v \in E^0 \setminus \{w\}} p_{v^1} \otimes e_{1,1} + \left(\sum_{i,j=1}^n \sum_{f,g \in s_E^{-1}(w)} (s_{f^i} s_{f^1}^* \otimes e_{1,i})(s_{g^j} s_{g^1}^* \otimes e_{j,1}) \right) \\ &= \sum_{v \in E^0 \setminus \{w\}} p_{v^1} \otimes e_{1,1} + \sum_{i=1}^n \sum_{f \in s_E^{-1}(w)} s_{f^i} s_{f^1}^* \otimes e_{1,1} \\ &= \sum_{v \in E^0 \setminus \{w\}} p_{v^1} \otimes e_{1,1} + \sum_{i=1}^n p_{w^i} \otimes e_{1,1} \\ &= 1_{C^*(E_I)} \otimes e_{1,1} \end{aligned}$$

and

$$\begin{aligned} VV^* &= \sum_{v \in E^0 \setminus \{w\}} p_{v^1} \otimes e_{1,1} + \left(\sum_{i,j=1}^n \sum_{f,g \in s_E^{-1}(w)} (s_{f^1} s_{f^i}^* \otimes e_{i,1})(s_{g^j} s_{g^1}^* \otimes e_{1,j}) \right) \\ &= \sum_{v \in E^0 \setminus \{w\}} p_{v^1} \otimes e_{1,1} + \sum_{i=1}^n \sum_{f \in s_E^{-1}(w)} s_{f^1} s_{f^i}^* \otimes e_{i,i} \\ &= \sum_{v \in E^0 \setminus \{w\}} p_{v^1} \otimes e_{1,1} + \sum_{i=1}^n p_{w^1} \otimes e_{i,i} \\ &= \sum_{v \in E^0 \setminus \{w\}} p_{v^1} \otimes e_{1,1} + p_{w^1} \otimes 1_{M_n(\mathbb{C})}. \end{aligned}$$

Therefore, V is a partial isometry in $C^*(E_I) \otimes M_n(\mathbb{C})$ such that $V^*V = 1_{C^*(E_I)} \otimes e_{1,1}$, $VV^* = \sum_{v \in E^0 \setminus \{w\}} p_{v^1} \otimes e_{1,1} + p_{w^1} \otimes 1_{M_n(\mathbb{C})}$ and $(\gamma_z^{E_I} \otimes \text{id}_{M_n(\mathbb{C})})(V) = V$ for all $t \in \mathbb{T}$. Define $\beta: C^*(E_I) \otimes e_{1,1} \rightarrow Q(C^*(E_I) \otimes M_n(\mathbb{C}))Q$ by $\beta(x) = VxV^*$, where

$$Q = \sum_{v \in E^0 \setminus \{w\}} p_{v^1} \otimes e_{1,1} + p_{w^1} \otimes 1_{M_n(\mathbb{C})}.$$

Then β is a $*$ -isomorphism such that

$$\begin{aligned} ((\gamma_z^{E_I} \otimes \text{id}_{M_n(\mathbb{C})}) \circ \beta)(x) &= (\gamma_z^{E_I} \otimes \text{id}_{M_n(\mathbb{C})})(VxV^*) \\ &= V(\gamma_z^{E_I} \otimes \text{id}_{M_n(\mathbb{C})})(x)V^* \\ &= (\beta \circ (\gamma_z^{E_I} \otimes \text{id}_{M_n(\mathbb{C})}))(x) \end{aligned}$$

for all $x \in C^*(E_I) \otimes e_{1,1}$. Since $(\psi \otimes \text{id}_{\mathbb{M}_n(\mathbb{C})})(p) = Q$ and $Q = q \otimes e_{1,1} + \sum_{i=2}^n p_{w^1} \otimes e_{i,i} \leq q \otimes 1_{\mathbb{M}_n(\mathbb{C})}$,

$$\begin{aligned} (\psi \otimes \text{id}_{\mathbb{M}_n(\mathbb{C})})(p(C^*(E) \otimes \mathbb{M}_n(\mathbb{C}))p) &= Q(\psi \otimes \text{id}_{\mathbb{M}_n(\mathbb{C})})(C^*(E) \otimes \mathbb{M}_n(\mathbb{C}))Q \\ &= Q(qC^*(E_I)q \otimes \mathbb{M}_n(\mathbb{C}))Q \\ &= Q(q \otimes 1_{\mathbb{M}_n(\mathbb{C})})(C^*(E_I) \otimes \mathbb{M}_n(\mathbb{C}))(q \otimes 1_{\mathbb{M}_n(\mathbb{C})})Q \\ &= Q(C^*(E_I) \otimes \mathbb{M}_n(\mathbb{C}))Q \end{aligned}$$

and

$$\begin{aligned} (\psi \otimes \text{id}_{\mathbb{M}_n(\mathbb{C})})(p(\mathcal{D}_E \otimes c_0(\{1, 2, \dots, n\}))) &= Q(\psi \otimes \text{id}_{\mathbb{M}_n(\mathbb{C})})(\mathcal{D}_E \otimes c_0(\{1, 2, \dots, n\})) \\ &= Q(q\mathcal{D}_{E_I} \otimes c_0(\{1, 2, \dots, n\})) \\ &= Q(q \otimes 1_{\mathbb{M}_n(\mathbb{C})})(\mathcal{D}_{E_I} \otimes c_0(\{1, 2, \dots, n\})) \\ &= Q(\mathcal{D}_{E_I} \otimes c_0(\{1, 2, \dots, n\})). \end{aligned}$$

Define $\Psi: C^*(E_I) \rightarrow p(C^*(E) \otimes \mathbb{M}_n(\mathbb{C}))p$ by $\Psi(a) = ((\psi \otimes \text{id}_{\mathbb{M}_n(\mathbb{C})})^{-1} \circ \beta)(a \otimes e_{1,1})$. Then Ψ is a *-isomorphism and

$$\begin{aligned} (\gamma_z^E \otimes \text{id}_{\mathbb{M}_n(\mathbb{C})}) \circ \Psi(a) &= ((\gamma_z^E \otimes \text{id}_{\mathbb{M}_n(\mathbb{C})}) \circ (\psi \otimes \text{id}_{\mathbb{M}_n(\mathbb{C})})^{-1} \circ \beta)(a \otimes e_{1,1}) \\ &= ((\psi \otimes \text{id}_{\mathbb{M}_n(\mathbb{C})})^{-1} \circ (\gamma_z^{E_I} \otimes \text{id}_{\mathbb{M}_n(\mathbb{C})}) \circ \beta)(a \otimes e_{1,1}) \\ &= ((\psi \otimes \text{id}_{\mathbb{M}_n(\mathbb{C})})^{-1} \circ \beta \circ (\gamma_z^{E_I} \otimes \text{id}_{\mathbb{M}_n(\mathbb{C})}))(a \otimes e_{1,1}) \\ &= ((\psi \otimes \text{id}_{\mathbb{M}_n(\mathbb{C})})^{-1} \circ \beta)(\gamma_z^{E_I}(a) \otimes e_{1,1}) \\ &= \Psi \circ \gamma_z^{E_I}(a) \end{aligned}$$

for all $a \in C^*(E_I)$.

We are left to show that $\Psi(\mathcal{D}_{E_I}) = p(\mathcal{D}_E \otimes c_0(\{1, 2, \dots, n\}))$, and this will follow from the claim

$$(3.1) \quad \beta(\mathcal{D}_{E_I} \otimes e_{1,1}) = V(\mathcal{D}_{E_I} \otimes e_{1,1})V^* = Q(\mathcal{D}_{E_I} \otimes c_0(\{1, 2, \dots, n\})).$$

Let μ be a finite path in E_I . Note that

$$\begin{aligned} Vs_\mu s_\mu^* \otimes e_{1,1} &= \left(\sum_{v \in E^0 \setminus \{w\}} p_{v^1} \otimes e_{1,1} + \sum_{i=1}^n \sum_{f \in s_E^{-1}(w)} s_{f^1} s_{f^i}^* \otimes e_{i,1} \right) (s_\mu s_\mu^* \otimes e_{1,1}) \\ &= \begin{cases} s_\mu s_\mu^* \otimes e_{1,1} & \text{if } s_{E_I}(\mu) = v^1 \text{ with } v \neq w \\ \sum_{f \in s_E^{-1}(w)} s_{f^1} s_{f^k}^* s_\mu s_\mu^* \otimes e_{k,1} & \text{if } s_{E_I}(\mu) = w^k, \end{cases} \end{aligned}$$

which implies

$$\begin{aligned}
& V(s_\mu s_\mu^* \otimes e_{1,1})V^* \\
&= \begin{cases} s_\mu s_\mu^* \otimes e_{1,1} & \text{if } s_{E_I}(\mu) = v^1 \text{ with } v \neq w \\ \sum_{f,g \in s_E^{-1}(w)} s_{f^1} s_{f^k}^* s_\mu s_\mu^* s_{g^k} s_{g^1}^* \otimes e_{k,k} & \text{if } s_{E_I}(\mu) = w^k \end{cases} \\
&= \begin{cases} s_\mu s_\mu^* \otimes e_{1,1} & \text{if } s_{E_I}(\mu) = v^1 \text{ with } v \neq w \\ \sum_{f \in s_E^{-1}(w)} s_{f^1} s_{f^k}^* s_\mu s_\mu^* s_{f^k} s_{f^1}^* \otimes e_{k,k} & \text{if } s_{E_I}(\mu) = w^k. \end{cases}
\end{aligned}$$

Suppose $s_{E_I}(\mu) = v^1$ with $v \neq w$. Then $s_\mu s_\mu^* \otimes e_{1,1} \in (p_{v^1} \otimes e_{1,1})(\mathcal{D}_{E_I} \otimes c_0(\{1, 2, \dots, n\})) \subseteq Q(\mathcal{D}_{E_I} \otimes c_0(\{1, 2, \dots, n\}))$. Suppose $s_{E_I}(\mu) = w^k$. Then

$$\sum_{f \in s_E^{-1}(w)} s_{f^1} s_{f^k}^* s_\mu s_\mu^* s_{f^k} s_{f^1}^* \otimes e_{k,k} = s_{f^1} s_{\mu'} s_{\mu'}^* s_{f^1}^* \otimes e_{k,k} \in (p_{w^1} \otimes e_{k,k})(\mathcal{D}_{E_I} \otimes c_0(\{1, 2, \dots, n\})).$$

Since $(p_{w^1} \otimes e_{k,k})(\mathcal{D}_{E_I} \otimes c_0(\{1, 2, \dots, n\})) \subseteq Q(\mathcal{D}_{E_I} \otimes c_0(\{1, 2, \dots, n\}))$, $V s_\mu s_\mu^* V^* \in Q(\mathcal{D}_{E_I} \otimes c_0(\{1, 2, \dots, n\}))$. Also note that $V(p_{v^1} \otimes e_{1,1})V^* = p_{v^1} \otimes e_{1,1} \in Q(\mathcal{D}_{E_I} \otimes c_0(\{1, 2, \dots, n\}))$ for all $v \in E^0 \setminus \{w\}$ and

$$\begin{aligned}
V(p_{w^k} \otimes e_{1,1})V^* &= \left(\sum_{i=1}^n \sum_{f \in s_E^{-1}(w)} s_{f^1} s_{f^i}^* \otimes e_{i,1} \right) (p_{w^k} \otimes e_{1,1}) \left(\sum_{i=1}^n \sum_{f \in s_E^{-1}(w)} s_{f^1} s_{f^i}^* \otimes e_{i,1} \right)^* \\
&= \sum_{f \in s_E^{-1}(w)} (s_{f^1} s_{f^k}^* \otimes e_{k,1})(p_{w^k} \otimes e_{1,1})(s_{f^k} s_{f^1}^* \otimes e_{1,k}) \\
&= \sum_{f \in s_E^{-1}(w)} s_{f^1} s_{f^1}^* \otimes e_{k,k} \\
&= (p_{w^1} \otimes 1_{M_n(\mathbb{C})}) \sum_{f \in s_E^{-1}(w)} s_{f^1} s_{f^1}^* \otimes e_{k,k} \in Q(\mathcal{D}_{E_I} \otimes c_0(\{1, 2, \dots, n\})).
\end{aligned}$$

Since \mathcal{D}_{E_I} is equal to the closed linear span of $\{s_\mu s_\mu^* : \text{for all finite paths } \mu \text{ in } E_I\}$, $V(\mathcal{D}_{E_I} \otimes e_{1,1})V^* \subseteq Q(\mathcal{D}_{E_I} \otimes c_0(\{1, 2, \dots, n\}))$.

For the other inclusion, suppose $Q(s_\mu s_\mu^* \otimes e_{\ell,\ell}) = (s_\mu s_\mu^* \otimes e_{\ell,\ell})Q = s_\mu s_\mu^* \otimes e_{\ell,\ell}$. Then

$$\begin{aligned}
(s_\mu s_\mu^* \otimes e_{\ell,\ell})V &= (s_\mu s_\mu^* \otimes e_{\ell,\ell}) \left(\sum_{v \in E^0 \setminus \{w\}} p_{v^1} \otimes e_{1,1} + \sum_{i=1}^n \sum_{f \in s_E^{-1}(w)} s_{f^1} s_{f^i}^* \otimes e_{i,1} \right) \\
&= \begin{cases} (s_\mu s_\mu^* \otimes e_{1,1}) \left(\sum_{v \in E^0 \setminus \{w\}} p_{v^1} \otimes e_{1,1} + \sum_{f \in s_E^{-1}(w)} s_{f^1} s_{f^1}^* \otimes e_{1,1} \right) & \text{if } \ell = 1 \\ (s_\mu s_\mu^* \otimes e_{\ell,\ell}) \sum_{f \in s_E^{-1}(w)} s_{f^1} s_{f^\ell}^* \otimes e_{\ell,1} & \text{if } \ell \neq 1 \end{cases} \\
&= \begin{cases} (s_\mu s_\mu^* \otimes e_{1,1})(q \otimes e_{1,1}) & \text{if } \ell = 1 \\ \sum_{f \in s_E^{-1}(w)} s_\mu s_\mu^* s_{f^1} s_{f^\ell}^* \otimes e_{\ell,1} & \text{if } \ell \neq 1 \end{cases} \quad \blacksquare
\end{aligned}$$

which implies

$$V^*(s_\mu s_\mu^* \otimes e_{\ell, \ell})V = \begin{cases} qs_\mu s_\mu^* q \otimes e_{1,1} & \text{if } \ell = 1 \\ \sum_{f, g \in s_E^{-1}(w)} s_{g^\ell} s_{g^1}^* s_\mu s_\mu^* s_{f^1} s_{f^\ell}^* \otimes e_{1,1} & \text{if } \ell \neq 1. \end{cases}$$

Suppose $\ell = 1$. Then $qs_\mu s_\mu^* q \otimes e_{1,1} \in q\mathcal{D}_{E_I} \otimes e_{1,1} \subseteq \mathcal{D}_{E_I} \otimes e_{1,1}$. Suppose $\ell \neq 1$. Then $\sum_{f, g \in s_E^{-1}(w)} s_{g^\ell} s_{g^1}^* s_\mu s_\mu^* s_{f^1} s_{f^\ell}^* \otimes e_{1,1} = \sum_{f \in s_E^{-1}(w)} s_{f^\ell} s_{\mu'} s_{\mu'}^* s_{f^\ell}^* \otimes e_{1,1} \in \mathcal{D}_{E_I} \otimes e_{1,1}$. Hence, $V^*(Q(\mathcal{D}_{E_I} \otimes c_0(\{1, 2, \dots, n\})))V \subseteq \mathcal{D}_{E_I} \otimes e_{1,1}$ which implies that

$$\begin{aligned} Q(\mathcal{D}_{E_I} \otimes c_0(\{1, 2, \dots, n\})) &= VV^*(\mathcal{D}_{E_I} \otimes c_0(\{1, 2, \dots, n\}))VV^* \\ &\subseteq V(\mathcal{D}_{E_I} \otimes e_{1,1})V^* \\ &\subseteq Q(\mathcal{D}_{E_I} \otimes c_0(\{1, 2, \dots, n\})). \end{aligned}$$

Thus, $\beta(\mathcal{D}_{E_I} \otimes e_{1,1}) = V(\mathcal{D}_{E_I} \otimes e_{1,1})V^* = Q(\mathcal{D}_{E_I} \otimes c_0(\{1, 2, \dots, n\}))$ proving (3.1).

Using the above claim, we get

$$\begin{aligned} \Psi(\mathcal{D}_{E_I}) &= ((\psi \otimes \text{id}_{\mathbf{M}_n(\mathbb{C})})^{-1} \circ \beta)(\mathcal{D}_{E_I} \otimes e_{1,1}) \\ &= (\psi \otimes \text{id}_{\mathbf{M}_n(\mathbb{C})})^{-1}(Q(\mathcal{D}_{E_I} \otimes c_0(\{1, 2, \dots, n\}))) \\ &= p(\mathcal{D}_E \otimes c_0(\{1, 2, \dots, n\})). \end{aligned}$$

The last part of the theorem follows from (9) \implies (8) in [CRST, Corollary 11.3], since $p \geq 1_{C^*(E)} \otimes e_{1,1}$ and the closed ideal in $\mathcal{F}_E \otimes \mathbf{M}_n(\mathbb{C})$ generated by $1_{C^*(E)} \otimes e_{1,1}$ is $\mathcal{F}_E \otimes \mathbf{M}_n(\mathbb{C})$. \square

Definition 3.6 (Move (I+): Unital Insplitting). *The graphs E and F are said to be move (I+) equivalent if there exists a graph G and a regular vertex $w \in G^0$ such that E is the result of an (I-) move applied to G via a partition of $r_G^{-1}(w)$ using n sets and F is the result of an (I-) move applied to G via a partition of $r_G^{-1}(w)$ using n sets.*

Corollary 3.7 ((I+) \subseteq $\overline{\text{II}}$). *Let $E = (E^0, E^1, r_E, s_E)$ be a graph and let $w \in E^0$ be a regular vertex. Partition $r^{-1}(w)$ twice as a finite disjoint union of (possibly empty) subsets,*

$$\begin{aligned} r^{-1}(w) &= \mathcal{E}_1 \sqcup \mathcal{E}_2 \sqcup \dots \sqcup \mathcal{E}_n \\ &= \mathcal{F}_1 \sqcup \mathcal{F}_2 \sqcup \dots \sqcup \mathcal{F}_n. \end{aligned}$$

*Let F be the insplitting graph of E with respect to the first partition and let G be the insplitting graph of E with respect to the second partition. Then there exists a *-isomorphism $\phi: C^*(F) \rightarrow C^*(G)$ such that $\phi(\mathcal{D}_F) = \mathcal{D}_G$ and $\gamma_z^G \circ \phi = \phi \circ \gamma_z^F$.*

Proof. First note that for any bijection β on the set $\{1, 2, \dots, n\}$, the graphs obtained from E by insplitting the vertex w with respect to the partitions

$$\begin{aligned} r^{-1}(w) &= \mathcal{E}_1 \sqcup \mathcal{E}_2 \sqcup \dots \sqcup \mathcal{E}_n \\ r^{-1}(w) &= \mathcal{E}_{\beta(1)} \sqcup \mathcal{E}_{\beta(2)} \sqcup \dots \sqcup \mathcal{E}_{\beta(n)} \end{aligned}$$

are isomorphic. Consequently, there exists a *-isomorphism between the two graph C^* -algebras preserving the gauge-action and the canonical diagonal. Similar for the graphs obtained from E by insplitting the vertex w with respect to the partitions

$$\begin{aligned} r^{-1}(w) &= \mathcal{F}_1 \sqcup \mathcal{F}_2 \sqcup \dots \sqcup \mathcal{F}_n \\ r^{-1}(w) &= \mathcal{F}_{\beta(1)} \sqcup \mathcal{F}_{\beta(2)} \sqcup \dots \sqcup \mathcal{F}_{\beta(n)}. \end{aligned}$$

Consequently, we may assume that \mathcal{E}_1 and \mathcal{F}_1 are nonempty sets if $r^{-1}(w)$ is a nonempty set.

Applying Theorem 3.5, with E and F , we get a $*$ -isomorphism $\Psi_F: C^*(F) \rightarrow p(C^*(E) \otimes M_n(\mathbb{C}))p$, where $p = \sum_{v \in E \setminus \{w\}} p_v + p_w \otimes 1_{M_n(\mathbb{C})}$ such that $\Psi_F(\mathcal{D}_F) = p(\mathcal{D}_E \otimes c_0(\{1, 2, \dots, n\}))$, and $(\gamma_z^E \otimes \text{id}_{M_n(\mathbb{C})}) \circ \Psi_F = \Psi_F \circ \gamma_z^F$. Applying Theorem 3.5, with E and G , we get a $*$ -isomorphism $\Psi_G: C^*(G) \rightarrow p(C^*(E) \otimes M_n(\mathbb{C}))p$ such that $\Psi_G(\mathcal{D}_G) = p(\mathcal{D}_E \otimes c_0(\{1, 2, \dots, n\}))$, and $(\gamma_z^E \otimes \text{id}_{M_n(\mathbb{C})}) \circ \Psi_G = \Psi_G \circ \gamma_z^G$. Then $\phi = \Psi_G^{-1} \circ \Psi_F: C^*(F) \rightarrow C^*(G)$ is a $*$ -isomorphism such that

$$\phi(\mathcal{D}_F) = \Psi_G^{-1}(p(\mathcal{D}_E \otimes c_0(\{1, 2, \dots, n\}))) = \mathcal{D}_G$$

and

$$\begin{aligned} \gamma_z^G \circ \phi &= \gamma_z^G \circ \Psi_G^{-1} \circ \Psi_F \\ &= \Psi_G^{-1} \circ (\gamma_z^E \otimes \text{id}_{M_n(\mathbb{C})}) \circ \Psi_F \\ &= \Psi_G^{-1} \circ \Psi_F \circ \gamma_z^F \\ &= \phi \circ \gamma_z^F. \end{aligned} \quad \square$$

Remark 3.8. As touched upon in the introduction, we find it convenient to think of a (I+) move as the result of redistributing the past of vertices having the same future, as the pair of lower points in (1.2) and (1.3). This even makes sense – with care – in the presence of loops; for instance we have

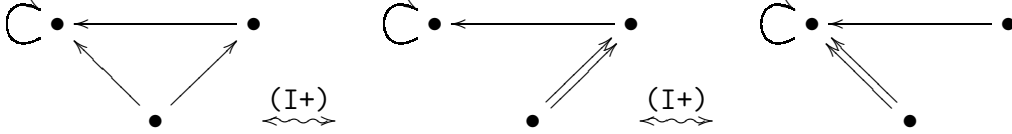

since all graphs are in-splittings of $\text{C} \bullet \leftarrow \bullet$ with two sets in the partition.

3.3. Delays. We now move on to moves related to symbol expansion from symbolic dynamics, characterized by allowing slower transitions between two vertices in the graph. Such moves are inherently not gauge-invariant, and the versions hitherto used have also failed to provide $*$ -isomorphisms rather than stable isomorphisms. Inspired by the work in [AR15] we present first a move which allows to remove any regular vertex not supporting a loop in a way preserving $\overline{101}$. It is a variation of a generalization of the (R) move considered earlier which seems to have the right generality. We will still need the move (S) of adding a source anywhere considered already in [Sør13] and note that it preserves $\overline{001}$.

Definition 3.9 (Move (R+): Unital Reduction). *Let E be a graph and let w be a regular vertex which does not support a loop. Let E_{R+} be the graph defined by*

$$E_{R+}^0 = (E^0 \setminus \{w\}) \sqcup \{\tilde{w}\}$$

$$E_{R+}^1 = (E^1 \setminus (r_E^{-1}(w) \cup s_E^{-1}(w))) \sqcup \{[ef] : e \in r_E^{-1}(w), f \in s_E^{-1}(w)\} \sqcup \{\tilde{f} : f \in s_E^{-1}(w)\}$$

where the source and range maps of E_{R+} extend those of E , and satisfy $s_{E_{R+}}([ef]) = s_E(e)$, $s_{E_{R+}}(\tilde{f}) = \tilde{w}$, $r_{E_{R+}}([ef]) = r_E(f)$ and $r_{E_{R+}}(\tilde{f}) = r_E(f)$.

Theorem 3.10 ((R+) $\subseteq \overline{101}$). *Let E be a graph and let w be a regular vertex and let E_{R+} be the graph in Definition 3.9. Then there exists a $*$ -isomorphism $\psi: C^*(E_{R+}) \rightarrow C^*(E)$ such that $\psi(\mathcal{D}_{E_{R+}}) = \mathcal{D}_E$.*

Proof. Set $P_v = p_v$ for $v \in E^0 \setminus \{w\}$, $P_{\tilde{w}} = p_w$, $S_e = s_e$ for $e \in E^1 \setminus (r_E^{-1}(w) \cup s_E^{-1}(w))$, $S_{[ef]} = s_e s_f$ for $e \in r_E^{-1}(w)$, $f \in s_E^{-1}(w)$, and $S_{\tilde{f}} = s_f$ for $f \in s_E^{-1}(w)$. A computation shows that $\{P_v, P_{\tilde{w}}, S_e, S_{[ef]}, S_{\tilde{f}}\}$ is a Cuntz-Krieger E_{R+} -family in $C^*(E)$. Therefore, there exists a $*$ -homomorphism $\psi: C^*(E_{R+}) \rightarrow C^*(E)$ such that $\psi(p_v) = P_v$, $\psi(p_{\tilde{w}}) = P_{\tilde{w}}$, $\psi(s_e) = S_e$, $\psi(s_{[ef]}) = S_{[ef]}$, and $\psi(s_{\tilde{f}}) = S_{\tilde{f}}$. Note that ψ sends each vertex project to a nonzero projection and if $e_1 e_2 \dots e_n$ is a vertex-simple cycle in E_{R+} with no exits (*vertex-simple* means $s_{E_{R+}}(e_i) \neq s_{E_{R+}}(e_j)$ for $i \neq j$) then $\psi(s_{e_1 e_2 \dots e_n})$ is a unitary in a corner of $C^*(E)$ with full spectrum. Hence, by [Szy02, Theorem 1.2], ψ is injective.

We now show that ψ is surjective. Note that the only generators of $C^*(E)$ that are not obviously in the image of ψ are s_e with $r_E(e) = w$. Let $e \in r_E^{-1}(w)$. Then

$$s_e = s_e \sum_{f \in s_E^{-1}(w)} s_f s_f^* = \sum_{f \in s_E^{-1}(w)} S_{[ef]} S_{\tilde{f}}^* = \psi \left(\sum_{f \in s_E^{-1}(w)} s_{[ef]} s_{\tilde{f}}^* \right).$$

Therefore, the image of ψ contains every generator of $C^*(E)$ which implies that ψ is surjective.

We are left with showing $\psi(\mathcal{D}_{E_{R+}}) = \mathcal{D}_E$. For a path $\mu = e_1 e_2 \dots e_n$ in E_{R+} , set $\nu_\mu = \nu_1 \nu_2 \dots \nu_n$ where

$$\nu_i = \begin{cases} e_i & \text{if } e_i \in E^1 \setminus (r_E^{-1}(w) \cup s_E^{-1}(w)) \\ ef & \text{if } e_i = [ef] \\ f & \text{if } e_i = \tilde{f} \\ v & \text{if } \mu = v \\ w & \text{if } \mu = \tilde{w}. \end{cases}$$

Since \tilde{f} is a source in E_{R+} for all $f \in s_E^{-1}(w)$, $e_i = \tilde{f}$ for some $f \in s_E^{-1}(w)$ implies $i = 1$. With this observation, it is now clear that ν_μ is a path in E . Note that if μ is a path in E_{R+} , then $\psi(s_\mu) = s_{\nu_\mu}$. Therefore, for all paths μ in E_{R+} , $\psi(s_\mu s_\mu^*) = s_{\nu_\mu} s_{\nu_\mu}^*$ is an element in \mathcal{D}_E . Since $\mathcal{D}_{E_{R+}}$ is generated by elements of the form $s_\mu s_\mu^*$, $\psi(\mathcal{D}_{E_{R+}}) \subseteq \mathcal{D}_E$. Let ν be a path in E . If $\nu = v \in E^0$, then by definition of ψ , p_ν is an element of $\psi(\mathcal{D}_{E_{R+}})$. Let $\nu = f_1 f_2 \dots f_n$ be a path of positive length in E . By grouping the edges $f_i f_{i+1}$ where $f_i \in r_E^{-1}(w)$ and $f_{i+1} \in s_E^{-1}(w)$, we may write $\nu = \nu_1 \nu_2 \dots \nu_m$ where ν_i is an edge or a path of length two of the form ef with $e \in r_E^{-1}(w)$ and $f \in s_E^{-1}(w)$ satisfying $|\nu_i| = 1$ and $s_E(\nu_i) = w$ implies $i = 1$. Set $\mu = \mu_1 \dots \mu_n$ with

$$\mu_1 = \begin{cases} \mu_1 & \text{if } |\nu_1| = 1 \text{ and } s_E(\nu_1) \neq w \\ \tilde{\nu}_1 & \text{if } |\nu_1| = 1 \text{ and } s_E(\nu_1) = w \\ [\mu_1] & \text{if } |\mu_1| = 2 \end{cases}$$

and

$$\mu_i = \begin{cases} \nu_i & \text{if } |\nu_i| = 1 \\ [\nu_i] & \text{if } |\nu_i| = 2 \end{cases}$$

for $i \geq 2$. By construction, μ is a path in E_{R+} and $\psi(s_\mu) = s_\nu$. Thus,

$$s_\nu s_\nu^* = \psi(s_\mu s_\mu^*).$$

Since \mathcal{D}_E is generated by elements of the form $s_\nu s_\nu^*$, $\mathcal{D}_E \subseteq \psi(\mathcal{D}_{E_{R+}})$. We conclude that $\psi(\mathcal{D}_{E_{R+}}) = \mathcal{D}_E$. \square

Definition 3.11 (Move (S): Remove a regular source). *Let $E = (E^0, E^1, r, s)$ be a graph, and let $w \in E^0$ be a source that is also a regular vertex. Let E_S denote the graph (E_S^0, E_S^1, r_S, s_S) defined by*

$$E_S^0 := E^0 \setminus \{w\} \quad E_S^1 := E^1 \setminus s^{-1}(w) \quad r_S := r|_{E_S^1} \quad s_S := s|_{E_S^1}.$$

We say E_S is formed by performing move (S) to E .

Theorem 3.12 ((S) \subseteq $\overline{101}$). *Let E be a graph and let w be a regular source. Let E_S be the graph in Definition 3.11. Then there exists a $*$ -isomorphism $\psi: C^*(E_S) \otimes \mathbb{K} \rightarrow C^*(E) \otimes \mathbb{K}$ such that $\psi(\mathcal{D}_{E_S} \otimes c_0) = \mathcal{D}_E \otimes c_0$.*

Proof. Define $\phi: C^*(E_S) \rightarrow C^*(E)$ by $\phi(p_v) = p_v$ and $\phi(s_e) = s_e$ for all $v \in E_S^0$ and $e \in E_S^1$. Let $q = \sum_{v \in E_S} p_v$. A computation shows that $\phi(C^*(E_S)) = qC^*(E)q$ and $\phi(\mathcal{D}_{E_S}) = q\mathcal{D}_E$. Since w is a regular source, q is a full projection in $C^*(E)$. The theorem now follows from [CRS17, Theorem 3.2, Theorem 4.2, and Corollary 4.5]. \square

3.4. Advanced moves. The Cuntz splice and Pulelehua moves are complicated moves designed (by Cuntz in [Cun86] and the authors with Restorff and Sørensen in [ERRS]) to change the graph essentially without changing the K -theory of the graph C^* -algebra. Proving that these moves do not change the graph C^* -algebra either is a key step for establishing classification ([Rør95], [ERRS17], [ERRS]) and the stable isomorphisms thus obtained are not concrete and cannot be expected to preserve any additional structure.

It is, however, not hard to obtain versions which preserve $*$ -isomorphism as corollaries to classification, and indeed this was first considered for the (C) move in [Mat18]. We choose a different solution, adding a number of sources to the standard construction which balances the situation enough to preserve the K -theoretical class of the unit. We may then prove that these moves are $\overline{100}$ by appealing to classification results.

For a graph F and $v \in F^0$, e_v will denote the element in \mathbb{Z}^{F^0} that is 1 in the v^{th} coordinate and zero elsewhere. By $[e_v]$ or $[e_v]_F$ we denote the image in coker \mathbf{B}_F^\bullet .

Definition 3.13 (Move (C+): Cuntz splicing). *Let $E = (E^0, E^1, r, s)$ be a graph and let $u \in E^0$ be a regular vertex that supports at least two distinct return paths. Let E_{C+} denote the graph $(E_{C+}^0, E_{C+}^1, r_{C+}, s_{C+})$ defined by*

$$E_{C+}^0 := E^0 \sqcup \{u_1, u_2, u_3\}$$

$$E_{C+}^1 := E^1 \sqcup \{e_1, e_2, f_1, f_2, h_1, h_2, g\},$$

where r_{C+} and s_{C+} extend r and s , respectively, and satisfy

$$s_{C+}(e_1) = u, \quad s_{C+}(e_2) = u_1, \quad s_{C+}(f_i) = u_1, \quad s_{C+}(h_i) = u_2, \quad s_{C+}(g) = u_3$$

and

$$r_{C+}(e_1) = u_1, \quad r_{C+}(e_2) = u, \quad r_{C+}(f_i) = u_i, \quad r_{C+}(h_i) = u_i, \quad r_{C+}(g) = u.$$

We say E_{C+} is formed by performing move (C+) to E .

Theorem 3.14 ((C+) \subseteq $\overline{100}$). *Let E be a graph and let u be a regular vertex that supports at least two distinct return paths. Then $C^*(E) \cong C^*(E_{C+})$.*

Proof. By [ERRS18, Lemma 3.17], there exists a graph E' with finitely many vertices such that $C^*(E) \cong C^*(E')$, each infinite emitter in E' emits infinitely many edges to any vertex it emits an edge to, and every transition state has exactly one outgoing edge. To

obtain E' , one out-splits each infinite emitter and each transition state. Since these graph moves do not involve u (regular vertex that supports at least two distinct return paths), we can outsplit the same vertices in E_{C+} and get a graph F' such that $C^*(E_{C+}) \cong C^*(F')$ and $F' \cong E'_{C+}$. Thus, without loss of generality, we may assume that each infinite emitter in E emits infinitely many edges to any vertex it emits an edge to, and every transition state has exactly one outgoing edge. Consequently, $\mathbf{B}_E = \mathbf{A}_E - \mathbf{I}$ is an element of the class of matrices $\mathfrak{M}_{\mathcal{P}}^{\circ}(\mathbf{m} \times \mathbf{n}, \mathbb{Z})$ defined in [ERRS18, Definition 4.15], and $\mathbf{B}_{E_{C+}} = \mathbf{A}_E - \mathbf{I}$ is an element of $\mathfrak{M}_{\mathcal{P}}^{\circ}((\mathbf{m} + 3\mathbf{e}_j) \times (\mathbf{n} + 3\mathbf{e}_j), \mathbb{Z})$ where u belongs to the block $j \in \mathcal{P}$. Here \mathbf{e}_j is the vector with 1 in the j^{th} component.

Note that the diagonal block of $\mathbf{B}_{E_{C+}}^{\bullet}\{j\}$ can be described as the matrix

$$\left[\begin{array}{c|ccc} \mathbf{B}_E^{\bullet}\{j\} & \vdots & \vdots & \vdots \\ \hline \cdots & 0 & 0 & 0 \\ \cdots & 0 & 0 & 0 \\ \cdots & 0 & 1 & 0 \end{array} \right].$$

Let $U \in \text{GL}_{\mathcal{P}}((\mathbf{m} + 3\mathbf{e}_j) \times (\mathbf{n} + 3\mathbf{e}_j), \mathbb{Z})$ and $V \in \text{SL}_{\mathcal{P}}(\mathbf{m} + 3\mathbf{e}_j) \times (\mathbf{n} + 3\mathbf{e}_j), \mathbb{Z})$ be the identity matrix everywhere except the j^{th} diagonal block where they are given by

$$\left[\begin{array}{c|ccc} \mathbf{I} & \vdots & \vdots & \vdots \\ \hline \cdots & 0 & -1 & 0 \\ \cdots & 0 & 0 & 0 \\ \cdots & 0 & 0 & 1 \end{array} \right]$$

and

$$\left[\begin{array}{c|ccc} \mathbf{I} & \vdots & \vdots & \vdots \\ \hline \cdots & 0 & 0 & 0 \\ \cdots & 0 & -1 & 0 \\ \cdots & 0 & -1 & 0 \end{array} \right]$$

respectively. Then $U\mathbf{B}_{E_{C+}}^{\bullet}V = -\iota_{3\mathbf{e}_j}(-\mathbf{B}_E^{\bullet})$ where $\iota_{\mathbf{r}}$ is the embedding of a block matrix to a larger block matrix for any multiindex \mathbf{r} (see [ERRS18, Definition 4.1]).

As explained in [ERRS18, Section 4.4], (U, V) induces an isomorphism $\text{FK}_{\mathcal{R}}(U, V)$ on the reduced filtered K -theory from $\text{FK}_{\mathcal{R}}(\mathcal{P}, C^*(E_{C+}))$ to $\text{FK}_{\mathcal{R}}(\mathcal{P}, C^*(E))$ where V^T induces the isomorphism on the K_0 -groups. Note that $[p_{u_1}] = 0$ and $[p_{u_3}] = [p_u]$ in $K_0(C^*(E_{C+}))$. Note that

$$V^T(e_v) = e_v \quad \text{and} \quad V^T(e_{u_2}) = -e_u + e_{u_2}$$

for all $v \in E^0$. By identifying $K_0(C^*(E_{C+}))$ with $\text{coker } \mathbf{B}_{E_{C+}}^{\bullet}$ and $K_0(C^*(E))$ with $\text{coker}(-\iota_{3\mathbf{e}_j}(-\mathbf{B}_E^{\bullet}))$ we get $V^T([e_v]_{E_{C+}}) = [e_v]_E$ and $V^T([e_{u_2}]_{E_{C+}}) = -[e_u]_E$ since $e_{u_2} \in \text{im}(-\iota_{3\mathbf{e}_j}(-\mathbf{B}_E^{\bullet}))$. Therefore,

$$\begin{aligned} V^T \left(\sum_{v \in E_{C+}^0} [e_v]_{E_{C+}} \right) &= V^T \left(\sum_{v \in E^0} [e_v]_{E_{C+}} + [e_{u_2}]_{E_{C+}} + [e_{u_3}]_{E_{C+}} \right) \\ &= \sum_{v \in E^0} [e_v]_E - [e_u]_E + V^T([e_u]_{E_{C+}}) \\ &= \sum_{v \in E^0} [e_v]_E. \end{aligned}$$

Hence, $\text{FK}_{\mathcal{R}}(U, V)$ sends $[1_{C^*(E_{C+})}]$ to $[1_{C^*(E)}]$. Moreover, since $V^T(e_v) = e_v$ for all $v \in E^0$ and the simple subquotient corresponding to the j th component is a purely infinite simple C^* -algebra, $\text{FK}_{\mathcal{R}}(U, V)$ is an isomorphism on the ordered reduced filtered K -theory from $\text{FK}_{\mathcal{R}}^+(\mathcal{P}, C^*(E_{C+}))$ to $\text{FK}_{\mathcal{R}}^+(\mathcal{P}, C^*(E))$. By [ERRS, Theorem 3.5], $C^*(E_{C+}) \cong C^*(E)$. \square

We denote the graph where we have applied $(\mathbf{C}+)$ to each vertex w in S by $E_{S,-}$. For each $w \in S$, v_1^w, v_2^w, v_3^w will denote the additional vertices from the $(\mathbf{C}+)$ move at w enumerated as in Definition 3.13.

Definition 3.15 (Move $(\mathbf{P}+)$: Eclosing a cyclic component). *Let $E = (E^0, E^1, r, s)$ be a graph and let u be a regular vertex that supports a loop and no other return path, the loop based at u has an exit, and if $w \in E^0 \setminus \{u\}$ and $s_E^{-1}(u) \cap r_E^{-1}(w) \neq \emptyset$, then w is a regular vertex that supports at least two distinct return paths. We construct $E_{u,P+}$ as follows.*

Set $S = \{w \in E^0 \setminus \{u\} : s_E^{-1}(u) \cap r_E^{-1}(w) \neq \emptyset\}$ (since the loop based at u has an exit, S is nonempty, and clearly $u \notin S$). Set $E_{u,P+}^0 = E_{S,-}^0$ and

$$E_{u,P+}^1 = E_{S,-}^1 \sqcup \{\bar{e}_w, \tilde{e}_w : w \in S, e \in s_E^{-1}(u) \cap r_E^{-1}(w)\}$$

with $s_{E_{u,P+}}|_{E_{S,-}^1} = s_{E_{S,-}}, r_{E_{u,P+}}|_{E_{S,-}^1} = r_{E_{S,-}}, s_{E_{u,P+}}(\bar{e}_w) = s_{E_{u,P+}}(\tilde{e}_w) = u, r_{E_{u,P+}}(\bar{e}_w) = r_{E_{u,P+}}(\tilde{e}_w) = v_2^w$.

We say that $E_{u,P+}$ is formed by performing Move $(\mathbf{P}+)$ to E .

Theorem 3.16 ($(\mathbf{P}+) \subseteq \overline{100}$). *Let E be a graph and let u be a regular vertex that supports a loop and no other return path, the loop based at u has an exit, and if $w \in E^0 \setminus \{u\}$ and $s_E^{-1}(u) \cap r_E^{-1}(w) \neq \emptyset$, then w is a regular vertex that supports at least two distinct return paths. Then $C^*(E_{u,P+}) \cong C^*(E)$.*

Proof. We again use a similar argument as in the proof of Theorem 3.14, without loss of generality, we may assume that each infinite emitter in E emits infinitely many edges to any vertex it emits an edge to, and every transition state has exactly one outgoing edge. Thus, $\mathbf{B}_E = \mathbf{A}_E - \mathbf{I}$ is an element of $\mathfrak{M}_{\mathcal{P}}^{\circ}(\mathbf{m} \times \mathbf{n}, \mathbb{Z})$. Let j be the component of u and let j_1, j_2, \dots, j_n be the components in \mathcal{P} such that for each i , there exists w in the component j_i such that $\mathbf{B}_E(u, w) \neq 0$.

Let $S = \{w \in E^0 \setminus \{u\} : s_E^{-1}(u) \cap r_E^{-1}(w) \neq \emptyset\}$, let

$$\mathcal{E}_i = \{w \in E^0 : w \text{ is in the } j_i \text{ component and } \mathbf{B}_E(u, w) \neq 0\},$$

and let $k_i = |\mathcal{E}_i|$. Let V be the operation matrix which implements the matrix operations

- Add column v_3^w to column w for all $w \in S$
- Subtract column v_2^w from column w for all $w \in S$

by multiplication from the right. Let $\mathbf{r} = \sum_{i=1}^n 3k_i \mathbf{e}_{j_i}$. Then $V \in \text{SL}_{\mathcal{P}}((\mathbf{m} + \mathbf{r}) \times (\mathbf{n} + \mathbf{r}), \mathbb{Z})$ since the column operations are done in each component. Let U be the operation matrix which implements the matrix operations

- Subtract row v_3^w from row w for all $w \in S$
- Subtract $\sum_{w \in S} 2|s_E^{-1}(u) \cap r_E^{-1}(w)|$ times row v_1^w from row u for all $w \in S$
- Multiply row u by -1
- Multiply rows v_1^w and v_2^w by -1 for all $w \in S$
- Interchange rows v_1^w and v_2^w for all $w \in S$

by multiplication from the left. Since the row operations are done in the components j_i , we have that $U \in \text{GL}_{\mathcal{P}}((\mathbf{m} + \mathbf{r}) \times (\mathbf{n} + \mathbf{r}), \mathbb{Z})$.

A computation shows that $UB_{E_{u,P+}}^\bullet V = -\iota_{\mathbf{r}}(-\mathbf{B}_E^\bullet)$. As explained in [ERRS18, Section 4.4], (U, V) induces an isomorphism $\text{FK}_{\mathcal{R}}(U, V)$ on the reduced filtered K -theory from $\text{FK}_{\mathcal{R}}(\mathcal{P}, C^*(E_{u,P+}))$ to $\text{FK}_{\mathcal{R}}(\mathcal{P}, C^*(E))$ where V^T induces the isomorphism on the K_0 -groups. Note that $V^T e_v = e_v$ for $v \in E^0$ and $V^T e_{v_2^w} = -e_w + e_{v_2^w}$ for all $w \in S$. Since $[p_{v_1^w}] = 0$, $[p_{v_2^w}] = [p_w]$ in $K_0(C^*(E_{u,P+}))$ and $e_{v_2^w}$ is in the image of $-\iota_{\mathbf{r}}(-\mathbf{B}_E^\bullet)$, identifying the K_0 -groups with the cokernels of the associated matrices we get

$$\begin{aligned} V^T \left(\sum_{v \in E_{u,P+}^0} [e_v] \right) &= V^T \left(\sum_{v \in E} [e_v] \right) + V^T \left(\sum_{w \in S} [e_{v_2^w}] \right) + V^T \left(\sum_{w \in S} [e_{v_3^w}] \right) \\ &= \sum_{v \in E^0 \setminus S} [e_v] + \sum_{w \in S} [e_w] - \sum_{w \in S} [e_w] + V^T \left(\sum_{w \in S} [e_w] \right) \\ &= \sum_{v \in E^0 \setminus S} [e_v] + \sum_{w \in S} [e_w] \\ &= \sum_{v \in E^0} [e_v]. \end{aligned}$$

Hence, $\text{FK}_{\mathcal{R}}(U, V)$ sends $[1_{C^*(E_{u,P+})}]$ to $[1_{C^*(E)}]$. Moreover, since $V^T(e_v) = e_v$ for all $v \in E^0$ and the simple subquotient corresponding to the j_i th component is a purely infinite simple C^* -algebra, $\text{FK}_{\mathcal{R}}(U, V)$ is an isomorphism on the ordered reduced filtered K -theory from $\text{FK}_{\mathcal{R}}^+(\mathcal{P}, C^*(E_{u,P+}))$ to $\text{FK}_{\mathcal{R}}^+(\mathcal{P}, C^*(E))$. By [ERRS, Theorem 3.5], $C^*(E_{u,P+}) \cong C^*(E)$. \square

4. xyz-EQUIVALENCES COMPARED

In this intermediate section, we study select examples of graphs to develop a portfolio of examples demonstrating first that the various notions of xyz -invariance are different, but also that in all but one of these cases, any concrete xyz -equivalence may be implemented by moves that respect $\overline{\text{xyz}}$. This leads up to a conjecture presented in the ensuing section.

We employ the strategy of showing concrete moves everywhere in this section, even in situations where we will later show the existence of such moves in further generality, since we find that it serves as a good illustration of how the refined moves work.

4.1. Three classes of graphs. In this section we introduce and study three classes of graphs which lead to interesting examples. For any $k \geq 0$ and any $n_1, \dots, n_k > 0$ we consider the graph $F(n_1, \dots, n_k)$

$$(4.1) \quad \begin{array}{ccccccc} \bullet & & \bullet & & \bullet & & \bullet \\ \downarrow n_1-1 & & \downarrow n_2-1 & & \downarrow n_{k-1}-1 & & \downarrow n_k \\ \bullet & \leftarrow & \bullet & \leftarrow & \dots & \leftarrow & \bullet & \leftarrow & \bullet \end{array}$$

to be interpreted as whenever some $n_i = 1$ with $i < k$, the corresponding source is removed. The notation has been chosen so that the n_i indicate the number of paths of length i ending at the sink. The graph $F()$ in the case $k = 0$ is simply a sink which is also

a source. For any $k \geq 1$ and any $n_1, \dots, n_k \geq 0$ we consider $E(n_1, \dots, n_k)$ given as

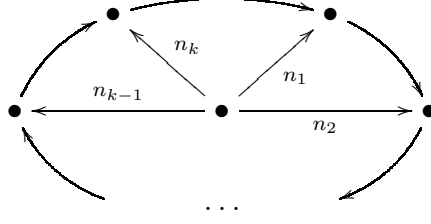

Note that this time $n_i = 0$ is allowed, but again if $\sum_{i=1}^k n_k = 0$ the source is removed. Finally, with $c \geq 2$ and $n \geq 0$ we will consider $G(c, n)$ given by the graph

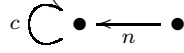

(i.e. with adjacency matrix $\begin{bmatrix} 0 & n \\ c & 0 \end{bmatrix}$), again with no source when $n = 0$.

Proposition 4.1. *Let $\underline{n} = (n_1, \dots, n_k)$ and $\underline{m} = (m_1, \dots, m_\ell)$ be given as above.*

- (1) $F(\underline{n})$ is 00z-equivalent to $F(\underline{m})$ for any choice of $\underline{n}, \underline{m}$, and by moves of the type (S) any such graph can be reduced to the graph $F()$.
- (2) $F(\underline{n})$ is 10z-equivalent to $F(\underline{m})$ whenever $\sum_{i=1}^k n_i = \sum_{j=1}^\ell m_j$, and by moves of the type (0) and (R+) any such graph can be reduced to a graph of the form $F(\sum_{i=1}^k n_i)$.
- (3) $F(\underline{n})$ is 01z-equivalent to $F(\underline{m})$ whenever $k = \ell$, and by moves of the type (0) and (I-) any such graph can be reduced to a graph of the form $F(\underline{1})$.
- (4) $F(\underline{n})$ is 11z-equivalent to $F(\underline{m})$ only when $k = \ell$ and $n_i = m_j$.

Proof. The first claim is clear. For (2), first note that the graph C^* -algebra associated with $F(\underline{n})$ is $M_d(\mathbb{C})$ with $d = 1 + \sum_{i=1}^k n_i$, so that the sum is retained by the C^* -algebra. Using (R+) on all vertices that are not sources and collecting all the resulting sources by (0) moves in reverse yields the standard form.

For the remaining claims, we appeal to the tools in Section 2.2. We first compute by Theorem 2.2 that $\mathcal{F}_{F(\underline{n})} \simeq \mathbb{C} \oplus M_{n_1}(\mathbb{C}) \oplus \dots \oplus M_{n_k}(\mathbb{C})$ and hence that $\mathcal{F}_{F(\underline{n})} \otimes \mathbb{K} = \mathbb{K}^{k+1}$. Consequently, tuples defining 01z-equivalent graphs must have the same number of entries. It is easy to remove all the vertical edges but one at the far right end of the graph in (4.1) by moves of the type (I-), obtaining the stipulated standard form in (3). To prove that the data is retained as an ordered tuple by 110-equivalence, we use Corollary 2.5. Indeed, the data given by the K -theory of $C^*(F(\underline{n}) \times_1 \mathbb{Z})$ and $C^*(F(\underline{m}) \times_1 \mathbb{Z})$ with the translation and corner projection comes out to $\sum_{\mathbb{Z}} \mathbb{Z}$, the right shift map, and

$$(\dots, 0, 1, n_1, \dots, n_k, 0, \dots) \text{ and } (\dots, 0, 1, m_1, \dots, m_\ell, 0, \dots)$$

respectively, with the first nonzero entry at index 0 depending. The K_0 -groups are ordered so that a vector is positive if and only if every entry is positive, so the elements \mathbf{e}_k with a single non-zero entry being 1 at index k define the set of minimally positive elements. Hence with h from Corollary 2.5 we have that $h(\mathbf{e}_0) = \mathbf{e}_s$ for some s , which implies that

$$h([p^F(\underline{n})_0]) = h\left(\mathbf{e}_0 + \sum_{i=1}^k n_i \mathbf{e}_i\right) = \mathbf{e}_s + \sum_{i=1}^k n_i \mathbf{e}_{i+s}.$$

But since this needs to coincide with $[p^F(\underline{m})_0]$ we conclude first that $s = 0$ and then that $\underline{n} = \underline{m}$. \square

Example 4.2. We note:

(4.2) $F()$ and $F(1)$ are 001-equivalent, but neither 100- nor 010-equivalent

(4.3) $F(1)$ and $F(2)$ are 011-equivalent, but not 100-equivalent

(4.4) $F(1, 1)$ and $F(2)$ are 101-equivalent, but not 010-equivalent

This also shows the non-invariance of our (I-), (R+), and (S) moves as indicated in Figure 2. Indeed, $F()$ is obtained by an (S) move on $F(1)$, $F(2)$ is obtained by an (I-) move on $F(1)$, and $F(2)$ is obtained by an (R+) move on $F(1, 1)$.

Proposition 4.3. *Let $\underline{n} = (n_1, \dots, n_k)$ and $\underline{m} = (m_1, \dots, m_\ell)$ be given as above.*

- (1) $E(\underline{n})$ is 00z-equivalent to $E(\underline{m})$ for any choice of $\underline{n}, \underline{m}$, and by moves of the type (O), (R+) and (S) any such graph can be reduced to the graph $E(0)$.
- (2) $E(\underline{n})$ is 10z-equivalent to $E(\underline{m})$ precisely when $\sum_{i=1}^k (n_i + 1) = \sum_{j=1}^\ell (m_j + 1)$, and by moves of the type (O) and (R+) any such graph can be reduced to a graph of the form $E(\sum_{i=1}^k (n_i + 1) - 1)$.
- (3) $E(\underline{n})$ is 01z-equivalent to $E(\underline{m})$ precisely when $k = \ell$, and by moves of the type (O) and (I-) any such graph can be reduced to a graph of the form $E(\underline{0})$.
- (4) $E(\underline{n})$ is 11z-equivalent to $E(\underline{m})$ only when $k = \ell$ and $n_{i+i_0} = m_i$ cyclically for some choice of i_0 .

Proof. For (1) and (2), we first use (R+) to reduce the cycle length to one. This will produce $k - 1$ additional sources, and by an (O) move we collect them to the graph $E(\sum_{i=1}^k n_i + (k - 1))$. In (1), we may remove these sources altogether by an (S) move, and in (2) this is a unique form since the C^* -algebra is $M_d(C(\mathbb{T}))$ with $d = \sum_{i=1}^k (n_i + 1)$.

For the remaining claims, we again appeal to the tools in Section 2.2. We get by Theorem 2.2 that $\mathcal{F}_{E(\underline{n})} \simeq M_{n_1+1}(\mathbb{C}) \oplus \dots \oplus M_{n_k+1}(\mathbb{C})$ and hence that the tuples defining 01z-equivalent graphs must have the same number of entries. To reduce to the case when all $n_i = 0$, consider

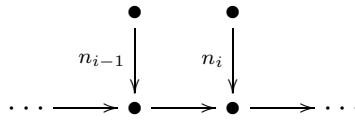

and note how the n_i edges to the vertex at index i may be removed by a reverse move (I-) applied to the vertex at index $i - 1$. This works also when $k = 1$, and we obtain the stipulated standard form in (3). To prove that the data is retained as a cyclically ordered tuple by 110-equivalence, we use Corollary 2.5. This time the data given by the K -theory of $C^*(F(\underline{n}) \times_1 \mathbb{Z})$ and $C^*(F(\underline{m}) \times_1 \mathbb{Z})$ with the translation and corner projection comes out to $\mathbb{Z}^k \simeq \mathbb{Z}^\ell$, the cyclic right shift map, and

$$(n_1 + 1, \dots, n_k + 1) \text{ and } (m_1 + 1, \dots, m_\ell + 1),$$

respectively. The claim follows as above. \square

Lemma 4.4. *Let c, n be given as above.*

- (1) *There are moves of the form (O), (I+) going from $G(c, n)$ to $G(c, c(n + c - 1))$.*
- (2) *There are moves of the form (O), (I+), (R+) going from $G(c, n)$ to $G(c, n + c - 1)$.*

Proof. One (0) move splitting all loops into c singletons gives a graph with c instances of vertices receiving n edges from a source, supporting a loop and receiving uniquely from all other vertices of this form. For $c = 3$ this looks like

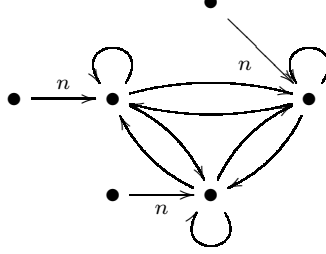

where we have split the sources for legibility of the graph. Since all these c vertices have exactly the same future, we may perform a (I+) move to create $c-1$ sources each emitting to a select vertex among the c , and collect all the edges from sources there, as

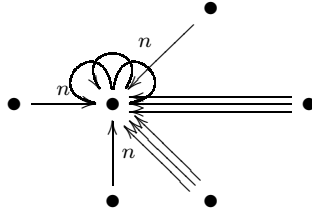

for $c = 3$. The total number of edges from sources is $c(c-1)$ from the other vertices arising from the outsplit, and cn obtained as copies of the original n . This establishes (1).

For (2), we first assume that $n > c$, perform an outsplit at the source and then go

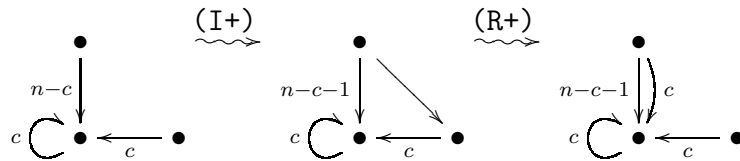

which becomes $G(c, n + c - 1)$ after a (0) move. When $n \in \{2, \dots, c\}$ we apply (1) to pass to $c(n + c - 1)$, and note that we can work our way up from $n + c - 1$ to this by the argument just given. When $n \in \{0, 1\}$ we must use (1) both on n and $n + c - 1$, but the argument is completed in the same way. \square

Resolving the 10z case for $G(c, n)$ is rather involved, and for the first and last time in this paper, we resort to an existence proof rather than just providing a concrete list of moves. We base our solution on a careful analysis on a parallel problem in symbolic dynamics performed by Danrun Huang (constructive, but complicated) in the mid-nineties ([Hua94]). We first note:

Proposition 4.5. Consider the graphs G_0, G_1, G_2, G_3 given by the adjacency matrices

$$A_0 = \begin{bmatrix} 0 & c_1 & c_2 \\ 0 & a_{11} & a_{12} \\ 0 & a_{21} & a_{22} \end{bmatrix} \quad A_1 = \begin{bmatrix} 0 & c_1 & c_2 + c_1 + 1 \\ 0 & a_{11} & a_{12} + a_{11} - 1 \\ 0 & a_{21} & a_{22} + a_{21} \end{bmatrix}$$

$$A_2 = \begin{bmatrix} 0 & c_1 & c_2 \\ 0 & a_{11} & a_{12} \\ 0 & a_{21} + a_{11} - 1 & a_{22} + a_{12} \end{bmatrix} \quad A_3 = \begin{bmatrix} 0 & c_1 + a_{11} - 1 & c_2 + a_{12} \\ 0 & a_{11} & a_{12} \\ 0 & a_{21} & a_{22} \end{bmatrix}$$

respectively, where all $c_i, a_{ij} > 0$.

- (1) G_1 can be obtained from G_0 by moves of the type (O) and (R+).
- (2) G_2 can be obtained from G_0 by moves of the type (O), (I+), and (R+) when $c_i > a_{1i}$.
- (3) G_3 can be obtained from G_0 by moves of the type (O), (I+), and (R+) when $c_1 > a_{11} + 1$ and $c_2 > a_{12}$.

Proof. For (1) we go

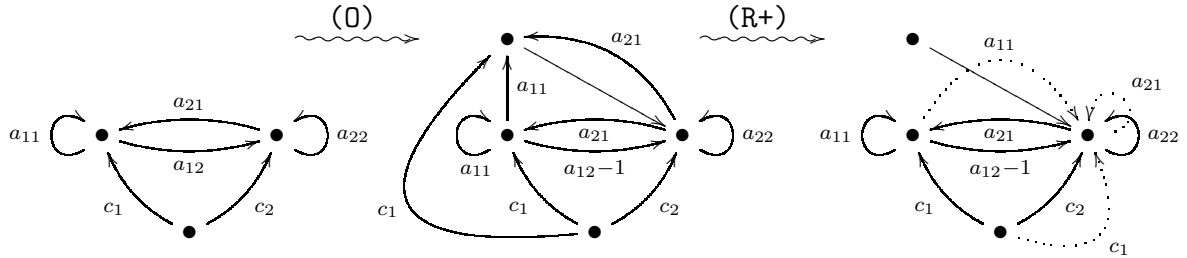

by first out-splitting at the leftmost vertex and then applying (R+) to the top one, which does not support at loop. The dotted arrows are all obtained as shortening of paths that used to go via the deleted vertex. Collecting all edges again gives the indicated graph. For (2) we go

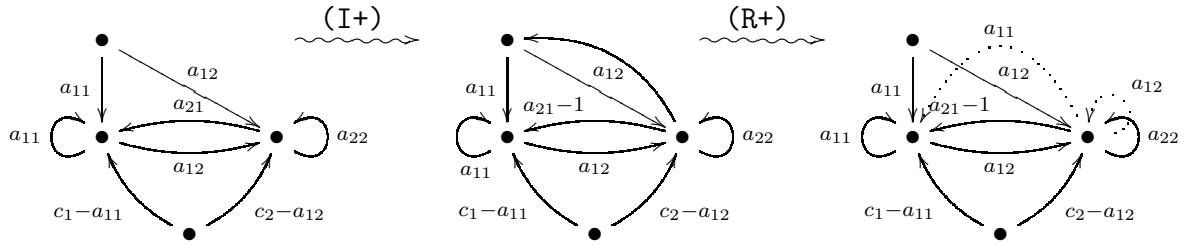

where the leftmost graph is obtained from the original by an (O) move “borrowing” edges from the source to prepare for the (I+) move, and then using (R+) as above. Reestablishing the original form gives the desired graph. For (3) we vary this construction slightly, to

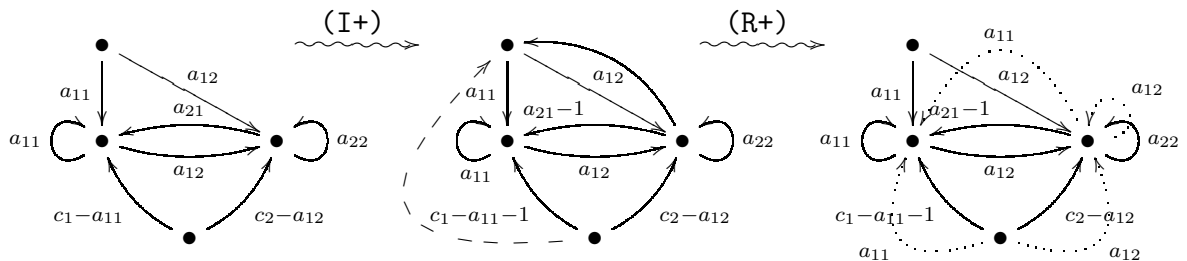

where we have also shifted one edge from the source to the leftmost vertex to the top (the slashed edge) before using (R+). This gives

$$\begin{bmatrix} 0 & c_1 + a_{11} - 1 & c_2 + a_{12} \\ 0 & a_{11} & a_{12} \\ 0 & a_{21} + a_{11} - 1 & a_{22} + a_{12} \end{bmatrix}$$

which we can obtain from A_3 by the moves in (2). \square

These recipes for moves are specializations of key concepts in [AER]. As in that paper, we introduce notation for an alternative way of keeping track of the data a_{ij}, c_i which simplifies the conclusions (1)–(3) above. We set

$$\begin{aligned} b_{ij} &= a_{ji} - \delta_{i,j} \quad (\text{Kronecker } \delta) \\ d_i &= c_i + 1 \end{aligned}$$

and represent the graphs by a pair

$$\left(\begin{pmatrix} d_1 \\ d_2 \end{pmatrix}, \begin{pmatrix} b_{11} & b_{12} \\ b_{21} & b_{22} \end{pmatrix} \right)$$

(note round parentheses, and that the adjacency matrix has been transposed).

Corollary 4.6. *With graphs represented as above, we may go from the pair (D, B) to any of the pairs*

$$(4.5) \quad \left(\begin{pmatrix} 1 & 1 \\ 0 & 1 \end{pmatrix} D, \begin{pmatrix} 1 & 1 \\ 0 & 1 \end{pmatrix} B \right), \left(\begin{pmatrix} 1 & 0 \\ 1 & 1 \end{pmatrix} D, \begin{pmatrix} 1 & 0 \\ 1 & 1 \end{pmatrix} B \right)$$

$$(4.6) \quad \left(D, B \begin{pmatrix} 1 & 1 \\ 0 & 1 \end{pmatrix} \right), \left(D, B \begin{pmatrix} 1 & 0 \\ 1 & 1 \end{pmatrix} \right)$$

$$(4.7) \quad \left(D + \begin{pmatrix} b_{11} \\ b_{21} \end{pmatrix}, B \right), \left(D + \begin{pmatrix} b_{12} \\ b_{22} \end{pmatrix}, B \right)$$

by moves of the type (0), (I+), and (R+), provided that $\min D > \ell + 2 > \ell > \max B$ for some integer ℓ .

Proof. Substitute in the conclusions of Proposition 4.5 to get the first claim in each line, and note the last claims by symmetry. \square

Keeping track of the different conditions on the entries in (1)–(3) of Proposition 4.5 is a key challenge in [AER], but the case we are studying here is so simple that we can afford the coarser condition using ℓ .

Proposition 4.7.

- (1) $\mathbf{G}(c, n)$ is $\mathbf{0yz}$ -equivalent to $\mathbf{G}(c, m)$ for any choice of n, m , and by moves of the type (0) and (I−) any such graph can be reduced to the graph $\mathbf{G}(c, 0)$.
- (2) $\mathbf{G}(c, n)$ is $\mathbf{10z}$ -equivalent to $\mathbf{G}(c, m)$ precisely when $m + 1 \equiv x(n + 1) \pmod{c - 1}$ where x is a unit of $\mathbb{Z}/(c - 1)$, and by moves of the type (0), (I+) and (R+) any two such graphs can be transformed into each other.
- (3) $\mathbf{G}(c, n)$ is $\mathbf{11z}$ -equivalent to $\mathbf{G}(c, m)$ precisely when $(c + m)/(c + n)$ is a power of c , and by moves of the type (0) and (I+) any two such graphs can be transformed into each other.

Proof. For (1), we go

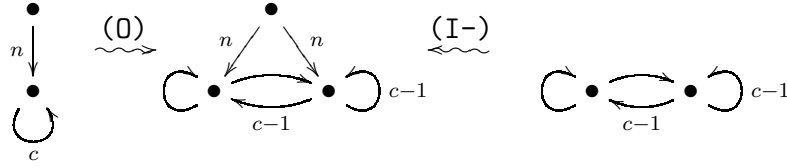

with the (I-) move applied at the vertex with only one loop. For (3), we note by Corollary 2.5 that the condition that $(c+m)/(c+n) = c^k$ with $k \in \mathbb{Z}$ is necessary for 110-equivalence since the pointed K -theory of $C^*(\mathbb{G}(c, n) \times_1 \mathbb{Z})$ with the class of the projection $[p_0]$ comes out to $(\mathbb{Z}[1/c], c+n)$ (since the shift translates to division by c in this case, any group isomorphism commutes with it). Also, when $(c+m)/(c+n) = c$ we have that $m = c(c+n) - c = c(c+n-1)$, and by Lemma 4.4(1) we may pass from $\mathbb{G}(c, n)$ to $\mathbb{G}(c, m)$ by 111-invariant moves. When $(c+m)/(c+n) = c^2$ we rewrite as

$$\frac{c+m}{c^2+cn} = c \quad \frac{c^2+cn}{c+n} = c$$

and note that we can go from $\mathbb{G}(c, n)$ to $\mathbb{G}(c, m)$ via $\mathbb{G}(c, c(c+n-1))$. Repeating this and/or interchanging m and n proves the claim, and in particular that 110 and 111 coincides here.

For (2), it is clear from K -theory that the condition on m and n is necessary for 100-equivalence, since $m+1$ and $n+1$, respectively, define the class of the units in the K_0 -group. In the other direction, let $q = c-1$. To pass from $\mathbb{G}(c, n)$ to $\mathbb{G}(c, x(n+1)-1)$ with x inducing a unit of \mathbb{Z}/q we assume that $0 \leq n < q$ but note that because of Lemma 4.4(2) we may freely elect to work with any other integer having the same remainder r modulo q . Thus for $k_1, k_2 \geq 2$ to be determined later, we start with $\mathbb{G}(c, (k_1+k_2+1)q+r)$ and go

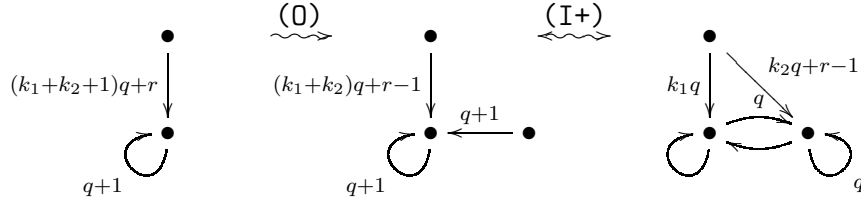

which is the graph represented by the pair

$$\left(\left(\begin{pmatrix} k_1q+1 \\ k_2q+r \end{pmatrix}, \begin{pmatrix} 0 & 1 \\ q & q-1 \end{pmatrix} \right) \right).$$

By (4.5) and (4.6) we can go to the pair

$$\left(\left(\begin{pmatrix} k_1q+1 \\ (k_1+k_2)q+r+1 \end{pmatrix}, \begin{pmatrix} 1 & 1 \\ 2q & q \end{pmatrix} \right) \right)$$

by applying $\begin{pmatrix} 1 & 0 \\ 1 & 1 \end{pmatrix}$ on the left and $\begin{pmatrix} 1 & 0 \\ 1 & 1 \end{pmatrix}$ on the right, and we note for later use that this way we can generate any pair

$$\left(\left(\begin{pmatrix} d_1 \\ d_2 \end{pmatrix}, \begin{pmatrix} 1 & 1 \\ 2q & q \end{pmatrix} \right) \right)$$

from $\mathbb{G}(c, r)$, provided that $d_2 > d_1 + 2q$ and $d_1 \equiv 1, d_2 \equiv r+1$ modulo q .

We are now ready to invoke [Hua94], which gives us matrices $U, V \in \text{SL}(2, \mathbb{N})$ so that

(i) U and V are products of $\begin{pmatrix} 1 & 0 \\ 0 & 1 \end{pmatrix}$ and $\begin{pmatrix} 1 & 1 \\ 1 & 1 \end{pmatrix}$

- (ii) $U \begin{pmatrix} 1 & 1 \\ 2q & q \end{pmatrix} = \begin{pmatrix} 1 & 1 \\ 2q & q \end{pmatrix} V$
- (iii) $U \begin{pmatrix} d_1 \\ d_2 \end{pmatrix} = \begin{pmatrix} d'_1 \\ d'_2 \end{pmatrix}$ with $d'_2 \equiv xd_2$ modulo q

Let $C = U \begin{pmatrix} 1 & 1 \\ 2q & q \end{pmatrix} = \begin{pmatrix} 1 & 1 \\ 2q & q \end{pmatrix} V$ and choose k_1 so that $k_1q > \max C$. Then by (4.5) we can go from our initial pair $(\begin{pmatrix} d_1 \\ d_2 \end{pmatrix}, \begin{pmatrix} 1 & 1 \\ 2q & q \end{pmatrix})$ to

$$(4.8) \quad \left(\begin{pmatrix} d'_1 \\ d'_2 \end{pmatrix}, C \right)$$

by the choices among $\begin{pmatrix} 1 & 1 \\ 0 & 1 \end{pmatrix}$ and $\begin{pmatrix} 1 & 0 \\ 1 & 1 \end{pmatrix}$ specified by U applied to the left. We use here that all entries in our pair are increasing along the way, and hence that any value encountered in the vector dominates any value encountered in a matrix in the way needed to apply Corollary 4.6. In the same fashion, we see by (4.6) that we may apply the choices among $\begin{pmatrix} 1 & 1 \\ 0 & 1 \end{pmatrix}$ and $\begin{pmatrix} 1 & 0 \\ 1 & 1 \end{pmatrix}$ specified by V to the pair

$$(4.9) \quad \left(\begin{pmatrix} d'_1 \\ d'_2 \end{pmatrix}, \begin{pmatrix} 1 & 1 \\ 2q & q \end{pmatrix} \right)$$

to arrive at the pair in (4.8), since the operations on the right do not affect the vector. Thus we have now a way via (0), (I+) and (R+) to (4.9) from our original graph.

We know that $d'_2 \equiv x(r+1)$ modulo q , and by adding the left column $\begin{pmatrix} 1 \\ 2q \end{pmatrix}$ a number of times by (4.7), we may arrange that $d'_1 \equiv 1$ modulo q and that $d'_2 > d'_1 + 2q$. This shows that we can obtain the graph specified from $G(c, x(n+1) - 1)$, as required. Since all moves used are 101-invariant, we have established that 100 and 101 coincide. \square

Example 4.8. (The Cuntz algebra \mathcal{O}_2) It is well known that $M_2(\mathcal{O}_2) \simeq \mathcal{O}_2$, but interestingly, the graphs $G(2, 0)$ and $G(2, 1)$ fail to be 111-equivalent as seen in the proof above (our eyes were opened to this fact by [Haz13]). The two graphs are 101-equivalent, and the equivalence may be implemented by 101-invariant moves which in this case come out to

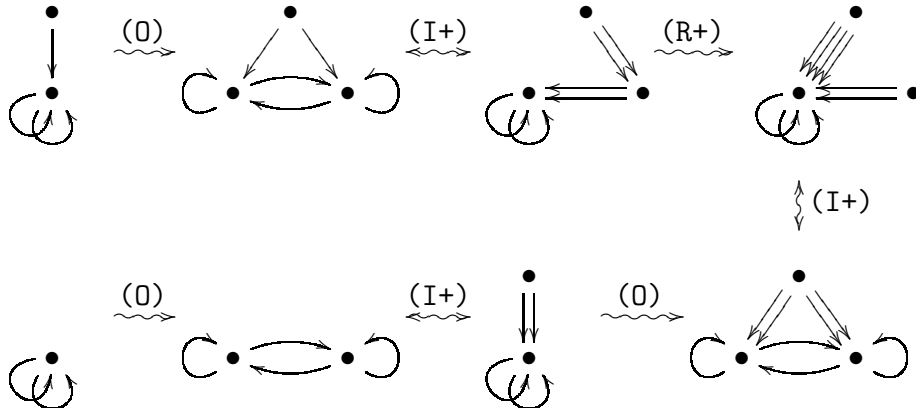

They are also 011-equivalent, and the equivalence may be implemented by 011-invariant moves such as

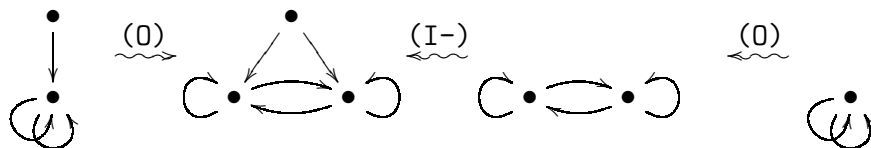

We conclude:

(4.10) $G(2, 0)$ and $G(2, 1)$ are **101**- and **011**-equivalent, but not **111**-equivalent

If $G(2, 0)$ had been **001**-isomorphic to the result G of applying **(C+)** to it, it would also be **001**-isomorphic to



by Theorem 3.12. The two SFTs defined by these two essential graphs have different Bowen-Franks invariants, and hence they fail to be flow equivalent and fail to be **001**-equivalent by [MM14]. $G(2, 0)$ and G also fail to be **010**-equivalent since the stabilized fixed point algebras (cf. Theorem 2.2) they define are not isomorphic. Indeed they are the stationary AF algebras given by

$$[2] \quad \begin{bmatrix} 2 & 1 & 0 \\ 1 & 1 & 1 \\ 0 & 1 & 1 \end{bmatrix}$$

(in the latter case we use that p_0^G is a full projection) and it is easy to see by computing dimension groups that they differ. We conclude:

(4.11) $G(2, 0)$ and the result of applying **(C+)** to it are **100**- equivalent, but not **001**- or **010**-equivalent

4.2. Further examples.

Example 4.9. (The Kim-Roush example) Kim and Roush provide in [KR99] the first example of a pair of shift equivalent irreducible shifts of finite type which fail to be strong shift equivalent

$$\begin{bmatrix} 0 & 0 & 1 & 1 & 3 & 0 & 0 \\ 1 & 0 & 0 & 0 & 3 & 0 & 0 \\ 0 & 1 & 0 & 0 & 3 & 0 & 0 \\ 0 & 0 & 1 & 0 & 3 & 0 & 0 \\ 0 & 0 & 0 & 0 & 0 & 0 & 1 \\ 1 & 1 & 1 & 1 & 10 & 0 & 0 \\ 1 & 1 & 1 & 1 & 0 & 1 & 0 \end{bmatrix} \quad \begin{bmatrix} 0 & 0 & 1 & 1 & 3 & 0 & 0 \\ 1 & 0 & 0 & 0 & 0 & 0 & 0 \\ 0 & 1 & 0 & 0 & 0 & 0 & 0 \\ 0 & 0 & 1 & 0 & 0 & 0 & 0 \\ 0 & 0 & 0 & 0 & 0 & 0 & 1 \\ 4 & 5 & 6 & 3 & 10 & 0 & 0 \\ 4 & 5 & 6 & 3 & 0 & 1 & 0 \end{bmatrix},$$

finally disproving William’s conjecture. Involving deep results by Bratteli and Kishimoto on one hand and Carlsen and Rout on another, we show here how these examples are relevant for us. Indeed, since the systems are also primitive, we may appeal to Corollary 1.5 and Theorem 4.3 of [BK00] to see that the graphs G_1, G_2 defined by these two adjacency matrices are **010**-equivalent from the fact that they are shift equivalent. And by [CR17] we see that they fail to be **011**-equivalent.

It is straightforward to compute the Bowen-Franks invariants $(BF(G_i), \text{sgn det}(I - A_i))$ and the pointed K_0 -groups $(K_0(C^*(G_i)), [1_{C^*(G_i)}])$, and they turn out to be identical for the two examples, namely $(\mathbb{Z}/99\mathbb{Z}, -1)$ in the former case and $(\mathbb{Z}/99\mathbb{Z}, 66)$ in the latter. Because of this we conclude that G_1 is **101**-equivalent to G_2 . In fact both graphs are **101**-equivalent to $G(100, 32)$.

(4.12) There exist two graphs which are 010- and 101-equivalent,
but not 011-equivalent

Example 4.10. To see that the (P+) move is not 001-invariant, we note that if it had been, there would be 001-invariant moves between the pair of graphs



studied in [ERRS18]. However, we know this is not the case since the SFTs the graphs define are not flow equivalent. To see that it is not 010-invariant, apply (P+) to the graph

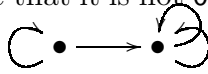

and argue as in Example 4.8.

5. GENERATING xyz-EQUIVALENCE BY MOVES

5.1. A conjecture.

Conjecture 5.1. *In all the six cases 000, 001, 011, 100, 101, 111, the equivalence relation is generated by those moves that leave the graphs invariant in the relevant sense. Explicitly:*

$$\begin{aligned} \overline{000} &= \langle (O), (I-), (R+), (S), (C+), (P+) \rangle \\ \overline{001} &= \langle (O), (I-), (R+), (S) \rangle \\ \overline{011} &= \langle (O), (I-) \rangle \\ \overline{100} &= \langle (O), (I+), (R+), (C+), (P+) \rangle \\ \overline{101} &= \langle (O), (I+), (R+) \rangle \\ \overline{111} &= \langle (O), (I+) \rangle \end{aligned}$$

Two of the statements are theorems. Indeed, we proved with Restorff and Sørensen:

Theorem 5.2 ([ERRS]). $\overline{000} = \langle (O), (I-), (R+), (S), (C+), (P+) \rangle$

Proof. In [ERRS] we proved that $\overline{000}$ is generated by the moves on the list

$$(O), (I), (R), (S), (C), (P)$$

so we need to establish that the moves not on both lists may be generated by the lists considered in the present paper. But $\langle (I) \rangle \subset \langle (I-) \rangle$ by definition, and each of the claims $\langle (R) \rangle \subset \langle (R+), (S) \rangle$, $\langle (C) \rangle \subset \langle (C+), (S) \rangle$, $\langle (P) \rangle \subset \langle (P+), (S) \rangle$ are obvious. \square

In a companion paper to the present one, joint with Arklint, we establish the corresponding claim for exact *-isomorphism:

Theorem 5.3 ([AER]). $\overline{100} = \langle (O), (I+), (R+), (C+), (P+) \rangle$

Remark 5.4. Our list of moves do not work in the case 010. Indeed, our only 010-invariant moves are $\langle (O), (I-) \rangle$, so that would entail

$$\overline{010} = \langle (O), (I-) \rangle \subseteq \overline{011} \subseteq \overline{010}$$

and hence that $\overline{010} = \overline{011}$. We know by Example 4.12 that this is not the case.

6. THE GAUGE SIMPLE CASE

In the remaining part of the paper we will establish partial evidence for the four other statements from Conjecture 5.1, focusing on the gauge simple case. We will establish our conjecture fully in the case when the graph is finite and defines a gauge simple graph C^* -algebra, and for all graph defining gauge simple graph C^* -algebras except in the cases 011 and 111.

The proofs we present in this section draw substantially on recent work by other authors, and in some cases work away from the gauge simple case. Our aim is to support our conjectures in the gauge simple case only, but we will succinctly indicate when the arguments carry further than what we need for that.

At the end of the section, we solve completely the case where the irreducible core of the graph is given by a single vertex, providing explicit recipes for changing one such graph into another by moves in all such cases, even when they are covered by more general results.

To organize our work, we recall the concept of *temperature* from [ERRS18]. Applied to a unital gauge simple graph C^* -algebra, it is defined as

$$\begin{cases} -2 & C^*(E) \text{ is not simple} \\ -1 & C^*(E) \text{ is finite-dimensional} \\ \text{rank } K_0(C^*(E)) - \text{rank } K_1(C^*(E)) & \text{otherwise} \end{cases}$$

The last type of temperature is never negative, and counts the number of infinite emitters in E . Thus the temperature 0 is indicative of finite graphs which define purely infinite C^* -algebras, i.e. the Cuntz-Krieger case. Our results may then be summarized as:

	-2	-1	0	≥ 1
<u>000</u>	Theorem 5.2			
<u>001</u>	Corollary 6.5	Corollary 6.4	Corollary 6.11	
<u>011</u>			Corollary 6.8	?
<u>100</u>	Theorem 5.3			
<u>101</u>	Corollary 6.5	Corollary 6.4	Theorem 6.2	
<u>111</u>			Theorem 6.1	?

The 111-generation question for the case of finite graphs with no sinks was solved by Aguyar Brix:

Theorem 6.1 ([Bri]). $\overline{111} = \langle (0), (I+) \rangle$ in the class of finite graphs with no sinks.

Note that simplicity plays no role in this result. By a refinement of the key result in [AER] we are also able to solve there the 101-generation question graphs defining simple C^* -algebras.

Theorem 6.2 ([AER]). $\overline{101} = \langle (0), (I+), (R+) \rangle$ in the class of graphs defining simple C^* -algebras.

We do not know how to do this in the presence of ideals. For the remaining cases, our approach is to simplify the graphs by appropriate moves before proving generation.

6.1. Reductions. When a graph E defines a gauge simple C^* -algebra $C^*(E)$ all vertices allowing a non-trivial path back to themselves are mutually connected. We define this as the *core* of the graph. We may hence usefully partition all vertices among sources,

transitional vertices and core vertices. Should there be a sink in E , it is unique and no vertex allows a path back to itself. In this case, the sink is also considered a part of the core.

Lemma 6.3. (111 standard form): *Without changing the core, it is possible to arrange*

- (1) *There is at most one source*
- (2) *Any transitional vertex emits exactly one edge*
- (3) *Any transitional or core vertex receives at most from one vertex outside the core which is not the source*
- (4) *Any core vertex c with the property that some core vertex c' emits only one edge, and the range of that edge is c ($c = c'$ is allowed) receives nothing from a transitional vertex.*

by applying moves (0) and (I+), and their inverses.

Proof. We first outsplit all transitional vertices and sources to obtain that they emit uniquely, arranging in particular for (2). For (3), we note that if any vertex receives from more than one transitional vertex, these several vertices have exactly the same future, and hence an (I+) move may shift all possible pasts to one of them, creating sources of the rest. A similar argument moves the past of any transitional vertex emitting to c as in (4) to c' . Of course it would be possible that c' itself was the range of a unique edge emitted from some c'' (this will in particular be the case when $c = c' = c''$), but then the argument is simply repeated. Since every step reduces the number of transitional vertices by at least one, the procedure must terminate. Finally, move (0) is applied in reverse to collect all sources to one. \square

Corollary 6.4. *In the class of graphs leading to C^* -algebras stably isomorphic to \mathbb{C} , all the equivalence relations \mathbf{xyz} are generated by those moves that leave the graphs invariant.*

Proof. Using Lemma 6.3 and moves (0) we may reduce to the graphs of the form $F(\underline{n})$ considered in Proposition 4.1, using 111-invariant moves and hence without changing the level of isomorphism. The proposition then establishes that when two such graphs are \mathbf{xyz} -isomorphic, there are \mathbf{xyz} -invariant moves to identical graphs. \square

This argument is easily extended to prove that any \mathbf{xyz} -isomorphism between finite-dimensional graph C^* -algebra is generated by \mathbf{xyz} -invariant moves.

Corollary 6.5. *In the class of graphs leading to C^* -algebras stably isomorphic to $C(\mathbb{T})$, all the equivalence relations \mathbf{xyz} are generated by those moves that leave the graphs invariant.*

Proof. Using Lemma 6.3, we may reduce to the graphs of the form $E(\underline{n})$ considered in Proposition 4.3, since no transitional vertices will exist because of (4). Thus, using 111-invariant moves and hence without changing the level of isomorphism, the proposition establishes that when two such graphs are \mathbf{xyz} -isomorphic, there are \mathbf{xyz} -invariant moves to identical graphs. \square

Lemma 6.6. (011 standard form): *Without changing the core, it is possible to arrange*

- (1) *Any regular source emits exactly one edge*
- (2) *Any transitional vertex receives exactly one edge and emits exactly one edge*
- (3) *Any core vertex receives at most from one vertex which is not in the core*
- (4) *Any core vertex c with the property that some core vertex c' emits only one edge, and the range of that edge is c ($c = c'$ is allowed) receives nothing from outside the core*

by applying moves (0) and (I-), and their inverses.

Proof. We first start by performing the moves in Lemma 6.3, but undo the last step so that all sources emit uniquely again. Since (I-) is now at our disposal, in any situation where a vertex receives from a transitional vertex as well as from a number of sources, we may simply erase all the sources by insplitting at the transitional vertex. This ensures (2) and (3), and arguing in the same way, we may also erase all sources emitting to a c as in (4). We can also shift any strand of transitional vertices ending at c back to c' , decreasing its length by one. Again, the argument may be repeated if necessary, and the procedure must stop since the number of sources is decreased at each stage. \square

Proposition 6.7. *If the core is not a sink, the graph may be replaced by a graph with no sources (and hence no transitional vertices) applying moves (0) and (I-), and their inverses.*

Proof. We have already dealt with cores that are simple cycles, so we may assume that some vertex emits more than one edge. Performing an outsplit at that vertex, we obtain at least one edge which is not a loop. Outsplitting again at the source of this edge, we obtain vertices c and c' in the position described in (4) of Lemma 6.6. Applying that lemma we now simplify the position of the transitional vertices and sources as specified.

We will reduce the total number of transitional vertices and sources by one as follows, maintaining throughout the property

(\dagger) There is at least one core vertex c_0 only receiving from the core

which holds from the outset at the vertex $c_0 = c$ from the previous paragraph. Fix a vertex v_1 not in the core which emits to c_1 in the core. Since the core is simply connected, there is a path from c_0 to c_1 , and somewhere on this path there are vertices c'_0 and c'_1 connected by one or several edges, so that c'_0 receives nothing from outside the core, but c'_1 receives from some v'_1 outside the core. Outsplitting at c'_0 we obtain a vertex c_2 emitting only one edge e , so that $r(e) = c'_1$. Since c'_0 does not receive from outside the core this will not affect the graph outside the core. We may now remove v'_1 as in Lemma 6.3 and shift the past of v'_1 , if any, to c_2 . In the resulting graph (\dagger) holds at c'_1 . \square

Corollary 6.8. $\overline{011} = \langle (0), (I-) \rangle$ in the class of finite graphs defining simple C^* -algebras.

Proof. The case where the graph algebras are finite-dimensional was dealt with in Corollary 6.4. By Proposition 6.7 we reduce the remaining case to graphs with neither sinks nor sources. It was proved in [CR17] that essential finite graphs that define 011-isomorphic graph C^* -algebras define conjugate shift of finite type, and by a classical result of Williams ([Wil73], [LM95]) this is the same as saying that one graph can be transformed into another by (0) and (I) moves. \square

With more work, this result extends to all finite graphs with no sinks, by extending Proposition 6.7 to allow the removal of all sources in general by working component-wise to remove sources and the transitional vertices connecting them to non-transitional vertices. Transitional vertices between pairs of nontransitional vertices do not need to be removed.

Lemma 6.9. (101 standard form): *Without changing the core, it is possible to arrange*

- (1) *There is at most one source*
- (2) *There are no transitional vertices*

by applying moves (O), (R+), and their inverses.

Proof. We may apply (R+) to remove all transitional vertices, and then collect all sources with a reverse (O) move. \square

Lemma 6.10. (001 standard form): *Without changing the core, it is possible to arrange*
 (1) *There are no sources (and hence no transitional vertices)*
by applying moves of type (S).

Proof. Remove each source by an (S) move. Repeat if necessary. \square

Corollary 6.11. $\overline{001} = \langle (O), (I-), (R+), (S) \rangle$ *in the class of graphs defining simple C^* -algebras.*

Proof. We have already dealt with the finite-dimensional case in Corollary 6.4. We may assume by Lemma 6.6 that the core is everything, and argue separately for the cases where there are no infinite emitters (temperature 0) and the case when there are (temperature ≥ 1). In the first case, we may appeal to [MM14] and see that when E and F are 001-equivalent, the graphs define flow equivalent shifts of finite type, and they are hence the same up to a finite number of applications of moves of the type (O), (I), and the classical reduction move in [PS75], which may be obtained using (R+) and (S) in conjunction. In the second case, we use [Sør13] which shows that move (C) is redundant in the presence of an infinite emitter. \square

6.2. Unicore case. As our final order of business, we will study explicitly the case when there is only one vertex in the core, and hence it is of the form $[c]$ with $c \in \{0, 1, 2, \dots, \infty\}$. We will establish Conjecture 5.1 in all such cases, by providing ad hoc arguments whenever it is not known to hold in general. Even when the results are known to hold for more general reasons, we will show explicitly which moves can be used to implement the isomorphism. It is clear from K -theory that c itself is an invariant up to 000-equivalence, so all that remains is to understand the impact of the non-core parts of the graphs. This case is closely related to the *polycephaly* case considered in the early work of Hazrat ([Haz13]) and we draw on several ideas from this paper.

Theorem 6.12. *Any form of xyz-equivalence among unicore graphs is generated by those moves that leave the graphs invariant in the appropriate sense.*

Proof.

CASE I: $c = 0$

We have already taken care of this in Corollary 6.4.

CASE II: $c = 1$

We have already taken care of this in Corollary 6.5.

CASE III: $c \in \{2, \dots\}$

We can reduce to Proposition 4.7 by 111-invariant moves as follows. First we organize the non-core part of the graph using Lemma 6.3, with the number of paths starting outside the core and ending inside it described by a vector $\underline{n} = (n_1, \dots, n_k)$. With a complete

out-split at the core we arrive at a graph of the form

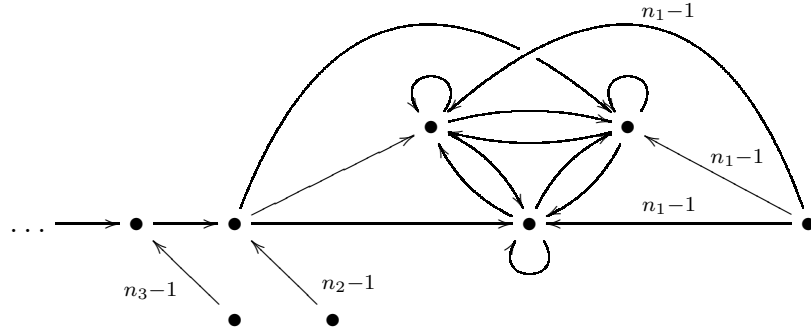

depicted here for $c = 3$, with the source emitting $n_1 - 1$ edges moved to the right hand side for legibility. Noting now that all the c vertices arising from the outsplit as well as the vertex receiving the $n_2 - 1$ edges from a source all have the same future, we perform an (I+) move to collect every incoming edge to these $c + 1$ vertices at one vertex (much as in the proof of Lemma 4.7(1)), leading to

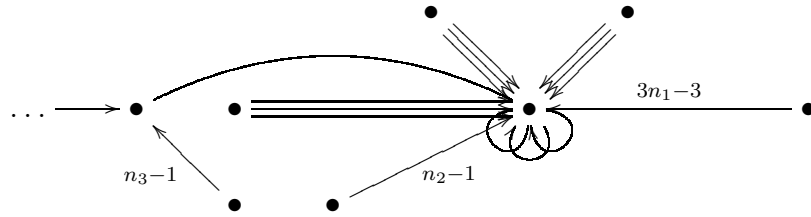

when $c = 3$. Reestablishing the standard form, the total number of paths of each length is transformed from \underline{n} to

$$(c(n_1 + c - 1) + n_2, n_3, \dots, n_k)$$

the key point being that this vector has only $k - 1$ entries. Repeating as necessary, we arrive at a graph in the form considered in Lemma 4.7, in which the claim has already been proved.

CASE IV: $c = \infty$

We use arrows of the form “ \Rightarrow ” to graphically indicate a countable infinite collection of parallel edges. In the 011 case, we will show that all the graphs may be reduced to $[\infty]$ using moves (0) and (I-). We already have by Lemma 6.6 a reduction to graphs of the form

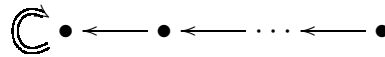

with $k + 1 \geq 1$ vertices in total. However, we have

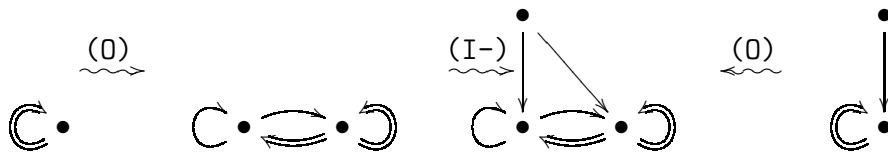

letting us pass between $k = 0$ and $k = 1$, and similarly we can start from any $k > 1$ and go

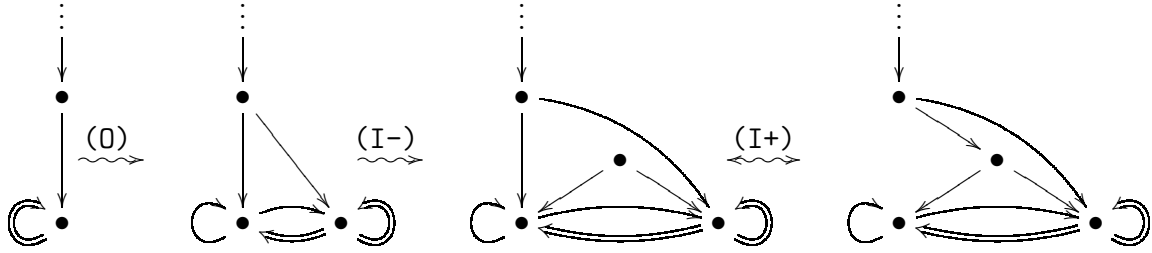

Note that the longest path ending at each core vertex to the right is now of length $k + 1$, so that when the standard form in Lemma 6.6 is reestablished, we get

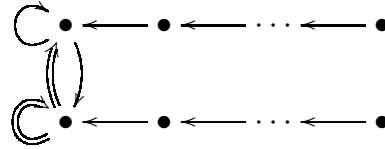

with a total of $2k + 4$ vertices. Performing out-amalgamations from right to left we get

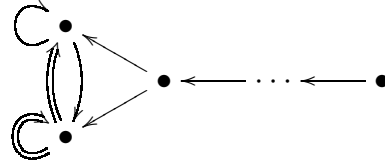

and eventually the standard form with $k + 2$ vertices in total.

For 10z-equivalence, we apply Lemma 6.9 to reduce to the form

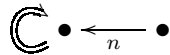

and note that n is contained in the K_0 -group of the C^* -algebra. For 11z we place the graph in the standard form $H(\underline{n})$ given by

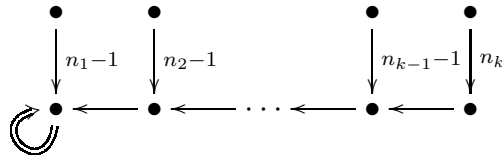

and use Corollary 2.5 see that the vector \underline{n} is given by the 11z-class. Indeed, exactly like in Proposition 4.1 the data given by the K -theory of $C^*(H(\underline{n}) \times_1 \mathbb{Z})$ with the translation and corner projection comes out to $\sum_{\mathbb{Z}} \mathbb{Z}$, the right shift map, and

$$(\dots, 0, 1, n_1, \dots, n_k, 0, \dots)$$

with the first non-zero entry at index 0, respectively. However, this time the K_0 -group is ordered lexicographically, so to prove that a map h as in Corollary 2.5 from the system defined by $H(\underline{n})$ to the system defined by $H(\underline{m})$ with $\underline{m} = (m_1, \dots, m_\ell)$ will force $\underline{n} = \underline{m}$ we must argue differently. By symmetry we may assume that $k \geq \ell$.

Since \mathbf{e}_0 is dominated by $[p_0^{\mathbf{H}(\underline{n})}]$ (because $n_1 > 0$ when $k > 0$), we see that $h(\mathbf{e}_0)$ is dominated by $[p_0^{\mathbf{H}(\underline{m})}]$ and hence we have that

$$h(\mathbf{e}_0) = \sum_{i=0}^s \beta_i \mathbf{e}_i$$

where we assume that $\beta_s \neq 0$ (we also know that the first non-zero β_i is positive). We get

$$h([p_0^{\mathbf{H}(\underline{n})}]) = h\left(\mathbf{e}_0 + \sum_{i=1}^k n_i \mathbf{e}_i\right) = \beta_0 \mathbf{e}_0 + (\beta_1 + \beta_0 n_1) \mathbf{e}_1 + \cdots + \beta_s n_k \mathbf{e}_{s+k}$$

and since this needs to coincide with $h([p_0^{\mathbf{H}(\underline{m})}])$ we conclude first that $s = 0$ and $k = \ell$ by the last entry, using our knowledge that $s + k \geq k \geq \ell$. The first entry tells us that $\beta_0 = 1$ and then it follows that $\underline{n} = \underline{m}$. \square

REFERENCES

- [AER] S.E. Arklint, S. Eilers, and E. Ruiz. Geometric classification of isomorphism of unital graph C^* -algebras. In preparation.
- [AER18] S.E. Arklint, S. Eilers, and E. Ruiz. A dynamical characterization of diagonal preserving $*$ -isomorphisms of graph C^* -algebras. *Ergodic Theory Dynam. Systems*, 38:2401–2421, 2018.
- [ALPS11] G. Abrams, A. Louly, E. Pardo, and C. Smith. Flow invariants in the classification of Leavitt path algebras. *J. Algebra*, 2011.
- [AR15] S.E. Arklint and E. Ruiz. Corners of Cuntz-Krieger algebras. *Trans. Amer. Math. Soc.*, 367:7595–7612, 2015.
- [BC] K.A. Brix and T.M. Carlsen. Cuntz-Krieger algebras and one-sided conjugacy of shifts of finite type and their groupoids. To appear in *J. Austr. Math. Soc.*, DOI: <https://doi.org/10.1017/S1446788719000168>.
- [BCW17] N. Brownlowe, T.M. Carlsen, and M.F. Whittaker. Graph algebras and orbit equivalence. *Ergodic Theory Dynam. Systems*, 37:389–417, 2017.
- [BK00] O. Bratteli and A. Kishimoto. Trace scaling automorphisms of certain stable AF algebras. II. *Q. J. Math.*, 51(2):131–154, 2000.
- [BP04] T. Bates and D. Pask. Flow equivalence of graph algebras. *Ergodic Theory Dynam. Systems*, 24(2):367–382, 2004.
- [Bri] K.A. Brix. Eventual conjugacy and the balanced in-split. Private communication.
- [CEOR19] T.M. Carlsen, S. Eilers, E. Ortega, and G. Restorff. Continuous orbit equivalence and flow equivalence of reducible shifts of finite type. *J. Math. Anal. Appl.*, 469:1088–1110, 2019.
- [CR17] T.M. Carlsen and J. Rout. Diagonal-preserving gauge-invariant isomorphisms of graph C^* -algebras. *J. Funct. Anal.*, 273:2981–2993, 2017.
- [Cri08] T. Crisp. Corners of graph algebras. *J. Operator Theory*, 60(2):253–271, 2008.
- [CRS17] T.M. Carlsen, E. Ruiz, and A. Sims. Equivalence and stable isomorphism of groupoids, and diagonal-preserving stable isomorphisms of graph C^* -algebras and Leavitt path algebras. *Proc. Amer. Math. Soc.*, 145(4):1581–1592, 2017.
- [CRST] T.M. Carlsen, E. Ruiz, A. Sims, and M. Tomforde. Reconstruction of groupoids and C^* -rigidity of dynamical systems. arXiv:1711.01052.
- [Cun86] J. Cuntz. The classification problem for the C^* -algebras \mathcal{O}_A . In *Geometric methods in operator algebras (Kyoto, 1983)*, volume 123 of *Pitman Res. Notes Math. Ser.*, pages 145–151. Longman Sci. Tech., Harlow, 1986.
- [CW18] T.M. Carlsen and M.L. Winger. Orbit equivalence of graphs and isomorphism of graph groupoids. *Math. Scand.*, 123(2):239–248, 2018.
- [ERRS] S. Eilers, G. Restorff, E. Ruiz, and A.P.W. Sørensen. The complete classification of unital graph C^* -algebras: Geometric and strong. Submitted for publication.
- [ERRS17] S. Eilers, G. Restorff, E. Ruiz, and A.P.W. Sørensen. Invariance of the Cuntz splice. *Math. Ann.*, 369:1061–1080, 2017.

- ERRS18 S. Eilers, G. Restorff, E. Ruiz, and A.P.W. Sørensen. Geometric classification of graph C^* -algebras over finite graphs. *Canad. J. Math.*, 12:294–353, 2018.
- FLR00 N.J. Fowler, M. Laca, and I. Raeburn. The C^* -algebras of infinite graphs. *Proc. Amer. Math. Soc.*, 128(8):2319–2327, 2000.
- Haz13 R. Hazrat. The graded Grothendieck group and the classification of Leavitt path algebras. *Math. Ann.*, 355:273–325, 2013.
- Hua94 D. Huang. Flow equivalence of reducible shifts of finite type. *Ergodic Theory Dynam. Systems*, 14(4):695–720, 1994.
- KR99 K. H. Kim and F. W. Roush. The Williams conjecture is false for irreducible subshifts. *Ann. of Math.*, 149:545–558, 1999.
- LM95 D. Lind and B. Marcus. *An introduction to symbolic dynamics and coding*. Cambridge University Press, Cambridge, 1995.
- Mat10 K. Matsumoto. Orbit equivalence of topological markov shifts and cuntz–krieger algebras. *Pacific J. Math.*, pages 199–225, 2010.
- Mat17 K. Matsumoto. Uniformly continuous orbit equivalence of Markov shifts and gauge actions on Cuntz-Krieger algebras. *Proc. Amer. Math. Soc.*, 145(3):1131–1140, 2017.
- Mat18 K. Matsumoto. A short note on Cuntz splice from a viewpoint of continuous orbit equivalence of topological Markov shifts. *Math. Scand.*, 123(1):91–100, 2018.
- MM14 K. Matsumoto and H. Matui. Continuous orbit equivalence of topological Markov shifts and Cuntz-Krieger algebras. *Kyoto J. Math.*, 54(4):863–877, 2014.
- PS75 B. Parry and D. Sullivan. A topological invariant of flows on 1-dimensional spaces. *Topology*, 14(4):297–299, 1975.
- Rae05 I. Raeburn. *Graph algebras*, volume 103 of *CBMS Regional Conference Series in Mathematics*. Published for the Conference Board of the Mathematical Sciences, Washington, DC, 2005.
- Rør95 M. Rørdam. Classification of Cuntz-Krieger algebras. *K-Theory*, 9(1):31–58, 1995.
- Sør13 A.P.W. Sørensen. Geometric classification of simple graph algebras. *Ergodic Theory Dynam. Systems*, 33(4):1199–1220, 2013.
- Szy02 W. Szymański. General Cuntz-Krieger uniqueness theorem. *Internat. J. Math.*, 13:549–555, 2002.
- Wil73 R. F. Williams. Classification of subshifts of finite type. *Ann. of Math*, 98:120–153, 1973.
- Wil07 D. P. Williams. *Crossed products of C^* -algebras*, volume 134 of *Mathematical Surveys and Monographs*. American Mathematical Society, Providence, RI, 2007.

DEPARTMENT OF MATHEMATICAL SCIENCES, UNIVERSITY OF COPENHAGEN, UNIVERSITETSPARKEN 5, DK-2100 COPENHAGEN, DENMARK
E-mail address: eilers@math.ku.dk

DEPARTMENT OF MATHEMATICS, UNIVERSITY OF HAWAII, HILO, 200 W. KAWILI ST., HILO, HAWAII, 96720-4091 USA
E-mail address: ruize@hawaii.edu