

Development and Evaluation of Least Square Satellite Tracking in Real Antenna Control System

Thiago Sarmento, Andrey Nakamura, Itelo Filho, Lucas Correa,
Marcos Takeda, Adalbery Castro, Aldebaro Klautau

Abstract—This work describes the implementation of a satellite tracking technique in a real antenna control system. The technique uses least squares estimation to search for the best antenna pointing position to receive the satellite beacon signal tracked in the 2D region created by the motion axes. The work also presents the technique implementation results in the real system to prove its operation with the beacon signal intensity and the orbit obtained with the search over time.

Keywords—Satellite tracking technique, Real antenna control system, Least squares.

I. INTRODUCTION

The satellites are essential for global communications, enabling new possibilities and applications never imagined before. However, like all technologies, the satellite communications show challenges to be overcome. One of these problems is in maintaining the antenna's pointing in the best reception position of the satellite signal. Satellite tracking techniques are widely used in earth stations antenna control systems [6] to improve signal reception of near geosynchronous satellites. Most algorithms are based on both search and optimization algorithms applied to antenna pointing angles and a beacon signal.

The Satellites have a beacon signal, serving as a reference for reception of antennas. This signal is used by the algorithms for the tracking of its orbit, and the satellites studied in this work are the geostationary orbits inclined [9]. The objective of these tracking techniques is to maximize the beacon signal reception with respect to the azimuth and elevation angles. As satellites keeps moving, searches must be done several times a day.

II. LEAST SQUARES

In [7] a least squares framework is devised by modeling the beacon signal level near the optimal pointing angle as a 2D parabola. The algorithm uses a square movement pattern to perform measurements. At each corner the antenna stops by a predetermined time and then a beacon measurement is made and stored, along with its azimuth and elevation. This data is then used to estimate a 2D parabola by the least squares method.

Andrey Nakamura, Itelo Filho, Lucas Correa, Thiago Sarmento, Marcos Takeda, Adalbery Castro and Aldebaro Klautau are with Federal University of Para, Belem, Brazil (e-mails: {thiago.sarmento, andrey.nakamura, lucas.correa, marcos.takeda}@itec.ufpa.br, {itelo, adalbery, aldebaro}@ufpa.br).

The beacon model is given by the parabola equation

$$L(x, y) = K_x(x - p)^2 + K_y(y - q)^2 + L_{pq} \quad (1)$$

where K_x and K_y are the quadratic coefficients for azimuth and elevation, respectively. x and y are the measurement angles, p and q are the satellite direction, L_{pq} is the maximum beacon signal and $L(x, y)$ is the beacon level at pointing angle (x, y) .

By expanding (1) one can write

$$L(x, y) - K_x x^2 - K_y y^2 = -2K_x x p - 2K_y y q + L_{pq} + K_x p^2 + K_y q^2 \quad (2)$$

and then defining

$$\beta^T = [-2K_x p \quad -2K_y q \quad (L_{pq} + K_x p^2 + K_y q^2)] \quad (3)$$

$$X_i = [x_i \quad y_i \quad 1] \quad (4)$$

$$Y_i = L(x_i, y_i) - K_x x_i^2 - K_y y_i^2 \quad (5)$$

where, at each time instant, sensors provide samples x_i, y_i and $L(x_i, y_i)$ from azimuth resolver, elevation resolver and beacon receiver, respectively.

We can then rewrite (2) simply as

$$Y = X\beta \quad (6)$$

where Y is a $N \times 1$ matrix and X is a $N \times 3$ matrix, with N being the number of samples. Each row of Y is Y_i and each row of X is X_i , i varying from 1 to N . The least squares solution is then given by the well-known equation

$$\beta = (X^T X)^{-1} X^T Y \quad (7)$$

and we can retrieve the satellite position and beacon level by

$$p = -\frac{\beta_1}{2K_x} \quad (8)$$

$$q = -\frac{\beta_2}{2K_y} \quad (9)$$

$$L_{pq} = \beta_3 - K_x p^2 - K_y q^2. \quad (10)$$

One drawback of this linear approach is that the values of K_x and K_y must be known before hand. In [7], K_x is calculated as $K_x = K_y \cos^2(h_0)$, where h_0 is the elevation of the satellite position, but K_y is still needed. For our setup we managed to estimate $K_y \approx -11.4$, and K_x is in the range $[-1.2 - 1.0]$ depending on the actual elevation position.

III. RECURSIVE LEAST SQUARES (RLS)

The RLS algorithm can perform least squares in a filter form, avoiding matrix inversion and adding an exponential weighting function which decreases the weights for older samples. The advantage is that using a filter form, we can estimate the parabola by storing only the filter state. Also, the weighting function can help to model the satellite movement occurring while estimation is performed.

The RLS algorithm is given by

$$Q = \frac{P_{i-1}}{\lambda + X_i P_{i-1} X_i^T} \quad (11)$$

$$K = Q X_i^T \quad (12)$$

$$\hat{Y}_i = X_i \beta_{i-1} \quad (13)$$

$$e = Y_i - \hat{y}_i \quad (14)$$

$$\beta_i = \beta_{i-1} + K e \quad (15)$$

$$P_i = \frac{1}{\lambda} (I - K X_i) P_{i-1} \quad (16)$$

where P is a positive-definite matrix, x is a vector with input data, β is a vector with the estimated model coefficients and λ is the forgetting factor.

The forgetting factor λ is a constant between 0 and 1 which defines the weight of past samples in the estimation. Defining $\tau = \frac{1}{1-\lambda}$ as the memory horizon of the RLS algorithm, samples older than τ have small weights in the algorithm. For example, $\lambda = 0.98$ gives $\tau = 50$ samples. For $\lambda = 1$, the memory horizon is infinite, yielding the same estimation of the regular least squares, as every sample has the same weight.

IV. TRACKING ALGORITHM

Tracking is performed in a timed basis in order to minimize antenna movement, reducing mechanical wear and tear. The tracking algorithm in this work has four steps:

- 1) Perform a displacement pattern on the neighborhood of the actual position to acquire data
- 2) Estimate the optimal position with acquired data using
- 3) Move to the estimated position
- 4) Wait for the next tracking cycle

The displacement pattern used is mostly the same from [7] and reproduced in Figure 1, the only difference is that in this work we adapted to a rectangle instead of a square. This is because we observed different variations on each axis, so we can adjust accordingly.

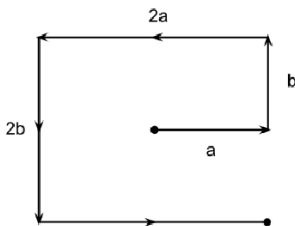

Fig. 1

DISPLACEMENT MOVEMENT PATTERN.

One key difference is that in [7] the measurements are only made at the vertices of the square, but in our setup these measurements are taken every 20 ms, thus increasing the number of samples needed to be stored by the conventional least squares, while in RLS this is not a problem due to the filter form of the algorithm.

V. ANTENNA SETUP

The antenna used, shown in the Figure 2, is parabolic measuring 3 meters and having 3 axes of freedom (azimuth, elevation and polarization), which is installed in the Guamá STP (Science and Technology Park) belonging to LASSE (Telecommunications, Automation and Electronics Research and Development Center).



Fig. 2

3 AXES ANTENNA INSTALLED IN THE GUAMÁ STP.

The antenna receives the satellite signal, which passes the signal to LNB (Low Noise Block) which makes RF to IF down conversion of signal, and thus transmits this signal to the beacon receiver [5] via cable. The received signal from the beacon receiver is linearized to a voltage range of 0 to 10 V which is directly proportional to the intensity of the satellite beacon signal. This antenna is part of a project to develop a system to automatically control the antennas movement to make possible the satellite tracking with the techniques implementation.

The antenna monitoring and control system is designed to control 3-axis antennas (azimuth, elevation and polarization), controlling the antenna movement manually or automatically. The system is also responsible for monitoring the beacon signal strength, correcting the antenna pointing position for best reception, using the tracking techniques developed to control the antenna. The system consists of an antenna power unit (APU) and antenna control unit (ACU), the layout of which can be seen in Figure 3.

The APU is responsible for activation and/or controlling the electrical components of the system, controlling the movement of the antenna through the azimuth, lift and polarization axis motors. The ACU has the system control function, sending instructions to the APU and performing the available tracking techniques, as well as storing settings and other important information such as position register and beacon signal strength.

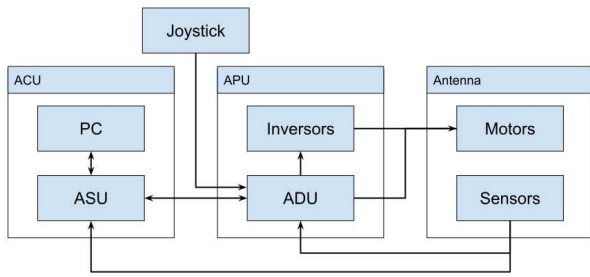

Fig. 3

ANTENNA MONITORING AND CONTROL SYSTEM OVERVIEW.

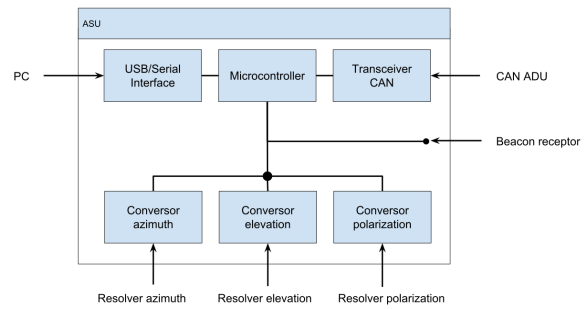

Fig. 5

ANTENNA CONTROL UNIT DIAGRAM.

A. Antenna Power Unit

The antenna power unit is responsible for the control of the electrical components of the system such as inverters and motors of the antenna, reading of sensors installed in the antenna and the electrical board, communication with the ACU and Joystick for receiving commands and sending of system status and actions of that are taken in emergency situations.

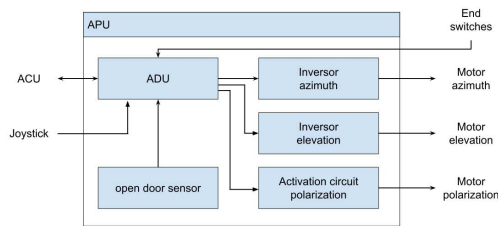

Fig. 4

ANTENNA POWER UNIT DIAGRAM.

The Antenna Drive Unit (ADU) was the prototype developed in project to control the handling functions. The microcontroller [1] used in ADU reads the sensors connected to it, sends status to ACU and receives move instructions for activating the antenna inverters and motors through the CAN (Controller Area Network) interface.

B. Antenna Control Unit

The antenna control unit is responsible for the intelligence of the system, sending instructions for moving to the APU, which can come from user interaction through the graphical interface, already configured satellite tracking techniques or emergency situations.

The computer is responsible for running software that monitors all system operations, stores system settings, runs available trace techniques, and receives user commands through the GUI (Graphical User Interface). The ASU Antenna Sensors Unit was the prototype developed in the project to read the sensors and promote ACU communication with the ADU. The data received by ADU and the values read in the resolvers

[2], [3] and beacon receiver sensors are sent to the PC and it responds with commands to be passed. The ASU makes the connection between the computer located on ACU and APU, receiving the messages and passing the commands. In order to communicate with ADU, ASU uses the available CAN interface on its microcontroller, and to communicate with the computer it has a USB/Serial converter to interface with. The microcontroller must also read the sensors connected to ACU to pass the data to the computer. All activities performed by ASU must be performed in real time, updating both the PC with the data collected on system status and ADU on commands related to the antenna movement.

VI. TRACKING RESULTS

In our tests, our system tracked the Brasilsat B3 satellite [4], which is in inclined orbit. Running our system for approximately 24 hours, we obtained a data log from the antenna control system containing information about azimuth, elevation and beacon levels.

Figure 6 shows the tracking trajectory for our algorithm, showing the movement pattern of the measurement phase, and then moving to the maximizing position. The overall trajectory shape is, as expected, a figure 8 shape, frequently observed for inclined orbit satellites.

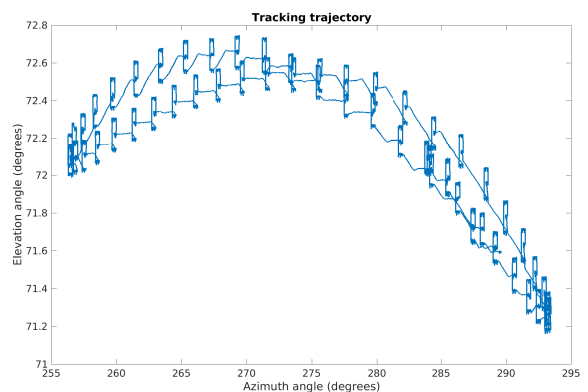

Fig. 6

TRACKING TRAJECTORY.

Figure 8 and 9 shows the azimuth and elevation angles over time. The discontinuities are caused by the tracking algorithm, which adjust the antenna every tracking cycle. We can note that the azimuth angle variation is greater than 30 degrees while the variation in elevation angle is smaller than 2 degrees, this is because our earth station location relative to the satellite. The inclined orbit makes the satellite move in the north-south direction as seen in Figure 7, and as our earth station is near the equator line, most of the satellite movement is in the azimuth angle of our antenna.

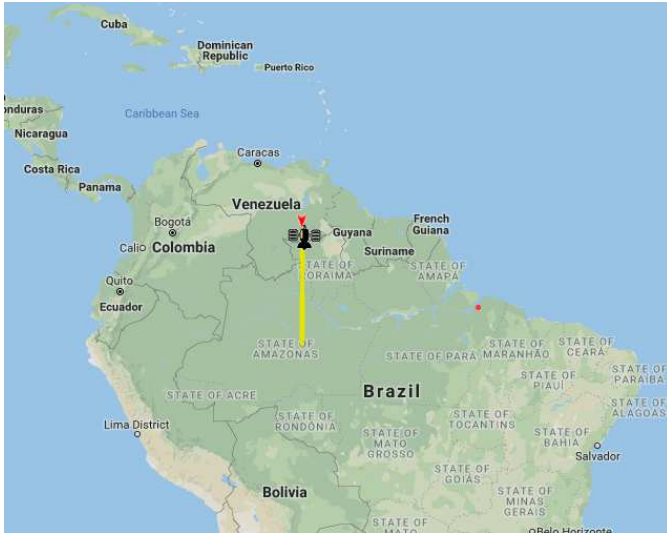

Fig. 7
N2Y0 ORBIT TRACKING [8].

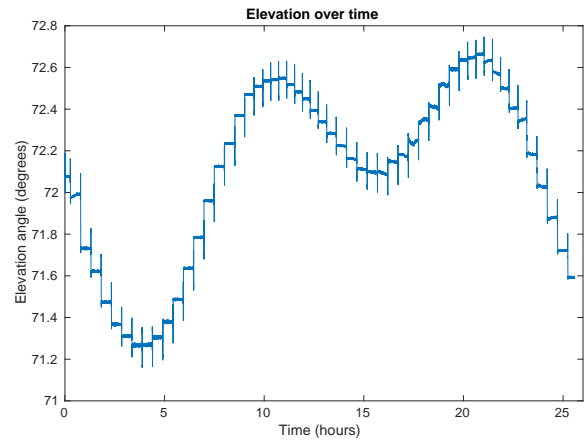

Fig. 9
ELEVATION ANGLE OVER TIME.

a higher value. Variations in the upper level are due to weather conditions, temperature and time of day.

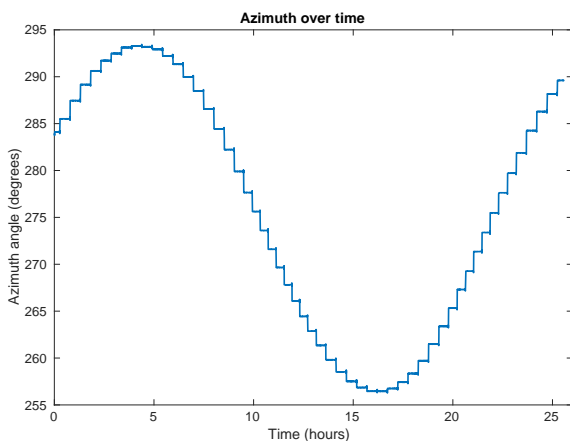

Fig. 8
AZIMUTH ANGLE OVER TIME.

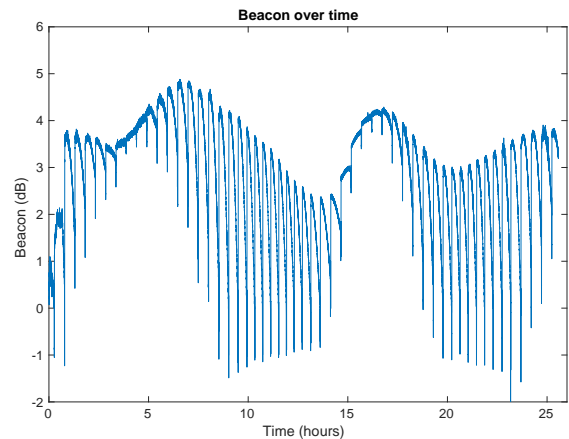

Fig. 10
BEACON SIGNAL LEVEL OVER TIME.

VII. CONCLUSIONS

The results obtained show that the least squares technique implemented in the real antenna control system is able to track the Brasilsat B3 satellite satisfactorily, confirming the work of [7]. Also, the adaptation described in this paper with the use of RLS performed well, removing the need for matrix inverses and increasing the adaptability of the model due to the forgetting factor.

ACKNOWLEDGEMENTS

The authors would like to thank BrasilSAT Harald S/A for their support during the project development.

Figure 10 shows the beacon signal level over time. The lowest beacon level in our setup is around -24 dB. In this test we achieved a mean beacon level of 2.89 dB, and a standard deviation of 1.15 dB. The beacon level reduction happens because the antenna remains stopped until the next tracking cycle. The tracking algorithm then restores the beacon level to

REFERENCES

- [1] AVR. *8-bit Microcontroller with 32K/64K/128K Bytes of ISP Flash and CAN Controller*, 2014.
- [2] Research Concepts. *Synchro-Brushless Resolver Clifton Precision Model 11-BHW-48F/F662*, 2001.
- [3] Analog Devices. *Variable Resolution, 10-Bit to 16-Bit R/D Converter with Reference Oscillator*, 2008.
- [4] Diretoria de Engenharia. Características do Satélite Brasilsat B3 em Órbita Inclinada, para Projeto Técnico de Redes de Comunicações Digitais em Banda C. Technical report, Embratel Star One.
- [5] General Dynamics. *Digital Tracking Receiver*, 2012.
- [6] GJ Hawkins, DJ Edwards, and JP McGeehan. Tracking systems for satellite communications. In *IEE Proceedings F (Communications, Radar and Signal Processing)*, volume 135, pages 393–407. IET, 1988.
- [7] J. I. Laine. 2d model-based step-track procedure. *IEEE Transactions on Aerospace and Electronic Systems*, 36(4):1386–1391, Oct 2000.
- [8] n2yo. live real time satellite tracking and predictions: brasilsat b3, March 2018.
- [9] John E Prussing and Bruce A Conway. *Orbital mechanics*. Oxford University Press, USA, 1993.