

IRREDUCIBILITY OF THE WYSIWYG REPRESENTATIONS OF THOMPSON'S GROUPS.

VAUGHAN F. R. JONES

ABSTRACT. We prove irreducibility and mutual inequivalence for certain unitary representations of R. Thompson's groups F and T .

1. INTRODUCTION

Let F and T be the Thompson groups as usual. In [10] an action of F was shown to arise from a *functor* from the category \mathcal{F} whose objects are natural numbers and whose morphisms are planar binary forests, to another category \mathcal{C} . Forests decorated with cyclic permutations of their leaves give a category \mathcal{T} for which functors from \mathcal{T} give actions of T .

The representations studied in [10] came from functors Φ to a trivalent tensor category (planar algebra) \mathcal{C} in the sense of [12], based on a specific "vacuum vector" Ω in the 1-box space of the tensor category. A Thompson group element g is represented by a pair of binary planar trees (see [4]), drawn in the plane with one tree upside down on top of the other as below for an element of F that we will call D :

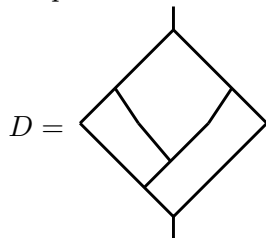

The standard dyadic intervals defined by the leaves of the bottom tree are sent by g (in the only affine way possible) to the corresponding intervals for the top tree.

If π is the unitary representation defined by the (suitably normalised) trivalent vertex in \mathcal{C} , the coefficient

$$\langle \pi(g)\Omega, \Omega \rangle$$

is simply equal to the pair of trees of g interpreted as a planar diagram (tangle) for \mathcal{C} !! (Or more correctly the pair of trees as drawn is a multiple of a single vertical straight line and that multiple is $\langle \pi(g)\Omega, \Omega \rangle$.) For this reason we will call these representations, on the closure of the F -linear span of Ω , the Wysiwyg (what you see is what you get) representations of the Thompson groups. It is plausible that all the Wysiwyg representations are irreducible, indeed the entire family of unitary representations defined in [10] and [9] could all be irreducible. Until this paper the

only examples where irreducibility could be shown were when the representation was *induced* from a subgroup. Then the problem becomes one of calculating the commensurator of that subgroup. This was done in [6] and [13].

In this paper we will show that if we change the vacuum vector slightly then all the Wysiwyg representations are irreducible. The proof will not be difficult but comes from a remarkable piece of luck involving this new vacuum Ψ . To wit, Ψ is fixed by the usual generator A of F and any other fixed vector by A is a multiple of Ψ . This immediately implies the representation is irreducible on the closed F -linear span of Ψ . (More information on the spectral measure of elements of F can be found in [1].)

Since these fixed vectors are canonical, any numerical data calculated from them are invariants of the representation. In this way we are able to show that these Wysiwyg representations are mutually inequivalent for different values of the parameter d of the category \mathcal{C} . This was also unknown before, even for the induced representations.

A more "elementary" way to get unitary representations is developed in [3] where the tensor category is Hilbert spaces with direct sum as tensor product. Here too the coefficients of the vacuum vector are given simply by the pair of trees as above, but interpreted as morphisms in the category. Little is known about irreducibility in this situation.

2. DEFINITIONS

A binary planar forest is the isotopy class of a disjoint union of binary trees embedded in \mathbb{R}^2 all of whose roots lie on $(\mathbb{R}, 0)$ and all of whose leaves lie on $(\mathbb{R}, 1)$. The isotopies are supported in the strip $(\mathbb{R}, [0, 1])$. Binary planar forests form a category in the obvious way with objects being \mathbb{N} whose elements are identified with isotopy classes of sets of points on a line and whose morphisms are the forests which can be composed by stacking a forest in $(\mathbb{R}, [0, 1])$ on top of another, lining up the leaves of the one on the bottom with the roots of the other by isotopy then rescaling the y axis to return to a forest in $(\mathbb{R}, [0, 1])$. The structure is of course actually combinatorial but it is very useful to think of it in the way we have described.

We will call this category \mathcal{F} .

Definition 2.0.1. Fix $n \in \mathbb{N}$. For each $i = 1, 2, \dots, n$ let f_i be the planar binary forest with n roots and $n + 1$ leaves consisting of straight lines joining $(k, 0)$ to $(k, 1)$ for $1 \leq k \leq i - 1$ and $(k, 0)$ to $(k + 1, 1)$ for $i + 1 \leq k \leq n$, and a single binary tree with root $(i, 0)$ and leaves $(i, 1)$ and $(i + 1, 1)$ thus:



Note that any element of \mathcal{F} is in an essentially unique way a composition of morphisms f_i , the only relation being $\Phi(f_j)\Phi(f_i) = \Phi(f_i)\Phi(f_{j-1})$ for $i < j - 1$. The

set of morphisms from 1 to n in \mathcal{F} is the set of binary planar rooted trees \mathfrak{T} and is a *directed set* with $s \leq t$ iff there is and $f \in \mathcal{F}$ with $t = fs$.

Given a functor $\Phi : \mathcal{F} \rightarrow \mathcal{C}$ to a category \mathcal{C} whose objects are sets, we define the direct system S_Φ which associates to each $t \in \mathfrak{T}$, $t : 1 \rightarrow n$, the set $\Phi(\text{target}(t)) = \Phi(n)$. For each $s \leq t$ we need to give ι_s^t . For this observe that there is an $f \in \mathcal{F}$ for which $t = fs$ so we define

$$\iota_s^t(\kappa) = \Phi(f)$$

which is an element of $\text{Mor}_{\mathcal{C}}(\Phi(\text{target}(s)), \Phi(\text{target}(t)))$ as required. The ι_s^t trivially satisfy the axioms of a direct system.

As a slight variation on this theme, given a functor $\Phi : \mathcal{F} \rightarrow \mathcal{C}$ to any category \mathcal{C} , and an object $\omega \in \mathcal{C}$, form the category \mathcal{C}^ω whose objects are the sets $\text{Mor}_{\mathcal{C}}(\omega, \text{obj})$ for every object obj in \mathcal{C} , and whose morphisms are composition with those of \mathcal{C} . The definition of the functor $\Phi^\omega : \mathcal{F} \rightarrow \mathcal{C}^\omega$ is obvious. Thus the direct system S_{Φ^ω} associates to each $t \in \mathfrak{T}$, $t : 1 \rightarrow n$, the set $\text{Mor}_{\mathcal{C}}(\omega, \Phi(n))$. Given $s \leq t$ let $f \in \mathcal{F}$ be such that $t = fs$. Then for $\kappa \in \text{Mor}_{\mathcal{C}}(\omega, \Phi(\text{target}(s)))$,

$$\iota_s^t(\kappa) = \Phi(f) \circ \kappa$$

which is an element of $\text{Mor}_{\mathcal{C}}(\omega, \Phi(\text{target}(t)))$.

As in [10] we consider the direct limit:

$$\lim_{\rightarrow} S_\Phi = \{(t, x) \text{ with } t \in \mathfrak{T}, x \in \Phi(\text{target}(t))\} / \sim$$

where $(t, x) \sim (s, y)$ iff there are $r \in \mathfrak{T}$, $z \in \Phi(\text{target}(z))$ with $t = fr$, $s = gr$ and $\Phi(f)(x) = z = \Phi(g)(y)$.

We use $\frac{t}{x}$ to denote the equivalence class of (t, x) mod \sim .

The limit $\lim_{\rightarrow} S_\Phi$ will inherit structure from the category \mathcal{C} . For instance if the objects of \mathcal{C} are Hilbert spaces and the morphisms are isometries then $\lim_{\rightarrow} S_\Phi$ will be a pre-Hilbert space which may be completed to a Hilbert space which we will also call the direct limit unless special care is required.

As was observed in [10], if we let Φ be the identity functor and choose ω to be the tree with one leaf, then the inductive limit consists of equivalence classes of pairs $\frac{t}{x}$ where $t \in \mathcal{T}$ and $x \in \Phi(\text{target}(t)) = \text{Mor}(1, \text{target}(t))$. But $\text{Mor}(1, \text{target}(t))$ is nothing but $s \in \mathcal{T}$ with $\text{target}(s) = \text{target}(t)$, i.e. trees with the same number of leaves as t . Thus the inductive limit is nothing but the Thompson group F with group law

$$\frac{r}{s} \frac{s}{t} = \frac{r}{t}.$$

Moreover for any other functor Φ , $\lim_{\rightarrow} S_\Phi$ carries a natural action of F defined as follows:

$$\frac{s}{t} \left(\frac{t}{x} \right) = \frac{s}{x}$$

where $s, t \in \mathfrak{T}$ with $\text{target}(s) = \text{target}(t) = n$ and $x \in \Phi(n)$. A Thompson group element given as a pair of trees with m leaves, and an element of $\lim_{\rightarrow} S_\Phi$ given as a

pair (tree with n leaves, element of $\Phi(n)$), may not be immediately composable by the above formula, but they can always be “stabilised” to be so within their equivalence classes.

The Thompson group action preserves the structure of $\varinjlim S_\Phi$ so for instance in the Hilbert space case the representations are unitary.

3. THE WYSIWYG REPRESENTATIONS.

We are especially interested in applying the construction of the previous section when \mathcal{C} is the category of bifinite bimodules (correspondences in the sense of Connes) over a von Neumann algebra M - [5]. Here we begin with a Hilbert space \mathcal{H} which is a binormal bimodule for M and form the category whose objects are the relative tensor powers $\otimes_M^n \mathcal{H}$ which are also $M - M$ bimodules. The morphisms of the category are $M - M$ bimodule maps. We will for simplicity restrict to certain such bimodule categories which have been described simply diagrammatically in [12]. To be precise:

Definition 3.0.1. For $d \in \{4\cos^2\pi/n - 1 | n = 4, 5, 6, \dots\} \cup [3, \infty)$ let \mathcal{C} be the trivalent (tensor) category described in [12] with objects 1 and $\otimes^n X$ for $n \geq 0$, with $\otimes^0 X = 1$, for a privileged object X .

By definition \mathcal{C}_n is $Mor(1, \otimes^n X)$ which is the finite dimensional Hilbert space of linear combinations of tangles with n boundary points and an arbitrary number of trivalent vertices, modulo the skein relations given in [12], and the kernel of the natural positive semidefinite Hermitian form. We have $dim(\mathcal{C}_0) = 1, dim(\mathcal{C}_1) = 0, dim(\mathcal{C}_2) = 1$ and $dim(\mathcal{C}_3) = 1$.

Here the object 1 may be realised as $L^2(M)$ for a von Neumann algebra M and X would be some given $M - M$ correspondence.

The category \mathcal{C} is by definition generated by an element in \mathcal{C}_3 . Although [12] does not address unitarity issues, by realising \mathcal{C} as a cabled Temperley-Lieb category as described in [12], \mathcal{C} has a $*$ -structure with positive definite inner product. The generator Y of [12] is then defined naturally from Temperley-Lieb and is invariant under the rotation. \mathcal{C} can also be realised as a category of correspondences over hyperfinite factors-[8]. (Indeed all of our considerations will apply to categories of $M - M$ bimodules generated by \mathcal{H} with suitable irreducibility and self-duality conditions, and an appropriate $M - M$ bilinear $Y : \mathcal{H} \rightarrow \mathcal{H} \otimes_M \mathcal{H}$ with $Y^*Y = 1$.)

Definition 3.0.2. $Mor_{\mathcal{C}}(1, X \otimes X)$ is spanned by a single tangle consisting of a string joining the 2 boundary points. We will normalise this tangle by dividing it by \sqrt{d} and call the resulting unit vector Ψ .

$Mor_{\mathcal{C}}(X, X \otimes X)$ is spanned by a single tangle consisting of the trivalent vertex. By our normalisation it is a unit vector. We will call it Ω .

The above choice of Y gives a functor from the category of binary planar forests to \mathcal{C} as described in [10]. The relation 2.1 of [12] implies that the connecting maps ι_s^t are isometries. So we obtain two categories \mathcal{C}^1 and \mathcal{C}^X and direct systems S_{Φ^1} and

S_{Φ^x} . Thompson's groups F and T act unitarily on the Hilbert spaces \mathfrak{H}_Y^1 and \mathfrak{H}_Y^X obtained as the (completions of the) direct limits $\lim_{\rightarrow} S_{\Phi^1}$ and $\lim_{\rightarrow} S_{\Phi^x}$ respectively.

Thus Φ^X is the functor which sends the object n to the finite dimensional Hilbert space $\mathcal{C}_{n+1} = \text{Mor}_{\mathcal{C}}(X, \otimes^n X)$, and a morphism (forest) $f : m \rightarrow n \in \mathcal{F}$ to the isometry $\Phi^X(f) : \mathcal{C}_{m+1} \rightarrow \mathcal{C}_{n+1}$ obtained by interpreting the forest f as an element of \mathcal{C}_{m+n} by replacing the vertices in f with the element $Y \in \mathcal{C}$. The element $\Phi^X(f)$ then has m ingoing boundary points and n outgoing ones so defines an isometry according to the usual language of planar algebras -[11]. We illustrate below, for $x \in \Phi^X(3)$ and f the forest with 3 roots and 8 leaves which is visible in the diagram (thus $m = 3, n = 8$):

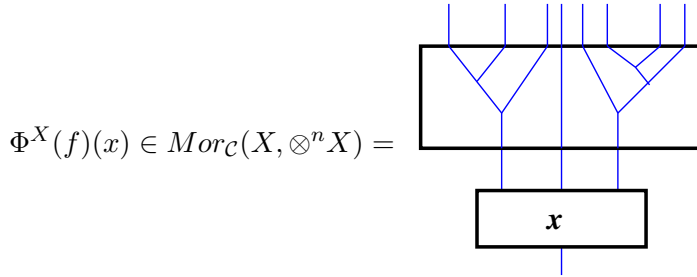

The functor Φ^1 is in some sense even simpler. We have

$$\Phi^1(n) = \begin{cases} 0 & \text{if } n = 1 \\ \mathcal{C}_n & \text{if } n \geq 2 \end{cases}$$

And as an illustration , for $x \in \Phi^1(3)$ and f as above,

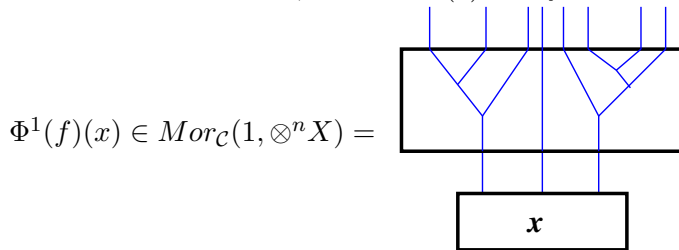

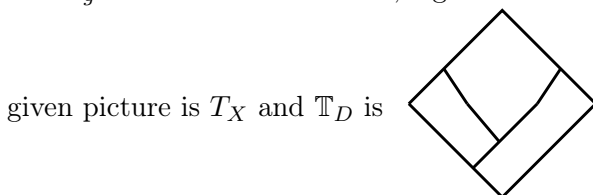

When representing an element of Thompson's group F as a pair of trees as in the introduction one can choose to either include or not include the vertical edges at the top and bottom marking the roots. If $g \in F$ let T_g be the version with these vertices and \mathbb{T}_g be the version without, e.g. for the element $D \in F$ of the introduction, the



Proposition 3.0.1. *Let $g \in F$ be given. Then the “vacuum expectation value”, or “vacuum coefficient” $\langle \pi(g)\Omega, \Omega \rangle$ is $\frac{1}{d}$ times the scalar obtained by tying the top of T_g to the bottom and evaluating in \mathcal{C} by replacing all vertices of the trees by Y 's.*

And $\langle \pi(g)\Psi, \Psi \rangle$ is $\frac{1}{d}$ times the scalar obtained by replacing all the vertices of T_g by Y and evaluating in \mathcal{C} .

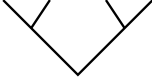
Proof. This is an exercise which will be clear if we illustrate using the element $D \in F$ and the representation coming from Φ^1 .

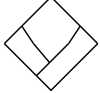
If s is the tree  and t is the tree  then $D = \frac{s}{t}$. As a vector in the direct limit, $\sqrt{d}\Psi = \frac{t}{\Phi^1(t)}$ so that $\sqrt{d}\pi(D)(\Psi) = \frac{s}{\Phi^1(t)}$. But also $\sqrt{d}\Psi = \frac{s}{\Phi^1(s)}$ so by the definition of the inner product in the direct limit Hilbert space, $d\langle \pi(g)\Psi, \Psi \rangle$ is the inner product in $\Phi^1(4)$ of $\Phi^1(t)$ with $\Phi^1(s)$ which by the definition of Φ is just  viewed as an element of $\mathcal{C}_0 = \mathbb{C}$.

The case of Φ^X is proved in the same way. □

Definition 3.0.3. *We call the representations π_Y of F coming from Φ^1 and Φ^X as above, on the closed F -linear span of Ψ and Ω respectively, the Wysiwyg representations of F .*

Definition 3.0.4. *More generally one can let p be any minimal projection in one of the algebras \mathcal{C}_{2n} and consider the direct system*

$$t \mapsto \begin{cases} \mathcal{C}_m & \text{if } t \text{ is a tree with } m \text{ leaves and } m \geq 2n \\ 0 & \text{if } t \text{ has less than } 2n \text{ leaves.} \end{cases}$$

Then F acts on the direct limit as before and we let $\pi_{Y,p}$ be the unitary representation of F on the Hilbert space completion, so that $\pi_{Y,\phi}$ contains π_Y where ϕ is the identity of \mathcal{C}_0 .

4. THE MAIN THEOREM

Let \mathcal{C} and Y be as in the last section. Let π_Y be the Wysiwyg representation of F defined above with vacuum Ψ .

Theorem 4.0.1. *The unitary representation π_Y is irreducible.*

Our proof will rely heavily on an algorithm for calculating the product of two elements of F which is to be found in [2] and [7]. Let us describe it:

Given two pairs P and Q of (binary planar rooted) trees represented diagrammatically as in the introduction, place P on top of Q in the plane and join them as below
:

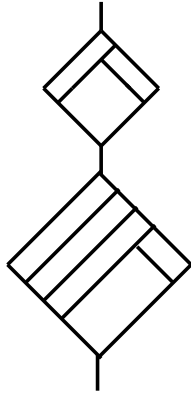

Then apply the diagrammatic rules $\times \rightarrow ||$ and $\diamond \rightarrow |$ (and some isotopy) until they cannot be applied any more:

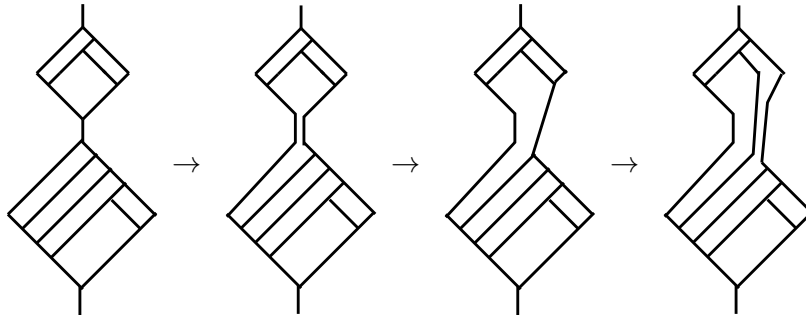

At this point one may draw a curve through the diagram so that all the vertices below it are Y's and all above it are upside down Y's. Straightening that curve to a horizontal line thus gives a pair of trees that give the product of the two original F elements P and Q :

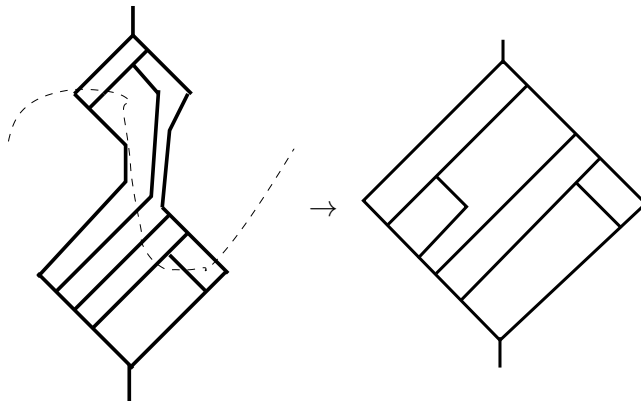

NB It is important to note that, although the diagrams involved in calculating gh make sense in the category \mathcal{C} , one may NOT use them to calculate vacuum

expectation values until all the cancellations are done. This is because the relation $\begin{array}{c} \diagup \\ \diagdown \end{array} \rightarrow \begin{array}{c} | \\ | \end{array}$ does not hold in \mathcal{C} .

The following lemma is just a simple calculation but that calculation leads on to all the lucky accidents that make the proof work. Recall that A is the generator of F in [4].

Lemma 4.0.1. $\pi_Y(A)\Psi = \Psi$.

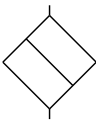
Proof. The two-tree picture of A is  so the diagram in \mathcal{C} giving $\langle A\Psi, \Psi \rangle$ is

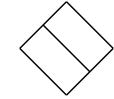

which by the rules in \mathcal{C} is the same as $d\langle \Psi, \Psi \rangle$. By the unitarity of π_Y we are done. \square

We leave it to the reader to deduce this result directly from the definition of the action of group elements on vectors in the direct limit so that the result actually holds even in the non-unitary case. (Note that we have suppressed the π_Y in the inner product formula. We will continue in this way.)

Lemma 4.0.2. Let g and h be in F . Then

$$\langle A^n g \Psi, h \Psi \rangle = \langle g \Psi, \Psi \rangle \langle \Psi, h \Psi \rangle$$

for sufficiently large n .

Proof. Observe that $\langle A^n g \Psi, h \Psi \rangle = \langle h^{-1} A^n g \Psi, \Psi \rangle$ so we must calculate the vacuum expectation value of $h^{-1} A^n g$.

The diagram for $h^{-1} A^n g$ before cancellation is (with n sloping lines in the A^n part):

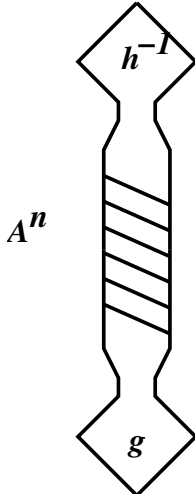

Now take the "pair of trees" picture of g and isolate the vertices on the right branch of the top tree as below:

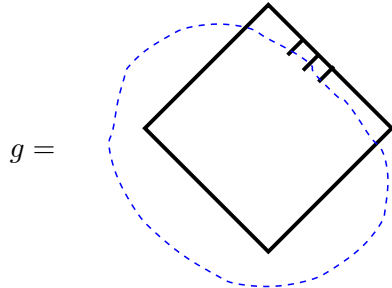

Look near the top of g and the bottom of A^n :

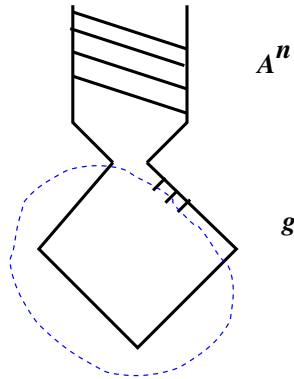

For sufficiently large n one may apply $\begin{matrix} \diagdown & \rightarrow & | \\ \diagup & & | \end{matrix}$ enough times to cancel all the right branch vertices in the top half of g to obtain:

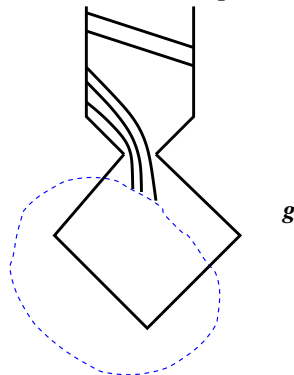

At this stage all the strings connecting what is left of A^n to g are connected at the bottom as they were in g , which is reduced. So provided n is large enough so there is no interference between g and h^{-1} , the only cancellation that can occur in the picture is the leftmost of these strings, marked "a" below, which can only cancel with a vertex of A^n if it is connected directly to the leftmost branch of the top tree of g .

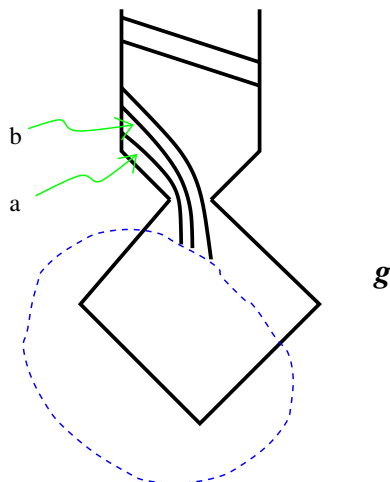

After the string a has been cancelled the only other cancellation is b and so on. Once all these cancellations are done, no more can happen. The same considerations apply to h^{-1} so we may calculate $\langle h^{-1}A^n g \Psi, \Psi \rangle$ by looking at the resulting figure in the trivalent category. But before doing that observe that the last round of cancellations are all of the form $\diamond \rightarrow \mid$ which is also true in \mathcal{C} ! So we may undo them and obtain the picture below:

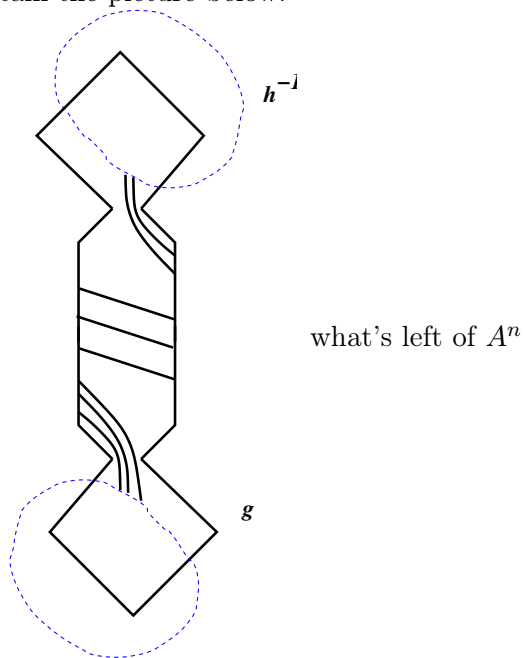

So that $\langle h^{-1}A^n g \Psi, \Psi \rangle$ is $\frac{1}{d}$ times the evaluation of the above picture in \mathcal{C} . But now isolate the parts of the picture involving g and h^{-1} as below:

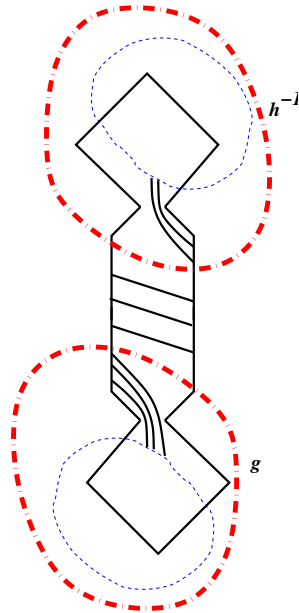

The parts enclosed in the red double dashed regions are actually elements of \mathcal{C}_2 which is one dimensional. Hence they are scalar multiples of a single curve joining the boundary points. To find the scalar multiple cut out the parts inside the red dotted lines and join the boundary points to obtain (for g , h is similar) :

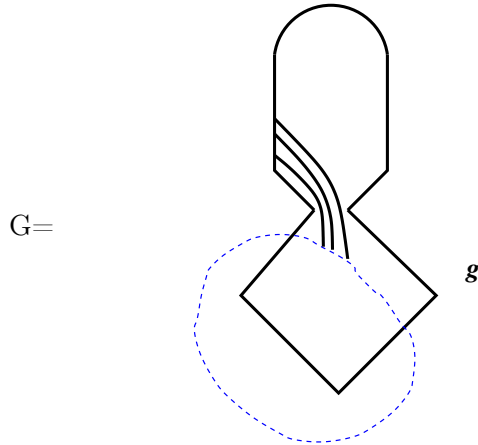

The curves which started out connected to the top right branch of g , can be moved back there, the top of the picture straightened, and we recognise the picture of g that we started with! And similarly a factor H at the top. By wysiwyg we have

$$G = d\langle g\Psi, \Psi \rangle \text{ and } H = d\langle h^{-1}\Psi, \Psi \rangle.$$

By easy planar algebra arguments, splitting a "connected sum" of two closed tangles as the product of individual closed tangles incurs a multiplicative factor of $\frac{1}{d}$.

The three pictures resulting from the red double dash decomposition are G , H and A^k for some k with $0 \leq k \leq n$, to which we may apply $\diamond \rightarrow \left| \right. k$ times to obtain just d .

$$\text{Altogether } d\langle A^n g\Psi, h\Psi \rangle = \frac{d}{d^2}GH \text{ so } \langle A^n g\Psi, h\Psi \rangle = \frac{G}{d} \frac{H}{d} = \langle g\Psi, \Psi \rangle \langle \Psi, h\Psi \rangle.$$

It is interesting that the same calculation works for Φ^X right up to this point. But because of the extra string joining the top to the bottom, a multiplicative factor of $(\frac{d-2}{d-1})^k$ appears which means A^n actually tends weakly to zero. Indeed the projection onto $\mathbb{C}\Omega$ does not even commute with A in this case since if it did, $|\langle A\Omega, \Omega \rangle|$ would be 1. \square

Corollary 4.0.1. *The weak limit of $\pi_Y(A^n)$ as $n \rightarrow \infty$ on the closure of the F -linear span of Ψ is equal to P_Ψ , the orthogonal projection onto the linear span of Ψ .*

Proof. The formula for P_Ψ is $P_\Psi(\eta) = \langle \Psi, \eta \rangle \Psi$. Linear extension of the result of the previous lemma gives $\langle A^n \xi, \eta \rangle = \langle P_\Psi \xi, \eta \rangle$ for ξ and η in a dense subspace and the corollary follows from the unitarity of π_Y . \square

Proof. The proof of the theorem is now easy. For let \mathfrak{H} be the closed F -linear span of Ψ on which π_Y acts. Suppose t is a bounded operator on \mathfrak{H} commuting with $\pi_Y(F)$. Then by the previous corollary $t\Psi = \lambda\Psi$ for some scalar λ . Thus $tg\Psi = \lambda g\Psi$ for all $g \in F$ so taking linear combinations we see that $t = \lambda id$ on all of \mathfrak{H} . \square

Corollary 4.0.2. *The Wysiwyg representations from Φ^1 are mutually inequivalent for different values of d .*

Proof. The vector Ψ when normalised is unique up to a scalar of modulus one, as a vector spanning the 1-eigenspace of A . But we can calculate, using the relations of [12], $\langle X\Psi, \Psi \rangle = d\frac{d-2}{d-1}$. But $\langle \Psi, \Psi \rangle = d$ so two Wysiwyg representations can only be equivalent if the values of d are equal. \square

Remark 4.0.1. *We know that the inductive limit Hilbert space also carries a unitary representation of Thompson's group T , extending that of F and also called π_Y . Exactly the same argument as above shows that T acts irreducibly on the closed T -linear span of Ψ but we do not know if that is the same Hilbert space as \mathfrak{H} .*

5. IMPROVEMENTS

We present two improvements on the previous results by extending from the F -linear span of the vacuum vector to the whole direct limit Hilbert space.

a) Telling the representations apart.

It is curious that all the representations of F the kind we are considering contain the coefficients of the vacuum by weak limits of certain elements. Which means that the representations are inequivalent as soon as the corresponding vacuum ones are.

To be more precise let $\sigma : F \rightarrow F$ be the endomorphism which sends an element of F (viewed as a PL homeomorphism of $[0, 1]$) to itself rescaled and acting in $[\frac{1}{2}, 1]$ and by the identity on $[0, \frac{1}{2}]$.

Diagrammatically we have, for $g = \frac{a}{b}$:

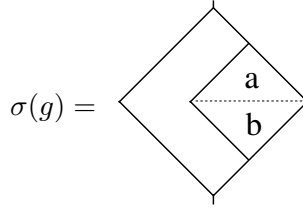

Theorem 5.0.1. *Let $g \in G$ and Then*

$\pi_{Y,p}(\sigma^n(g))$ tends weakly to $\langle \pi(g)\Omega, \Omega \rangle id$ for any p as in 3.0.4

Proof. By unitarity as usual it suffices to show that

$$\langle \pi_{Y,p}(\sigma^n(g))(\xi), \eta \rangle \rightarrow \langle \pi(g)\Omega, \Omega \rangle \langle \xi, \eta \rangle$$

for ξ and η in any finite dimensional approximant of the direct limit. Let t_m be the full bifurcating planar tree with 2^m leaves (such trees form a cofinite sequence) and let x and y be elements of \mathcal{C}_{2^m} . Then let $\xi = \frac{t_m}{x}$ and $\eta = \frac{t_m}{y}$ be the corresponding elements of the direct limit Hilbert space. We need to calculate $\langle \pi_{Y,p}(\sigma^n(g))(\xi), \eta \rangle$ for large n . For any $k > 0$ and any tree s let r_s^k be the tree with n branches to the left attached to a single branch to the right, and s attached to the end of the right branch, thus:

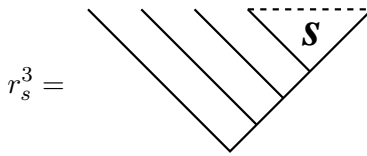

Suppose $n > m$ and that a is a tree. Let t_a be the tree obtained by attaching r_a^{n-m} to the rightmost leaf of t_m . Let g be given by the pair of trees $\frac{a}{b}$. Then by drawing a diagram and cancelling lots of carets we see that $\frac{t_a}{t_b} = \sigma^n(\frac{a}{b}) = \sigma^n(g)$. Moreover

$$\frac{t_m}{x} = \frac{t_b}{x_b}$$

where x_b is the element of \mathcal{C} defined by attaching the diagram r_b^{n-m} to the rightmost string emanating from a disc containing x thus (illustrated for $m = 3$ so there are 8 vertical strings emanating from the disc containing x):

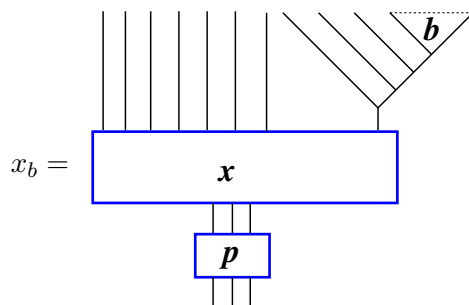

This picture is interpreted as an element of the planar algebra with the trivalent vertices being discs containing Y , as usual.

We have

$$\sigma^n(g)(\xi) = \frac{t_a}{t_b} \left(\frac{t_b}{x_b} \right) = \frac{t_a}{x_b}$$

and of course

$$\eta = \frac{t_m}{y} = \frac{t_a}{y_a}$$

so working the \mathcal{C} we see that $\langle \pi_{Y,p}(\sigma^n(g))(\xi), \eta \rangle$ is the value in \mathcal{C} of the following diagram (illustrated for $n = 6$):

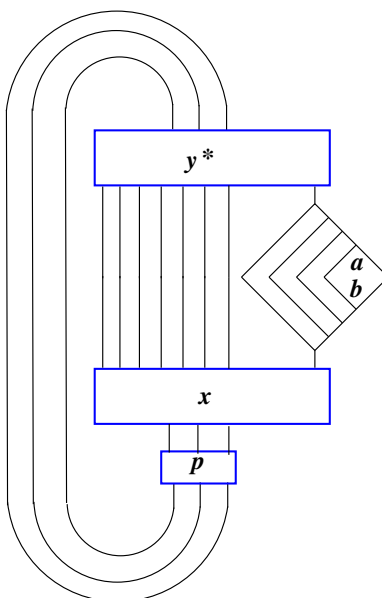

Since the dimension of \mathcal{C}_1 is one, we may surround the diamond shape part of the picture by a disc and use the unitarity of Y to conclude that this picture is a multiple of $\langle \pi(g)\Omega, \Omega \rangle \langle \xi, \eta \rangle$. \square

Corollary 5.0.1. $\pi_{Y,p}$ is inequivalent to $\pi_{Y',q}$ whenever $\pi_{Y,1}$ is inequivalent to $\pi_{Y',1}$.

b) In the last section we showed that A^n tends weakly to the projection onto $\mathbb{C}\Psi$ on the F -linear span of Ψ . Here we extend that to the whole space \mathfrak{H}_Y^1 . We record also the corresponding result for $\pi_{Y,1}$.

Theorem 5.0.2. (i) $\pi_{Y,\phi}(A^n)$ tends weakly to the projection onto $\mathbb{C}\Psi$ as $n \rightarrow \infty$.
(ii) $\pi_{Y,1}(A^n)$ tends weakly to zero as $n \rightarrow \infty$.

Proof. (i) The proof will involve a calculation similar to that of the previous theorem but fortunately the detailed structure of the stabilising forests need not concern us. This is because we know already that there is a fixed vector for $\pi_{Y,\phi}(A)$ so if we can show the weak limit of $\pi_{Y,\phi}(A^n)$ exists and has rank 1, it can only be orthogonal projection onto the subspace spanned by the fixed point.

So let a_n and b_n be the trees with n leaves illustrated below for $n = 7$:

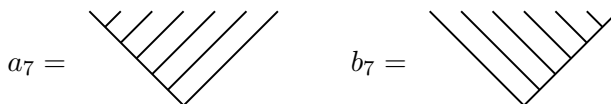

Then $A^n = \frac{a_{n-2}}{b_{n-2}}$.

Suppose we are given $\xi = \frac{t_m}{x}$ and $\eta = \frac{t_m}{y}$ as in the last theorem in the direct limit Hilbert space on which $\pi_{Y,\phi}(A^n)$ acts. As before our first job is to stabilise b_n and t_m so they are equal. Provided n is much larger than 2^m this will be achieved for b_n by a forest of the form:

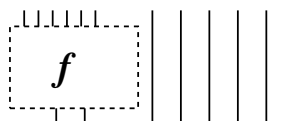

where f is the forest with the $m-2$ trees t_{m-1}, t_{m-2}, \dots from left to right. To stabilise the numerator t_m of ξ , simply attach a copy of b_k for some large k (approximately equal to $n - 2^m$) to the rightmost leaf of t_m . Thus we have

$$\pi_{Y,\phi}(A^n)(\xi) = \frac{\tilde{a}_n}{\tilde{x}}$$

with \tilde{x} given by the following tangle (illustrated with $m = 3$ and $k = 7$):

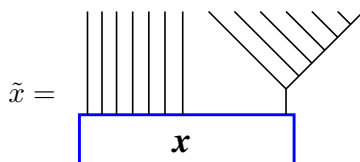

and \tilde{a}_n is the tree a_n stabilised by the forest above thus:

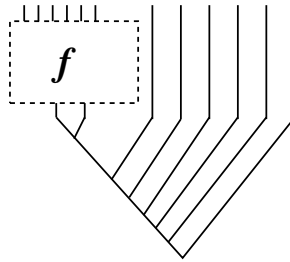

In order to calculate the inner product $\langle \pi_{Y,\phi}(A^n)(\xi), \eta \rangle$ we need to stabilise \tilde{a}_n and t_m so that they are equal. This involves attaching a forest g which is a reflected version of f on the right hand side of \tilde{a} , and attaching a copy of \tilde{a}_k for some k to the left hand side of t_m . Applying these stabilisations to the denominators we see that we want the inner product in \mathcal{C} of

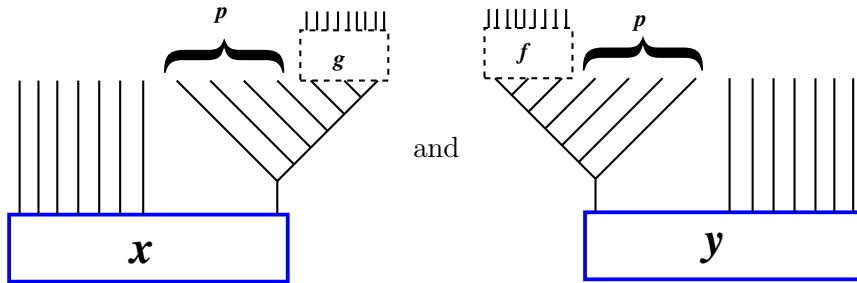

Observe that p (the number of strings as indicated) can be made arbitrarily large by increasing n whereas the sizes of f and g depend only on m . We see that $\langle \pi_{Y,\phi}(A^n)(\xi), \eta \rangle$ is given by an element of \mathcal{C}_0 that looks like:

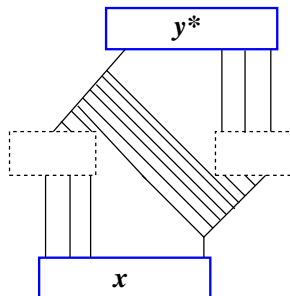

Which can be redrawn in \mathcal{C} as

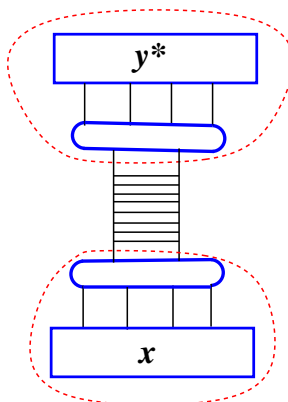

where we observe that, since the dimension of \mathcal{C}_2 is one, the contributions of the top and bottom dotted circles are just linear functionals of x and y^* which do not change as soon as n is large enough. By the unitarity property of Y , we see that the weak limit of $\pi_{Y,\phi}(A^n)$ exists and has rank 1.

Very little changes for $\pi_{Y,1}(A^n)$. The only difference in the final diagram is a string joining the top of the picture to the bottom so that the dotted circles meet three strings instead of two. Thus what is inside them contributes a multiple of Y and the ladder in the middle introduces a term t^p which tends to zero as n , hence p tends to infinity.

□

REFERENCES

- [1] Aiello, V. and Jones, V. (2019) On spectral measures for certain unitary representations of R. Thompson's group. [arXiv:1905.05806](https://arxiv.org/abs/1905.05806)
- [2] J. Belk, Thompson's group F. Ph.D. Thesis (Cornell University). [arXiv preprint:0708.3609](https://arxiv.org/abs/0708.3609) (2007).
- [3] Brothier, A. and Jones, V. Pythagorean representations of Thompson's groups. [arXiv:1807.06215](https://arxiv.org/abs/1807.06215)
- [4] Cannon, J.W., Floyd, W.J. and Parry, W.R. (1996) Introductory notes on Richard Thompson's groups. *L'Enseignement Mathématique* **42** 215–256
- [5] Connes, A. (1994). Noncommutative geometry. *Academic Press*.
- [6] G. Golan and M. Sapir, On Jones' subgroup of Thompson group F, *Journal of Algebra* **470** (2017), 122D-159.
- [7] V Guba, M Sapir, Diagram groups, *Mem. Amer. Math. Soc.* **130**(1997)
- [8] Hayashi, T. and Yamagami, S. (2000). Amenable tensor categories and their realizations as AFD bimodules. *Journal of Functional Analysis*, **172**, 19–75.
- [9] Jones, V.F.R. (2017) Some unitary representations of Thompson's groups F and T. *J. Comb. Algebra*, **1**, 1-D44.
- [10] Jones, V.F.R. (2018) A no-go theorem for the continuum limit of a periodic quantum spin chain. *Communications in Mathematical Physics*, **357**, 295–317
- [11] V.F.R. Jones, Planar Algebras I, preprint. [math/9909027](https://arxiv.org/abs/math/9909027)
- [12] S. Morrison, E. Peters, N. Snyder, (2017) Categories generated by a trivalent vertex. *Selecta Mathematica*, **23** 817-D868 [arXiv:1501.06869](https://arxiv.org/abs/1501.06869)

- [13] J. Nikkel, Y. Ren, (2018) On Jones Subgroup of R. Thompson's Group T *International Journal of Algebra and Computation* **28** 877–903 [arXiv:1710.06972](https://arxiv.org/abs/1710.06972)