

Automated Steel Bar Counting and Center Localization with Convolutional Neural Networks

Zhun Fan, *Senior Member, IEEE*, Jiewei Lu, Benzhang Qiu, Tao Jiang, Kang An, Alex Noel Josephraj, and Chuliang Wei

Abstract—Automated steel bar counting and center localization plays an important role in the factory automation of steel bars. Traditional methods only focus on steel bar counting and their performances are often limited by complex industrial environments. Convolutional neural network (CNN), which has great capability to deal with complex tasks in challenging environments, is applied in this work. A framework called CNN-DC is proposed to achieve automated steel bar counting and center localization simultaneously. The proposed framework CNN-DC first detects the candidate center points with a deep CNN. Then an effective clustering algorithm named as Distance Clustering (DC) is proposed to cluster the candidate center points and locate the true centers of steel bars. The proposed CNN-DC can achieve 99.26% accuracy for steel bar counting and 4.1% center offset for center localization on the established steel bar dataset, which demonstrates that the proposed CNN-DC can perform well on automated steel bar counting and center localization. Code is made publicly available at: <https://github.com/BenzhangQiu/Steel-bar-Detection>.

Index Terms—Steel bar counting, center localization, convolutional neural network, distance clustering.

I. INTRODUCTION

STEEL industry is one of the most important basic industries for many countries. Steel bar is one of the most commonly used steel products, which is mainly used for building construction. Factory automation [1], [2], [3], [4], [5], [6] plays an essential role in improving the productivity of steel bars, in which automated steel bar counting and center localization are among the most crucial steps.

A. Steel Bar Counting

Steel bar counting plays an important role in the management of steel production. Traditional steel bar counting is based on human calculation. Skilled workers count the number of steel bars in the factory, which is time-consuming and prone to errors. In recent years, some image processing techniques are employed to achieve automated steel bar counting. In [7], Zhang *et.al.* use a template matching algorithm and a mutative threshold segmentation method to achieve steel bar counting. In [8], Ying *et.al.* combine Sobel operator and Hough transformation for automatic steel bar counting. In [9],

Wu *et.al.* propose a steel bar counting method which utilizes concave dots matching, K-level fault tolerance and visual feedback. In [10], Ghazali *et.al.* employ Hough transformation and the Laplacian of Gaussian (LoG) technique to perform automated steel bar counting. In [11], Liu *et.al.* propose a contours-based steel bar identification algorithm to count the number of steel bars. However, these methods are easily affected by the noisy and complex industrial environment, and need to adjust many parameters during operations.

B. Center Localization

Center localization means locating the center of each steel bar, as shown in Fig. 2. The reason of performing center localization is that it is an important step to achieve automated nameplate welding. Before leaving steel factories, steel bars need to be welded nameplates which contain the information of steel bars, such as production time and type specification. Traditional nameplate welding is performed by skilled workers. Experienced workers use manipulators to weld nameplates on the steel bars, as shown in Fig. 3. Before welding a nameplate on a steel bar, an appropriate welding point which is close to the center of a steel bar needs to be chosen in order to avoid the broken and sliding problems of nameplates in transit. Therefore, locating the centers of steel bars is the first and one of the most crucial steps to achieve automated nameplate welding.

In this paper, a framework called CNN-DC is proposed to achieve automated steel bar counting and center localization simultaneously. The proposed CNN-DC framework first detects the candidate center points with a deep convolutional neural network (CNN). Then an effective clustering algorithm called *Distance Clustering (DC)* is proposed to cluster the candidate center points and obtain the centers of steel bars.

For the task of steel bar counting and center localization, the object detection algorithm[12] can be used. But it depends on larger dataset, and it is easy to misidentify in the case of dense object. The proposed method aims to figure out the problem of fewer dataset in factory. According to patches extracted from only 4 images which is used to train the CNN, this network has a significance expression of center area of steel bar and background. And distance clustering can eliminate the redundancy of candidate center points. The experimental results demonstrate the effectiveness of CNN-DC on steel bar counting and center localization.

The rest of this paper is structured as follows: Section II describes the proposed CNN-DC framework. Section III

Corresponding author: Zhun Fan (email: Zfan@stu.edu.cn).

Jiewei Lu and Benzhang Qiu contributed equally.

Authors are with the Guangdong Provincial Key Laboratory of Digital Signal and Image Processing, College of Engineering, Shantou University, Shantou 515063, China.

This research work was supported by Guangdong Key Laboratory of Digital Signal and Image Processing, the National Natural Science Foundation of China under Grant (61175073, 61300159, 61332002, 51375287).

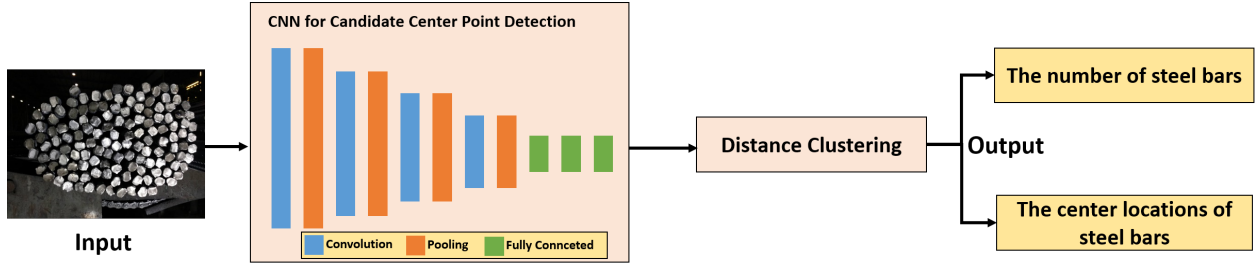

Fig. 1. The proposed CNN-DC framework. CNN-DC first detects the center points with a deep CNN, and then applies Distance Clustering algorithm to obtain the information of the number of steel bars and the center locations of the steel bars.



Fig. 2. An example of center localization. Red points are the centers of steel bars.

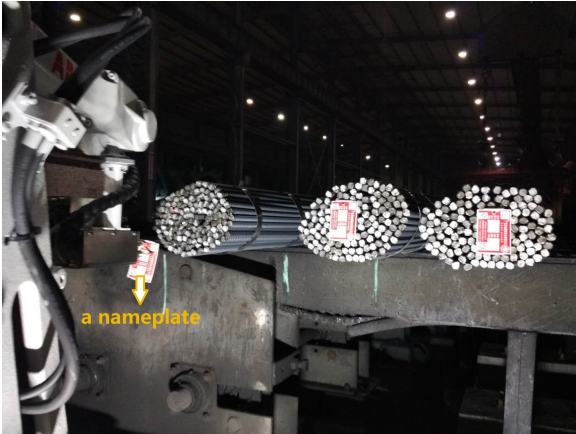

Fig. 3. Manipulators are used to weld nameplates on the steel bars.

introduces the steel bar dataset and evaluation metrics. Section IV provides the experimental results. Section V presents the conclusions of this paper.

II. METHODOLOGY

The proposed CNN-DC framework can be regarded as a two-stage algorithm for automated steel bar counting and center localization. CNN-DC first obtains the candidate center points of steel bars with a deep CNN, and then an effective clustering algorithm named as Distance Clustering is proposed

to cluster the candidate center points. Fig. 1 shows the framework of CNN-DC.

A. Convolutional Neural Networks

Convolutional neural networks are applied in our work to detect the candidate center points. Neural networks are inspired by biological processes [13], [14], and can be used to process a variety of high dimensional data [15], [16], [17], [12], [18], [19], [20], [21], [22], such as images, videos, voice signals and text characters. When dealing with the above-mentioned data, the application of fully connected networks is sometimes cumbersome due to its large feature space. Therefore, CNNs as special types of neural networks are preferred due to some important characteristics, such as spatial arrangement, sparse interactions, parameter sharing [23].

The input of CNNs is called tensor, which comprises of a multi-dimensional array. The core components of CNNs are convolutional and pooling layers. A convolutional layer convolves the input tensor with a set of kernels to generate the output tensor. For each kernel, a feature map is generated by performing convolution, which slides the kernel on the whole spatial positions of the input tensor. Each convolutional layer consists of a set of kernels and thus produces a collection of feature maps, which are stacked together to generate the output tensor. When the input tensor is shaped as greyscale image, the following steps are performed in order to specify the convolutional layer: (1) Accepting the input tensor with size $H_i \times W_i \times D_i$, and obtaining the four parameters: K (the number of kernels), F (the spatial dimensions of kernels), S (stride) and P (the zero padding size). (2) Producing the output tensor with size $H_o \times W_o \times D_o$, where $H_o = (H_i - F + 2P)/S + 1$, $W_o = (W_i - F + 2P)/S + 1$ and $D_o = K$. (3) The total number of parameters for the kernels is $(F \times F \times D_i) \times K$, where each kernel has $(F \times F \times D_i)$ parameters. Pooling layers are used to reduce the number of training parameters and control overfitting. They have two downsampling strategies: max-pooling and mean-pooling. Normally max-pooling is adopted with kernels of size 2×2 and stride 2.

Convolutional neural networks generally consist of several convolutional layers and pooling layers, finalized with one or more fully connected layers. The details of CNNs used in this paper are provided in Fig. 5.

B. Distance Clustering

Clustering is a statistical analysis method applied to classification problems. The methods of clustering include: connectivity-based clustering [24], [25], centroid-based clustering [26], [27], density-based clustering [28] [29], grid-based clustering [30]. An effective clustering algorithm called Distance Clustering (DC) is proposed to cluster the candidate center points obtained from the CNN.

The pseudocode of DC is shown in Algorithm 1 and illustrated in Fig. 4:

Algorithm 1: Distance Clustering (DC)

Input: The locations of candidate center points and a distance threshold th_d

Output: A set of clusters, the center of each cluster and the number of clusters

Step 1: Initialization

- 1) For $i = 1, \dots, n$, set $D(i) = d_{ij}$, where n is the number of candidate center points, d_i is the Euclidean distance between the i th candidate center point and its closest candidate center point j , D is the set of d_{ij} .
- 2) Create an empty structure S to save the initial clusters.
- 3) For $i = 1, \dots, n$, do
 - if $D(i) < th_d$, $S\{i\} = \{i;j\}$; else $S\{i\} = \{i\}$

Step 2: Clustering

- 1) Create a structure $S_c\{1\} = S\{1\}$ to save the final clusters and set the number of clusters as $n_{S_c} = 1$.
- 2) For $i = 2, \dots, n$, do
 - $n_{S_c} = \text{length}(S_c)$
 - condition = 0
 - For $k = 1, \dots, n_{S_c}$, do
 - if $(S\{i\} \cap S_c\{k\}) \neq \emptyset$, do
 - $S_c\{k\} = \{S_c\{k\}; S\{i\}\}$
 - condition = 1
 - break
 - end if

Step 3: Obtaining Centers

- 1) Create an empty center set C to save the centers
- 2) For $i = 1, \dots, n_{S_c}$, do
 - $x_{c_i} = (\max(x_{S_c\{i\}}) + \min(x_{S_c\{i\}})) / 2$
 - $y_{c_i} = (\max(y_{S_c\{i\}}) + \min(y_{S_c\{i\}})) / 2$
 - $C(i) = (x_{c_i}, y_{c_i})$

Initialization: In this step, for the i th candidate center point, its Euclidean distances with other candidate center points are calculated first. Then the closest distance d_{ij} with the j th candidate center point is chosen and assigned to the i th candidate center point. Moreover, a structure S is created to save neighbors for the i th candidate center point. A distance threshold th_d is used to decide whether the point j is a neighbor of the i th candidate center point and belongs to the set of $S\{i\}$. In the experiment, th_d is set as 20.

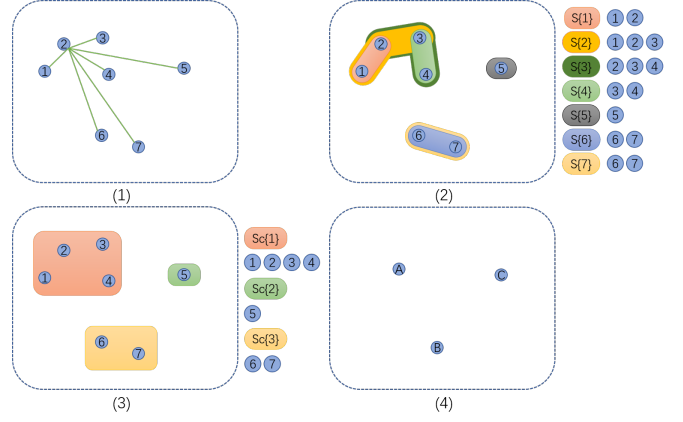

Fig. 4. Illustrating the process of distance clustering: (1) Calculating distances of each two candidate center points. (2) Creating a set for each candidate center point by distance threshold. (3) Merging sets if they have common elements. (4) Calculating the center point of each set.

Clustering: A new structure S_c is created to save the final clusters. For each clusters $S\{i\}$ in S , if it has common elements with one of the clusters $S_c\{k\}$ in S_c , the cluster $S\{i\}$ will be merged into $S_c\{k\}$. Otherwise, S_c will create a new cluster to save $S\{i\}$.

Obtaining Centers: For each cluster in S_c , the localization of each cluster center is calculated by averaging the maximum and minimum coordinate values for the x-coordinate and y-coordinate.

III. DATASET AND EVALUATION METRICS

A. Dataset

The steel bar dataset consists of 10 images. The images are obtained by an industrial camera in a steel bar factory. Each image has a high resolution and is of size 1440×1080 . Moreover, each image has RGB channels and each channel is with 8 bits. The 10 images were divided into a training set and test set. The training set contains 4 images while the test set consists of 6 images. 99195 patches extracted from the training set are used to train the network.

B. Evaluation Metrics

Four commonly used evaluation metrics are applied in our work to assess the performance of CNN-DC:

$$Recall = \frac{TP}{TP + FN}$$

$$Precision = \frac{TP}{TP + FP}$$

$$F1 = \frac{2 \times Precision \times Recall}{Precision + Recall}$$

where TP, FP and FN indicates true positive (the number of correctly detected center points), false positive (the number of incorrectly detected center points), and false negative (the number of undetected center points), respectively. *Recall* indicates the CNN-DC's ability of detecting center points while *Precision* is used to measure the CNN-DC's capability of correctly detecting center points. *F1* is a comprehensive index

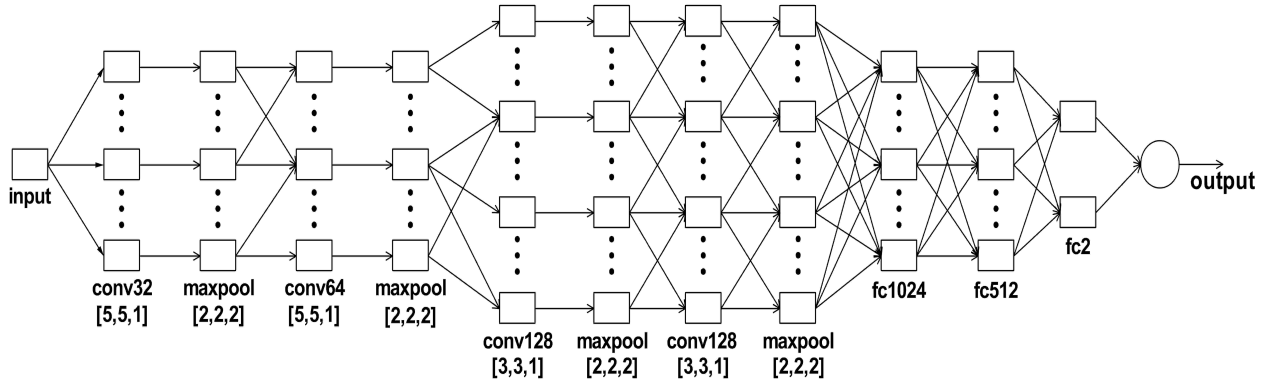

Fig. 5. The CNN architecture composed of four convolutional layers, four pooling layers and three fully connected layers. Layer names are followed by the number of feature maps. Square brackets specify the kernel size and stride. It is noted that 'conv', 'maxpool' and 'fc' are short terms for convolutional layer, max pooling layer and fully connected layer, respectively. Zero-padding is not used in this paper.

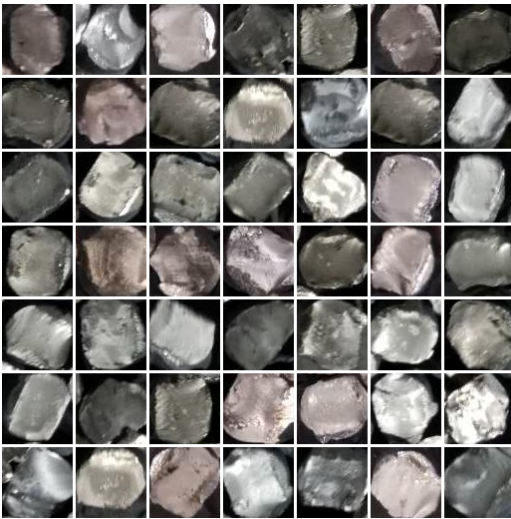

Fig. 6. The patches with label 1.

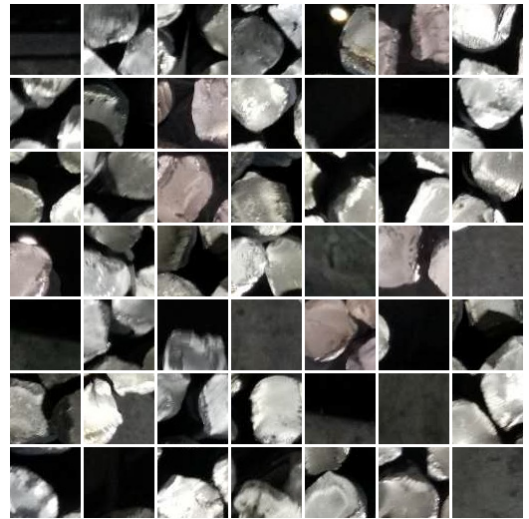

Fig. 7. The patches with label 0.

of *Recall* and *Precision*. The calculation time of applying CNN-DC on each test image is also stored.

In order to further evaluate the performance of CNN-DC for automated steel bar counting and center localization, two other useful metrics are employed in this work.

The first one is relative accuracy [31] :

$$Acc_r = \left(1 - \frac{|N_d - N|}{N}\right) \times 100\% \quad (1)$$

where $N_d = TP + FP$ is the number of detected center points. N is the actual number of steel bars. Acc_r evaluates the performance of CNN-DC on steel bar counting.

The second is the offset degree of center points:

$$offset = \frac{\sum_{i=1}^N \frac{X_i}{m}}{N} \times 100\% \quad (2)$$

where $m = 71$ is the average diameter of a steel bar and used to perform data normalization, X_i is the Euclidean distance between the i th manually marked center point and the closest detected center point. $offset$ is used to evaluate the performance of CNN-DC on center localization.

IV. EXPERIMENTS

In this section, the training setup of CNN is first introduced, followed by the experimental results.

A. Training Setup

1) *Network Architecture and Training Parameters*: The network architecture used in our experiment is composed of four convolutional layers, four pooling layers and three fully connected layers, as shown in Fig. 5. The network was trained by the stochastic gradient descent algorithm [32]. L_2 regularization with a weight decay 0.0001 was adopted to prevent overfitting. The learning rate was set as 0.001 and the training was stopped after 40 epochs. The implementation of CNN-DC was based on Tensorflow [33]. The training was conducted on a Intel Xeon E5-2690 CPU with a TITAN Xp GPU.

2) *Data Preparation*: In our experiment, 4 steel bar images are used to train the network. The input of the network are patches extracted from images based on each image pixel. The patch size is of 71×71 (71 is approximately the diameter of the

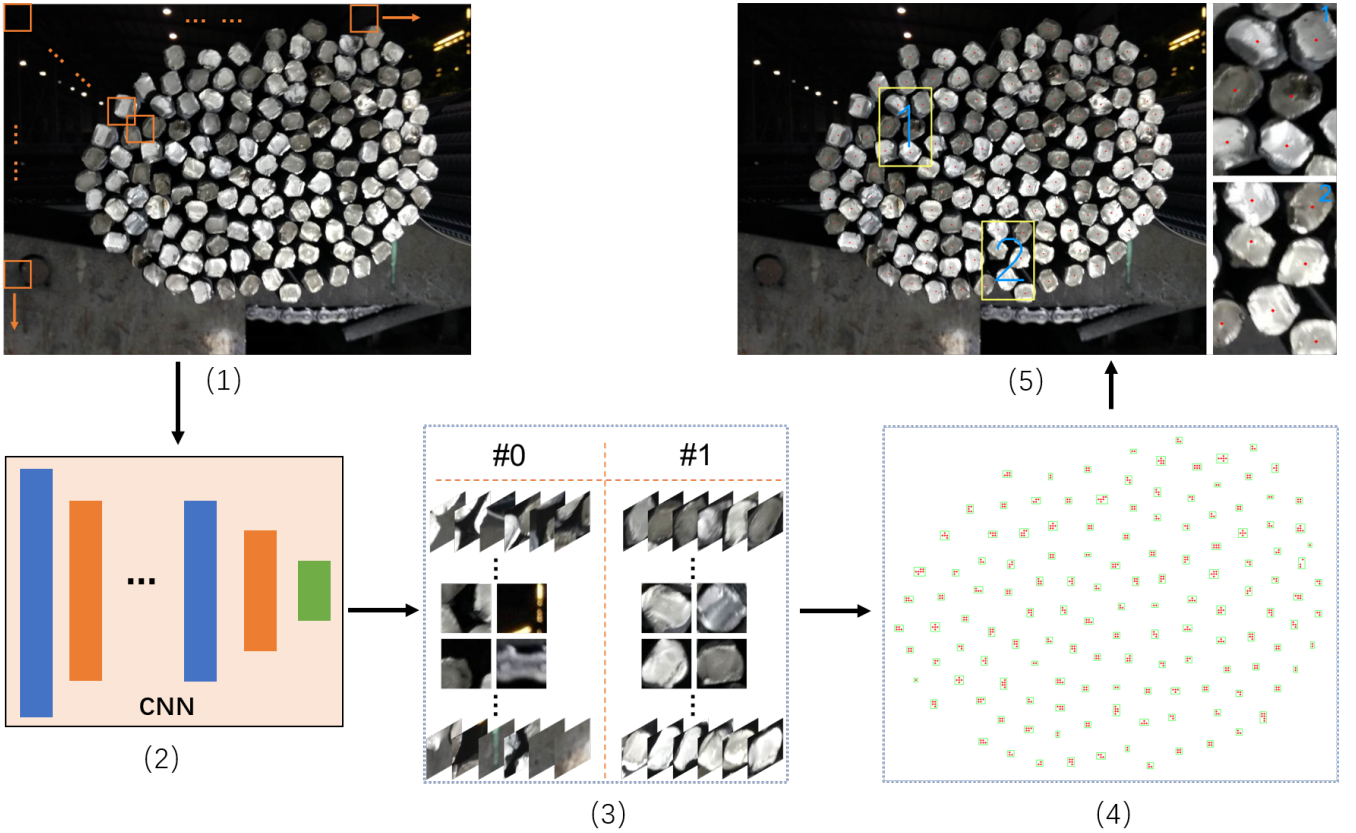

Fig. 8. The process illustrating the application of CNN-DC: (1) A 71×71 sliding window is adopted to extract patches from images based on each image pixel. (2) These patches are detected by CNN with architecture shown in Figure 5. (3) The result of CNN classification. (4) The center coordinates of the patches considered as label 1 are shown as red points, and the green boxes show the group of red points by distance clustering with process shown in Algorithm 1. (5) The center of each group is reimposed into the center of each steel bar of the original image accordingly.

steel bars). $1440 \times 1080 \times 4$ patches are extracted first. Then the patches whose centers were within the 7×7 rectangles centered in the manual center points are labeled as 1, and other patches are labeled as 0. Finally, 26468 patches are labeled as 1, while 6194332 patches are labeled as 0, which leads to an imbalanced data problem. In training, all patches with label 1 are chosen first. Then the patches with label 0 are selected randomly according to the ratio of positive (1) to negative (0) patches. In our experiment, the ratio of positive to negative patches is set as 1 : 3. Thus 26468 patches with label 1 and 72727 patches with label 0 are used to train the network. The examples of positive and negative training examples are shown in Fig. 6 and 7. During testing, a sliding window with stride 6 was employed to improve the efficiency of CNN-DC. The process of selecting the optimal test stride with regard to the efficiency of CNN-DC is provided in the third experiment of the next section.

B. Results

Three experiments are conducted in order to demonstrate the effectiveness of the proposed CNN-DC on automated steel bar counting and center localization. In the first experiment, the performance of CNN-DC on steel bar counting and center localization was analyzed. In the second experiment, the proposed CNN-DC was compared with other methods. In

the third experiment, the analysis of two parameters (the test stride and the distance threshold th_d) in DC algorithm was conducted.

TABLE I
THE PERFORMANCE OF CNN-DC ON THE STEEL BAR DATASET

	Recall	Precision	F1
	0.9951	0.9976	0.9963
Average Indexs of CNN-DC	Acc_r	$offset$	times(s)
	99.26%	4.11%	3.5862

1) *The First Experiment*: The performance of CNN-DC on the steel bar dataset is shown in TABLE I. From TABLE I, it can be observed that CNN-DC can obtain high scores on Recall, Precision and F1, with average values of 0.9951, 0.9976 and 0.9963, respectively, which indicates that CNN-DC can effectively identify center points on the steel bar images. Moreover, CNN-DC can achieve a high score on Acc_r with an average value of 99.26%, which means that CNN-DC can have a good performance in steel bar counting. Moreover, the low $offset$ score (4.1%) indicates that CNN-DC performs well on center localization. In addition, the calculation time of CNN-DC ($time = 3.5862s$) indicates that the CNN-DC can meet the requirement of real-time processing for factory automation. The processes illustrating the application of CNN-DC on the steel bar dataset are shown in Fig. 8.

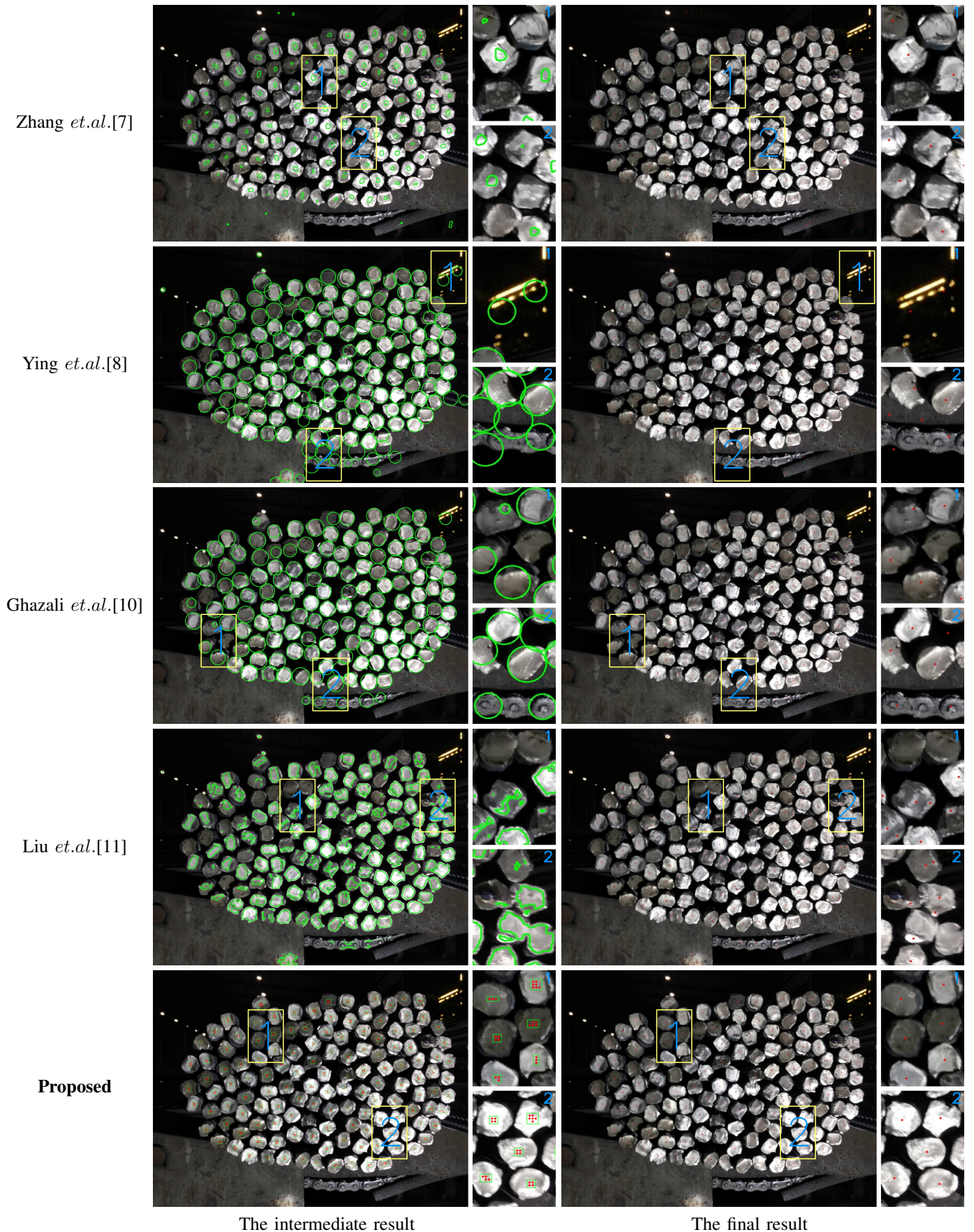

Fig. 9. Comparison of results obtained by different methods on an exemplar image. In Zhang *et.al.*[7], the template matching algorithm can not match the image which is not similar to the template, and lead to lack of identification of some steel bars. In Ying *et.al.*[8] and Ghazali *et.al.*[10], the Hough transformation algorithm is sensitive to edge information. Some circular background area and steel bars with blur edge is easy to be misidentified. In Liu *et.al.*[11], the contours-based algorithm relies on good contour extraction. It is sensitive to luminance variation of steel surface and edge blurring of steel bars. The proposed method has better robustness for above disturbance.

TABLE II
THE COMPARISON BETWEEN CNN-DC AND OTHER METHODS

Average	Recall	Precision	F1	Acc_r	$offset$	times(s)
Zhang <i>et.al.</i> [7]	0.8864	0.9360	0.9103	94.69%	15.83%	0.3023
Ying <i>et.al.</i> [8]	0.9617	0.8417	0.8975	85.68%	12.58%	0.2404
Ghazali <i>et.al.</i> [10]	0.9778	0.9366	0.9566	95.56%	10.30%	0.1346
Liu <i>et.al.</i> [11]	0.8123	0.6833	0.7420	80.99%	25.58%	0.0313
Proposed	0.9951	0.9976	0.9963	99.26%	4.11%	3.5862

2) *The Second Experiment*: In the first experiment, it has been demonstrated that CNN-DC performs well on steel bar counting and center localization. In order to further demonstrate the effectiveness of CNN-DC, we compare CNN-DC with other existing methods on the steel bar dataset. From TABLE II, it can be observed that CNN-DC outperforms other methods in terms of Recall, Precision, F1, Acc_r and $offset$. As shown in Fig. 9, the result obtained by other methods is sensitive to environmental disturbance, luminance variation of steel surface and edge blurring of steel bars. The proposed method has better robustness for challenging environments. Although the calculation time of CNN-DC is higher than other methods, it can be reduced by model acceleration methods. With the help of network binarization[34], structured pruning[35] and matrix decomposition[36], the calculation time can be further reduced and will be the next step in our future work.

3) *The Third Experiment*: In our work, $stride = 6$ and $th_d = 20$ are used, which were selected based on the experiments on the training data of the steel bar dataset. In order to illustrate the reasons of choosing these values, the variations of the evaluation metrics: Recall, Precision, F1, $offset$ and the calculation time on the training data of the steel bar dataset by varying $stride$ and th_d are given in Fig. 10 and 11. From Fig. 10, it can be observed that CNN-DC can have a good performance on the training data of the steel bar dataset as $stride$ varies in [1,9]. In the meantime, CNN-DC can have a low calculation time as $stride$ varies in [5,18]. From the above observation, CNN-DC performs overall better as $stride$ varies in [5,9], and $stride = 6$ is chosen randomly from [5,9]. From Fig. 11, it can be observed that CNN-DC can maintain high scores of Recall, Precision, F1 and Acc_r as th_d varies in [11,51]. CNN-DC can also have a low $offset$ value as th_d varies in [1,51]. Moreover, the calculation time varies very slightly with change of th_d . From the above observation, CNN-DC can obtain a good performance as th_d varies [11,51], and $th_d = 20$ is selected randomly from [11,51].

V. CONCLUSIONS

Automated steel bar counting and center localization are of great significance in factory automation of steel bars. Steel bar counting and center localization are traditionally performed by skilled workers, which are tedious and time-consuming. In order to alleviate the burdens of workers on steel bar counting and center localization, an effective end-to-end framework called CNN-DC is proposed to achieve steel bar counting and center localization simultaneously. The proposed CNN-DC framework first performs candidate center point detection

with a deep convolutional neural network, which is followed by a Distance Clustering algorithm to cluster the candidate center points and obtain the center locations of steel bars. The experimental results show that the proposed CNN-DC framework performs well on steel bar counting and center localization, achieving $Recall = 0.9951$, $Precision = 0.9976$, $F1 = 0.9963$, $Acc_r = 99.26\%$, $offset = 4.11\%$ and $time = 3.5862s$.

In the future, more steel bar images will be collected by negotiating with the managers of steel bar factories in order to further validate the effectiveness of CNN-DC. Applying CNN-DC real time in steel bar factories is also planned in order to validate the practicability of the proposed method.

REFERENCES

- [1] V. E. Wagner, A. A. Andreshak, and J. P. Staniak, "Power quality and factory automation," *IEEE Transactions on Industry Applications*, vol. 26, no. 4, pp. 620–626, 1990.
- [2] Y. Miyatake and R. Kangari, "Experiencing computer integrated construction," *Journal of Construction Engineering and Management*, vol. 119, no. 2, pp. 307–322, 1993.
- [3] H.-J. Korber, H. Wattar, and G. Scholl, "Modular wireless real-time sensor/actuator network for factory automation applications," *IEEE Transactions on Industrial Informatics*, vol. 3, no. 2, pp. 111–119, 2007.
- [4] A. Grau, M. Indri, L. L. Bello, and T. Sauter, "Industrial robotics in factory automation: From the early stage to the internet of things," in *IECON 2017-43rd Annual Conference of the IEEE Industrial Electronics Society*. IEEE, 2017, pp. 6159–6164.
- [5] M. Dotoli, A. Fay, M. Miśkiewicz, and C. Seatzu, "Advanced control in factory automation: a survey," *International Journal of Production Research*, vol. 55, no. 5, pp. 1243–1259, 2017.
- [6] M. Dotoli, A. Fay, M. Mikowicz, and C. Seatzu, "An overview of current technologies and emerging trends in factory automation," *International Journal of Production Research*, pp. 1–21, 2018.
- [7] D. Zhang, Z. Xie, and C. Wang, "Bar section image enhancement and positioning method in on-line steel bar counting and automatic separating system," in *Image and Signal Processing, 2008. CISP'08. Congress on*, vol. 2. IEEE, 2008, pp. 319–323.
- [8] X. Ying, X. Wei, Y. Pei-xin, H. Qing-da, and C. Chang-hai, "Research on an automatic counting method for steel bars' image," in *Electrical and Control Engineering (ICECE), 2010 International Conference on*. IEEE, 2010, pp. 1644–1647.
- [9] Y. Wu, X. Zhou, and Y. Zhang, "Steel bars counting and splitting method based on machine vision," in *Cyber Technology in Automation, Control, and Intelligent Systems (CYBER), 2015 IEEE International Conference on*. IEEE, 2015, pp. 420–425.
- [10] M. F. Ghazali, L.-K. Wong, and J. See, "Automatic detection and counting of circular and rectangular steel bars," in *9th International Conference on Robotic, Vision, Signal Processing and Power Applications*. Springer, 2017, pp. 199–207.
- [11] L. Xiaohu and O. Jineng, "Research on steel bar detection and counting method based on contours," in *2018 International Conference on Electronics Technology (ICET)*. IEEE, 2018, pp. 294–297.
- [12] S. Ren, K. He, R. Girshick, and J. Sun, "Faster R-CNN: towards real-time object detection with region proposal networks," *IEEE Transactions on Pattern Analysis & Machine Intelligence*, no. 6, pp. 1137–1149, 2017.

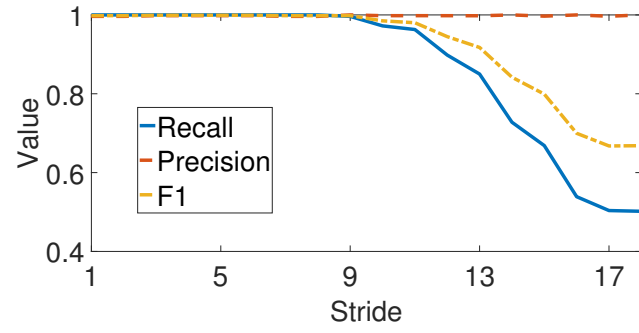

(a)

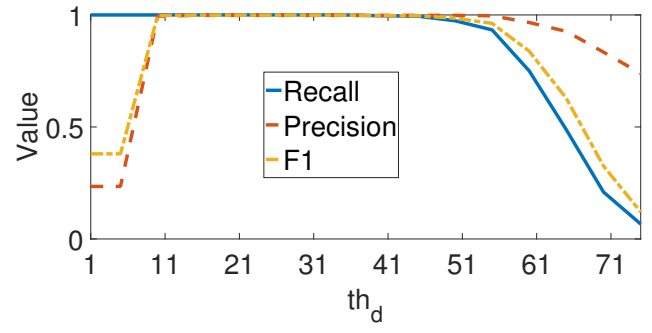

(a)

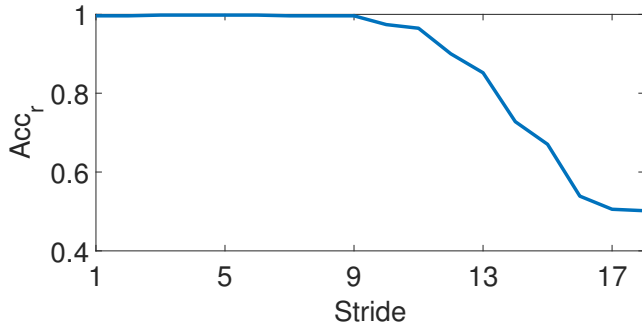

(b)

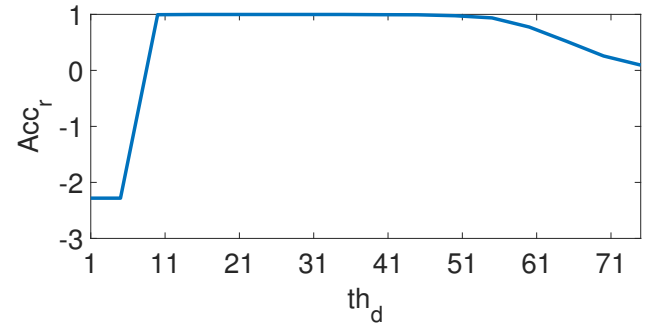

(b)

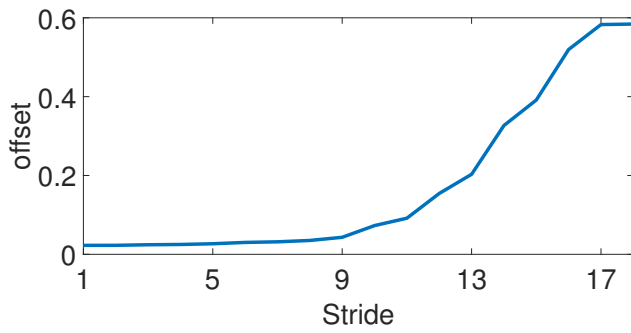

(c)

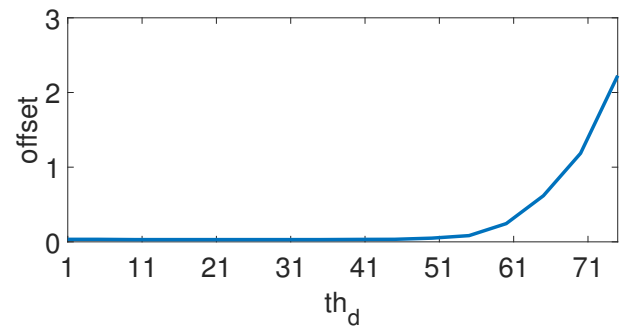

(c)

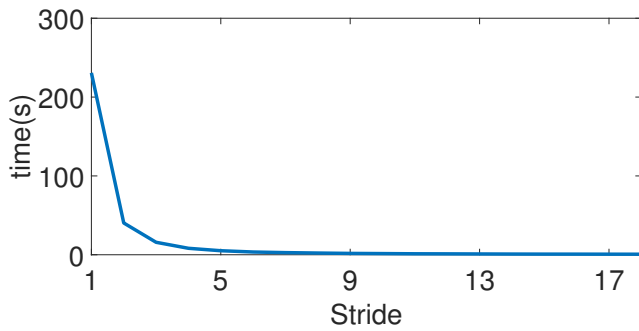

(d)

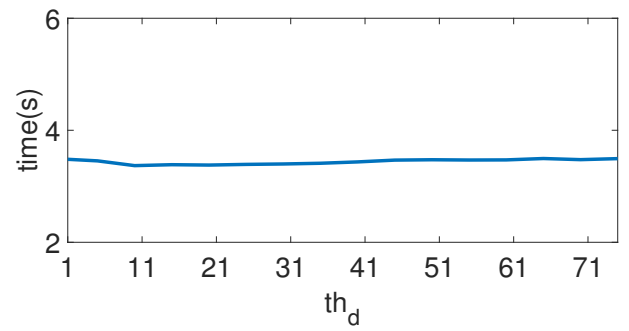

(d)

Fig. 10. Variations of different evaluation metrics on the training data of the steel bar dataset with the increase of stride. (a) The variations of Recall, Precision and F1 with the increase of stride. (b) The variation of Acc_r with the increase of stride. (c) The variation of offset with the increase of stride. (d) The variation of calculation time with the increase of stride.

Fig. 11. Variations of different evaluation metrics on the training data of the steel bar dataset with the increase of th_d . (a) The variations of Recall, Precision and F1 with the increase of th_d . (b) The variation of Acc_r with the increase of th_d . (c) The variation of offset with the increase of th_d . (d) The variation of calculation time with the increase of th_d .

- [13] M. Matsugu, K. Mori, Y. Mitari, and Y. Kaneda, "Subject independent facial expression recognition with robust face detection using a convolutional neural network," *Neural Networks*, vol. 16, no. 5-6, pp. 555–559, 2003.
- [14] Y. LeCun, L. Bottou, Y. Bengio, and P. Haffner, "Gradient-based learning applied to document recognition," *Proceedings of the IEEE*, vol. 86, no. 11, pp. 2278–2324, 1998.
- [15] O. Abdel-Hamid, A.-r. Mohamed, H. Jiang, L. Deng, G. Penn, and D. Yu, "Convolutional neural networks for speech recognition," *IEEE/ACM Transactions on Audio, Speech, and Language Processing*, vol. 22, no. 10, pp. 1533–1545, 2014.
- [16] U. R. Acharya, S. L. Oh, Y. Hagiwara, J. H. Tan, and H. Adeli, "Deep convolutional neural network for the automated detection and diagnosis of seizure using eeg signals," *Computers in Biology and Medicine*, vol. 100, pp. 270–278, 2018.
- [17] B. Hu, Z. Lu, H. Li, and Q. Chen, "Convolutional neural network architectures for matching natural language sentences," in *Advances in Neural Information Processing Systems*, 2014, pp. 2042–2050.
- [18] H. Su, S. Maji, E. Kalogerakis, and E. Learned-Miller, "Multi-view convolutional neural networks for 3D shape recognition," in *Proceedings of the IEEE International Conference on Computer Vision*, 2015, pp. 945–953.
- [19] J. Sun, W. Cao, Z. Xu, and J. Ponce, "Learning a convolutional neural network for non-uniform motion blur removal," in *Proceedings of the IEEE Conference on Computer Vision and Pattern Recognition*, 2015, pp. 769–777.
- [20] R. Sakurai, S. Yamane, and J.-H. Lee, "Restoring aspect ratio distortion of natural images with convolutional neural network," *IEEE Transactions on Industrial Informatics*, vol. 15, no. 1, pp. 563–571, 2019.
- [21] Z. Zheng, Y. Yang, X. Niu, H.-N. Dai, and Y. Zhou, "Wide and deep convolutional neural networks for electricity-theft detection to secure smart grids," *IEEE Transactions on Industrial Informatics*, vol. 14, no. 4, pp. 1606–1615, 2017.
- [22] H. Gao, B. Cheng, J. Wang, K. Li, J. Zhao, and D. Li, "Object classification using cnn-based fusion of vision and lidar in autonomous vehicle environment," *IEEE Transactions on Industrial Informatics*, vol. 14, no. 9, pp. 4224–4231, 2018.
- [23] A. Krizhevsky, I. Sutskever, and G. E. Hinton, "Imagenet classification with deep convolutional neural networks," in *Advances in Neural Information Processing Systems*, 2012, pp. 1097–1105.
- [24] T. Zhang, R. Ramakrishnan, and M. Livny, "Birch: an efficient data clustering method for very large databases," in *ACM Sigmod Record*, vol. 25, no. 2. ACM, 1996, pp. 103–114.
- [25] G. Karypis, E.-H. S. Han, and V. Kumar, "Chameleon: Hierarchical clustering using dynamic modeling," *Computer*, no. 8, pp. 68–75, 1999.
- [26] J. A. Hartigan and M. A. Wong, "Algorithm as 136: A K-means clustering algorithm," *Journal of the Royal Statistical Society. Series C (Applied Statistics)*, vol. 28, no. 1, pp. 100–108, 1979.
- [27] R. T. Ng and J. Han, "Clarans: A method for clustering objects for spatial data mining," *IEEE Transactions on Knowledge & Data Engineering*, no. 5, pp. 1003–1016, 2002.
- [28] M. Ester, H.-P. Kriegel, J. Sander, X. Xu *et al.*, "A density-based algorithm for discovering clusters in large spatial databases with noise," in *ACM SIGKDD Conference on Knowledge Discovery and Data Mining(KDD)*, vol. 96, no. 34, 1996, pp. 226–231.
- [29] A. Rodriguez and A. Laio, "Clustering by fast search and find of density peaks," *Science*, vol. 344, no. 6191, pp. 1492–1496, 2014.
- [30] M. Ankerst, M. M. Breunig, H.-P. Kriegel, and J. Sander, "Optics: ordering points to identify the clustering structure," in *ACM Sigmod Record*, vol. 28, no. 2. ACM, 1999, pp. 49–60.
- [31] J. S. Armstrong and F. Collopy, "Error measures for generalizing about forecasting methods: Empirical comparisons," *International journal of forecasting*, vol. 8, no. 1, pp. 69–80, 1992.
- [32] L. Bottou, "Stochastic gradient descent tricks," in *Neural networks: Tricks of the trade*. Springer, 2012, pp. 421–436.
- [33] M. Abadi, P. Barham, J. Chen, Z. Chen, A. Davis, J. Dean, M. Devin, S. Ghemawat, G. Irving, M. Isard *et al.*, "Tensorflow: A system for large-scale machine learning," in *12th {USENIX} Symposium on Operating Systems Design and Implementation ({OSDI} 16)*, 2016, pp. 265–283.
- [34] M. Rastegari, V. Ordonez, J. Redmon, and A. Farhadi, "Xnor-net: Imagenet classification using binary convolutional neural networks," in *European Conference on Computer Vision*. Springer, 2016, pp. 525–542.
- [35] J.-H. Luo, J. Wu, and W. Lin, "Thinet: A filter level pruning method for deep neural network compression," in *Proceedings of the IEEE international conference on computer vision*, 2017, pp. 5058–5066.
- [36] Y.-D. Kim, E. Park, S. Yoo, T. Choi, L. Yang, and D. Shin, "Compression of deep convolutional neural networks for fast and low power mobile applications," *arXiv preprint arXiv:1511.06530*, 2015.