

# Snapshot-Free, Transparent, and Robust Memory Reclamation for Lock-Free Data Structures

Ruslan Nikolaev  
rnikola@vt.edu

Department of Electrical and Computer Engineering  
Virginia Tech  
Blacksburg, VA, USA

Binoy Ravindran  
binoy@vt.edu

Department of Electrical and Computer Engineering  
Virginia Tech  
Blacksburg, VA, USA

## Abstract

We present a family of safe memory reclamation schemes, Hyaline, which are fast, scalable, and transparent to the underlying lock-free data structures. Hyaline is based on reference counting – considered impractical for memory reclamation in the past due to high overheads. Hyaline uses reference counters only during reclamation, but not while accessing individual objects, which reduces overheads for object accesses. Since with reference counters, an arbitrary thread ends up freeing memory, Hyaline’s reclamation workload is (almost) balanced across all threads, unlike most prior reclamation schemes such as epoch-based reclamation (EBR) or hazard pointers (HP). Hyaline often yields (excellent) EBR-grade performance with (good) HP-grade memory efficiency, which is a challenging trade-off with all existing schemes.

Hyaline schemes offer: (i) high *performance*; (ii) good memory *efficiency*; (iii) *robustness*: bounding memory usage even in the presence of stalled threads, a well-known problem with EBR; (iv) *transparency*: supporting virtually unbounded number of threads (or concurrent entities) that can be created and deleted dynamically, and effortlessly join existent workload; (v) *autonomy*: avoiding special OS mechanisms and being non-intrusive to runtime or compiler environments; (vi) *simplicity*: enabling easy integration into unmanaged C/C++ code; and (vii) *generality*: supporting many data structures. All existing schemes lack one or more properties.

We have implemented and tested Hyaline on x86(-64), ARM32/64, PowerPC, and MIPS. The general approach requires LL/SC or double-width CAS, while a specialized version also works with single-width CAS. Our evaluation reveals that Hyaline’s throughput is very high – it steadily outperforms EBR by 10% in one test and yields **2x** gains in oversubscribed scenarios. Hyaline’s superior memory efficiency is especially evident in read-dominated workloads.

PLDI '21, June 20–25, 2021, Virtual, Canada

© 2021 Copyright held by the owner/author(s). Publication rights licensed to ACM.

This is the author’s version of the work. It is posted here for your personal use. Not for redistribution. The definitive Version of Record was published in *Proceedings of the 42nd ACM SIGPLAN International Conference on Programming Language Design and Implementation (PLDI '21), June 20–25, 2021, Virtual, Canada*, <https://doi.org/10.1145/3453483.3454090>.

**CCS Concepts:** • Theory of computation → Concurrent algorithms.

**Keywords:** lock-free, non-blocking, memory reclamation, hazard pointers, epoch-based reclamation

## 1 Introduction

Modern computer systems increasingly rely on parallelism. Programming paradigms are also changing accordingly: the use of scalable non-blocking data structures is preferred to more traditional lock-based approaches.

Aside from general memory allocation and reclamation problems, non-blocking data structures also present a number of unique challenges that do not manifest in lock-based programming. One of the most fundamental problems for lock-free data structures that use dynamic memory allocation is that memory objects need to be *safely* deallocated. The problem arises when one thread wants to deallocate a memory object, but concurrent threads still have stale pointers and are unaware of ongoing memory deallocation. Garbage collectors avoid this problem by deferring the deallocation until no thread has pointers to the deallocated memory object. However, *fully* lock-free garbage collectors are challenging to design, especially with consistent and limited overheads.

Moreover, it is often impractical to use garbage collectors in languages that are designed for unmanaged code such as C and C++. To support concurrent data structures in unmanaged languages, a number of techniques have been developed for safe memory reclamation (or SMR). Many existing approaches for SMR originate from, or improve upon, epoch-based reclamation (EBR) [24, 26] and hazard pointers (HP) [32]. Unlike garbage collectors, these schemes do not *automatically* determine when memory becomes free. Instead, such schemes are predicated on *user-specified retire* statements, which are roughly analogous to *free*, with the only difference being that *retire* does not necessarily deallocate memory right away.

EBR uses a simple API and achieves good performance, but lacks protection against stalled threads. This can prevent timely reclamation, resulting in blocking behavior due to memory exhaustion. HP does not suffer from this problem, but is harder to use and slower in practice. Some of the other SMR algorithms [11–13, 15, 42] rely on special operating system (OS) abstractions, which make them difficult to use

arXiv:1905.07903v2 [cs.DC] 1 May 2021

in certain settings such as within OS kernels or platform-independent code. In general, all SMR schemes have different trade-offs in terms of API simplicity, throughput, average memory efficiency, and protection against stalled threads.

Although a number of existing SMR schemes [24, 39, 44] achieve excellent throughput, their memory efficiency is limited. An implicit assumption of these algorithms is that all threads get more or less *even* shares of memory objects to reclaim. In most existing SMR schemes, a thread that detaches an object from a data structure must eventually reclaim it. This can cause an unbalanced reclamation workload, especially in read-dominated scenarios, where most threads are reading and only a fraction of them modifies data (see examples in Section 6). When most threads are reading and are therefore not deallocating, the reclamation parallelism is reduced, which degrades memory efficiency. To make matters worse, threads also need to periodically peruse their local lists of not-yet-reclaimed objects to check if an object can be safely reclaimed (as in HP) or check the status of all threads to advance an epoch (as in EBR). The reclamation workload that is skewed toward the writer threads and consequent delayed reclamation can eventually degrade performance (see Section 6). Such performance degradation becomes even more evident in oversubscribed scenarios where there are more threads than cores available. Note that oversubscription is not that uncommon in practice (e.g., consider Go, Erlang, and proposed C++23 concurrency constructs).

Lock-free reference counting (LFRC) [33, 43], another SMR discipline, enables better parallelism in theory: a thread with the last reference frees an object, which often means that an *arbitrary* thread ends up freeing memory. Unfortunately, LFRC typically performs poorly since every object access, even just for reading, requires memory writes and barriers.

In this paper, we revisit reference counting – considered impractical for concurrent algorithms in the past – and design an SMR scheme called Hyaline (Sections 3 and 4). The key idea of Hyaline is to actively use reference counters only during reclamation, but not while accessing individual objects. This reduces overheads for object accesses, while ensuring that the reclamation workload is balanced across all threads, yielding excellent performance as well as excellent memory efficiency. We establish Hyaline’s core properties including reclamation safety, lock-freedom, reclamation cost bounds, and robustness (Section 5).

Hyaline also has a number of other important properties. Unlike most SMR algorithms, which typically require *globally visible*, private, per-thread state (either in static arrays or in dynamically managed lists), Hyaline supports virtually unbounded number of threads using a relatively small (fixed) number of shared *slots*, entities that can be shared by multiple threads. Since Hyaline’s reclamation is asynchronous (i.e., any thread can free memory allocated by any thread), threads can immediately be recycled without worrying about the fate of its previously deleted but not-yet-freed objects. These

two properties ensure that Hyaline is less intrusive to applications, enabling its greater *transparency*. Hyaline is also well suited for preemptive environments where the number of threads substantially exceeds the number of cores and can change dynamically such as in OS kernels<sup>1</sup> and server applications with per-client threads (or fibers).

We have implemented and evaluated Hyaline on a variety of architectures including x86(-64), ARM32/64, PowerPC, and MIPS (Section 6). Our experimental results reveal that, in a number of cases, Hyaline demonstrates both excellent throughput as well as excellent memory efficiency, which is difficult for many past SMR schemes to achieve together. Hyaline’s substantial throughput gains are also evident: in the Bonsai Tree benchmark, Hyaline’s steady gains over EBR, one of the fastest schemes, are  $\approx 10\%$ . In oversubscribed scenarios, Hyaline particularly shines: up to **2x** throughput gains for high-throughput data structures.

We also present an extension of Hyaline, called Hyaline-S, to deal with stalled threads (Section 4). Similar to EBR, basic Hyaline’s memory usage can become unbounded if some threads are stalled. We partially adopt the *birth eras* idea, inspired by similar usage in interval-based reclamation (IBR) [44] and hazard eras (HE) [39], and demonstrate how this idea helps to deal with stalled threads in Hyaline-S.

The paper’s research contribution is the Hyaline algorithm and its variants, which are the first SMR schemes that achieve excellent performance, memory efficiency, and other aforementioned properties over a broad range of workloads including read-dominated and oversubscribed scenarios.

## 2 Background

For greater clarity and completeness, we discuss properties and challenges of the existent memory reclamation schemes.

**Read-Modify-Write.** Lock-free algorithms typically use read-modify-write (RMW) operations, which atomically read a memory variable, perform some operation on it, and write back the result. Modern CPUs implement RMWs via compare-and-swap (CAS) or a pair of load-link (LL)/store-conditional (SC) instructions. For better scalability, some CPUs [4] support specialized fetch-and-add (FAA) and *swap* operations. Also, x86-64 and ARM64 support operations on two adjacent CPU words (double-width RMW) via the `cmpxchg16b` [4] and `ldaxp/stlxp` [2] instructions, respectively.

Hyaline requires either double-width CAS, or ordinary LL/SC (see Appendix A regarding LL/SC and PowerPC) since a reference counter needs to be coupled with a pointer in some places. In rare cases, such as in SPARC [7], where neither is supported, reference counters can be squeezed with pointers. (SPARC uses 54-bit virtual addresses; 48-bit cache-line aligned pointers where lower 6 bits are 0s can be

<sup>1</sup>Specifically, this is useful for global data structures within OS kernels that support kernel-mode preemption, e.g., Linux. We also have preliminary results with experimental OS designs [37].

squeezed with 16-bit counters.) We also present a specialized Hyaline-1 version for single-width CAS.

**API Model.** We focus on the SMR problem in unmanaged code environments such as C/C++. Hyaline’s and Hyaline-1’s basic programming model is similar to that of EBR [24] and is defined as follows. Memory objects are allocated using standard OS-defined means. They additionally incorporate SMR-related headers and are initialized appropriately. Once memory objects appear in a lock-free data structure, they must be reclaimed using a two-step procedure. After deleting a pointer from the data structure, a memory object needs to be *retired*. A memory object is returned to the OS only after the object becomes unreachable by any other concurrent thread. All data structure operations must be encapsulated between *enter* and *leave* calls that trigger the use of SMR.

**Robustness.** One of the biggest downsides of the simplistic API model described above is that memory usage becomes unbounded in the presence of stalled threads. We call an algorithm *robust* if it bounds memory usage for stalled threads.<sup>2</sup>

HP [32] was among the first to recognize this problem and propose a safer API model, which wraps every pointer access. HP more precisely tracks retired objects using pointers and assigns special indices to accessed objects. HE [39] adopted the same API model but proposed to internally record eras (epochs) rather than pointers. More recently, IBR [44] simplified HE’s API by abolishing indices when wrapping pointers, bringing it closer to the original EBR model.

We added additional robustness guarantees to Hyaline and Hyaline-1 by extending the API with a pointer wrapper method, *deref*, as in IBR. Our robust schemes, Hyaline-S and Hyaline-1S, adopt the birth eras approach from HE and IBR to guard against stalled threads. The main idea is to mark each allocated object with the global counter, so that stalled threads will only hold older objects. Note that whereas HE and IBR also use retire eras to identify reclamation intervals, Hyaline relies on reference counting.

**Reclamation Cost.** Many reclamation schemes have a non-constant reclamation cost. For example, HP, HE, and IBR need to periodically peruse thread local lists of not-yet-reclaimed objects to check if an object can be safely reclaimed. Hyaline does not need to periodically check thread local lists. We discuss and prove reclamation costs in Section 5.

**Transparency.** Most existing SMR schemes maintain special entries throughout thread lifecycles – e.g., static arrays indexed by thread IDs. In practice, threads can be created and deleted dynamically, and practical implementations [3] maintain lists rather than arrays with per-thread entries.

<sup>2</sup>Sometimes, this property is also called “lock-freedom” (memory-wise). Since memory is finite, stalled threads prevent other threads from allocating memory when memory is exhausted. We use the terminology from [13, 21, 44] to capture this property more precisely.

<sup>3</sup>Hyaline-S adaptively changes the number of slots to guarantee robustness.

However, this puts an extra burden on programmers who have to explicitly register and unregister threads. This also breaks seamless integration, as concurrent data structures cannot be accessed outside thread contexts – e.g., signal handlers or OS interrupt contexts. Moreover, unregistration is blocking, as a thread needs to complete deallocation, which is impossible until all other threads promise not to access its locally retired objects. In Hyaline, threads can completely forget about previously retired objects after calling *leave*, as they are already (or will be) taken care for by the remaining threads. (In Section 3.2, *retire* uses local batches, but they can be immediately finalized by allocating a finite number of dummy nodes.) We call a scheme *transparent* if it avoids the problems mentioned above.

**Snapshot-Freedom.** To make certain schemes (HP, HE, IBR, etc) more efficient, when examining what objects can be deleted safely, a *snapshot* of global state (i.e., all hazard pointers or eras) is taken. The per-thread snapshot sidesteps expensive cache misses since it can be consulted repeatedly for *all* not-yet-freed objects. Per-thread snapshots are typically preallocated, resulting in extra  $O(n^2)$  memory usage, which is substantial as the number of threads,  $n$ , grows. Furthermore, pre-allocated memory needs to be expanded if the number of threads grows dynamically, which presents additional challenges for *transparency*. In contrast, EBR consults the global state only once per each examination and does not take snapshots. All Hyaline schemes are also snapshot-free.

**Semantics.** Most robust schemes provide different semantics in handling memory objects that have never been dereferenced. Whereas non-robust schemes, such as EBR, can work with the original lock-free linked list [25], robust schemes (HP, HE, and IBR) require a modification [32] that timely retires deleted list nodes. Our non-robust and robust Hyaline schemes have a similar distinction. FreeAccess [17] – a recent scheme – specifically tackles the semantics problem. The scheme is still robust, but falls short on transparently handling the *swap* operation (can be used for better scalability), and needs compiler modifications. It also uses a garbage collector which is undesirable when fully transparent memory management is needed, such as in OS kernels.

**Memory Overhead (Header Size).** SMR schemes also differ in extra memory required per each node. For example, EBR, HP, and PEBR store a (thread-local) list pointer per node. HE and IBR additionally require two 64-bit eras. All Hyaline variants require 3 words which is equivalent to HE and IBR for 64-bit CPUs and more efficient for 32-bit CPUs.

Although EBR/HP/PEBR’s overhead can be fully eliminated by allocating an intermediate container object when retiring, this causes undesirable circular allocator dependency. In the same vein, HE, IBR, and Hyaline schemes can reduce the overhead to just 1 word.

**Table 1.** Comparison of Hyaline with existing SMR approaches.

Scheme	Based on	Performance	Robust	Transparent	Header Size	Usage/API
LFRC [33, 43]	-	Very Slow	Yes	Partially (swap)	N/A, but 1 extra word per pointer	Harder, intrusive
HP [32]	-	Slow	Yes	No (retire)	1 word	Harder
EBR [24, 26]	RCU [31]	Fast	No	No (retire)	1 word	Very easy
DEBRA+ [15]	EBR	Fast	Partially	No (OS)	1 word + desc	Harder
PEBR [30]	EBR, HP	Medium	Yes	No (retire, OS)	1 word	Medium
HE [39]	EBR, HP	Medium	Yes	No (retire)	3 words (64 bit)	Harder
IBR (2GE) [39]	EBR, HP	Fast	Yes	No (retire)	3 words (64 bit)	Medium
FreeAccess [17]	AOA [18]	Fast	Yes	Partially (swap, GC)	GC tracking	Modified compiler
<b>Hyaline</b>	-	Fast	No	<b>Yes</b>	3 words	<b>Very easy</b>
Hyaline-1	-	Fast	No	Partially	3 words	Very easy
<b>Hyaline-S</b>	Hyaline, part. HE/IBR	Fast	<b>Yes</b> <sup>3</sup>	<b>Yes</b>	3 words	<b>Medium</b>
Hyaline-1S	Hyaline-1, part. HE/IBR	Fast	Yes	Partially	3 words	Medium

**Summary.** Existing approaches are discussed in detail in Section 7. Table 1 presents a qualitative and quantitative comparison of Hyaline with other schemes on metrics including performance, robustness, and transparency. We also categorize API as hard, medium, etc., similar to the discussion in [44]. Although this categorization is somewhat subjective, we note that the medium difficulty in robust Hyaline-S and Hyaline-1S implies that *deref* on pointers can be fully hidden using standard language idioms, such as smart pointers in C++, and no extra programming language or OS support is needed. This is not true for schemes that rely on OS mechanisms. Furthermore, schemes that use HP’s API require assigning indices to reserved objects and annotating where a pointer is used for the last time. These cannot be hidden in smart pointers easily and need to be handled explicitly by a programmer.

### 3 Hyaline

Hyaline is a member of the family of memory reclamation techniques where programs explicitly retire objects and ensure that retired objects are not reachable from subsequent operations on the data structures. In addition, each operation on the data structures must be enclosed between *enter* and *leave* calls as presented in Figure 1. Hyaline keeps track of all active threads using *special* reference counters. Those counters are not typical and do not represent the number of references to objects directly. Unlike traditional per-object counting, the use of reference counters is triggered only when handling retired objects (nodes). Thus, insertions and read-only traversals avoid expensive (and inconvenient) per-access counting.

```

handle_t Handle = enter();
// deref is for Hyaline-S,
// not needed in Hyaline
List = deref(&LinkedList);
Node = deref(&List->Next);
retire(Node);
// Do something else...
leave(Handle);
// Transparency: the thread
// need not check any of the
// retired nodes after this

```

**Figure 1.** Hyaline’s transparent API.

#### 3.1 Simplified Version

We first describe a simpler version of Hyaline that manipulates only a single *retirement list*. This version is more prone to CAS contention, a problem addressed by a scalable version that we present in Section 3.2.

Hyaline’s key idea is that all threads participate in the tracking of retired nodes in the global list even if they are not actively retiring any nodes themselves. A special *Head* tuple is associated with the retirement list. The tuple consists of *HPtr* and *HRef* fields. *HPtr* is a pointer to the beginning of the list, and *HRef* counts the number of active threads. Initially, when the list is empty, *HPtr* = *Null* and *HRef* = 0.

When each thread *enters*, it atomically increments the *HRef* field to indicate that a new thread has arrived. At the same time, the thread records a snapshot value of *HPtr* at the moment it entered. The thread stores this snapshot value in a special per-thread *Handle* variable. Since updates on the [*HRef*, *HPtr*] tuple have to be atomic, we use double-width RMW to update *Head*.

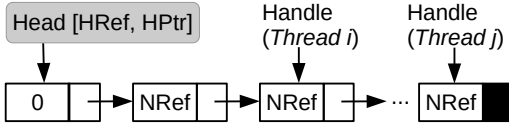

Figure 2. (Simplified) Hyaline: List of retired nodes.

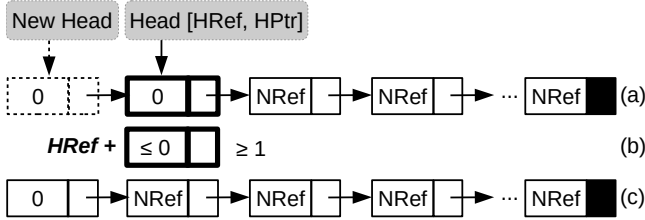

Figure 3. (Simplified) Hyaline: Adjusting the reference counter of a predecessor node when retiring.

As nodes are *retired*, threads append them to the list (Figure 2). Since nodes need to be connected in the list, each node incorporates a special header in addition to any other fields used for representing the encapsulating data structure. The header contains Next and NRef fields. Next is a pointer to the next node in the list, and NRef of every non-Head node counts threads that can still access this node. For the very first node, HRef itself serves this purpose. (We will describe how NRef is initialized later.)

When a thread completes a data structure operation (*leaves*), it decrements HRef to indicate that one thread has just left. Simultaneously, it retrieves the HPtr pointer and then traverses a sublist of nodes from HPtr to Handle that were retired since it initiated the operation (*enter*). While traversing the sublist, the thread decrements NRef counters for every non-Head node. The first node’s counter (HRef) is already decremented. A node is freed when its counter becomes 0.

Using HRef for the first node prevents the ABA problem as a thread has a reference to every node through its Handle inclusively – i.e., no other thread can recycle these nodes.

We now describe how NRef values get propagated across the list. When retiring a node, its NRef is set to 0, as the actual counter for the very first node in the list is inferred from the HRef field of Head. As threads insert retired nodes, they initialize Next and atomically update Head (shown with dashed lines in Figure 3, part (a)). NRef of the predecessor is initially 0. However, since a node was just added, the predecessor is no longer the first node, and any concurrent thread may decrement its NRef, converting it to a negative value, but will not deallocate this predecessor (NRef must become 0 for the node to be deallocated). Finally, the current thread atomically adds the snapshot value of HRef (obtained while appending the new node) to the NRef field of the predecessor, and its new *adjusted* value becomes  $\geq 1$  (Figure 3, part (b)). Retiring is now complete (Figure 3, part (c)).

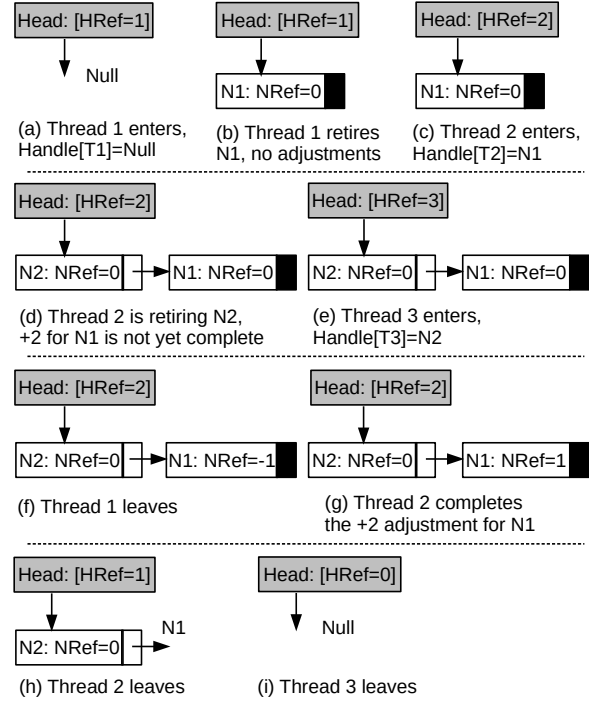

Figure 4. Example for single-list Hyaline, Nx is a node.

Essentially, NRef is the difference between two logical variables: the number of times the node is acquired and the number of times it is released. Due to concurrency interleaving, NRef is relaxed and can be negative.

Figure 4 shows an example with 3 threads. Initially, HRef is 0 and HPtr is Null. (a) Thread 1 calls *enter* to atomically increment HRef and retrieve its handle. (b) Thread 1 retires node N1; as the list is empty, there is no predecessor to adjust. (c) Thread 2 enters, but (d) it stalls while retiring N2. Meanwhile, (e) Thread 3 enters. (f) Thread 1 leaves and dereferences all nodes in the list through its handle Null. Since N2 is the first node, HRef is decremented, but N2’s NRef field remains intact. N1 stays as its NRef is now negative. (g) Thread 2 resumes and completes its adjustment for N1. (h) Thread 2 then leaves, dereferences all nodes, and deallocates N1. (i) Finally, Thread 3 leaves and deallocates N2.

Although this version is not yet optimized for performance, we make one important observation regarding the algorithm’s asynchronous tracking mentioned in introduction: threads traverse lists just once when dereferencing nodes in *leave*. This is unlike EBR, where all threads are periodically checked if they are past the retired node(s) epoch. Section 6 reveals this to be Hyaline’s advantage for oversubscribed tests.

**Alternative Designs.** Hyaline carefully avoids the ABA problem which is possible with other designs. A straightforward alternative is to use NRef in the first node as usual, i.e., to indicate its reference counter. HRef can then indicate

the reference counter of the node to be retired in the future. However, this design triggers the ABA problem, as the node pointed to by `Handle` (end-of-list marker) can be recycled and may reappear in the retirement sublist when `leave` is called. The sublist will get truncated, and the remaining nodes will never be dereferenced. An extra ABA tag could prevent this problem but `Head` already needs double-width operations.

`NRef` could also store the reference counter of the next rather than the current node. `HRef` would indicate the reference counter of the first node as in `Hyaline`. While this design is ABA-free, it has a major drawback: nodes must be dereferenced in the reversed order, as they are dependent on each other. It complicates the implementation, as backward links also need to be stored. Moreover, `Head` cannot be updated until the retirement sublist is fully traversed, and by that time, other nodes may already be retired. If deallocation is slow, one unlucky thread can easily get stuck in a state where it has to constantly deallocate nodes retired by other threads. Other threads will simply continue dereferencing their counters and keep retiring more and more nodes. `Hyaline` avoids this problem by immediately decrementing `HRef`, as all nodes are independent from each other there.

### 3.2 Scalable Multiple-List Version

If deletions are frequent, `retire` calls may create contention on `Head`. To alleviate the contention, threads create local lists of nodes to be retired. Threads retire entire batches of nodes and keep a single reference counter per batch rather than individual nodes. Batches do not have direct analogues in epoch-based approaches, where all retired nodes are always in thread-local lists. However, batch size (the number of nodes in a batch) impacts the cost of retirement in a way that is similar to the frequency of epoch counter increments.

Frequent `enter` and `leave` calls also create contention on `Head`, which is undesirable for high-throughput data structures. To address this problem, we introduce the concept of `slots`, which a thread chooses randomly or based on its ID. Slots do not need to be statically assigned: they can change from one operation to another. Each slot has its own `Head`, and thus, we end up with multiple retirement lists. When a batch is retired, it needs to be added to each slot that has its `HRef`  $\neq 0$  (i.e., slots with active threads).

Since batches are added atomically only to one slot at a time, slots may end up with non-identical order of batches. To support this, we need individual list pointers. We take advantage of the fact that we retire entire batches rather than nodes. To that end, we require the number of nodes in batches to be strictly greater than the number of slots. Each node in a batch keeps the `Next` pointer for the corresponding slot's retirement list, and one additional node will keep the per-batch `NRef` counter instead. Additionally, all nodes in the batch are linked together, and each node has an extra

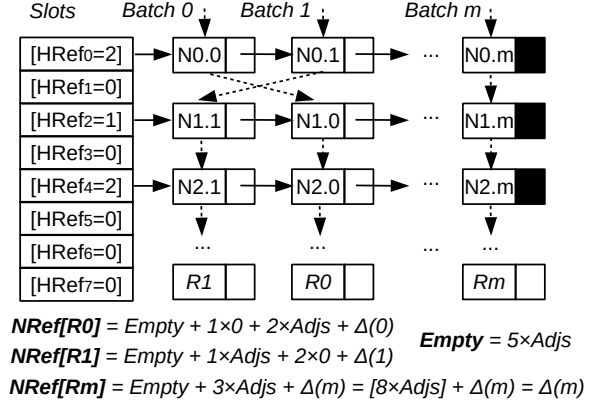

Figure 5. Scalable (multiple-list) Hyaline.

pointer to the node with `NRef`. Thus, each node keeps three variables irrespective of batch sizes and total number of slots.

In Section 3.1, we described reference adjustments using signed integer arithmetic. The same argument applies to unsigned numbers, in which case negative numbers represent very large integers. We generalize this idea to accommodate `Hyaline`'s multiple-list version. When adjusting a predecessor in slot  $i$ , we add  $Adjs + HRef_i$  rather than just  $HRef_i$ , where  $Adjs$  is a special constant which prevents the adjustment for the predecessor to complete until all slots are handled. Assuming that the number of slots,  $k$ , is a power of 2, and the maximum representable unsigned integer value is  $2^N - 1$ , we calculate:  $Adjs = \left\lfloor \frac{2^N - 1}{k} \right\rfloor + 1$ .

For example, if  $k = 1$  (simple version),  $Adjs$  cancels out right away. When  $k = 8$ , assuming 64-bit integers,  $Adjs = 2^{61}$ . It is easy to see that more generally,  $Adjs$  cancels out after  $k$  additions:  $k \times Adjs = 0$  due to unsigned integer overflow.

When retiring a batch, a predecessor batch has to accumulate  $Adjs$  for all  $k$  lists for the adjustment to complete. Since some slots have no active threads, we accumulate  $Adjs$  for them when inserting the batch, and atomically add the net value to `NRef` of the *current* batch as the final step.

In Figure 5, we present an example with  $k = 8$  slots. For the purpose of this example, we enumerated nodes to reflect their relative slot positions (skipping empty slots) and corresponding batch numbers. For convenience, `Empty` denotes adjustments for five empty slots ( $5 \times Adjs$ ) that need not be handled. Batches are added one slot at a time, and two concurrent threads insert them in an interleaved fashion. When `Batch 0` is inserted, it ends up in the first position for slot 0 and the second position in all other active slots. `NRef` for `Batch 0` is stored in the node `R0` and contains `Empty` for empty slots, 0 for slot 0 (not yet adjusted),  $2 \times Adjs$  for slots 2 and 4 (adjusted when retiring `Batch 1`), and the *actual* counter component  $\Delta_0$ .  $\Delta_0$  contains the snapshot values of

$HRef_2$  and  $HRef_4$  when Batch 1 is inserted. A similar breakdown is shown for *Batch 1*. For *Batch m*, all adjustments are already cancelled out, and its NRef node contains just  $\Delta_m$ .

**Hyaline-1 for Single-width CAS.** In a special case, if every thread allocates its own unique slot, we can squeeze HRef into one bit and merge it with HPtr. This simplifies *enter* and *leave*, since they can use ordinary *write* and *swap* in lieu of CAS, making these operations wait-free. Adjustments can be also simplified: instead of adjusting predecessors and empty slots, we count the number of slots a batch is added to. ( $k$  does not have to be a power of 2.) After adding the batch to the last slot, NRef of the batch is adjusted by this counter.

**Contention.** Assuming that slots are cache-line aligned, CAS on Head is almost uncontended, and MESIF/MOESI protocols used by modern Intel/AMD CPUs incur no substantial performance penalty [41] (contrary to popular belief). The cost of *enter* and *leave* is therefore relatively small. Section 6 further shows that there is very little difference in Hyaline’s or Hyaline-1’s overall performance even for high-throughput data structures, which confirms that CAS in *enter* or *leave* is not a source of any measurable performance penalty.

**Costs.** Hyaline-1’s and EBR’s *enter/leave* costs are similar at the very least for x86 (write+barrier is replaced with *swap*, i.e., *xchg*, by recent gcc/clang compilers; AMD explicitly recommends *xchg* for sequentially-consistent writes [9]). Due to low CAS contention (used in lieu of *swap*), more general Hyaline also exhibits very similar performance. Though *leave* is longer in Hyaline and Hyaline-1 due to list traversals, this cost is simply incurred elsewhere in EBR, e.g., in *retire*.

## 4 Algorithm Descriptions

The main idea of Hyaline is that it always implicitly keeps track of concurrent threads. The number of concurrent threads gets reflected in the counter for each retired batch. Each of the concurrent threads has to decrement this counter explicitly. When the counter gets to 0, the batch is reclaimed.

Figure 6 presents the layout of nodes, batch structure, and global state. Batches are first accumulated locally. All retired nodes are linked together using BatchNext. The very last node (with a reference counter) is denoted as NRefNode, its BatchNext points to the very first node (i.e., in a cyclic list manner). Every node has a pointer to NRefNode.

### 4.1 Basic Hyaline

In Figure 7, we present pseudocode for the *enter*, *leave*, and *retire* operations. *enter* atomically increments the HRef variable while fetching the current pointer in a given slot. *retire* inserts a batch to all slots. For empty slots, it counts *Empty* adjustments and adds *Empty* to NRef of the batch in the very end. For each slot, a predecessor is adjusted by the corresponding HRef snapshot value and *Adjs*. *leave* decrements HRef, but also reads Next from the node Head is pointing

<pre>// Double-width integer struct head_t {     int HRef;     node_t *HPtr; }; // Nodes are retired locally // by appending to a batch; // when the batch fills up, // retire() is called for the // entire batch. As nodes get // appended to the batch, // MinBirth is set to minimum // BirthEra across batch nodes. struct local_batch_t {     // Pointer to the NRef node     node_t *NRefNode;     // The first node in the batch     node_t *FirstNode;     // Only for Hyaline-S or -1S     int MinBirth; };</pre>	<pre>struct node_t {     union {         // NRefNode: refer. counter         int NRef;         // Others: per-slot list         node_t *Next;         // Only for Hyaline-S or -1S         int BirthEra;     };     // Pointer to the NRef node     node_t *NRefNode;     // Next node in the batch     node_t *BatchNext; }; // Slots (all Hyaline variants) head_t Heads[k]; // Last era (Hyaline-S or -1S) int Accesses[k]; // Acknowledgments for Hyaline-S int Acks[k];</pre>
---	--

Figure 6. Hyaline’s nodes and global state.

to. Since a thread always has a reference to the head of the list, reading the first node is safe. The last thread replaces the first node with Null treating it as a predecessor in *retire*. Finally, succeeding nodes (if any) are dereferenced in the *traverse* helper method.

Hyaline-1 in Figure 8 replaces *enter* and *leave* with simpler equivalents. Since one thread is the sole owner of all nodes, *leave* can detach the first node immediately and read the node that follows after that. This simpler scheme also does not adjust predecessor nodes.

### 4.2 Hyaline-S

To deal with stalled threads in Hyaline, we extend Hyaline by partially adopting the idea from HE and IBR to record *birth eras* when allocating memory. The high-level idea is to mark each allocated object with the global counter, so that stalled threads will only hold older objects. Objects allocated after those threads stall will be counted only towards active threads. Birth eras simply facilitate detection of stalled threads in Hyaline. (Compare it to HE and IBR, where birth and retire eras define actual reclamation intervals.) Unlike HE/IBR, birth eras share space with other variables, e.g., Next, as they are not required to survive *retire*.

Hyaline-S, unlike Hyaline-1S, supports multiple threads per each slot, so we have to record eras such that they can be shared across multiple threads. That presents extra challenges when dealing with stalled threads since they may interleave with non-stalled threads.

In Figure 9, we present Hyaline-S. Our API model is reminiscent of 2GE-IBR [44] which only requires to additionally wrap all pointer reads in a special *deref* call. The eras are 64-bit numbers which are assumed to never overflow in practice. When nodes are allocated, *init\_node* initializes their birth eras with the era clock value. When dereferencing pointers, threads call *deref* to update a per-slot *access* era value. Since Hyaline-S allows arbitrary number of threads per slot, threads must share per-slot eras, and the maximum era needs

```

1 forall head_t Head ∈ Heads[k] do // Initialization
2   | Head.HRef = 0, Head.HPtr = Null;
3 handle_t enter(int slot)
4   | Last = FAA(&Heads[slot], { .HRef=1, .HPtr=0 });
5   | return Last.HPtr; // Returns a handle
6 void leave(int slot, handle_t handle)
7   | do // Decrement HRef and fetch Next
8     | Head = Heads[slot];
9     | Curr = Head.HPtr;
10    | if ( Curr ≠ handle )
11      | | Next = Curr->Next;
12      | New.HPtr = Curr;
13      | if ( Head.HRef = 1 ) New.HPtr = Null;
14      | New.HRef = Head.HRef - 1;
15      | while not CAS(&Heads[slot], Head, New);
16      | if ( Head.HRef = 1 and Curr ) // Treat Curr as if
17        | | adjust(Curr, Adjs); // it were a predecessor
18      | if ( Curr ≠ handle ) // Non-empty list
19        | | traverse(Next, handle);
20 void adjust(node_t *node, int val)
21   | Ref = node->NRefNode;
22   | // free_batch() frees all nodes by iterating
23   | // BatchNext. BatchNext of Ref points to the
24   | // first node in the batch.
25   | if ( FAA(&Ref->NRef, val) = -val ) free_batch(Ref->BatchNext);
26
27 void retire(local_batch_t *batch)
28   | doAdj = False, Empty = 0, Inserts = 0;
29   | CurrNode = batch->FirstNode;
30   | batch->NRefNode->NRef = 0;
31   | forall int slot ∈ 0..k-1 do
32     | do // Add the batch to this slot
33       | Head = Heads[slot];
34       | if ( Head.HRef = 0 ) // #1#
35         | | doAdj = True, Empty += Adjs;
36         | | continue with the next slot;
37       | New.HPtr = CurrNode;
38       | New.HRef = Head.HRef;
39       | New.HPtr->Next = Head.HPtr;
40       | while not CAS(&Heads[slot], Head, New);
41       | CurrNode = CurrNode->BatchNext;
42       | adjust(Head.HPtr, Adjs + Head.HRef); // #2#
43     | if ( doAdj ) adjust(batch->FirstNode, Empty); // #3#
44 void traverse(node_t *next, handle_t handle)
45   | do // Traverse the retirement sublist
46     | Curr = next;
47     | if ( Curr = Null ) break;
48     | next = Curr->Next;
49     | Ref = Curr->NRefNode;
50     | if ( FAA(&Ref->NRef, -1) = 1 ) // BatchNext of Ref points to the
51       | | free_batch(Ref->BatchNext); // first node in the batch
52     | while Curr ≠ handle;

```

Figure 7. Hyaline for double-width CAS.

```

1 handle_t enter(int slot)
2   | Heads[slot] = { .HRef=1, .HPtr=Null };
3   | return Null; // Returns a handle
4 // Replace #2# in retire() with: Inserts++
5
6 void leave(int slot, handle_t handle)
7   | Head = SWAP(&Heads[slot], { .HRef=0, .HPtr=Null });
8   | if ( Head.HPtr ≠ Null ) traverse(Head.HPtr, handle);
9 // Replace #3#: adjust(batch->FirstNode, Inserts)

```

Figure 8. Hyaline-1 for single-width CAS (substitutes for functions).

```

1 int AllocEra = 0; // Initialization
2 thread int AllocCounter = 0;
3 forall int Access ∈ Accesses[k] do Access = 0;
4 forall signed int Ack ∈ Acks[k] do Ack = 0;
5 node_t *deref(int slot, node_t **ptr_node)
6   | Access = Accesses[slot];
7   | while True do
8     | node_t *Node = (*ptr_node);
9     | Alloc = AllocEra;
10    | if ( Access = Alloc ) return Node;
11    | Access = touch(slot, Alloc);
12 void retire(local_batch_t *batch)
13   | // Replace #1# in retire() with:
14   | Access = Accesses[slot];
15   | if ( Head.HRef = 0 or Access < batch->MinBirth ) ...;
16   | // Place after #2# in retire():
17   | FAA(&Acks[slot], Head.HRef); // Hyaline-S only
18
19 void init_node(node_t *node)
20   | if ( AllocCounter++ mod Freq = 0 ) FAA(&AllocEra, 1);
21   | node->BirthEra = AllocEra; // Shared with Next
22
23 int touch(int slot, int era)
24   | do // Hyaline-1S: use a regular memory write
25     | Access = Accesses[slot];
26     | if ( Access ≥ era ) return Access;
27     | while not CAS(&Accesses[slot], Access, era);
28     | return era
29 // Hyaline-S only, not needed in Hyaline-1S
30 handle_t enter(int *slot)
31   | while Acks[*slot] ≥ Threshold do
32     | *slot = (*slot + 1) mod k; // Try all k slots
33
34 void traverse(int slot, node_t *next, handle_t handle)
35   | Counter = 0;
36   | do Counter++ ... while ...;
37   | FAA(&Acks[slot], -Counter);

```

Figure 9. Hyaline-S and Hyaline-1S: dealing with stalled threads (extension).

to be set using the *touch* helper function. (Hyaline-1S can just write the new era, as there is a 1:1 thread-to-slot mapping.) Since all active threads update eras when calling *deref* in

their slots, *retire* simply uses the minimum birth era across all nodes in a batch, and skips slots with stale eras.



Since threads share per-slot eras in Hyaline-S, it is crucial to stay away from slots occupied by stalled threads when entering. Each slot keeps a special Ack value incremented by *retire*. Ack accumulates the total number of active threads across all retired batches in the slot. Since all retired batches inevitably appear in the retirement sublists of all active threads, each thread acknowledges that it no longer references batches by decrementing Ack in *traverse*. Ack can be negative temporarily if *traverse* takes place before *FAA* in *retire*. (Nonetheless, Ack only increases after finite number of retirements when at least one thread is stalled, i.e., it does not call *traverse*.) Ack may also be positive, but after some threshold (e.g., 8192), *enter* can assume that the corresponding slot is occupied by stalled threads. Acks do not incur any measurable penalty as evidenced by Section 6 where Hyaline-S and Hyaline-1S have roughly similar performance.

All slots may end up being occupied by stalled threads in Hyaline-S. To guarantee robustness, we can adaptively increase the number of slots by using an extra array which stores pointers to arrays of slots (Section 4.3).

### 4.3 Adaptive Resizing for Hyaline-S

Unlike Hyaline-1S which allocates a dedicated slot for each thread and is fully robust, Hyaline-S caps the total number of slots. This limits robustness guarantees for Hyaline-S in rare situations when all slots fill up with stalled threads and they begin to interfere with active threads.

We now describe an approach which makes Hyaline-S fully robust by adaptively increasing the number of available slots,  $k$ , as a larger number of threads are stalled. We denote the initial  $k$  value (a constant),  $Kmin$ . The current  $k$  value is stored in a global atomic variable.

When a batch is finalized and *retired*, we read the current  $k$  value. (There is no problem if concurrent threads increase the  $k$  value right after we read it, as new slots will be used by new *enter* calls which need not account for already retired nodes. A larger than necessary  $k$  is also not a problem since the batch will simply be added to extra slots.) We calculate the *Adjs* value based on the current  $k$  value and store it in each batch. Each node in a batch contains a pointer to *NRefNode*, but *NRefNode* itself does not need to keep this pointer. Instead, we use this variable to store the current *Adjs* value for the batch.

When calling *adjust*, we use the corresponding batch's *Adjs* value. In Figure 7, we have three *adjust* calls: Line 17 uses *Adjs* for the *Curr*'s batch, Line 38 uses *Adjs* for *HPtr*'s batch, and Line 39 uses *Adjs* for the current batch.

When stalled threads occupy all slots (Figure 9, Line 26), we adaptively increase the number of slots. Since we cannot resize the initial array of slots easily, we maintain a *directory of slots*, an array of pointers to arrays of slots, as shown in Figure 10. This array is fixed-size and small, e.g., for 64-bit CPUs, it never exceeds 64 entries. Initially, only index 0 points to the array of slots with  $Kmin$  entries. As *enter* runs

out of slots, we allocate an additional array of  $(2 \times Kmin - Kmin)$  slots such that the total number of slots doubles. We atomically change index 1 to point to the new array (we also offset this pointer by  $Kmin$  to simplify the slot position calculation). If a concurrent thread also changes index 1, the thread for which the corresponding CAS fails will discard the allocated buffer. The aforementioned procedure applies to all arrays which use slots: *Heads*, *Accesses*, and *Acks*.

To access a slot, we use the formula from Figure 10, which calculates a directory array index. The  $\log_2$  operation, including a special case of  $\log_2(0) = -1$ , is efficiently implemented by the *leading zero count* instruction, available on modern CPUs, by using  $\log_2(x) = N - lzcnt(x) - 1$ , where  $N$  is bit-length. Since we always double the number of slots,  $k$ , and the initial  $Kmin$  value is a power-of-two number, our assumption that  $k$  is a power-of-two number is still valid.

We always increase the number of slots as we detect more stalled threads and run out of slots. However, the number of slots is bounded by the total number of stalled threads (rounded to the next power-of-two number). Since the number of threads is finite, memory occupied by slots is bounded, i.e., our algorithm is still robust. Existing robust SMR schemes similarly require dedicated slots per *each* thread.

### 4.4 Usage Preference

It should be feasible to always use Hyaline-1 in lieu of EBR, and Hyaline-1S in lieu of HE, HP, or IBR given Hyaline's performance benefits (Section 6). One exception is when users deliberately want to avoid reclamation by read-only threads due to some extremely rigid latency requirements. This scenario seems uncommon for general-purpose systems, and it would not improve the overall throughput anyhow.

Hyaline-1 and Hyaline-1S are very portable and expose a relatively simple API. Hyaline and Hyaline-S provide full transparency but additionally require LL/SC or double-width CAS, which degrades portability. All Hyaline schemes simplify integration, e.g., it is much easier to register/unregister threads dynamically than with the aforementioned schemes. Garbage collectors have different trade-offs, and Hyaline's applicability in the corresponding applications is similar to that of EBR, HE, HP, and IBR.

## 5 Correctness

We now prove correctness, lock-freedom, and robustness.

**Theorem 1.** *All Hyaline variants are reclamation-safe.*

*Proof.* In a correct program, a retired batch cannot be accessed by subsequent operations. Only concurrent operations may still access it. Each of those concurrent operations starts by calling Hyaline's *enter*. Any batch retired during this concurrent execution will have its *NRef*  $\neq 1$  (Lines 26 and 39). If another thread executes *leave* after Line 36 and before the last adjustment in Line 39, then it will start by decrementing the retired object's reference count such that it will be a

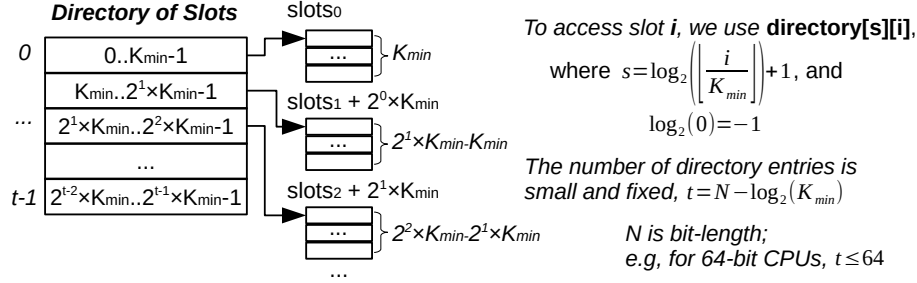

Figure 10. Hyaline-S: adaptive resizing.

very large number (Line 46). Only objects with a new reference count of zero are reclaimed (Lines 22 or 46). Thus, those retired objects with very large reference counts are safe from being reclaimed. After executing Line 39 across all slots where the batch is placed, the retired object’s reference count will reflect the correct number of concurrent threads that have not executed *leave* yet. Hence, the object will not be reclaimed until all these threads execute *leave*.

Hyaline-(1)S, regardless of *HRef* values, skips slots with eras that are smaller than *min\_birth* from a retired batch. *min\_birth* signifies the oldest node in the batch. *deref* always updates per-slot eras to keep them in sync with the global era clock. Thus, the retired batch must have been covered by per-slot eras unless none of its nodes is ever dereferenced. □

**Theorem 2.** *All Hyaline variants are lock-free. (With respect to CPU progress only, see Theorem 5 for robustness.)*

*Proof.* Hyaline has two unbounded loops (Lines 7-15 and 28-36). If the CAS operation fails in the first loop (Lines 7-15) causing it to repeat, it means that Head is changed by another thread executing *enter*, *leave*, or *retire* in the same slot. Thus, that other thread is making progress – i.e., successfully executing *enter*, *leave*, or *retire* in the same slot, and finishing modification of the same Head. The same argument applies to the second loop (Lines 28-36). The loop in *traverse* is bounded by the number of batches retired between executing *enter* and *leave*, and this number is finite.

Hyaline-S (Figure 9) has two additional loops (Lines 7-11 and 20-23). If CAS fails in *touch* (Lines 20-23) causing it to repeat, it means that another thread calling *touch* succeeds. The other loop (Lines 7-11) converges unless the global era clock is incremented. In the latter case, another thread is making progress, i.e., initializes a new node in Line 17. □

**Theorem 3.** *Hyaline and Hyaline-S have  $O(n/k)$  reclamation cost.*

*Proof.* The reclamation cost in Hyaline consists of two parts: 1) the direct cost of *retire* and 2) the cost of *retire* incurred later, during list traversal in *leave*.

Retiring is a simple  $O(1)$  linked-list (batch) insertion operation. Upon reaching the maximum batch size, *s*, *retire*

inserts the batch into slots with active threads. Since the number of slots is *k*,  $s \geq k + 1$ . Each batch is inserted into at most *k* slots after *s* per-node *retire* calls, making the average cost of *retire*  $O(1)$ .

The list traversal takes place for all batches retired between *enter* and *leave*. A batch is retired after  $s \geq k + 1$  *retire* calls (for individual nodes). Each batch maintains a single reference counter per  $\geq (k + 1)$  nodes. The batch’s reference counter needs to be decremented by all active threads (at most, *n* threads). Thus, the average cost to update a reference counter *per node* (i.e., the indirect cost of a single *retire* incurred in *leave*) is  $O(n \times \frac{1}{k+1}) = O(n/k)$ . □

**Theorem 4.** *Hyaline-1 and Hyaline-1S have  $O(1)$  reclamation cost.*

*Proof.* Hyaline-1 and -1S are special cases of Hyaline and Hyaline-S, where  $k = n$  (i.e., the number of threads equals to the number of slots). Thus, the reclamation cost is  $O(1)$ . □

**Theorem 5.** *Hyaline-S and Hyaline-1S are robust.<sup>4</sup>*

*Proof.* Since slots with stalled threads are detected after a finite number of *retire* calls and avoided by active threads in their following operations, we assume, without loss of generality, that slots do not reference any active threads. (Although batches are potentially added to every slot, one stalled thread can only make unusable the slot which was used by the last *enter* operation of the stalled thread. Only this slot references this thread. Newly allocated nodes will skip this slot due to its stale era and consequently will not reference the stalled thread when these nodes are retired.)

Since threads update their per-slot eras in monotonically increasing order when calling *deref*, each slot *i* ends up with some era  $A_i$  when it contains only stalled threads. Let  $Era_{max} = \max(A_i)$  across all slots *i* with stalled threads. We use  $E_i$  to denote a global era clock value when the earliest stalled thread from slot *i* entered. All previously retired

<sup>4</sup>As in IBR, we consider only stalled threads – i.e., threads that are stopped indefinitely as opposed to threads that are simply paused briefly. Also, as in IBR, “starved” threads that are running but unable to make any progress can still potentially reserve an unbounded number of objects; this is prevented by bounding the number of CAS failures in data structure operations and restarting from the very beginning (implemented by Section 6’s benchmark).

nodes must have been retired before (or at)  $E_i$ . Let  $\delta Era = Era_{max} - \min(E_i)$  across all  $i$  slots with stalled threads. All potentially unreclaimable batches will have their  $\min\_birth \leq Era_{max}$  (Line 14 of Figure 9). As each thread periodically increments the era value, a number of unreclaimable batches is bounded by  $\delta Era \times Freq \times n$ , where  $n$  is the number of threads and  $Freq$  is the frequency used in the algorithm. Batch sizes can be capped by  $k + 1$ , where  $k$  is the number of slots. Thus, the number of unreclaimable nodes is bounded by  $\delta Era \times Freq \times n(k + 1)$ ,  $k \leq n$ .  $\square$

## 6 Evaluation

We used and extended the test framework of [44] to support Hyaline. The framework consists of four benchmarks representing different data structures: the sorted linked-list [25, 32], lock-free hash map [32], a variant of the Bonsai Tree [16], which is a self-balancing lock-free binary tree, and Natarajan and Mittal’s binary tree [34].

We run our tests for up to 144 threads on a 72-core machine consisting of four Intel Xeon E7-8880 v3 2.30 GHz (45MB L3 cache) CPUs with hyper-threading disabled and 128GB of RAM. We chose Clang 11.0.1 with the `-O3` optimization flag due to its better support of double-width RMW as used by Hyaline. We saw no visible difference between GCC and Clang for existing algorithms. We used jemalloc [23] to alleviate the standard library malloc’s poor performance [1].

Since a number of different techniques exist, we focus on well-established or state-of-the-art algorithmic schemes that have similar properties or programming models as Hyaline. We do not evaluate classical reference counting because it uses an intrusive model and is already known to be slower than other evaluated schemes. We skip OS-based approaches since they are inevitably blocking. We skip PEBR [30] due to significant API differences. We note that PEBR authors only compare against EBR, and PEBR’s performance appears to be 85-90% of EBR’s, worse than that of Hyaline. Since Hyaline aims to achieve excellent throughput while also retaining good memory efficiency, we are comparing against schemes with excellent throughput, such as epoch-based reclamation, and excellent memory efficiency, such as hazard pointers.

We compare all four Hyaline variants against:

**HP** – hazard pointers [32].

**HE** – hazard eras [39].

**IBR** – the interval-based technique 2GE-IBR [44].

**Epoch** – a variant [44] of the epoch-based approach.<sup>5</sup>

**No MM** – running the test without any memory reclamation, which serves as a general baseline.

In the results, it is more fair to compare Hyaline and Hyaline-1 against (non-robust) Epoch, and Hyaline-S and Hyaline-1S against (robust) HP, IBR, and HE.

<sup>5</sup>This variant has an advantage over the original EBR [24, 26] in that it increments the epoch counter unconditionally, but it has to place all retired nodes in one per-thread list. Both approaches exhibit good performance.

The original benchmark code we used [44] implemented snapshots only for IBR. HP and HE were suboptimal due to excessive cache misses when scanning lists of retired nodes. We modified these implementations accordingly. EBR and Hyaline are snapshot-free and do not need this optimization.

Note that the actual throughput can exceed *No MM* as it can be faster to recycle old objects. As memory deallocation slows down due to a number of factors, including number of freed objects, any memory reclamation scheme can also become objectively slower than *No MM*.

We use both a *write-intensive* workload (50% *insert*, 50% *delete*), which stresses reclamation techniques through a large number of insertions and deletions, as well as *read-dominated* workload (90% *get*, 10% *put*), which represents a more reclamation-unbalanced and yet common scenario.

For each data point, the experiment starts by prefilling the data structure with 50,000 elements and runs 10 seconds. Each thread then randomly performs the aforementioned operations. The key used in each operation is randomly chosen from the range of 0 to 100,000 with equal probability. We run the experiment 5 times and report the average.

Reclamation algorithms need to be adjusted to gain good performance. Although this process is tricky, we found more or less reasonable parameters for a fair comparison such that existing algorithms achieve the highest possible throughput while retaining as much of memory efficiency as possible. For our machine, benchmark parameters  $epochf = 150$  and  $emptyf = 120$  appear to be optimal for existing schemes in this regard.  $epochf$  amortizes the frequency of epoch counter increments for Epoch, IBR, and HE.  $emptyf$  reduces other overheads for all algorithms, e.g., amortizing the frequency of list traversals. For Hyaline and Hyaline-S, we cap the number of slots,  $k$ , at 128 (the next power of 2 of the number of cores). All variants use batches of at least 64 and at most  $k + 1$  nodes (as required by the Hyaline algorithms).

Figure 11a shows the throughput of (sorted) Linked-list, which is a good example of an unbalanced workload since operations are slow and dominated by the long traversal required to find an element (even in the write-intensive scenario). Figure 12a, which shows the average number of retired but not-yet-reclaimed objects per operation (allows us to estimate how fast memory is reclaimed), demonstrates that Hyaline has excellent memory efficiency, which is much better than that of Epoch, HE, or IBR. This validates our claim that Hyaline’s efficiency is better in unbalanced settings. All Hyaline variants also have marginally higher throughput than the other schemes. Although HP is also efficient, its throughput is visibly worse due to so many memory barriers incurred while traversing the list. Similar trends are also observed for the read-dominated case (Figures 11d and 12d).

Figure 11b shows hash map’s throughput using the write-intensive workload. Hash map operations are very short and significantly stress memory reclamation systems. Because operations are short, HP’s performance does not degrade

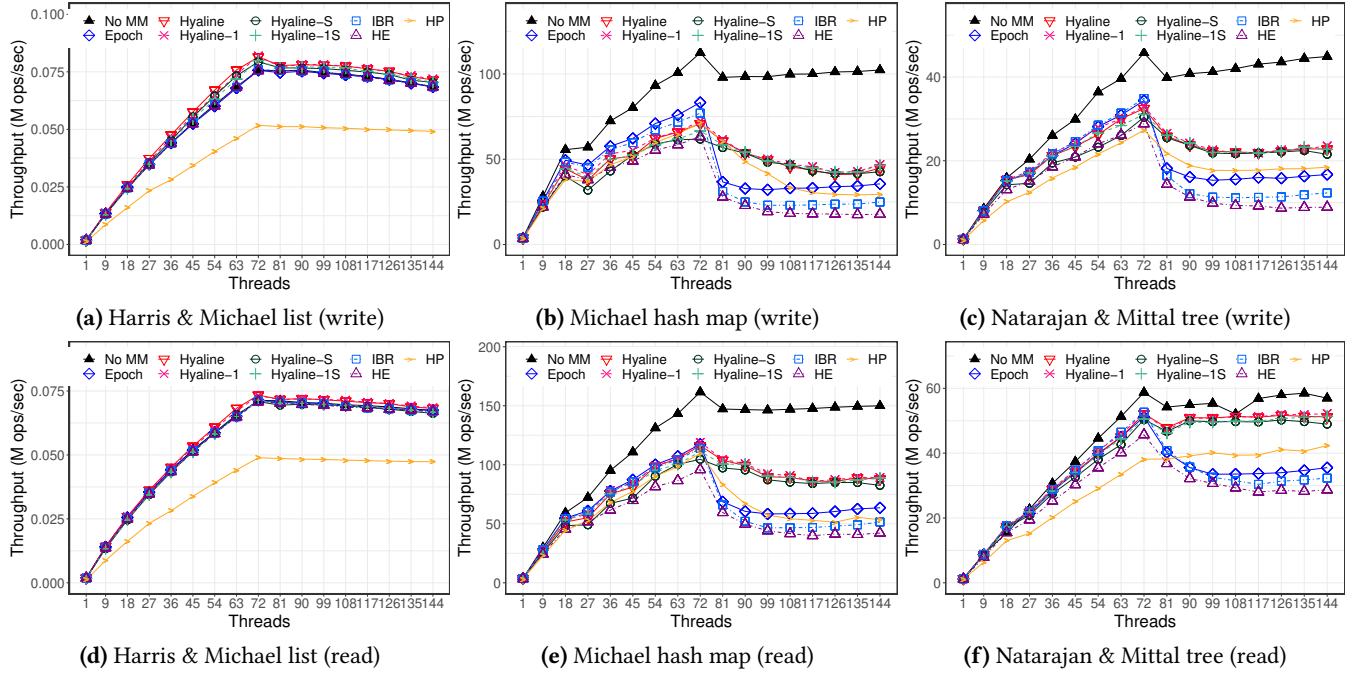

Figure 11. Throughput (higher is better).

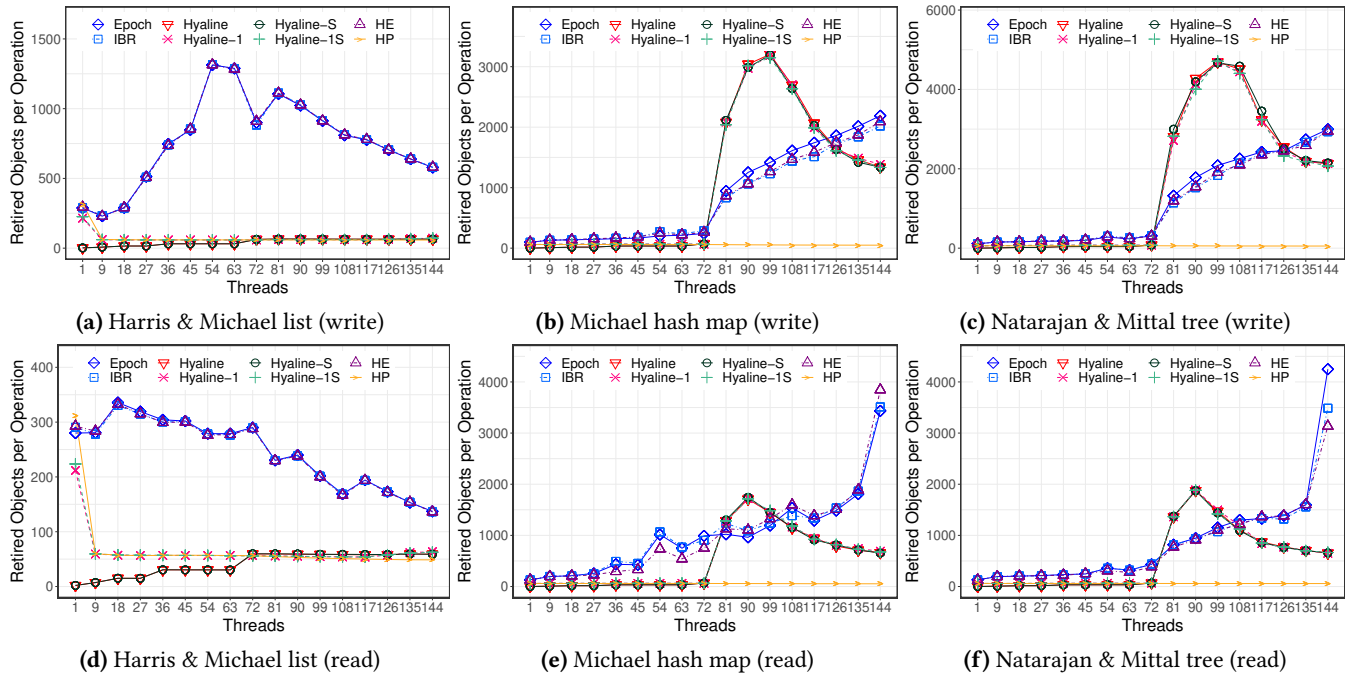

Figure 12. Average number of unreclaimed objects per operation (lower is better).

as much as in the prior test. The gap between *No MM* and memory reclamation techniques substantially increases as the number of threads begins to exceed the number of cores. However, all Hyaline variants still perform well after 72 threads. (The gap between Hyaline and Epoch gets as large

as 2x for 81 threads.) For a smaller number of threads, retirement in Hyaline can be slightly more expensive than in Epoch and IBR. The average number of unreclaimed objects (Figure 12b) for all Hyaline variants is comparable to HP

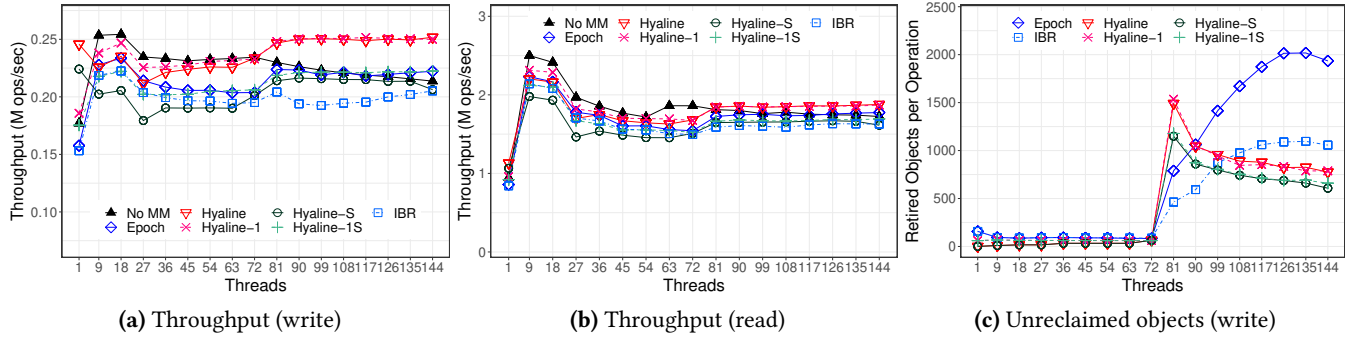

Figure 13. Bonsai tree. (Unreclaimed objects for **read** and **write** are nearly identical.)

and smaller than that of IBR, HE, or Epoch before the over-subscribed scenario (not visible due to a smaller scale). Although it temporarily increases afterwards, the corresponding throughput is also substantially higher than that of other schemes. Hence, one possible explanation for this increase is that Hyaline simply allocates and reclaims more objects (compared to other schemes) in the first place. Since this workload is already very balanced, Hyaline also does not get any extra benefit due to reclamation balancing. Hash map’s results are somewhat more interesting for the read-dominated case (Figures 11e and 12e), where Hyaline is more memory efficient than IBR, HE, or Epoch. Hyaline’s throughput remains very high, even in oversubscribed scenarios.

Natarajan & Mittal tree (Figures 11c, 12c, 11f, and 12f) shows similar trends to that of hash map. HP is slower due to longer operations. Throughput gains of Hyaline are more visible here. With respect to memory efficiency, we see the same benefit in the read-dominated workload as in hash map. Before oversubscription, Hyaline’s efficiency is close to HP’s.

Figures 13a and 13b show Bonsai tree’s throughput. HP and HE are not implemented due to the complexity of the tree rotation operations [44], for which the number of local pointers cannot be determined in advance. Throughput drops for all schemes as we approach 18 per-socket cores, most likely due to over-socket contention [44]. Hyaline and Hyaline-1 achieve the best performance and steadily outperform Epoch by  $\approx 10\%$ . All robust schemes presented for this benchmark (IBR, Hyaline-S, and Hyaline-1S) have similar performance; it is worse than their non-robust counterparts due to increased number of pointer dereferences. The number of unreclaimed objects (Figures 13c) for Hyaline and Hyaline-S is mostly smaller than that of Epoch and IBR, respectively.

**Snapshots.** Snapshots also impact memory utilization. For 144 threads and 16 local (concurrently reserved) pointers in HP and HE, snapshots **additionally require 2.5 MB**. Although this size depends on the number of threads, and the number of local pointers is typically smaller, we present this figure to give some perspective. For example, even if the number of unreclaimed objects is as high as 4000, and

each object is 128 bytes, we still use less than **0.5 MB**. To retain the same evaluation methodology as in prior works, our results above disregard snapshot overheads. However, for snapshot-based schemes (IBR, HP, and HE), snapshots alone can create more memory inefficiency than the scheme itself, a fact rarely acknowledged in prior works.

## 7 Related Work

A number of approaches for safe memory reclamation (SMR) were proposed over the last two decades.

Most SMR approaches are either pointer- or epoch- based. Pointer-based techniques such as hazard pointers (HP) [32] are typically fine-grained and track every accessed object. Unfortunately, this approach degrades performance as pointer dereferencing incurs additional overheads, such as memory writes and barriers. Pass-the-buck [27, 28] has a similar model. Drop the anchor [14] is designed specifically for linked-lists and outperforms hazard pointers, but the approach is not directly applicable to other data structures. Optimistic Access [19] and Automatic Optimistic Access (AOA) [18] are more universal techniques, but they require data structures to be written in a “normalized form.” FreeAccess [17] drops this requirement and implements a garbage collector. FreeAccess, however, needs to divide a program into read-only and write-only periods, which makes it impossible to directly use certain operations such as *swap*. OrGC [20], another fully lock-free garbage collector, achieves good performance but is still slower in some tests than HP.

In epoch-based reclamation (EBR) [24, 26], which is based on the read-copy-update (RCU) [31] paradigm, objects are marked with the current epoch value at the time they are retired. A memory object is deallocated only when all thread reservations are ahead of the object’s retire epoch and no thread can reach it. Stamp-it [38] extends EBR to guarantee  $O(1)$  reclamation cost but is not robust and requires per-thread control blocks. It extends EBR by using a doubly-linked list, and requires ABA tags [29]. Stamp-it squeezes 17-bit tags directly into control block pointers, but for ABA safety, it is better to use larger tags and double-width CAS.

The hazard eras (HE) approach [39] attempts to reconcile EBR with HP: HE is robust, but uses “eras” (i.e., epochs) instead of pointer addresses to accelerate the algorithm. When allocating memory objects, they are tagged with the *birth* era, and when objects are retired, they are tagged with the *retire* era. Lifecycles of objects are controlled by these eras. Similarly to HP’s API model, indices must be assigned to all accessed objects in HE. A subsequent work [36] makes HE wait-free. Interval-based reclamation (IBR) [44] employs the idea of birth and retire eras but forgoes the need to explicitly assign indices making its API model, especially in its 2GE-IBR variant, reminiscent of EBR and easier to use.

Some approaches exploit OS support. PEBR [30] relies on OS tricks [5] to avoid extra memory barriers, which makes it intrusive to execution environments. DEBRA+ [15], NBR [42], and QSense [13] improve EBR to make it robust, but they rely on OS signals or scheduler support. They are robust but not in a fully lock-free manner as typical OSs such as Linux inevitably use locks. ThreadScan [12] and Forkscan [11] are other examples of schemes that rely on signals.

Another approach that is simple to implement but has a high overhead is lock-free reference counting (LFRC) [33, 43]. In this approach, each object is associated with a reference count. An object can be safely reclaimed when the reference count reaches zero. The reference count is updated with every access, which converts read-accesses into write-accesses with a memory barrier. This significantly impacts performance. Hyaline uses a completely different approach, wherein objects are accessed without modifying reference counters. Since active threads are tracked only in the list of *retired* objects, Hyaline’s overhead is significantly smaller.

Some approaches rely on hardware transactional memory (HTM) to speed up reference counting [22] using HTM transactions. Another approach [10] executes any read operation on the data structure as an HTM transaction. When a conflict occurs in a concurrent thread that reclaims memory, the transaction is aborted. Some other approaches [21] optimize performance by using page protection mechanisms which issue a page fault that forces a global memory barrier.

## 8 Conclusion

We presented Hyaline, a new lock-free algorithm for safe memory reclamation. Hyaline uses LL/SC or double-width CAS, which are available on most modern architectures. A specialized Hyaline-1 algorithm uses single-width CAS and can be implemented on all architectures. We also presented Hyaline-S and Hyaline-1S extensions, which bound memory usage even in the presence of stalled threads. Compared to other common approaches, the Hyaline schemes balance the reclamation workload due to their underlying asynchronous nature of reclamation. This often manifests in improved memory efficiency without sacrificing performance.

All Hyaline schemes are suitable for environments where threads are created and deleted dynamically: threads are “off-the-hook” as soon as they *leave* and do not need to check retirement lists afterwards. Hyaline and Hyaline-S are fully transparent as they need not explicitly register or unregister threads; they can allocate a fixed number of slots roughly corresponding to the number of cores and still support any number of threads. Hyaline-1 and Hyaline-1S are less transparent in this sense but can be implemented everywhere.

Hyaline schemes do not take snapshots, which can help reduce memory footprints as the number of threads grow.

We tested all Hyaline versions on x86(-64), ARM32/64, PowerPC, and MIPS architectures. For these architectures, all Hyaline variants exhibit very high throughput on various data structures, and ensure that the number of retired, but not-yet-reclaimed objects is small. We presented results for x86-64, a ubiquitous architecture. Hyaline’s benefits are especially visible in certain read-dominated workloads. Moreover, in oversubscribed scenarios, Hyaline obtains up to **2x** throughput gain over other algorithms, including EBR.

## Availability

We provide code for the modified benchmark and all Hyaline variants at <https://github.com/rusnikola/lfsmr>.

The arXiv version of the paper is available at <https://arxiv.org/abs/1905.07903>.

## Acknowledgments

A preliminary version of the algorithm previously appeared as a brief announcement at PODC ’19 [35].

We would like to thank the anonymous reviewers and our shepherd Tony Hosking for their insightful comments and suggestions, which helped greatly improve the paper. We also thank Mohamed Mohamedin for helping with experiments for an early version of the algorithm.

This work is supported in part by AFOSR under grants FA9550-15-1-0098 and FA9550-16-1-0371 and ONR under grants N00014-18-1-2022 and N00014-19-1-2493.

## References

- [1] 2020. Allocator Benchmarks. <https://locklessinc.com>.
- [2] 2020. ARM Reference Manual ARMv8. <https://developer.arm.com/>.
- [3] 2020. Concurrency Kit. <http://concurrencykit.org/>.
- [4] 2020. Intel 64 and IA-32 Developer’s Manual. <https://www.intel.com/>.
- [5] 2020. Linux Programmer’s Manual – membarrier(2) – Linux manual page. <https://man7.org/linux/man-pages/man2/membarrier.2.html>.
- [6] 2020. MIPS32/MIPS64 Revision 6.06. <https://www.mips.com/products/architectures/>.
- [7] 2020. Oracle SPARC Architecture 2011. <http://www.oracle.com/>.
- [8] 2020. PowerPC Architecture Book, Version 2.02. Book I: PowerPC User Instruction Set Architecture. <https://www.ibm.com/developerworks/>.
- [9] 2020. Software Optimization Guide for AMD Family 10h and 12h Processors. <https://www.amd.com/system/files/TechDocs/40546.pdf>.
- [10] Dan Alistarh, Patrick Eugster, Maurice Herlihy, Alexander Matveev, and Nir Shavit. 2014. StackTrack: An Automated Transactional Approach to Concurrent Memory Reclamation. In *Proceedings of the 9th*

- European Conference on Computer Systems* (Amsterdam, The Netherlands) (*EuroSys '14*). ACM, Article 25, 14 pages.
- [11] Dan Alistarh, William Leiserson, Alexander Matveev, and Nir Shavit. 2017. Forkscan: Conservative Memory Reclamation for Modern Operating Systems. In *Proceedings of the 12th European Conference on Computer Systems* (Belgrade, Serbia) (*EuroSys '17*). ACM, 483–498.
- [12] Dan Alistarh, William M. Leiserson, Alexander Matveev, and Nir Shavit. 2015. ThreadScan: Automatic and Scalable Memory Reclamation. In *Proceed. of the 27th ACM Symposium on Parallelism in Algorithms and Architectures* (Portland, Oregon, USA) (*SPAA '15*). ACM, 123–132.
- [13] Oana Balmau, Rachid Guerraoui, Maurice Herlihy, and Igor Zablotchi. 2016. Fast and Robust Memory Reclamation for Concurrent Data Structures. In *Proceedings of the 28th ACM Symposium on Parallelism in Algorithms and Architectures* (*SPAA '16*). ACM, 349–359.
- [14] Anastasia Braginsky, Alex Kogan, and Erez Petrank. 2013. Drop the Anchor: Lightweight Memory Management for Non-blocking Data Structures. In *Proceedings of the 25th Annual ACM Symposium on Parallelism in Algorithms and Architectures* (*SPAA '13*). ACM, 33–42.
- [15] Trevor Alexander Brown. 2015. Reclaiming Memory for Lock-Free Data Structures: There Has to Be a Better Way. In *Proceedings of the 2015 ACM Symposium on Principles of Distributed Computing* (*PODC '15*). ACM, 261–270.
- [16] Austin T. Clements, M. Frans Kaashoek, and Nickolai Zeldovich. 2012. Scalable Address Spaces Using RCU Balanced Trees. In *Proceedings of the 17th Intern. Conference on Architectural Support for Programming Languages and Operating Systems* (*ASPLOS XVII*). ACM, 199–210.
- [17] Nachshon Cohen. 2018. Every Data Structure Deserves Lock-free Memory Reclamation. *Proc. ACM Program. Lang.* 2, OOPSLA, Article 143 (Oct. 2018), 24 pages.
- [18] Nachshon Cohen and Erez Petrank. 2015. Automatic Memory Reclamation for Lock-free Data Structures. In *Proceedings of the 2015 ACM SIGPLAN International Conference on Object-Oriented Programming, Systems, Languages, and Applications* (*OOPSLA 2015*). ACM, 260–279.
- [19] Nachshon Cohen and Erez Petrank. 2015. Efficient Memory Management for Lock-Free Data Structures with Optimistic Access. In *Proceedings of the 27th ACM Symposium on Parallelism in Algorithms and Architectures* (Portland, Oregon, USA) (*SPAA '15*). ACM, 254–263.
- [20] Andreia Correia, Pedro Ramalhete, and Pascal Felber. 2021. OrcGC: Automatic Lock-Free Memory Reclamation. In *Proceedings of the 26th ACM SIGPLAN Symposium on Principles and Practice of Parallel Programming* (*PPoPP '21*). ACM, 205–218.
- [21] Dave Dice, Maurice Herlihy, and Alex Kogan. 2016. Fast Non-intrusive Memory Reclamation for Highly-concurrent Data Structures. In *Proceed. of the 2016 ACM SIGPLAN International Symposium on Memory Management* (Santa Barbara, CA, USA) (*ISMM 2016*). ACM, 36–45.
- [22] Aleksandar Dragojević, Maurice Herlihy, Yossi Lev, and Mark Moir. 2011. On the Power of Hardware Transactional Memory to Simplify Memory Management. In *Proceedings of the 30th Annual ACM SIGACT-SIGOPS Symposium on Principles of Distributed Computing* (San Jose, California, USA) (*PODC '11*). ACM, 99–108.
- [23] Jason Evans. 2006. A scalable concurrent malloc (3) implementation for FreeBSD. In *Proc. of the BSDCan Conference, Ottawa, Canada*.
- [24] Keir Fraser. 2004. *Practical lock-freedom*. Technical Report UCAM-CL-TR-579. <https://www.cl.cam.ac.uk/techreports/UCAM-CL-TR-579.pdf>
- [25] Timothy L. Harris. 2001. A Pragmatic Implementation of Non-blocking Linked-lists. In *Distributed Computing*, Jennifer Welch (Ed.). Springer Berlin Heidelberg, Berlin, Heidelberg, 300–314.
- [26] Thomas E. Hart, Paul E. McKenney, Angela Demke Brown, and Jonathan Walpole. 2007. Performance of memory reclamation for lockless synchronization. *J. Parallel and Distrib. Comput.* 67, 12 (2007), 1270–1285.
- [27] Maurice Herlihy, Victor Luchangco, Paul Martin, and Mark Moir. 2005. Nonblocking Memory Management Support for Dynamic-sized Data Structures. *ACM Trans. Comput. Syst.* 23, 2 (May 2005), 146–196.
- [28] Maurice Herlihy, Victor Luchangco, and Mark Moir. 2002. The Repeat Offender Problem: A Mechanism for Supporting Dynamic-Sized, Lock-Free Data Structures. In *Proceedings of the 16th International Conference on Distributed Computing* (*DISC '02*). Springer-Verlag, 339–353.
- [29] Maurice Herlihy and Nir Shavit. 2008. *The Art of Multiprocessor Programming*. Morgan Kaufmann Publishers, San Francisco, CA, USA.
- [30] Jeehoon Kang and Jaehwang Jung. 2020. A Marriage of Pointer- and Epoch-Based Reclamation. In *Proceedings of the 41st ACM SIGPLAN Conference on Programming Language Design and Implementation* (London, UK) (*PLDI '20*). ACM, 314–328.
- [31] Paul E. McKenney, Jonathan Appavoo, Andi Kleen, O. Krieger, Orran Krieger, Rusty Russell, Dipankar Sarma, and Maneesh Soni. 2001. Read-Copy Update. In *In Ottawa Linux Symposium*. 338–367.
- [32] Maged M. Michael. 2004. Hazard pointers: safe memory reclamation for lock-free objects. *IEEE Transactions on Parallel and Distributed Systems* 15, 6 (June 2004), 491–504.
- [33] Maged M. Michael and Michael L. Scott. 1995. *Correction of a Memory Management Method for Lock-Free Data Structures*. Technical Report.
- [34] Aravind Natarajan and Neeraj Mittal. 2014. Fast Concurrent Lock-free Binary Search Trees. In *Proceedings of the 19th ACM SIGPLAN Symposium on Principles and Practice of Parallel Programming* (Orlando, Florida, USA) (*PPoPP '14*). ACM, 317–328.
- [35] Ruslan Nikolaev and Binoy Ravindran. 2019. Brief Announcement: Hyaline: Fast and Transparent Lock-Free Memory Reclamation. In *Proceedings of the 2019 ACM Symposium on Principles of Distributed Computing* (Toronto, ON, Canada) (*PODC '19*). ACM, 419–421.
- [36] Ruslan Nikolaev and Binoy Ravindran. 2020. Universal Wait-Free Memory Reclamation. In *Proceedings of the 25th ACM SIGPLAN Symposium on Principles and Practice of Parallel Programming* (San Diego, California) (*PPoPP '20*). ACM, 130–143.
- [37] Ruslan Nikolaev, Mincheol Sung, and Binoy Ravindran. 2020. LibretOS: A Dynamically Adaptable Multiserver-Library OS. In *Proceedings of the 16th ACM SIGPLAN/SIGOPS International Conference on Virtual Execution Environments* (Lausanne, Switzerland) (*VEE '20*). 114–128.
- [38] Manuel Pöter and Jesper Larsson Träff. 2018. Brief Announcement: Stamp-it, a More Thread-efficient, Concurrent Memory Reclamation Scheme in the C++ Memory Model. In *30th on Symposium on Parallelism in Algorithms and Architectures* (*SPAA '18*). ACM, 355–358.
- [39] Pedro Ramalhete and Andreia Correia. 2017. Brief Announcement: Hazard Eras - Non-Blocking Memory Reclamation. In *Proceedings of the 29th ACM Symposium on Parallelism in Algorithms and Architectures* (Washington, DC, USA) (*SPAA '17*). ACM, 367–369.
- [40] Susmit Sarkar, Kayvan Memarian, Scott Owens, Mark Batty, Peter Sewell, Luc Maranget, Jade Alglave, and Derek Williams. 2012. Synchronising C/C++ and POWER. In *Proceedings of the 33rd ACM SIGPLAN Conference on Programming Language Design and Implementation* (Beijing, China) (*PLDI '12*). ACM, 311–322.
- [41] Hermann Schweizer, Maciej Besta, and Torsten Hoefler. 2015. Evaluating the Cost of Atomic Operations on Modern Architectures. In *Proceedings of the 2015 International Conference on Parallel Architecture and Compilation* (*PACT '15*). IEEE Computer Society, 445–456.
- [42] Ajay Singh, Trevor Brown, and Ali Mashtizadeh. 2021. NBR: Neutralization Based Reclamation. In *Proceedings of the 26th ACM SIGPLAN Symposium on Principles and Practice of Parallel Programming* (*PPoPP '21*). ACM, 175–190.
- [43] John D. Valois. 1995. Lock-free Linked Lists Using Compare-and-swap. In *Proceedings of the 14th Annual ACM Symposium on Principles of Distributed Computing* (Ottawa, ON, Canada) (*PODC '95*). 214–222.
- [44] Haosen Wen, Joseph Izraelevitz, Wentao Cai, H. Alan Beadle, and Michael L. Scott. 2018. Interval-based Memory Reclamation. In *Proceedings of the 23rd ACM SIGPLAN Symposium on Principles and Practice of Parallel Programming* (Vienna, Austria) (*PPoPP '18*). ACM, 1–13.

```

1 bool dCAS_Ptr(head_t *Head, head_t Expect, head_t New)
2   Old.HPtr = LL(Head.HPtr);
3   Old.HRef = Load(Head.HRef);
4   if ( Old ≠ Expect ) return False;
5   return SC(Head.HPtr, New.HPtr);
6 bool dCAS_Ref(head_t *Head, head_t Expect, head_t New)
7   Old.HRef = LL(Head.HRef);
8   Old.HPtr = Load(Head.HPtr);
9   if ( Old ≠ Expect ) return False;
10  return SC(Head.HRef, New.HRef);
11 head_t dFAA(head_t *Head, int RefAddend)
12   // Increment HRef
13   // HPtr remains intact
14   do
15     Old.HRef = LL(Head.HRef);
16     Old.HPtr = Load(Head.HPtr);
17     Value = Old.HRef + RefAddend;
18     while not SC(Head.HRef, Value);
19   return Old;

```

Figure 14. Single-width LL/SC version. Both HRef and HPtr are in the same reservation granule.

## A Hyaline(-S) for Single-width LL/SC

ARM32 MPCore+ and ARM64 [2] implement double-width LL/SC. Hyaline can be easily implemented on such architectures. However, MIPS [6] (until very recently) and PowerPC [8] implement only single-width LL/SC. We now describe an approach that we have used to successfully implement (in inline assembly) and stress-test Hyaline.

Typical implementations of LL/SC have certain restrictions, e.g., memory writes between LL and SC are prohibited. Memory reads, however, are still allowed for architectures such as PowerPC and MIPS. Although architectural manuals do not always mention it explicitly, the LL reservation granularity is typically larger than just a single CPU word, i.e., an entire L1 cache line [40] or even larger. This creates “false sharing,” where concurrent LL/SC on unrelated variables residing in the same granule causes SC to succeed only for one variable. In Hyaline, the [HRef, HPtr] tuple needs to be atomically loaded. However, with the exception of a special case when HRef goes to 0 in *leave*, we only update one or the other variable at a time. We use this observation to implement Hyaline for single-width LL/SC. We place two variables in the same reservation granule by aligning the first variable on the double-word boundary so that only one LL/SC pair succeeds at a time. An ordinary *load* operation between LL and SC loads the other variable. To prevent reordering of LL and load, we construct an artificial data dependency that acts as an implicit barrier for load. For the SC to succeed, the other variable from the granule must also be intact.

In Figure 14, we present a replacement of the *FAA* operation used by *enter* and two versions of double-width CAS replacements. *retire* uses the version that modifies a pointer. *leave* first uses the version that modifies a reference counter. We keep HPtr intact in *leave* even if HRef goes to 0. Then the other version of CAS sets HPtr to Null if the object is still unclaimed by any concurrent *enter*. Double-width load atomicity is guaranteed only when SC succeeds. Our algorithm tolerates single-width atomicity for CAS failures. Weak CAS (with sporadic failures) is tolerated in all cases other than  $HRef = 0$ . For that case, a strong version is created by looping SC; single-width atomicity for failures is acceptable as false negatives are impossible unless concurrent threads modify Head and claim the object – i.e.,  $HRef$  is no longer 0.

```

1 handle_t trim(int slot, handle_t handle)
2   Head = Heads[slot]; // Do not alter head
3   Curr = Head.HPtr;
4   if ( Curr ≠ handle ) // Non-empty list
5     traverse(Curr->Next, handle);
6   return Curr; // Returns a new handle

```

Figure 15. Hyaline’s trimming.

## B Trimming

As mentioned in Section 3.2, the cost of *enter* and *leave* is relatively small as long as there is no slot contention.

Trimming provides an alternative way to avoid contention while keeping the number of slots very small as in the simpler single-list version. Although, *trim* is harder to use manually (we avoid it in Section 6), it may be practical when several operations in a row take place on the data structure. *trim* can also be called automatically when building *quiescent-state* style memory reclamation as in [26]. Logically, *trim* is equivalent to *leave* followed by *enter*, but avoids the unwanted alteration of Head. *trim* allows a thread to indicate that previously retired batches (by any thread) are safe to delete from its perspective. When performing multiple operations on data structures, we can call *trim* in lieu of *leave* for the current operation and *enter* for the operation that follows.

The use of *trim* should not be confused with a case when *enter* and *leave* encapsulate several data structure operations. In the latter case, none of the retired batches can be reclaimed until *leave* is called. In contrast, *trim* dereferences previously retired batches such that they are timely reclaimed.

In Figure 15, we present pseudocode for trimming which extends the algorithm presented in Figures 7, 8, and 9. *trim* dereferences batches by traversing thread’s retirement list but skips the very first node and Head entirely; it updates a per-thread *handle* to reflect a shortened tail. (Note that with *trim*, Hyaline-1 and Hyaline-1S can have handles which are not necessarily Null.) Because *trim* does not update Head, it is critical to bound the length of retirement lists that need to be traversed, forcing *leave* and *enter* afterwards. Otherwise, if deallocation is slow, one unlucky thread can get stuck in a state where it is traversing an ever-changing list and deallocating more and more batches retired by other threads.