

# mmb: Flexible High-Speed Userspace Middleboxes

Korian Edeline, Justin Iurman, Cyril Soldani, Benoit Donnet  
*Université de Liège*  
*Montefiore Institute*  
*Liège, Belgium*

## Abstract

Nowadays, Internet actors have to deal with a strong increase in Internet traffic at many levels. One of their main challenge is building high-speed and efficient networking solutions. In such a context, kernel-bypass I/O frameworks have become their preferred answer to the increasing bandwidth demands. Many works have been achieved, so far, all of them claiming to have succeeded in reaching line-rate for traffic forwarding. However, this claim does not hold for more complex packet processing. In addition, all those solutions share common drawbacks on either deployment flexibility or configurability and user-friendliness.

This is exactly what we tackle in this paper by introducing `mmb`, a VPP middlebox plugin. `mmb` allows, through an intuitive command-line interface, to easily build stateless and stateful classification and rewriting middleboxes. `mmb` makes a careful use of instruction caching and memory prefetching, in addition to other techniques used by other high-performance I/O frameworks. We compare `mmb` performance with other performance-enhancing middlebox solutions, such as kernel-bypass framework, kernel-level optimized approach and other state-of-the-art solutions for enforcing middleboxes policies (firewall, NAT, transport-level engineering). We demonstrate that `mmb` performs, generally, better than existing solutions, sustaining a line-rate processing while performing large numbers of complex policies.

## 1 Introduction

Global Internet traffic has constantly increased over the past decade. In 2017, 17.4 billions of devices have generated more than 45,000 GB/second Internet traffic. By 2022, the number of devices connected to IP networks will reach 28.5 billions, among which 51% will follow a machine to machine (M2M) communication scheme, and their traffic will attain 150,700 GB/second, with hours peaking up to a x4.8 increase factor. Following the introduction of 4K, Ultra-High-Definition (UHD), or video streaming, Video traffic, which is particularly

delay-sensitive, will account for 82 % of this total [8, 14]. The fixed broadband and the mobile network speed will also continue to grow, to an average of respectively 75.4 Mbps and 28.5 Mbps.

In parallel, the traditional TCP/IP architecture (i.e., the end-to-end principle) is becoming outdated in a wide range of network situations. Indeed, corporate networks [26], WiFi hotspots, cellular networks [28], but also Tier-1 ASes [12] are deploying more and more *middleboxes* in addition to traditional network hardware. A middlebox is a network device inspecting, filtering, or even modifying packets that traverse it. Typically, a middlebox performs actions on a packet that are different from standard functions of an IP router. Indeed, middleboxes may be deployed for, e.g., security (IDS, NATs, firewalls) and network performance (load balancer, WAN optimizer).

Internet actors have thus to deal with this double increase at many levels, and particularly, in building high-speed networking solutions. A wide range of Kernel-bypass I/O frameworks are available to answer this increasing bandwidth demand, and the Linux kernel has been striving to stay afloat [6, 16]. Many of those efforts claims to have succeeded in reaching line-rate for traffic forwarding, less so for more complex packet processing (e.g., a firewall with a large number of rules, TCP options). Moreover, all of them share common drawbacks, on either deployment flexibility by necessitating expensive hardware or specific OS to maintain reasonable performances, or configurability and user-friendliness by requiring non-trivial programming for basic adaptation of common network functions.

In this paper, we want to overcome those limitations by introducing `mmb` (**M**odular **M**iddle**B**ox), an open-source<sup>1</sup> extension to the Vector Packet Processing (VPP [24]) high-speed kernel-bypassing framework. `mmb` aims at achieving line-rate forwarding performance while performing a large number of complex packet manipulation defined by middlebox policies. It leverages VPP employment of classical and recent advances

<sup>1</sup>Due to double-blind submission, a link to the source code will be provided if the paper is accepted.

in packet processing techniques, such as computation and I/O batching, Zero-Copy forwarding, low-level parallelism, and caching efficiency.

Moreover, by implementing combinable generic middle-box policies, configurable from an intuitive command-line interface, `mmb` allows for out-of-the-box middlebox deployment and easy adaptation. On modern hardware, it is able to hold baremetal-like performance while running on a virtual machine, thanks to PCIe passthrough technologies (i.e., SR-IOV, virtio). Finally, `mmb` benefits from VPP continuous development and maintenance.

We conduct a thorough comparison of trending high-performance packet processing solutions with `mmb`, for a selection of simple to complex use cases, packet forwarding, firewall-like packet filtering, packet filtering with stateful flow tracking, packet filtering with stateful matching and packet mangling (i.e., NAT), and TCP options filtering and mangling. We find that, with few hardware restrictions and without the need to write a single line of code, `mmb` is able to sustain packet forwarding at line-rate speed when enforcing a large set of diverse and complex classification and mangling rules, while other solutions either perform worse, require specific hardware or OS, necessitate expert-level configuration, or have inner design limitations that make them inapplicable.

The remainder of this paper is organized as follows: Sec. 2 provides the required background for this paper, focusing on the VPP framework and its main features employed by `mmb`; Sec. 3 introduces `mmb` by detailing its architecture and important aspects; Sec. 4 contains the performance evaluation of `mmb`. It describes and motivates the selected use cases, introduces the state-of-the-art tools compared to `mmb`, explains their configurations, and discusses the results; Sec. 5 positions `mmb` with respect to notable high-performance packet processors; finally, Sec. 6 concludes this paper by summarizing its main achievements.

## 2 VPP Background

This section aims at providing the required background for `mmb`. In particular, it focuses on *Vector Packet Processing* (VPP) [7], a 17-year old Cisco-developed technology providing a high-performance, extensible, feature-rich, packet-processing stack that runs in user space. It implements a full network stack and is designed to be customizable. It can run on I/O frameworks such as DPDK [1], Netmap [25], or OpenDataPlane (ODP) [23].

VPP leverages techniques such as batch-processing, Receive-side Scaling (RSS) queues, Zero-Copy by allowing userspace applications to have Direct Memory Access (DMA) to the memory region used by the NIC, offloading certain packet processing functions to dedicated hardware, and I/O batching to reduce the overhead of NIC-initiated interrupts. While those techniques have been implemented in other kernel-bypassing frameworks (e.g., FastClick [4]) and have

```

while(n_left_from >= 2){
    /* prefetch next iteration */
    if(PREDICT_TRUE(n_left_from >= 4)){
        vlib_prefetch_buffer_header(b[2], STORE);
        vlib_prefetch_buffer_header(b[3], STORE);
    }

    process(b[0]);
    process(b[1]);

    b += 2;
    next += 2;
    n_left_from -= 2;
}

/* process remaining packets */
while(n_left_from > 0){
    process(b[0]);

    b += 1;
    next += 1;
    n_left_from -= 1;
}

```

Figure 1: VPP Dual-loop.

been shown to drastically improve performances [3], VPP attempts to surpass it by introducing parallel processing on multiple CPU cores, to maximise hardware instruction pipelining, alongside an optimal use of CPU caches to minimize the memory access bottleneck. To this end, VPP introduces particular coding practices (e.g.: memory prefetching, cache-fitting processing nodes, branch prediction) to maximize low-level parallelism and cache locality.

### 2.1 Processing Nodes

The VPP packet processing path is based on a directed *forwarding graph* architecture. An example of such graph is shown in Fig. 3, that illustrates the subgraph used by `mmb`. It is made of small, modular *nodes* performing a set of functions (e.g., `dpdk-input`, `ip4-lookup`) to packets, in userspace. Each node is designed to entirely fit inside the instruction cache. The graph node dispatcher is responsible for directing the packet vectors through the graph. This modular architecture enables the development of independent *plugins*, that consist in shared libraries loaded at runtime, to plug their own nodes into the existing VPP forwarding graph, or rearrange it.

### 2.2 Packet Vectors

Kernel-bypass frameworks usually rely on a classical run-to-completion approach [4, 20], where each single packet is processed by each function separately. However, this approach has a few downsides related to memory access, which is a well-known bottleneck of software performance [5], ultimately resulting in reduced throughput.

First and foremost, the instruction cache hit rate suffers from continually having to load the different packet processing functions, and even more so when the cache is full. Moreover, when processing a packet, there is no a-priori information on the next function to be executed, neither which portions the packet data will be read. This prevents the establishment of prefetching strategies, which are efficient in addressing the memory access bottleneck.

VPP chooses to rely on a per-node batch processing, by systematically using pre-allocated packet batches (i.e., *vectors*), that contains typically up to 256 packets. When a function is applied to a packets batch, the first packet causes the function to be loaded in the instruction cache. Then, the following packets are guaranteed to hit the cache, amortizing the cost of the initial cache miss over the whole packet vector. Moreover, this approach gives a-priori information on the next data sections to be read, allowing for efficient prefetching strategies.

### 2.3 Low-level Optimization

VPP heavily encourages developers to set up multiple coding practice in the form of low-level optimizations techniques, in order to exploit all available hardware optimizations, and ultimately to improve the framework throughput.

Most VPP packet processing functions are *N-loops*, which consists in explicit handling *N* packets per iteration to increase the code parallelism. This practice aims at exploiting CPU hardware pipelining and at amortizing the cost of instruction cache misses. Fig. 1 shows an example of a dual-loop packet processing algorithm with data prefetching. By unrolling the loop, this algorithm allows for subtracting the processing time of two packets to the fetching time of the two next packets buffers. VPP authors notes that quad-loops (i.e.,  $N=4$ ) are only beneficial for small processing functions, because the introduced space-time trade-off is bounded by the limited size of instruction L1 caches [24].

VPP also relies on *branch prediction* by having programmers to give hints on the probability of code branches. This practice benefits, in case of a correct branch prediction, of avoiding a pipeline reset. Another important practice is allocating *N* buffers at a time rather than individually, and when possible, pre-allocating them.

## 3 Modular Middlebox

mmb (**M**odular **M**iddle**B**ox) is a VPP extension that performs stateless and stateful classification, and rewriting. It achieves stateless packet matching based on any combination of constraints on network or transport protocol fields, stateful TCP and UDP flow matching, packet mangling, packet dropping and bidirectional mapping. mmb is partly protocol-agnostic by allowing to match and rewrite fields

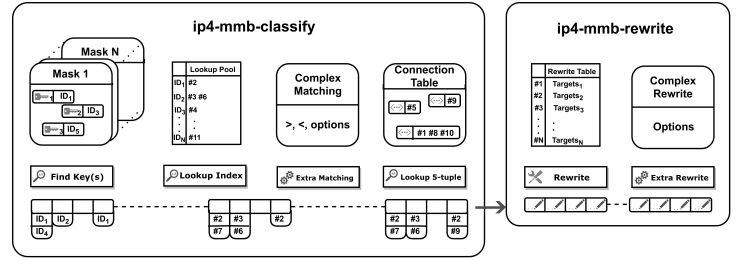

Figure 2: mmb processing path.

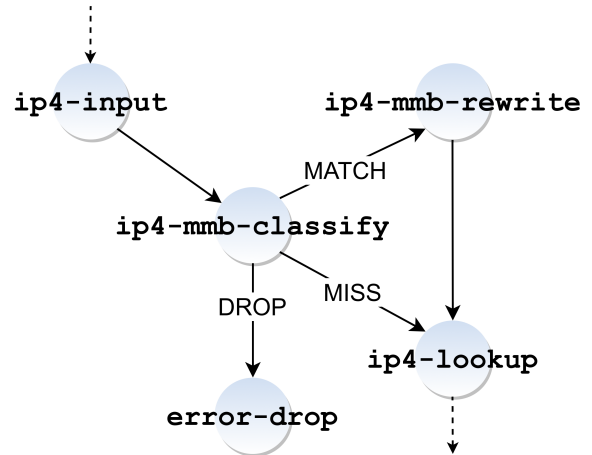

Figure 3: VPP forwarding graph with mmb nodes.

ip4-payload, udp-payload, and tcp-opt, and allows for on-the-fly configuration.

Sec. 3.1 provides a global overview of mmb, while Sec. 3.2 and Sec. 3.3 focus on mmb nodes for classification and rewriting operations.

### 3.1 General Overview

Following the VPP architecture (see Sec. 2), mmb forwarding graph consists in two nodes, a *classification* (e.g., ip4-mmb-classify) and a *rewrite* node (e.g., ip4-mmb-rewrite), as shown in Fig. 3. When mmb is enabled, its nodes are connected to the processing graph. If IPv6 is available, the IPv6 variants of those two nodes can also be connected to the IPv6 forwarding graph. The classification node is placed right after the ip4-input (or ip6-input) node, that validates the IP4 header checksum, verifies its length and discards packets with expired TTLs.

Depending on the outcome of the classification step, that can either be *drop*, *miss*, or *match*, packets are forwarded respectively to the *error-drop* node which will discard them, to ip4-lookup, the node responsible for the Forwarding Information Base (FIB) lookups, that then dispatches packets to the corresponding processing path, or the mmb-rewrite node, applying modification rules to packets.

```

# mmb <add-keyword> <match> [<match> ... <match>]
                        <target> [<target> ... <target>]

<add-keyword> : add-stateless | add-stateful
<match>       : <field> <condition> <value>
<target>      : mod <field> <value> | add <field> <value>
                | strip [!] <field> | map <field> <value>
                | shuffle <field>   | drop

```

Figure 4: mmb command-line interface syntax.

Overall, mmb consists in three processing paths that can each be traversed or not by packet vectors, depending on the input policies. A fast path, which relies on VPP bounded index hash tables and implements the mask-based matching operation using binary operators, is shown in Fig. 5. This path is enabled when a rule without any TCP option is entered. Moreover, it restricts the conditions to == (isequal). The stateful flow matching is using this fast path. A first slow path for rules that uses complex conditions ( $\neq$ ,  $<$ ,  $>$ ,  $\leq$ ,  $\geq$ ), and a second slow path for the linked list parsing required when classifying based on TCP options as well as when rewriting them.

The main goal of mmb is to be easily configurable, and to allow defining a wide range of middlebox policies by combining rules, defined by using commands with a generic semantic [11, 13], at high-speed. To this end, we define a grammar (see Fig. 4) that can be used to build a packet processing middlebox directly from a command-line interface. For example, building a middlebox that rewrites TCP port 80 to port 443 is done as follows:

---

```
vpp# mmb add tcp-dport 80 mod tcp-dport 443
```

---

Here is another example of a middlebox stripping all options but MSS and WSCALE if the packet contains the timestamp option:

---

```
vpp# mmb add tcp-opt-timestamp strip ! tcp-opt-mss strip ! tcp
-opt-wscale
```

---

A full usage of the command-line interface with examples is provided with mmb source code.<sup>1</sup>

### 3.2 Classification Node

mmb packet processing is displayed in Fig. 2. The classification node is an extension to VPP classification module, that consists in four distinct steps: a mask-based constraint matching step, an index lookup pool, a complex matching step and a connection table.

The mask-based matching determines if each packet satisfies constraints on fixed offset fields. For this, we create one classification table per packet mask (e.g., per combination of fields in the match constraint), sized from 16 bytes to at most 80 consecutive bytes. We create one key for a given table per value for its associated packet mask. For each table,

---

#### Algorithm 1 Matching operation

---

```

function MATCH(pkt, mask, key, skip, chunks)
  res  $\leftarrow$  (pkt[skip] & mask[0])  $\oplus$  key[0]
  switch chunks do
    case 5
      res  $\leftarrow$  res | ((pkt[skip + 4] & mask[4])  $\oplus$  key[4])
    case 4
      res  $\leftarrow$  res | ((pkt[skip + 3] & mask[3])  $\oplus$  key[3])
    case 3
      res  $\leftarrow$  res | ((pkt[skip + 2] & mask[2])  $\oplus$  key[2])
    case 2
      res  $\leftarrow$  res | ((pkt[skip + 1] & mask[1])  $\oplus$  key[1])
    case 1
      break
    default
      abort()
  if zero_byte_mask(res) = 0xffff then
    return 1
  else
    return 0

```

---

the search for a key matching a given packet is a hash-based search performed in constant time.

The matching operation consists of two binary operations (AND and XOR), as shown in Fig. 5.1, which are applied to consecutive chunks of 16 bytes, starting from the first non-zero byte in the mask. Each results are OR'ed into a 16-byte variable, that is compared to zero to verify if the matching operation was successful. This operation is illustrated in Alg. 1.

Then, for each packet that matched at least one mask-key combination, mmb checks if an additional matching is needed, with a constant-time lookup, and performs it. Additional matching is necessary for constraints on linked-list based fields such as TCP options.

Finally, each packet is matched to a connection table via its 5-tuple. The connection tables keep track of every connection that matched at least one stateful rule, and implements a flag tracking and a timeout mechanism without interruptions. This allows, for example, for reflexive policies. Both TCP and UDP are handled by the connection table.

If a packet matches at least one rule with a drop target, it is immediately forwarded to the error-drop node. If the packet matches only non-drop rules, it is forwarded to the mmb-rewrite node, and if the packet does not match any rule, it is handed to the next non-mmb node, ip4-lookup.

### 3.3 Rewrite Node

The mmb-rewrite node consists in two operations: a mask-based rewrite step that works on the fixed offset fields, similarly to the first step of the classification node, and a complex rewrite step for linked-list based fields.

$$Result_{Classif.} = (Packet \& Mask) \oplus Key \quad (1)$$

$$Result_{Rewrite} = (Packet \& Mask) | Key \quad (2)$$

Figure 5: Binary operations for packet classification and rewrite.

To perform the rewrite operation, or application of targets, we build a target mask and a target key when the rule is added. The rewrite is then performed with two binary operations (AND and OR), as shown in Fig. 5.2.

`mmb` allows to perform packet mangling by defining, for any rule, a set of static and dynamic targets. Static targets consists in setting a user-defined value to a chosen field. In the case of TCP options, targets may also define an option strip or an addition. Dynamic targets allows for setting a different value, within a predefined value range or random, on a per-connection basis.

## 4 Performance

In this section, we evaluate `mmb` performances. We describe and motivate the selected use cases, introduce the state-of-the-art kernel-bypass frameworks and other tools that we compare to and we explain how we configured them. Finally, we discuss the obtained results.

### 4.1 Testbed Description

The testbed consists of three machines with Intel Xeon CPU E5-2620 v4 @ 2.10GHz, 8 Cores, 16 Threads, 32GB RAM, running Debian 9.0 with 4.9 kernels. Two of these machines play the role of Traffic Generators (TGs), while one is the Device Under Test (DUT). An additional machine with Intel Xeon CPU E5-2630 v3 @ 2.40GHz 8 Cores, 16 Threads, 16GB RAM, running Ubuntu Server 18.04.1 with 4.15 kernel, is used as alternative DUT for experiments requiring a more recent kernel. Each machine is equipped with a Intel XL710 2x40GB QSFP+ NIC with Receive-Side Scaling enabled (RSS) connected to a Huawei CE6800 switch using one port each for TGs and both for the DUT.

The DUT runs VPP 18.10, DPDK 18.08 with 10 1-GB huge pages, and a `kvm/QEMU` 2.8.1 hypervisor with a Ubuntu 18.04 guest. The TGs run `iperf3` [27], `nginx` 1.10.3 and `wrk` 4.0.2.

The DUTs are configured to maximize their performances. The scaling governor is set to run the CPU at the maximum frequency. 7 cores out of 8 (14 threads) are isolated from the kernel scheduler to make sure that no other tasks is being run on the same physical CPU, and pinned to the process under test. We enable `adaptive-ticks` CPUs to omit unnecessary scheduling-clock ticks for CPUs with only one runnable task,

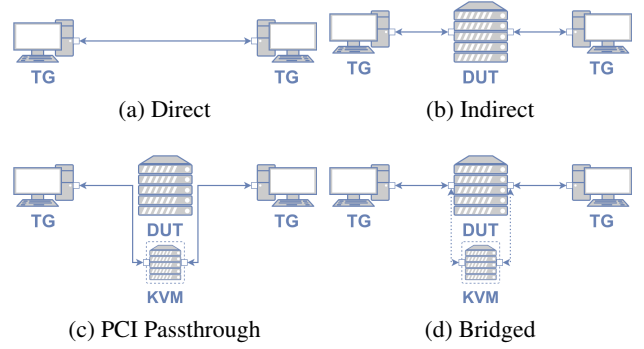

Figure 6: Measurement Setups. TG = Traffic Generator. DUT = Device Under Test. Plain arrows are physical connections, Dotted arrows are bridge networks and the machine surrounded by dots is a virtual machine.

which we ensure by setting the CPU affinity for VPP, and we enable Read-Copy-Update (RCU) callback offloading.

We configured our testbed into four different setups: A *direct* client-to-server communication setup, shown in Fig. 6a, that is used to evaluate bandwidth baselines and rule out sender-bounded experiments. An *indirect* setup, Fig. 6b, in which the DUT forwards traffic between sender and receiver by running code on its host OS. A *PCI passthrough* setup, Fig. 6c, allowing the hypervisor to directly connect a PCI device, in our case the NIC, with a guest OS. Finally, a *bridged* setup, Fig. 6d, where the guest OS interfaces are connected to the host OS interfaces using two bridges.

PCI passthrough relies on hardware virtualization, which is made available by Intel Virtualization Technology for Directed I/O (Intel VT-d), and on I/O translation, which is provided by Input-Output Memory Management Unit (IOMMU), in order to allow guest virtual machines to directly use PCI devices. We also evaluated the `virtio KVM` I/O virtualization driver, which allows DPDK to have fast virtual access to PCI devices, and although more difficult to configure properly, `virtio` does not show significant differences in performance. We did not evaluate Single Root-I/O Virtualization (SR-IOV), but we expect it to performs similarly.

As mentioned above, we generate traffic using both `iperf` and `wrk` with `nginx`. Given that `iperf` relies on a single TCP connection, it is bounded to a single CPU, and we have to make sure that we measure the performance of the DUT and not the TGs. To this end, we run a single pair of `iperf` client-server using the direct setup, and we add `iperf` client-server pairs until the bandwidth reaches the maximum capacity. We found that at least 3 `iperf` client-server pairs are needed to allow us to reach a consistent 37.7 Gbps bandwidth, which is the closest that `iperf` can get to the maximum capacity of the NICs. We arbitrarily choose to use 7 `iperf` pairs for the rest of the experiments. This experiment aims at analyzing the effect of a small amount of large flows, whose processing cannot be

distributed on all available DUT CPUs.

The wrk+nginx traffic generators consists in one TG running nginx, hosting files of different size (1KB, 2KB, 4KB, 8KB, 16KB, 32KB, 64KB, 128KB, and 256KB), and the other TG running 32 wrk threads, each opening 128 connections and transferring the same file. We notice that, when transferring files from 1 KB to 32 KB, the bandwidth is linearly increasing. Starting from 32-KB files, the bandwidth reaches a threshold that holds for experiments transferring files from 64 KB to 256 KB. We arbitrarily choose to transfer the 128KB file for all wrk+nginx experiments. At line-rate, wrk generates an average of 35,780 requests/sec.

For both iperf and wrk+nginx traffic generation, the experiments last for 20 seconds and omit the first second, to avoid transient effects. Packets are sized according to Ethernet MTU. All NICs distributes packets to the RX rings by hashing both IP addresses and ports. Each experiment result is averaged over ten runs for bandwidth measurements, and a thousand runs for RTT and CPU measurements.

## 4.2 Experiments

The experiments consist in comparing `mmb` to trending high-speed packet processors: FastClick [4], XDP [16], and iptables [2]. We evaluate two Linux kernel versions (i.e., 4.9 and 4.15) for both `mmb` and iptables because they exhibit significant performance differences. Below, we describe the compared tools.

FastClick [4] is a packet processor framework based on the Click modular router [21]. It comes with multi-queue support, zero-copy forwarding, I/O and computation batching, and integrates both DPDK [1] and Netmap [25]. It emerged from the analysis and integration of the best ideas of previous work such as RouteBricks [10] and DoubleClick [20], plus a few additional performance improvements. It also greatly eases the writing of Click configurations, as the framework can handle some level of parallelization automatically, without requiring the user to allocate resources manually as in the other Click-based frameworks.

eXpress Data Path (XDP) [16] is a high-performance programmable kernel packet processor for Linux. It does not replace the TCP-IP stack, but rather adds an extra filtering step based on extended Berkeley Packet Filters (eBPF). The latter are able to perform stateless lookups, flow lookups, and flow state tracking. The main use cases of XDP are pre-stack DDoS filtering, forwarding, load balancing, and flow monitoring. There is a proposal for the migration of Linux iptables to eBPF/XDP-based filtering [6, 19]. We point out that it is possible to use XDP alongside VPP and `mmb`. Because eBPFs are introduced in the 4.14 kernel, we only evaluated XDP on the Ubuntu Server 18.04 DUT.

iptables is the builtin Linux firewall application [2]. It relies on netfilter, the kernel packet filtering framework, which consists in multiple filtering hooks (`NF_IP_LOCAL_IN`,

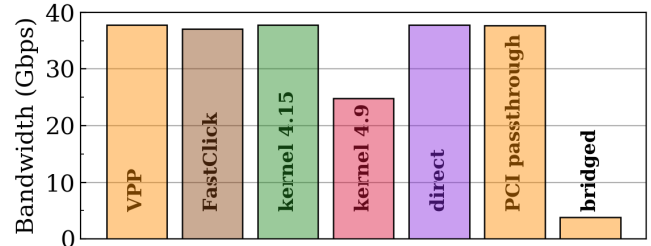

Figure 7: Forwarding baselines. TGs are running iperf. In indirect setup, DUT is forwarding packets through either VPP, FastClick, kernel 4.9 or 4.15. In PCI passthrough and bridged setups, DUT is running VPP.

`NF_IP_FORWARD`, `NF_IP_LOCAL_OUT`) positioned strategically in the networking stack, that are triggered by packets as they progress in the stack. However, the filtering is performed sequentially and the packets that matches drop rules are not necessarily dropped immediately and might stay longer in the processing pipe. iptables also comes with a connection tracking system (`conntrack`), implemented on top of netfilter.

The following use cases are considered for comparing the performances of `mmb` to FastClick, XDP, and iptables: packet forwarding, firewall-like packet filtering, packet filtering with stateful flow tracking, packet filtering with stateful matching and packet mangling (i.e., NAT), and TCP options filtering and mangling. We also report additional results showing the limitations of `mmb` matching algorithm, and an analysis of its CPU time.

## 4.3 Results

### 4.3.1 Forwarding

We first evaluate the TG bottleneck, by running both experiments using the *direct* setup. We obtain 37.7 Gbps with both iperf and wrk with nginx. Then, we evaluate VPP, FastClick, and kernel forwarding baselines for the *indirect* setup, and the VPP forwarding baseline for the *PCI passthrough* and *bridged* setups. The results are displayed in Fig. 7.

We observe that VPP, FastClick, and Linux kernel 4.15 forward packets at more than 99% of the direct baseline. The Linux kernel 4.9 performs substantially worse, forwarding only at 24.8 Gbps. We conducted additional analyses and ruled out unfortunate queue balancing, CPU loads, and RX input hash methods as the causes of this difference.

When running VPP, both the *indirect* and *PCI passthrough* setups reach the *direct* baseline. Both setups continue to behave similarly in following experiments. We note that this advocates in favor of `mmb` deployment flexibility and from now on, we report a single result that stands for both setups. Unsurprisingly, the *bridged* performs very poorly at 3.6 Gbps, emphasizing so the importance of direct I/O.

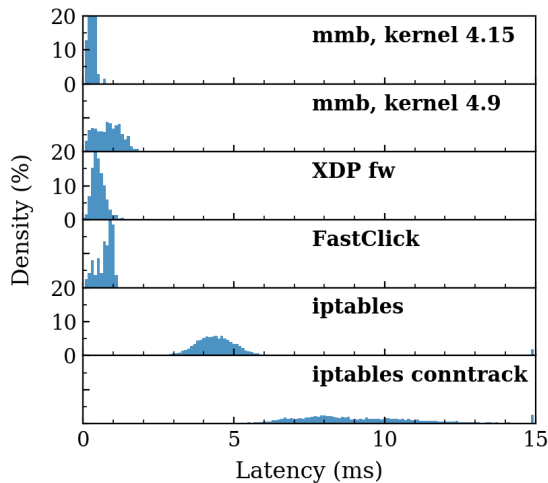

Figure 8: RTT with 10K firewall rules.

### 4.3.2 Firewall

We configure `mmb` as a firewall and compare it to a FastClick firewall configuration, an XDP-based firewall, and the kernel forwarding with `iptables` filtering, to evaluate their applicability to a basic firewall-like packet filtering use case. To this end, a generator of random firewall rules is used. Rules classify packets based exclusively on five-tuples, to enable tools with mask-based hash classification approaches (e.g., `mmb` and XDP) to only use one single table. We ensure that no rules are matching the traffic from the TGs. We generate a new set of rules for every experiment. In the real world, these middlebox policies can be used as a firewall as well as DDoS protection measures. We inject these rules to `mmb` as stateless rules.

For XDP, we build a simplistic five-tuple firewall. We use a BPF hash map with five-tuples as keys, and use it to store the type of rule (i.e., accept or drop) and the count of accepted and dropped packets. Every time a packet is received, an eBPF will check for an entry in the map corresponding to the current packet. If it is found, then the related drop counter is incremented and the packet dropped. Otherwise, the packet passes.

When the DUT is running `iptables`, we inject the rules to the `FORWARD` chain.

For FastClick, we use an `IPFilter` element that will drop packets matching a rule (i.e., none in our test), and will pass them to the routing table otherwise. As `IPFilter` elements can only support up to  $2^{16}$  rules, we have to chain several of those to support more rules. The `click-fastclassifier` post-processing tool was not used. While it moderately improves performance, it takes a huge amount of time and RAM to optimize the configuration, and makes it static (i.e., preventing so live reconfiguration).

The bandwidth results are shown in Fig. 9a and 9d. It shows that XDP and VPP with `mmb` on a 4.15 kernel, keep a constant forwarding rate, regardless of the number of rules. Both are performing very close to the direct baseline, at the exception of XDP on `iperf`-generated traffic, that has a large standard deviation (not represented in this figure) which we believe is the effect of unfortunate CPU distribution. This effect is not present with `wrk` traffic, because it generates more flows, whose processing distributes better on multiqueue systems. The `mmb` firewall on a 4.9 kernel shows signs of rule count dependent performance, but we believe this is rather due to the kernel.

`iptables` on a 4.15 kernel surprisingly sustains a line-rate bandwidth until 1,000 rules are inputted, while `iptables` on 4.9 kernel performance decreases already with very few rules.

FastClick performance decreases even more quickly with the number of rules (no data is depicted for more than 10,000 rules because the slow processing stalls the TGs). This is due to the implementation of the `IPFilter` element that, as already noted, is not designed for a large number of rules. On the contrary to `mmb` and XDP that use a  $O(1)$  hash-based approach to match packets to rules, FastClick uses a binary search which requires  $O(\log_2 n)$  comparisons. Moreover, the matching code has bad cache locality, further contributing to the performance drop.

This experiment indicates that the `mmb` mask-based *fast path*, when relying on a single table, has a very limited impact on the maximum achievable bandwidth of the forwarding device, regardless on the number of rules.

In Fig. 8, we display the average RTT distribution for the same use case, with 10,000 rules. It shows that all DPDK-based I/Os, plus XDP, have an average RTT under 1 ms. At the microsecond scale, `mmb` on a 4.15 kernel performs better with an average RTT of  $327 \mu\text{s}$ , against  $562 \mu\text{s}$  for XDP and  $771 \mu\text{s}$  for FastClick.

### 4.3.3 Stateful

Next, we confront the chosen tools to the packet filtering with stateful flow tracking use case. We generate sets of rules matching on the received packets five-tuple, similarly to the previous experiment. In addition to that, we input a static set of rules to guarantee that all traffic from the TGs is matched, to enable flow tracking capabilities of the tested tools, and quantify the inducted performance overhead. In the real world, this type of middlebox policies can be used for private network-initiated reflexive ACLs.

We inject these rules to `mmb` as stateful rules in order to have every packet matching at least one rule to add an entry to the connection table. All packets, matching or not, are also checked against the opened connections, whose states are updated when needed.

For FastClick, we use an `IPRewriter` element for connection tracking. Each packet goes through that element when

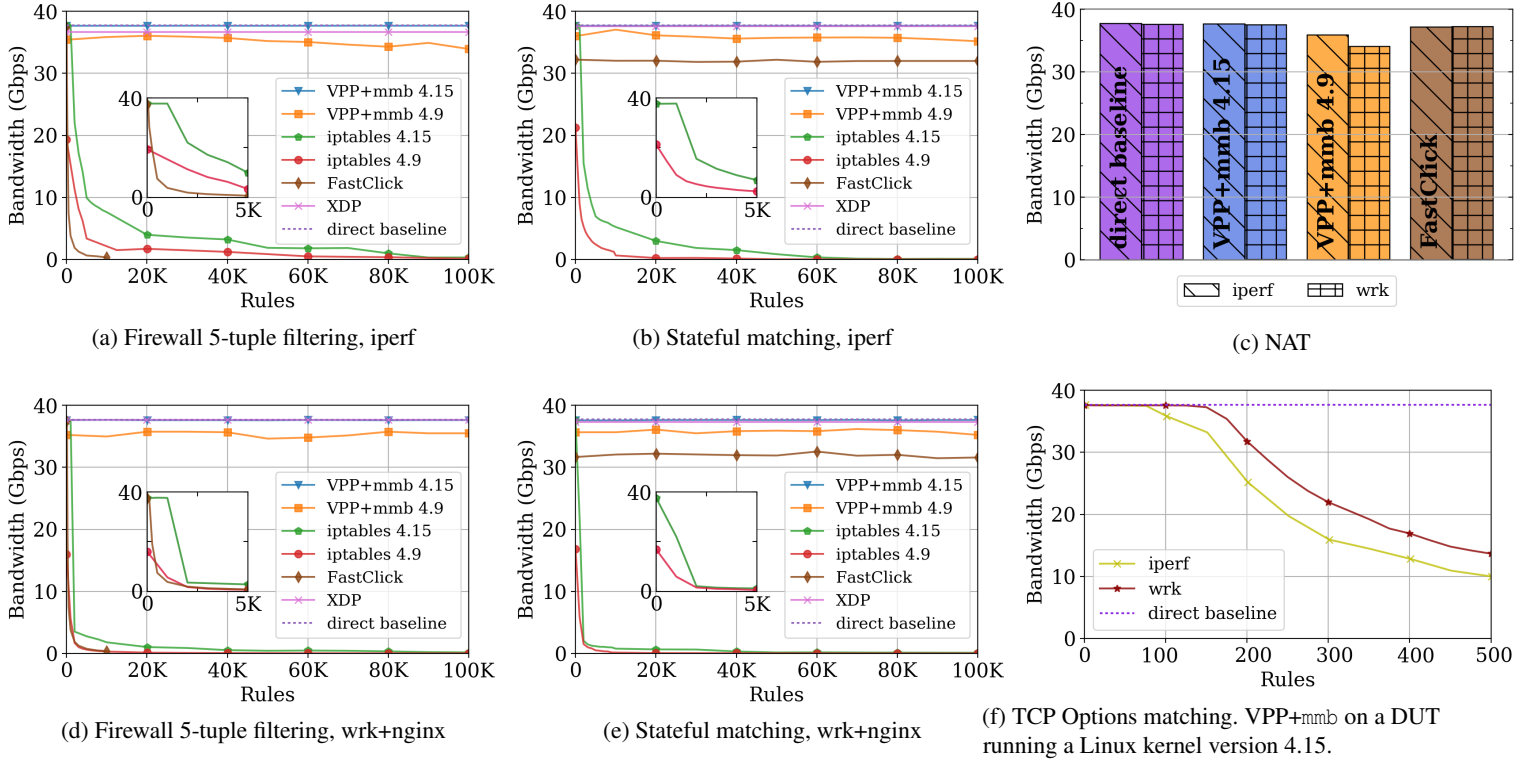

Figure 9: Performances in *indirect* setup. *direct* baseline traffic does not traverse the DUT.

leaving the middlebox, triggering the creation of a new flow entry if it is a flow first packet. Packets also go through that element just after entering the middlebox. If a packet matches an existing flow, it is passed directly to the routing table rather than to the IPFilter. IPReewriter is not thread-safe and will only recognize a return packet as belonging to a flow if it is processed on the same core that created the flow entry. As Receive-Side-Scaling cannot enforce that, we use one IPReewriter per core and keep separate flow state for both directions.

iptables is configured as a stateful firewall by enabling `conntrack`, the iptables netfilter-based connection tracking module, and injecting rules to the `FORWARD` chain.

With XDP, we build a stateful flow tracker using three different BPF hash maps. One for connections tracking, one for three-tuple matching rules and one for five-tuple matching rules. We ensure that all operations are as simple as possible to avoid unnecessary processing overhead. The five-tuple map is filled with the randomly generated rules, and the three-tuple map with the static rules. Both maps are used to filter packets and add entries to the tracking map. The tracking map contains the list of forwarded flows that matched at least one rule, with hashes of the five-tuples as keys. This map also stores various pieces flow information such as flow timestamps, TCP state, packet counters, and involved interfaces. Since a full TCP state machine is superfluous for this use case,

we implement a simplified version by observing all TCP flags sent from both ends of every connection, which is enough to differentiate transient from idle connections.

Results are displayed in Fig. 9b and 9e. As in the previous experiment, `mmb` on a 4.15 kernel and XDP have constant line-rate performances. iptables on a 4.15 also shows similar performance than for the stateless firewall experiment, while iptables kernel 4.9 with `conntrack` performs worse than without it.

FastClick performs better than for the stateless case, because the costly filtering step is done only for the first packet of each flow (but in both directions). Its performance is still significantly lower than that of `mmb` or XDP, however.

#### 4.3.4 NAT

The NAT experiment consists in DUT running a Source Network Address Translation (SNAT) with port translation. The straightforward way to configure `mmb` as a SNAT, with 200.0.0.1 as the globally routable address, relies on the single following rule:

```
vpp# mmb add-stateful ip-saddr 10.0.0.0/24 ip-proto tcp tcp-
      shuffle tcp-sport mod ip-saddr 200.0.0.1
```

For FastClick, we use IPReewriter elements to implement the SNAT. When a packet leaves the DUT towards the server,



it goes through an `IPRewriter` which will rewrite its source address and port, adding a new flow entry if necessary. The port is chosen in a range that depends on the processing core so that on the return path, the packets can be dispatched to the same core for the reverse transformation using a simple match on the destination port.

As shown in Fig. 9c, the average bandwidth of traffic crossing an `mmb` NAT is equals to the direct baseline. `mmb` performs 1 and 2.5 Gbps worse on a 4.9 kernel, which we believe is directly caused by a constant kernel overhead, observed on all other use cases. `FastClick` performance is very similar. While the `Click` configuration for the NAT also comprises a slow `IPFilter` element, it is used only on the return path, and contains just one rule per core. The NAT performance is thus better than the one of the stateful firewall.

### 4.3.5 TCP Options

Finally, we evaluate the performance of traffic engineering policies that matches and mangle TCP Options. The processing of TCP Option, or IPv6 Extension Headers, is more complex because it requires linked list parsing for every packet. Because any ingress middlebox is able to strip or add TCP Options, the presence and order of TCP Options in a TCP packet is not known a-priori. This forbids `mmb` to exploit a rule-defined or connection-defined mask-based approach for parsing TCP options. For this use case, we inject rules that match on random value of random TCP Options. We do not mangle TCP options because it would disrupt TCP and affect its performance. However, because the linked list parsing is done once, we predict that mangling option do not increase substantially the processing time.

`FastClick` is not tested against this use case because none of the distributed elements is able to match on variable-offset TCP options. We would have to write new elements for TCP option parsing and mangling, which would require a significant amount of code.

XDP is also not tested against this use case because eBPF brings limitations explained in the next section, which are exceeded by the task of implementing complex packet mangling.

The bandwidth measurement results, displayed in Fig. 9f, indicates that the threshold of injected TCP Options-based classification rules to sustain line-rate packet forwarding, for traffic generated with `iperf`, and `wrk` with `nginx`, are respectively 100 and 150. This difference is explained by the high CPU-time requirements of this use case, that we investigate in Sec. 4.3.7, which makes it benefits from multi-core processing.

### 4.3.6 Limitations

We conducted an additional experiment on the firewall use case to quantify the performance gain of `mmb` mask-based

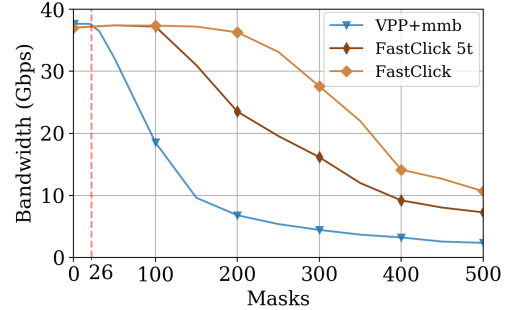

Figure 10: Stability limit of `mmb` mask-based matching. `FastClick 5t` is the firewall matching on 5-tuples. `FastClick` is the firewall matching on random rules.

approach (see 3.2). In this scenario, each inputted rule is deliberately generated to match on a different combination of five fields, in order to force the use of one table for each single rule. The results are shown in Fig. 10.

It shows a clear limit of 26 combinations of fields for line-rate processing, after which the performances start to diminish. With more than 40 combinations, performances drop significantly faster. We explain it by the limited size of the cache that is too small to hold all prefetched hash tables to avoid cache miss. We advocate that this limitation is largely sufficient for a realistic usage.

XDP runs almost at line rate for both firewall (Fig. 9a and Fig. 9d) and stateful (Fig. 9b and Fig. 9e) use cases, which makes it a good alternative to `mmb`. But, although very good, it introduces some limitations and restrictions. Indeed, the in-kernel eBPF verifier is a static code analyzer that walks BPF programs instruction per instruction, and validates them. Moreover, stack space in BPF programs is limited to only 512 bytes which means that any program must terminate quickly and will only call a fixed number of kernel functions. As a consequence, larger programs or programs that contain loops will be rejected, which provides security and reliability for the kernel but can be a drag on developers.

While `FastClick` does not support large numbers of rules, we observe that its matching algorithm, based on a decision tree, is not affected much by the number of combinations of fields it is matching on, and it can sustain 35 Gbps up to 200 rules with different masks. The performance is even slightly better than the one for the five-tuple firewall, since there is more variety in the rules. E.g., if a packet is a TCP packet, all rules for other protocols (ICMP, UDP, etc.) can be ruled out with a single comparison of the IP protocol field.

### 4.3.7 CPU time

We measured the cost in CPU cycles of packet processing, which is available through VPP API, for four extreme use cases: respectively a firewall with 100K rules, a flow tracker

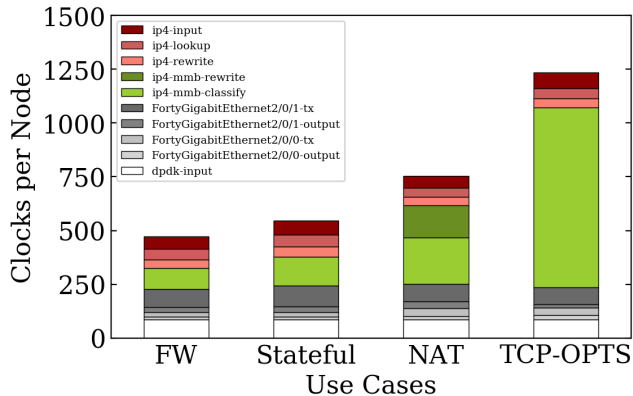

Figure 11: CPU clock cycles per packet. fw is a 5-tuples firewall with 100K rules, stateful is a flow tracker with 100K rules and one guaranteed match, NAT is a source NAT, tcp-opts is a TCP option classifier and rewriter with 100 rules.

with a 100K rules and a guaranteed match, a source NAT and a transport-level engineering middlebox that parses and modify TCP options that contains 100 rules. The result, presented in Fig. 11, shows that, for the first three experiments, performing combinations of packet filtering, stateful tracking, and packet mangling rules, *mmb* is able to maintain a low rate of CPU cycles per packet. In particular, packet filtering and flow tracking consume less CPU time, respectively 96 and 135, than the rest of VPP IP processing path (*ip4-input*, *ip4-lookup*, and *ip4-rewrite*), whose execution requires an average of 155 CPU cycles per packet. Finally, packet classification based on TCP Options consumes the most CPU time, i.e., 836 clocks per packet. We remind that this experiment is an extreme use case that corresponds to the most complex task that can be performed by *mmb* while sustaining line-rate forwarding. Moreover, realistic use cases are not likely to require as many different policies.

## 5 Related Work

Over the years, numerous works have been proposed for fast and efficient packet processing. Among others, one can cite *iptables* [2] (the built-in Linux firewall application), *PF\_RING* [9] (a software I/O framework that modifies the socket API to avoid buffer reallocation and bypass unnecessary kernel functionalities to improve the performances of packet capture from those of *libpcap*), *PacketShader* [15] (a GPU-accelerated software router framework, that perform I/O batching and kernel bypass) and *eXpress Data Path* (XDP) [16], a high-performance programmable kernel packet processor for Linux.

The more specific *mOS* [17] is a networking stack for building stateful middleboxes. Its ambition is to provide a high-

performance general-purpose flow management mechanism. It comes with an API to allow for building middleboxes applications requiring flow state tracking such as stateful NATs, or payload reassembly such as NIDS/NIPS and L7 protocol analyzers. *mOS* is based on *mTCP* [18], a parallelizable userspace TCP/IP stack.

The *Click* modular router is a flexible router framework [21]. It was not specifically designed for high-speed packet processing as it relies on the Linux kernel via system calls for certain tasks, leading so into an increase in processing time. Further, on the contrary to *mmb*, *Click* requires the user to write C++ classes to build new functionalities. *Click* has been extended over the years to overcome its limitations. *RouteBricks* [10] brings hardware multiqueue support to *Click*, and introduce an architecture for parallel execution of router functionalities as a first step towards fast modular software routers. *DoubleClick* [20] integrates *PacketShader* I/O batching and computation batching. Moreover, it also takes advantage of the non-uniform memory access (NUMA) CPU architecture. *FastClick* [4] comes with multiqueue support, zero-copy forwarding, I/O and computation batching, and integrates both *DPDK* [1] (user-level packet I/O framework) and *Netmap* [25] (one of the earliest user-level packet I/O framework). *FastClick* comes with a wide variety of elements, and is able to implement more diverse policies than *mmb*. Moreover, one of *FastClick* key point is the ease of writing new *Click* configurations. However, the process of choosing and building a suited element pipeline still require substantial effort and expertise. *MiddleClick* [3] further enhances *FastClick* with flow-processing capabilities. It comes, among others, with an optional middlebox-oriented TCP stack. Moreover, *MiddleClick* speeds up NFV chains by factorizing tasks such as classification, which is done only once for a whole service chain, and can be offloaded to hardware. Finally, *ClickNP* [22] is an FPGA-based packet processing framework whose abstraction mimics *Click*. *ClickNP* is supposed to improve parallelism, and shows extreme performance improvement with more than 200 MPps, but it requires dedicated expensive hardware.

This paper has shown that VPP with *mmb* performs better than those state of the art solutions for fast packet middlebox processing.

## 6 Conclusion

For now ten years, we observe that middleboxes have become more and more popular at every floor of the network (corporate, mobile networks, tier-1 ASes). Those middleboxes have to deal, also, with an increasing Internet traffic, meaning that they have to process packets at very high rate.

This paper introduced *mmb* (Modular Middlebox), a high-performance modular middlebox, implemented as a VPP plugin. *mmb* can be used to deploy out-of-the box middleboxes and to easily and intuitively configure custom policies through

its command-line interface, on the contrary to state-of-the-art solutions usually requiring dedicated hardware, specific OS or non-trivial programming.

We compared `mmb` to other trending high-speed packet processors (FastClick, XDP, iptables) and demonstrated, through several use cases, that `mmb` is able to sustain packet forwarding at line-rate speed when applying a large number of diverse and complex classification and mangling rules. `mmb` is open source and freely available.<sup>1</sup>

In the near future, we would like to push further the `mmb` development. In particular, we are interested in Layer-7 payload reassembly and generic application-level matching and mangling rules.

## Acknowledgments

This project has received funding from the European Union's Horizon 2020 research and innovation program under grant agreement No 688421. The opinions expressed and arguments employed reflect only the authors' views. The European Commission is not responsible for any use that may be made of that information. Further, the opinions expressed and arguments employed herein do not necessarily reflect the official views of the Swiss Government.

## References

- [1] Data plane development kit. <https://dpdk.org>.
- [2] iptables manpage. <https://ipset.netfilter.org/iptables.man.html>.
- [3] BARBETTE, T., SOLDANI, C., GAILLARD, R., AND MATHY, L. Building a chain of high-speed VNFs in no time. In *Proc. IEEE International Conference on High Performance Switching and Routing* (June 2018).
- [4] BARBETTE, T., SOLDANI, C., AND MATHY, L. Fast userspace packet processing. In *Proc. ACM/IEEE Symposium on Architectures for Networking and Communications Systems (ANCS)* (July 2015).
- [5] BONCZ, P. A., MANEGOLD, S., AND KERSTEN, M. L. Database architecture optimized for the new bottleneck: Memory access. In *Proc. International Conference on Very Large Data Bases (VLDB)* (September 1999).
- [6] BROUER, J. D., AND HØILAND-JØRGENSEN, T. XDP – challenges and future work. In *Proc. Linux Plumbers Conference* (November 2018).
- [7] CISCO. Vector Packet Processing (VPP), 2002. See <https://fd.io>.
- [8] CISCO. Cisco visual networking index: Forecast and trends 2017–2022, 2018. Cisco White Paper.
- [9] DERI, L. Improving passive packet capture: Beyond device polling. In *Proc. International System Administration and Network Engineering Conference (SANE)* (September/October 2004).
- [10] DOBRESCU, M., EGI, N., ARGYRAKI, K., CHUN, B.-G., FALL, K., IANNACCONE, G., KNIES, A., MANESH, M., AND RATNASAMY, S. Routebricks: Exploiting parallelism to scale software routers. In *Proc. Symposium on Operating Systems Principles (SIGOPS)* (October 2009).
- [11] EDELINE, K., AND DONNET, B. Towards a middlebox policy taxonomy: Path impairments. In *Proc. IEEE International Workshop on Science for Communication Networks (NetSciCom)* (April 2015).
- [12] EDELINE, K., AND DONNET, B. A first look at the prevalence and persistence of middleboxes in the wild. In *Proc. International Teletraffic Congress (ITC)* (September 2017).
- [13] EDELINE, K., AND DONNET, B. An observation-based middlebox policy taxonomy. In *Proc. ACM SIGCOMM CoNEXT Student Workshop* (September 2017).
- [14] GERBER, A., AND DOVERSPIKE, R. Traffic type and growth in backbone networks. In *Proc. Optical Fiber Communication Conference* (March 2011).
- [15] HAN, S., JANG, K., PARK, K., AND MOON, S. Packetshader: A GPU-accelerated software router. In *Proc. ACM SIGCOMM* (August 2010).
- [16] HØILAND-JØRGENSEN, T., BROUER, J. D., BORKMANN, D., FASTABEND, J., HERBERT, T., AHERN, D., AND MILLER, D. The eXpress data path: Fast programmable packet processing in the operating system kernel. In *Proc. ACM SIGCOMM CoNEXT* (December 2018).
- [17] JAMSHED, M. A., MOON, Y. G., KIM, D., HAN, D., AND PARK, K. S. mOS: A reusable networking stack for flow monitoring middleboxes. In *Proc. USENIX Symposium on Networked Systems Design and Implementation (NSDI)* (March 2017).
- [18] JEONG, E., WOO, S., JAMSHED, M. A., JEONG, H., IHM, S., HAN, D., AND PARK, K. mtcp: a highly scalable user-level tcp stack for multicore systems. In *NSDI* (2014), vol. 14, pp. 489–502.
- [19] KARLSSON, M., AND TÖPEL, B. The path to DPDK speeds for AF XDP. In *Proc. Linux Plumbers Conference* (November 2018).
- [20] KIM, J., HUH, S., JANG, K., PARK, K. S., AND MOON, S. The power of batching in the click modular router. In *Proc. Asia-Pacific Workshop on Systems* (July 2012).

- [21] KOHLER, E., MORRIS, R., CHEN, B., JANNOTTI, J., AND KAASHOEK, F. The click modular router. *ACM Transactions on Computer Systems* 18, 3 (August 2000), 263–297.
- [22] LI, B., TAN, K., LUO, L. L., PENG, Y., LUO, R., XU, N., XIO, Y., CHENG, P., AND CHEN, E. Clicknp: Highly flexible and high performance network processing with reconfigurable hardware. In *Proc. ACM SIGCOMM* (August 2016).
- [23] LINARO NETWORKING GROUP (LNG). Opendataplane (ODP), 2013. See <https://www.opendataplane.org>.
- [24] LINGUAGLOSSA, L., ROSSI, D., PONTARELLI, S., BARACH, D., MARJON, D., AND PFISTER, P. High-speed software data plane via vectorized packet processing. *IEEE Communications Magazine* 56, 12 (December 2018), 97–103.
- [25] RIZZO, L. Netmap: A novel framework for fast packet I/O. In *Proc. USENIX Security Symposium* (August 2012).
- [26] SHERRY, J., HASAN, S., SCOTT, C., KRISHNAMURTHY, A., RATNASAMY, S., AND SEKAR, V. Making middleboxes someone else’s problem: Network processing as a cloud service. In *Proc. ACM SIGCOMM* (August 2012).
- [27] TIRUMALA, A., QIN, F., DUAGN, J., FERGUSON, J., AND GIBBS, K. Iperf, the TCP/UDP bandwidth measurement tool, 2005. See <http://iperf.sourceforge.net/>.
- [28] WANG, Z., QIAN, Z., XU, Q., MAO, Z., AND ZHANG, M. An untold story of middleboxes in cellular networks. In *Proc. ACM SIGCOMM* (August 2011).