

# COMPUTATIONAL COMPLEXITY OF BIASED DIFFUSION-LIMITED AGGREGATION \*

NICOLAS BITAR <sup>†</sup>, ERIC GOLES <sup>‡</sup>, AND PEDRO MONTEALEGRE <sup>‡</sup>

**Abstract.** Diffusion-Limited Aggregation (DLA) is a cluster growth model that consists in a set of particles that are sequentially aggregated over a two-dimensional grid. In this paper, we introduce a *biased* version of the DLA model, in which particles are limited to move in a subset of possible directions. We denote  $k$ -DLA the model where the particles move only in  $k$  possible directions. We study the biased DLA model from the perspective of Computational Complexity, defining two decision problems. The first problem is PREDICTION, whose input is a site of the grid  $c$  and a sequence  $S$  of walks, representing the trajectories of a set of particles. The question is whether a particle stops at site  $c$  when sequence  $S$  is realized. The second problem is REALIZATION, where the input is a set of positions of the grid,  $P$ . The question is whether there exists a sequence  $S$  that realizes  $P$ , i.e. all particles of  $S$  exactly occupy the positions in  $P$ . Our aim is to classify the PREDICTION and REALIZATION problems for the different versions of DLA. We first show that PREDICTION is **P**-Complete for 2-DLA (thus for 3-DLA). Later, we show that Prediction can be solved much more efficiently for 1DLA. In fact, we show that in that case the problem is **NL**-Complete. With respect to REALIZATION, we show that restricted to 2DLA the problem is in **P**, while for 1DLA is in **L**.

**Key words.** Diffusion-Limited Aggregation, Computational Complexity, Space Complexity, NL-Completeness, P-Completeness

**AMS subject classifications.** 03D15, 68Q17, 68Q10

**1. Introduction.** Diffusion-Limited Aggregation (DLA) is a kinetic model for cluster growth, first described by Witten and Sander [26], which consists of an idealization of the way dendrites or dust particles form, where the rate-limiting step is the diffusion of matter to the cluster. The original DLA model consists of a series of particles that are thrown one by one from the top edge of a two (or more) dimensional grid. The sites in the grid can either be occupied or empty. Initially all the sites in the grid are empty, except for the bottom line which begins and remains occupied. Each particle follows a random walk in the grid, starting from a random position in the top edge, until it neighbors an occupied site, or the particle escapes from the top edge or one of the lateral edges. In case the particle finds itself neighboring an occupied site, the current position of the particle becomes occupied and the next particle is thrown. The set of occupied sites is called a *cluster*.

Clusters generated by the dynamics are highly intricate and fractal-like (see Figure 1); they have been shown to exhibit the properties of scale invariance and multifractality [12, 17]. DLA clusters have been observed to appear in phenomena such as electrodeposition, dielectrics and ion beam microscopy [7, 21, 22]. Nevertheless, perhaps the fundamental aspect of DLA is its profound connection to Hele-Shaw flow: it has been shown that DLA is its stochastic counterpart [9, 13].

---

\*Submitted to the editors September 9, 2022.

<sup>†</sup>Departamento de Ingeniería Matemática, Universidad de Chile, Santiago, Chile (nbitar@dim.uchile.cl). Supported in part by CONICYT-PFCHA/MagísterNacional/2019 - 22190497.

<sup>‡</sup>Facultad de Ingeniería y Ciencias, Universidad Adolfo Ibáñez, Santiago, Chile (eric.chacc@uai.cl, p.montealegre@uai.cl).

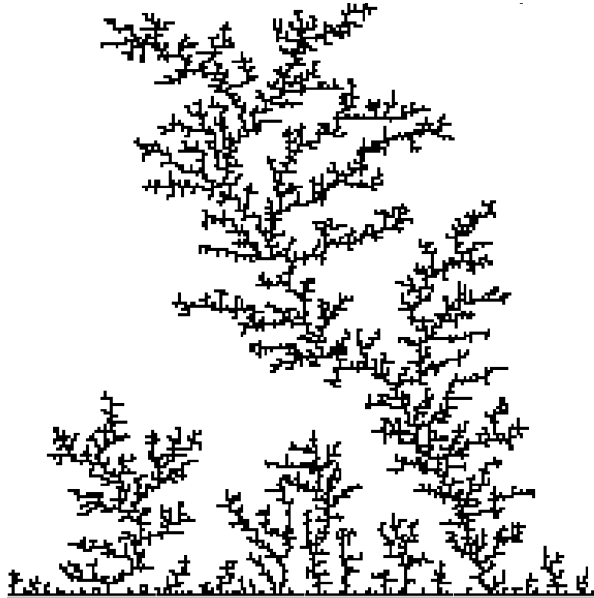

FIG. 1. A realization of the dynamics for a  $200 \times 200$  grid.

In this article we study *restricted versions of DLA*, which consist in the limitation of the directions a particle is allowed to move within the grid. We ask what would be the consequences of restricting the particles movement in terms of computational complexity. More precisely, we consider four models, parameterized by  $k \in \{1, 2, 3, 4\}$ . The 4-DLA model is simply the two-dimensional DLA model, i.e. when the particles can move in the 4 cardinal directions. The 3-DLA model is the DLA model when the particles can only move into the South, East or West direction. In the 2-DLA model, the directions are restricted to the South and East. Finally, in the 1-DLA model, the particles can only move downwards.

Even though the particles have restricted movement, it is possible to notice that the fractal-like structures are still present in the clusters obtained by the restricted DLA (see Figure 2).

It is interesting to note that, in fact, the 1-DLA model is a particular case of another computational model created to describe processes in statistical physics, that of the Ballistic Deposition Model. In this model, there is a graph and a set of particles that are thrown into the vertices at some fixed initial height  $h$ . The height of the particle decreases in one unit at a time, until it reaches the bottom (height 0 or meets another particle, i.e. there is a particle in an adjacent vertex at the same height, or in the same vertex just behind). The 1-DLA model corresponds to the Ballistic Deposition model when the graph is an undirected path.

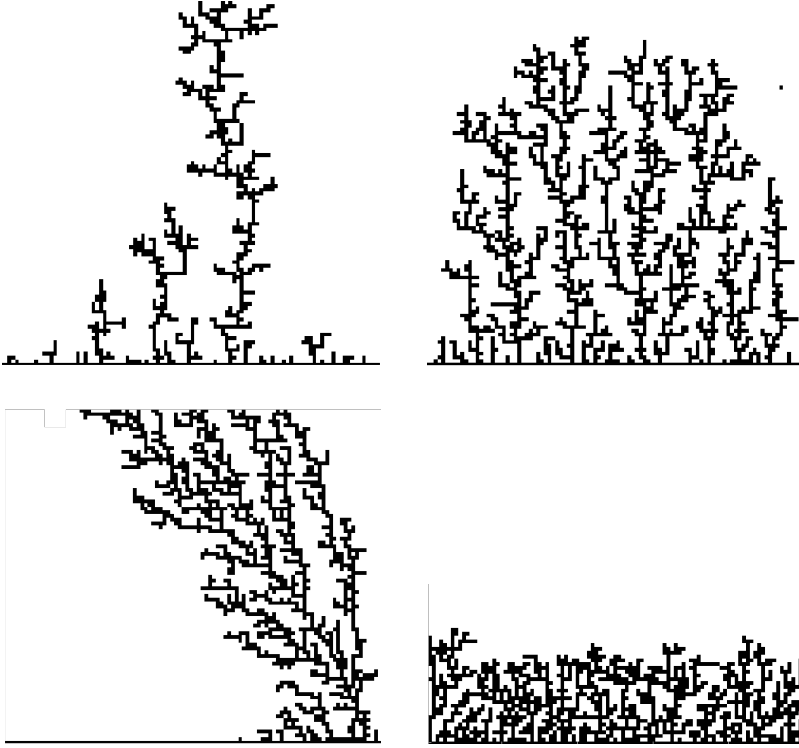

FIG. 2. DLA simulation for four (top left), three (top right), two (bottom left) and one (bottom right) directions, when  $N = 100$ .

Due to the generated cluster's properties, theoretical approaches to the DLA model are usually in the realm of fractal analysis, renormalization techniques and conformal representations [5]. In this article we consider a perhaps unusual approach to study the DLA model (and its restricted versions), related with its computational capabilities, the difficulty of simulating their dynamic, and the possibility of characterizing the patterns they produce. Machta and Greenlaw studied, within the framework of computational complexity theory, the difficulty of computing whether a given site on the grid becomes occupied after the dynamics have taken place, i.e. all the particles have stuck to the cluster or have been discarded [15]. Inspired by their work, we consider two decision problems:

- DLA-PREDICTION, which receives a the sequence of trajectories for  $n$  particles (i.e. the trajectories are deterministic and explicit) and the coordinates of a site in the lattice as input. The question is whether the given coordinate is occupied by a particle after the  $n$  particles are thrown.
- DLA-REALIZATION, which receives a pattern of size  $n \times n$  in the grid as input, and whose question is whether that pattern can be produced by the DLA model.

For each  $k \in \{1, 2, 3\}$  we call  $k$ -DLA-PREDICTION and  $k$ -DLA-REALIZATION, respectively, the problems DLA-PREDICTION and DLA-REALIZATION restricted to  $k$ -DLA model.

The computational complexity of a problem can be defined as the amount of resources, like time or space, needed to computationally solve it. Intuitively, the complexity of DLA-PREDICTION represent *how efficiently* (in terms of computational resources) we are able to simulate the the dynamics of DLA. On the other hand, the complexity of DLA-REALIZATION represent *how complex* are the patterns produced by DLA model.

We consider four fundamental complexity classes:  $\mathbf{L}$ ,  $\mathbf{P}$ ,  $\mathbf{NL}$  and  $\mathbf{NP}$ . Classes  $\mathbf{L}$  and  $\mathbf{P}$  contain the problems that can be solved in a *deterministic* Turing machine that use *logarithmic space* and take *polynomial time*, respectively. On the other hand  $\mathbf{NL}$  and  $\mathbf{NP}$  are the classes of problems that can be solved in a *non-deterministic* Turing machine that use *logarithmic space* and take *polynomial time*, respectively. For detailed definitions and characterizations of these classes we recommend the book of Arora and Barak [2]. A convention between computer theorists states that  $\mathbf{P}$  is the class of problems that can be solved *efficiently* with respect to computation time. In that context,  $\mathbf{NP}$  can be characterized as the classes of problems that can be *efficiently verified* with respect to computation time. Similarly, the same conventions hold for  $\mathbf{L}$  and  $\mathbf{NL}$  changing computation time for space.

It is easy to see that  $\mathbf{L} \subseteq \mathbf{NL} \subseteq \mathbf{P} \subseteq \mathbf{NP}$ , though it is unknown if any of these inclusions is proper. Perhaps the most famous conjecture in Computational Complexity theory is if  $\mathbf{P} \neq \mathbf{NP}$ . Put simply, this conjecture states that there are some problems whose solution can be efficiently verified but can not be efficiently found. As mentioned in last paragraph, in this context *efficiently* means polynomial time. Similarly, it is conjectured that  $\mathbf{L} \neq \mathbf{NL}$ , where in this case *efficiently* refers to logarithmic space. It is also conjectured that  $\mathbf{NL} \neq \mathbf{P}$ , meaning that some problems can be computed efficiently with respect to computation time, but can not be verified (or computed) efficiently with respect to space [2].

The problems in  $\mathbf{P}$  that are the most likely to not belong to  $\mathbf{NL}$  (hence not in  $\mathbf{L}$ ) are the  $\mathbf{P}$ -Complete problems [11]. A problem is  $\mathbf{P}$ -Complete if any other problem in  $\mathbf{P}$  can be reduced to it via a *log-space reduction*, i.e. a function calculable in logarithmic space that takes *yes*-instances of one problem into the other. In a nutshell, it is unlikely that some  $\mathbf{P}$ -Complete problem belongs to  $\mathbf{NL}$ , because in that case we would have that  $\mathbf{NL} = \mathbf{P}$ . Similarly a problem is  $\mathbf{NL}$ -Complete if any problem in  $\mathbf{NL}$  can be reduced to it via a  $\mathbf{L}$  reduction.  $\mathbf{NL}$ -Complete problems are problems in  $\mathbf{NL}$  that are the most likely to not belong to  $\mathbf{L}$ , because if some  $\mathbf{NL}$ -Complete problem were to belong in  $\mathbf{L}$ , it would imply that  $\mathbf{NL} = \mathbf{L}$  [2].

One  $\mathbf{P}$ -Complete problem is the CIRCUIT VALUE PROBLEM (CVP), which consists in, given a Boolean circuit and an truth-assignment of its input gates, compute the output value of a given gate. Roughly, this problem is unlikely to be solvable (or verifiable) in logarithmic space because there is no better algorithm than simply sequentially compute truth values of each gate of the Boolean circuit, keeping in memory the values of all gates already evaluated. One  $\mathbf{NL}$ -Complete problem is REACHABILITY, which consists in, given a directed graph  $G$  and two vertices  $s$  and  $t$ , decide if there is a directed path between  $s$  and  $t$ . Roughly, this problem is unlikely to be solvable in logarithmic space because there is no way to remember all paths starting from  $s$  that do not reach  $t$ .

Within this context, it was shown by Machta and Greenlaw [15], that DLA-PREDICTION is **P**-Complete. The proof of this fact consists of reducing to it a version of the Circuit Value Problem, which is known to be **P**-Complete [11]. Within this proof, we noticed that the gadgets used to simulate the circuits rely heavily on the fact that in the DLA model, particles are free to move in any of the four cardinal directions. On the other hand, in the context of the study of the Ballistic deposition model it was proven by Matcha and Greenlaw [14] that 1-DLA-PREDICTION is in **NC**. The class **NC** is a complexity class that contains **NL** and is contained in **P**.

**1.1. Our results.** We begin our study of the complexity of biased DLA analyzing the complexity of the DLA-PREDICTION problem. By extending the results of Machta and Greenlaw to the 2-DLA model, we show that 2-DLA-PREDICTION is **P**-Complete. This result is obtained following essentially the same gadgets used for the non-restricted case, but carefully constructing them using only two directions. More precisely, the construction of Machta and Greenlaw consists in a representation of an instance of CVP as a sequence of particle throws, which final positions represent the input Boolean circuit with its gates evaluated on the given input. A gate evaluated *true* is represented by a path of particles, while the *false* signals are represented by the lack of such path. Since the construction of the circuit must be done in logarithmic space, the sequence of particles must be defined without knowing the actual output of the gates. Therefore, the trajectory of the particles considers that, if they are do not stick on a given position, they escape through the top edge of the grid. Since this escape movement is not possible in the 2-DLA (nor 3-DLA) model (because particles can not move upwards), we modify the circuit construction to build the gates in a specific way, in order to give the particles enough space to escape through the rightmost edge or deposit at the bottom of the grid without disrupting the ongoing evaluation of the circuit.

The fact that 2-DLA-PREDICTION is **P**-Complete directly implies that 3-DLA-PREDICTION is also **P**-Complete, settling the prediction problem for these two biased versions of the model.

We then study the 1-DLA model. Despite of what one might guess, the dynamics the DLA model restricted to one direction are far from trivial (see Section 2.2 for examples of the patterns produced by this model). Indeed, we begin our study showing that this dynamics can simulate simple sorting algorithms like *Bead-Sort*. Then, we improve the result of Matcha and Greenlaw by showing that 1-DLA-PREDICTION is in **NL**. This is in fact an improvement, because they showed that 1-DLA-PREDICTION is in **NC**<sup>2</sup> [14], and **NL** is a sub-class of **NC**<sup>2</sup> [11]. Our result holds for the Ballistic Deposition model, i.e., when the graph is not restricted to a path but is an arbitrary graph given in the input (we call that problem BD-PREDICTION). We finish our study of the prediction problem showing that the complexity of BD-PREDICTION *can not be improved*. Indeed, we show that BD-PREDICTION is **NL**-Complete.

After this, we study the DLA-REALIZATION problem. We observe that  $k$ -DLA-REALIZATION is in **NP** for all  $k \in \{1, 2, 3, 4\}$ . Moreover, the non-deterministic aspect of the **NP** algorithm solving DLA-REALIZATION only needs to obtain the order of the sequence on which the particles are placed on the grid, rather than obtaining both the order and the trajectory that each particle follows. In fact, the trajectories can be computed in polynomial time, given the order in which the particles are placed in the grid.

We then show 1-DLA-REALIZATION can be solved much more efficiently. In fact, we give a characterization of the patterns that the 1-DLA model can produce. Our

characterization is based on a planar directed acyclic graph (PDAG) that represent the possible ways in which the particles are able to stick. Each occupied cell of the grid is represented by a node of the PDAG, plus a unique sink vertex that represents the *ground*. We show that a pattern can be constructed by 1-DLA if and only if there is a directed path from every vertex to the ground. We use our characterization show that 1-DLA-REALIZATION is in **L**, using a result of Allender *et al.* [1] solving REACHABILITY in log-space, when the input graph is a single sink PDAG.

Finally, we give an efficient algorithm to solve the realization problem in the 2-DLA model, showing that 2-DLA-REALIZATION is in **P**. Our algorithm uses the fact that in the 2-DLA model, the particles are placed into the grid in a very specific way. More precisely, the realizable patterns are constructed following a diagonal that grows from the bottom-right part of the pattern to the top-left part. We use this fact to efficiently compute the order in which the particles are thrown, obtaining a polynomial-time algorithm.

**1.2. Related work.** For dynamical properties of the restricted versions of DLA, including Ballistic Deposition, we refer the reader to [4, 16, 18, 23].

Some problems of similar characteristics have been studied in this context, such as the Ising Model, Eden Growth, Internal DLA and Mandelbrot Percolation, to name a few [15, 19]. On the other hand, the problem of Sandpile Prediction is an example where increasing the degrees of freedom, increases the computational complexity of the prediction problem. In particular, when the dimension is greater than 3, the prediction problem is **P**-Complete; but when the dimension is 1, the problem is in **NC** [20].

Another example of a complexity dichotomy that depends on the topology of the system is the Bootstrap Percolation model [8]. In this model, a set of cells in a  $d$ -dimensional grid are initially infected, in consecutive rounds, healthy sites that have more than the half of their neighbors infected become infected. In this model prediction problem can be defined, consisting in determining if a given site becomes infected at some point of the evolution of the system. In [10] it is shown that this prediction problem is **P**-Complete in three or more dimensions, while in two dimensions it is in **NC**. Other problems related to Bootstrap percolation involve the maximum time that the dynamics takes before converging to a fixed point [6].

**1.3. Structure of the article.** The first section formally introduces the different computational complexity classes, along side problems of known complexity used throughout the article. Next, the dynamics for the general case of DLA are presented, in addition to the formal definition of the two associated prediction problems that are discussed: Prediction and Realization. The third section focuses on the proof that DLA restricted to 2 or 3 directions is **P**-Complete and with the presentation of the non-deterministic log-space algorithm for the generalized version of the one direction DLA problem, Ballistic Deposition. The last section talks about the results concerning the Realization problem, where the one-directional case is shown to be solvable in **L**, and the two-directional case has a polynomial algorithm characterizing figures obtained from the dynamics.

## 2. Preliminaries.

**2.1. Complexity Classes and Circuit Value Problem.** In this subsection we will define the main background concepts in computational complexity required in this article. For a more complete and formal presentation we refer to the books of Arora and Barak [2] and Greenlaw et al. [11]. We assume that the reader is familiar

with the basics concepts dealing with computational complexity. As we mentioned in the introduction, in this paper we will only consider complexity classes into which we classify the prediction problems.  $\mathbf{P}$  is the class of problems solvable in a Turing machine that runs in polynomial time in the size of the input. More formally, if  $n$  is the size of the input, then a problem is polynomial time solvable if it can be solved in time  $n^{\mathcal{O}(1)}$  in a deterministic Turing machine.

A logarithmic-space Turing machine consists in a Turing machine with three tapes: a read-only *input tape*, a write-only *output-tape* and a read-write *work-tape*. The Turing machine is allowed to move as much as it likes on the input tape, but can only use  $\mathcal{O}(\log n)$  cells of the work-tape (where  $n$  is the size of the input). Moreover, once the machine writes something in the output-tape, it moves to the next cell and can not return.  $\mathbf{L}$  is the class of problems solvable in a logarithmic-space Turing machine.

A non-deterministic Turing machine is a Turing machine whose transition function does not necessarily output a single state but one over a set of possible states. A computation of the non-deterministic Turing machine considers all possible outcomes of the transition function. The machine is required to stop in every possible computation thread, and we say that the machine *accepts* if at least one thread finishes on an accepting state. A non-deterministic Turing machine is said to run in *polynomial-time* if every computation thread stops in a number of steps that is polynomial in the size of the input.  $\mathbf{NP}$  is the class of problems solvable in polynomial time in a non-deterministic Turing machine. A non-deterministic Turing machine is said to run in *logarithmic-space* if every thread of the machine uses only logarithmic space in the work-tape.  $\mathbf{NL}$  is the class solvable in logarithmic space in a non-deterministic Turing machine.

A problem  $\mathcal{L}$  is  $\mathbf{P}$ -Complete if it belongs to  $\mathbf{P}$  and any other problem in  $\mathbf{P}$  can be reduced to  $\mathcal{L}$  via a logarithmic-space (many-to-one or Turing) reduction. A  $\mathbf{P}$ -Complete problem belongs to  $\mathbf{NL}$  implies that  $\mathbf{P} = \mathbf{NL}$ .

One well-known  $\mathbf{P}$ -Complete problem is the NOR-CIRCUIT-VALUE-PROBLEM. A *NOR Boolean Circuit* is a directed acyclic graph  $C$ , where each vertex of  $C$  has two incoming and two outgoing edges, except for some vertices that have no incoming edges (called *inputs* of  $C$ ) and others that have no outgoing edges (called *outputs* of  $C$ ). We consider that  $C$  is *ordered by layers* meaning that for each non-input vertex of  $C$ , the two incoming neighbors of  $v$  are at the same distance from an input. In other words, the input gates are in the first layer, the outgoing neighbors of the input gates are in the second layer, the third layer are outgoing neighbors of the vertices in the second layer, and so on.

Each vertex of  $C$  has a Boolean value (*true* or *false*). A truth-assignment of the inputs of  $C$ , called  $I$ , is an assignment of values of the input gates of  $C$ . The value of a non-input gate  $v$  is the NOR function (the negation of the conjunction) of the value of the two incoming neighbors of  $v$ . A truth-assignment  $I$  of  $C$  defines a dynamic over  $C$ . First the vertices of the second layer compute their value according to the values of the input gates given in  $I$ . Then the vertices of the third layer compute their values according to the values of the second layer, and so on until we compute the value of all the vertices of the circuit. We call  $C(I)$  the truth values of the output vertices of  $C$  when the input gates are assigned  $I$ .

The NOR-CIRCUIT-VALUE-PROBLEM is defined as follows.

**NOR-CIRCUIT-VALUE-PROBLEM**

**Input:** A NOR Boolean Circuit  $C$  of size  $n$ , a truth-assignment  $I$  of  $C$  and  $g$  an output gate of  $C$ .

**Question:** Is  $g$  true in  $C(I)$ ?

In [11] it is shown that this problem is **P**-Complete.

PROPOSITION 2.1 ([11]). *NOR-Circuit-Value-Problem is **P**-Complete.*

A problem  $\mathcal{L}$  is **NL**-Complete if  $\mathcal{L}$  belongs to **NL** and any other problem in **NL** can be reduced to  $\mathcal{L}$  via a (many-to-one or Turing) reduction computable in logarithmic space. A **NL**-Complete problem belongs to **L** implies that **NL** = **L**.

One **NL** problem is REACHABILITY [2]. An instance of REACHABILITY is a directed graph  $G$  and two vertices  $s$  and  $t$ . The instance is accepted if there is a directed path from  $s$  to  $t$  in  $G$ . REACHABILITY is **NL**-Complete because the computation of a non-deterministic log-space Turing machine (which is the set of possible states of the machine plus contents of the working tape) can be represented by a directed graph of polynomial size, and the difficulty of finding a directed path in that graph is the difficulty of finding a sequence of transitions from the initial state to an accepting state.

For our reductions we will need specific variant of REACHABILITY, that we call LAYERED EXACT REACHABILITY (LDE-REACHABILITY). In this problem, the input graph  $G$  is a directed acyclic graph (DAG), which is *layered*, meaning that vertices of a layer only receive inputs of a previous layer and only output to a next layer (but vertices with in-degree zero are not necessarily in the first layer). Also, besides  $G$  and  $s$  and  $t$ , the input considers a positive integer  $k \leq |G|$ , where  $|G|$  is the number of vertices of the input graph. The question is whether there exists a path of length exactly  $k$  connecting vertices  $s$  and  $t$ . We show that this restricted version is also **NL**-Complete.

PROPOSITION 2.2. LDE-REACHABILITY is **NL**-Complete.

*Proof.* Let us first consider the problem EXACT-REACHABILITY. This problem receives as input a directed graph  $G$ , two vertices  $s$  and  $t$  and a positive integer  $k \leq |G|$ , and the question is whether there exists a directed path of length exactly  $k$  connecting vertices  $s$  and  $t$ . Is easy to see that EXACT-REACHABILITY is **NL**-Complete. Indeed, it belongs to **NL** because an algorithm can simply nondeterministically choose the right vertices to follow in a directed path of length exactly  $k$  from  $s$  to  $t$ . The verification of such path can be performed using  $\mathcal{O}(\log n)$  simply verifying the adjacency of the vertices in the sequence, and keeping a counter of the length of the path, that uses  $\mathcal{O}(\log n)$  space because  $k \leq |G|$ . Observe also that EXACT-REACHABILITY is **NL**-Complete because, if we have an algorithm  $\mathcal{A}$  solving EXACT-REACHABILITY, we can solve REACHABILITY running  $\mathcal{A}$  for  $k \in \{0, \dots, |G|\}$ .

Observe now that LDE-REACHABILITY is in **NL** for the same reasons than EXACT-REACHABILITY. We now show that, LDE-REACHABILITY is **NL**-Complete reducing EXACT-REACHABILITY to it. Let  $(G, s, t, k)$  be an instance of EXACT-REACHABILITY. Consider the instance  $(G', s', t', k)$  in LDE-REACHABILITY defined as follows. The set of vertices of  $G'$  is a set of  $k$  copies of  $V(G)$ , the the set of vertices of  $G$ . We enumerate the copies from 1 to  $k$ , and call them  $V_1, \dots, V_k$ . Then the set of vertices of  $G'$  is  $V(G') = V_1 \cup \dots \cup V_k$ . If  $v$  is a vertex of  $G$ , we call  $v_i$  the copy of  $v$  that belongs to  $V_i$ . There are no edges in  $G'$  between vertices in the same copy of  $V$ . Moreover, if  $u, v$  are two adjacent vertices in  $G$ , we add, for each  $i \in \{1, \dots, k-1\}$ , a



directed edge from the  $i$ -th copy of  $u$  to the  $i + 1$  copy  $v$  in  $G'$ , formally:

$$(u, v) \in E(G) \iff (u_i, v_{i+1}) \in E(G'), \forall i \in \{1, \dots, k\}.$$

Finally,  $s' = s_1$  and  $t' = t_k$ . By construction we obtain that  $G'$  is layered, and moreover  $(G, s, t, k)$  is a *yes*-instance of EXACT-REACHABILITY if and only if  $(G', s', t', k)$  is a *yes*-instance of LDE-REACHABILITY.

Finally, we remark that we can build the instance  $(G', s', t', k)$  in log-space from  $(G, s, t, k)$ . Indeed, the algorithm has to simply make a counter  $j$  from 1 to  $k$ , and sequentially connect the vertices of the  $j$ -th copy of  $V(G)$  with the vertices of the  $j + 1$  copy of  $V(G)$ . We deduce that LDE-REACHABILITY is **NL**-Complete.  $\square$

**2.2. The DLA Model and its Restricted Counterpart.** The dynamics for the computational of DLA is the following: We begin with a sequence of particles which will under go a random walk starting from a position at the top edge of a  $N \times N$  lattice. The sequence specifies the order in which the particles are released. Each particle moves until it neighbors an occupied site at which point it sticks to its position, growing the cluster. We begin with an occupied bottom edge of the lattice. If the particles does not stick to the cluster and leaves the lattice (exiting through the top or lateral edges), it is discarded. A new particle begins its random walk as soon as the previous particle sticks to the cluster or is discarded. This process goes on until we run out of particles in our sequence.

To study this model from a computational perspective, it is convenient to consider a *deterministic* version, where the sequence of sites visited by each released particle is predefined. The prediction problem presented by Machta and Greenlaw [15] for a  $d$ -dimensional DLA is:

**DLA-PREDICTION**

**Input:** Three positive integers:  $N, M, L$ , a site  $p$  in the two-dimensional lattice of size  $N^2$ , a list of random bits specifying  $M$  particle trajectories of length  $L$  defined by a site on the top edge of the lattice together with a list of directions of motion.

**Question:** Is site  $p$  occupied after the particles have been thrown into the lattice?

For this prediction problem, it is shown in [15] that DLA-PREDICTION is **P**-Complete. The proof consists of reducing a **P**-Complete variant of the Circuit Value Problem to the prediction problem. Their construction relies heavily on the fact that the particles can move in four directions (Up, Down, Left or Right).

The question we would like to answer is: what happens to the computational complexity of the prediction problem as we restrict the number of directions the particles are allowed to move along. Instead of the four permitted directions, we restrict the particle to move in three (left, right and downwards), two (right and downwards) and one (only downwards) directions.

We call the different directions by  $d_1 = \text{Down}$ ,  $d_2 = \text{Right}$ ,  $d_3 = \text{Left}$  and  $d_4 = \text{Up}$ . From this, we define the following class of prediction problems for  $k \in \{1, 2, 3, 4\}$ :

***k*-DLA-PREDICTION**

**Input:** Three positive integers:  $N$ ,  $M$ ,  $L$ , a site  $p$  in the  $N \times N$  lattice, a list of random bits specifying  $M$  particle trajectories of length  $L$  defined by a site on the top edge of the lattice together with a list of directions of motion, where the allowed directions of motions are  $\{d_1, \dots, d_k\}$ .

**Question:** Is site  $p$  occupied after the particles have been thrown into the lattice?

Where DLA-PREDICTION is the same as 4-DLA-PREDICTION.

In addition, we ask for the computational complexity of determining whether a given pattern or figure is obtainable through the different biased dynamics. To do this, we codify a pattern on the two-dimensional grid as a 0-1 matrix, where 0 represents an unoccupied site, and 1 represents an occupied one (an example of this can be found in Section 4.2). We define the computational problem as follows:

***k*-DLA-REALIZATION**

**Input:** A 0-1 matrix  $M$  codifying a pattern on the two-dimensional grid.

**Question:** Does there exist a sequence of particle throws that can move only on the allowed directions of motions,  $\{d_1, \dots, d_k\}$ , whose end figure is represented by  $M$ ?

Intuitively, this problem is concerned with understanding the complexity of the figures that can be obtained through the different versions of the DLA dynamics, by looking at the computational resources that are required to understand their structure.

To our knowledge, this problem has not been studied from this angle before.

### 3. DLA-Prediction.

**3.1. Two and three directions.** In this section we show that the 2-DLA-PREDICTION problem is **P**-Complete. This result directly implies that the 3-DLA-PREDICTION problem is also **P**-Complete.

**THEOREM 3.1.** 2-DLA-PREDICTION is **P**-Complete.

*Proof.* We assume without loss of generality that the two directions in which the particles move are Down and Right. The proof consists of creating gadgets to simulate an instance of the planar NOR CVP problem. To make this reduction, we must simulate wires, which transmit the circuits truth value amongst the gates, NOR gates and single input OR gates. For this purpose, we modify the gadgets used in [15] for the 4 directional case.

Firstly, to transmit the truth values we generate wires. We create these by systematically stacking particles. Each particle has a pre-assigned position in the wire. When each particle is released, it heads down to its target position. If the position below it is occupied (signaling that the wire is transmitting the value *True*) the particle sticks further transmitting the value. On the other hand, if the wire is transmitting the value *False*, the particle will not stick to the assigned position.

If this happens, the particle is then instructed to move two positions to the right, and the to move indefinitely downwards to be discarded by means of getting stuck to the bottom, effectively transmitting the wire's value. We must do this because we can't make use of the upwards direction to discard the particles (through the top of the lattice). This means, that when we finally put the circuit together, each wire must be isolated by a distance of at least four columns from the next, to permit discarding

particles. This separation will later guarantee that the discarded particles do not interfere with the evaluation of the circuit: by transmitting a *False* value of length  $n$ , by discarding on two columns, that stack of discarded particles will only reach a height of  $n/2$ .

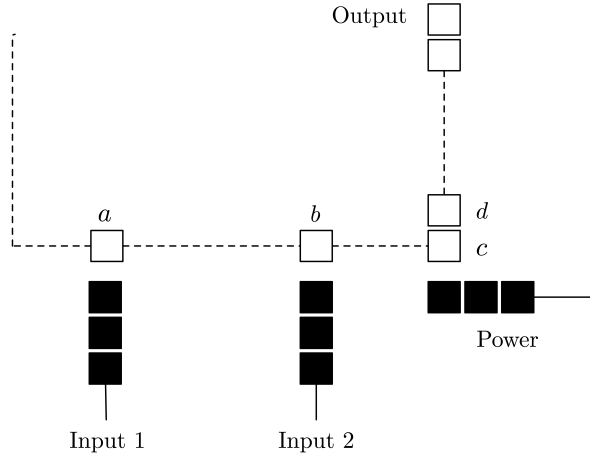

FIG. 3. Gadget for the simulation of a NOR gate. Both inputs are grown until they reach the sites directly below sites  $a$  and  $b$  respectively. Two successive particles then follow the path  $a \rightarrow b \rightarrow c$  following the dotted line, stopping according to the inputs. The output is then grown from site  $c$ .

Next, we must simulate the NOR gate. It receives two inputs from the preceding layer. Each of these inputs are grown as mentioned before to the sites  $a$  and  $b$ , as shown in Fig. 3. It is important to remember that both input cables are separated by a distance of four columns, to allow for the discarding of particles. In addition, we grow a power cable to function the gate (it is a wire that always carries the *True* value). Same as before, site  $c$  must be at least four columns away from site  $b$ . Once everything is in place, the gate is evaluated as follows: A particle makes the journey  $a \rightarrow b \rightarrow c$ . If input 1 is *True*, then the particle will stick at  $a$ . The same goes for input 2 and site  $b$ . If both inputs are *False*, the particle will then stick at site  $c$ . In any of the 3 cases, a new wire is grown starting from site  $d$ . By doing this, the NOR gate is correctly evaluated.

For the single input OR gate, we proceed in a similar fashion. The input wire is grown up to site 1. There, two particles make specific trajectories: the first visits  $a \rightarrow b$ , while the second one  $c \rightarrow d$ . After these particles have completed their trajectories, the power cable is grown starting at the site left of  $d$ . If the input is affirmative, then the first of the walks will stop at  $a$ , and the second at  $c$ . The wire is grown from 1, and the power cable as mentioned before, crossing the two of them. If the input is negative, then the walks will end at  $b$  and  $d$  respectively. As before, the wire and the power cable are grown, crossing them. We re-state the importance of the distance between the cables germinated at 1,  $c$  and  $a$ , for the discarding of particles.

The planar NOR CVP instance is constructed from Right to Left and from the bottom up in the topological order provided, as it is shown in Figure 5.

There are two important commentaries we must make to ensure the functioning of the evaluation. First off, due to the fact that the power cable is akin to a wire constantly transmitting *True*, the direction in which it is grown is not important, the

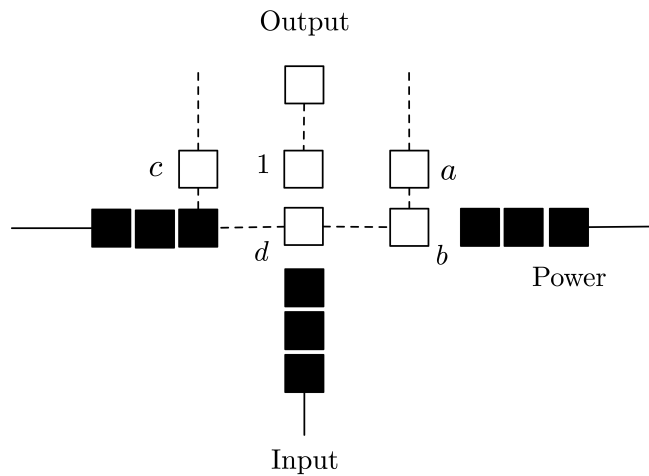

FIG. 4. Gadget for the simulation of a OR gate. The input is grown up to site 1. A first particle then makes the trajectory  $a \rightarrow b$ , stopping according to the truth value of the gadget's input. Then, a second particle makes the trajectory  $c \rightarrow d$ , also stopping according to the truth value of the input. To finalize, the power wire is grown starting from site  $d$ , and the output is grown from site 1. This 1 input OR gate, in fact, simulates the crossing of the input wire with the power wire.

particles will always stick at the assigned location.

If the circuit is constructed with the before mentioned space between wires, the residual particles being deposited at the bottom of the lattice will not interfere with the evaluation of the circuit.

Lastly, if the circuit is  $k$  layers deep and consists of  $I$  inputs, the dimensions of our lattice must be at least  $10k \times 5I$  (the height of  $10k$  amounts for the height of the gates, and the wires from one layer to the next).

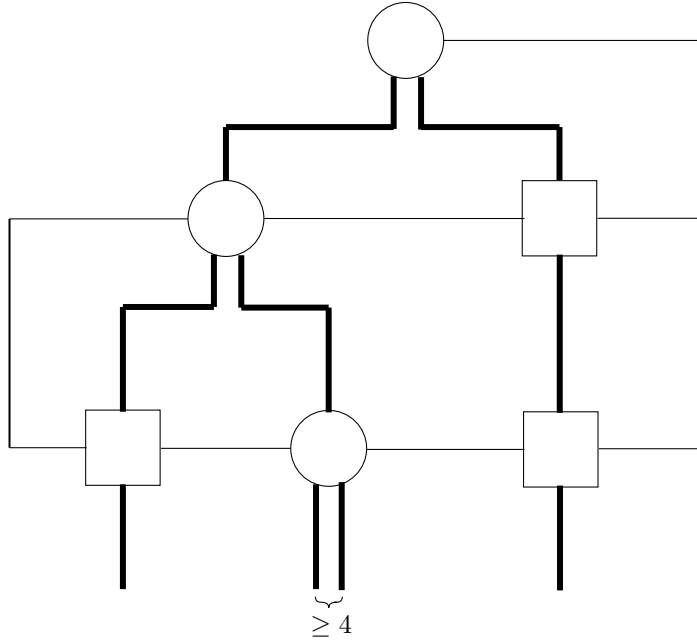

FIG. 5. A circuit consists of single-input OR gates, shown as squares, and NOR gates, shown as circles. Truth-value carrying wires are shown in bold, where as the power cable is thinner. For this particular instance  $k = 3$ , and  $I = 4$ .

COROLLARY 3.2. 3-DLA-PREDICTION is **P**-Complete.

*Proof.* The particles in this case are allowed to move downwards, to the left and to the right. Thus, the proof of the **P**-Completeness is straightforward. Because we already showed that given two directions, the prediction problem is **P**-Complete we can just ignore one of the lateral directions, and execute the same constructions shown in the previous theorem.  $\square$

Because the before mentioned proofs rely only on the use of two dimensions, both results are directly extended to the dynamics in an arbitrary number of dimensions:

COROLLARY 3.3. 2-DLA-PREDICTION and 3-DLA-PREDICTION in  $\mathbb{Z}^d$ , are **P**-Complete.

**3.2. One Direction.** By restricting the directions in which we allow particles to move, our problem statement simplifies. Because particles are only permitted to fall, there is no need to specify the whole trajectory of the particles, just the column of the  $N \times N$  lattice we are throwing it down. Therefore, as a first method for representing the given behavior, we describe our input as sequence of particle drops:  $S = a_1 a_2 \dots a_{n-1} a_n$  where each  $a_i \in [N]$  represents the column where the  $i$ -th particle is dropped, and  $[n]$  denotes the set  $\{1, \dots, n\}$  for each integer  $n$ .

This one-dimensional case is actually a particular instance of a more general model called *Ballistic Deposition* (BD), first introduced by Void and Sutherland to model colloidal aggregation [24, 25]. The growth model takes the substrate to be an undirected graph  $G = (V, E)$ , where each vertex defines a column through a "height" function  $h : V \rightarrow \mathbb{N}$ , which represents the highest particle at the vertex. In addition, a sequence of particle throws is given by a list of vertices  $S = v_1 v_2 \dots v_{n-1} v_n$ , where

a particle gets stuck at a height determined by its vertex, and all vertices neighboring it. It is easy to see that the one-dimensional DLA problem on a  $N \times N$  square lattice is the special case when  $G = ([N], \{(i, i + 1) : i \in [N]\})$ .

Our prediction problem is as follows:

**BD PREDICTION**

**Input:** A graph  $G = (V, E)$ , a sequence  $S$  of particle throws and a site  $t = (h, v) \in \mathbb{N} \times V$ , where  $v$  is a vertex and  $h$  a specified height for it.

**Question:** Is site  $t$  occupied after the particles have been thrown into the graph?

This problem was shown to be in  $\mathbf{NC}^2$  by Matcha and Greenlaw using a Minimum-Weight Path parallel algorithm [14]. We improve this result to show that the problem is in fact  $\mathbf{NL}$ -Complete.

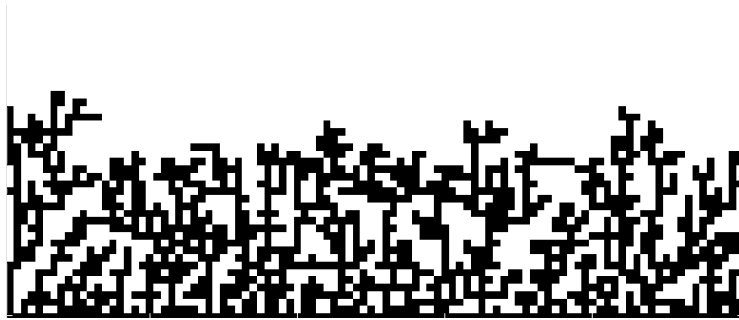

FIG. 6. A realization of the one-directional dynamics of the system on a one-dimensional strip.

**3.2.1. Computational Capabilities of the Dynamics.** As a first look at the computational capabilities of the model, and sticking to the 1-DLA version of Ballistic Deposition, we show that we can sort natural numbers simulating The Bead-Sort model described by Arulanandham et al. [3]. This model consists of sorting natural numbers through gravity: numbers are represented by beads on rods, like an abacus, and are let loose to be subjected to gravity. As shown in [3], this process effectively sorts any given set of natural numbers. It is reasonable to think that because of the dynamics and constraints of our model (one direction of movement for the particles), the same sorting method can be applied within our model, which is in fact the case.

LEMMA 3.4. *Bead-Sort can be simulated.*

*Proof.* Let  $A$  be a set of  $n$  positive natural numbers, with  $m$  being the biggest number in the set. We create a  $2m \times 2m$  lattice where we will be throwing the particles. Here the  $k$ -th rod from the Bead-Sort model is represented by row  $2k - 2$  on our lattice. Now, for each number  $a \in A$  we create the sequence  $S_a = 2\ 4\ 6\ \dots\ 2a$ . The total sequence of launches  $S$  is created by concatenating all  $S_a$  for  $a \in A$ . We note that because of the commutativity of our model, the order in which the concatenation is made is not relevant. Thus, throwing sequence  $S$  into our lattice, effectively simulates the Bead-Sort algorithm.  $\square$

Let us give an example using the set  $A = \{7, 4, 1, 10\}$ . Following the proof, we must simulate 1-DLA on a  $20 \times 20$  square lattice, and create the sequences  $S_1 = 2$ ,  $S_4 = 2\ 4\ 6\ 8$ ,  $S_7 = 2\ 4\ 6\ 8\ 10\ 12\ 14$ , and  $S_{10} = 2\ 4\ 6\ 8\ 10\ 12\ 14\ 16\ 18\ 20$ . By releasing the sequence  $S = S_1 \circ S_4 \circ S_7 \circ S_{10}$  into the lattice we obtain Figure 7, which is ordered

increasingly, effectively sorting set  $A$ .

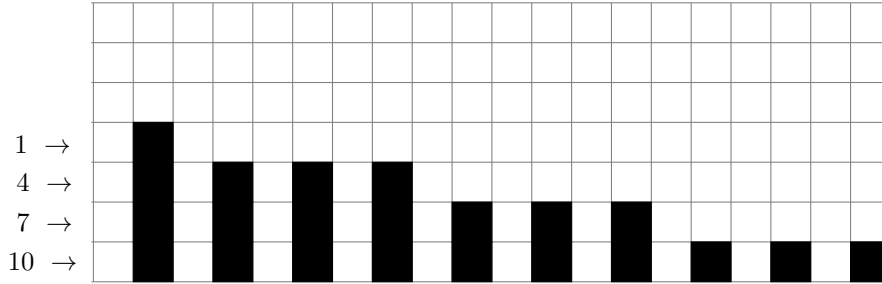

FIG. 7. Figure obtained by throwing sequence  $S$  into the lattice. Set  $A$  is order decreasingly from the first row onwards.

A key aspect of the present model is the commutativity of throws through non-consecutive vertices of the graph. Given a figure,  $\mathcal{F}$ , we define  $\varphi_v(\mathcal{F})$  as the figure that results after throwing a particle through vertex  $v$ . We notice, that because of the dynamics of our model, the point at which a given particle freezes is determined uniquely by the state of the vertex it has been dropped in, and the state of its neighbors. Therefore, given  $v \in V$ :

$$(\varphi_v \circ \varphi_u)(\mathcal{F}) = (\varphi_u \circ \varphi_v)(\mathcal{F}) \quad \forall u \notin N_G(v).$$

We will later use this fact to create a better algorithm for the prediction problem.

**3.2.2. Non-deterministic Log-space Algorithm.** There is a critical aspect of the dynamics that is exploitable to create an algorithm: if two particles are thrown on non-adjacent vertices, their relative order in the input sequence is reversible. By using this, our aim is to shuffle the sequence into one with the same final configuration, but that is ordered in a way that allows us to quickly solve the prediction problem. Specifically, if we are able to reorganize the input sequence into one that releases particles according to the height they will ultimately end at, the remaining step to solve the problem is checking amongst the particles for the target height, if the target vertex appears.

Let  $S$  be the input sequence of BD PREDICTION. Formally, a sequence  $S = s_1 \dots s_n$  is composed of the vertices onto which each particle will be released. From  $S$ , we are able to define a sequence of particles  $p_1, \dots, p_n$  that represents the same realization as the input sequence. We define a *particle*  $p$ , as a triple  $(V(p), \text{num}(p), \text{pos}(p)) \in V \times [n] \times [n]$ , where first coordinate,  $V(p)$ , denotes the vertex onto which the particle is thrown, the second coordinate,  $\text{num}(p)$ , is an integer representing the number of particles thrown onto vertex  $V(p)$  before  $p$ , and the third,  $\text{pos}(p)$  is the position of the particle within sequence  $S$ . The particle description of  $S$  is easily obtained by setting  $V(p_i) = s_i$ ,  $\text{num}(p_i) = |\{j \in [n] : s_j = s_i \wedge j \leq i\}|$ , and  $\text{pos}(p_i) = i$ .

Let us call  $\mathbb{P} = \{p_1, \dots, p_n\}$  the *set of particles* of  $S$ .

To further breakdown the problem, we define the following sets:

$$A(p) := \{q \in \mathbb{P} : \text{pos}(q) < \text{pos}(p)\},$$

$$N(p) := \{q \in A(p) : V(q) \in N_G(V(p)) \cup \{V(p)\}\},$$

$$N^=(p) := \{q \in N(p) : V(q) = V(p)\}.$$

In words,  $A(p)$  denotes the set of particles thrown before  $p$ ,  $N(p)$  denotes the set of particles that are thrown before  $p$  on vertices adjacent to  $p$ , and  $N^=(p)$  denotes the subset of particles in  $N(p)$  in the same vertex as  $p$ .

For a particle  $p \in \mathbb{P}$ , the *row of  $p$* , denoted  $\text{row}(p)$  is the height at which the particle ends up at after the dynamics have taken place. In other words,  $\text{row}(p) = h(V(p))$  after releasing the sequence  $S' = s_1 \dots s_{\text{pos}(p)}$ . Relative to this definition, we call  $N^r$  the set of particles thrown before  $p$  in vertices adjacent than  $p$  that stick at row  $r$ , formally:

$$N^r(p) = \{q \in N(p) : \text{row}(q) = r\}.$$

We translate the dynamics into this new notation in the following lemma:

LEMMA 3.5. *Let  $p \in \mathbb{P}$  be a particle and let*

$$r = \begin{cases} 1 & \text{if } N(p) = \emptyset, \\ \max\{\text{row}(q) : q \in N(p)\} & \text{if } N(p) \neq \emptyset. \end{cases}$$

Then,

$$\text{row}(p) = \begin{cases} r + 1 & \text{if } N^r(p) \cap N^=(p) \neq \emptyset, \\ r & \text{if } N^r(p) \cap N^=(p) = \emptyset. \end{cases}$$

Explicitly, if the particle is the first of its neighbors to be thrown ( $N(p) = \emptyset$ ), its row is 1. If not; if its neighbors are higher than the vertex it is thrown in ( $N^r(p) \cap N^=(p) = \emptyset$ ), the particle sticks at their height. Lastly, if the vertex that the particle is thrown in is higher than its neighbors ( $N^r(p) \cap N^=(p) \neq \emptyset$ ), the particle sticks one row higher than the last particle in the vertex.

*Proof.* Let  $p$  be a particle such that  $N(p) = \emptyset$ . This implies that  $p$  is the first particle thrown through vertex  $V(p)$  and its adjacent vertices. From the commutativity property, we deduce that  $\text{row}(p) = 1$ . On the other hand,  $r = 1$  and  $N^r(p) \cap N^=(p) = \emptyset$ , so  $\text{row}(p) = r$ .

Suppose now that  $N(p) \neq \emptyset$ , and let  $q$  be a particle in  $N^r(p)$ . Observe that  $\text{row}(q) = r$ , and  $\text{row}(u) \leq r$  for all  $u \in N(p)$ . Then, when  $p$  is thrown, the first particle that it encounters is  $q$ . Suppose that we can pick  $q$  such that  $V(q) = V(p)$  (i.e.  $N^r(p) \cap N^=(p) \neq \emptyset$ ). Since  $V(q) = V(p)$ , we deduce that  $\text{row}(p) = \text{row}(q) + 1 = r + 1$ . On the other hand, if  $N^r(p) \cap N^=(p) = \emptyset$  then the coordinate  $(V(p), r)$  is empty when  $p$  is thrown, but some of  $(u, r)$ , for  $u \in N_G(V(p))$ , are occupied. We deduce that  $\text{row}(p) = \text{row}(q) = r$ .  $\square$

We create a weighted graph that codifies the dependence of the particles between each other. Let  $G_S$  be a weighted directed graph defined from  $S$  as follows: the vertex set of  $G_S$  is the set of particles  $\mathbb{P}$  plus one more vertex  $g$ , called the *ground* vertex. The edges of  $G_S$  have weights, given by the weight function  $W$  defined as:

$$W(p, q) = \begin{cases} 1 & \text{if } (p = g) \wedge (N(q) = \emptyset), \\ 1 & \text{if } p \in N^=(q), \\ 0 & \text{if } p \in N(q) \setminus N^=(q), \\ -\infty & \text{otherwise.} \end{cases}$$

Observe that if we keep only the edges with weight different than  $-\infty$ , the obtained graph has no directed cycle, i.e. it is a directed acyclic graph. Moreover, the set of incoming edges of vertex  $p$  is  $N(p)$  if  $N(p) \neq \emptyset$ , and  $\{g\}$  otherwise. For  $p \in \mathbb{P}$ , we call  $\tilde{\omega}_{gp}$  the longest (maximum weight) path from  $g$  to  $p$  in  $G_S$ .



**THEOREM 3.6.** *For every  $p \in \mathbb{P}$ ,  $\text{row}(p) = \tilde{\omega}_{gp}$ .*

*Proof.* We reason by induction on  $\text{pos}(p)$ . Let  $p \in \mathbb{P}$  be the particle such that  $\text{pos}(p) = 1$ . Observe that  $p$  has only one incoming edge, which comes from  $g$ , and  $W(g, p) = 1$ . Then  $\tilde{\omega}_{gp} = 1 = \text{row}(p)$ .

Suppose now that  $\text{row}(p) = \tilde{\omega}_{gp}$  for every particle  $q$  such that  $\text{pos}(q) \leq k$  and let  $p$  be a the particle  $\text{pos}(p) = k + 1$ . If  $N(p) = \emptyset$ , then, like in the base case, the only incoming edge of  $p$  is  $g$ , and from Lemma 3.5 we deduce that  $\text{row}(p) = 1 = \tilde{\omega}_{gp}$ .

Suppose now that  $N(p)$  is different than  $\emptyset$ . Let  $q$  be the a particle in  $N(p)$  such that  $\text{row}(q)$  is maximum, i.e.  $\text{row}(q) = \max\{\text{row}(u) : u \in N(p)\}$ . Observe that, from induction hypothesis and the choice of  $q$ ,  $\tilde{\omega}_{gq} \geq \tilde{\omega}_{gu}$  for all  $u \in N(p) \setminus \{q\}$ . Moreover,  $\tilde{\omega}_{gp} \leq \tilde{\omega}_{gq} + 1$ .

Suppose that  $q$  can be chosen to be such that  $V(q) = V(p)$ . Lemma 3.5 then implies that  $\text{row}(p) = \text{row}(q) + 1$ . On the other hand, the path from  $g$  to  $p$  that passes through  $q$  is of weight  $\tilde{\omega}_{gq} + 1$ . We deduce that  $\tilde{\omega}_{gp} = \tilde{\omega}_{gq} + 1 = \text{row}(q) + 1 = \text{row}(p)$ .

Suppose now that for all  $u \in N^=(p)$ ,  $\text{row}(u)$  is strictly smaller than  $\text{row}(q)$ . In this case, Lemma 3.5 implies that  $\text{row}(p) = \text{row}(q)$ . On the other hand, the path from  $g$  to  $p$  that passes through  $q$  is of weight  $\tilde{\omega}_{gq}$ , which is greater or equal than  $\tilde{\omega}_{gu}$ , for all  $u \in N(p) \setminus N^=(p)$  and strictly greater than  $\tilde{\omega}_{gu}$ , for all  $u \in N^=(p)$ . We deduce that  $\tilde{\omega}_{gp} = \tilde{\omega}_{gq} = \text{row}(q) = \text{row}(p)$ .  $\square$

We now present a **NL** algorithm for the prediction problem.

Given a site  $(h, v)$ , we want to non-deterministically obtain a path through graph  $G_S$  that will guarantee the site will be occupied by a particle. Each step of our algorithm we will non-deterministically guess a pair consisting of the next particle, and the corresponding weight of the transition between the last particle and the new one, such that the sum of the weights is the maximum weight to the final particle.

We say a particle  $p$  is valid for an input sequence  $S$ , if  $p \in \mathbb{P}$ . The following log-space algorithm verifies if a particles is valid.

---

**Algorithm 3.1**

---

**Input:** A sequence  $S$  and a particle  $p \in V \times [n] \times [n]$

**Output:** Accept if particle  $p$  is valid.

Check if  $V(p) = s_{\text{pos}(p)}$

Sum  $\leftarrow 0$

**for**  $i \leq \text{pos}(p)$  **do**

**if**  $s_i = V(p)$  **then**

        Sum  $\leftarrow$  Sum + 1

**end**

**end**

**if** Sum = num( $p$ ) **then**

    Accept

**else**

    Reject.

**end**

---

At each step of the for loop of the algorithm, we must remember the value of Sum, the particles vertex,  $V(p)$ , and the current index of the iteration. This amounts to using  $\mathcal{O}(\log(n))$  space.

We also present a log-space algorithm to determine wether the obtained transition weight corresponds to the value of the weight function

---

**Algorithm 3.2**

---

**Input:** A sequence  $S$ , two valid particles  $p, q \in V \times [n] \times [n]$ , and  $w \in \{0, 1\}$ **Output:** Accept if  $W(p, q) = w$ .

```

if  $p = q$  then
  for  $i < \text{pos}(q)$  do
    | Check that  $s_i$  is not adjacent to  $V(q)$ 
  end
  Accept
end
if  $w = 1$  then
  | Check that  $\text{pos}(p) < \text{pos}(q)$  and  $V(p) = V(q)$ 
  | Accept
end
if  $w = 0$  then
  | Check that  $\text{pos}(p) < \text{pos}(q)$ 
  | Check that  $V(p) \neq V(q)$ 
  | Check that  $V(p)$  is adjacent to  $V(q)$ 
  | Accept
end
Reject

```

---

For this algorithm, the only case in which information needs to be stored is when  $p = q$ . For this instance, each iteration of the for loop must remember the index of the iteration, and the vertex  $V(q)$ . Therefore, this algorithm uses  $\mathcal{O}(\log(n))$  space.

Combining these two subroutines, we are now ready to present the main algorithm.

---

**Algorithm 3.3 NL algorithm for BD PREDICTION**

---

**Input:** A graph  $G = (V, E)$ , a sequence  $S$  and a site  $t = (x, v) \in \mathbb{N} \times V$ **Output:** Accept if a particle occupies site  $t$  and reject otherwise.Non-deterministically obtain  $m$ , the number of particles, and  $p_1$ . Write them down.Check if  $p_1$  is valid and that  $W(g, p_1) = 1$ Sum  $\leftarrow 1$ 

Write down Sum.

```

for  $j \in \{2, \dots, m\}$  do
  | Non-deterministically obtain particle  $p_j$  and the transition weight  $w_{j-1,j}$ , and
  | write them down.
  | Check if  $p_j$  is valid.
  | Check if  $W(p_{j-1}, p_j) = w_{j-1,j}$ 
  | Sum  $\leftarrow$  Sum +  $w_{j-1,j}$ 
  | Erase  $p_{j-1}$  and  $w_{j-1,j}$ 
end
if Sum =  $x$  and  $V(p_m) = v$  then
  | Accept
else
  | Reject.
end

```

---

At the  $j$ -th step of this algorithm, we must retain the following information: the sum of the weights so far, particles  $p_{j-1}$  and  $p_j$ , the current weight  $w_{j-1,j}$ . This

means that around  $4 \log(n) = \mathcal{O}(\log(n))$  space is used on the tape.

**PROPOSITION 3.7.** *BD-PREDICTION is in NL.*

*Proof.* Let us show that Algorithm 3.2.2 decides BD PREDICTION. Let  $S$  be an input sequence and  $P = (h, v)$  an input site.

If the release of  $S$  on to the underlying graph results on site  $P$  being occupied, by Theorem 3.6 we know that there exists a particle  $q \in \mathbb{P}$  such that  $h = \text{row}(q) = \tilde{\omega}_{gq}$  and  $V(q) = v$ . Let  $C = g p_1 p_2 \dots p_{m-1} p_m$  be the maximum weight path of weight  $\tilde{\omega}_{gq}$ , where  $p_m = q$ . Then, for the  $j$ -th non-deterministic choice the algorithm makes, it obtains the pair:  $p_j$  and  $W(p_{j-1}, p_j)$ .

If the algorithm accepts for  $S$  and  $P$ , we will obtain a sequence of particles such that the sum of the transition weights is exactly  $h$  and that  $V(p_m) = v$ . This means that the weight from the ground to the last particle will indeed be  $h = \tilde{\omega}_{gp_m}$ . Due to Theorem 3.6, this means that  $\text{row}(p_m) = \tilde{\omega}_{gp_m} = h$ . Therefore, particle  $p_m$  indeed occupies site  $P$ .  $\square$

**THEOREM 3.8.** *BD-PREDICTION is in NL-Complete.*

*Proof.* Due to proposition 2.2, to show that the problem is NL-Hard, we will reduce an instance of LDE-REACHABILITY to the Ballistic Deposition problem.

Let  $(G, s, t, k)$  be an instance of LDE-REACHABILITY, where  $m$  is the number of layers of  $G$ , and let  $i \in [m]$  be the index such that  $s \in V_i$ . The idea is to throw two particles for each vertex in all layers from  $i$  to  $i+k$ . This way, the height at which the particles freeze will increase with each layer. Formally, for every  $i < j \leq i+k$  and every  $u \in V_j$  we create the sequence  $S_u = uu$  (two particles are thrown in vertex  $u$ ). Concatenating these sequences, we obtain a sequence of throws on the whole layer  $S_j = \bigcirc_{u \in V_j} S_u$ . We note that due to the structure of the graph and the commutativity of the dynamics, the order in which these sequences are concatenated does not matter because no to vertices in the same layer are adjacent.

Finally, our input sequence will be the concatenation of the sequences associated to every layer from the  $i$ -th layer to the  $i+k$ -th one,  $S = S_s \circ \bigcirc_{i+k \geq j > i} S_j$ . The order in which these sequences are concatenated is important, and must be done in increasing order by their index. At any point in this process the only information retained is the vertex for which we are currently creating the sequence  $S_u$ . This only requires  $\log(n)$  space to store, making this process a log-space reduction.

By defining the site  $P = (k+1, t)$ , we create an instance of BD-PREDICTION:  $(G, S, P)$ . Let us prove that this is indeed a reduction.

If  $(G, s, t, k) \in \text{LDE-REACHABILITY}$ , then there exists a directed path  $C = v_0 \dots v_k$  in  $G$ , where  $s = v_0$  and  $t = v_k$ . Because of the layered structure of the graph, if  $s \in V_i$  then  $v_j \in V_{i+j}$ . Then, because by construction, for every vertex on  $C$  two particles will be dropped, the height of the last particle dropped in  $v_j$  will be  $j+1$ , meaning that the last particle dropped on  $v_k = t$  will have a height of  $k+1$ . This means that site  $P$  will in fact be occupied, and therefore  $(G, S, P) \in \text{BD-PREDICTION}$ .

If  $(G, S, P) \in \text{BD-PREDICTION}$ , site  $P = (k+1, t)$  is occupied after the sequence of particles,  $S$ , have been released onto  $G$ . Due to our construction, if site  $P$  is occupied, site  $(k, t)$  must also be occupied by a particle. Let  $l \in [m]$  be such that

$t \in V_l$ . Because only two particles are thrown at each vertex, for the latter site to be occupied there must exist a vertex  $v_1 \in V_{l-1}$  adjacent to  $t$  such that sites  $(k, v_1)$  and  $(k-1, v_1)$  are occupied.

Iterating this process, we obtain a sequence  $v_1 \dots v_{k-1}$  such that  $v_i$  is adjacent to  $v_{i-1}$  and sites  $(k-i+1, v_i)$  and  $(k-i, v_i)$  are occupied, for every  $i \in \{2, \dots, k-1\}$ . By virtue of the construction of  $S$ , the only possible way in which site  $(1, v_{k-1})$  is occupied is that  $s = v_{k-1}$ . This proves that  $(G, s, t, k) \in \text{LDE-REACHABILITY}$ , concluding our proof.  $\square$

**4. Shape Characterizations and Realization.** Although the figures obtained by simulating the dynamics are complex and fractal-like, not every shape is obtainable as an end product. This naturally leads to the problem of characterizing the figures which are obtainable through the dynamics, for the different restrictions of the DLA model.

A crucial observation is the fact that not all connected shapes are realizable. Figure 8 shows shapes that are not achievable for each of the restricted versions.

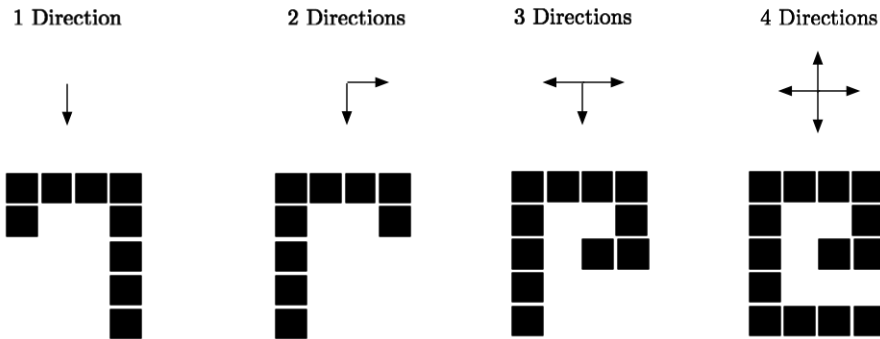

FIG. 8. Four non-constructible figures with the respective maximum number of directions where it is not constructible. The last figure is not constructible even with four directions.

Given a fixed number of allowed directions, determining whether a given figure is realizable is an **NP** problem, where the non-deterministic choices of the algorithm are the order in which the particles are released. Having the order, it is possible to compute the trajectories that each particle takes in polynomial time, by finding a path that does not neighbor the already constructed cluster, from the place at which it is released to its final destination.

We give better algorithms for the shape characterization problems for both 1-DLA and 2-DLA, showing that the former belongs to the class of log-space solvable problems, **L**, and the latter to **P**.

**4.1. One Direction.** To characterize shapes created by the one-directional dynamics, given a sequence of drops  $S$ , and its corresponding shape  $\mathcal{F}(S) \in \{0, 1\}^{m \times n}$ , we construct a planar directed acyclic graph (DAG),  $G = (V, E)$ , that takes into account the ways in which a shape can be constructed with the dynamics. We construct  $G$  in two steps.

We begin by constructing  $G_a = (V_a, E_a)$ , where:

$$\begin{aligned} V_a &= \{ij : \mathcal{F}(S)_{ij} = 1\} \cup \{g\}, \\ E_1 &= \{(ij, ij+1) : \mathcal{F}(S)_{ij} = \mathcal{F}(S)_{ij+1} = 1\}, \\ E_2 &= \{(ij, ij-1) : \mathcal{F}(S)_{ij} = \mathcal{F}(S)_{ij-1} = 1\}, \\ E_3 &= \{(ij, i+1j) : \mathcal{F}(S)_{ij} = \mathcal{F}(S)_{i+1j} = 1\}, \\ E_4 &= \{(nj, g) : \mathcal{F}(S)_{nj} = 1\}, \end{aligned}$$

and  $E_a = E_1 \cup E_2 \cup E_3 \cup E_4$ . The intuition is the following: we create a vertex for each block in the shape and one representing the ground where the initial particles stick.  $E_1$  and  $E_2$  account for the particles that stick through their sides,  $E_3$  accounts for particles falling on top of each other and finally  $E_4$  connects the first level to the ground.

For example, given the sequence  $S = 2\ 7\ 7\ 2\ 6\ 3\ 4\ 4\ 4\ 5\ 6\ 3\ 2\ 6\ 2$ , we depict the obtained shape and corresponding graph in Figure 9.

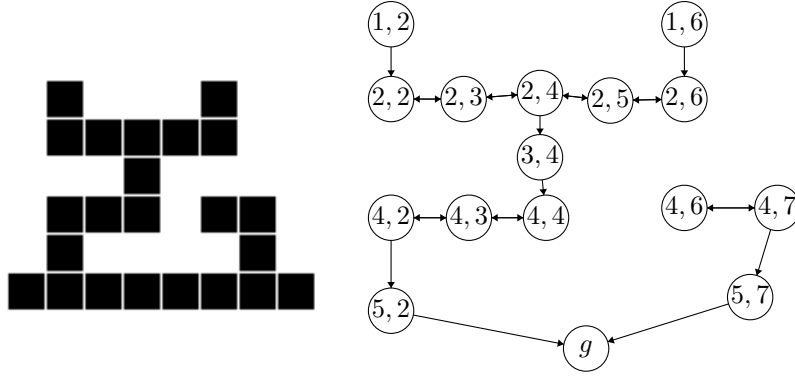

FIG. 9. Shape and graph obtained from sequence  $S = 2\ 7\ 7\ 2\ 6\ 3\ 4\ 4\ 4\ 5\ 6\ 3\ 2\ 6\ 2$ .

LEMMA 4.1. A configuration is constructible iff  $\forall ij \in V_a \setminus \{g\}$  there exists a directed path between  $ij$  and  $g$ .

*Proof.* Given a constructible configuration, by virtue of the definition, there is a sequence  $S$  of particle drops that generates the configuration. Therefore, by the dynamics of our system and the construction of the graph, for each node in our graph, there exists a directed path to the *ground*, represented by node  $g$ .

Now, let  $G = (V, E)$  be the graph corresponding to a given configuration on the grid. If we have that  $\forall ij \in V \setminus \{g\}$  there exists a directed path between  $ij$  and  $g$ , we start by reversing the direction of the arcs in our graph, and running a Breadth-first search-like algorithm starting from node  $g$ , to determine the minimum distance from  $g$  to each of the other nodes. For all nodes with distance 1 from  $g$ ,  $\{i_k j_k\}_{k=1}^n$ , we create the sequence  $S_1 = j_1 \dots j_n$ . Then for all non-visited nodes, with distance  $d$  from  $g$ ,  $\{a_k b_k\}_{k=1}^m$ , we create the sequence  $S_d = b_1 \dots b_m$ . Let us show that the sequence  $S = S_1 \circ S_2 \circ \dots \circ S_M$ , with  $M = \max\{\text{dist}(ij, p) : ij \in V \setminus \{g\}\}$  corresponds to the configuration. We do this by induction over  $|S| = n$ .

For  $n = 1$ , we have only one occupied state on our configuration, which is the only particle present in  $S$ . It is straightforward to see that  $\mathcal{F}(S)$  actually corresponds to the configuration.

Assuming the sequence is correct for  $n$ , let us see that it is also correct for  $n + 1$ . Because of the way  $S$  was constructed, the only possibility for the configuration not to be achieved is that  $S_{n+1}$  ends up higher or lower in  $\mathcal{F}(S)$  on its column that in the given configuration. Due to the dynamics, the only way for a particle to become immobile is to stick to another particle, this means that either it sticks to a particle in its own column, or to a particle in one of the neighboring ones. By the induction hypothesis,  $S \setminus S_{n+1}$  actually corresponds to the configuration of the first  $n$  particles. Therefore, if, without loss of generality,  $S_{n+1}$  ends up lower, this means that when generating the sequence  $S$  a node that was at a lesser distance from  $g$  than the particle with which it sticks, was added after all other nodes that at the same distance, which is a contradiction.  $\square$

Next, we obtain  $G$  from  $G_a$  through the following procedure:

1. For every  $v \in V_a \setminus \{g\}$ , we create two vertices  $v_1$  and  $v_2$ , connected by an arc from the former to the latter.
2. For every  $e = (v, u) \in E_1$ , we create an edge  $(v_1, u_1)$ .
3. For every  $e = (v, u) \in E_2$ , we create an edge  $(v_2, u_2)$ .
4. For every  $e = (v, u) \in E_3$ , we create an edge  $(v_2, u_1)$ .
5. For every  $e = (v, g) \in E_4$ , we create an edge  $(v_2, g)$ .

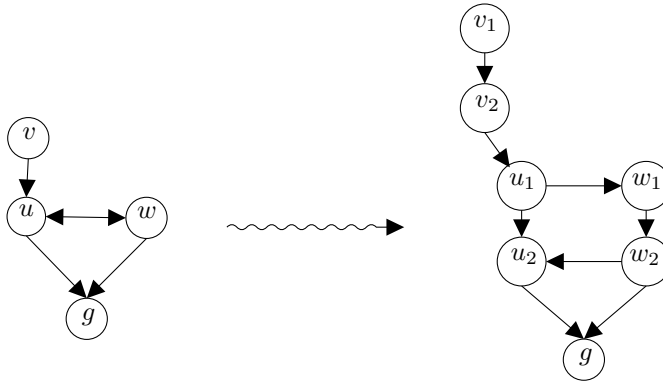

This procedure turns  $G_a$  into a planar DAG.

It is straight forward to see that there is a directed path from a vertex  $v \in V_a$  to  $g$  on graph  $G_a$  if and only if there is a path from vertex  $v_1$  to  $g$  on graph  $G$ .

Due to our construction, graph  $G$  is what is known as a Multiple Source Single Sink Planar DAG (MSPD): there are multiple vertices with in-degree zero, and one vertex with out-degree zero. Allender et al. showed that the reachability problem on MSPD is in fact log-space solvable [1].

**THEOREM 4.2** ([1], Theorem 5.7). *MSPD reachability is in  $\mathbf{L}$ .*

**PROPOSITION 4.3.** *Determining whether a given figure is a valid configuration for 1-DLA, is in  $\mathbf{L}$ .*

The proof of this proposition consists on creating a log-space reduction from our realization problem to MSPD reachability. This stems from the fact that if a problem is log-space reducible to a log-space solvable problem, it is itself log-space solvable (the proof of this fact can be found in [2]).

*Proof.* Let  $M$  be a matrix representing the configuration, using the same con-

vention as the definition shape. We can see that the directed graph is constructible from a shape in  $\mathbf{NC}^1$ . By assigning a processor for each pair of coordinates in the matrix, that is  $\mathcal{O}(n^2)$  processors, to construct the nodes and arcs of our graph. Because  $\mathbf{NC}^1 \subseteq \mathbf{L}$ , this procedure is realizable in log-space. This procedure creates the MSPD  $G$ .

For each vertex  $v \in V$ , we can solve the MSPD reachability problem for the instance  $(G, v, g)$  in log-space. Due to Lemma 4.1, this solves the one-directional realization problem.

**4.2. Two directions.** To characterize shapes generated by the two-directional dynamics, we proceed in by recursively checking if the overall figure is constructible, starting from the corner.

PROPOSITION 4.4. *Determining whether a given figure is a valid configuration for 2-DLA, is in  $\mathbf{P}$ .*

We create a sequential algorithm, that checks if a figure is constructible by starting at the last coordinate of the shape, and by ordering neighboring sites according to the Manhattan metric. We start by showing how the algorithm works on the following example:

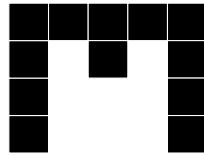

which is represented by the matrix,

$$M = \begin{bmatrix} 1 & 1 & 1 & 1 & 1 \\ 1 & 0 & 1 & 0 & 1 \\ 1 & 0 & 0 & 0 & 1 \\ 1 & 0 & 0 & 0 & 1 \end{bmatrix}.$$

On each iteration, we will add coordinates to a set of *Anchored* sites,  $A$ . At each step, this set contains all the coordinates that we know are constructible, starting by the last coordinate. If by the time the algorithm finishes, there are coordinates that are not contained in  $A$ , we will state that the figure is not constructible through the two-directional dynamics. The order in which we will ask if the new figure is constructible is shown in the following matrix:

$$\begin{bmatrix} 20 & 18 & 15 & 11 & 7 \\ 19 & 16 & 12 & 8 & 4 \\ 17 & 13 & 9 & 5 & 2 \\ 14 & 10 & 6 & 3 & 1 \end{bmatrix}.$$

The algorithm begins by adding  $(4, 5)$  to set  $A$ . Next we ask if the figure obtained by adding coordinate  $(3, 5)$  is constructible, which in this case amounts to asking if  $\begin{bmatrix} 1 \\ 1 \end{bmatrix}$  is constructible. Because we now that any column is realizable, we add coordinate  $(3, 5)$  to  $A$ . Furthermore, and by following the before mentioned order, because  $M_{3,4} = 0$ , we can add this coordinate to  $A$ .

The first roadblock to this procedure is encountered on step 12:

$$M = \begin{bmatrix} 1 & 1 & 1 & 1^A & 1^A \\ 1 & 0 & 1^? & 0^A & 1^A \\ 1 & 0 & 0^A & 0^A & 1^A \\ 1 & 0^A & 0^A & 0^A & 1^A \end{bmatrix}.$$

Here, coordinates already on  $A$  are denoted by a superscripted  $A$ . In this step we ask if  $A$  is constructible when adding coordinate  $(2, 3)$ . It is easy to see that given the coordinate available, there is no way to construct the figure; the block at coordinate  $(2, 3)$  is always hanging in mid-air.

Because overhangs are a possibility, we can't rule out  $M$  as un-constructible. This means that we must hold on to coordinate  $(2, 3)$  until more of the figure has been ruled as feasible.

By continuing with the procedure, we arrive at a new situation:

$$M = \begin{bmatrix} 1 & 1 & 1^? & 1^A & 1^A \\ 1 & 0 & 1^? & 0^A & 1^A \\ 1 & 0^A & 0^A & 0^A & 1^A \\ 1^A & 0^A & 0^A & 0^A & 1^A \end{bmatrix}.$$

Because we left coordinate  $(2, 3)$  in stand-by, we now ask  $A$  is constructible by adding both  $(2, 3)$  and  $(1, 3)$  simultaneously. Due to the fact that this new figure can be constructed, we add both coordinates to  $A$ , and move on to the rest of the missing coordinates.

To see where how this procedure discerns between realizable figures, let's analyze a case where the figure is not constructible:

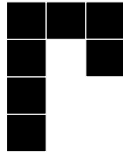

which is represented by the matrix:

$$\begin{bmatrix} 0 & 0 & 0 & 0 & 0 \\ 0 & 1 & 1 & 1 & 0 \\ 0 & 1 & 0 & 1 & 0 \\ 0 & 1 & 0 & 0 & 0 \\ 0 & 1 & 0 & 0 & 0 \end{bmatrix}.$$

As before, the order in which we will grow the set of constructible positions is given by:

$$\begin{bmatrix} 25 & 23 & 20 & 16 & 11 \\ 24 & 21 & 17 & 12 & 7 \\ 22 & 18 & 13 & 8 & 4 \\ 19 & 14 & 9 & 5 & 2 \\ 15 & 10 & 6 & 3 & 1 \end{bmatrix}.$$

Again, the algorithm begins by adding site  $(5, 5)$  to the set of anchored sites  $A$ . Then, by following the order mentioned the algorithm continues to add sites (as long as the ones on  $A$  remain constructible as a whole) until it encounters a site it can't add. For the given example, this occurs at step 8:



$$\begin{bmatrix} 0 & 0 & 0 & 0 & 0 \\ 0 & 1 & 1 & 1 & 0^A \\ 0 & 1 & 0 & 1^? & 0^A \\ 0 & 1 & 0 & 0^A & 0^A \\ 0 & 1 & 0^A & 0^A & 0^A \end{bmatrix}.$$

Because up to this point  $A$  is composed of only empty sites, there is now way to construct a particle floating two blocks above the floor (that is, on site  $(3, 4)$ ). We hold on to this site and continue with the pre-established order.

The next problem we encounter is at step 12:

$$\begin{bmatrix} 0 & 0 & 0 & 0 & 0^A \\ 0 & 1 & 1 & 1^? & 0^A \\ 0 & 1 & 0 & 1^? & 0^A \\ 0 & 1 & 0^A & 0^A & 0^A \\ 0 & 1^A & 0^A & 0^A & 0^A \end{bmatrix}.$$

We now ask if set  $A$  is constructible by adding both  $(3, 4)$  and  $(2, 4)$  simultaneously. It is easy to see that the same problem persists: given  $A$ , we are still asking if we can build floating blocks, which is not allowed by the dynamics. In an analogous fashion, we proceed to ask if  $A$  is constructible by adding coordinates  $(3, 4)$  and  $(3, 3)$ . These sites suffer from the same problem as before, so they are put on hold.

The next problematic sites come at step 16 and 18. In the former we ask if  $A$  is constructible by adding  $(3, 4)$ ,  $(2, 4)$  and  $(1, 4)$ , which suffers from the same short coming as before. For the latter, the sites added are  $(3, 4)$ ,  $(3, 3)$  and  $(3, 2)$ .

$$\begin{bmatrix} 0 & 0 & 0 & 0 & 0^A \\ 0 & 1 & 1 & 1 & 0^A \\ 0 & 1^? & 0^? & 1^? & 0^A \\ 0 & 1^A & 0^A & 0^A & 0^A \\ 0^A & 1^A & 0^A & 0^A & 0^A \end{bmatrix}.$$

Although site  $(3, 2)$  can be anchored at site  $(4, 2) \in A$ , we require that all the coordinates added must be constructible.

We note that after adding site  $(1, 5)$  to  $A$ , there is no way to continue with the procedure. This means that the given figure is not constructible by the 2-DLA dynamics.

Let us formalize this procedure:

DEFINITION 4.5. *Let  $C \subseteq [N] \times [N]$  be a set of coordinates. We create the graph  $G_C = (V_C, E_C)$ , where*

$$V_C = \{(i, j) : (i, j) \in C \wedge F_{ij} = 1\} \cup \{g\},$$

$$E_1 = \{(i, j)(k, l) : F_{ij} = F_{kl} = 1 \wedge (k, l) \in \{(i, j \pm 1), (i \pm 1, j)\}\},$$

$$E_2 = \{(N, j)g : F_{Nj} = 1\},$$

and  $E_C = E_1 \cup E_2$ . We say  $C$  is anchored, if  $G_C$  is connected.

The set of edges  $E_1$  represents particles which are stuck to each other, and  $E_2$  represents the particles that are stuck to the ground.

As in the first example, we will recursively check the given figure from site  $(N, M)$ . The idea is to create the sequence of launches as the recursion works through the figure. The order in which we do this is given determined by the 1-norm, as shown on Figure 10.

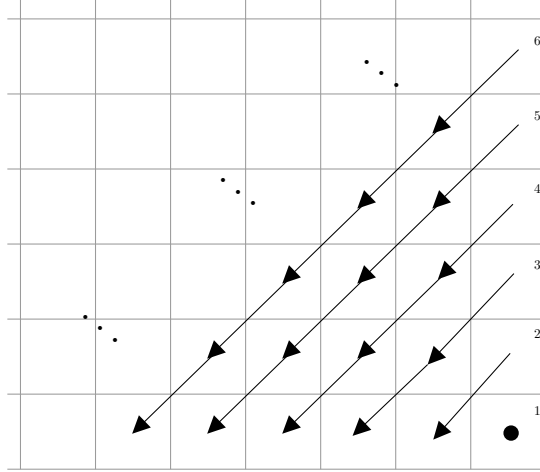

FIG. 10. Order in which new coordinates are added to the constructible set.

We define the family of sets  $\{A_n\}_{n \in [N^2]}$ , where  $A_1 = \{(N, N)\}$ . We transform every coordinate,  $(i, j)$  into

$$n(i, j) = 1 + \left( N - j - \left\lfloor \frac{d}{N} \right\rfloor (d + 1 - N) \right) + \frac{d(d+1)}{2} - \left\lfloor \frac{d}{N} \right\rfloor (d - N)(d + 1 - N),$$

where  $d = (N - i) + (N - j)$ , which orders them in the specified way (this can be seen in the examples, specifically on the matrices which specify the order in which coordinates are added). In addition, we define the set,  $B$ , of particles which are not constructible at the current stage, but will possibly be constructed at a later iteration. We note that the algorithm will accept at the end if and only if set  $B$  is empty.

Suppose we are on the  $n$ -th iteration; we define  $A_{n+1}$  as follows: Let  $i$  and  $j$  be such that  $n + 1 = n(i, j)$ .

1. We first check if  $(i - 1, j) \in B$ . If this is the case, we continue checking for all  $(i - k, j) \in B$  for  $k \geq 1$ . For all these coordinates, we ask if  $A_n \cup \{(i - k, j)\}_{k \geq 0}$  is anchored. If the answer is positive, we set  $A_{n+1} = A_n \cup \{(i - k, j)\}_{k \geq 0}$ . If not, we add  $(i, j)$  to  $B$ , and set  $A_{n+1} = A_n$ .
2. We then check if  $(i, j - 1) \in B$ . If this is the case, as before, we continue checking for all  $(i, j - k) \in B$  for  $k \geq 1$ . For all these coordinates, we ask if  $A_n \cup \{(i, j - k)\}_{k \geq 0}$  is anchored. If the answer is positive, we set  $A_{n+1} = A_n \cup \{(i, j - k)\}_{k \geq 0}$ . If not, we add  $(i, j)$  to  $B$ , and set  $A_{n+1} = A_n$ .
3. If neither of the previous situations happen, we ask if  $A_n \cup \{(i, j)\}$  is anchored. If the answer is yes, we set  $A_{n+1} = A_n \cup \{(i, j)\}$ . On the contrary, we add  $(i, j)$  to  $B$ , and set  $A_{n+1} = A_n$ .
4. We say  $F$  is constructible if  $A_{N^2} = [N] \times [N]$ .

We now present the proof of the proposition.

*Proof of Prop. 4.4.* Let  $F \in \{0, 1\}^{N \times N}$  be a figure obtained from the dynamics. We will show that the before mentioned procedure accepts  $F$ : let  $(i, j) \in [N] \times [N]$  be an arbitrary coordinate. and  $n = n(i, j)$ .

The first case is when  $(i, j - 1) \notin B$  nor  $(i - 1, j) \notin B$ . If  $F_{ij} = 0$  it is evident that  $A_{n-1} \cup \{(i, j)\}$  is constructible, which means that  $(i, j) \in A_n$ . On the other hand, if  $F_{ij} = 1$ , because of the dynamics, this site is occupied by virtue of the particle sticking to an occupied neighbor. If the coordinate of this occupied neighbor is in  $A_{n-1}$ ,  $A_{n-1} \cup \{(i, j)\}$  will be constructible, and therefore  $(i, j) \in A_n$ . If it is not in  $A_{n-1}$ , we will have  $(i, j) \in B$ . Because of this, this coordinate will be added later on: it will be added in a block along side the occupied neighbor's coordinates. The cases where  $(i, j - 1) \in B$  or  $(i - 1, j) \in B$  are analogous. We conclude that  $A_{N^2} = [N] \times [N]$ , i.e. the procedure accepts.

Now suppose that  $F$  is a figure such that  $A_{N^2} = [N] \times [N]$ . For every  $(i, j)$  such that  $F_{ij} = 1$ , there exists an  $m \geq n(i, j)$  such that  $(i, j) \in A_m \setminus A_{m-1}$ . We create a particle list from the sets  $\{A_n\}_{n \in [N^2]}$ : Each particle is thrown in the order of the index of the first set on which the coordinate in which it ultimately ends up in appears. If only a single coordinate is added from one  $A_n$  to the next, there is no ambiguity on adding the new particles to the ones being thrown. The problem arises when a block of coordinates is added. In this case, we add the particles by ordering them according to their distance to node  $g$  on the auxiliary graph  $G_C$ . Because the constructible sets grow diagonally starting from the bottom right corner, each particle thrown can reach its assigned place in the figure, without being intercepted. Therefore, figure  $F$  is realizable by the dynamics.

Even though we can't provide a proof that this problem is **P**-Complete at this time, there is some evidence pointing to the fact that it is probably not parallelizable. The following example shows that a figure's different connected components are not independent from each other. On Figure 11, the non-labeled section must be constructed first. Then, it is easy to see that part  $a$  must be constructed before part  $b$ , and part  $b$  must be constructed before part  $c$ .

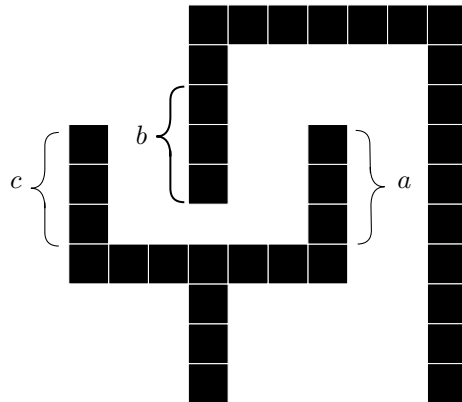

FIG. 11. A figure exhibiting sequential behaviour.

**5. Conclusion.** The introduction of restrictions to the system changes our computational complexity when the only direction available for particles to move is downwards. By adapting the **P**-Complete proof of the 4-DLA-PREDICTION we showed that both 3-DLA-PREDICTION and 2-DLA-PREDICTION are **P**-Complete. For 1-DLA-PREDICTION, we tackled the generalized problem, BALLISTIC DEPOSITION and showed that by exploiting the commutativity exhibited by the dynamics of the system, we created a non-deterministic log-space algorithm to solve the problem, and show that 1-PREDICTION is in **NL**-Complete. What is interesting to note is that the algorithm does not depend on the topological properties of the model, it exclusively works on the input word (the sequence of particle throws in this case).

We finally showed that characterizing the shapes that are obtainable through the dynamics is an interesting problem, and exhibited that the computational problem associated is in **L** for the one-directional dynamics, and in **P** for the two-directional one.

**5.1. Future Work.** An interesting extension to the presented problem is the one of determining, given a figure, what is the minimum amount of directions necessary to produce it, if it is achievable at all. We have shown that figures generated by the 1-PREDICTION model are characterizable in **L**, and those of the two-directional model in **P**. It remains to see if the latter can be improved into an **NC** algorithm, or the problem is in fact **P**-Complete. In addition, the complexity class of the problem of characterizing achievable figures remains to be found for the three and four-directional cases.

A related problem is concerned with determining if, given an initial and final figure, there is a sequence of particles throws that takes the initial figure to the final. This can too be divided in relation to the number of directions the particles are allowed to move in. It is our belief that because of the increase in the degrees of freedom the problem allows, there is room to create more complex gadgets, indicating that these problems are possibly **NP**-Complete.

**Acknowledgments.** We would like to thank the anonymous reviewers for letting us know about the Ballistic Deposition model, which we had no previous knowledge of. This work has been partially supported by CONICYT, via PAI + Convocatoria Nacional Subvención a la Incorporación en la Academia Año 2017 + PAI77170068 (P.M.), and via CONICYT-PFCHA/MagísterNacional/2019 - 22190497 (N. Bitar).

#### REFERENCES

- [1] E. ALLENDER, T. CHAKRABORTY, D. A. M. BARRINGTON, S. DATTA, AND S. ROY, *Grid graph reachability problems*, in 21st Annual IEEE Conference on Computational Complexity (CCC'06), IEEE, 2006, pp. 15–pp.
- [2] S. ARORA AND B. BARAK, *Computational complexity: a modern approach*, Cambridge University Press, 2009.
- [3] J. J. ARULANANDHAM, C. S. CALUDE, AND M. DINNEEN, *Bead-sort: A natural sorting algorithm*, tech. report, Department of Computer Science, The University of Auckland, New Zealand, 2002.
- [4] A. ASSELAH, E. N. CIRILLO, B. SCOPPOLA, E. SCOPPOLA, ET AL., *On diffusion limited deposition*, *Electronic Journal of Probability*, 21 (2016).
- [5] F. BARRA, B. DAVIDOVITCH, AND I. PROCACCIA, *Iterated conformal dynamics and laplacian growth*, *Physical Review E*, 65 (2002), p. 046144.
- [6] F. BENEVIDES AND M. PRZYKUCKI, *Maximum percolation time in two-dimensional bootstrap percolation*, *SIAM Journal on Discrete Mathematics*, 29 (2015), pp. 224–251, <https://doi.org/10.1137/130941584>, <https://doi.org/10.1137/130941584>.

- [7] R. BRADY AND R. BALL, *Fractal growth of copper electrodeposits*, *Nature*, 309 (1984), pp. 225–229.
- [8] J. CHALUPA, P. L. LEATH, AND G. R. REICH, *Bootstrap percolation on a bethe lattice*, *Journal of Physics C: Solid State Physics*, 12 (1979), pp. L31–L35, <https://doi.org/10.1088/0022-3719/12/1/008>, <https://doi.org/10.1088/0022-3719/12/1/008>.
- [9] D. Y. CHAN, B. D. HUGHES, L. PATERSON, AND C. SIRAKOFF, *Simulating flow in porous media*, *Physical Review A*, 38 (1988), p. 4106.
- [10] E. GOLES, P. MONTEALEGRE-BARBA, AND I. TODINCA, *The complexity of the bootstrapping percolation and other problems*, *Theoretical Computer Science*, 504 (2013), pp. 73–82, <https://doi.org/10.1016/j.tcs.2012.08.001>, <https://doi.org/10.1016/j.tcs.2012.08.001>.
- [11] R. GREENLAW, H. HOOVER, AND W. RUZZO, *Limits to Parallel Computation: P-completeness Theory*, Oxford University Press, Inc., New York, NY, USA, 1995.
- [12] T. C. HALSEY, P. MEAKIN, AND I. PROCACCIA, *Scaling structure of the surface layer of diffusion-limited aggregates*, *Physical review letters*, 56 (1986), p. 854.
- [13] Z. KOZA, *The equivalence of the dla and a hydrodynamic model*, *Journal of Physics A: Mathematical and General*, 24 (1991), p. 4895.
- [14] J. MACHTA AND R. GREENLAW, *The parallel complexity of growth models*, *Journal of Statistical Physics*, 77 (1994), pp. 755–781.
- [15] J. MACHTA AND R. GREENLAW, *The computational complexity of generating random fractals*, *Journal of Statistical Physics*, 82 (1996), pp. 1299–1326.
- [16] T. MANSOUR, R. RASTEGAR, AND A. ROITERSHTEIN, *On ballistic deposition process on a strip*, arXiv preprint arXiv:1903.12548, (2019).
- [17] P. MEAKIN, *Diffusion-controlled cluster formation in 2-6-dimensional space*, *Physical Review A*, 27 (1983), p. 1495.
- [18] P. MEAKIN, P. RAMANLAL, L. M. SANDER, AND R. BALL, *Ballistic deposition on surfaces*, *Physical Review A*, 34 (1986), p. 5091.
- [19] C. MOORE AND J. MACHTA, *Internal diffusion-limited aggregation: parallel algorithms and complexity*, *Journal of Statistical Physics*, 99 (2000), pp. 661–690.
- [20] C. MOORE AND M. NILSSON, *The computational complexity of sandpiles*, *Journal of statistical physics*, 96 (1999), pp. 205–224.
- [21] L. NIEMEYER, L. PIETRONERO, AND H. WIESMANN, *Fractal dimension of dielectric breakdown*, *Physical Review Letters*, 52 (1984), p. 1033.
- [22] J. NITTMANN, G. DACCORD, AND H. E. STANLEY, *Fractal growth viscous fingers: quantitative characterization of a fluid instability phenomenon*, *Nature*, 314 (1985), pp. 141–144.
- [23] M. D. PENROSE, *Growth and roughness of the interface for ballistic deposition*, *Journal of Statistical Physics*, 131 (2008), pp. 247–268.
- [24] D. SUTHERLAND, *Comments on vold's simulation of floc formation*, *Journal of Colloid and Interface Science*, 22 (1966), pp. 300–302.
- [25] M. J. VOLD, *Computer simulation of floc formation in a colloidal suspension*, *Journal of Colloid Science*, 18 (1963), pp. 684–695.
- [26] T. A. WITTEN AND L. M. SANDER, *Diffusion-limited aggregation, a kinetic critical phenomenon*, *Phys. Rev. Lett.*, 47 (1981), pp. 1400–1403, <https://doi.org/10.1103/PhysRevLett.47.1400>, <https://link.aps.org/doi/10.1103/PhysRevLett.47.1400>.