

Cite this: DOI: 00.0000/xxxxxxxxxx

Hydrodynamic Mobility Reversal of Squirmers near Flat and Curved Surfaces

Michael Kuron^{*a‡}, Philipp Stärk^{a‡}, Christian Holm^{a‡}, and Joost de Graaf^{fb‡}Received Date
Accepted Date

DOI: 00.0000/xxxxxxxxxx

Self-propelled particles have been experimentally shown to orbit spherical obstacles and move along surfaces. Here, we theoretically and numerically investigate this behavior for a hydrodynamic squirmer interacting with spherical objects and flat walls using three different methods of approximately solving the Stokes equations: The method of reflections, which is accurate in the far field; lubrication theory, which describes the close-to-contact behavior; and a lattice Boltzmann solver that accurately accounts for near-field flows. The method of reflections predicts three distinct behaviors: orbiting/sliding, scattering, and hovering, with orbiting being favored for lower curvature as in the literature. Surprisingly, it also shows backward orbiting/sliding for sufficiently strong pushers, caused by fluid recirculation in the gap between the squirmer and the obstacle leading to strong forces opposing forward motion. Lubrication theory instead suggests that only hovering is a stable point for the dynamics. We therefore employ lattice Boltzmann to resolve this discrepancy and we qualitatively reproduce the richer far-field predictions. Our results thus provide insight into a possible mechanism of mobility reversal mediated solely through hydrodynamic interactions with a surface.

1 Introduction

An increasing body of experimental and theoretical work demonstrates that the proximity of surfaces has an important effect on the behavior of self-propelled particles. In biology, spermatozoa^{1–3} and bacteria⁴ can circle near a flat wall, which has been attributed to hydrodynamic interactions and the specifics of flagellar beating^{5–12}. Artificial self-propelled particles, which can move through the catalytic decomposition of H_2O_2 ^{13,14}, i.e., chemical swimmers, also respond to the presence of a surface^{15–19}. In this case, there can be both a hydrodynamic^{5,20–23} and a chemical coupling to the surface^{17,19,24–26}, which themselves are intimately linked through the way they lead to self-propulsion^{13,14,27–36}.

Experimentally, chemical swimmers are well known to be orientationally locked near a flat surface^{17,19}. This locking has been linked to specifics of the reaction mechanism and the local hydrodynamic interactions that it induces^{17,25}. Chemical swimmers may also follow the surface topology. For example, they interact with small variations of the substrate's height^{15,19}, as has been qualitatively described using simple theoretical model swim-

mers¹⁹. In addition, chemical patterning of the surface has been shown to significantly modify the mobility of a chemical swimmer^{37–41}. These man-made swimmers can also follow strongly curved surfaces, even leading them to orbit around spherical obstacles^{16,18}.

The orbiting of swimmers has been studied extensively using hydrodynamic descriptions^{23,42}. In the far field, the associated hydrodynamic problem is typically solved using the method-of-reflections approximation²⁰ and Faxén's law^{43,44}. Spagnolie *et al.*²³ account for the leading-order hydrodynamic force-dipole moment in their analysis and find that there is a critical radius for orbiting. Only pusher swimmers — ones that have an extensible flow field — enter such a trajectory²³; pullers on the other hand are trapped in a 'hovering' state, wherein they point straight into the surface. However, the methods of reflections is known to break down for small swimmer-obstacle separations²².

In the lubrication regime, which captures the behavior for vanishing gap sizes, a swimmer's ability to follow a path along a planar wall has been examined^{45,46}. Specifically, Lintuvuori *et al.*⁴⁵ studied a squirmer, which is a simple model swimmer that accounts for finite-size contributions to the flow field. The results for a squirmer near a flat wall may be readily transferred to orbiting around objects with low curvature. Unfortunately, lubrication theory does not provide substantial insight other than for the hovering state, wherein the swimmer's direction of motion is into the obstacle and no tangential displacement occurs.

^a Institute for Computational Physics, University of Stuttgart, Allmandring 3, 70569 Stuttgart, Germany. E-mail: mkuron@icp.uni-stuttgart.de

^b Institute for Theoretical Physics, Center for Extreme Matter and Emergent Phenomena, Utrecht University, Princetonplein 5, 3584 CC Utrecht, The Netherlands.

‡ Conceptualization: MK, JdG; Calculations and Analysis: MK, PS, JdG; Writing: MK, JdG; Supervision: CH, JdG; Funding Acquisition: CH, JdG; Resources: CH.

A combination of lubrication and far-field results is often used in an attempt to bridge the gap between these two regimes^{42,45,46}. This approximation gives rise to steady orbiting pullers and oscillatory orbits for pushers⁴⁵, the latter of which are a result of a competition between the two regimes. The critical radius for orbiting will also be reduced by this interplay⁴².

In the case of a flat wall, the intermediate regime has been resolved using the boundary element (BEM) method⁴⁷, as well as the lattice Boltzmann (LB) method^{45,46}, and multi-particle collision dynamics⁴⁸ (MPCD). Ishimoto and Gaffney⁴⁷ observe that a puller squirmer moves stably along the wall, pointing slightly toward it. Lintuvuori *et al.*⁴⁵ reproduce the behaviors found in their analytic predictions, which combine the far field and lubrication regimes. However, this level of analysis has not yet been performed for orbiting.

In this paper, we examine in-depth the effect of the surface curvature on the hydrodynamic orbiting of a squirmer and take the limit to the behavior near a flat surface. To efficiently explore parameter space, we employ far-field approximations, as well as the LB method^{49–52} that accurately resolves the near-field flows. Using this approach we reproduce the three behaviors reported in literature: orbiting around the sphere/sliding along the wall, scattering, and hovering^{23,42,45,47}. Surprisingly, we find a second type of orbiting in both our hydrodynamic approaches where the swimmer effectively moves in the direction opposite to its bulk motion. Backward orbiting appears for strong pusher squirmers and supersedes the forward orbiting predicted for a point-like dipole swimmer using identical hydrodynamic parameters²³. This behavior can be shown to result from fluid recirculation in the gap between the squirmer and the surface leading to strong forces opposing forward motion. In the limit of a flat wall, we similarly find backward sliding.

The behavior of a squirmer near an obstacle is controlled by the strength and sign of its dipole moment and is also sensitive to the curvature of the obstacle. Scattering takes place for sufficiently neutral squirmers, which only have a source dipole flow field in bulk, while hovering and orbiting require the presence of a force-dipole contribution to the flow field. We find that the minimal force-dipole moment that leads to orbiting scales quadratically with the curvature for puller squirmers. Backward orbiting/sliding and hovering can be suppressed by introducing short-ranged repulsions between the squirmer and the surface. However, backward motion supplants forward motion even for imposed gap sizes of one tenth of the squirmer radius.

We will focus on hydrodynamic interactions here, but our results are also of interest to the ongoing study of motion of chemical swimmers near surfaces. We will show that it is possible to reverse the mobility of a swimmer by modifying its hydrodynamic force-dipole moment without changing the bulk swim velocity. This strong response to the presence of a surface underpins the need for more experiments performed in bulk in order to isolate the effect of environmental changes on swimmer mobility. Our predictions provide a stepping stone toward understanding the richer behaviors encountered when introducing coupling between solute gradients and hydrodynamic flow fields^{53–55}.

The remainder of this paper is laid out as follows: Section 2

introduces the squirmer model and describes the problem considered. We also explain how the hydrodynamics are solved to obtain trajectories of the squirmers. In section 3, we introduce a characterization of these trajectories, before we present our main results in section 4, wherein we discuss the influence of obstacle size, short-range repulsion, and higher-order hydrodynamic moments. We conclude and present an outlook in section 5.

2 Model and Method

In this paper, we study the interaction of a squirmer of radius R_S with a spherical obstacle of radius R (or a flat wall, corresponding to $R \rightarrow \infty$) as illustrated in fig. 1. The squirmer is free to move and its position is $\mathbf{r}_S = (x, y)^T$ with the superscript denoting transposition, while the obstacle is fixed at the origin. Figure 2 introduces the angles and distances used to describe the squirmer's position and orientation: φ is the angle between the squirmer's orientation $\hat{\mathbf{e}}$ and the tangent plane at the closest point on the obstacle's surface; α is the angle between the direction of the squirmer's velocity \mathbf{v} and the tangent plane; and h is the size of the gap between the squirmer's and the obstacle's surfaces. Initially, the squirmer is located far away from the obstacle — we effectively take the limit to infinity — at different distances y_0 from the x -axis. $\hat{\mathbf{e}}$ points along the x -axis, corresponding to $\varphi_0 = \arcsin(y_0/R_S) - 90^\circ$. For the case of the flat wall, the squirmer starts at a large distance above the wall and oriented at different φ_0 against it. Subscript zeros ($_0$) here refer to the respective variable at time $t = 0$.

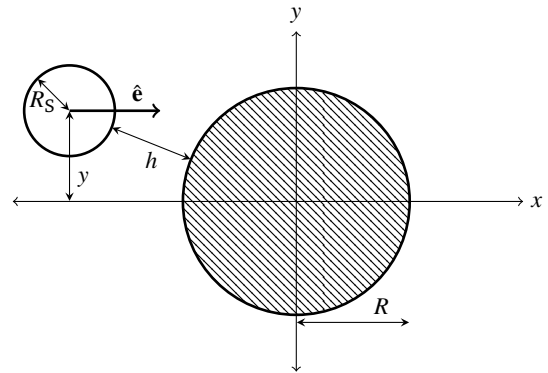

Fig. 1 The geometry of the system investigated: The obstacle of radius R is located at the origin, while the squirmer of radius R_S and orientation $\hat{\mathbf{e}}$ is at $(x, y)^T$. The size of the gap between the two objects is h . For the case of the flat wall ($R \rightarrow \infty$), y loses its meaning, but the other quantities remain well-defined.

In the rest of this section, we describe a method to determine how the model's parameters — like dipolarity β , angle of incidence φ_0 , and size ratio R/R_S — affect the squirmer's ability to enter into an orbit around or be scattered at the obstacle: we (1) introduce the squirmer model, (2) perform a hydrodynamic multipole decomposition, (3) introduce the method of reflections to account for the obstacle's presence, (4) use Faxén's law to calculate the response of the squirmer to fluid flow, and (5) explain how to numerically integrate the trajectory. Finally, we (6) use lubrication theory to briefly discuss the stability of bound states and (7) introduce a numerical method that is capable of resolving the near-field flow.

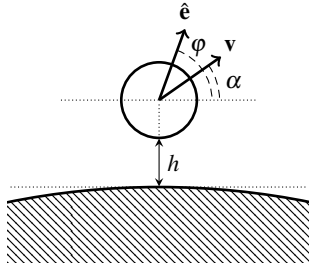

Fig. 2 The angles φ and α are between the tangent plane at the closest point on the obstacle's surface and the squirmer's orientation $\hat{\mathbf{e}}$ and direction of motion \mathbf{v} , respectively. The length h is the size of the gap between squirmer and obstacle.

2.1 Squirmers and the Stokes equation

Theoretical descriptions typically use simple swimmer models that describe only the resulting hydrodynamic flow in a far-field approximation, which eliminates the complex details of a microswimmer's propulsion method. As self-propulsion is force-free^{6,56}, the lowest nonzero term of a hydrodynamic multipole expansion is the dipole. The force dipole decays with distance as r^{-2} , which justifies the often-applied truncation beyond this order. Point dipoles are, however, difficult to handle numerically, due to their inherent divergences^{57,58}, while extended dipoles are inconvenient to analytical theory.

A widely used model that can account for finite sizes of the swimmer is the squirmer model. Lighthill⁵⁹ originally introduced it to explain swimming by an oscillatory shape change. Blake⁶⁰ later used it to describe the microorganism *Paramecium*, which propels via a specific beat pattern of the cilia on its surface. Both authors expanded the flow at the swimmer's surface into spherical harmonics and discovered that the first two modes are sufficient to describe the resulting flow. If the squirmer is impermeable, radial flow through the surface can further be ignored⁶¹, so that the motion of cilia on the surface of a sphere of radius R_S can be described by the envelope⁶⁰

$$\mathbf{u}(\mathbf{r})|_{s=R_S} = \left(B_1 + B_2 \frac{\hat{\mathbf{e}} \cdot \mathbf{s}}{s} \right) \left(\frac{\hat{\mathbf{e}} \cdot \mathbf{s}}{s} \frac{\mathbf{s}}{s} - \hat{\mathbf{e}} \right). \quad (1)$$

Here, $\mathbf{s} = \mathbf{r} - \mathbf{r}_S$ is the position vector \mathbf{r} relative to the squirmer's center \mathbf{r}_S , B_1 and B_2 are constants, and $\hat{\mathbf{e}}$ is the unit orientation vector of the sphere.

The flow resulting from this boundary condition is governed by the Navier-Stokes equations, which reduce to the Stokes equations,

$$\eta \nabla^2 \mathbf{u}(\mathbf{r}) = -\nabla p(\mathbf{r}), \quad (2)$$

$$\nabla \cdot \mathbf{u}(\mathbf{r}) = 0, \quad (3)$$

in the here-applicable limit of a low Reynolds number,

$$\text{Re} = \frac{2\rho v_0 R_S}{\eta} \ll 1. \quad (4)$$

p refers to the pressure, ρ to the fluid density, and η to the fluid viscosity, while v_0 is a characteristic flow velocity. ∇ , $\nabla \cdot$, and ∇^2

are the gradient, divergence and Laplace operators, respectively. Equations (2) and (3) under the condition of eq. (1) are solved by the flow field^{60,61}

$$\begin{aligned} \mathbf{u}_S(\mathbf{r}) = & B_1 \frac{R_S^3}{s^3} \left(\frac{\hat{\mathbf{e}} \cdot \mathbf{s}}{s} \frac{\mathbf{s}}{s} - \frac{1}{3} \hat{\mathbf{e}} \right) \\ & + B_2 \left(\frac{R_S^4}{s^4} - \frac{R_S^2}{s^2} \right) \left(\frac{3}{2} \left(\frac{\hat{\mathbf{e}} \cdot \mathbf{s}}{s} \right)^2 - \frac{1}{2} \right) \frac{\mathbf{s}}{s} \\ & + B_2 \frac{R_S^4}{s^4} \frac{\hat{\mathbf{e}} \cdot \mathbf{s}}{s} \left(\frac{\hat{\mathbf{e}} \cdot \mathbf{s}}{s} \frac{\mathbf{s}}{s} - \hat{\mathbf{e}} \right) \end{aligned} \quad (5)$$

in the laboratory frame. This corresponds to the squirmer moving with a velocity^{60,61} of

$$\mathbf{v}_0 = \frac{2}{3} B_1 \hat{\mathbf{e}}, \quad (6)$$

i.e., a velocity that depends only on the first mode and points in the direction of the squirmer's orientation vector $\hat{\mathbf{e}}$. Micrometer-sized swimmers in water exist in the low-Re limit according to eq. (4), thus v_0 only sets the time scale without changing the physical behavior. This makes it convenient to scale out v_0 and introduce the dipolarity

$$\beta = \frac{B_2}{B_1} \quad (7)$$

as the ratio of the magnitudes of the second and first moment. β classifies the shape of the flow field, with the sign distinguishing three different kinds of swimmers. A pusher with $\beta < 0$ pushes fluid away from its front and back (with $\hat{\mathbf{e}}$ pointing forward) and draws fluid in from its sides. A puller with $\beta > 0$ pulls fluid toward itself at front and back, pushing it away from its sides. At the transition point $\beta = 0$ lies the neutral squirmer, which moves fluid from front to back. Biological examples of these three classes include *Escheria coli*⁶², *Chlamydomonas reinhardtii*⁶³, and *Paramecium*⁶⁴, respectively.

2.2 Mode Decomposition

We first consider a Stokeslet⁶⁵, the flow due to a force monopole \mathbf{F} applied at \mathbf{r}_S :

$$\mathbf{u}_{\text{FM}}(\mathbf{r}, \mathbf{r}_S) = \frac{1}{8\pi\eta} \mathcal{M}(\mathbf{r}, \mathbf{r}_S) \mathbf{F} \quad (8)$$

with the Oseen tensor

$$\mathcal{M}(\mathbf{r}, \mathbf{r}_S) = \frac{1}{|\mathbf{r} - \mathbf{r}_S|} \left(\mathbb{1} + \frac{(\mathbf{r} - \mathbf{r}_S) \otimes (\mathbf{r} - \mathbf{r}_S)}{|\mathbf{r} - \mathbf{r}_S|^2} \right). \quad (9)$$

We know that the flows of the higher hydrodynamic moments can be obtained from the Stokeslet eq. (8) by differentiation^{22,66,67}:

$$\mathbf{u}_{\text{FD}}(\mathbf{r}, \mathbf{r}_S) = \mathcal{D}(\mathbf{r}, \mathbf{r}_S) \mathbf{F} \quad (10)$$

$$\mathbf{u}_{\text{SD}}(\mathbf{r}, \mathbf{r}_S) = -\frac{1}{2} \nabla_S^2 \mathbf{u}_{\text{FM}}(\mathbf{r}, \mathbf{r}_S) \quad (11)$$

$$\mathbf{u}_{\text{SQ}}(\mathbf{r}, \mathbf{r}_S) = \mathcal{Q}(\mathbf{r}, \mathbf{r}_S) \mathbf{F} \quad (12)$$

with

$$\mathcal{D}(\mathbf{r}, \mathbf{r}_S) = -(\nabla_S \otimes \mathbf{u}_{FM}(\mathbf{r}, \mathbf{r}_S))^T \quad (13)$$

$$\mathcal{Q}(\mathbf{r}, \mathbf{r}_S) = \frac{1}{3} (\nabla_S \otimes \mathbf{u}_{SD}(\mathbf{r}, \mathbf{r}_S))^T. \quad (14)$$

Here, \otimes is the dyadic product and the subscript S to differentiation with respect to \mathbf{r}_S .

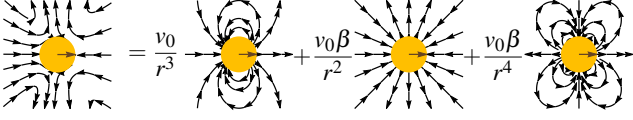

Fig. 3 The squirmer's flow field is comprised of a source dipole, a force dipole, and a source quadrupole.

We can write the squirmer flow in terms of these moments by identifying them in eq. (5):

$$\begin{aligned} \mathbf{u}_S(\mathbf{r}) = & \frac{8\pi\eta}{3} B_1 R_S^3 \mathbf{u}_{SD}(\mathbf{r}, \mathbf{r}_S) + \frac{8\pi\eta}{2} B_2 R_S^2 \mathbf{u}_{FD}(\mathbf{r}, \mathbf{r}_S) \\ & + \frac{8\pi\eta}{2} B_2 R_S^4 \mathbf{u}_{SQ}(\mathbf{r}, \mathbf{r}_S) \end{aligned} \quad (15)$$

with $\mathbf{F} = \hat{\mathbf{e}}$. This decomposition is illustrated by fig. 3: a squirmer's flow field is composed of a source dipole with r^{-3} decay and the prefactor B_1 , a force dipole with r^{-2} decay and a prefactor of B_2 , and a source quadrupole with r^{-4} decay and the same B_2 prefactor.

2.3 Method of Reflections

The expressions of section 2.1 are valid in bulk only. The presence of a solid boundary can be incorporated via the method of reflections²⁰. Here, a virtual flow originating from inside the obstacle is introduced. Its purpose is to ensure fulfillment of the no-slip boundary condition on the obstacle's surface,

$$\mathbf{u}(\mathbf{r})|_{\text{boundary}} = \mathbf{0}. \quad (16)$$

We can limit ourselves to obtaining the image of the Stokeslet $\mathbf{u}_{FM}(\mathbf{r}, \mathbf{r}_S)$ as section 2.2 permits to express any higher hydrodynamic modes in terms of a Stokeslet. For a flat wall, this leads to the Blake tensor, a superposition of force monopole, force dipole and source dipole^{68,69},

$$\begin{aligned} \mathcal{R}_{\text{wall}} \mathbf{u}_{FM}(\mathbf{r}, \mathbf{r}_S) = & -\mathbf{u}_{FM}(\mathbf{r} - \mathbf{r}_*) + \mathbf{u}_{FD}(\mathbf{r} - \mathbf{r}_*) \\ & - \mathbf{u}_{SD}(\mathbf{r} - \mathbf{r}_*). \end{aligned} \quad (17)$$

These seemingly originate from a point \mathbf{r}_* on the other side of the wall and at the same distance from the wall as the Stokeslet. The image Stokeslet for a no-slip sphere is^{23,70}

$$\mathcal{R} \mathbf{u}_{FM}(\mathbf{r}, \mathbf{r}_S) = \frac{1}{8\pi\eta} \mathcal{R} \mathcal{M}(\mathbf{r}, \mathbf{r}_S) \mathbf{F} \quad (18)$$

with the reflection operator \mathcal{R} given in appendix A. Equation (17) for the reflection by a flat wall is recovered from this by expanding

around $R^{-1} = 0$. The expansion reveals that corrections are to leading order linear in the inverse radius.

We finally obtain the image squirmer,

$$\begin{aligned} \mathcal{R} \mathbf{u}_S(\mathbf{r}) = & \frac{8\pi\eta}{3} B_1 R_S^3 \mathcal{R} \mathbf{u}_{SD}(\mathbf{r}, \mathbf{r}_S) \\ & + \frac{8\pi\eta}{2} B_2 R_S^2 \mathcal{R} \mathbf{u}_{FD}(\mathbf{r}, \mathbf{r}_S) \\ & + \frac{8\pi\eta}{2} B_2 R_S^4 \mathcal{R} \mathbf{u}_{SQ}(\mathbf{r}, \mathbf{r}_S). \end{aligned} \quad (19)$$

One can exploit the linearity of the Stokes equation to change the order of operations. That is, we first apply the known reflection of eq. (18) and then perform the differentiation of eqs. (10) to (12):

$$\begin{aligned} = & -\frac{8\pi\eta}{6} B_1 R_S^3 \nabla_S^2 (\mathcal{R} \mathbf{u}_{FM}(\mathbf{r}, \mathbf{r}_S)) \\ & - \frac{8\pi\eta}{2} B_2 R_S^2 (\nabla_S \otimes (\mathcal{R} \mathbf{u}_{FM}(\mathbf{r}, \mathbf{r}_S))) \mathbf{F} \\ & - \pi\eta B_2 R_S^4 (\nabla_S \otimes \nabla_S^2 (\mathcal{R} \mathbf{u}_{FM}(\mathbf{r}, \mathbf{r}_S))) \mathbf{F}. \end{aligned} \quad (20)$$

The flow field

$$\mathbf{u}(\mathbf{r}) = \mathbf{u}_S(\mathbf{r}) + \mathcal{R} \mathbf{u}_S(\mathbf{r}) \quad (21)$$

fulfills the Stokes eqs. (2) and (3) and the no-slip boundary condition eq. (16) on the obstacle. It does not, however, exactly fulfill the slip boundary condition eq. (1) on the squirmer as this is not possible with a single reflection. An infinite series of reflections at the obstacle's and squirmer's surfaces would be required to respect both boundary conditions simultaneously.

Other methods that fulfill the condition of eq. (1) by correctly incorporating near-field hydrodynamic effects are, however, computationally much more expensive. The tradeoff of using a far-field method for a problem that is potentially near-field-dependent will be justified by section 4.3, where we compare some results to ones obtained with a near-field-capable method.

2.4 Faxén's law

Now that we have the flow field, we can calculate the squirmer's response to it via Faxén's laws^{43,44,61,71,72}. The first law states that a force-free sphere at position \mathbf{r} moves with velocity

$$\mathbf{v} = \left(1 + \frac{R_S^2}{6} \nabla^2 \right) \mathbf{u}(\mathbf{r}). \quad (22)$$

The second law gives the angular velocity of the sphere as

$$\boldsymbol{\omega} = \frac{1}{2} \nabla \times \mathbf{u}(\mathbf{r}). \quad (23)$$

Equations (22) and (23) can be used to calculate the response of the squirmer to the reflected flow $\mathcal{R} \mathbf{u}_S$. Its response to \mathbf{u}_S cannot be calculated this way as the flow diverges at \mathbf{r}_S ; however, we already know from eq. (6) that \mathbf{u}_S makes the squirmer move with velocity $v_0 \hat{\mathbf{e}}$. While eqs. (22) and (23) are series expansions, all higher orders are zero for spheres in Stokes flow⁴⁴. Faxén's

third⁷¹ and higher⁷³ laws are not needed as the squirmer is assumed to be rigid.

2.5 Numerical Method

Thus far, we have only given the analytical expressions for the problem considered. We now resort to a simple numerical method to solve the associated equation system, as analytical solutions are not available. This requires choosing values for the free parameters, which are the starting position and orientation of the squirmer and the squirmer radius R_S and dipolarity β . Due to the symmetry of the problem, we can restrict ourselves to the $z = 0$ plane, while still considering the full three-dimensional problem. We can furthermore set $R_S = 1$ without loss of generality as there are no externally-defined length scales.

The flow field $\mathbf{u}(\mathbf{r}, t)$ due to the squirmer can be obtained from eq. (21). All derivatives here are carried out analytically. The linear velocity $\mathbf{v}(t)$ and angular velocity $\boldsymbol{\omega}(t)$ of the squirmer is obtained from the flow via Faxén's eqs. (22) and (23). The derivatives in these are carried out numerically via two-sided central finite differences to avoid further increasing the number of terms in the expression, which is already approaching the limit of what can be computed efficiently. An Euler integrator,

$$\mathbf{r}(t) = \mathbf{r}(t - \tau) + \mathbf{v}(t)\tau, \quad (24)$$

then updates the position of the squirmer and the entire process is iterated to obtain the trajectory. The integrator's time step τ is not relevant as low-Reynolds flow is time-independent; instead, the squirmer's v_0 determines the integrator's step size. In the calculations below, we adaptively set

$$\tau = 0.01 \frac{1}{v_0} \max(h, R_S). \quad (25)$$

This allows for fast integration of the trajectory far away from the obstacle, where the squirmer moves in a (nearly) straight line, and a high resolution when the gap between the squirmer and the obstacle is small and the hydrodynamic interactions are strong.

We include a hard-core repulsive potential that prevents the overlap of squirmer and obstacle by ensuring that $h \geq r_{\text{cut}}$. This modifies the integrator of eq. (24) to become

$$\mathbf{r}(t) = \max(r_{\text{cut}} + R + R_S, r'(t)) \hat{\mathbf{r}}'(t) \quad (26)$$

with

$$\mathbf{r}'(t) = \mathbf{r}(t - \tau) + \mathbf{v}(t)\tau. \quad (27)$$

2.6 Stability Analysis using Lubrication Theory

The flow in a small gap between two objects is the regime of lubrication theory^{61,74,75}. It assumes that the flow is dominated by the interaction between those points where the surfaces are closest. For a squirmer near a flat wall, Lintuvuori *et al.*⁴⁵ give

$$\frac{d\varphi}{dt} = \boldsymbol{\omega} = \frac{3v_0}{2R_S} \cos \varphi (1 - \beta \sin \varphi) \hat{\mathbf{e}}_\varphi + \mathcal{O}\left(1/\log \frac{h}{R_S}\right) \quad (28)$$

$$\mathbf{v} = 0 + \mathcal{O}\left(1/\log \frac{h}{R_S}\right) \quad (29)$$

where $\hat{\mathbf{e}}_\varphi$ is the angular unit vector in our angle convention. This means that lateral translation vanishes but rotation remains possible.

Solving the above equation for the stationary state $\boldsymbol{\omega} = 0$ yields one stable solution, $\varphi = -90^\circ$ at $\beta < -1$. This corresponds to the hovering state of a pusher. However, the interplay between the lubrication regime and far-field reorientation can lead to orbiting states of both the puller and pusher⁴⁵.

Note that lubrication theory is an extreme limit where far-field hydrodynamics become irrelevant and only one term at infinitely close separation remains of the near-field flow. The typical gap sizes h we will find in the next section fall in between those where far-field hydrodynamics is applicable ($h \gtrsim R_S$) and those where lubrication theory is valid ($\log(h/R_S) \ll -1$). This necessitates verification of such predictions using methods that deal with the intermediate regime, the near field.

2.7 Resolving the Near Field using Lattice Boltzmann

Neither the far-field calculations of sections 2.3 to 2.5 nor the lubrication considerations of section 2.6 are able to accurately capture the intermediate near-field regime. The squirmer enters this regime when it comes close to the obstacle, and we therefore resort to the LB method^{49,50} to test our far-field predictions. LB is a Navier-Stokes solver that excels at coupled fluid-particle simulations and flows in complex geometries⁵¹. Space and time are discretized on a grid of spacing Δx and Δt , respectively, and the Boltzmann transport equation is solved using a two-time relaxation scheme. This reproduces solutions to the Navier-Stokes equations on sufficiently large length and time scales, which we resolve. Our specific implementation using the waLBerla framework^{76,77} and its application to the present problem are described in Ref. 78. We refer the interested reader to Ref. 52 for a complete overview of the general LB method.

We should point out the following concerning our LB calculations here: The minimal gap between squirmer and obstacle that LB can accurately resolve is limited to around Δx , due to our LB's lack of lubrication corrections^{72,79,80}. Note that such corrections exist for driven spheres and some other shapes, but a specific implementation for a squirmer has not yet been formulated, due to the complexity of the boundary problem. We therefore impose short-ranged Weeks-Chandler-Andersen-type potential⁸¹ between the obstacle and squirmer, which is given by

$$U(\mathbf{r}_S - \mathbf{r}) = 4\epsilon \left[\left(\frac{\sigma}{|\mathbf{r}_S - \mathbf{r}|} \right)^{12} - \left(\frac{\sigma}{|\mathbf{r}_S - \mathbf{r}|} \right)^6 \right] + \epsilon, \quad (30)$$

for $0 < |\mathbf{r}_S| < 2^{1/6}\sigma$ and set to 0 for $r > 2^{1/6}\sigma$. This potential ensures that the squirmer and obstacle remain separated by at least one LB cell. We do not resort to hard-core repulsions, as a discontinuous potential leads to issues with the underlying algorithm for the positional update of our squirmer in waLBerla^{76,77}.

A resolution of eight lattice cells per squirmer radius ($R_S = 8\Delta x$) was used throughout, which allows for accurate capturing of flow

fields down to gaps of $h \gtrsim R_S/8$, also see Ref. 78. The calculations in this paper further employ a periodic calculation domain of size $L \times L \times H$ with $L = \max(5.5R, 160\Delta x)$ and $H = \max(2.6R, 80\Delta x)$. The viscosity is set to $\eta = 0.8\rho\Delta x^2/\Delta t$. The squirmer is initially located at $(\max(0.3R, 9\Delta x), y_0, L/2)^\top$, while the obstacle is at $(L/2, L/2, H/2)^\top$. In all LB calculations, $\varepsilon = 1\rho\Delta x^5/\Delta t^2$ and $\sigma = 1.34\Delta x$ are used.

3 Characterization

We start our analysis of the behavior of a squirmer near a spherical obstacle using the far-field hydrodynamic theory of sections 2.3 to 2.5. To determine the different behaviors, we vary the three free parameters in the model: the relative obstacle size R/R_S , the squirmer dipolarity β , and the initial off-axis position y_0 (or equivalently, the initial incidence angle φ_0). We pick $R/R_S \in \{1, 2, 5, 10, 20, 50, 100, 200, 500\}$ and $y_0 \in [0, 10R]$ spaced roughly exponentially, $\beta \in [-30, 30]$ spaced linearly, and $r_{\text{cut}}/R_S \in \{0, 0.01, 0.1, 0.2\}$.

3.1 Trajectories

Inspecting the resulting trajectories reveals four general classes of behavior, examples of which are shown in fig. 4a-d. (a) corresponds to a forward orbit; (b) is a scattering trajectory; in (c) the squirmer hovers above obstacle's surface; (d) is a backward orbit. Figure 4e shows the size of the gap between the squirmer and the obstacle over time. Here, one can see that a decaying oscillation is modulated onto the forward orbit, while the oscillation of the backward orbit is quite stable. These oscillations are reminiscent of those observed in Refs. 45,47. Figure 4fg shows the orientation of the squirmer's orientation vector $\hat{\mathbf{e}}$ and velocity vector \mathbf{v} , respectively.

To identify the origin of the three different kinds of bound trajectories more clearly, these angles are illustrated in fig. 5: In a forward orbit, $\hat{\mathbf{e}}$ and \mathbf{v} are roughly parallel ($\hat{\mathbf{e}} \cdot \mathbf{v} > 0$), while in a backward orbit they are antiparallel ($\hat{\mathbf{e}} \cdot \mathbf{v} < 0$). Hovering is a case where \mathbf{v} points almost straight into the obstacle, so the squirmer is stuck in place. A squirmer is considered hovering when it moves at a speed of $v < v_0/100$ or has $|\alpha - \varphi| < 3^\circ$. The precise choice of these limits may appear arbitrary, but we found that most orbiting trajectories exhibit angles that either much larger or much smaller. If the trajectory is oscillatory, we average the angle over at least one orbit.

Lastly, we should note that all of the above classes of trajectories are also obtained in our LB calculations of section 2.7. However, the specific parameters for which these behaviors are observed are different. We will come back to this in section 4.3.

3.2 Interpreting the Bound States

We examine the flow fields in fig. 6a-c to identify the hydrodynamic reason behind the observed bound states. Our far-field analysis relies on Faxen's laws, eqs. (22) and (23), to implicitly carry out the surface integrals that specify the forces and torques that move and reorient the squirmer in proximity to the boundary. However, we will argue here that applying the intuitive arguments encountered in lubrication theory, see section 2.6, gives

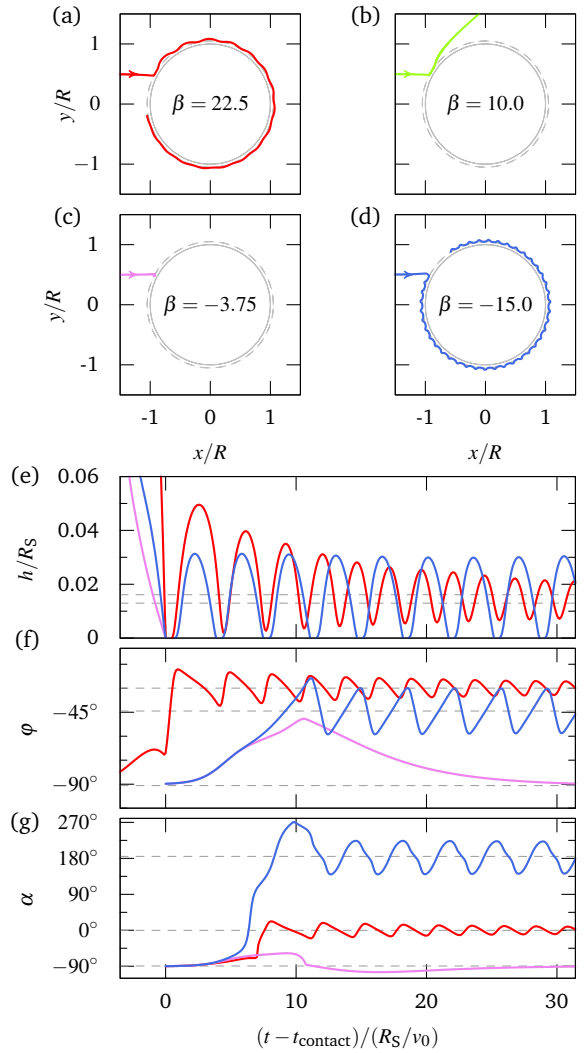

Fig. 4 (a-d) Trajectories for different β , leading to a forward orbit (red, $\beta = 22.5$), scattering (green, $\beta = 10$), a hovering state (violet, $\beta = -3.75$) and a backward orbit (blue, $\beta = -15$). The solid gray circle indicates the position of the obstacle, while the dashed gray circle indicates the closest possible approach. (e) The surface-to-surface gap size h/R_S between squirmer and obstacle over time. The dashed gray lines indicate the long-time mean gap size. (f) The angle φ between the obstacle's surface and the squirmer's orientation vector over time. (g) The angle α between the obstacle's surface and the squirmer's direction of motion over time. The dashed gray lines indicate the long-time mean angle. All calculations used $R = 20R_S$, $y_0 = 0.5R$, $r_{\text{cut}} = 0$. Time t_{contact} is the time at which the squirmer first made contact ($h = r_{\text{cut}}$) with the obstacle.

insight into the origin of the various bound states. Lubrication theory states that the dynamics of the squirmer is governed by the viscous dissipation taking place at the point of closest approach⁴⁵. In the far field, one can expect a dominant contribution to the surface integral to also come from this point, especially for small separation.

Let us now consider the flow generated by the squirmer at the location of the boundary, without accounting for the boundary's presence. Thus, we are considering the *unmodified* (bulk) flow field of the squirmer, evaluated at the point of closest approach. The *unmodified* fluid velocity at this point is provided in fig. 7

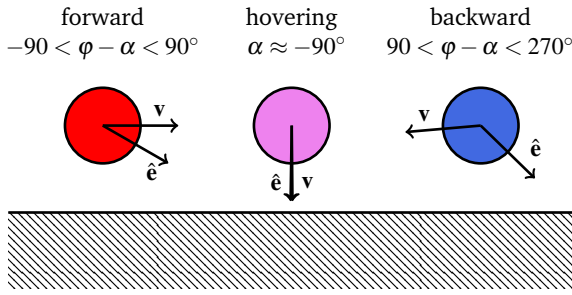

Fig. 5 The bound states correspond to characteristic values of the angles introduced in fig. 2. Forward orbiting/sliding corresponds to \mathbf{v} and $\hat{\mathbf{e}}$ approximately parallel, backward orbiting/sliding to \mathbf{v} and $\hat{\mathbf{e}}$ approximately antiparallel, and hovering is \mathbf{v} pointing approximately perpendicularly into the obstacle. The angles illustrated here correspond to the dashed lines in fig. 4fg.

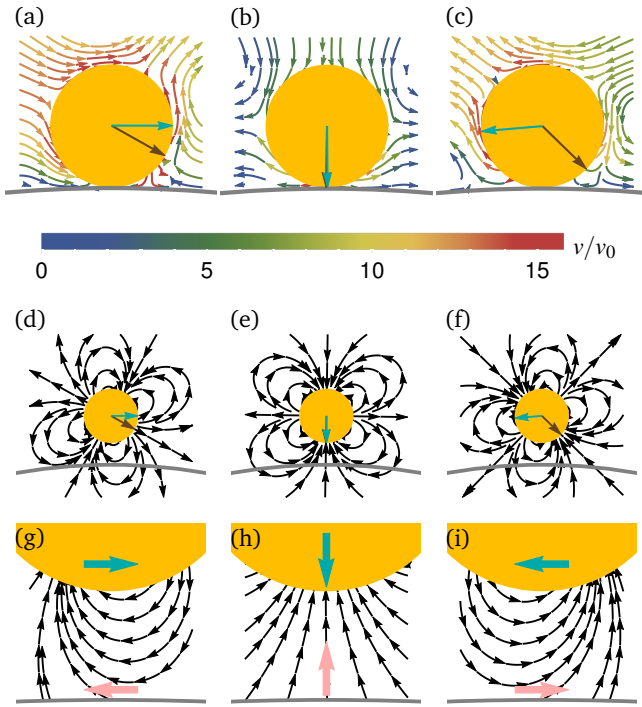

Fig. 6 The flow around the squirmer in the (a) forward (puller), (b) hovering (pusher), and (c) backward (pusher) configurations of fig. 5. The cyan arrow indicates \mathbf{v} , while the brown one marks $\hat{\mathbf{e}}$. The gray line indicates the position of the no-slip wall. (d-f) The same configurations, but showing the bulk flow due to the source quadrupole moment only, where we have not accounted for the boundary condition. (g-i) Zoom-ins on the gap in (d-f), showing that the source quadrupole leads to a flow at the surface (closest point) corresponding to the pink arrow. The closest point dominates the dynamics and to satisfy the boundary condition, the swimmer effectively moves with \mathbf{v} as indicated by the cyan arrow.

which decomposes it into components parallel and perpendicular to the boundary. This figure also shows the separate contributions of the various hydrodynamic modes to the *unmodified* flow field around the squirmer. Clearly, the source quadrupole moment gives rise to the strongest parallel flow in this scenario. The perpendicular components of the force dipole and source quadrupole essentially balance, such that *unmodified* flow ‘into’ the wall is

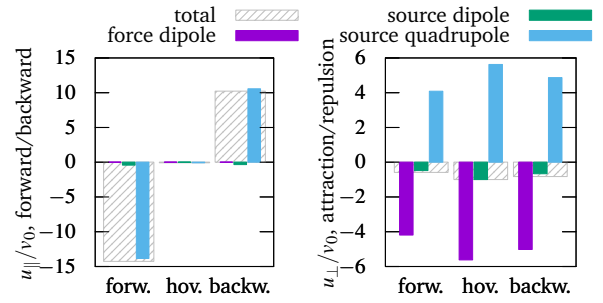

Fig. 7 Histogram showing the relative contributions of the hydrodynamic modes to the motion of the squirmer, as measured by the bulk flow generated at the point closest to the obstacle (not accounting for this boundary, see text). The parallel u_{\parallel} and perpendicular u_{\perp} components of this flow velocity—corresponding to the configurations given in fig. 4—are provided in the left- and right-hand panels, respectively. The colored bars indicate the contributions of the three hydrodynamic modes, while the net effect is provided by the shaded area.

dominated by the source dipole.

The perpendicular component is associated with motion toward/away from the boundary and is thus not of interest here. Focusing on the boundary-parallel contribution and dominant flow of the source quadrupole, we obtain *unmodified* flow fields due to this term as depicted in fig. 6d-f. Zoom-ins on the region of smallest separation are provided in fig. 6g-i, where we should again stress that we only indicate the position of the boundary, but do not account for it in drawing the flow lines. Clearly, the zero-velocity boundary condition is not satisfied. To achieve this condition at the point of closest approach, we can assign a velocity to the swimmer that is equal in magnitude, but oppositely directed. Hence, a forward-moving (fig. 6adg), hovering (fig. 6beh), and backward-moving (fig. 6cfi) state are expected.

The above argument relies on the strong reduction that the dynamics of the squirmer is sufficiently dominated by the point of closest approach, which is only true in the lubrication limit. In addition, we estimate the contribution there through the flow field around a squirmer in bulk fluid. The above explanation should thus be seen as a means to develop some intuition for the behavior of the squirmer, but not as a full proof. Section 4.3 will show that this intuition is, however, accurate, as removal of the source quadrupole term strongly alters the dynamics. Similarly, increasing the separation between the squirmer and boundary sufficiently for longer-ranged hydrodynamic modes to dominate also eliminates the backward-orbiting state. This will be done in section 4.2 by varying the short-range interaction potential.

4 Results

We are now able to use the observations of section 3 to classify trajectories into distinct categories corresponding to the four archetypal trajectories of fig. 4. This allows us to construct state diagrams in parameter space using the efficient far-field method of sections 2.3 to 2.5. To produce two-dimensional β - γ_0 diagrams, r_{cut} and R/R_S are chosen to be constant values. From the data set discussed in the previous section, one can already obtain coarse state diagrams by performing a Voronoi construction⁸² to iden-

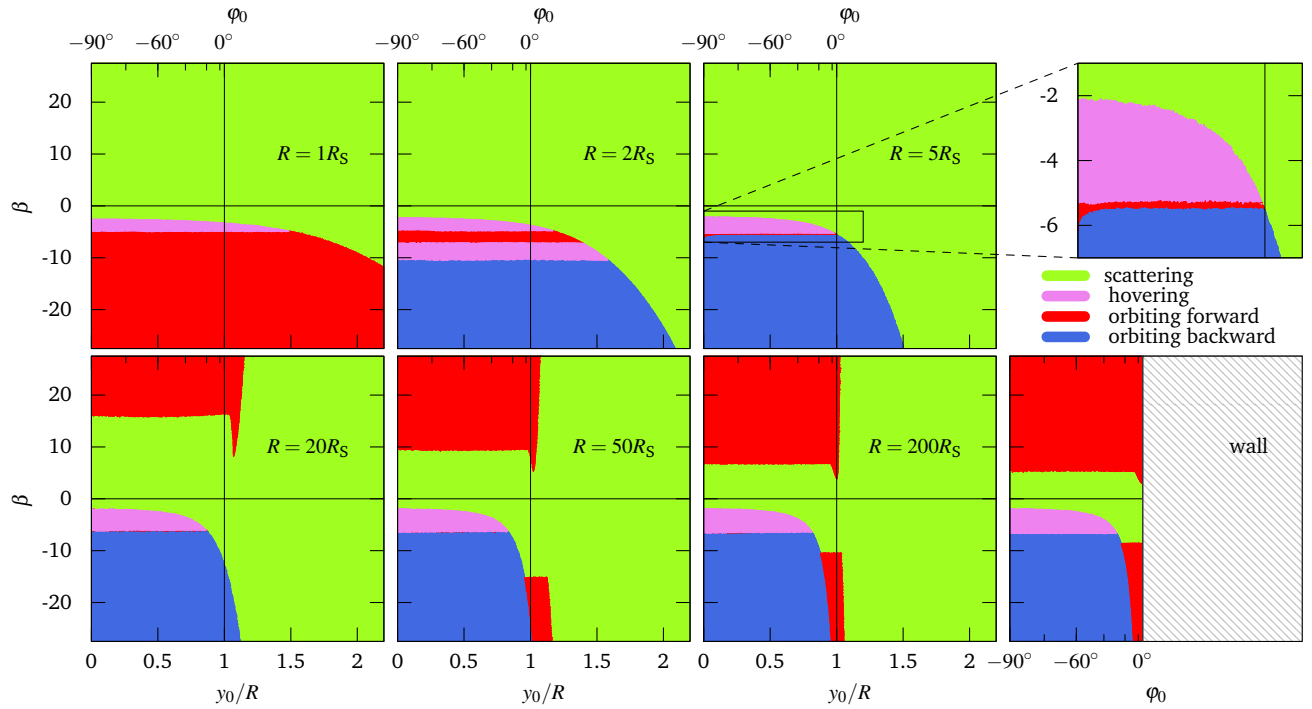

Fig. 8 The influence of obstacle-squirmer size ratio: State diagrams indicating the way the squirmer behavior depends on dipolarity β and initial position y_0 (or equivalently, initial orientation φ_0) with different R and constant $r_{\text{cut}} = 0$. Forward orbits are red, backward orbits blue, hovering is violet and scattering is green, as indicated in the legend and used throughout. The former three (bound) states correspond to specific relative angles of the squirmer's orientation and motion, which are illustrated in fig. 5.

tify polygonal regions in the two-dimensional parameter space. Each of these regions is associated with a (y_0, β) data point and contains all points that are closer to this data point than to any other data point. The entire region is then filled with the color assigned to the behavior observed for the respective data point. We now refine the coarse diagram: One can identify polygon vertices that connect polygons of different color (i.e., that lie on the edge of a state's region). A new calculation is then started at each of the identified vertices. This procedure is repeated until a sufficiently smooth diagram is obtained.

The topology of these state diagrams is roughly as follows. At $y_0 = 0$, only hovering states can be found because the symmetry remains unbroken. For nonzero y_0 , the strongest pushers follow oscillating backward orbits. Decreasing the squirmer strength successively leads to hovering, a forward orbit with decaying oscillation, and another hovering state, before transitioning to scattering near $\beta = 0$. Pullers of sufficient strength again enter into forward orbits with decaying oscillation. Another region of forward orbits is found for strong pushers near $y_0 = R_S$, but with a persistent oscillation. In the rest of this section, we will discuss various influences on the state diagram: (1) the obstacle size, (2) the short-range repulsion, (3) the different hydrodynamic moments, and (4) near-field flow.

4.1 Effects of Obstacle Size

State diagrams for a representative selection of obstacle sizes R and constant $r_{\text{cut}} = 0$ are shown in fig. 8. At the smallest obsta-

cle, $R = R_S$, one observes that strong pushers ($\beta < 0$) enter into forward orbits. The critical value of β below which the squirmer is captured is constant below $y_0 \approx 1.5R$ and decreases beyond this point. Between the orbiting and the scattering states lies a hovering state that also extends to $y_0 \approx 1.5R$.

As R increases, one first observes that the y_0 required to capture the squirmer decreases. Simultaneously, the forward orbits are mostly replaced with backward orbits, though a small region of forward orbiting remains, and for $R \approx 2R_S$ a second hovering region appears, between the backward orbits and the hovering states (see inset in fig. 8). This region of forward orbits quickly shrinks as R increases and corresponds to a set of edge-case trajectories, e.g., ones where the squirmer moves just slightly faster than the criterion we picked to delimit orbiting from hovering.

Further increase of R introduces a forward orbiting state for strong pullers ($\beta > 0$); the critical β that separates these forward orbits from scattering is independent of y_0 for $y_0 < R$ and decreases as R increases. Furthermore, at $y_0 \approx R$, the forward orbiting state extends significantly into the scattering state's region. This peninsula of red in fig. 8 appears because the squirmer approaches the obstacle in such a way that no hydrodynamic re-orientation is required to swing into orbit.

Finally, one observes a second forward orbiting state that develops for strong pushers. This one is near $y_0 \approx R$, unlike the other states, which can be entered at $y_0 \approx 0$. At $R = 200$, the state diagram is already almost indistinguishable from the case for a flat wall ($R \rightarrow \infty$). In the latter case, y_0 becomes meaningless and

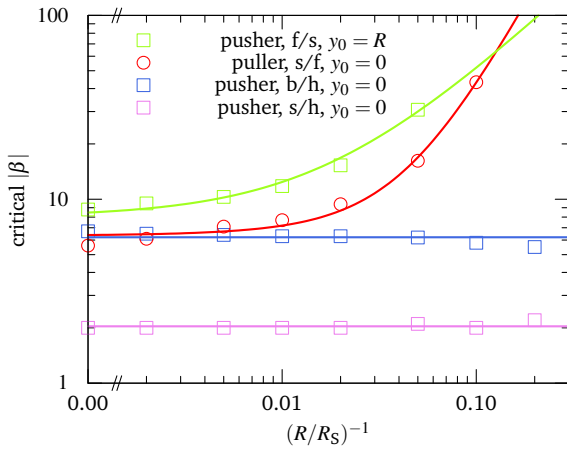

Fig. 9 From fig. 8 we can extract critical values of β that mark the transition from one state to another. Blue is the transition between backward orbiting (b) and hovering (h), violet is the transition between hovering and scattering (s), and red is the transition between hovering and forward orbiting (f), all near $y_0 = 0$. Green is the transition from forward orbiting to scattering near $y_0 = R$. The error bars are comparable to the symbol size and result from the finite size of the regions produced by the Voronoi construction and also from the slightly diffuse transition regions (see the inset of fig. 8).

is replaced by φ_0 , which is a well-defined quantity even for finite radii, but cannot describe $y_0 > R$.

In fig. 9, we have extracted the position of the critical values of β for the transitions observed in fig. 8. The transitions from scattering to hovering and from hovering to backward orbiting are nearly independent of β . The transition between scattering and forward orbiting happens at $\beta \propto R^{-2}$ for pullers at $y_0 \approx 0$ and at $\beta \propto -R^{-1}$ for pushers at $y_0 \approx R$. This scaling disagrees with Spagnolie *et al.*'s prediction²³ for the pusher, $\beta \propto -R^{-1/2}$, but as discussed in section 4.3, the deviation is fully explained by a modeling difference.

4.2 Effects of Short-Range Repulsion

Thus far, we have assumed $r_{\text{cut}} = 0$, letting the squirmer and obstacle touch. However, realistic swimmers typically repel each other and from obstacles at short distances⁴⁵, e.g., due to electrostatics²², phoretic interactions⁵⁵, or near-field hydrodynamics²². To study this effect, we pick $R = 20R_S$, where the state diagram contains all the features seen at other obstacle radii. We then construct iteratively refined Voronoi diagrams for $r_{\text{cut}}/R_S \in \{0, 0.01, 0.1, 0.2\}$ in fig. 10.

Making the step from $r_{\text{cut}} = 0$ to $r_{\text{cut}} = 0.01R_S$ introduces an additional length scale into the problem. Despite the small absolute magnitude of this r_{cut} , this leads to the appearance of the transition from scattering to a forward orbit for pushers near $y_0 = R$. While one cannot see this forward orbiting state in the diagram for $r_{\text{cut}} = 0$, it is expected at $\beta \approx -40$ per fig. 9 and visible in fig. 8 for larger R . Increasing r_{cut} further moves both transitions between scattering and forward orbits to smaller $|\beta|$. At $r_{\text{cut}} = 0.1R_S$, the hovering state has vanished completely. At $r_{\text{cut}} = 0.2R_S$, the backward orbiting state has vanished too and is replaced by forward orbits, which have now extended to smaller y_0 .

The disappearance of the hovering state at relatively moderate short-range repulsion is again in line with our attribution of the observations to the quadrupole term, which at small β can only dominate for the smallest gap sizes. Even $r_{\text{cut}} = 0.2R_S$ is sometimes a realistic model for short-range repulsion, for example for chemical nanoswimmers with extended electric double layers^{34,83}. This could explain why backward orbits are not encountered more commonly in experiment and theory.

4.3 Effects of Higher-Order Hydrodynamic Modes

In the previous section, we have already observed that backward orbits and hovering are very much dependent on near-field interactions. This even goes to the extent that backward orbits are completely suppressed if squirmer and obstacle are kept sufficiently far apart. The results suggests that one of the higher hydrodynamic modes in eq. (5) causes this behavior, since they dominate the flow only on short distances. We perform two additional far-field calculations to quantify this effect: (i) one that drops the source quadrupole from eqs. (15), (19) and (20) but is otherwise identical to the method described in section 2, and (ii) one that furthermore drops the squirmer's source dipole, leaving only the force dipole flow and moving the squirmer directly via v_0 .

Again, we pick $R = 20R_S$ and $r_{\text{cut}} = 0$ and obtain the state diagram in fig. 11. One can see that the lack of a quadrupole term replaces the backward orbits and hovering states with forward orbits. It also converts the forward orbits into a hovering state down to much smaller β . Further dropping the source dipole allows for direct comparison with Spagnolie *et al.*²³, who predict the position of the transition: They suggest that pushers orbit for $\beta < -\sqrt{1024R_S/81R}$ as long as $y_0 < 0.86\beta^{2/5}(R/R_S)^{1/5} + R/R_S$, while they see pullers hovering for $\beta > 32R_S/9R$. We reproduce these predictions quite well as seen in fig. 11. The remaining deviation is consistent with Ref. 23, where the critical $|\beta|$ is found to be slightly larger than predicted. Furthermore there is a slight difference in modeling, namely that Spagnolie *et al.* do not include the swimmer's finite R_S in eq. (22).

4.4 Accounting for the Near Field

Finally, we come to the results obtained using our LB calculations, see section 2.7. These are computationally much more involved and we were therefore only able to sample a few points to verify the general trends of our far-field prediction. We restrict ourselves to $R/R_S \in \{2, 5, 20\}$ and a few values of β and y_0 . The state diagram in fig. 12 shows that scattering is generally more prevalent than in the previous far-field-only calculations. Backward orbits are still observed, but their critical dipolarity increases more rapidly with decreasing curvature. Forward orbits, which in the far field are primarily predicted for pullers, are now found in the case of sufficiently strong pushers when the obstacle size is large enough. Hovering states are possible for both pushers and pullers of sufficient strength, whenever the curvature is low.

These observations confirm that all four states found in the far-field model are indeed allowed by the near-field flow. Most notably, backward orbits of strong pushers appear in both far-field

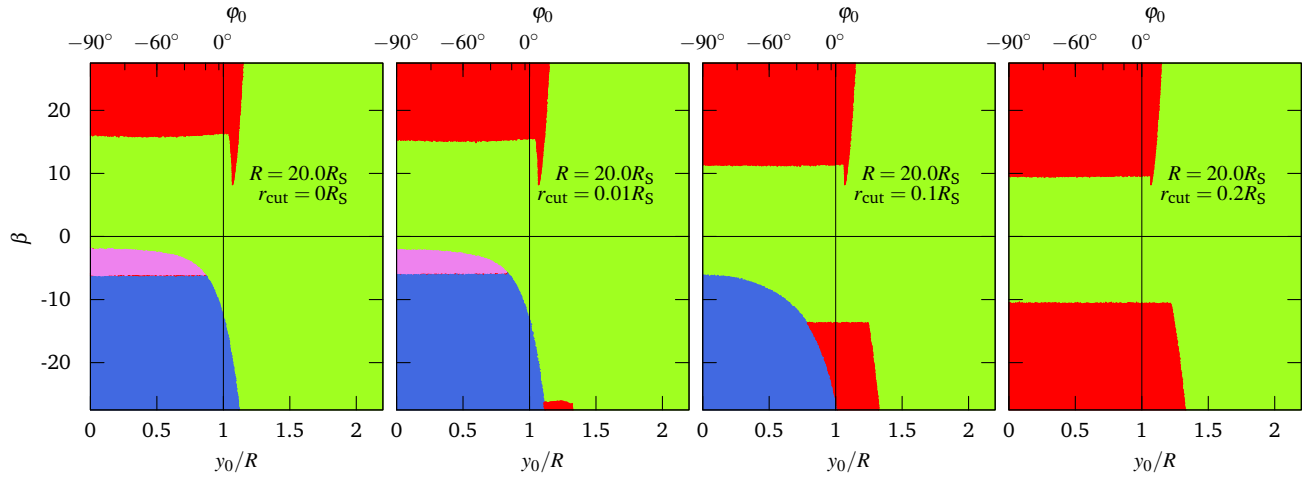

Fig. 10 The influence of non-hydrodynamic interactions: State diagrams of the squirmer-obstacle interaction with color coding as in fig. 8. The dipolarity β and initial position y_0 (or equivalently, initial orientation φ_0) are varied at constant $R = 20R_S$. From left to right we increase the short-range repulsion, $r_{\text{cut}} = 0, 0.01, 0.1,$ and $0.2R_S$.

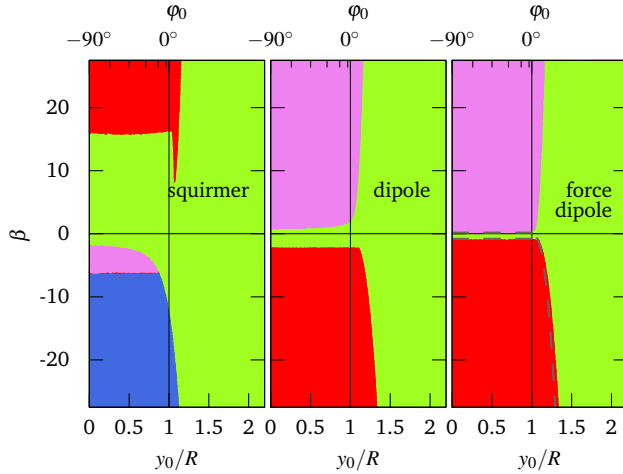

Fig. 11 The influence of higher-order hydrodynamic moments: State diagrams of the squirmer-obstacle interaction with color coding as in fig. 8. The obstacle radius is maintained at $R = 20R_S$, while the dipolarity β and initial position y_0 (or equivalently, initial orientation φ_0) are varied. From left to right we consider different hydrodynamic models: squirmer, force and source dipole, and force dipole. The gray dashed lines in the right panel indicate the position of the transition as predicted by Ref. 23.

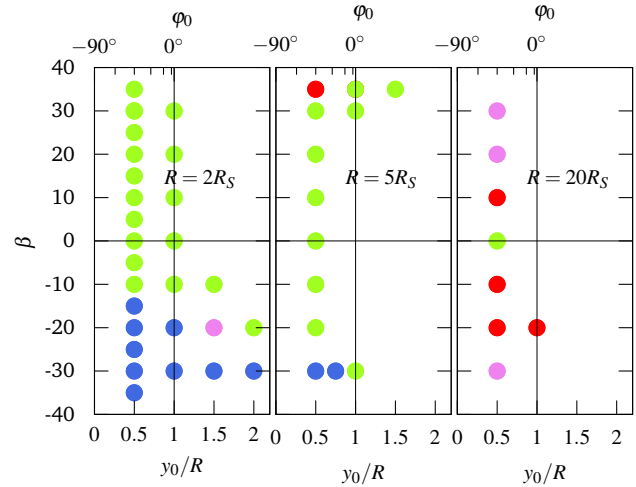

Fig. 12 The influence of near-field hydrodynamics: State diagrams obtained via the LB method indicate the interaction between the squirmer and obstacle as a function of dipolarity β and initial position y_0 (or equivalently, initial orientation φ_0); the color coding is as in fig. 8. From left to right three values of $R = 2, 5,$ and $20R_S$ are considered. Compare to fig. 8 to see the differences caused by the near field.

and LB models. However, agreement with the far-field model and with lubrication theory is only obtained to a certain degree, as expected. The observed rapid decrease of β with R for backward orbiting places the backward sliding state ($R \rightarrow \infty$) outside the capabilities of our LB calculations.

5 Conclusion

We have employed three hydrodynamic methods to investigate the behavior of a squirmer near a spherical obstacle or a flat wall. Our primary results are derived using a simple far-field approximation, which lends itself to an efficient exploration of parameter space. Depending on the squirmer dipolarity, incidence angle, obstacle curvature, and short-range repulsion, this revealed four classes of trajectories: scattering, forward orbits, backward orbits,

and hovering. Three of these trajectory classes have been previously reported, but the backward orbits constitute a new class that appears only for strong pushers.

Using the far-field approximation allowed us to construct state diagrams that cover the entire parameter space. We obtained all four classes for reasonable dipolarity parameters whenever the squirmer size is less than roughly half the size of the obstacle. Comparison to calculations that exclude the squirmer's quadrupole term reconcile our results with those of Spagnolie *et al.*²³. This clearly attributes hovering and backward orbiting to the quadrupole. Thus, accounting for the finite size of the swimmer in the hydrodynamic multipole expansion introduces a richer behavior.

We also computed trajectories for several parameter sets us-

ing the LB method to investigate whether the reported far-field behaviors persist even when taking into account near-field details. While the exact positions of the transition between classes are altered, the qualitative behavior stays the same. Most importantly, we reproduce the predicted backward orbiting for the strong pushers in these calculations, showing that this effect is not an artifact of our approximation.

Our results indicate a mechanism of mobility reversal with respect to the bulk that is exclusively due to the hydrodynamic interaction of a swimmer with a surface. However, biological or artificial swimmers may additionally interact chemically or electrostatically with surfaces. Simple mappings of chemical swimmers onto a squirmer^{53–55} are known not to qualitatively capture their behavior at small separation^{54,55}. Thus, such effects need to be accounted for in unison with the hydrodynamics. The present theory and LB calculations provide a stepping stone toward analysis of (electro)chemical contributions to the orbiting of artificial swimmers.

Conflicts of interest

There are no conflicts to declare.

Acknowledgements

We acknowledge the Deutsche Forschungsgemeinschaft (DFG) for funding through the SPP 1726 “Microswimmers: from single particle motion to collective behavior” (HO1108/24-2). JdG further acknowledges funding through the NWO START-UP grant (740.018.013). Computational resources were provided by the state of Baden-Württemberg through bwHPC and by the DFG through grant INST 35/1134-1 FUGG. We are grateful to Alexander Chamolly and Will Uspal for useful discussions.

Research Data

The numerical code and analysis scripts used to obtain the data presented in this publication is available at <https://doi.org/10.24416/UU01-BMGD4E>, along with a representative subset of the data.

References

- 1 D. Woolley, *Reproduction*, 2003, **126**, 259.
- 2 B. M. Friedrich, I. H. Riedel-Kruse, J. Howard and F. Jülicher, *J. Exp. Biol.*, 2010, **213**, 1226–1234.
- 3 A. Bukatin, I. Kukhtevich, N. Stoop, J. Dunkel and V. Kantsler, *Proc. Natl. Acad. Sci.*, 2015, **112**, 15904–15909.
- 4 H. C. Berg and L. Turner, *Biophys. J.*, 1990, **58**, 919–930.
- 5 E. Lauga, W. R. DiLuzio, G. M. Whitesides and H. A. Stone, *Biophys. J.*, 2006, **90**, 400–412.
- 6 E. Lauga and T. R. Powers, *Rep. Prog. Phys.*, 2009, **72**, 096601.
- 7 J. Elgeti, U. B. Kaupp and G. Gompper, *Biophys. J.*, 2010, **99**, 1018–1026.
- 8 H. Gadêlha, E. Gaffney, D. Smith and J. Kirkman-Brown, *J. Royal Soc. Interface*, 2010, **7**, 1689–1697.
- 9 D. Giacché, T. Ishikawa and T. Yamaguchi, *Phys. Rev. E*, 2010, **82**, 056309.
- 10 L. Alvarez, B. M. Friedrich, G. Gompper and U. B. Kaupp, *Trends Cell Biol.*, 2014, **24**, 198–207.
- 11 C. Bechinger, R. D. Leonardo, H. Löwen, C. Reichhardt, G. Volpe and G. Volpe, *Rev. Mod. Phys.*, 2016, **88**, 045006.
- 12 G. Saggiorato, L. Alvarez, J. F. Jikeli, U. B. Kaupp, G. Gompper and J. Elgeti, *Nat. Commun.*, 2017, **8**, 1415.
- 13 W. F. Paxton, K. C. Kistler, C. C. Olmeda, A. Sen, S. K. St. Angelo, Y. Cao, T. E. Mallouk, P. E. Lammert and V. H. Crespi, *J. Am. Chem. Soc.*, 2004, **126**, 13424–13431.
- 14 J. R. Howse, R. A. Jones, A. J. Ryan, T. Gough, R. Vafabakhsh and R. Golestanian, *Phys. Rev. Lett.*, 2007, **99**, 048102.
- 15 G. Volpe, I. Buttinoni, D. Vogt, H.-J. Kümmerer and C. Bechinger, *Soft Matter*, 2011, **7**, 8810–8815.
- 16 D. Takagi, J. Palacci, A. B. Braunschweig, M. J. Shelley and J. Zhang, *Soft Matter*, 2014, **10**, 1784–1789.
- 17 S. Das, A. Garg, A. Campbell, J. Howse, A. Sen, D. Velegol, R. Golestanian and S. Ebbens, *Nat. Commun.*, 2015, **6**, 8999.
- 18 A. T. Brown, I. D. Vladescu, A. Dawson, T. Vissers, J. Schwarz-Linek, J. S. Lintuvuori and W. C. K. Poon, *Soft Matter*, 2016, **12**, 131–140.
- 19 J. Simmchen, J. Katuri, W. E. Uspal, M. N. Popescu, M. Tasinkevych and S. Sánchez, *Nat. Commun.*, 2016, **7**, 10598.
- 20 B. Felderhof, *Phys. A Stat. Mech. Appl.*, 1977, **89**, 373–384.
- 21 I. Llopis and I. Pagonabarraga, *J. Non-Newtonian Fluid Mech.*, 2010, **165**, 946–952.
- 22 S. E. Spagnolie and E. Lauga, *J. Fluid Mech.*, 2012, **700**, 105–147.
- 23 S. E. Spagnolie, G. R. Moreno-Flores, D. Bartolo and E. Lauga, *Soft Matter*, 2015, **11**, 3396–3411.
- 24 M. N. Popescu, S. Dietrich and G. Oshanin, *J. Chem. Phys.*, 2009, **130**, 194702.
- 25 W. E. Uspal, M. N. Popescu, S. Dietrich and M. Tasinkevych, *Soft Matter*, 2015, **11**, 434–438.
- 26 A. Mozaffari, N. Sharifi-Mood, J. Koplik and C. Maldarelli, *Phys. Fluids*, 2016, **28**, 053107.
- 27 J. L. Anderson, *Annu. Rev. Fluid Mech.*, 1989, **21**, 61–99.
- 28 R. Golestanian, T. B. Liverpool and A. Ajdari, *Phys. Rev. Lett.*, 2005, **94**, 220801.
- 29 Y. Wang, R. M. Hernandez, D. J. Bartlett, J. M. Bingham, T. R. Kline, A. Sen and T. E. Mallouk, *Langmuir*, 2006, **22**, 10451–10456.
- 30 R. Golestanian, T. Liverpool and A. Ajdari, *New J. Phys.*, 2007, **9**, 126.
- 31 M. N. Popescu, S. Dietrich, M. Tasinkevych and J. Ralston, *Eur. Phys. J. E*, 2010, **31**, 351–367.
- 32 J. L. Moran and J. D. Posner, *J. Fluid Mech.*, 2011, **680**, 31–66.
- 33 S. Ebbens, M.-H. Tu, J. R. Howse and R. Golestanian, *Phys. Rev. E*, 2012, **85**, 020401.
- 34 A. T. Brown and W. C. K. Poon, *Soft Matter*, 2014, **10**, 4016–4027.
- 35 A. T. Brown, W. C. K. Poon, C. Holm and J. de Graaf, *Soft Matter*, 2017, **13**, 1200–1222.

- 36 A. I. Campbell, S. J. Ebbens, P. Illien and R. Golestanian, *arXiv preprint arXiv:1802.04600*, 2018.
- 37 J. Hu, A. Wysocki, R. G. Winkler and G. Gompper, *Sci. Rep.*, 2015, **5**, 9586.
- 38 W. E. Uspal, M. N. Popescu, S. Dietrich and M. Tasinkevych, *Phys. Rev. Lett.*, 2016, **117**, 048002.
- 39 H. Ceylan, I. C. Yasa and M. Sitti, *Adv. Mater.*, 2017, **29**, 1605072.
- 40 M. N. Popescu, W. E. Uspal and S. Dietrich, *J. Phys. Condens. Matter*, 2017, **29**, 134001.
- 41 W. E. Uspal, M. N. Popescu, M. Tasinkevych and S. Dietrich, *New J. Phys.*, 2018, **20**, 015013.
- 42 A. Chamolly, T. Ishikawa and E. Lauga, *New J. Phys.*, 2017, **19**, 115001.
- 43 H. Faxén, *Ark. Mat. Astron. Fys.*, 1922, **17**, 1.
- 44 H. Brenner, *Chem. Eng. Sci.*, 1964, **19**, 703–727.
- 45 J. S. Lintuvuori, A. T. Brown, K. Stratford and D. Marenduzzo, *Soft Matter*, 2016, **12**, 7959–7968.
- 46 Z. Shen, A. Würger and J. S. Lintuvuori, *Eur. Phys. J. E*, 2018, **41**, 39.
- 47 K. Ishimoto and E. A. Gaffney, *Phys. Rev. E*, 2013, **88**, 062702.
- 48 K. Schaar, A. Zöttl and H. Stark, *Phys. Rev. Lett.*, 2015, **115**, 038101.
- 49 G. R. McNamara and G. Zanetti, *Phys. Rev. Lett.*, 1988, **61**, 2332–2335.
- 50 F. Higuera, S. Succi and R. Benzi, *Europhys. Lett.*, 1989, **9**, 345.
- 51 A. J. C. Ladd, *J. Fluid Mech.*, 1994, **271**, 285–309.
- 52 T. Krüger, H. Kusumaatmaja, A. Kuzmin, O. Shardt, G. Silva and E. M. Viggien, *The Lattice Boltzmann Method: Principles and Practice*, Springer, Cham, 2017.
- 53 S. Michelin and E. Lauga, *J. Fluid Mech.*, 2014, **747**, 572–604.
- 54 Y. Ibrahim and T. B. Liverpool, *Eur. Phys. J. Special Top.*, 2016, **225**, 1843–1874.
- 55 M. N. Popescu, W. E. Uspal, Z. Eskandari, M. Tasinkevych and S. Dietrich, *Eur. Phys. J. E*, 2018, **41**, 145.
- 56 T. Ishikawa, *J. Royal Soc. Interface*, 2009, **6**, 815–834.
- 57 A. J. Mathijssen, D. O. Pushkin and J. M. Yeomans, *J. Fluid Mech.*, 2015, **773**, 498–519.
- 58 J. de Graaf and J. Stenhammar, *Phys. Rev. E*, 2017, **95**, 023302.
- 59 M. Lighthill, *Commun. Pure Appl. Math.*, 1952, **5**, 109–118.
- 60 J. Blake, *J. Fluid Mech.*, 1971, **46**, 199–208.
- 61 T. Ishikawa, M. Simmonds and T. Pedley, *J. Fluid Mech.*, 2006, **568**, 119–160.
- 62 K. Drescher, J. Dunkel, L. Cisneros, S. Ganguly and R. Goldstein, *Proc. Natl. Acad. Sci.*, 2011, **108**, 10940.
- 63 K. Drescher, R. Goldstein, N. Michel, M. Polin and I. Tuval, *Phys. Rev. Lett.*, 2010, **105**, 168101.
- 64 T. Ishikawa and M. Hota, *J. Exp. Biol.*, 2006, **209**, 4452–4463.
- 65 G. G. Stokes, *Trans. Camb. Philos. Soc.*, 1851, **9**, 8.
- 66 A. T. Chwang and T. Y.-T. Wu, *J. Fluid Mech.*, 1975, **67**, 787–815.
- 67 C. Pozrikidis, *Boundary integral and singularity methods for linearized viscous flow*, Cambridge University Press, 1992.
- 68 J. Blake, *Math. Proc. Camb. Philos. Soc.*, 1971, **70**, 303–310.
- 69 Y. von Hansen, M. Hinczewski and R. R. Netz, *J. Chem. Phys.*, 2011, **134**, 235102.
- 70 C. W. Oseen, *Neuere Methoden und Ergebnisse in der Hydrodynamik*, Akademische Verlagsgesellschaft, Leipzig, 1927.
- 71 G. Batchelor and J. Green, *J. Fluid Mech.*, 1972, **56**, 375–400.
- 72 L. Durlofsky, J. F. Brady and G. Bossis, *J. Fluid Mech.*, 1987, **180**, 21–49.
- 73 M. Puljiz and A. M. Menzel, *Phys. Rev. E*, 2019, **99**, 053002.
- 74 A. J. Goldman, R. G. Cox and H. Brenner, *Chem. Eng. Sci.*, 1967, **22**, 637–651.
- 75 B. Cichocki and R. Jones, *Phys. A Stat. Mech. Appl.*, 1998, **258**, 273–302.
- 76 C. Godenschwager, F. Schornbaum, M. Bauer, H. Köstler and U. Rüde, Proceedings of the International Conference on High Performance Computing, Networking, Storage and Analysis, 2013, p. 35.
- 77 C. Rettinger and U. Rüde, *Comput. Fluids*, 2017, **154**, 74–89.
- 78 M. Kuron, P. Stärk, C. Burkard, J. de Graaf and C. Holm, *J. Chem. Phys.*, 2019, **150**, 144110.
- 79 N.-Q. Nguyen and A. Ladd, *Phys. Rev. E*, 2002, **66**, 046708.
- 80 T. Ishikawa, J. Locsei and T. Pedley, *J. Fluid Mech.*, 2008, **615**, 401–431.
- 81 J. D. Weeks, D. Chandler and H. C. Andersen, *J. Chem. Phys.*, 1971, **54**, 5237.
- 82 F. Aurenhammer, *ACM Comput. Surv.*, 1991, **23**, 345–405.
- 83 T.-C. Lee, M. Alarcón-Correa, C. Miksch, K. Hahn, J. G. Gibbs and P. Fischer, *Nano Lett.*, 2014, **14**, 2407–2412.

A Hydrodynamic Reflection at a Sphere

In this appendix we reproduce the reflection flow field of a Stokeslet near a spherical obstacle with a no-slip boundary condition (eq. (16)) located at the origin^{23,70}. The Stokeslet flow (eq. (8)) originates at \mathbf{r}_S such that the image tensor is given by

$$\mathcal{R}\mathcal{M}(\mathbf{r}, \mathbf{r}_S) = -\frac{R}{r_S s_*} \mathbb{1} - \frac{R^3}{r_S^3 s_*^3} \mathbf{s}_* \otimes \mathbf{s}_* - (r^2 - R^2) \Phi$$

$$-\frac{r_S^2 - R^2}{r_S} \left(\frac{1}{R^3 s_*} \mathbf{r}_* \otimes \mathbf{r}_* - \frac{R}{r_S^2 s_*^3} (\mathbf{r}_* \otimes \mathbf{s}_* + \mathbf{s}_* \otimes \mathbf{r}_*) + \frac{2\mathbf{r}_* \cdot \mathbf{s}_*}{R^3 s_*^3} \mathbf{r}_* \otimes \mathbf{r}_* \right), \quad (31)$$

with

$$\begin{aligned} \Phi = & \frac{r_S^2 - R^2}{2r_S^3} \left[-\frac{3}{R s_*^3} \mathbf{s}_* \otimes \mathbf{r}_S + \frac{R}{s_*^3} \mathbb{1} - \frac{3R}{s_*^5} \mathbf{s}_* \otimes \mathbf{s}_* - \frac{2}{R s_*^3} \mathbf{r}_* \otimes \mathbf{r}_S + \frac{6\mathbf{r}_* \cdot \mathbf{s}_*}{R s_*^5} \mathbf{s}_* \otimes \mathbf{r}_S \right. \\ & + \frac{3R}{s_* r_* + \mathbf{r} \cdot \mathbf{r}_* - r_*^2} \left(\frac{1}{r_*^2 s_*} \mathbf{s}_* \otimes \mathbf{r}_* + \frac{1}{s_*^3} \mathbf{s}_* \otimes \mathbf{s}_* + \frac{s_* - r_*}{r_* s_*} \mathbb{1} \right) \\ & - \frac{3R}{r_*^2 s_*^2 (s_* r_* + \mathbf{r} \cdot \mathbf{r}_* - r_*^2)^2} \left((r_* \mathbf{s}_* + s_* \mathbf{r}_*) \otimes (s_* \mathbf{r}_S - r_*^2 \mathbf{s}_* + s_* r_* (\mathbf{r} - 2\mathbf{r}_*)) \right) \\ & \left. - \frac{3R}{r_*^2 r (r r_* + \mathbf{r} \cdot \mathbf{r}_*)} (\mathbf{r} \otimes \mathbf{r}_* + r r_* \mathbb{1}) + \frac{3R}{r_*^2 r (r r_* + \mathbf{r} \cdot \mathbf{r}_*)^2} (r_* \mathbf{r} + r \mathbf{r}_*) \otimes (r_* \mathbf{r} + r \mathbf{r}_*) \right], \quad (32) \end{aligned}$$

where the variables $\mathbf{r}_* = (R^2/r_S^2)\mathbf{r}_S$ and $\mathbf{s}_* = \mathbf{r} - \mathbf{r}_*$ have been introduced. For the limiting case of a flat wall ($R \rightarrow \infty$), the for-

mer has the geometric interpretation of the location of the image Stokeslet.