

Figure 1: Axes of the HCL color space. Top: Hue H changes from 0 (red) via 75 (yellow), etc. to 300 (purple) with fixed $C = 60$ and $L = 65$. Center: Chroma C changes from 0 (gray) to 100 (colorful) with fixed $H = 0$ (red) and $L = 65$. Bottom: Luminance L changes from 95 (light) to 15 (dark) with fixed $H = 260$ (blue) and $C = 25$ (low, close to gray).

To address these problems, many improved color palettes with better perceptual properties have been receiving increasing attention in the literature (Harower and Brewer 2003; Zeileis, Hornik, and Murrell 2009; Smith and Van der Walt 2015; CARTO 2019; Crameri 2018). Many systems for systems for statistical and scientific computing provide infrastructure for such color palettes, e.g., for R (R Core Team 2018) the list of useful packages encompasses: **RColorBrewer** (Neuwirth 2014), **viridis** (Garnier 2018), **rcartocolor** (Nowosad 2018), **wesanderson** (Ram and Wickham 2018), or **scico** (Pedersen and Crameri 2018) among many others. Furthermore, packages like **pals** (Wright 2018) and **paletteer** (Hvitfeldt 2019) collect many of the proposed palettes in combination with a unified interface. Most of these palettes, however, are pre-existing palettes, stored as a limited set of colors and interpolated as necessary. And even if specific algorithms have been used in the initial construction of the palettes, these are often not reflected in the software implementations.

The **colorspace** package (Ihaka *et al.* 2019) adopts a somewhat different approach that gives the user direct access to the construction principles underlying its palettes. These are based on simple trajectories in the perceptually-based HCL (Hue–Chroma–Luminance) color space (Wikipedia 2019e) whose axes match those of the human visual system very well: Hue (= type of color, dominant wavelength), chroma (= colorfulness), luminance (= brightness), see Figure 1. Thus, utilizing this color model the **colorspace** package can derive general and adaptable strategies for color palettes; manipulate individual colors and color palettes; and assess and visualize the properties of color palettes (beyond simple color swatches). Specifically, **colorspace** provides three types of palettes based on the HCL model:

- *Qualitative*: Designed for coding categorical information, i.e., where no particular ordering of categories is available and every color should receive the same perceptual weight. Function: `qualitative_hcl()`.
- *Sequential*: Designed for coding ordered/numeric information, i.e., where colors go from high to low (or vice versa). Function: `sequential_hcl()`.
- *Diverging*: Designed for coding ordered/numeric information around a central neutral value, i.e., where colors diverge from neutral to two extremes. Function: `diverging_hcl()`.

A broad collection of prespecified palettes are shipped in the package. In addition, existing palettes can be easily tweaked and new or adapted palettes registered. The prespecified

palettes include suitable HCL color choices that closely approximate of most palettes from packages **RColorBrewer**, **rcartocolor**, and **viridis** by using only a small set of hue, chroma, and luminance parameters.

To aid choice and application of these palettes the package provides (a) scales for use with **ggplot2** (Wickham 2016), (b) **shiny** (Chang, Cheng, Allaire, Xie, and McPherson 2018) and **tcltk** (R Core Team 2018) apps for interactive exploration, (c) visualizations of palette properties, and (d) accompanying manipulation utilities (like desaturation, lighten/darken, and emulation of color vision deficiencies).

The remainder of the manuscript is organized as follows: Section 2 gives a first overview of the package’s “look & feel” and the general workflow. Section 3 summarizes the S4 color space classes and methods in the package. Section 4 introduces the extensible collection of HCL-based palettes along with their construction details. Section 5 presents the toolbox for palette visualization and assessment. Section 6 discusses the implemented techniques for color vision deficiency emulation that help assess the suitability of colors for colorblind viewers. Section 7 briefly highlights the interactive color apps from the package. Finally, some further color manipulation utilities are highlighted in Section 8 before Section 9 concludes the manuscript.

2. A quick tour

The stable release version of **colorspace** is hosted on the Comprehensive R Archive Network (CRAN) at <https://CRAN.R-project.org/package=colorspace> and the development version of **colorspace** is hosted on R-Forge at <https://R-Forge.R-project.org/projects/colorspace/>.

2.1. Choosing HCL-based color palettes

The **colorspace** package ships with a wide range of predefined color palettes, specified through suitable trajectories in the HCL (Hue-Chroma-Luminance) color space. A quick overview can be gained easily with the `hcl_palettes()` function (see Figure 2):

```
R> library("colorspace")
R> hcl_palettes(plot = TRUE)
```

A suitable vector of colors can be easily computed by specifying the desired number of colors and the palette name (see Figure 2 for possible palette names), e.g.,

```
R> q4 <- qualitative_hcl(4, palette = "Dark 3")
R> q4
```

```
[1] "#E16A86" "#909800" "#00AD9A" "#9183E6"
```

The functions `sequential_hcl()`, and `diverging_hcl()` work analogously. Additionally, a palette’s hue/chroma/luminance parameters can be modified, thus allowing for easy customization of each palette. Moreover, the `choose_palette()/hclwizard()` app provides convenient user interfaces to perform palette customization interactively. Finally, even more flexible diverging HCL palettes are provided by `divergingx_hcl()`.

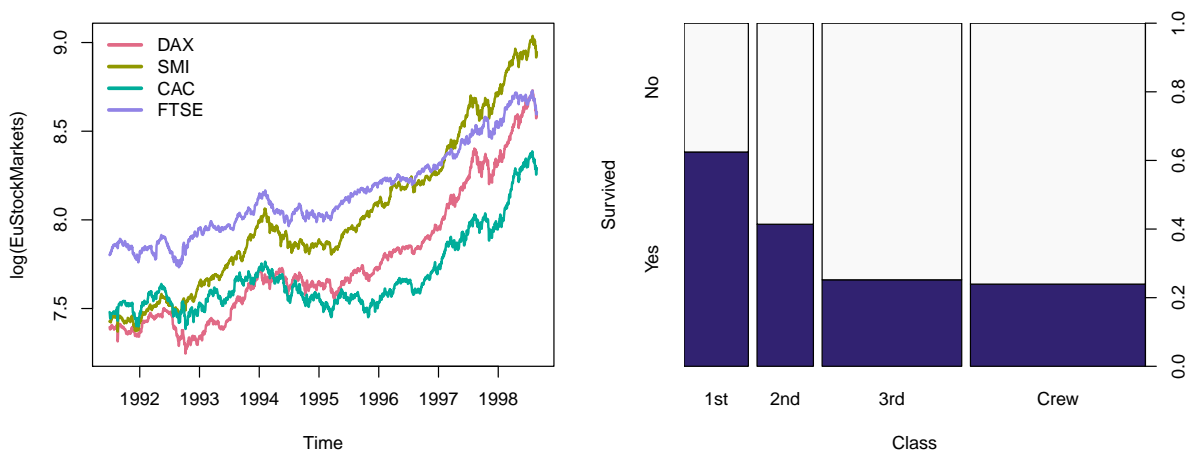
Figure 2: Brief overview of available predefined palettes in `colorspace`.Figure 3: Using `colorspace` with base R graphics. Left: Time series plot of log-prices from `EuStockMarkets` data with `qualitative_hcl(4, "Dark 3")` palette. Right: Spine plot with survival proportions across passenger classes in the `titanic` data with `sequential_hcl(2, "Purples 3")` palette.

2.2. Usage with base graphics

The color vectors returned by the HCL palette functions can usually be passed directly to most base graphics function, typically through the `col` argument. Here, the `q4` vector created above is used in a time series display (see the left panel of Figure 3):

```
R> plot(log(EuStockMarkets), plot.type = "single", col = q4, lwd = 2)
R> legend("topleft", colnames(EuStockMarkets), col = q4, lwd = 3, bty = "n")
```

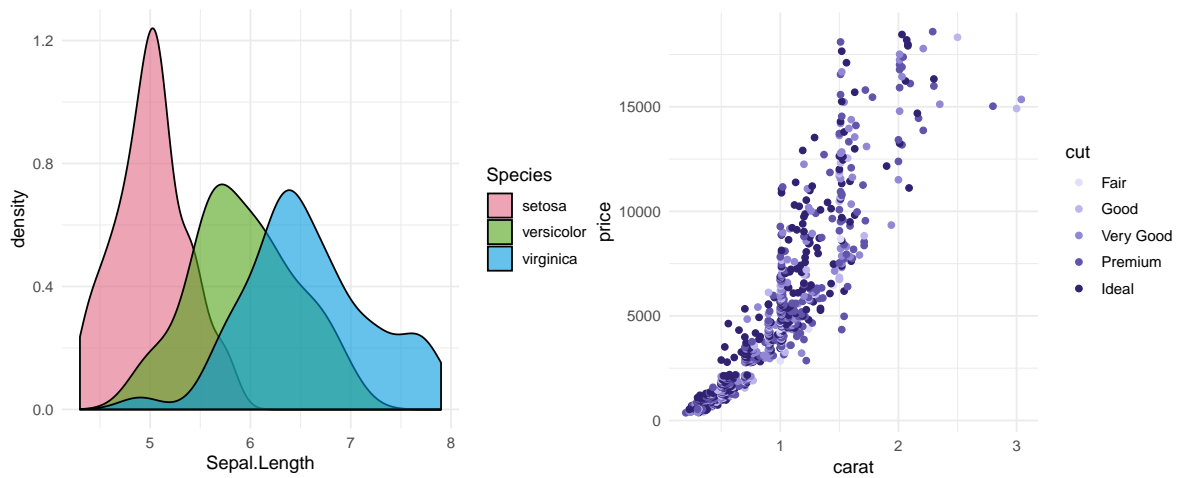

Figure 4: Using `colorspace` with `ggplot2` graphics. Left: Kernel density of sepal length, grouped and shaded by species, in the `iris` data with semi-transparent `scale_fill_discrete_qualitative(palette = "Dark 3")` color scale. Right: Scatter plot of price by carat, shaded by cut levels, in a subsample of the `diamonds` data with the `scale_color_discrete_sequential(palette = "Purples 3", nmax = 6, order = 2:6)` color scale.

As another example for a sequential palette, we demonstrate how to create a spine plot (see the right panel of Figure 3) displaying the proportion of Titanic passengers that survived per class. The "Purples 3" palette is used, which is quite similar to the ColorBrewer.org (Harrower and Brewer 2003) palette "Purples". Here, only two colors are employed, yielding a dark purple and light gray.

```
R> ttnc <- margin.table(Titanic, c(1, 4))[, 2:1]
R> spineplot(ttnc, col = sequential_hcl(2, palette = "Purples 3"))
```

2.3. Usage with `ggplot2`

To provide access to the HCL color palettes from within `ggplot2` graphics (Wickham 2016; Wickham *et al.* 2018) suitable discrete and/or continuous `ggplot2` color scales are provided. The scales are named via the scheme

```
scale_<aesthetic>_<datatype>_<colorscale>()
```

where

- `<aesthetic>` is the name of the aesthetic (`fill`, `color`, `colour`).
- `<datatype>` is the type of the variable plotted (`discrete` or `continuous`).
- `<colorscale>` sets the type of the color scale used (`qualitative`, `sequential`, `diverging`, `divergingx`).

To illustrate their usage two simple examples are shown using the qualitative "Dark 3" and sequential "Purples 3" palettes that were also employed above. For the first example, semi-transparent shaded densities of the sepal length from the `iris` data are shown, grouped by species (see the left panel of Figure 4).

```
R> library("ggplot2")
R> ggplot(iris, aes(x = Sepal.Length, fill = Species)) +
+   geom_density(alpha = 0.6) +
+   scale_fill_discrete_qualitative(palette = "Dark 3")
```

And for the second example the sequential palette is used to code the cut levels in a scatter of price by carat in the `diamonds` data (or rather a small subsample thereof, see the right panel of Figure 4). The scale function first generates six colors but then drops the first color because the light gray is too light here. (Alternatively, the chroma and luminance parameters could also be tweaked.)

```
R> dsamp <- diamonds[1 + 1:1000 * 50, ]
R> ggplot(dsamp, aes(carat, price, color = cut)) + geom_point() +
R>   scale_color_discrete_sequential(palette = "Purples 3",
R>   nmax = 6, order = 2:6)
```

2.4. Palette visualization and assessment

The `colorspace` package also provides a number of functions that aid visualization and assessment of its palettes.

- `demoplot()` can display a palette (with arbitrary number of colors) in a range of typical and somewhat simplified statistical graphics.
- `hclplot()` converts the colors of a palette to the corresponding hue/chroma/luminance coordinates and displays them in HCL space with one dimension collapsed. The collapsed dimension is the luminance for qualitative palettes and the hue for sequential/diverging palettes.
- `specplot()` also converts the colors to hue/chroma/luminance coordinates but draws the resulting spectrum in a line plot.

For the qualitative "Dark 3" palette from above the following plots can be obtained (see Figure 5).

```
R> demoplot(q4, "bar")
R> hclplot(q4)
R> specplot(q4, type = "o")
```

The bar plot is used as a typical application for a qualitative palette (in addition to the time series and density plots used above). The other two displays show that luminance is (almost) constant in the palette while the hue changes linearly along the color "wheel". Ideally, chroma would have also been constant to completely balance the colors. However, at this luminance the maximum chroma differs across hues so that the palette is fixed up to use less chroma for the yellow and green elements.

Note also that in a bar plot areas are shaded (and not just points or lines) so that lighter colors would be preferable. In the density plot in Figure 4 this was achieved through semi-transparency. Alternatively, luminance could be increased as is done in the "Pastel 1" or "Set 3" palettes.

Subsequently, the same types of assessment are carried out in Figure 6 for the sequential "Purples 3" palette as employed above.

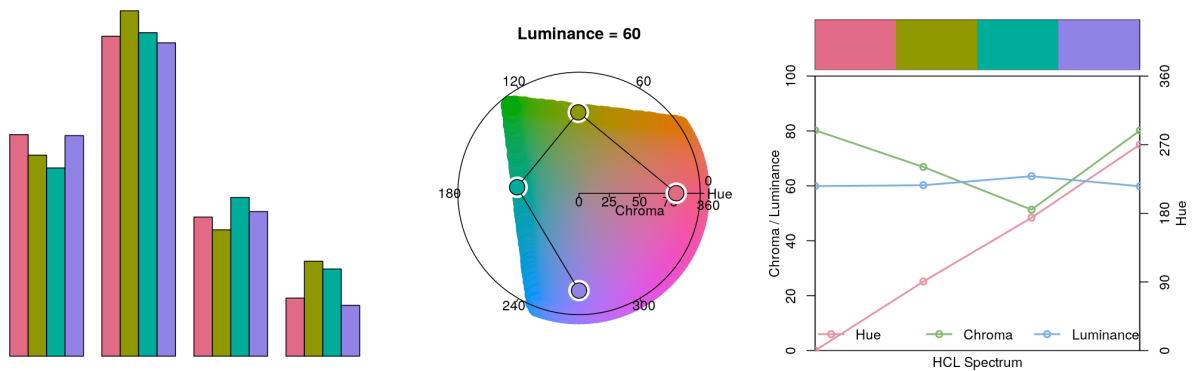

Figure 5: Palette visualization and assessment for `qualitative_hcl(4, "Dark 3")` palette. Left: Demo bar plot. Center: Hue-chroma plane at fixed $L = 60$ in HCL space. Right: HCL spectrum with linearly changing hue (around color wheel), almost constant chroma, and constant luminance.

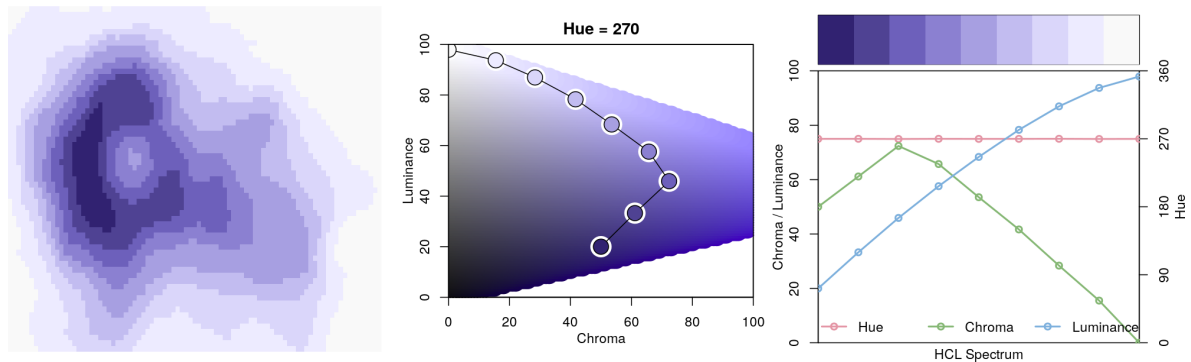

Figure 6: Palette visualization and assessment for `sequential_hcl(4, "Purples 3")` palette. Left: Demo heatmap. Center: Chroma-luminance plane at fixed $H = 270$ in HCL space. Right: HCL spectrum with constant hue, triangular chroma, and increasing luminance.

```
R> s9 <- sequential_hcl(9, "Purples 3")
R> demoplot(s9, "heatmap")
R> hclplot(s9)
R> specplot(s9, type = "o")
```

In Figure 6, a heatmap (based on the well-known Maunga Whau volcano data) is used as a typical application for a sequential palette. The elevation of the volcano is brought out clearly, using dark colors to give emphasis to higher elevations. The other two displays show that hue is constant in the palette while luminance and chroma vary. Luminance increases monotonically from dark to light (as required for a proper sequential palette). Chroma is triangular-shaped which allows to better distinguish the middle colors in the palette when compared to a monotonic chroma trajectory.

3. Color spaces: S4 classes and utilities

At the core of the **colorspace** package are various utilities for computing with color spaces (Wikipedia 2019d), as the name conveys. Thus, the package helps to map various three-dimensional representations of color to each other (Ihaka 2003). A particularly important mapping is the one from the perceptually-based and device-independent color model HCL (Hue-Chroma-Luminance) to standard Red-Green-Blue (sRGB) which is the basis for color specifications in many systems based on the corresponding hex codes (Wikipedia 2019i), e.g., in HTML but also in R. For completeness further standard color models are included as well in the package. The connections are illustrated in Figure 7. Color models that are (or try to be) perceptually-based are displayed with circles and models that are not are displayed with rectangles.

3.1. Implemented color spaces

The color spaces, implemented in **colorspace**, along with their corresponding S4 classes and eponymous class constructors, are:

- `RGB()` for the classic Red-Green-Blue color model that mixes three primary colors with different intensities to obtain a spectrum of colors. The advantage of this color model is (or was) that it corresponded to how computer and TV screens generated colors, hence it was widely adopted and still is the basis for color specifications in many systems. For example, the hex color codes are employed in HTML but also in R. However, the RGB model also has some important drawbacks: It does not take into account the output device properties, it is not perceptually uniform (a unit step within RGB does not produce a constant perceptual change in color), and it is unintuitive for humans to specify colors (say brown or pink) in this space. See Wikipedia (2019g) for more details.
- `sRGB()` addresses the issue of device dependency by adopting a so-called gamma correction. Therefore, the gamma-corrected standard RGB (sRGB), as opposed to the linearized RGB above, is a good model for specifying colors in software and for hardware. But it is still unintuitive for humans to work directly with this color space.

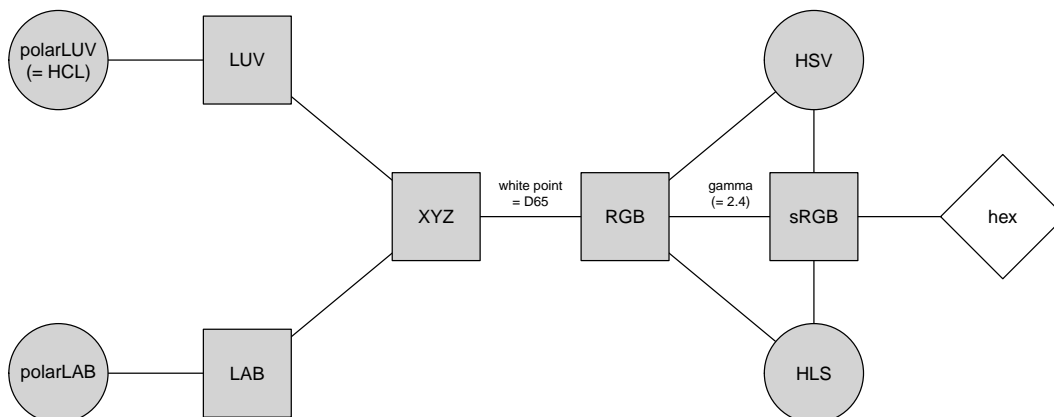

Figure 7: Relationship between three-dimensional color spaces implemented in **colorspace**. Color models that are (or try to be) perceptually-based are displayed with circles, other color models with rectangles.

Therefore, sRGB is a good place to end up in a color space manipulation but it is not a good place to start. See [Wikipedia \(2019h\)](#) for more details.

- `HSV()` is a simple transformation of the (s)RGB space that tries to capture the perceptual axes: *hue* (dominant wavelength, the type of color), *saturation* (colorfulness), and *value* (brightness, i.e., light vs. dark). Unfortunately, the three axes in the HSV model are confounded so that, e.g., brightness changes dramatically with hue. See [Wikipedia \(2019f\)](#) for more details.
- `HLS()` (Hue-Lightness-Saturation) is another transformation of (s)RGB that tries to capture the perceptual axes. It does a somewhat better job but the dimensions are still strongly confounded. See [Wikipedia \(2019f\)](#) for more details.
- `XYZ()` was established by the CIE (Commission Internationale de l'Eclairage) based on psychophysical experiments with human subjects. It provides a unique triplet of XYZ values, coding the standard observer's perception of the color. It is device-independent but it is not perceptually uniform and the XYZ coordinates have no intuitive meaning. See [Wikipedia \(2019a\)](#) for more details.
- `LUV()` and `LAB()` were therefore proposed by the CIE as perceptually uniform color spaces where the former is typically preferred for emissive technologies (such as screens and monitors) whereas the latter is usually preferred when working with dyes and pigments. However, the three axes of these two spaces still do not correspond to human perceptual axes. See [Wikipedia \(2019c\)](#); [Wikipedia \(2019b\)](#) for more details.
- `polarLUV()` and `polarLAB()` take polar coordinates in the UV plane and AB plane, respectively. Specifically, the polar coordinates of the LUV model are known as the HCL (Hue-Chroma-Luminance) model. These capture the human perceptual axes very well without confounding effects as in the HSV or HLS approaches. (More details follow below.)

All S4 classes for color spaces inherit from a virtual class `color` which is internally always represented by matrices with three columns (corresponding to the different three dimensions). Note that since the inception of the color space conversion tools within `colorspace`'s C code by [Ihaka \(2003\)](#) other R tools for this purpose became available. Notably, base R meanwhile provides `grDevices::convertColor()` (computed in high-level R, [R Core Team 2018](#)) and `farver::convert_colour()` ([Pedersen, Nicolae, and François 2018](#)) is based on a C++ library. For many basic color conversion purposes the `colorspace` package and these alternatives are essentially equally suitable (see the discussion in [Zeileis, Gaslam, Murrell, and Pedersen 2018](#)). For more complex conversions, including different chromatic adaptation algorithms, a more comprehensive color science approach is implemented in the R package `colorscience` ([Gama and Davis 2018](#)). Finally, base R also provides `grDevices::hcl()` for mapping HCL representations to hex codes.

To make the `colorspace` package self-contained and exactly backward compatible, the C code in `colorspace` is still used as the basis for all color space conversions.

3.2. Utilities

For working with the implemented S4 color spaces various utilities are available:

- `as()` method: Conversions of a `color` object to the various color spaces, e.g., `as(x, "sRGB")`.

- `coords()`: Extract the three-dimensional coordinates pertaining to the current color class.
- `hex()`: Convert a color object to sRGB and code in a hex string that can be used within R plotting functions.
- `hex2RGB()`: Convert a given hex color string to an sRGB color object which can also be coerced to other color spaces.
- `readRGB()` and `readhex()` can read text files into color objects, either from RGB coordinates or hex color strings.
- `writehex()`: Writes hex color strings to a text file.
- `whitepoint()`: Query and change the white point employed in conversions from CIE XYZ to RGB. Defaults to D65.

3.3. Illustration of basic colorspace functionality

As an example a vector of colors `x` can be specified in the HCL (or polar LUV) model:

```
R> (x <- polarLUV(L = 70, C = 50, H = c(0, 120, 240)))
```

```
      L  C  H
[1,] 70 50  0
[2,] 70 50 120
[3,] 70 50 240
```

The resulting three colors are pastel red (hue = 0), green (hue = 120), and blue (hue = 240) with moderate chroma and luminance. For display in other systems an sRGB representation might be needed:

```
R> (y <- as(x, "sRGB"))
```

```
      R      G      B
[1,] 0.8931564 0.5853740 0.6465459
[2,] 0.5266113 0.7224335 0.4590469
[3,] 0.4907804 0.6911937 0.8673877
```

With `coords(x)` or `coords(y)` the displayed coordinates can also be extracted as numeric matrices. And from sRGB we can also coerce to HSV for example:

```
R> as(y, "HSV")
```

```
      H      S      V
[1,] 348.0750 0.3446008 0.8931564
[2,] 104.6087 0.3645825 0.7224335
[3,] 208.0707 0.4341857 0.8673877
```

For display in many systems (including R itself) hex color codes based on the sRGB coordinates can be created:

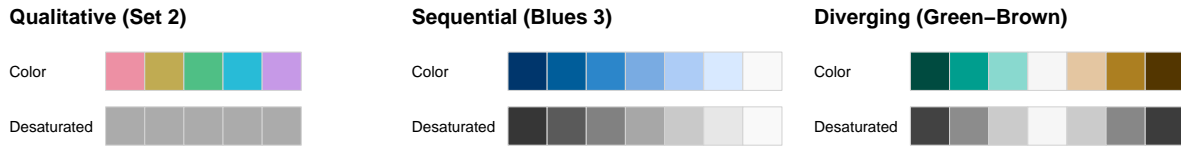

Figure 8: Examples of palette types in **colorspace**. Qualitative palettes are balanced towards the same luminance level while sequential and diverging palettes go from dark to light and/or vice versa, respectively.

```
R> hex(x)
```

```
[1] "#E495A5" "#86B875" "#7DB0DD"
```

4. HCL-based color palettes

As motivated in the previous section, the HCL space is particularly useful for specifying individual colors and color palettes, as its three axes match those of the human visual system very well. Therefore, the **colorspace** package provides three palette functions based on the HCL model: `qualitative_hcl()`, `sequential_hcl()`, and `diverging_hcl()`. Their construction principles are exemplified in Figure 8 and explained in more detail below. The desaturated palettes in the second row of Figure 8 bring out clearly that luminance differences (= light-dark contrasts) are crucial for sequential and diverging palettes while qualitative palettes are balanced at the same luminance.

To facilitate obtaining good sets of colors, HCL parameter combinations that yield useful palettes are accessible by name. These can be listed using the function `hcl_palettes()`:

```
R> hcl_palettes()
```

HCL palettes

Type: Qualitative

Names: Pastel 1, Dark 2, Dark 3, Set 2, Set 3, Warm, Cold, Harmonic, Dynamic

Type: Sequential (single-hue)

Names: Grays, Light Grays, Blues 2, Blues 3, Purples 2, Purples 3, Reds 2, Reds 3, Greens 2, Greens 3, Oslo

Type: Sequential (multi-hue)

Names: Purple-Blue, Red-Purple, Red-Blue, Purple-Orange, Purple-Yellow, Blue-Yellow, Green-Yellow, Red-Yellow, Heat, Heat 2, Terrain, Terrain 2, Viridis, Plasma, Inferno, Dark Mint, Mint, BluGrn, Teal, TealGrn, Emrld, BluYl, ag_GrnYl, Peach, PinkYl, Burg, BurgYl, RedOr, OrYel, Purp, PurpOr, Sunset, Magenta, SunsetDark, ag_Sunset, BrwnYl, YlOrRd, YlOrBr,

OrRd, Oranges, YlGn, YlGnBu, Reds, RdPu, PuRd, Purples,
 PuBuGn, PuBu, Greens, BuGn, GnBu, BuPu, Blues, Lajolla,
 Turku

Type: Diverging

Names: Blue-Red, Blue-Red 2, Blue-Red 3, Red-Green, Purple-Green,
 Purple-Brown, Green-Brown, Blue-Yellow 2, Blue-Yellow 3,
 Green-Orange, Cyan-Magenta, Tropic, Broc, Cork, Vik,
 Berlin, Lisbon, Tofino

To inspect the HCL parameter combinations for a specific palette simply include the `palette` name where upper- vs. lower-case, spaces, etc. are ignored for matching the label, i.e., "set2" matches "Set 2":

```
R> hcl_palettes(palette = "set2")
```

```
HCL palette
```

```
Name: Set 2
```

```
Type: Qualitative
```

```
Parameter ranges:
```

```
  h1 h2 c1 c2 l1 l2 p1 p2 cmax fixup
  0 NA 60 NA 70 NA NA NA   NA  TRUE
```

To compute the actual color hex codes (representing sRGB coordinates) based on these HCL parameters, the functions `qualitative_hcl()`, `sequential_hcl()`, and `diverging_hcl()` can be used. Either all parameters can be specified “by hand” through the HCL parameters, an entire palette can be specified “by name”, or the name-based specification can be modified by a few HCL parameters. In case of the HCL parameters, either a vector-based specification such as `h = c(0, 270)` or individual parameters `h1 = 0` and `h2 = 270` can be used.

The first three of the following commands lead to equivalent output. The fourth command yields a modified set of colors (lighter due to a luminance of 80 instead of 70).

```
R> qualitative_hcl(4, h = c(0, 270), c = 60, l = 70)
```

```
[1] "#ED90A4" "#ABB150" "#00C1B2" "#ACA2EC"
```

```
R> qualitative_hcl(4, h1 = 0, h2 = 270, c1 = 60, l1 = 70)
```

```
[1] "#ED90A4" "#ABB150" "#00C1B2" "#ACA2EC"
```

```
R> qualitative_hcl(4, palette = "set2")
```

```
[1] "#ED90A4" "#ABB150" "#00C1B2" "#ACA2EC"
```

```
R> qualitative_hcl(4, palette = "set2", l = 80)
```

```
[1] "#FFACBF" "#C6CD70" "#32DDCD" "#C7BEFF"
```

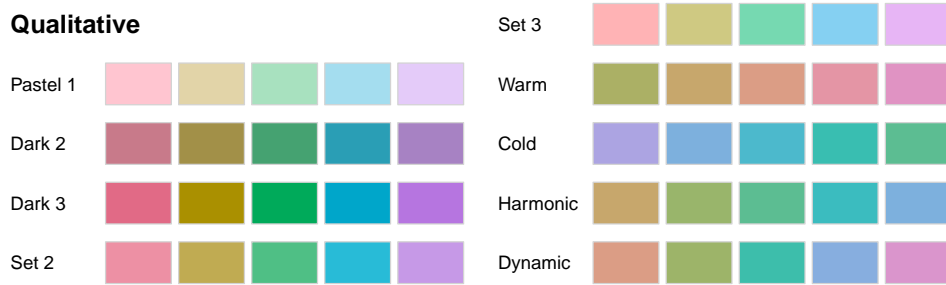

Figure 9: Prespecified qualitative HCL palettes available in `qualitative_hcl()` in `colospace`.

4.1. Qualitative palettes

As suggested by Ihaka (2003) `qualitative_hcl()` distinguishes the underlying categories by a sequence of hues while keeping both chroma and luminance constant, to give each color in the resulting palette the same perceptual weight. Thus, `h` should be a pair of hues (or equivalently `h1` and `h2` can be used) with the starting and ending hue of the palette. Then, an equidistant sequence between these hues is employed, by default spanning the full color wheel (i.e., the full 360 degrees). Chroma `c` (or equivalently `c1`) and luminance `l` (or equivalently `l1`) are constants.

Figure 9 shows the named palettes available in the `qualitative_hcl()` function. The first five palettes are close to the **ColorBrewer.org** palettes of the same name (Harrower and Brewer 2003). They employ different levels of chroma and luminance and, by default, span the full hue range. The remaining four palettes are taken from Ihaka (2003). They are based on the same chroma ($= 50$) and luminance ($= 70$) but the hue is restricted to different intervals.

```
R> hcl_palettes("qualitative", plot = TRUE, nrow = 5)
```

When qualitative palettes are employed for shading areas in statistical displays (e.g., in bar plots, pie charts, or regions in maps), lighter colors (with moderate chroma and high luminance) such as "Pastel 1" or "Set 3" are typically less distracting. By contrast, when coloring points or lines, more flashy colors (with high chroma) are often required: On a white background a moderate luminance as in "Dark 2" or "Dark 3" usually works better while on a black/dark background the luminance should be higher as in "Set 2". Some examples with demo graphics are provided in Section 5.

4.2. Sequential palettes (single-hue)

As suggested by Zeileis *et al.* (2009), `sequential_hcl()` codes the underlying numeric values by a monotonic sequence of increasing (or decreasing) luminance. Thus, the function's `l` argument should provide a vector of length 2 with starting and ending luminance (equivalently, `l1` and `l2` can be used). Without chroma (i.e., $c = 0$), this simply corresponds to a grayscale palette like `gray.colors()`, see "Grays" and "Light Grays" in Figure 10.

For adding chroma, a simple strategy would be to pick a single hue (via `h` or `h1`) and then decrease chroma from some value (`c` or `c1`) to zero (i.e., gray) along with increasing luminance. For bringing out the extremes (a dark high-chroma color vs. a light gray) this is already very effective, see "Blues 2", "Purples 2", "Reds 2", and "Greens 2".

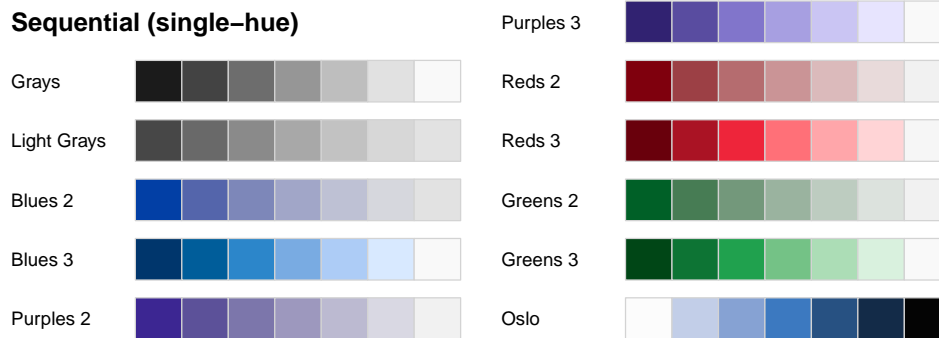

Figure 10: Prespecified sequential single-hue HCL palettes available in `sequential_hcl()` in **colorspace**.

For distinguishing colors in the center of the palette, two strategies can be employed: (a) Hue can be varied as well by specifying an interval of hues in `h` (or beginning hue `h1` and ending hue `h2`). More details are provided in the next section. (b) Instead of a decreasing chroma, a triangular chroma trajectory can be employed from `c1` over `cmax` to `c2` (equivalently specified as a vector `c` of length 3). This yields high-chroma colors in the middle of the palette that are more easily distinguished from the dark and light extremes. See "Blues 3", "Purples 3", "Reds 3", and "Greens 3" in Figure 10.

Instead of employing linear trajectories in the chroma or luminance coordinates, some palettes employ a power transformation of the chroma and/or luminance trajectory. Either a vector `power` of length 2 or separate `p1` (for chroma) and `p2` (for luminance) can be specified. If the latter is missing, it defaults to the former.

```
R> hcl_palettes("sequential (single-hue)", n = 7, plot = TRUE, nrow = 6)
```

All except the last one are inspired by the **ColorBrewer.org** palettes with the same base name (Harrower and Brewer 2003) but restricted to a single hue only. They are intended for a white/light background. The last palette ("Oslo") is taken from the scientific color maps of Crameri (2018) and is intended for a black/dark background and hence the order is reversed starting from a light blue (not a light gray).

To distinguish many colors in a sequential palette it is important to have a strong contrast on the luminance axis, possibly enhanced by an accompanying pronounced variation in chroma. When only a few colors are needed (e.g., for coding an ordinal categorical variable with few levels) then a lower luminance contrast may suffice.

4.3. Sequential palettes (multi-hue)

To not only bring out extreme colors in a sequential palette but also better distinguish middle colors it is a common strategy to employ a sequence of hues. Thus, the basis of such a palette is still a monotonic luminance sequence as above (combined with a monotonic or triangular chroma sequence). But rather than using a single hue, an interval of hues in `h` (or beginning hue `h1` and ending hue `h2`) can be specified.

`sequential_hcl()` allows combined variations in hue (`h` and `h1/h2`, respectively), chroma (`c` and `c1/c2/cmax`, respectively), luminance (`l` and `l1/l2`, respectively), and power transforma-



Figure 11: Prespecified sequential multi-hue HCL palettes available in `sequential_hcl()` in **colorspace**.

tions for the chroma and luminance trajectories (power and $p1/p2$, respectively). This yields a broad variety of sequential palettes, including many that closely match other well-known color palettes. Figure 11 shows all the named multi-hue sequential palettes in **colorspace**:

```
R> hcl_palettes("sequential (multi-hue)", n = 7, plot = TRUE)
```

- "Purple-Blue" to "Terrain 2" are various palettes created during the development of **colorspace**, e.g., by Zeileis *et al.* (2009) or Stauffer *et al.* (2015) among others.
- "Viridis" to "Inferno" closely match the palettes that Smith and Van der Walt (2015) developed for **matplotlib** and that gained popularity recently.



Figure 12: Prespecified diverging HCL palettes available in `diverging_hcl()` in **colorspace**.

- "Dark Mint" to "BrwnYl" closely match palettes provided in **CARTO** (CARTO 2019).
- "YlOrRd" to "Blues" closely match **ColorBrewer.org** palettes (Harrover and Brewer 2003).
- "Lajolla" and "Turku" closely match the scientific color maps of the same name by Crameri (2018) and are intended for a black/dark background.

Note that the palettes differ substantially in the amount of chroma and luminance contrasts, respectively. For example, many palettes go from a dark high-chroma color to a neutral low-chroma color (e.g., "Reds", "Purples", "Greens", "Blues") or even light gray (e.g., "Purple-Blue"). But some palettes also employ relatively high chroma throughout the palette (e.g., the viridis and many **CARTO** palettes). To emphasize the extremes the former strategy is typically more suitable while the latter works better if all values along the sequence should receive some more perceptual weight.

4.4. Diverging palettes

`diverging_hcl()` codes the underlying numeric values by a triangular luminance sequence with different hues in the left and in the right “arm” of the palette. Thus, it can be seen as a combination of two sequential palettes with some restrictions: (a) a single hue is used for each arm of the palette, (b) chroma and luminance trajectory are balanced between the two arms, (c) the neutral central value has zero chroma. To specify such a palette a vector of two hues `h` (or equivalently `h1` and `h2`), either a single chroma value `c` (or `c1`) or a vector of two chroma values `c` (or `c1` and `cmax`), a vector of two luminances `l` (or `l1` and `l2`), and power parameter(s) `power` (or `p1` and `p2`) are used. For more flexible diverging palettes without the restrictions above (and consequently more parameters) see the `divergingx_hcl()` palettes introduced below.

Figure 12 shows all such diverging palettes that have been named in **colorspace**:

```
R> hcl_palettes("diverging", n = 7, plot = TRUE, nrow = 10)
```

Type	H	C	L
Qualitative	Linear	Constant	Constant
Sequential	Constant (= single-hue) <i>or</i> Linear (= multi-hue)	Linear (+ power) <i>or</i> Triangular (+ power)	Linear (+ power)
Diverging	Constant (2×)	Linear (+ power) <i>or</i> Triangular (+ power)	Linear (+ power)

Table 1: Types of trajectories used for the HCL coordinates to construct qualitative, sequential, and diverging palettes, see Equations 1–3.

- "Blue-Red" to "Cyan-Magenta" have been developed for **colorspace** starting from Zeileis *et al.* (2009), taking inspiration from various other palettes, including more balanced and simplified versions of several **ColorBrewer.org** palettes (Harower and Brewer 2003).
- "Tropic" closely matches the palette of the same name from **CARTO** (CARTO 2019).
- "Broc" to "Vik" and "Berlin" to "Tofino" closely match the scientific color maps of the same name by Cramer (2018), where the first three are intended for a white/light background and the other three for a black/dark background.

When choosing a particular palette for a display similar considerations apply as for the sequential palettes. Thus, large luminance differences are important when many colors are used while smaller luminance contrasts may suffice for palettes with fewer colors etc.

4.5. Construction details

Table 1 summarizes which types of trajectories (*constant*, *linear*, *triangular*) are used for the three HCL coordinates (hue H , chroma C , luminance L) to construct the different types of palettes (*qualitative*, *sequential*, and *diverging*).

As emphasized in Figure 8, the luminance is probably the most important property for defining the type of palette. It is constant for qualitative palettes, monotonic for sequential palettes (linear or a power transformation), or uses two monotonic trajectories (linear or a power transformation) diverging from the same neutral value.

The trajectories for the hue are also rather intuitive and straightforward for the three different types of palettes (constant vs. linear). However, the chroma trajectories are probably most complicated and least obvious from the examples above. Hence, the exact mathematical equations underlying the chroma trajectories are given in the following (i.e., using the parameters c_1 , c_2 , c_{\max} , and p_1 , respectively) and are depicted in Figure 13. Analogous equations apply for the other two coordinates.

The trajectories are functions of the *intensity* $i \in [0, 1]$ where 1 corresponds to the full intensity:

$$\text{Constant: } c_1 \tag{1}$$

$$\text{Linear: } c_2 - (c_2 - c_1) \cdot i \tag{2}$$

$$\text{Triangular: } \begin{cases} c_2 - (c_2 - c_{\max}) \cdot \frac{i}{j} & \text{if } i \leq j \\ c_{\max} - (c_{\max} - c_1) \cdot \frac{i-j}{1-j} & > j \end{cases} \tag{3}$$

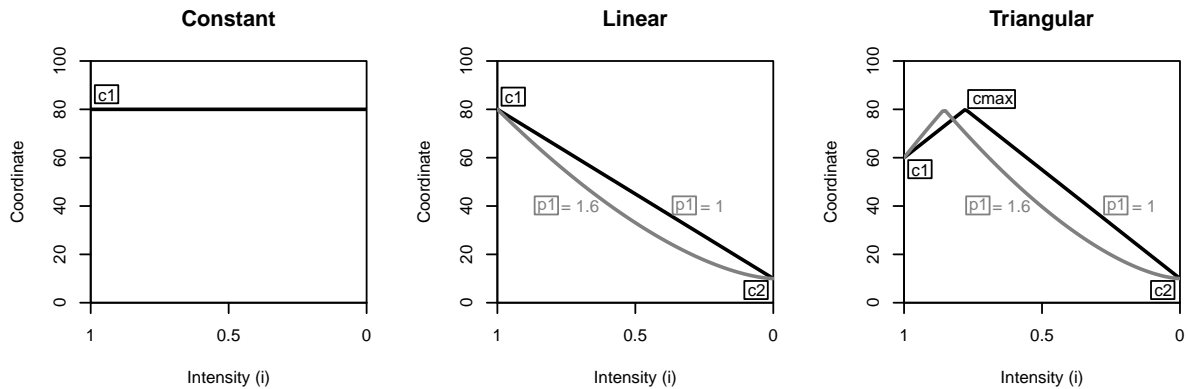

Figure 13: Types of trajectories to construct HCL color palettes, exemplified for the chroma coordinates, see Equations 1–3.

where j is the intensity at which c_{\max} is assumed. It is constructed such that the slope to the left is minus the slope to the right of j :

$$j = \left(1 + \frac{|c_{\max} - c_1|}{|c_{\max} - c_2|} \right)^{-1}$$

Instead of using a linear intensity i going from 1 to 0, one can replace i with i^{p_1} in Equations 1–3. This then leads to power-transformed curves that add or remove chroma more slowly or more quickly depending on whether the power parameter p_1 is < 1 or > 1 .

The three types of trajectories are also depicted in Figure 13. Note that full intensity $i = 1$ is on the left and zero intensity $i = 0$ on the right of each panel. The concrete parameters are:

- Constant: $c_1 = 80$.
- Linear: $c_1 = 80$, $c_2 = 10$, $p_1 = 1$ (solid) vs. $p_1 = 1.6$ (dashed).
- Triangular: $c_1 = 60$, $c_{\max} = 80$, $c_2 = 10$, $p_1 = 1$ (solid) vs. $p_1 = 1.6$ (dashed).

Further discussion of these trajectories and how they can be visualized and assessed for a given color palette is provided in Section 5.

4.6. Registering your own palettes

The `hcl_palettes()` already come with a wide range of predefined palettes to which customizations can be easily added. However, it might also be convenient to register a custom palette so that it can subsequently be reused with a new dedicated name. This is supported by adding a `register = "..."` argument once to a call to `qualitative_hcl()`, `sequential_hcl()`, or `diverging_hcl()`:

```
R> qualitative_hcl(3, palette = "set2", l = 80, register = "myset")
```

The new palette is then included in `hcl_palettes()`:

```
R> hcl_palettes("Qualitative")
```

HCL palettes

Type: Qualitative

Names: Pastel 1, Dark 2, Dark 3, Set 2, Set 3, Warm, Cold, Harmonic,
Dynamic, myset

And can be used subsequently in `qualitative_hcl()` as well as the qualitative **ggplot2** color scales (see Section 2.3), e.g.,

```
R> qualitative_hcl(4, palette = "myset")
```

```
[1] "#FFACBF" "#C6CD70" "#32DDCD" "#C7BEFF"
```

Remarks:

- The number of colors in the palette that was used during registration is not actually stored and can be modified subsequently. The same holds for arguments `alpha` and `rev`.
- When registering a new palette with an old name that was already available previously, the old palette gets overwritten. We recommend not to overwrite the palettes that are predefined in the package (albeit it is technically possible).
- The registration of a palette is only stored for the current session. When R is restarted and/or the **colorspace** package reloaded, only the predefined palettes from the package are available. Thus, to make a palette permanently available a registration R code like `colorspace::qualitative_hcl(3, palette = "set2", l = 80, register = "myset")` can be placed in your `.Rprofile` or similar startup scripts.

4.7. Flexible diverging palettes

The `divergingx_hcl()` function provides more flexible diverging palettes by simply calling `sequential_hcl()` twice with prespecified sets of hue, chroma, and luminance parameters. Thus, it does not pose any restrictions that the two “arms” of the palette need to be balanced and also allows to go through a non-gray neutral color (typically light yellow). Consequently, the chroma/luminance paths can be rather unbalanced.

Figure 14 shows all such flexible diverging palettes that have been named in **colorspace**:

```
R> divergingx_palettes(n = 7, plot = TRUE, nrow = 10)
```

- "ArmyRose" to "Tropic" closely match the palettes of the same name from **CARTO** (CARTO 2019).
- "PuOr" to "Spectral" closely match the palettes of the same name from **ColorBrewer.org** (Harrower and Brewer 2003).
- "Zissou 1" closely matches the palette of the same name from **wesanderson** (Ram and Wickham 2018).

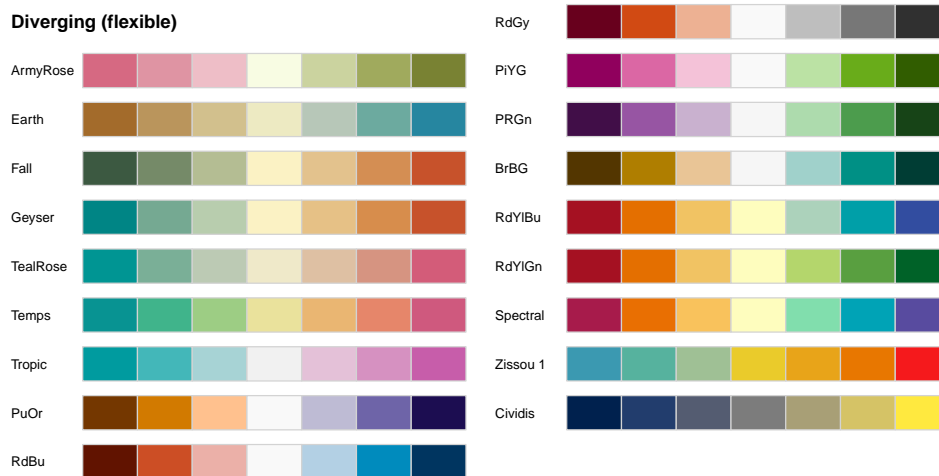

Figure 14: Prespecified flexible diverging HCL palettes available in `divergingx_hcl()` in **colorspace**.

- "Cividis" closely matches the palette of the same name from the **viridis** family (Garnier 2018). Note that despite having two "arms" with blue vs. yellow colors and a low-chroma center color, this is probably better classified as a sequential palette due to the monotonic chroma going from dark to light. (See Section 4.8 for more details.)

Typically, the more restricted `diverging_hcl()` palettes should be preferred because they are more balanced. However, by being able to go through light yellow as the neutral color warmer diverging palettes are available.

4.8. Approximating palettes from other packages

The flexible specification of HCL-based color palettes in **colorspace** allows to closely approximate color palettes from various other packages:

- **ColorBrewer.org** (Harrower and Brewer 2003) as provided by R package **RColorBrewer** (Neuwirth 2014). See `demo("brewer", package = "colorspace")`.
- **CARTO** colors (CARTO 2019) as provided by R package **rcartocolor** (Nowosad 2018). See `demo("carto", package = "colorspace")`.
- The viridis palettes of Smith and Van der Walt (2015) developed for **matplotlib**, as provided by R package **viridis** (Garnier 2018). See `demo("viridis", package = "colorspace")`.
- The scientific color maps of Crameri (2018) as provided by R package **scico** (Pedersen and Crameri 2018). See `demo("scico", package = "colorspace")`.

The graphics resulting from the demos can also be viewed online at <http://colorspace.R-Forge.R-project.org/articles/approximations.html>.

Figure 15 shows a selection of such approximations using `specplot()` (see also Section 5.2) for two blue/green/yellow palettes (`RColorBrewer::brewer.pal(7, "YlGnBu")` and `viridis::viridis(7)`) and two purple/red/yellow (`rcartocolor::carto_pal(7,`

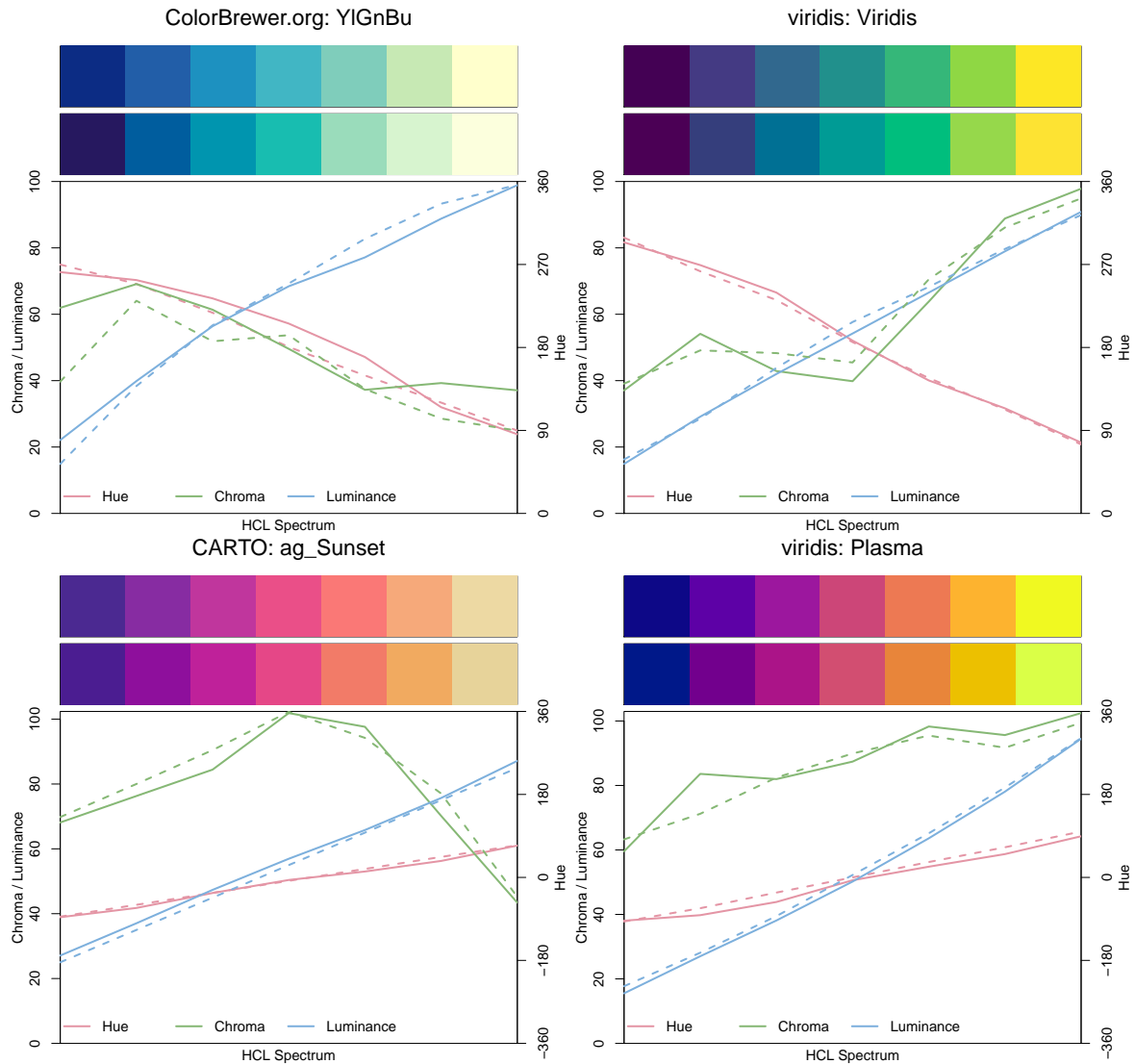

Figure 15: HCL spectrum of four palettes taken from **ColorBrewer.org**, **CARTO**, and **viridis** (top swatches, solid lines) along with their HCL-based approximations (bottom swatches, dashed lines).

"`ag_Sunset`") and `viridis::plasma(7)`). Each panel compares the hue, chroma, and luminance trajectories of the original palettes (top swatches, solid lines) and their HCL-based approximations (bottom swatches, dashed lines). The palettes are not identical but very close for most colors. Note that also the chroma trajectories from the HCL palettes (green dashed lines) have some kinks which are due to fixing HCL coordinates at the boundaries of admissible RGB colors.

Furthermore, Figure 15 illustrates what sets the viridis palettes apart from other sequential palettes. While the hue and luminance trajectories of "Viridis" and "YlGnBu" are very similar, the chroma trajectories differ: While lighter colors (with high luminance) have low chroma for "YlGnBu", they have increasing chroma for "Viridis". Similarly, "ag_Sunset"

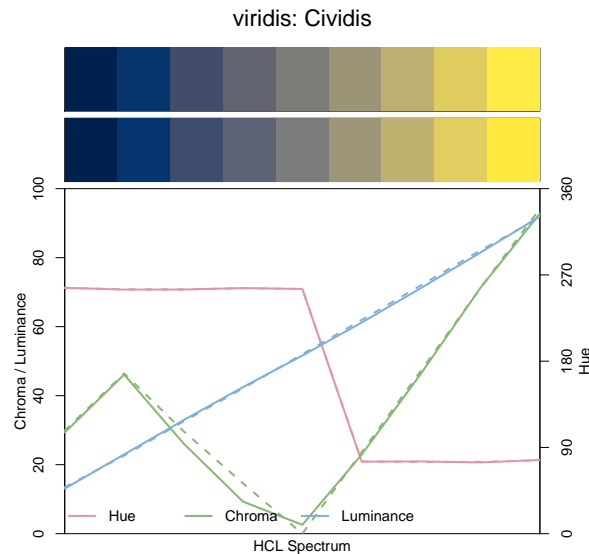

Figure 16: HCL spectrum of `viridis::cividis` (top swatch, solid lines) along with an HCL-based approximation (bottom swatch, dashed lines).

and "Plasma" have similar hue and luminance trajectories but different chroma trajectories. The result is that the viridis palettes have rather high chroma throughout which does not work as well for sequential palettes on a white/light background as all shaded areas convey high "intensity". However, they work better on a dark/black background (see Figure 26). Also, they might be a reasonable alternative for qualitative palettes when grayscale printing should also work.

Another somewhat nonstandard palette from the viridis family is the `cividis` palette based on blue and yellow hues and hence safe for red-green deficient viewers. Figure 16 shows the corresponding `specplot()` along with an HCL-based approximation. What is unusual about this palette: The hue and chroma trajectories would suggest a diverging palette, as there are two "arms" with different hues and a zero-chroma point in the center. However, the luminance trajectory clearly indicates a sequential palette as colors go monotonically from dark to light. Due to this unusual mixture the palette cannot be composed using the trajectories from Table 1.

However, the tools in `colorspace` can still be employed to easily reconstruct the palette. One strategy would be to set up the trajectories manually, using a linear luminance, piecewise linear chroma, and piecewise constant hue:

```
R> cividis_hcl <- function(n) {
+   i <- seq(1, 0, length.out = n)
+   hex(polarLUV(
+     L = 92 - (92 - 13) * i,
+     C = approx(c(1, 0.9, 0.5, 0), c(30, 50, 0, 95), xout = i)$y,
+     H = c(255, 75)[1 + (i < 0.5)]
+   ), fix = TRUE)
+ }
```

Instead of constructing the hex code from the HCL coordinates via `hex(polarLUV(L, C,`

H)) from **colorspace**, the base R function `hcl(H, C, L)` from **grDevices** could also be used. In addition to manually setting up a dedicated function `cividis_hcl()`, it is possible to approximate the palette using `divergingx_hcl()` (see Section 4.7), e.g.,

```
R> divergingx_hcl(n,
R>   h1 = 255, h2 = NA, h3 = 75,
R>   c1 = 30, cmax1 = 47, c2 = 0, c3 = 95,
R>   l1 = 13, l2 = 52, l3 = 92,
R>   p1 = 1.1, p3 = 1.0
R> )
```

This uses a slight power transformation with `p1 = 1.1` in the blue arm of the palette but otherwise essentially corresponds to what `cividis_hcl()` does. For convenience `divergingx_hcl(n, palette = "Cividis")` is preregistered using the above parameters.

4.9. HCL (and HSV) color palettes corresponding to base R palettes

To facilitate switching from base R palette functions to the HCL-based palettes above, **colorspace** provides a few convenience interfaces:

- `rainbow_hcl()`: Convenience interface to `qualitative_hcl()` for a HCL-based “rainbow” palette to replace the (in)famous `rainbow()` palette.
- `heat_hcl()`: Convenience interface to `sequential_hcl()` with default parameters chosen to generate more balanced heat colors than the basic `heat.colors()` function.
- `terrain_hcl()`: Convenience interface to `sequential_hcl()` with default parameters chosen to generate more balanced terrain colors than the basic `terrain.colors()` function.
- `diverging_hsv()`: Diverging palettes generated in HSV space rather than HCL space as in `diverging_hcl()`. This is provided for didactic purposes to contrast the more balanced HCL palettes with the more flashy and unbalanced HSV palettes.

5. Palette visualization and assessment

The **colorspace** package provides several visualization functions for depicting one or more color palettes and their underlying properties. Color palettes can be visualized by:

- `swatchplot()`: Color swatches.
- `specplot()`: Spectrum of HCL and/or RGB trajectories.
- `hclplot()`: Trajectories in 2-dimensional HCL space projections.
- `demoplot()`: Illustrations of typical (and simplified) statistical graphics.

5.1. Color swatches

The function `swatchplot()` is a convenience function for displaying collections of palettes that can be specified as lists or matrices of hex color codes. Essentially, it is just a call to the base graphics `rect()` function but with heuristics for choosing default labels, margins,

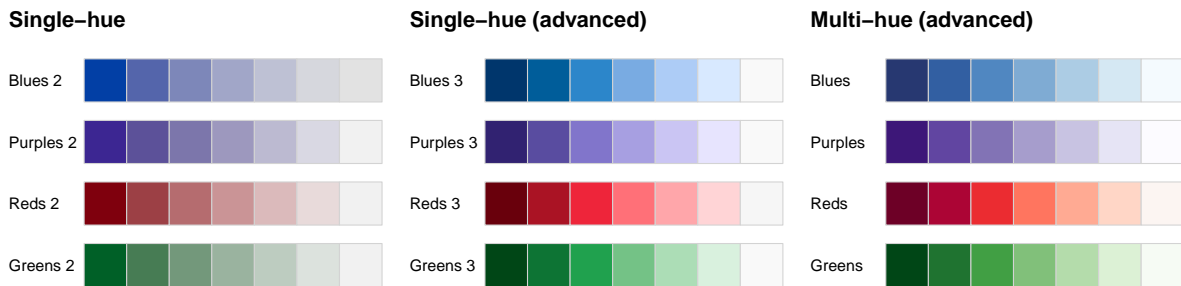

Figure 17: Variations of blue, purple, red, and green palettes with single hue and monotonic chroma (left), single hue and triangular chroma (center), and multiple hues and triangular chroma (right).

spacings, borders, etc. These heuristics are selected to work well for `hcl_palettes()` and might need further tweaking in future versions of the package. Thus, Figures 1–2 as well as Figures 8–12 all use `swatchplot()` internally. For a simple stand-alone illustration consider: `swatchplot("Palette" = sequential_hcl(5))`.

Next, we demonstrate a more complex example of a `swatchplot()` with three matrices of sequential color palettes of blues, purples, reds, and greens (see Figure 17). For all palettes, luminance increases monotonically to yield a proper sequential palette. However, the hue and chroma handling is somewhat different to emphasize different parts of the palette.

- *Single-hue*: In each palette the hue is fixed and chroma decreases monotonically (along with increasing luminance). This is typically sufficient to clearly bring out the extreme colors (dark/colorful vs. light gray).
- *Single-hue (advanced)*: The hue is fixed (as above) but the chroma trajectory is triangular. Compared to the basic single-hue palette above this allows to better distinguish the colors in the middle and not only the extremes.
- *Multi-hue (advanced)*: As in the advanced single-hue palette the chroma trajectory is triangular but additionally the hue varies slightly. This can further enhance the distinction of colors in the middle of the palette.

```
R> bprg <- c("Blues", "Purples", "Reds", "Greens")
R> swatchplot(
+ "Single-hue" = t(sapply(paste(bprg, 2), sequential_hcl, n = 7)),
+ "Single-hue (advanced)" = t(sapply(paste(bprg, 3), sequential_hcl, n = 7)),
+ "Multi-hue (advanced)" = t(sapply(bprg, sequential_hcl, n = 7)),
+ nrow = 5, line = 5)
```

5.2. HCL (and RGB) spectrum

As the properties of a palette in terms of the perceptual dimensions *hue*, *chroma*, and *luminance* are not always clear from looking just at color swatches or (statistical) graphics based on these palettes, the `specplot()` function provides an explicit display for the coordinates of the HCL trajectory associated with a palette. This can bring out clearly various aspects, e.g.,

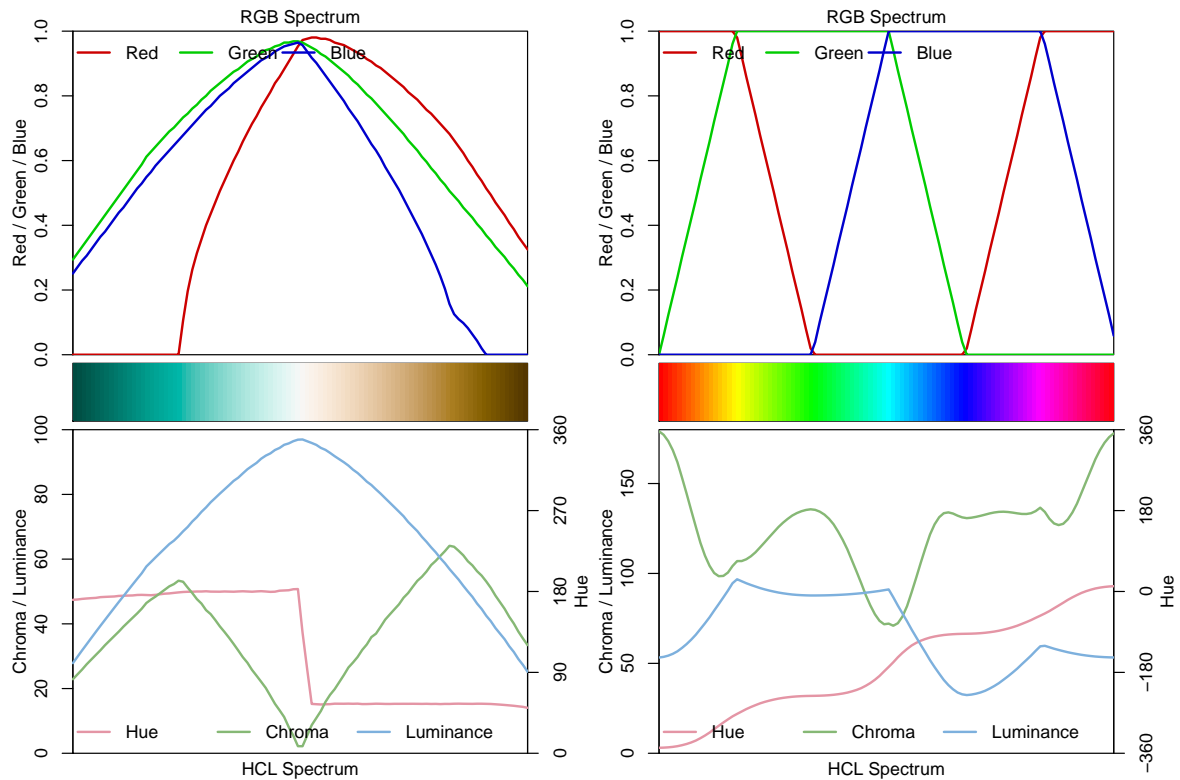

Figure 18: HCL spectrum of the balanced diverging "Green-Brown" palette (left panel) and the (in)famous and rather unbalanced `rainbow()` palette (right panel).

whether hue is constant, chroma is monotonic or triangular, and whether luminance is approximately constant (as in many qualitative palettes), monotonic (as in sequential palettes), or diverging.

The function first transforms a given color palette to its HCL (`polarLUV()`) coordinates. As the hues for low-chroma colors are not (or only poorly) identified, by default a smoothing is applied to the hues. Also, to avoid jumps from 0 to 360 or vice versa, the hue coordinates are shifted suitably. By default, the resulting trajectories in the HCL spectrum are visualized by a simple line plot:

- Hue is drawn in red and coordinates are indicated on the axis on the right with range $[0, 360]$ or (if necessary) $[-360, 360]$.
- Chroma is drawn in green with coordinates on the left axis. The range $[0, 100]$ is used unless the palette necessitates higher chroma values.
- Luminance is drawn in blue with coordinates on the left axis in the range $[0, 100]$.

Additionally, a color swatch for the palette is included. Optionally, a second spectrum for the corresponding trajectories of RGB coordinates can be included. However, this is usually just of interest for palettes created in RGB space (or simple transformations of RGB).

As spectrum plots have already been used for illustration in Figures 5 (for a qualitative palette) as well as 6 and 15 (for sequential palettes), this section only provides a couple of additional illustrations. The diverging "Green-Brown" palette is depicted in the left panel

of Figure 18. It simply combines a green and a brown/yellow sequential single-hue palette, both with triangular chroma trajectory. Hue is constant in each “arm” of the palette and the chroma/luminance trajectories are rather balanced between both arms. In the center the palette passes through a light gray (with zero chroma) as the neutral value. By including the corresponding RGB spectrum in the top panel, it also becomes apparent that choosing such well-balanced palettes through trajectories in RGB color space is not straightforward. This balanced palette – based on relatively simple HCL trajectories – is contrasted with a poorly-balanced palette – based on simple linear RGB trajectories in the right panel of Figure 18. This depicts the RGB and HCL spectrum of the (in)famous RGB rainbow palette. (See [Hawkins *et al.* 2014](#), for a plea why the RGB rainbow palette should be avoided in almost all scientific graphics.)

```
R> specplot(diverging_hcl(100, "Green-Brown"), rgb = TRUE)
R> specplot(rainbow(100), rgb = TRUE)
```

The RGB spectrum of the rainbow palette shows that the trajectories are quite simple in RGB space but lead to substantial variations in chroma and (more importantly) luminance. This is why this palette is not suitable for encoding underlying data in statistical graphics. See also the related discussion of color vision deficiency in Section 6.

5.3. Trajectories in HCL space

While the `specplot()` function above works well for bringing out the HCL coordinates associated with a given palette, it does not show how the palette fits into the HCL space. For example, it is not so clear whether high chroma values are close to the maximum possible for a given hue. Thus, it cannot be judged so easily how the parameters of the hue, chroma, and luminance trajectories can be modified to obtain another palette.

Therefore, the `hclplot()` is another visualization of the HCL coordinates associated with a palette. It does so by collapsing over one of the coordinates (either the hue H or the luminance L) and displays a heatmap of colors combining the remaining two dimensions. The coordinates for the given color palette are highlighted to bring out its trajectory. In case the hue is really fixed (as in single-hue sequential palettes) or the luminance is really fixed (as in the qualitative palettes), collapsing is straightforward. However, when the coordinate that is collapsed over is actually not constant in the palette, a simple bivariate linear model is used to capture how the collapsed coordinate varies along with the two displayed coordinates.

The function `hclplot()` has been designed to work well with the `hcl_palettes()` in this package. While it is possible to apply it to other color palettes as well, the results might look weird or confusing if these palettes are constructed very differently (e.g., like the highly-saturated base R palettes). To infer the default `type` of projection `hclplot()` assesses the luminance trajectory and sets the default correspondingly:

- `type = "qualitative"` if luminance is approximately constant.
- `type = "sequential"` if luminance is monotonic.
- `type = "diverging"` if luminance is diverging with two monotonic “arms” in the trajectory.

Thus, for qualitative palettes – where luminance and chroma are fixed – the varying hue is displayed in a projection onto the hue-chroma plane at a given fixed luminance (Figure 19):

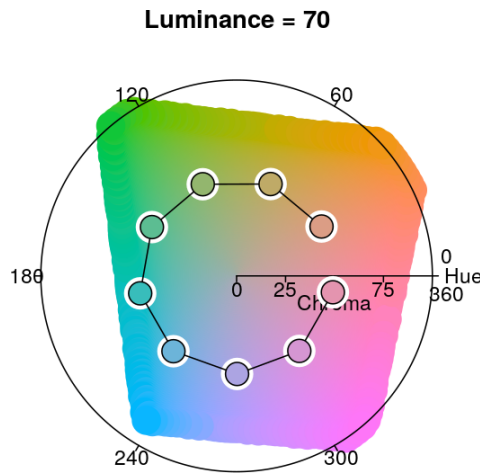

Figure 19: Hue-chroma plane with luminance fixed at $L = 70$ along with the qualitative "Dynamic" palette with varying hue H and chroma fixed at $C = 50$.

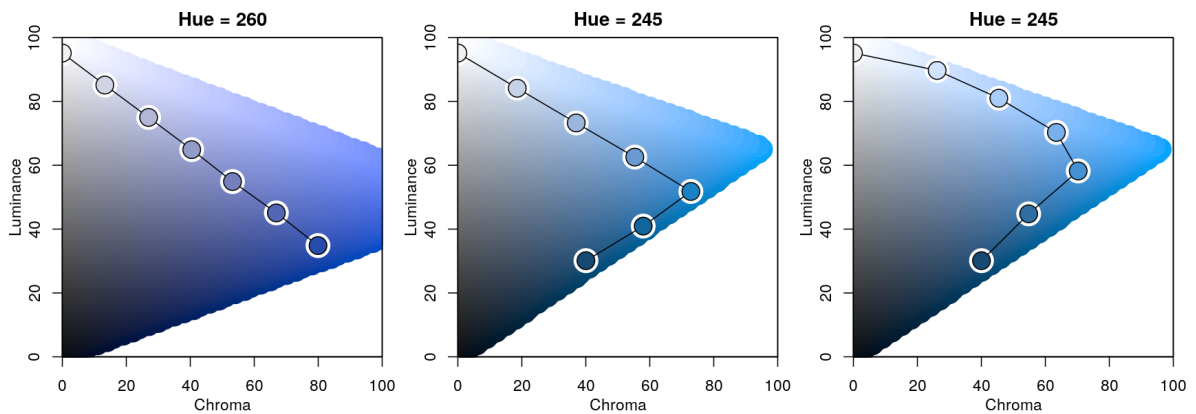

Figure 20: Luminance-chroma plane with variations of blue sequential single-hue palettes (similar to "Blues 2" and "Blues 3"). Left: Linear chroma for $H = 260$. Center: Triangular chroma for $H = 245$. Right: Power-transformed triangular chroma for $H = 245$.

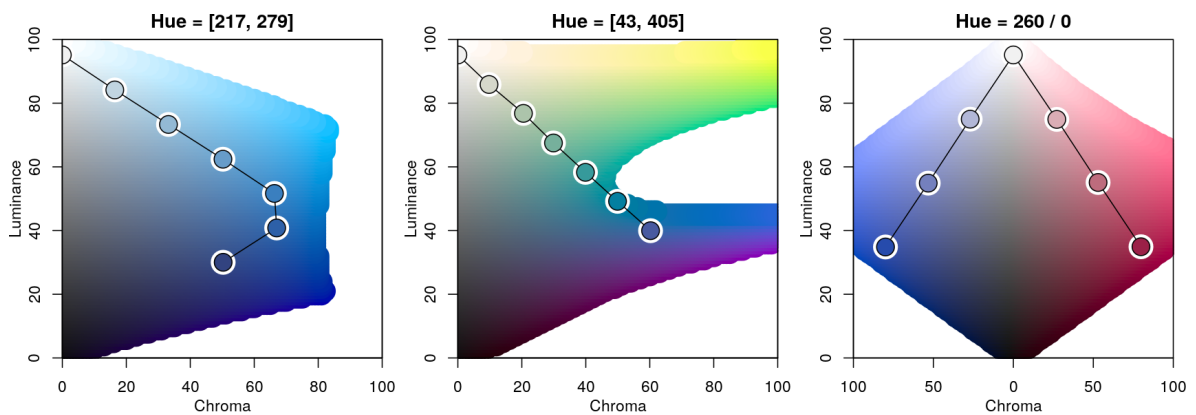

Figure 21: Luminance-chroma plane with blue multi-hue palette and triangular chroma (left), blue-yellow multi-hue palette and linear chroma (center), and diverging blue-red palette with balanced linear chroma.

```
R> hclplot(qualitative_hcl(9, "Dynamic"))
```

Figure 20 compares three single-hue sequential palettes by projection to the luminance-chroma plane for the given fixed hue. In the left panel the hue 260 is used with a simple linear chroma trajectory. The other two panels employ a triangular chroma trajectory for hue 245, either with a piecewise-linear (center) or power-transformed (right) trajectory.

```
R> par(mfrow = c(1, 3))
R> hclplot(sequential_hcl(7, h = 260, c = 80, l = c(35, 95), power = 1))
R> hclplot(sequential_hcl(7, h = 245, c = c(40, 75, 0), l = c(30, 95),
+   power = 1))
R> hclplot(sequential_hcl(7, h = 245, c = c(40, 75, 0), l = c(30, 95),
+   power = c(0.8, 1.4)))
```

Note that for $H = 260$ it is possible to go to dark colors (= low luminance) with high chroma while this is not possible to the same extent for $H = 245$ due to the distorted shape of the HCL space. Hence, chroma has to be decreased when proceeding to the dark low-luminance colors. Finally, Figure 21 compares two multi-hue sequential palettes along with a diverging palette.

```
R> par(mfrow = c(1, 3))
R> hclplot(sequential_hcl(7, h = c(260, 220), c = c(50, 75, 0),
+   l = c(30, 95), power = 1))
R> hclplot(sequential_hcl(7, h = c(260, 60), c = 60, l = c(40, 95),
+   power = 1))
R> hclplot(diverging_hcl(7, h = c(260, 0), c = 80, l = c(35, 95),
+   power = 1))
```

The multi-hue palette on the left employs a small hue range, resulting in a palette of “blues” just with slightly more distinction of the middle colors in the palette. In contrast, the multi-hue “blue-yellow” palette in the center panel uses a large hue range, resulting in more color contrasts throughout the palette. Finally, the balanced diverging palette in the right panel is constructed from two simple single-hue sequential palettes (for hues 260/blue and 0/red) that are completely balanced between the two “arms” of the palette.

5.4. Demonstration of statistical graphics

To demonstrate how different kinds of color palettes work in different kinds of statistical displays, `demoplot()` provides a simple convenience interface to some base graphics with (mostly artificial) data sets. As a first overview, Figure 22 displays all built-in demos with the same sequential heat colors palette: `sequential_hcl(5, "Heat")`. All types of demos can, in principle, deal with arbitrarily many colors from any palette but clearly the graphics differ in various respects such as:

- Work best for fewer colors (e.g., bar, pie, scatter, lines, ...) vs. many colors (e.g., heatmap, perspective, ...).
- Intended for categorical data (e.g., bar, pie, ...) vs. continuous numeric data (e.g., heatmap, perspective, ...).
- Shading areas (e.g., map, bar, pie, ...) vs. shading points or lines (scatter, lines).

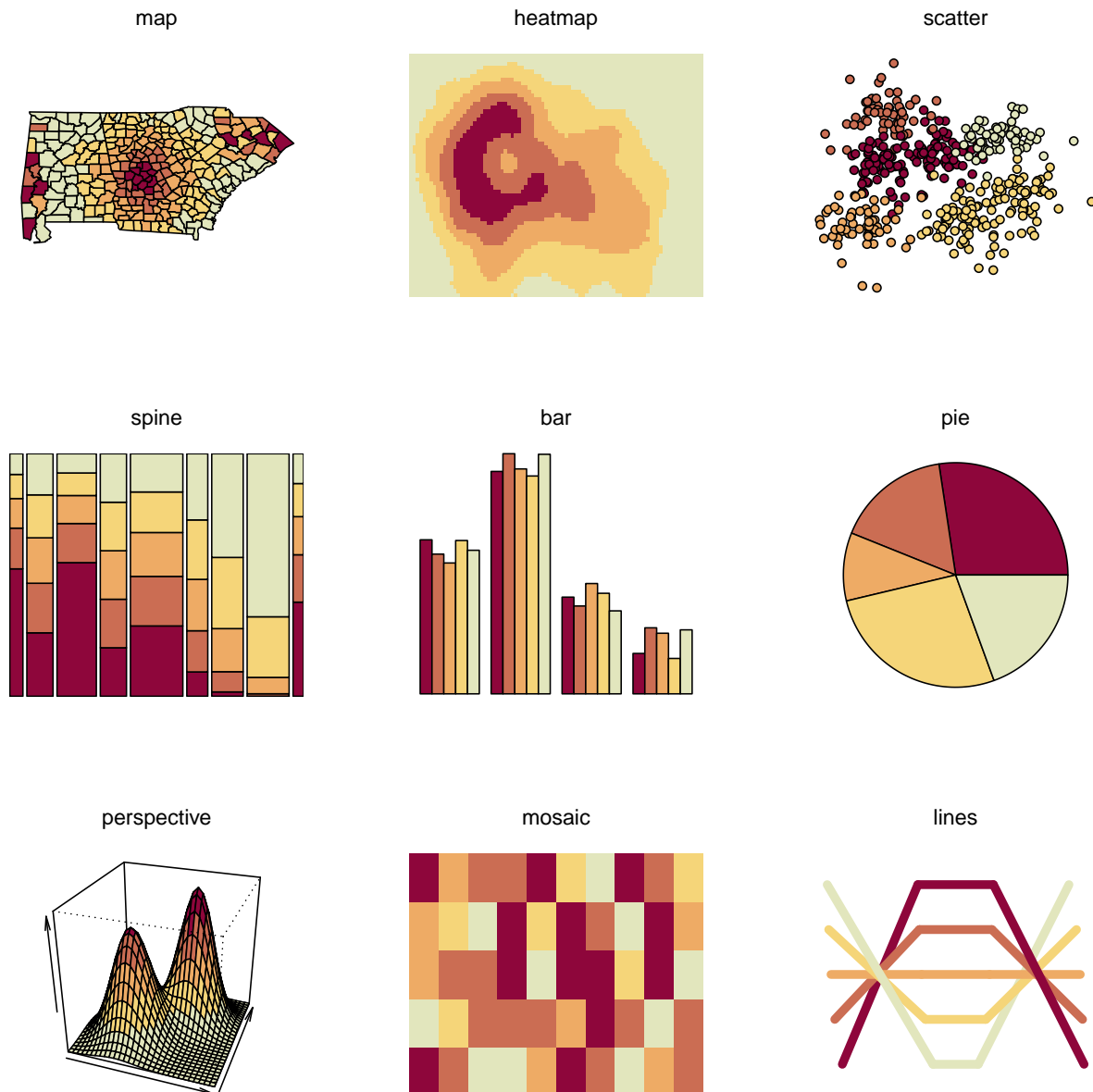

Figure 22: All built-in demoplot types with the same `sequential_hcl(5, "Heat")` palette.

Hence, in the following some further illustrations are organized by type of palette, using suitable demos for the particular palettes.

Qualitative palettes: Light pastel colors typically work better for shading areas (pie, left) while darker and more colorful palettes are usually preferred for points (center) or lines (right).

```
R> par(mfrow = c(1, 3))
R> demoplot(qualitative_hcl(4, "Pastel 1"), type = "pie")
R> demoplot(qualitative_hcl(4, "Set 2"), type = "scatter")
R> demoplot(qualitative_hcl(4, "Dark 3"), type = "lines")
```

Sequential palettes: Heatmaps (left) or perspective plots (center) often employ almost con-

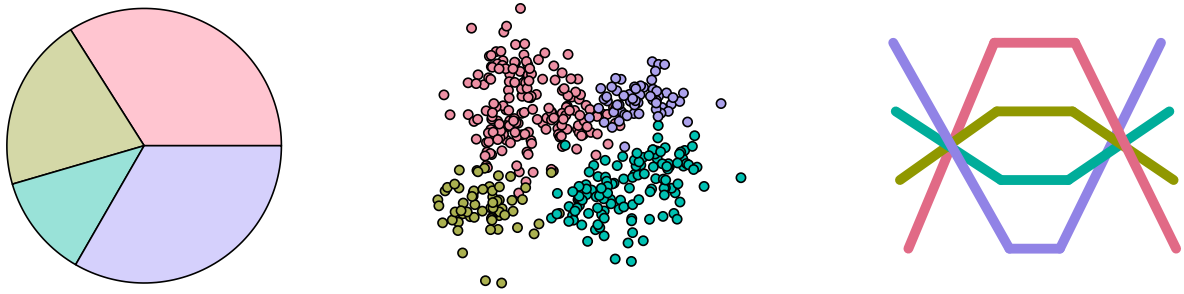
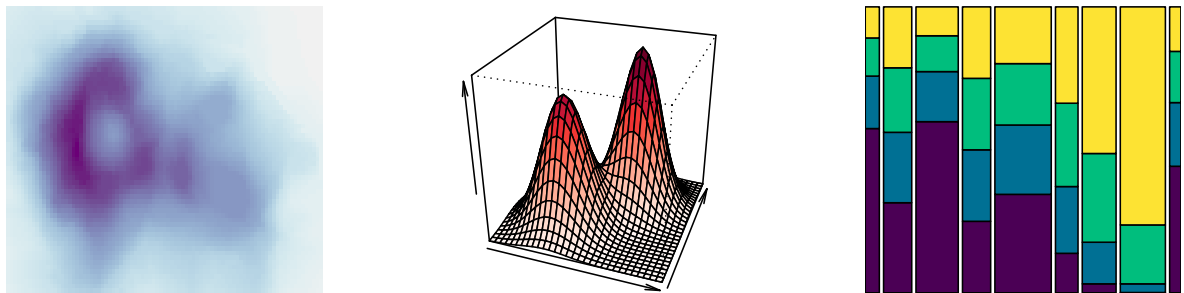
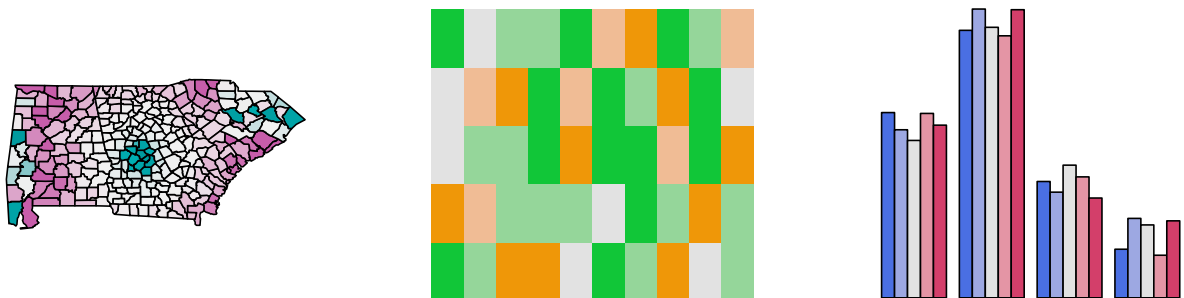
Figure 23: Examples for `demoplot()` with different `qualitative_hcl()` palettes.Figure 24: Examples for `demoplot()` with different `sequential_hcl()` palettes.Figure 25: Examples for `demoplot()` with different `diverging_hcl()` palettes.

tinuous gradients with strong luminance contrasts. In contrast, when only a few ordered categories are to be displayed (e.g., in a spine plot, right) more colorful sequential palettes like the `viridis` palette can be useful.

```
R> par(mfrow = c(1, 3))
R> demoplot(sequential_hcl(99, "Purple-Blue"), type = "heatmap")
R> demoplot(sequential_hcl(99, "Reds"), type = "perspective")
R> demoplot(sequential_hcl( 4, "Viridis"), type = "spine")
```

Diverging palettes: In some displays (such as the map, left), it is useful to employ an almost continuous gradient with strong luminance contrast to bring out the extremes. Here, this contrast is amplified by a larger power transformation emphasizing the extremes even further. In contrast, when fewer colors are needed more colorful palettes with lower luminance contrasts can be desired. This is exemplified by a mosaic (center) and bar plot (right).

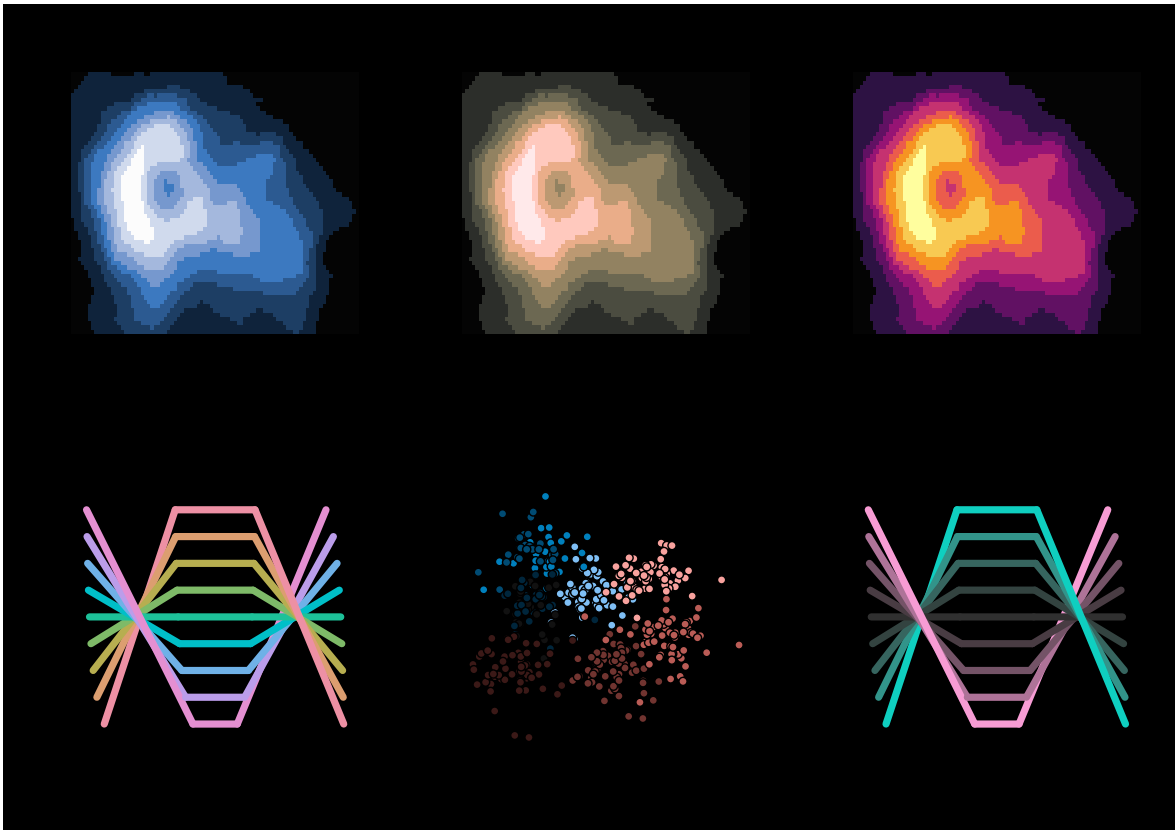

Figure 26: Examples for `demoplot()` with different palettes that work well on a black/dark background.

```
R> par(mfrow = c(1, 3))
R> demoplot(diverging_hcl(99, "Tropic", power = 2.5), type = "map")
R> demoplot(diverging_hcl( 5, "Green-Orange"),          type = "mosaic")
R> demoplot(diverging_hcl( 5, "Blue-Red 2"),           type = "bar")
```

Figures 23–25 focused on palettes designed for light/white backgrounds. Therefore, to conclude, some palettes are highlighted in Figure 26 that work well on dark/black backgrounds.

```
R> par(mfrow = c(2, 3), bg = "black")
R> demoplot(sequential_hcl(9, "Oslo"), "heatmap")
R> demoplot(sequential_hcl(9, "Turku"), "heatmap")
R> demoplot(sequential_hcl(9, "Inferno", rev = TRUE), "heatmap")
R> demoplot(qualitative_hcl(9, "Set 2"), "lines")
R> demoplot(diverging_hcl(9, "Berlin"), "scatter")
R> demoplot(diverging_hcl(9, "Cyan-Magenta", 12 = 20), "lines")
```

6. Color vision deficiency emulation

Using the physiologically-based model for simulating color vision deficiency (CVD) of Machado, Oliveira, and Fernandes (2009) different kinds of limitations can be emulated: deuteranope (green cone cells defective), protanope (red cone cells defective), and tritanope (blue cone cells defective).

Below we briefly describe our R interface to these emulation techniques and show them in practice for a heatmap with sequential palette. Another diverging palette example is available at http://colorspace.R-Forge.R-project.org/articles/color_vision_deficiency.html. Finally, CVD emulation is particularly useful for bringing out why the RGB rainbow palette is almost always a bad choice in scientific displays. See <http://colorspace.R-Forge.R-project.org/articles/endrainbow.html> for further illustrations.

6.1. R functions

The workhorse function to emulate color-vision deficiency is `simulate_cvd()`, which can take any vector of valid R colors and transform them according to a certain CVD transformation matrix and transformation equation. The transformation matrices have been established by Machado *et al.* (2009) and are provided in objects `protanomaly_cvd`, `deutanomaly_cvd`, and `tritanomaly_cvd`. The convenience interfaces `deutan()`, `protan()`, and `tritan()` are the high-level functions for simulating the corresponding kind of color blindness with a given severity (calling `simulate_cvd()` internally).

For further guidance on color blindness in relation to statistical graphics see Lumley (2006) which accompanies the R package `dichromat` (Lumley 2013) and is based on earlier emulation techniques (Viénot, Brettel, Ott, M'Barek, and Mollon 1995; Brettel, Viénot, and Mollon 1997; Viénot, Brettel, and Mollon 1999).

6.2. Illustration: Heatmap with sequential palette

To illustrate that poor color choices can severely reduce the usefulness of a statistical graphic for readers with color vision deficiencies, we employ the infamous RGB rainbow color palette in a heatmap. In base R this can be generated by `rainbow(11, end = 2/3)` ranging from red (for high values) to blue (for low values). The poor results for the RGB rainbow palette are contrasted in Figure 28 with a proper sequential palette ranging from dark blue to light yellow: `sequential_hcl(11, "Blue-Yellow")`.

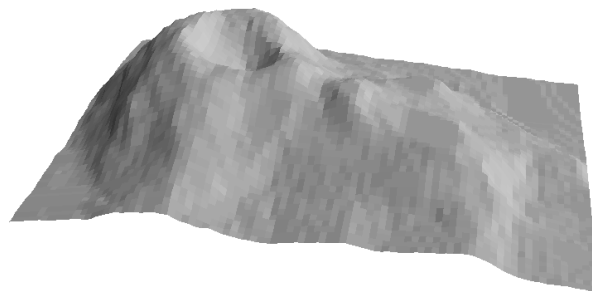

Figure 27: Perspective visualization of Maunga Whau volcano data (Mount Eden, Auckland, New Zealand).

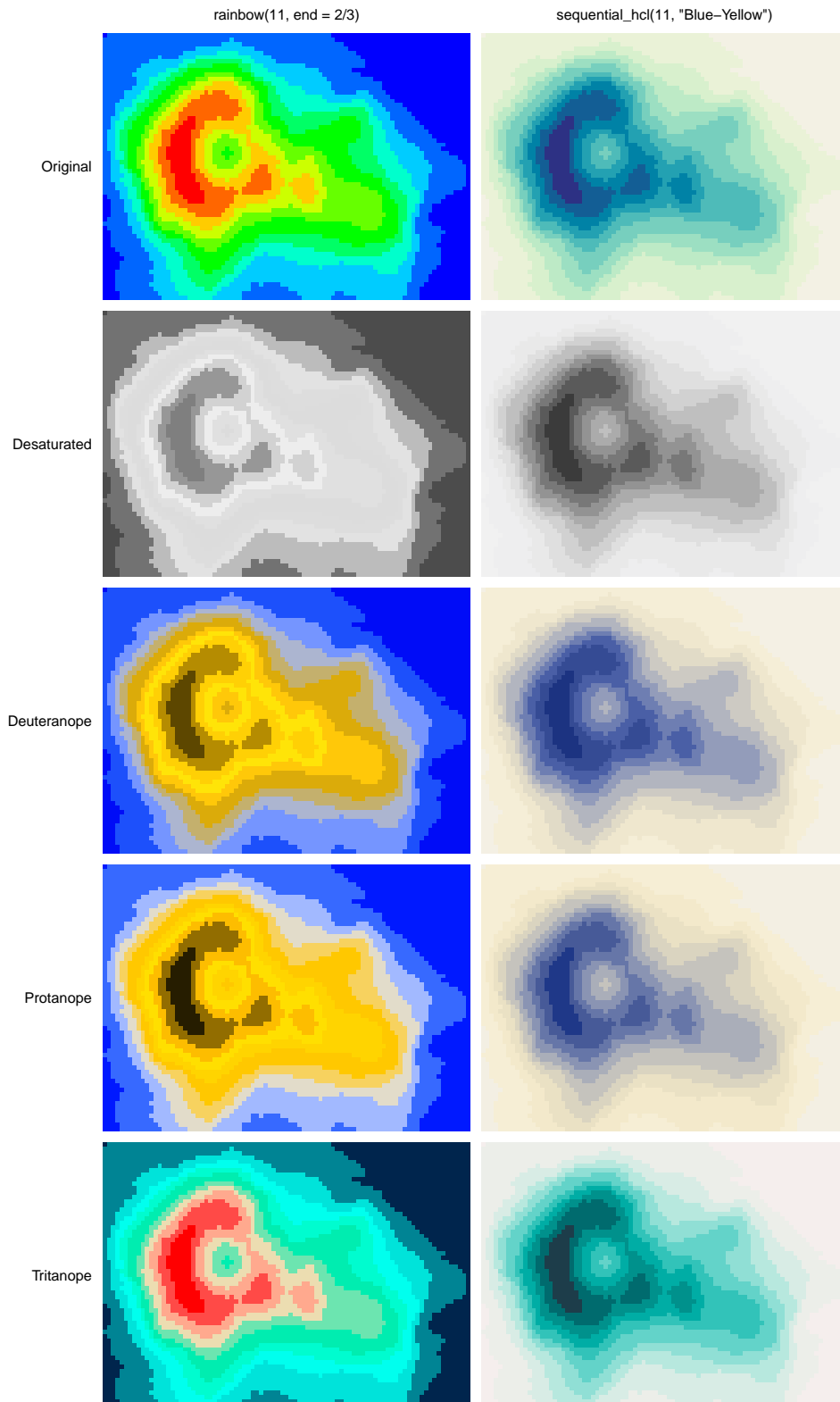

Figure 28: Heatmap of Maunga Whau volcano data with RGB rainbow (left) and HCL-based blue-yellow palette (right). The first row shows the original color palettes while subsequent rows emulate various color deficiencies.

The statistical graphic employed for illustration is a heatmap of the well-known Maunga Whau volcano data from base R. This heatmap is easily available as `demoplot(..., "heatmap")` where `...` is the color vector to be used, e.g.,

```
R> rainbow(11, end = 2/3)
```

```
[1] "#FF0000FF" "#FF6600FF" "#FFCC00FF" "#CCFF00FF" "#66FF00FF"
[6] "#00FF00FF" "#00FF66FF" "#00FFCCFF" "#00CCFFFF" "#0066FFFF"
[11] "#0000FFFF"
```

```
R> deutan(rainbow(11, end = 2/3))
```

```
[1] "#5D4700FF" "#B58C01FF" "#FFD005FF" "#FFE408FF" "#FFC809FF"
[6] "#DBAB0AFF" "#C4B06DFF" "#ACB5D0FF" "#7595FFFF" "#1D50FBFF"
[11] "#000CF7FF"
```

and so on. To aid the interpretation of the heatmap a perspective display using only gray shades is provided in Figure 27, providing another intuitive display of what the terrain around Maunga Whau looks like.

Subsequently, all combinations of palette and color vision deficiency are visualized. Additionally, a grayscale version is created with `desaturate()`. This clearly shows how poorly the RGB rainbow performs, often giving quite misleading impressions of what the terrain around Maunga Whau looks like. In contrast, the HCL-based blue-yellow palette works reasonably well in all settings. The most important problem of the RGB rainbow is that it is not monotonic in luminance, making correct interpretation quite hard. Moreover, the red-green contrasts deteriorate substantially in the dichromatic emulations.

7. Apps for choosing colors and palettes interactively

To facilitate exploring the package and employing it when working with colors, several graphical user interfaces (GUIs) are provided within the package as **shiny** apps (Chang *et al.* 2018). All of these GUIs/apps can either be run locally from within R but are also provided online at <http://hclwizard.org/>.

- *Palette constructor*: `choose_palette()` or `hclwizard()` or `hcl_wizard()`.
- *Color picker*: `choose_color()` or equivalently `hcl_color_picker()`.
- *Color vision deficiency emulator*: `cvd_emulator()`.

In addition to the **shiny** version, the *palette constructor* app is also available as a Tcl/Tk GUI via R package **tcltk** shipped with base R (R Core Team 2018). The **tcltk** version can only be run locally and is considerably faster while the **shiny** version has a nicer interface with more features and can be run online. The `choose_palette()` function by default starts the **tcltk** version while `hclwizard()/hcl_wizard()` by default start the **shiny** version.

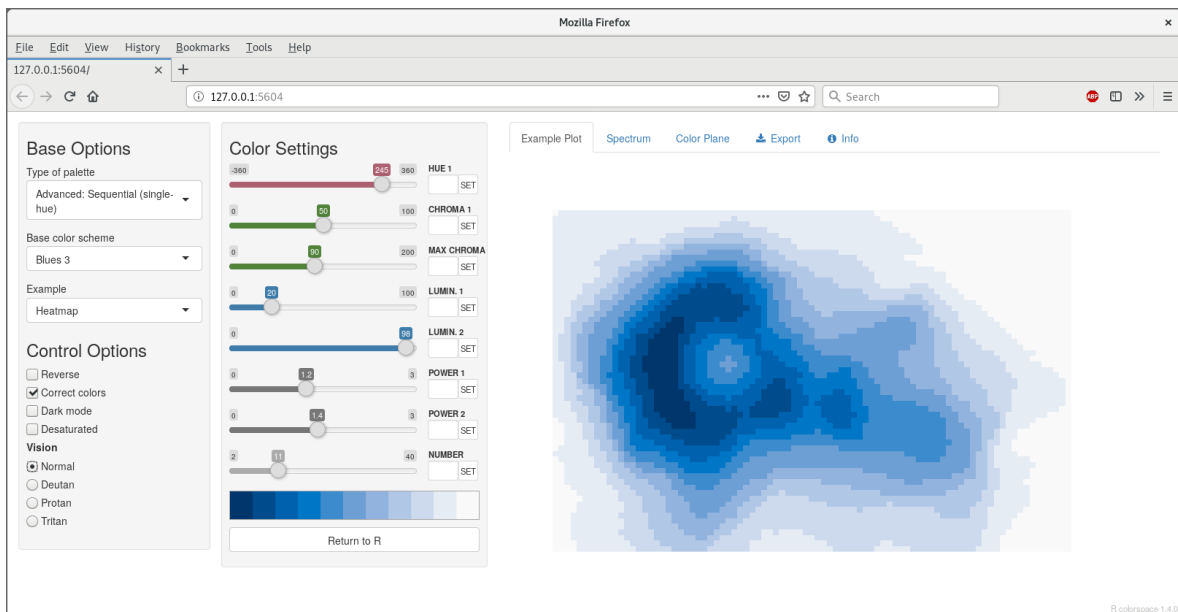

Figure 29: App for interactively choosing HCL-based color palettes: `choose_color()/hclwizard()`.

7.1. Choose palettes with the HCL color model

The **shiny** version of this GUI is shown in Figure 29. It interfaces the `qualitative_hcl()`, `sequential_hcl()`, and `diverging_hcl()` palettes from Section 4. The GUIs allow for interactive modification of the arguments of the respective palette-generating functions, i.e., starting/ending hue, minimal/maximal chroma, minimal maximal luminance, and power transformations that control how quickly/slowly chroma and/or luminance are changed through the palette. Subsets of the parameters may not be applicable depending on the type of palette chosen.

Optionally, the active palette can be illustrated by using a `specplot()` (see Section 5.2), `hclplot()` (see Section 5.3), or `demoplot()` (see Section 5.4), and assessed using emulation of color vision deficiencies (see Section 6). To facilitate generation of palettes for black/dark backgrounds, a “dark mode” of the GUIs is also available.

7.2. Choose individual colors with the HCL color model

This GUI can be started with either `choose_color()` or equivalently `hcl_color_picker()`. It shows the HCL color space either as a hue-chroma plane for a given luminance value or as a luminance-chroma plane for a given hue. Colors can be entered by:

- Clicking on a color coordinate in the hue-chroma or luminance-chroma plane.
- Specifying the hue/chroma/luminance values via sliders.
- Entering an RGB hex code.

By repeating the selection a palette of colors can be constructed and returned within R for subsequent usage in visualizations.

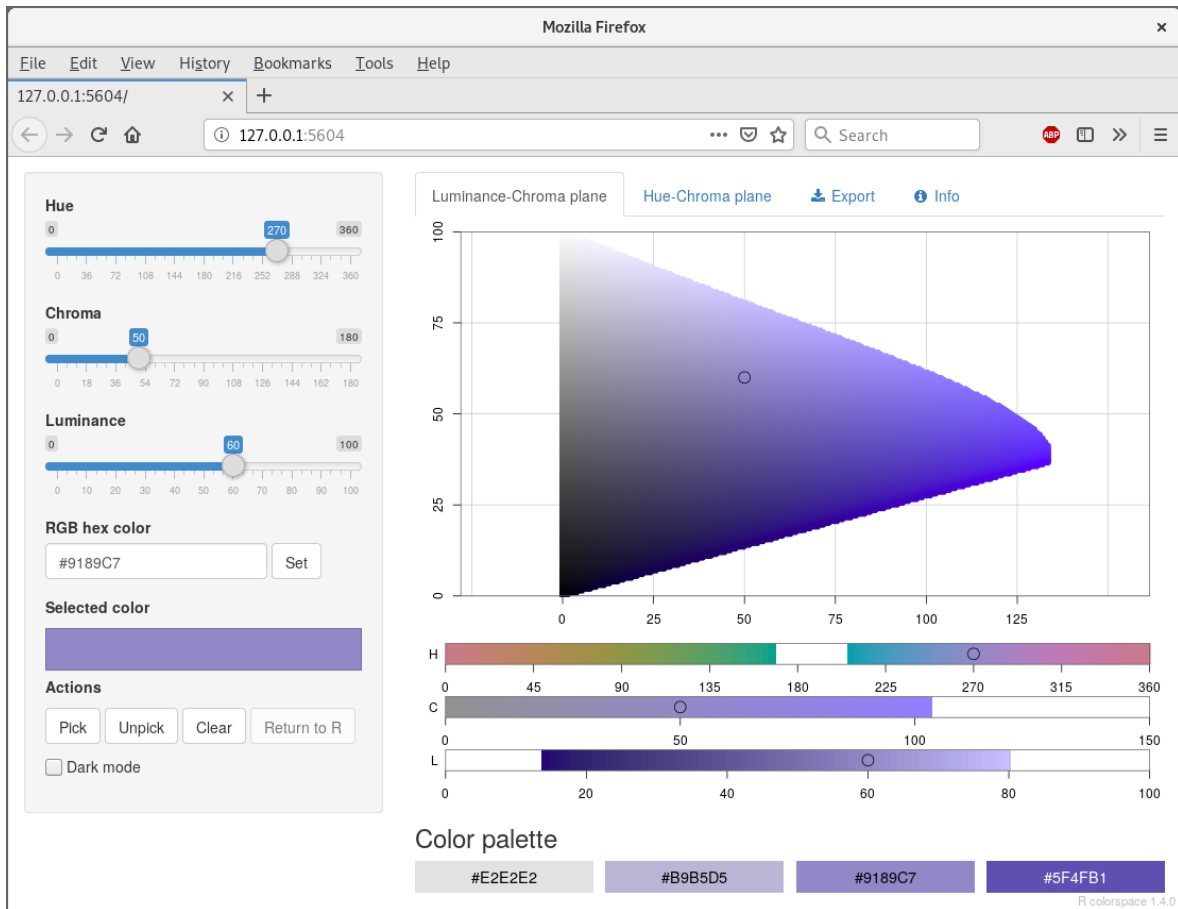

Figure 30: App for interactively choosing individual colors in HCL space: `choose_color()/hcl_color_picker()`.

7.3. Emulate color vision deficiencies

This GUI can be started with `cvd_emulator()`. It allows to upload a raster image in JPG or PNG format which is then checked for various kinds of color vision deficiencies at the selected severity. By default the severity is set to 100% and all supported kinds of color vision deficiency are checked for.

8. Color manipulation and utilities

The **colorspace** package provides several color manipulation utilities that are useful for creating, assessing, or transforming color palettes, namely:

- `desaturate()`: Desaturate colors by chroma removal in HCL space.
- `darken()` and `lighten()`: Algorithmically lighten or darken colors in HCL and/or HLS space.
- `max_chroma()`: Compute maximum chroma for given hue and luminance in HCL space.
- `mixcolor()`: Additively mix two colors by computing their convex combination.

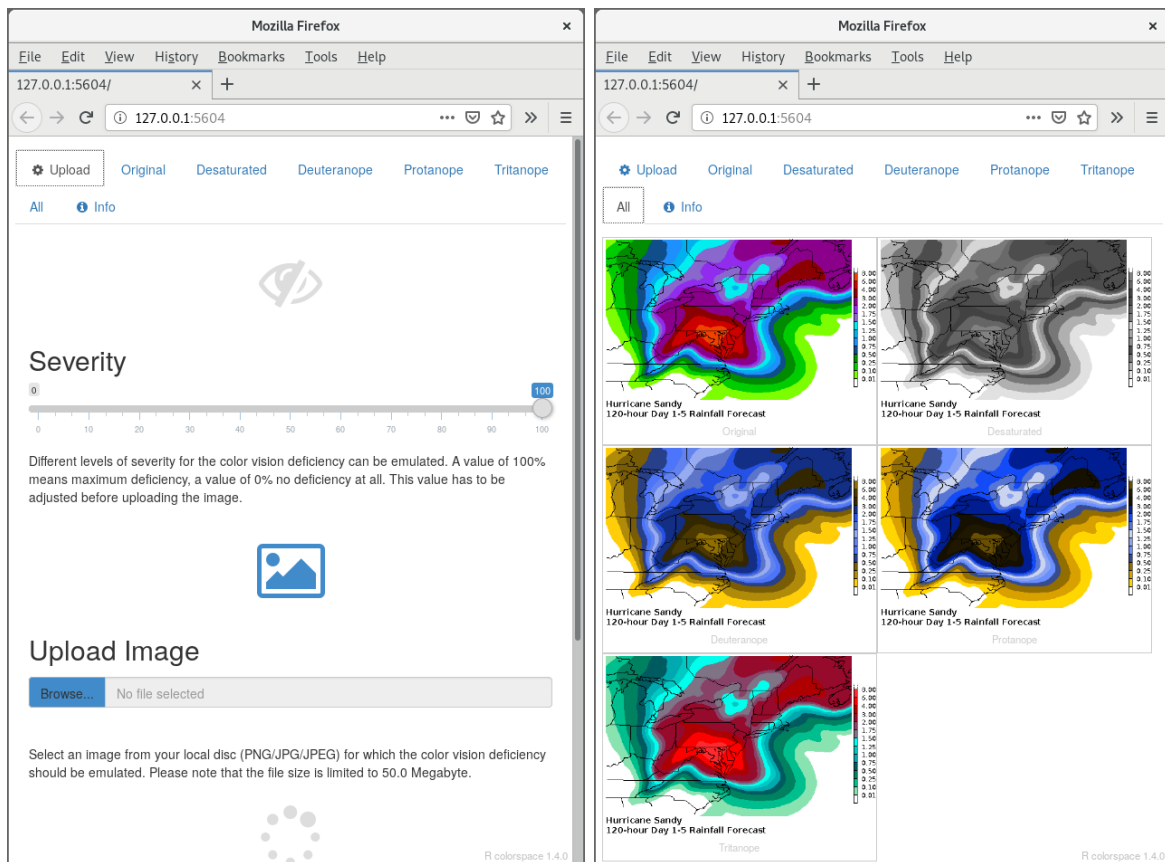

Figure 31: App for emulating color vision deficiencies for uploaded raster images: `cvd_emulator()`.

8.1. Desaturation in HCL space

Desaturation should map a given color to the gray with the same “brightness”. In principle, any perceptually-based color model (HCL, HLS, HSV, ...) could be employed for this but HCL works particularly well because its coordinates capture the perceptual properties better than most other color models.

The `desaturate()` function converts any given hex color code or named R color to the corresponding HCL coordinates and sets the chroma to zero. Thus, only the luminance matters which captures the “brightness” mentioned above. Finally, the resulting HCL coordinates are transformed back to hex color codes for use in R. First, `desaturate()` is used to desaturate a vector of R color names:

```
R> desaturate(c("white", "orange", "blue", "black"))
```

```
[1] "#FFFFFF" "#B8B8B8" "#4C4C4C" "#000000"
```

Notice that the hex codes corresponding to three coordinates in sRGB space are always the same, indicating gray colors. Analogously, hex color codes can also be transformed – in this case RGB rainbow colors from the base R function `rainbow()`:

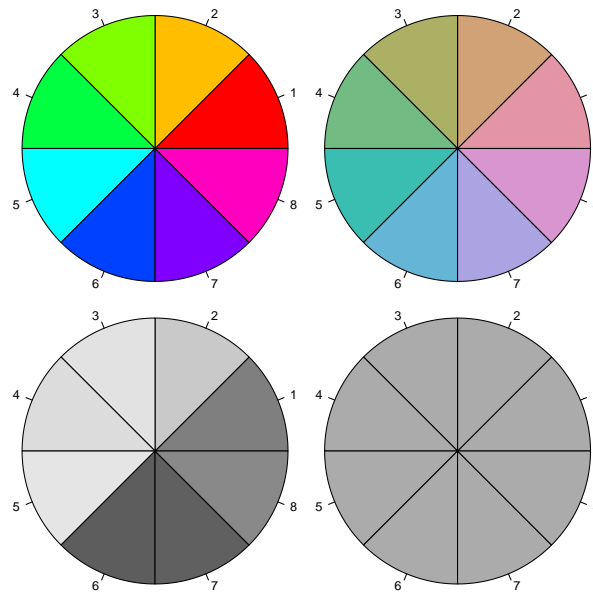

Figure 32: Color wheels in RGB (left) and HCL (right) space in color (top) and desaturated grayscale (bottom).

```
R> rainbow(3)

[1] "#FF0000FF" "#00FF00FF" "#0000FFFF"

R> desaturate(rainbow(3))

[1] "#7F7F7FFF" "#DCDCDCFF" "#4C4C4CFF"
```

Already this simple example shows that the three RGB rainbow colors have very different grayscale levels. This can be brought even more clearly when using a full color wheel (of colors with hues in $[0, 360]$ degrees). While the RGB `rainbow()` is very unbalanced, the HCL `rainbow_hcl()` (or also `qualitative_hcl()`) is (by design) balanced with respect to luminance.

```
R> wheel <- function(col, radius = 1, ...)
+   pie(rep(1, length(col)), col = col, radius = radius, ...)
R> par(mar = rep(0.5, 4), mfrow = c(2, 2))
R> wheel(rainbow(8))
R> wheel(rainbow_hcl(8))
R> wheel(desaturate(rainbow(8)))
R> wheel(desaturate(rainbow_hcl(8)))
```

8.2. Lighten or darken colors

In principle, a similar approach for lightening and darkening colors can be employed as for desaturation above. The colors can simply be transformed to HCL space and then the luminance can either be decreased (turning the color darker) or increased (turning it lighter) while

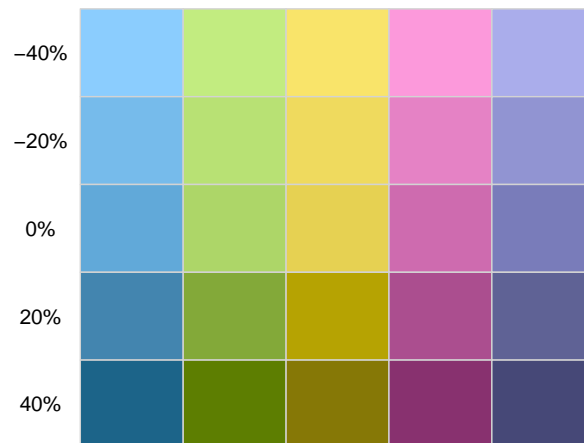

Figure 33: Okabe-Ito palette (0%) along with two levels of both lightening and darkening, respectively.

preserving the hue and chroma coordinates. This strategy typically works well for lightening colors, although in some situations the result can be somewhat too colorful. Conversely, when darkening rather light colors with little chroma, this can result in rather gray colors.

In these situations, an alternative might be to apply the analogous strategy in HLS space which is frequently used in HTML style sheets. However, this strategy may also yield colors that are either too gray or too colorful. A compromise that sometimes works well is to adjust the luminance coordinate in HCL space but to take the chroma coordinate corresponding the HLS transformation.

We have found that typically the HCL-based transformation performs best for lightening colors and this is hence the default in `lighten()`. For darkening colors, the combined strategy often works best and is hence the default in `darken()`. In either case it is recommended to try the other available strategies in case the default yields unexpected results.

Regardless of the chosen color space, the adjustment of the L component by a certain `amount` can occur by two methods, relative (the default) or absolute. For example for darkening these either use $L - 100 * \text{amount}$ (absolute) or $L * (1 - \text{amount})$ (relative). See `?lighten` and `?darken` for more details.

For illustration the qualitative palette suggested by [Okabe and Ito \(2008\)](#) is transformed by two levels of both lightening and darkening, respectively.

```
R> oi <- c("#61A9D9", "#ADD668", "#E6D152", "#CE6BAF", "#797CBA")
R> swatchplot(
+   "-40%" = lighten(oi, 0.4),
+   "-20%" = lighten(oi, 0.2),
+   " 0%" = oi,
+   " 20%" = darken(oi, 0.2),
+   " 40%" = darken(oi, 0.4),
+   off = c(0, 0)
+ )
```

8.3. Maximum chroma for given hue and luminance

As the possible combinations of chroma and luminance in HCL space depend on hue, it is not obvious which trajectories through HCL space are possible prior to trying a specific HCL coordinate by calling `polarLUV()`. To avoid having to fix up the color upon conversion to RGB `hex()` color codes, the `max_chroma()` function computes (approximately) the maximum chroma possible. For illustration we show that for given luminance (here: $L = 50$) the maximum chroma varies substantially with hue:

```
R> max_chroma(seq(0, 360, by = 60), 50)

[1] 137.96  59.99  69.06  39.81  65.45 119.54 137.96
```

Similarly, maximum chroma also varies substantially across luminance values for a given hue (here: $H = 120$, green):

```
R> max_chroma(120, seq(0, 100, by = 20))

[1]  0.00  28.04  55.35  82.79 110.28  0.00
```

8.4. Additive mixing of two colors

In additive color models like `RGB()` or `XYZ()` it can be useful to combine colors by additive mixing. Below a fully saturated red and green are mixed, yielding a medium brownish yellow.

```
R> R <- RGB(1, 0, 0)
R> G <- RGB(0, 1, 0)
R> Y <- mixcolor(0.5, R, G)
R> Y
```

```
      R   G B
[1,] 0.5 0.5 0
```

9. Summary and discussion

This manuscript provides an overview of the broad capabilities of the **colorspace** package for selecting individual colors or color palettes, manipulating these colors, and employing them in various kinds of visualizations.

In particular, the package provides various qualitative, sequential, and diverging palettes derived by relatively simple trajectories in HCL (Hue–Chroma–Luminance) space. In contrast to many other packages providing modern balanced color palettes (such as **ColorBrewer.org**, **CARTO**, **viridis**, or **scico**) special emphasis is given to flexibility of the palettes that can be adjusted to the particular needs of a given data visualization. The manuscript also provides various tips and tricks for choosing an effective palette in a given situation. Further useful guidance is provided in many sources, including: [Ware \(1988\)](#), [Okabe and Ito \(2008\)](#), [Aigner](#)

(2010), Stauffer *et al.* (2015), Zhang (2015), Rost (2018), Wilke (2019), and Ciechanowski (2019), among many others.

Further R packages that can complement the palettes provided by **colorspace** include: **Polychrome** (Coombes and Brock 2018; Coombes, Brock, Abrams, and Abruzzo 2018) implements strategies for qualitative palettes with many “categories”. While the qualitative palettes in Section 4 yield only about 6–8 clearly distinguishable colors due to the fixed chroma and luminance, **Polychrome** relaxes this restriction and can thus find a larger number of colors in CIELUV space that are spaced as far apart as possible. It also has several functions for visualizing color palettes in different ways. The palette collection packages **pals** (Wright 2018) and **paletteer** (Hvitfeldt 2019) also provide a wide range of prespecified palettes, including some qualitative schemes with many categories. Note that the palettes are quite diverse, though, and not all of them are equally suitable for coding qualitative information. The visualization functions in **colorspace** from Section 5 may be helpful in assessing their properties. **roloc** (Murrell 2018b,a) also provides color conversions, but not between numeric colour spaces; instead, from numeric color spaces to English color names.

In addition to the R version of **colorspace**, a Python 2/Python 3 re-implementation is in beta and available at <https://github.com/retostauffer/python-colorspace>. In the manuscript we focus on the more mature R implementation but replication materials for most examples are not only provided for R but also for Python.

Computational details

The results in this paper were obtained using R 3.5.2 (R Core Team 2018) with the packages **colorspace** 1.4.1 (Ihaka *et al.* 2019), **ggplot2** 3.1.0 (Wickham *et al.* 2018), **RColorBrewer** 1.1.2 (Neuwirth 2014), **rcartocolor** 0.0.22 (Nowosad 2018), **viridis** 0.5.1 (Garnier 2018), **scico** 1.1.0 (Pedersen and Crameri 2018). R itself and all packages used are available from the Comprehensive R Archive Network (CRAN) at <https://CRAN.R-project.org/>.

References

- Aigner W (2010). “Perception and Visualization.” URL http://www.ifs.tuwien.ac.at/~silvia/wien/vu-fovis/PDF-Files/02_perception-visualization_1up.pdf.
- Brettel H, Viénot F, Mollon JD (1997). “Computerized Simulation of Color Appearance for Dichromats.” *Journal of the Optical Society of America A*, **14**, 2647–2655. doi:10.1364/josaa.14.002647.
- Brewer CA (1999). “Color Use Guidelines for Data Representation.” In *Proceedings of the Section on Statistical Graphics, American Statistical Association*, pp. 55–60. Alexandria, VA. URL <http://www.personal.psu.edu/faculty/c/a/cab38/ColorSch/ASApaper.html>.
- CARTO (2019). “CARTOCOLORS – Data-Driven Color Schemes.” URL <https://carto.com/carto-colors/>.
- Chang W, Cheng J, Allaire JJ, Xie Y, McPherson J (2018). *shiny: Web Application Framework for R*. R package version 1.1.0, URL <https://CRAN.R-project.org/package=shiny>.

- Ciechanowski B (2019). “Color Spaces.” URL <https://ciechanow.ski/color-spaces/>.
- Coombes K, Brock G, Abrams ZB, Abruzzo LV (2018). “**Polychrome**: Creating and Assessing Qualitative Palettes with Many Colors.” *bioRxiv* 303883. doi:10.1101/303883.
- Coombes KR, Brock G (2018). **Polychrome**: *Qualitative Palettes with Many Colors*. R package version 1.1.1, URL <https://CRAN.R-project.org/package=Polychrome>.
- Cramer F (2018). “Geodynamic Diagnostics, Scientific Visualisation and **StagLab** 3.0.” *Geoscientific Model Development*, **11**(6), 2541–2562. doi:10.5194/gmd-11-2541-2018.
- Gama J, Davis G (2018). **colorscience**: *Color Science Methods and Data*. R package version 1.0.5, URL <https://CRAN.R-project.org/package=colorscience>.
- Garnier S (2018). **viridis**: *Default Color Maps from matplotlib*. R package version 0.5-1, URL <https://CRAN.R-project.org/package=viridis>.
- Harrower MA, Brewer CA (2003). “**ColorBrewer.org**: An Online Tool for Selecting Color Schemes for Maps.” *The Cartographic Journal*, **40**, 27–37. URL <http://ColorBrewer.org/>.
- Hawkins E, McNeill D, Stephenson D, Williams J, Carlson D (2014). “The End of the Rainbow – An Open Letter to the Climate Science Community.” URL <http://www.climate-lab-book.ac.uk/2014/end-of-the-rainbow/>.
- Hvitfeldt E (2019). **paletteer**: *Comprehensive Collection of Color Palettes*. R package version 0.2.1, URL <https://CRAN.R-project.org/package=paletteer>.
- Ihaka R (2003). “Colour for Presentation Graphics.” In K Hornik, F Leisch, A Zeileis (eds.), *Proceedings of the 3rd International Workshop on Distributed Statistical Computing, Vienna, Austria*. ISSN 1609-395X, URL <http://www.ci.tuwien.ac.at/Conferences/DSC-2003/Proceedings/>.
- Ihaka R, Murrell P, Hornik K, Fisher JC, Stauffer R, Wilke CO, McWhite CD, Zeileis A (2019). **colorspace**: *A Toolbox for Manipulating and Assessing Colors and Palettes*. R package version 1.4-0, URL <https://CRAN.R-project.org/package=colorspace>.
- Lumley T (2006). “Color Coding and Color Blindness in Statistical Graphics.” *ASA Statistical Computing & Graphics Newsletter*, **17**(2), 4–7. URL <http://stat-computing.org/newsletter/issues/scgn-17-2.pdf>.
- Lumley T (2013). **dichromat**: *Color Schemes for Dichromats*. R package version 2.0-0, URL <https://CRAN.R-project.org/package=dichromat>.
- Machado GM, Oliveira MM, Fernandes LAF (2009). “A Physiologically-Based Model for Simulation of Color Vision Deficiency.” *IEEE Transactions on Visualization and Computer Graphics*, **15**(6), 1291–1298. doi:10.1109/TVCG.2009.113. URL http://www.inf.ufrgs.br/~oliveira/pubs_files/CVD_Simulation/CVD_Simulation.html.
- Murrell P (2018a). “Generating Colour Names: The **roloc** Package for R.” URL <https://stattech.wordpress.fos.auckland.ac.nz/2018/01/25/2018-01-generating-colour-names-the-roloc-package-for-r/>.

- Murrell P (2018b). **roloc**: *Convert Colour Specification to Colour Name*. R package version 0.1-1, URL <https://CRAN.R-project.org/package=roloc>.
- Neuwirth E (2014). **RColorBrewer**: *ColorBrewer Palettes*. R package version 1.1-2, URL <https://CRAN.R-project.org/package=RColorBrewer>.
- Nowosad J (2018). **rcartocolor**: *'CARTOColors' Palettes*. R package version 0.0.22, URL <https://CRAN.R-project.org/package=rcartocolor>.
- Okabe M, Ito K (2008). “Color Universal Design (CUD): How to Make Figures and Presentations That Are Friendly to Colorblind People.” URL <http://jfly.iam.u-tokyo.ac.jp/color/>.
- Pedersen TL, Crameri F (2018). **scico**: *Colour Palettes Based on the Scientific Colour-Maps*. R package version 1.0.0, URL <https://CRAN.R-project.org/package=scico>.
- Pedersen TL, Nicolae B, François R (2018). **farver**: *Vectorised Colour Conversion and Comparison*. R package version 1.1.0, URL <https://CRAN.R-project.org/package=farver>.
- Ram K, Wickham H (2018). **wesanderson**: *A Wes Anderson Palette Generator*. R package version 0.3.6, URL <https://CRAN.R-project.org/package=wesanderson>.
- R Core Team (2018). *R: A Language and Environment for Statistical Computing*. R Foundation for Statistical Computing, Vienna, Austria. URL <https://www.R-project.org/>.
- Rost LC (2018). “What to Consider When Choosing Colors for Data Visualization.” URL <https://blog.datawrapper.de/colors/>.
- Smith N, Van der Walt S (2015). “A Better Default Colormap for **matplotlib**.” In *SciPy 2015 – Scientific Computing with Python*. Austin. URL <https://www.youtube.com/watch?v=xAoljeRJ3lU>.
- Stauffer R, Mayr GJ, Dabernig M, Zeileis A (2015). “Somewhere over the Rainbow: How to Make Effective Use of Colors in Meteorological Visualizations.” *Bulletin of the American Meteorological Society*, **96**(2), 203–216. doi:10.1175/BAMS-D-13-00155.1.
- Tufte ER (1990). *Envisioning Information*. Graphics Press, Cheshire, CT.
- Viénot F, Brettel H, Mollon JD (1999). “Digital Video Colourmaps for Checking the Legibility of Displays by Dichromats.” *Color Research and Application*, **24**(4), 243–252. doi:10.1002/(sici)1520-6378(199908)24:4<243::aid-col15>3.3.co;2-v.
- Viénot F, Brettel H, Ott L, M'Barek AB, Mollon JD (1995). “What Do Colour-Blind People See?” *Nature*, **376**, 127–128. doi:10.1038/376127a0.
- Ware C (1988). “Color Sequences for Univariate Maps: Theory, Experiments and Principles.” *IEEE Computer Graphics and Applications*, **8**(5), 41–49. doi:10.1109/38.7760.
- Ware C (2004). “Color.” In *Information Visualization: Perception for Design*, chapter 4, pp. 103–149. Morgan Kaufmann Publishers Inc.
- Wickham H (2016). **ggplot2**: *Elegant Graphics for Data Analysis*. 2nd edition. Springer-Verlag. URL <http://ggplot2.org/>.

- Wickham H, Chang W, Henry L, Pedersen TL, Takahashi K, Wilke C, Woo K (2018). *ggplot2: Create Elegant Data Visualisations Using the Grammar of Graphics*. R package version 3.1.0, URL <https://CRAN.R-project.org/package=ggplot2>.
- Wikipedia (2019a). “CIE 1931 Color Space — Wikipedia, The Free Encyclopedia.” URL https://en.wikipedia.org/wiki/CIE_1931_color_space, accessed 2019-01-05.
- Wikipedia (2019b). “CIELAB Color Space — Wikipedia, The Free Encyclopedia.” URL https://en.wikipedia.org/wiki/CIELAB_color_space, accessed 2019-01-05.
- Wikipedia (2019c). “CIELUV — Wikipedia, The Free Encyclopedia.” URL <https://en.wikipedia.org/wiki/CIELUV>, accessed 2019-01-05.
- Wikipedia (2019d). “Color Space — Wikipedia, The Free Encyclopedia.” URL https://en.wikipedia.org/wiki/Color_space, accessed 2019-03-11.
- Wikipedia (2019e). “HCL Color Space — Wikipedia, The Free Encyclopedia.” URL https://en.wikipedia.org/wiki/HCL_color_space, accessed 2019-03-11.
- Wikipedia (2019f). “HSL and HSV — Wikipedia, The Free Encyclopedia.” URL https://en.wikipedia.org/wiki/HSL_and_HSV, accessed 2019-01-05.
- Wikipedia (2019g). “RGB Color Space — Wikipedia, The Free Encyclopedia.” URL https://en.wikipedia.org/wiki/RGB_color_space, accessed 2019-01-05.
- Wikipedia (2019h). “sRGB — Wikipedia, The Free Encyclopedia.” URL <https://en.wikipedia.org/wiki/sRGB>, accessed 2019-01-05.
- Wikipedia (2019i). “Web Colors — Wikipedia, The Free Encyclopedia.” URL https://en.wikipedia.org/wiki/Web_colors, accessed 2019-03-11.
- Wilke CO (2019). *Fundamentals of Data Visualization*. O’Reilly Media. URL <https://serialmentor.com/dataviz/color-basics.html>.
- Wilkinson L (2005). *The Grammar of Graphics*. 2nd edition. Springer-Verlag.
- Wright K (2018). *pals: Color Palettes, Colormaps, and Tools to Evaluate Them*. R package version 1.5, URL <https://CRAN.R-project.org/package=pals>.
- Zeileis A, Gaslam B, Murrell P, Pedersen TL (2018). “Benchmarking Color Space Conversions.” Twitter discussion, URL <https://twitter.com/AchimZeileis/status/1076228936810590208>.
- Zeileis A, Hornik K, Murrell P (2009). “Escaping RGBland: Selecting Colors for Statistical Graphics.” *Computational Statistics & Data Analysis*, **53**, 3259–3270. doi:10.1016/j.csda.2008.11.033.
- Zhang S (2015). “Finding the Right Color Palettes for Data Visualizations.” URL <https://blog.graphiq.com/finding-the-right-color-palettes-for-data-visualizations-fcd4e707a283>.

Affiliation:

Achim Zeileis

Universität Innsbruck

Department of Statistics

Faculty of Economics and Statistics

Universitätsstr. 15

6020 Innsbruck, Austria

E-mail: Achim.Zeileis@R-project.org

URL: <https://eeecon.uibk.ac.at/~zeileis/>