

The Generic SysML/KAOS Domain Metamodel

Steve Jeffrey Tueno Fotso and Marc Frappier

GRIL, Université de Sherbrooke, Sherbrooke, QC J1K 2R1, Canada

Régine Laleau

LACL, Université Paris-Est Créteil, 94010, CRÉTEIL, France

Amel Mammam

SAMOVAR-CNRS, Télécom SudParis, 91000, Evry, France

Hector Ruiz Barradas

ClearSy System Engineering, 13100, Aix-en-Provence, France

Abstract

This paper is related to the generalised/generic version of the SysML/KAOS domain metamodel and on translation rules between the new domain models and *B System* specifications.

Keywords: Requirements Engineering, Domain Modeling, *SysML/KAOS*, Ontologies, *B System*, *Event-B*

1. Background

1.1. *Event-B* and *B System*

Event-B [1] is an industrial-strength formal method for *system modeling*. It is used to incrementally construct a system specification, using refinement, and to prove useful properties. *B System* is an *Event-B* syntactic variant proposed by ClearSy, an industrial partner in the *FORMOSE* project [2], and supported by *Atelier B* [3]. *Event-B* and *B System* have the same semantics defined by proof obligations [1].

Figure 1 is a metamodel of the *B System* language restricted to concepts that are relevant to us. A *B System* specification consists of components (instances of *Component*). Each component can be either a system or a refinement and it may define static or dynamic elements. A refinement is a component which refines another one in order to access the elements defined in it and to reuse them for new constructions. Constants, abstract and enumerated sets, and their properties, constitute the static part. The dynamic part includes the representation of the system state using variables constrained through invariants and initialised through initialisation actions. Properties and invariants can be categorised as instances of *LogicFormula*. Variables can be involved only in invariants. In our case, it is sufficient to consider that logic formulas are successions of operands in relation through operators. Thus, an instance of *LogicFormula* references its operators (instances of *Operator*) and its operands that may be instances of *Variable*, *Constant*, *Set* or *SetItem*.

1.2. *SysML/KAOS* Goal Modeling

1.2.1. Presentation

SysML/KAOS [4, 5] is a requirements engineering method which combines the traceability provided by *SysML* [6] with goal expressiveness provided by *KAOS* [7]. It allows the representation of requirements to be satisfied by a system and of expectations with regards to the environment through a hierarchy of goals. The goal hierarchy is built through a succession of refinements using two main operators: **AND** and **OR**. An **AND refinement** decomposes a goal into subgoals, and all of them must be achieved to realise the parent goal. An **OR refinement** decomposes a goal into subgoals such that the achievement of only one of them is sufficient for the achievement of the parent goal.

Email addresses: Steve.Jeffrey.Tueno.Fotso@USherbrooke.ca, Marc.Frappier@USherbrooke.ca (Steve Jeffrey Tueno Fotso and Marc Frappier), lalau@u-pec.fr (Régine Laleau), amel.mammam@telecom-sudparis.eu (Amel Mammam), hector.ruiz-barradas@clearsy.com (Hector Ruiz Barradas)

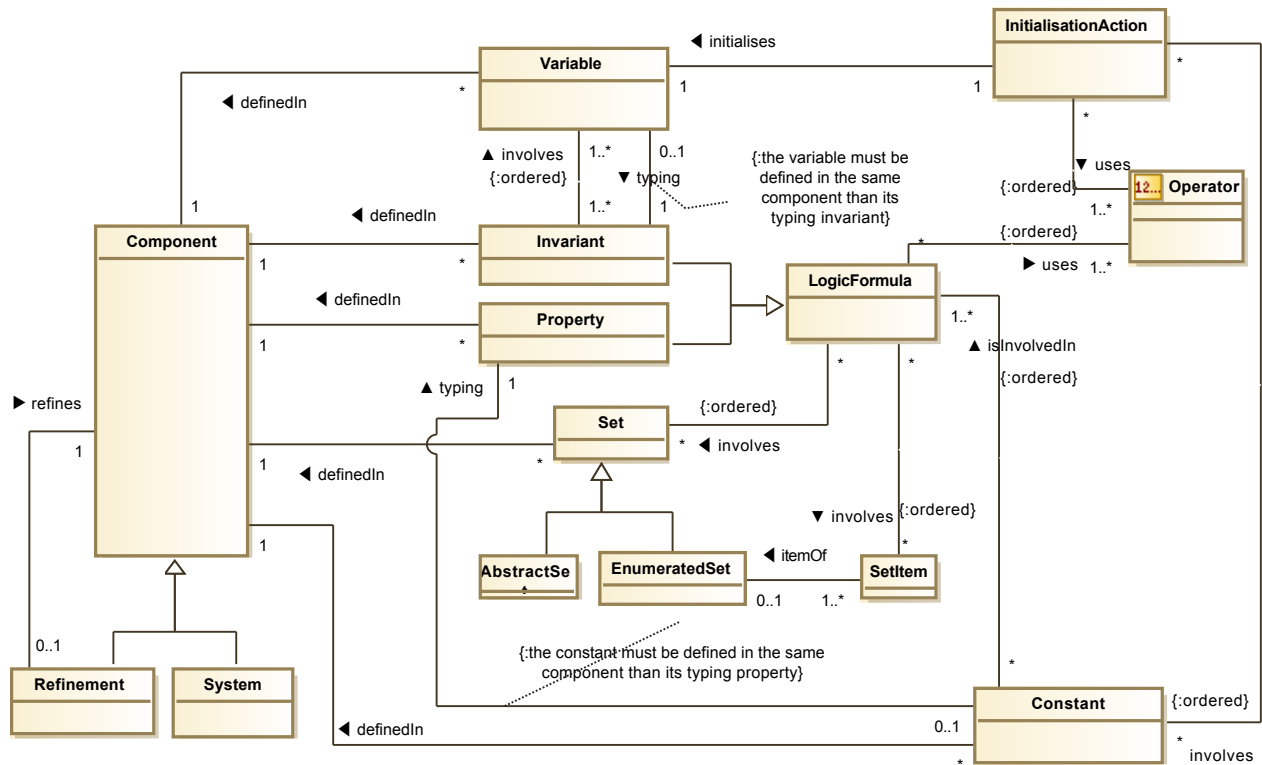

Figure 1: Metamodel of the B System specification language

For this work, the case study focuses on a communication protocol called *SATURN* proposed by *ClearSy*. SATURN relies on exchanges of communication frames between different agents connected through a bus. This case study is restricted to input/output agents. Input agents provide boolean data. Each input data undergoes a boolean transformation and the result is made available to output agents.

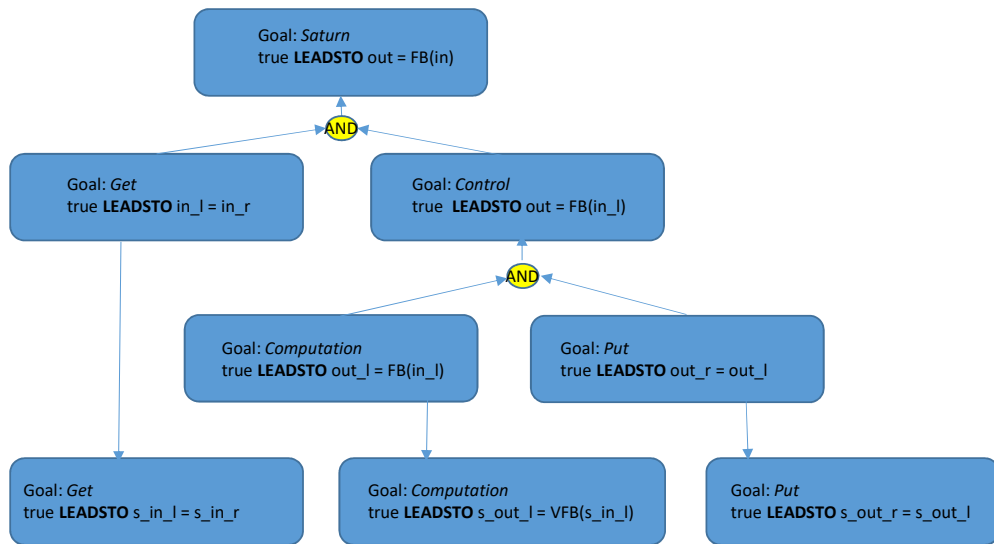

Figure 2: Excerpt from SATURN system goal diagram

Figure 2 is an excerpt from the SysML/KAOS goal diagram representing the functional goals of SATURN. The main purpose of the system is to transform data provided by input agents (in) and make the result (out=FB(in)) available to

output agents. The purpose gives the root goal *Saturn* of the goal diagram of Fig 2. However, goal *Saturn* disregards input reads and result writes. The *AND* operator is used just after to introduce, at the first refinement level, a goal *Get* for input data acquisition from input agents. Term *in_r* designates the data available within input agents and term *in_l* designates the input data used to compute the output data. Similarly, the second refinement level introduces a goal *Put* to make the result *out_l* available to output agents (*out_r* represents the data received by output agents). The third refinement level refines goals defined within the second refinement level to take into account multiplicities of input and output agents. Thus, input data acquisition generates a boolean array *s_in_l* instead of *in_l*, computation becomes a transformation between arrays $s_{out_l} = VFB(s_{in_l})$ and result delivery transfers the content of array *s_out_l* to output agents.

In addition, *SysML/KAOS* includes a domain modeling language which combines the expressiveness of *OWL* [8] and the constraints of *PLIB* [9].

1.3. *SysML/KAOS* Domain Modeling

1.3.1. Presentation

Domain models in *SysML/KAOS* are represented using ontologies. These ontologies are expressed using the *SysML/KAOS* domain modeling language [10, 11], built based on *OWL* [8] and *PLIB* [9], two well-known and complementary ontology modeling formalisms.

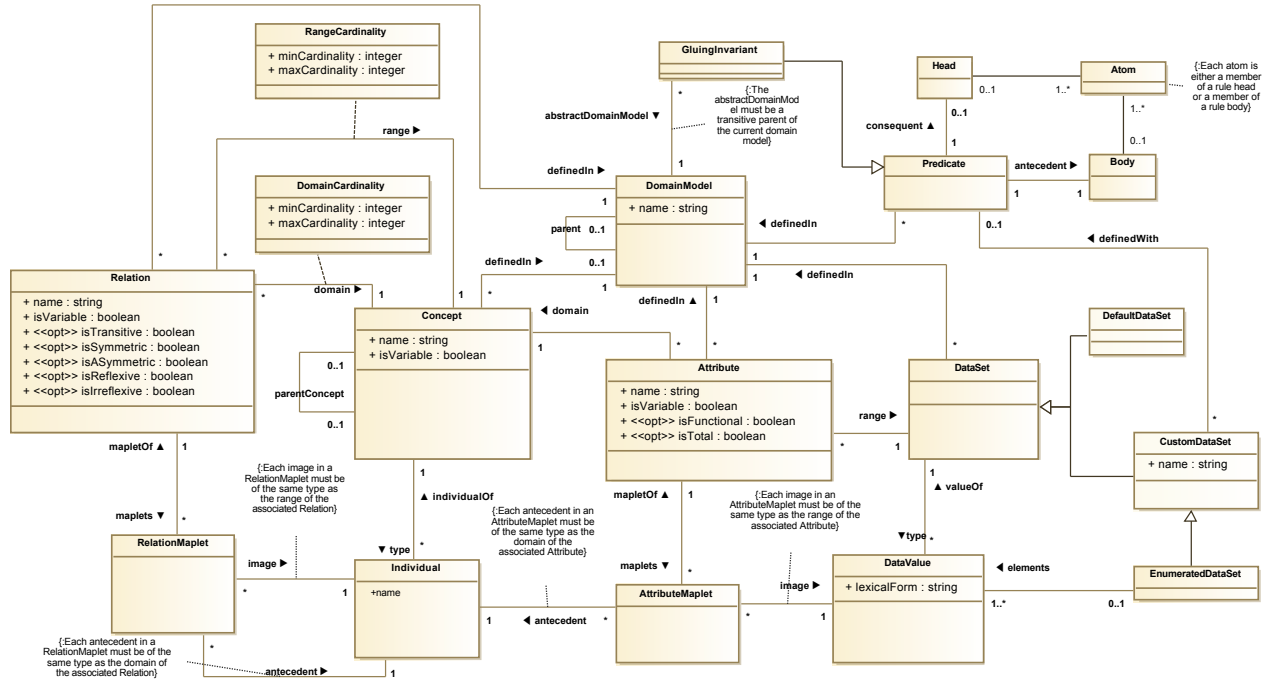

Figure 3: Excerpt from the metamodel associated with the *SysML/KAOS* domain modeling language

Figure 3 is an excerpt from the metamodel associated with the *SysML/KAOS* domain modeling language. Each domain model is associated with a level of refinement of the *SysML/KAOS* goal diagram and is likely to have as its parent, through the *parent* association, another domain model. *Concepts* (instances of **Concept**) designate collections of *individuals* (instances of **Individual**) with common properties. A concept can be declared *variable* (`isVariable=TRUE`) when the set of its individuals can be updated by adding or deleting individuals. Otherwise, it is considered to be *constant* (`isVariable=FALSE`).

Relations (instances of **Relation**) are used to capture links between concepts, and *attributes* (instances of **Attribute**) capture links between concepts and *data sets* (instances of **DataSet**). *Relation maplets* (instances of **RelationMaplet**) capture associations between individuals through relations and *attribute maplets* (instances of **AttributeMaplet**) play the same role for attributes. A relation or an attribute can be declared *variable* if the list of maplets related to it is likely to change over time. Otherwise, it is considered to be *constant*. The variability of an association (relation, attribute) is related to the ability to add or remove maplets. Each *domain cardinality* (instance of **DomainCardinality**) makes it

possible to define, for a relation *re*, the minimum and maximum limits of the number of individuals of the domain of *re* that can be put in relation with one individual of the range of *re*. In addition, the *range cardinality* (instance of *RangeCardinality*) of *re* is used to define similar bounds for the number of individuals of the range of *re*.

Predicates (instances of *Predicate*) are used to represent constraints between different elements of the domain model in the form of *horn clauses*: each predicate has a body which represents its *antecedent* and a head which represents its *consequent*, body and head designating conjunctions of atoms. A data set can be declared abstractly, as a *custom data set* (instance of *CustomDataSet*), and defined with a predicate. *Gluing invariants* (instances of *GluingInvariant*), specialisations of predicates, are used to represent links between data defined within a domain model and those appearing in more abstract domain models, transitively linked to it through the *parent* association. They capture relationships between abstract and concrete data during refinement and are used to discharge proof obligations.

1.3.2. Illustration and Shortcomings

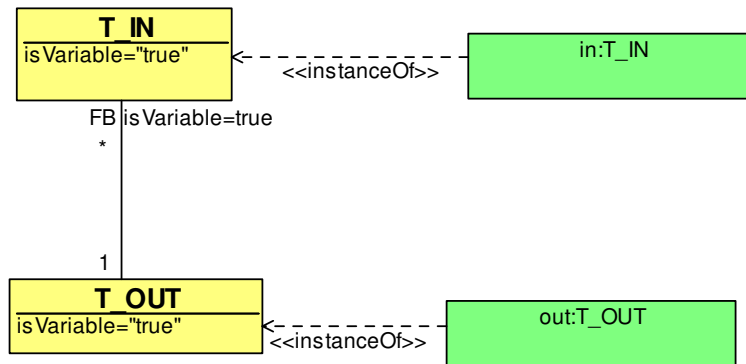

Figure 4: *Saturn_I*: ontology associated with the root level of the goal diagram of Fig. 2

Figure 4 is an attempt to represent the domain model associated with the root level of the goal diagram of Fig. 2 using the SysML/KAOS domain modeling language previously described. It is illustrated using the syntax proposed by *OWLGred* [12] and, for readability purposes, we have decided to hide the representation of optional characteristics. It should be noted that the *individualOf* association is illustrated, through *OWLGred*, as a stereotyped link with the tag *<<instanceOf>>*.

The type of input data is modeled as a concept *T_IN* defining an individual *in* which represents the input data. Similarly, the type of output data is modeled as a concept *T_OUT* defining an individual *out* which represents the output data. The computation function *FB* is modeled as a functional relation from *T_IN* to *T_OUT*.

The first difficulty we encountered is related to the changeability of domain entities. In fact, the states of input and output data change dynamically. In domain model of Fig. 4, a workaround consisted in considering that concepts *T_IN* and *T_OUT* and relation *FB* are variables. Thus, going from a system state where $out1 = FB(in1)$ to a system state where $out2 = FB(in2)$ is feasible and goes through: (1) withdrawal of maplet $in1 \mapsto out1$ from *FB*; (2) withdrawal of individual *in1* from *T_IN*; (3) withdrawal of individual *out1* from *T_OUT*; (4) addition of individual *in2* in *T_IN*; (5) addition of individual *out2* in *T_OUT*; and (6) addition of maplet $in2 \mapsto out2$ in *FB*. However, this representation does not conform to SATURN's design. Indeed, from a conceptual point of view: (1) the input data type must be constant (corresponds to the set of *n*-tuples of Booleans¹); (2) the output data type must be constant (corresponds to the set of *m*-tuples of Booleans²); (3) the computation function *FB* is hard-coded and is therefore constant. What should change are individuals representing the input and output data. It is thus necessary to be able to model variable individuals: individual which can dynamically take any value in a given concept. A similar need appears for relations with relation maplets, attributes with attribute maplets and data sets with data values.

Another difficulty has been encountered related to multiplicities of input and output agents (domain model associated with the third refinement level of the goal diagram of Fig. 2). Indeed, the array that represents input data needs to be modeled by a relation, ditto for the array that represents output data. Thus, the computation function needs to be

¹When considering *n* input agents

²When considering *m* output agents

modeled by a relation for which the domain and the range are relations, which is impossible with the current definition of the SysML/KAOS domain modeling language.

The *SATURN* case study also revealed the need to be able to:

- define domain and range cardinalities for attributes;
- define a named maplet (instance of *RelationMaplet* or *AttributeMaplet*) with or without antecedent and image;
- define an initial value for a variable individual, maplet or data value;
- define associations between data sets and maplets between data values;
- refine a concept with an association or a data set³;
- refine an individual with a maplet or a data value.

We have therefore identified the need to build a generalisation of the metamodel of Fig. 3 which enriches the expressiveness of the SysML/KAOS domain modeling language while preserving the fundamental constraints identified in [10, 11]. A major contribution of this new metamodel is that it federates notions of concept, data set, attribute and relation as well as notions of individual, maplet and data value that have always been considered distinct by ontology modeling languages. Additional constraints are defined to preserve the formal semantics of the language and to ensure unambiguous transformation of any domain model to a *B System* specification.

2. The New SysML/KAOS Domain Modeling Language

2.1. Presentation

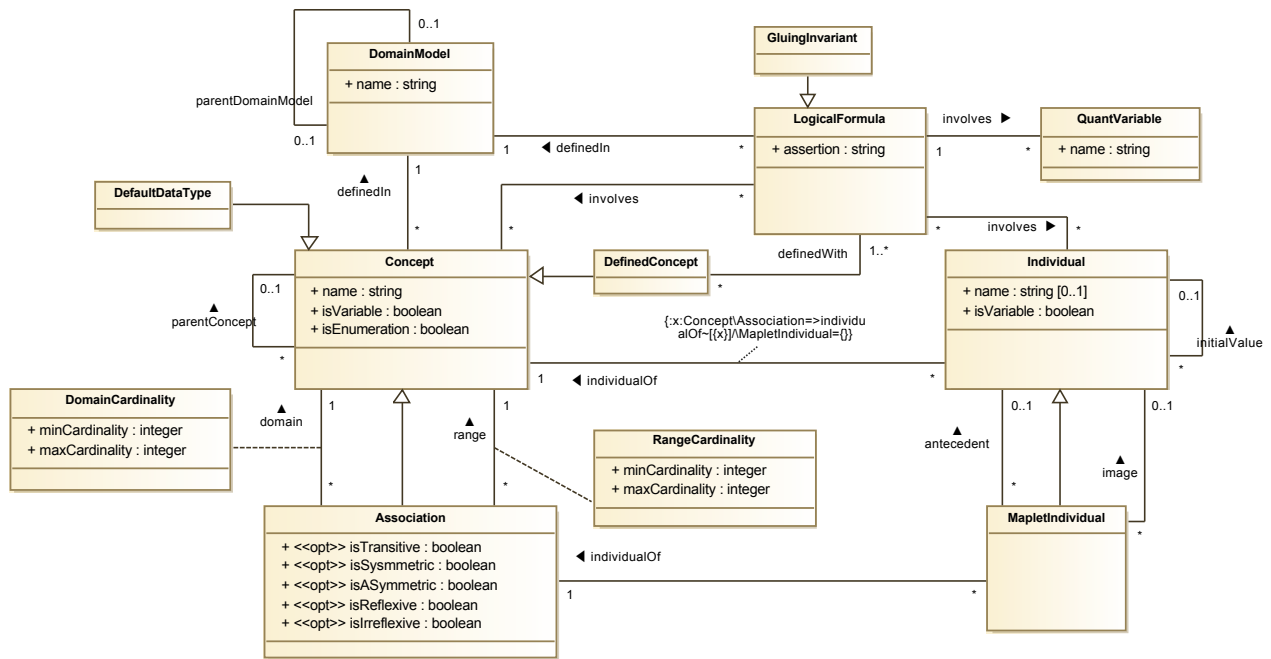

Figure 5: Excerpt from the updated SysML/KAOS domain metamodel

Figure 5 is an excerpt from the updated SysML/KAOS domain metamodel.

³An entity *ec*, defined in a concrete domain model, refines the entity *ea*, defined in an abstract domain model, if it can be deduced that $ec = ea$ from domain model definitions

2.1.1. Description

Domain models are also associated with levels of refinement of the SysML/KAOS goal model. *Concepts* (instances of *Concept*) designate collections of *individuals* (instances of *Individual*) with common properties. A concept can be declared *variable* (*isVariable=TRUE*) when the set of its individuals can be updated by adding or deleting individuals. Otherwise, it is considered to be *constant* (*isVariable=FALSE*). In addition, a concept can be an enumeration (*isEnumeration=TRUE*) if all its individuals are defined within the domain model. It should be noted that an individual can be *variable* (*isVariable=TRUE*) if it is introduced to represent a system state variable: it can represent different individuals at different system states. Otherwise, it is *constant* (*isVariable=FALSE*).

Associations (instances of *Association*) are concepts used to capture links between concepts. *Maplet individuals* (instances of *MapletIndividual*) capture associations between individuals through associations. Each named maplet individual can reference an antecedent and an image. When the maplet individual is unnamed, the antecedent and the image must be specified. The variability of an association is related to the ability to add or remove maplets. Each *domain cardinality* (instance of *DomainCardinality*) makes it possible to define, for an association *re*, the minimum and maximum limits of the number of individuals of the domain of *re* that can be put in relation with one individual of the range of *re*. In addition, the *range cardinality* (instance of *RangeCardinality*) of *re* is used to define similar bounds for the number of individuals of the range of *re*.

Class *LogicalFormula* replaces class *Predicate* of the metamodel of Fig. 3 to represent constraints between domain model elements.

2.1.2. Additional Constraints

This section defines the constraints that are required to preserve the formal semantics of the domain modeling language and to ensure an unambiguous transformation of any domain model to a *B System* specification. The constraints are defined using the *B* syntax [1].

- $x \in \text{Concept} \setminus \text{Association} \Rightarrow \text{individualOf}^{-1}[\{x\}] \cap \text{MapletIndividual} = \emptyset$: if concept *x* is not an association, then no individual of *x* can be a maplet individual.
- $x \in \text{MapletIndividual} \cap \text{dom}(\text{antecedent}) \Rightarrow \text{antecedent}(x) \in \text{domain}(\text{individualOf}(x))$: if maplet individual *x* has an antecedent, then the antecedent is an individual of the domain of its association.
- $x \in \text{MapletIndividual} \cap \text{dom}(\text{image}) \Rightarrow \text{image}(x) \in \text{range}(\text{individualOf}(x))$: if maplet individual *x* has an image, then the image is an individual of the range of its association.
- $\text{ind} \in \text{Individual} \setminus \text{MapletIndividual} \Rightarrow \text{ind} \in \text{dom}(\text{Individual_name})$: every individual which is not a maplet individual must be named.
- $\text{ind} \in \text{Individual} \setminus \text{dom}(\text{Individual_name}) \Rightarrow \text{Individual_isVariable}(\text{ind}) = \text{FALSE}$: every unnamed individual must be constant.
- $\text{ind} \in \text{MapletIndividual} \cap \text{dom}(\text{antecedent}) \cap \text{dom}(\text{image}) \Rightarrow (\text{antecedent}(\text{ind}) \in \text{dom}(\text{Individual_name}) \wedge \text{image}(\text{ind}) \in \text{dom}(\text{Individual_name}))$: antecedents and images of maplet individuals must be named.
- $\text{ind} \in \text{MapletIndividual} \setminus \text{dom}(\text{Individual_name}) \Rightarrow \text{ind} \in \text{dom}(\text{antecedent}) \cap \text{dom}(\text{image})$: every unnamed maplet individual must have an antecedent and an image.
- $x \in \text{Concept} \setminus (\text{Association} \cup \text{dom}(\text{parentConcept})) \Rightarrow \text{Concept_isVariable}(x) = \text{FALSE}$: every abstract concept (that has no parent concept) that is not an association must be constant.
- $x \in \text{Concept} \wedge \text{Concept_isEnumeration}(x) = \text{TRUE} \Rightarrow \text{Concept_isVariable}(x) = \text{FALSE}$: every concept that is an enumeration must be constant.
- $(\text{ind} \in \text{MapletIndividual} \cap \text{dom}(\text{antecedent}) \cap \text{dom}(\text{image}) \wedge \text{Individual_isVariable}(\text{ind}) = \text{FALSE}) \Rightarrow (\text{Individual_isVariable}(\text{antecedent}(\text{ind})) = \text{FALSE} \wedge \text{Individual_isVariable}(\text{image}(\text{ind})) = \text{FALSE})$: antecedents and images of constant maplet individuals must be constant.
- $(x \in \text{Association} \wedge \text{Concept_isVariable}(x) = \text{FALSE}) \Rightarrow (\text{Concept_isVariable}(\text{domain}(x)) = \text{FALSE} \wedge \text{Concept_isVariable}(\text{range}(x)) = \text{FALSE})$: domains and ranges of constant associations must be constant.

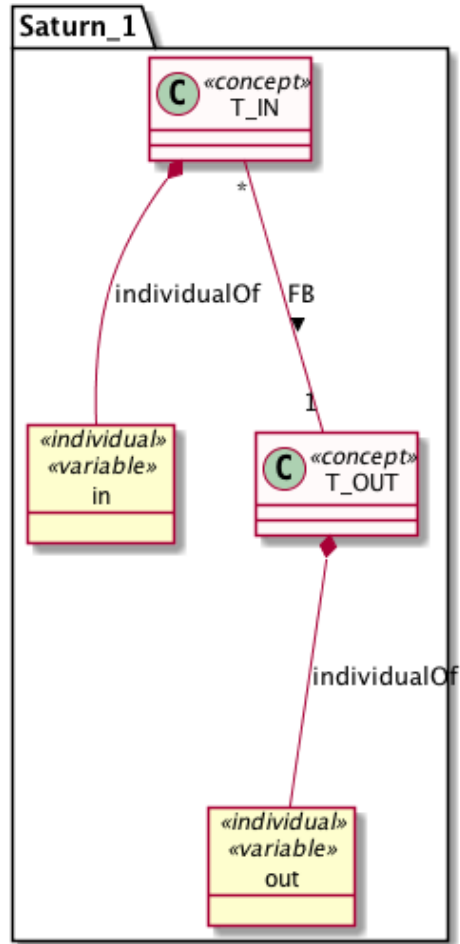

Figure 6: *Saturn_1*: ontology associated with the root level of the goal diagram of Fig. 2

2.2. Illustration

Figures 6, 7, 8, 9 represent domain models associated with refinement levels 0 (root level) .. 3 of the goal diagram of Fig. 2 using the updated SysML/KAOS domain modeling language. They are illustrated using the syntax proposed by the *SysML/KAOS Domain Modeling tool* [13]⁴ and, for readability purposes, we have decided to hide the representation of optional characteristics.

In domain model *Saturn_1* (Fig. 6), the type of input data is modeled as a constant concept *T_IN* (instance of class *Concept* of Fig. 5) defining a variable individual *in* (instance of class *Individual* of Fig. 5) which represents the input data. Similarly, the type of output data is modeled as a constant concept *T_OUT* defining a variable individual *out* which represents the output data. Finally, the computation function *FB* is modeled as a functional association (instance of class *Association* of Fig. 5) from *T_IN* to *T_OUT*.

In domain model *Saturn_2* (Fig. 7) which refines *Saturn_1*, individual *in* is refined by an individual named *in_1* and a new variable individual named *in_r* is defined to represent the acquired input data. Similarly, in domain model *Saturn_3* (Fig. 8), *out* is refined by *out_1* and individual *out_r* is added.

In domain model *Saturn_4* (Fig. 9) which refines *Saturn_3*, two concepts are defined: *MI* which represents the set of input agents and *MO* which represents the set of output agents. Concept *agents_in* (respectively *agents_out*) is a subconcept of *MI* (respectively *MO*) which represents the set of input (respectively output) agents that are active. Asso-

⁴The tool has been implemented on top of *Jetbrains MPS* [14] and *PlantUML* [15] to provide a proof of concept of the SysML/KAOS Domain Modeling Language.

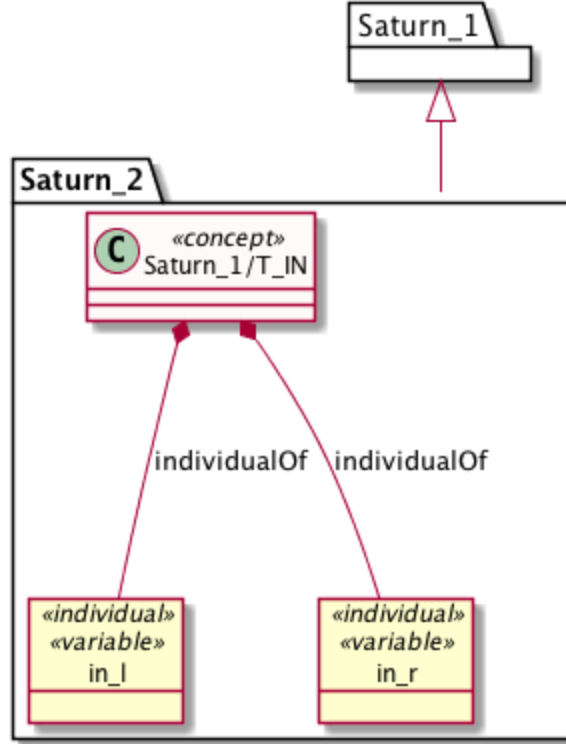

Figure 7: *Saturn_2*: ontology associated with the first refinement level of the goal diagram of Fig. 2

ciation VIN from *agents_in* to TT (this concept is defined in this abstraction level to represent any type of two-element data. It can latter be refined for example by `Bool` or `{0, 1}`) represents the type of input data which are now arrays. Similarly, association VOUT from *agents_out* to TT represents the type of output data. When being a concept only adds property name to an association, as in previous domain models, then no association class is attached to the link that represents the association. Otherwise, an association class is defined to allow the association to behave as a concept. This is the case for VIN and VOUT which serve as domains for other associations. Individuals *in_l*, *in_r*, *out_l* and *out_r* are refined by maplet individuals *s_in_l*, *s_in_r*, *s_out_l* and *s_out_r* (instances of class `MapletIndividual` of Fig. 5) using total injective associations *vec_to_in* from VIN to T_IN and *vec_to_out* from VOUT to T_OUT: $in_l = vec_to_in(s_in_l), in_r = vec_to_in(s_in_r), out_l = vec_to_out(s_out_l), out_r = vec_to_out(s_out_r)$. Finally, the computation function is modeled as a functional association named VBF from VIN to VOUT: $VBF = vec_to_in; FB; vec_to_out^{-1}$ (operator ; is the association composition operator used in logical formula assertions).

3. Updates in Translation Rules from Domain Models to B System Specifications

In the following, we describe a set of rules that allow to obtain a *B System* specification from domain models that conform to the updated SysML/KAOS domain modeling language.

Table 1 gives the translation rules. It should be noted that o_x designates the result of the translation of x . In addition, when used, qualifier *abstract* denotes "without parent". The rules have been implemented within the *SysML/KAOS Domain Modeling tool* [13] built on top of *Jetbrains MPS* [14] and *PlantUML* [15] to provide a proof of concept of the SysML/KAOS Domain Modeling Language. Rules 3, 4, 6..8, and 12..16 have undergone significant updates to the previously defined translation rules [16].

Table 1: The translation rules

	Translation Of	Domain Model		B System	
		Element	Constraint	Element	Constraint
1	Abstract domain model	DM	$DM \in \text{DomainModel}$ $DM \notin \text{dom}(\text{parentDomainModel})$	o_DM	$o_DM \in \text{System}$

2	Domain model with parent	DM PDM	$\{DM, PDM\} \subseteq \text{DomainModel}$ $PDM = \text{parentDomainModel}(DM)$ $o_PDM \in \text{Component}$	o_DM	$o_DM \in \text{Refinement}$ o_DM refines o_PDM
3	Abstract concept that is not an enumeration	CO	$CO \in \text{Concept} \setminus (\text{Association} \cap \text{DefinedConcept} \cap \text{DefaultDataType})$ $CO \notin \text{dom}(\text{parentConcept})$ $\text{isEnumeration}(CO) = \text{FALSE}$	o_CO	$o_CO \in \text{AbstractSet}$
4	Abstract concept that is an enumeration	CO $(I_j)_{j \in 1..n}$	$CO \in \text{Concept} \setminus (\text{Association} \cap \text{DefinedConcept} \cap \text{DefaultDataType})$ $CO \notin \text{dom}(\text{parentConcept})$ $\text{isEnumeration}(CO) = \text{TRUE}$ $\forall j \in 1..n, I_j \in \text{Individual} \setminus \text{MapletIndividual} \wedge \text{individualOf}(I_j) = CO \wedge \text{Individual_isVariable}(I_j) = \text{FALSE}$	o_CO $(o_I_j)_{j \in 1..n}$	$o_CO \in \text{EnumeratedSet}$ $\forall j \in 1..n, o_I_j \in \text{SetItem} \wedge \text{itemOf}(o_I_j) = o_CO$
5	Concept with constant parent	CO PCO	$\{CO, PCO\} \subseteq \text{Concept}$ $\text{parentConcept}(CO) = PCO$ $o_PCO \in \text{Set} \cup \text{Constant}$	o_CO	IF $\text{Concept_isVariable}(CO) = \text{FALSE}$ THEN $o_CO \in \text{Constant}$ ELSE $o_CO \in \text{Variable}$ LogicFormula: $o_CO \subseteq o_PCO$
6	Constant concept with variable parent	CO PCO PPCO	$\{CO, PCO, PPCO\} \subseteq \text{Concept}$ $\text{Concept_isVariable}(CO) = \text{FALSE}$ $\text{parentConcept}(CO) = PCO$ $o_PCO \in \text{Variable}$ $PPCO \in (\text{closure1}(\text{parentConcept}))[\{PCO\}]^5$ $o_PPCO \in \text{Set} \cup \text{Constant}$	o_CO	$o_CO \in \text{Constant}$ Property: $o_CO \subseteq o_PPCO$ Invariant: $o_CO \subseteq o_PCO$
7	Variable concept with variable parent	CO PCO	$\{CO, PCO\} \subseteq \text{Concept}$ $\text{Concept_isVariable}(CO) = \text{TRUE}$ $\text{parentConcept}(CO) = PCO$ $o_PCO \in \text{Variable}$	o_CO	$o_CO \in \text{Variable}$ Invariant: $o_CO \subseteq o_PCO$
8	Enumerated concept with parent	CO $(I_j)_{j \in 1..n}$	$CO \in \text{dom}(\text{parentConcept})$ $\text{isEnumeration}(CO) = \text{TRUE}$ $\forall j \in 1..n, I_j \in \text{Individual} \wedge \text{individualOf}(I_j) = CO \wedge \text{Individual_isVariable}(I_j) = \text{FALSE}$ $o_CO \in \text{Constant}^6$ $\forall j \in 1..n, o_I_j \in o_CO$		Property: $o_CO = (o_I_j)_{j \in 1..n}$
9	Association or defined concept without parent	CO	$CO \in (\text{DefinedConcept} \cup \text{Association})$ $CO \notin \text{dom}(\text{parentConcept})$	o_CO	IF $\text{Concept_isVariable}(CO) = \text{FALSE}$ THEN $o_CO \in \text{Constant}$ ELSE $o_CO \in \text{Variable}$
10	Association	AS CO1 CO2 da di ra ri	$\{CO1, CO2\} \subseteq \text{Concept}$ $AS \in \text{Association}$ $CO1 = \text{domain}(AS)$ $CO2 = \text{range}(AS)$ $\text{Relation_DomainCardinality_maxCardinality}(RE) = da$ $\text{Relation_DomainCardinality_minCardinality}(RE) = di$ $\text{Relation_RangeCardinality_maxCardinality}(RE) = ra$ $\text{Relation_RangeCardinality_minCardinality}(RE) = ri$ $o_AS \in \text{Constant} \cup \text{Variable}$ $\{o_CO1, o_CO2\} \subseteq (\text{Set} \cup \text{Constant} \cup \text{Variable})$		IF $\{ra, ri, da, di\} = \{1\}$ THEN LogicFormula: $o_RE \in o_CO1 \mapsto o_CO2$ ELSE IF $\{ra, ri, da\} = \{1\}$ THEN LogicFormula: $o_RE \in o_CO1 \mapsto o_CO2$ ELSE IF $\{ra, ri, di\} = \{1\}$ THEN LogicFormula: $o_RE \in o_CO1 \mapsto o_CO2$ ELSE IF $\{ra, da\} = \{1\}$ THEN LogicFormula: $o_RE \in o_CO1 \mapsto o_CO2$ ELSE IF $\{ra, ri\} = \{1\}$ THEN LogicFormula: $o_RE \in o_CO1 \mapsto o_CO2$ ELSE IF $\{ra, di\} = \{1\}$ THEN LogicFormula: $o_RE \in o_CO1 \mapsto o_CO2$ ELSE IF $\{ra, da, di\} = \{1\}$ THEN LogicFormula: $o_RE \in o_CO1 \mapsto o_CO2$ ELSE IF $\{ra, ri, da, di\} = \{1\}$ THEN LogicFormula: $o_RE \in o_CO1 \mapsto o_CO2$ ELSE LogicFormula: $o_RE \in o_CO1 \leftrightarrow o_CO2$ $\wedge \forall x. (x \in CO2 \Rightarrow \text{card}(o_RE^{-1}\{x\}) \in di..da)$ $\wedge \forall x. (x \in CO1 \Rightarrow \text{card}(o_RE\{x\}) \in ri..ra)$
11	Individual of a constant concept that is not an abstract enumeration	Ind CO	$Ind \in \text{Individual} \setminus \text{MapletIndividual}$ $CO = \text{individualOf}(Ind)$ $o_CO \in \text{AbstractSet} \cup \text{Constant}$	o_Ind	IF $\text{Individual_isVariable}(Ind) = \text{TRUE}$ THEN $o_Ind \in \text{Variable}$ ELSE $o_Ind \in \text{Constant}$ LogicFormula: $o_Ind \in o_CO$
12	Constant individual of a variable concept	Ind CO PPCO	$Ind \in \text{Individual} \setminus \text{MapletIndividual}$ $\text{Individual_isVariable}(Ind) = \text{FALSE}$ $CO = \text{individualOf}(Ind)$ $o_CO \in \text{Variable}$ $PPCO \in \text{Concept}$ $PPCO \in (\text{closure1}(\text{parentConcept}))[\{CO\}]$ $o_PPCO \in \text{Set} \cup \text{Constant}$	o_Ind	$o_Ind \in \text{Constant}$ Property: $o_Ind \in o_PPCO$ Invariant: $o_Ind \in o_CO$
13	Variable individual of a variable concept	Ind CO	$Ind \in \text{Individual} \setminus \text{MapletIndividual}$ $\text{Individual_isVariable}(Ind) = \text{TRUE}$ $CO = \text{individualOf}(Ind)$ $o_CO \in \text{Variable}$	o_Ind	$o_Ind \in \text{Variable}$ Invariant: $o_Ind \in o_CO$

⁵ $\text{closure1}(\text{parentConcept})$ designates the transitive closure of relation parentConcept

⁶Every concrete enumeration is a constant

14	Variable individual of a concept that is an abstract enumeration	Ind CO	$Ind \in \text{Individual} \setminus \text{MapletIndividual}$ $\text{Individual_isVariable}(Ind) = \text{TRUE}$ $CO = \text{individualOf}(Ind)$ $\text{Concept_isEnumeration}(CO) = \text{TRUE}$ $CO \notin \text{dom}(\text{parentConcept})$ $o_CO \in \text{EnumeratedSet}$	o_Ind	$o_Ind \in \text{Variable}$ Invariant: $o_Ind \in o_CO$
15	Maplet individual	Ind AS Ant Im	$Ind \in \text{MapletIndividual}$ $AS = \text{individualOf}(Ind)$ ⁷ $o_AS \in \text{Constant} \cup \text{Variable}$ $Ind \in \text{dom}(\text{antecedent}) \Rightarrow \text{Ant} = \text{antecedent}(Ind)$ $o_Ant \in \text{Constant} \cup \text{Variable}$ $Ind \in \text{dom}(\text{image}) \Rightarrow \text{Im} = \text{image}(Ind)$ $o_Im \in \text{Constant} \cup \text{Variable}$	o_Ind	IF $Ind \in \text{dom}(\text{Individual_name})$ THEN IF $\text{Individual_isVariable}(Ind) = \text{TRUE}$ THEN $o_Ind \in \text{Variable}$ Invariant: $o_Ind \in o_AS$ IF $Ind \in \text{dom}(\text{antecedent}) \cap \text{dom}(\text{image})$ THEN Invariant: $o_Ind = o_Ant \mapsto o_Im$ ELSE $o_Ind \in \text{Constant}$ IF $o_AS \in \text{Constant}$ THEN Property: $o_Ind \in o_AS$ ELSE Property: $o_Ind \in \text{dom}(o_AS) \leftrightarrow \text{im}(o_AS)$ Invariant: $o_Ind \in o_AS$ IF $Ind \in \text{dom}(\text{antecedent}) \cap \text{dom}(\text{image})$ THEN Property: $o_Ind = o_Ant \mapsto o_Im$ ELSE LogicFormula: $o_Ant \mapsto o_Im \in o_AS$ ⁸
16	Variable individual initialisation	Ind Init CO Init_ant Init_im	$Ind \in \text{Individual} \cap \text{dom}(\text{Individual_name})$ $\text{Individual_isVariable}(Ind) = \text{TRUE}$ $o_Ind \in \text{Variable}$ $CO = \text{individualOf}(Ind)$ $o_CO \in \text{Set} \cup \text{Constant} \cup \text{Variable}$ $Ind \notin \text{dom}(\text{initialValue}) \vee (\text{initialValue}(Ind) = \text{Init} \wedge (\text{Init} \notin \text{dom}(\text{Individual_name}) \wedge \text{Init_ant} = \text{antecedent}(\text{Init}) \wedge \text{Init_im} = \text{image}(\text{Init}) \wedge \{\text{Init_ant}, \text{Init_im}\} \subseteq \text{Constant} \cup \text{Variable}) \vee o_Init \in \text{Constant} \cup \text{Variable}))$		IF $Ind \notin \text{dom}(\text{initialValue})$ THEN $o_Ind ::= o_CO$ ELSE IF $\text{Init} \notin \text{dom}(\text{Individual_name})$ THEN Initialisation: $o_Ind := o_Ant \mapsto o_Im$ ELSE Initialisation: $o_Ind := o_Init$
17	Variable concept initialisation	CO $(I_j)_{j \in 1..n}$	$CO \in \text{dom}(\text{Concept})$ $\text{isVariable}(CO) = \text{TRUE}$ $\forall j \in 1..n. I_j \in \text{Individual} \wedge \text{individualOf}(I_j) = CO \wedge \text{Individual_isVariable}(I_j) = \text{FALSE}$ $o_CO \in \text{Variable}$ $\forall j \in 1..n. o_I_j \in o_CO$		Initialisation: $o_CO := (o_I_j)_{j \in 1..n}$ ⁹
18	Association transitivity	AS	$AS \in \text{Association}$ $\text{Association_isTransitive}(AS) = \text{TRUE}$ $o_AS \in \text{Constant} \cup \text{Variable}$		LogicFormula: $(o_AS ; o_AS) \subseteq o_AS$
19	Association symmetry	AS	$AS \in \text{Association}$ $\text{Association_isSymmetric}(AS) = \text{TRUE}$ $o_AS \in \text{Constant} \cup \text{Variable}$		LogicFormula: $o_AS^{-1} = o_AS$
20	Association asymmetry	AS CO	$AS \in \text{Association}$ $\text{Association_isSymmetric}(AS) = \text{TRUE}$ $o_AS \in \text{Constant} \cup \text{Variable}$ $\text{domain}(AS) = CO$ $o_CO \in \text{Set} \cup \text{Constant} \cup \text{Variable}$		LogicFormula: $(o_AS^{-1} \cap o_AS) \subseteq \text{id}(o_CO)$
21	Association reflexivity	AS CO	$AS \in \text{Association}$ $\text{Association_isReflexive}(AS) = \text{TRUE}$ $o_AS \in \text{Constant} \cup \text{Variable}$ $\text{domain}(AS) = CO$ $o_CO \in \text{Set} \cup \text{Constant} \cup \text{Variable}$		LogicFormula: $\text{id}(o_CO) \subseteq o_AS$
22	Association irreflexivity	AS CO	$AS \in \text{Association}$ $\text{Association_isIrreflexive}(AS) = \text{TRUE}$ $o_AS \in \text{Constant} \cup \text{Variable}$ $\text{domain}(AS) = CO$ $o_CO \in \text{Set} \cup \text{Constant} \cup \text{Variable}$		LogicFormula: $\text{id}(o_CO) \cap o_AS = \emptyset$

Each logical formula is translated with the definition of a *B System* logic formula corresponding to its assertion. Since both languages use first-order logic notations, the translation is limited to a syntactic rewriting.

Acknowledgment

This work is carried out within the framework of the *FORMOSE* project [2] funded by the French National Research Agency (ANR). It is also partly supported by the Natural Sciences and Engineering Research Council of Canada (NSERC).

⁷AS must be an association

⁸Following the variability status of o_AS , this predicate can be a property or an invariant

⁹If $\exists j \in 1..n. I_j \notin \text{dom}(\text{Individual_name})$ then o_I_j must be replaced by $o_I_j_Ant \mapsto o_I_j_Im$ as in the previous rule

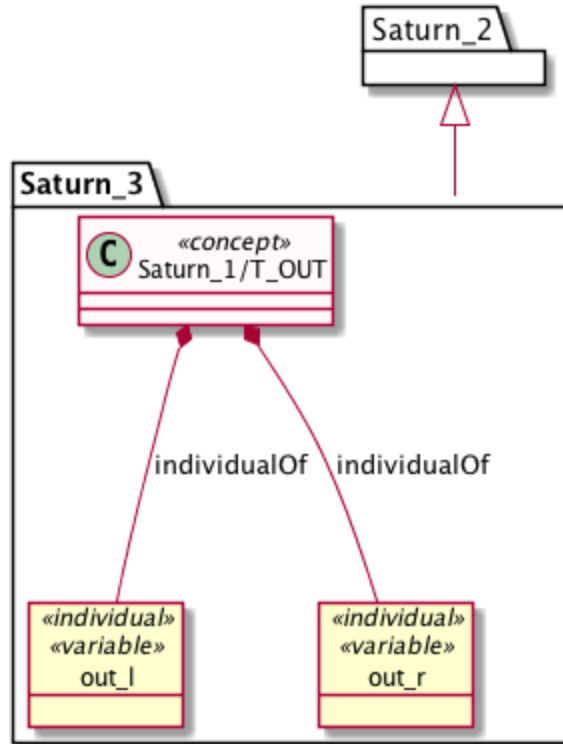

Figure 8: *Saturn_3*: ontology associated with the second refinement level of the goal diagram of Fig. 2

References

- [1] J. Abrial, *Modeling in Event-B - System and Software Engineering*, Cambridge University Press, 2010.
- [2] ANR-14-CE28-0009, Formose ANR project (2017).
URL <http://formose.lacl.fr/>
- [3] ClearSy, *Atelier B: B System* (2014).
URL <http://clearsy.com/>
- [4] R. Laleau, F. Semmak, A. Matoussi, D. Petit, A. Hammad, B. Tatibouet, A first attempt to combine SysML requirements diagrams and B, *Innovations in Systems and Software Engineering* 6 (1-2) (2010) 47–54.
- [5] A. Mammarr, R. Laleau, On the use of domain and system knowledge modeling in goal-based Event-B specifications, in: *ISoLA 2016, LNCS*, Springer, pp. 325–339.
- [6] M. Hause, et al., *The SysML modelling language*, in: *Fifteenth European Systems Engineering Conference*, Vol. 9, Citeseer, 2006.
- [7] A. van Lamsweerde, *Requirements Engineering - From System Goals to UML Models to Software Specifications*, Wiley, 2009.
- [8] K. Sengupta, P. Hitzler, *Web ontology language (OWL)*, in: *Encyclopedia of Social Network Analysis and Mining*, 2014, pp. 2374–2378.
- [9] G. Pierra, *The PLIB ontology-based approach to data integration*, in: *IFIP 18th World Computer Congress*, Vol. 156 of IFIP, Kluwer/Springer, 2004, pp. 13–18.
- [10] S. Tueno, R. Laleau, A. Mammarr, M. Frappier, *The SysML/KAOS Domain Modeling Approach*, ArXiv e-prints, cs.SE, 1710.00903.
URL <https://arxiv.org/pdf/1710.00903.pdf>

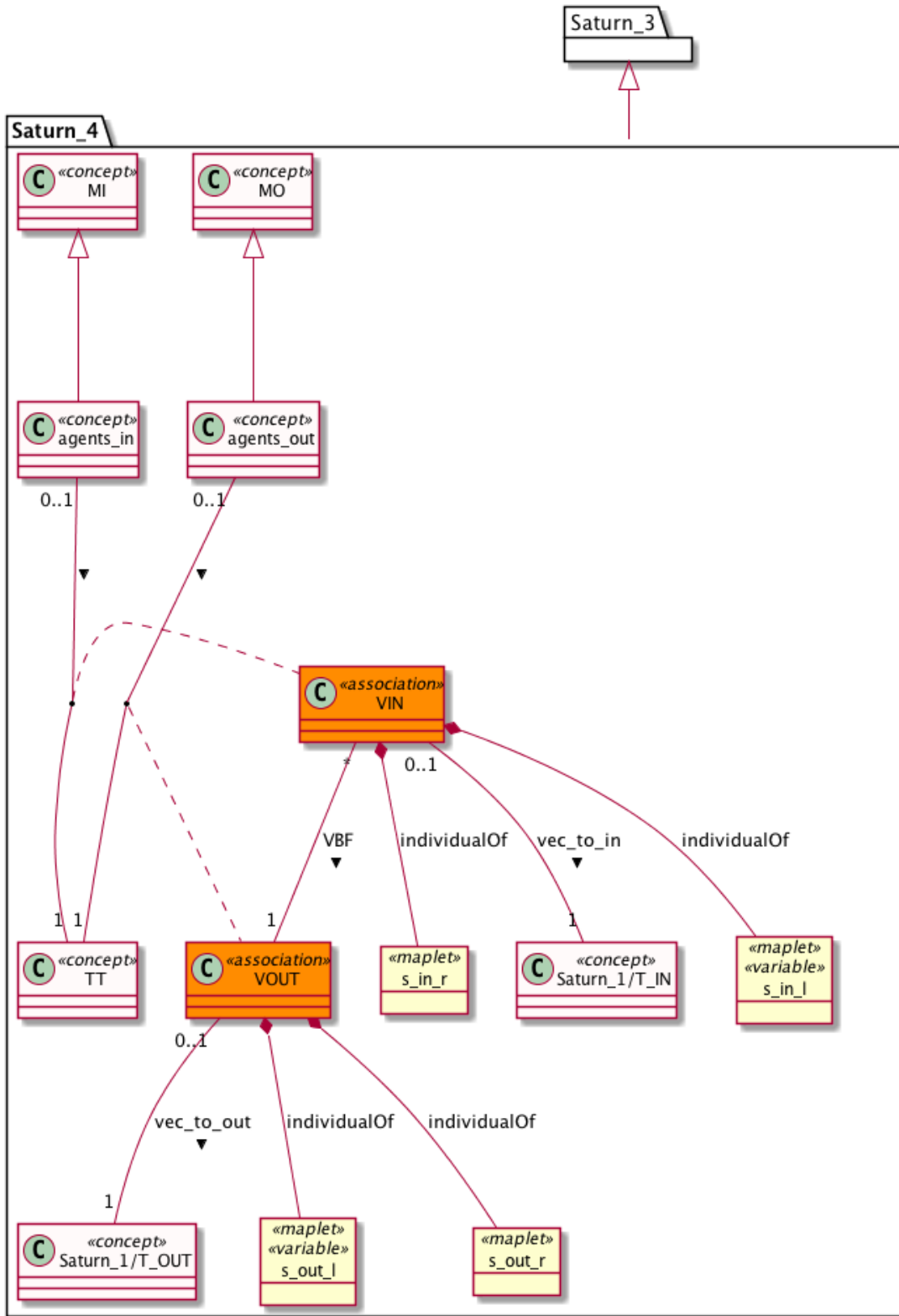

Figure 9: *Saturn_4*: ontology associated with the third refinement level of the goal diagram of Fig. 2

- [11] S. Tuono, R. Laleau, A. Mammar, M. Frappier, Towards using ontologies for domain modeling within the SysML/KAOS approach, in: RE Workshops, IEEE Computer Society, 2017, pp. 1–5.
- [12] I. UL, Owlged home (2017).
URL <http://owlged.lumii.lv/>
- [13] S. Tuono, R. Laleau, A. Mammar, M. Frappier, SysML/KAOS Domain Modeling Tool (2017).
URL https://github.com/anonym21/SysML_KAOS_Domain_Model_Parser
- [14] JetBrains, JetBrains mps (2017).
URL <https://www.jetbrains.com/mps/>
- [15] A. Roques, Plantuml: Open-source tool that uses simple textual descriptions to draw uml diagrams (2015).
- [16] S. Tuono, M. Frappier, R. Laleau, A. Mammar, From SysML/KAOS Domain Models to B System Specifications, ArXiv e-prints, cs.SE, 1803.01972.
URL <https://arxiv.org/pdf/1803.01972.pdf>