

On orthogonal symmetric chain decompositions

Karl Däubel, Sven Jäger, Torsten Mütze, and Manfred Scheucher

Institut für Mathematik, Technische Universität Berlin, Germany
 {daeubel,jaeger,muetze,scheucher}@math.tu-berlin.de

Abstract

The n -cube is the poset obtained by ordering all subsets of $\{1, \dots, n\}$ by inclusion. It is well-known that the n -cube can be partitioned into $\binom{n}{\lfloor n/2 \rfloor}$ chains, which is the minimum possible number. Two such decompositions of the n -cube are called *orthogonal* if any two chains of the decompositions share at most a single element. Shearer and Kleitman conjectured in 1979 that the n -cube has $\lfloor n/2 \rfloor + 1$ pairwise orthogonal decompositions into the minimum number of chains, and they constructed two such decompositions. Spink recently improved this by showing that the n -cube has three pairwise orthogonal chain decompositions for $n \geq 24$. In this paper, we construct four pairwise orthogonal chain decompositions of the n -cube for $n \geq 60$. We also construct five pairwise *edge-disjoint* chain decompositions of the n -cube for $n \geq 90$, where edge-disjointness is a slightly weaker notion than orthogonality.

1 Introduction

The n -dimensional cube Q_n , or n -cube for short, is the poset obtained by taking all subsets of $[n] := \{1, \dots, n\}$, and ordering them by inclusion. This poset is sometimes also called *subset lattice* or *Boolean lattice*, and it is a fundamental and widely studied object in combinatorics. For illustration, Figure 1 shows the 4-cube.

Clearly, Q_n is a graded poset with rank function given by the set sizes, and every maximal chain has size $n + 1$. We refer to the family of all subsets of a fixed size $k \in \{0, \dots, n\}$ as the k th level of Q_n . It is easy to see that Q_n has a unique largest level $n/2$ for even n , and two largest levels $\lfloor n/2 \rfloor$ and $\lceil n/2 \rceil$ for odd n . We refer to these levels as *middle levels*. Sperner's classical theorem [Spe28] asserts that each middle level is in fact a largest antichain of Q_n , i.e., Q_n has width $a_n := \binom{n}{\lfloor n/2 \rfloor}$. As a consequence, at least a_n many chains are needed to partition Q_n , and by Dilworth's theorem [Dil50], a partition into this many chains indeed exists. De Bruijn, van Ebbenhorst Tengbergen, and Kruiswijk [dBvETK51] first described an inductive construction of a partition of Q_n into a_n many chains that are all *symmetric* and *saturated*, i.e., every chain starts and ends in symmetric levels around the middle, and no chain skips any intermediate levels. Throughout this paper, we will refer to their decomposition as the *standard decomposition*. The existence of such a decomposition was used by Kleitman [Kle65] to prove a result on signed sums of complex numbers, improving an earlier result due to Littlewood

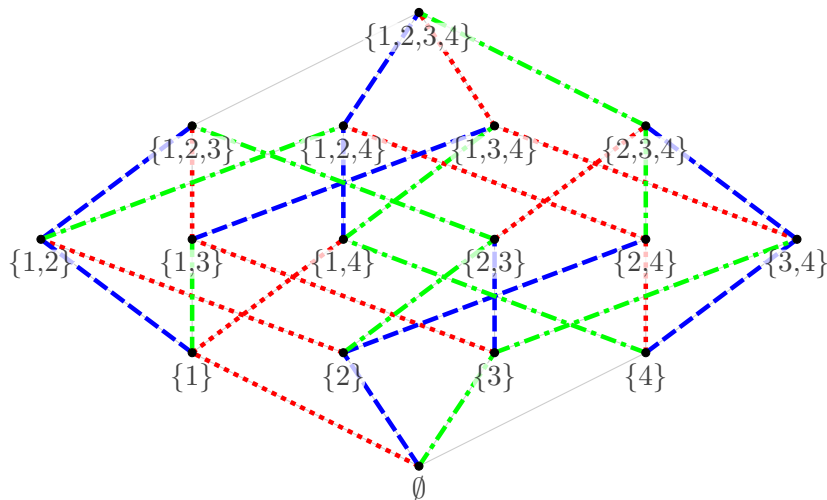

Figure 1: The 4-cube Q_4 , with three pairwise orthogonal chain decompositions into 6 chains, highlighted by dashed, dotted, and dash-dotted lines.

and Offord [LO38] (see also [Kle70]). Later, Lewin [Lew72], Aigner [Aig73], and White and Williamson [WW77] gave alternative descriptions of the standard decomposition via greedy matching algorithms as well as explicit local rules to follow the chains in the standard decomposition. The easiest-to-remember local rule using parenthesis matching was given by Greene and Kleitman [GK76].

Shearer and Kleitman [SK79] were the first to investigate chain decompositions of the n -cube that are different from the aforementioned standard decomposition. They proved that, when picking subsets $x, y \subseteq [n]$ at random, then the probability that x is a subset of y is at least $1/a_n$, for every probability distribution on Q_n . Their proof introduces the notion of orthogonal chain decompositions. Formally, two decompositions of Q_n into a_n (not necessarily symmetric or saturated) chains are called *orthogonal* if every two chains from the two decompositions have at most a single element of Q_n in common. For example, Figure 1 shows three pairwise orthogonal chain decompositions into 6 chains in Q_4 . Shearer and Kleitman conjectured that Q_n admits $b_n := \lfloor n/2 \rfloor + 1$ pairwise orthogonal chain decompositions all $n \geq 1$. As a warm-up exercise, we verified their conjecture for $n \leq 7$ with computer help. It is easy to see that there are at most b_n pairwise orthogonal decompositions: Fix some $y \subseteq [n]$ on level b_n , which for even n is one level above the unique middle level, and for odd n is the upper of the two middle levels. This y must be in some chain of each decomposition, and by the requirement that the decomposition must only use the minimum number a_n of chains, each such chain must also contain an $x \subseteq [n]$ on the (lower) middle level $b_n - 1$. As there are only b_n such pairs $\{x, y\}$ with $x \subseteq y$ (for fixed y), and each of them is contained in at most one of the decompositions, we obtain an upper bound of b_n on the number of pairwise orthogonal chain decompositions.

As a first step towards their conjecture, Shearer and Kleitman established the existence of *two* orthogonal chain decompositions for all $n \geq 2$. They proved this by showing that the standard decomposition and its complement, obtained by taking the complements of all sets with respect to the full set $[n]$, are almost-orthogonal. Formally, we say that two decompositions of Q_n into a_n symmetric and saturated chains are *almost-orthogonal* if every two chains from the two decompositions have at most a single element of Q_n in common, with the exception of the two unique chains of size $n+1$, which are only allowed to intersect in their minimal and maximal elements \emptyset and $[n]$. It is straightforward to verify that for $n \geq 5$, every family of $s \leq b_n$ almost-orthogonal decompositions can be modified to s orthogonal decompositions, by moving the empty set \emptyset in all but one of the decompositions from the unique longest chain to a shortest chain, one decomposition at a time (see [SK79, Spi17] for details).

Recently, Spink [Spi17] made the first progress towards the Shearer-Kleitman conjecture from 1979 by proving that Q_n has *three* pairwise orthogonal chain decompositions for $n \geq 24$. His proof follows the same route as Shearer and Kleitman, by showing that Q_n has three almost-orthogonal decompositions into symmetric and saturated chains. Using Spink's product construction, we improve on this result as follows:

Theorem 1. *For all $n \geq 60$, the n -cube has four pairwise almost-orthogonal decompositions into symmetric and saturated chains, and consequently four pairwise orthogonal chain decompositions.*

A slightly weaker notion than almost-orthogonality was introduced in a recent paper by Gregor, Jäger, Mütze, Sawada, and Wille [GJM⁺18]. We refer to any cover relation (x, y) where y covers x as an *edge* (y is one level above x and $x \subseteq y$), and we say that two decompositions of Q_n into a_n symmetric and saturated chains are *edge-disjoint* if the two decompositions do not share any edges. Equivalently, the two decompositions form edge-disjoint paths in the cover graph of Q_n , which is the graph formed by all cover relations. By this definition, every pair of almost-orthogonal chain decompositions is edge-disjoint, but not necessarily vice versa. As shown in [GJM⁺18], the main application of edge-disjoint chain decompositions is to construct cycle factors in subgraphs of Q_n induced by a sequence of levels around the middle. By the same reasoning as before, Q_n admits at most b_n pairwise edge-disjoint chain decompositions. The authors of [GJM⁺18] conjectured that this bound can be achieved for all $n \geq 1$. They verified this conjecture for $n \leq 7$, and proved that Q_n has *four* pairwise edge-disjoint decompositions for $n \geq 13$. We improve on this result as follows:

Theorem 2. *For all $n \geq 90$, the n -cube has five pairwise edge-disjoint decompositions into symmetric and saturated chains.*

Unless stated otherwise, all chains we consider in the following are symmetric and saturated, and we will from now on omit those qualifications. Moreover, we refer to any decomposition of Q_n into symmetric and saturated chains as an *SCD*. Also, when referring to a family of pairwise almost-orthogonal or pairwise edge-disjoint SCDs, we will from now on omit the qualification 'pairwise'.

Proof ideas To prove each of our two main theorems, we compute families of $s = 4$ almost-orthogonal and $s = 5$ edge-disjoint SCDs, for two cubes Q_a and Q_b of small coprime dimensions a and b . Specifically, these dimensions will be $(a, b) = (7, 11)$ and $(a, b) = (10, 11)$, respectively; see the shaded entries in Table 1. Using the product constructions presented in [Spi17] and [GJM⁺18], we then obtain s SCDs for all dimensions n for which n is a non-negative integer combination of a and b , in particular for all $n \geq (a - 1)(b - 1)$. This evaluates to $n \geq 60$ and $n \geq 90$ for the aforementioned values of a and b , respectively.

To find families of SCDs in cubes of small fixed dimension ($n = 7, 10$, and 11) that satisfy the desired constraints, we formulated the problem as a propositional formula in conjunctive normal form, and computed solutions using a standard SAT solver. Our main theoretical contribution here is to reduce the search space to a much smaller poset, the so-called *necklace poset* N_n , which is obtained as the quotient of Q_n under cyclic relabelings of the elements $\{1, \dots, n\}$. This strategy works particularly well when n is a prime number, and with some adjustments it can also be made to work for composite n .

Small dimensions Table 1 summarizes what is known for small values of n . Specifically, the table shows the maximum number of almost-orthogonal and edge-disjoint SCDs of Q_n that we know for $n \leq 11$, together with the upper bound b_n . As indicated in the table, we actually found six edge-disjoint SCDs of Q_{11} , which, using the product construction from [GJM⁺18], yields six edge-disjoint SCDs for all dimensions $n = 11k$, $k \in \mathbb{N}$. To extend this result to all but finitely many dimensions, thus improving Theorem 2, we would only need to find six edge-disjoint SCDs of Q_n for some other dimension n not of this form. It is also interesting to note that there are *no* three almost-orthogonal SCDs of Q_4 (see [Spi17]), i.e., in this case the trivial upper bound b_n cannot be achieved. Nevertheless, there are three orthogonal decompositions using non-symmetric chains in Q_4 —see Figure 1—so this shows that not every family of orthogonal chain decompositions can be obtained from almost-orthogonal SCDs.

n	1	2	3	4	5	6	7	8	9	10	11
almost-orthogonal SCDs	1	2	2	2	3	3*	4*	3*	3*	3	4*
edge-disjoint SCDs	1	2	2	3	3	4	4	4	4*	5*	6*
upper bound $b_n = \lfloor n/2 \rfloor + 1$	1	2	2	3	3	4	4	5	5	6	6

Table 1: Number of almost-orthogonal and edge-disjoint SCDs of Q_n we know for $n \leq 11$. Entries marked with * are new compared to the earlier results from [Spi17] and [GJM⁺18]. The corresponding families of SCDs are provided electronically on the authors’ website [www], and for the shaded entries they are also shown in Figures 7–10. The entries in the dotted box are explained in the text.

Our lower bounds in the table for edge-disjoint SCDs differ from the upper bound b_n by 1 exactly for the dimensions $n = 8, 9, 10$; see the dotted box in Table 1. In fact, it can be shown that our approach for finding edge-disjoint SCDs via the necklace poset N_n

yields at most $b_n - 1$ edge-disjoint SCDs of Q_n for all even n and for $n = 9$ (see Lemma 8 below), so our methods cannot yield better lower bounds for those cases.

Related work There has been considerable amount of work on partitioning the n -cube using possibly non-symmetric and/or non-saturated chains. One of the most interesting open problems in this direction is a well-known conjecture of Füredi [Für85] (cf. [Gri88]), which asserts that Q_n can be decomposed into a_n (not necessarily symmetric or saturated) chains whose sizes differ by at most 1, so their size is $2^n/a_n$ rounded up or down, which is approximately $\sqrt{\pi n}(1 + o(1))$. Tomon [Tom15] recently made some progress towards this conjecture, by showing that for large enough n , the n -cube can be decomposed into a_n chains whose size is between $0.8\sqrt{n}$ and $13\sqrt{n}$. Another remarkable result, recently shown by Gruslys, Leader, and Tomon [GLT19], is that for large enough n , the n -cube can be partitioned into copies of any fixed poset P , provided that the number of elements of P is a power of 2, and that P has a unique minimal and maximal element.

Pikurkho [Pik99] showed that all edges of the n -cube can be partitioned into symmetric chains, but it is not clear whether some of those chains can be selected to form one or more SCDs. In a slightly different direction, Streib and Trotter [ST14] presented the construction of an SCD of the n -cube that can be extended to a Hamiltonian cycle through the entire cover graph.

The existence and construction of SCDs has also been investigated for many graded posets different from Q_n . To this end, Griggs [Gri77] gave a sufficient condition for a general graded poset to admit an SCD. The paper [dBvETK51] proves that divisor lattices, which are products of chains, are symmetric chain orders.

Griggs, Killian, and Savage first constructed an explicit SCD of the necklace poset N_n [GKS04] when the dimension n is a prime number, with the goal of constructing rotation-symmetric Venn diagrams for n curves in the plane (see [RSW06]). Their result for N_n with n prime was later generalized by Jordan [Jor10] to all $n \in \mathbb{N}$, and to even more general quotients of Q_n by Duffus, McKibben-Sanders, and Thayer [DMST12]. All these constructions in the necklace poset proceed by taking suitable subchains from the standard SCD of Q_n . Further generalizations of these results can be found in [Dha12, HS13, DT15].

Outline of this paper In Section 2 we present the proofs of our two main theorems. The proofs of two crucial lemmas, which settle the base cases for our construction, are deferred to Section 5 at the end of the paper. In Section 3 we explain our reduction technique to produce SCDs of Q_n by working in the much smaller necklace poset N_n , and in Section 4 we describe how to exploit this reduction using a SAT solver.

2 Proofs of Theorems 1 and 2

As already mentioned in the introduction, both of our theorems are proved by applying product constructions established in [Spi17] and [GJM⁺18], respectively, which allow us to obtain s almost-orthogonal or edge-disjoint SCDs of Q_{a+b} , given s such SCDs in the

smaller cubes Q_a and Q_b . In the following we will repeatedly use the basic number-theoretic fact that, if a and b are coprime integers, then every integer $n \geq (a-1)(b-1)$ is a non-negative integer combination of a and b .

2.1 Proof of Theorem 1

The product construction for almost-orthogonal SCDs requires an additional property that we now define: A family of almost-orthogonal SCDs of the n -cube for some odd n is called *good* if the union of edges given by all chains of size 2 from all the decompositions forms a unicyclic graph, i.e., a graph all of whose components contain at most a single cycle. The following crucial statement was proved in [Spi17].

Lemma 1 ([Spi17, Theorem 3.3]). *Let $s \geq 3$ and $r \geq 2$ be integers, and let $n_1, \dots, n_r \geq 3$ be a sequence of odd integers. If each Q_{n_i} , $1 \leq i \leq r$, has a good family of s almost-orthogonal SCDs, then $Q_{n_1+\dots+n_r}$ has s almost-orthogonal SCDs.*

The base case for applying Lemma 1 is the following result, which will be proved in Section 5.

Lemma 2. *The cubes Q_7 and Q_{11} each have four good almost-orthogonal SCDs.*

Proof of Theorem 1. As every integer $n \geq (7-1)(11-1) = 60$ is a non-negative integer combination of 10 and 11, we can apply Lemmas 1 and 2 to obtain the desired SCDs. \square

Spink [Spi17, Theorem 3.4] also proved that the goodness requirement in Lemma 1 can be omitted if the additional condition $r \geq 6$ is added. As every integer $n \geq 60$ is a non-negative integer combination of 7 and 11 where each number is used at least 6 times, we would not need the families of SCDs of Q_7 and Q_{11} to be good to prove Theorem 1. However, since proving this modified version of Lemma 1 is considerably harder, partially deferred to another paper [DST18], and since goodness is not hard to achieve on top of almost-orthogonality, we prefer to stick with Lemma 1 in its stated form. Moreover, in this form the lemma also yields four almost-orthogonal SCDs for all non-negative integer combinations of 7 and 11 that are smaller than 60.

2.2 Proof of Theorem 2

The following product lemma for edge-disjoint SCDs was proved in [GJM⁺18].

Lemma 3 ([GJM⁺18, Theorem 5]). *If Q_a and Q_b each have s edge-disjoint SCDs, then Q_{a+b} has s edge-disjoint SCDs.*

The base case for applying Lemma 3 is the following result, which will be proved in Section 5.

Lemma 4. *The cubes Q_{10} and Q_{11} each have five edge-disjoint SCDs.*

Proof of Theorem 2. As every integer $n \geq (10-1)(11-1) = 90$ is a non-negative integer combination of 10 and 11, we can apply Lemmas 3 and 4 to obtain the desired SCDs. \square

To complete the proofs of our main theorems, it remains to prove Lemma 2 and Lemma 4. The corresponding SCDs are provided in Section 5 below.

3 Unrolling the necklace poset

Given a subset $x \subseteq [n]$, we write $\sigma(x)$ for the subset obtained from x by cyclically renaming elements $1 \rightarrow 2 \rightarrow \dots \rightarrow n \rightarrow 1$. Moreover, we write $\langle x \rangle$ for the family of all subsets obtained by repeatedly applying σ to x , and we refer to $\langle x \rangle$ as a *necklace*, and to any element of $\langle x \rangle$ as a *necklace representative*. We say that the necklace $\langle x \rangle$ is *full* if $|\langle x \rangle| = n$, and *deficient* if $|\langle x \rangle| < n$. For example, for $n = 4$ the necklace $\langle \{1,3,4\} \rangle = \{\{1,3,4\}, \{2,4,1\}, \{3,1,2\}, \{4,2,3\}\}$ is full, and the necklace $\langle \{1,3\} \rangle = \{\{1,3\}, \{2,4\}\}$ is deficient. Note that the cardinality of any necklace divides n . Consequently, if n is a prime number, then $\langle \emptyset \rangle$ and $\langle [n] \rangle$ are the only deficient necklaces, and all other necklaces are full. On the other hand, if n is composite, then there are more than these two deficient necklaces.

The *necklace poset* N_n is the set of all necklaces $\langle x \rangle$, $x \subseteq [n]$, and its cover relations are all pairs $(\langle x \rangle, \langle y \rangle)$ for which (x, y) form a cover relation in the n -cube; see the left hand side of Figure 2. Similarly to the n -cube, we also refer to the cover relations in N_n as *edges*. As σ preserves the set size, N_n inherits the level structure from Q_n , and notions such as symmetric chains and SCDs translate to N_n in the natural way.

As almost all necklaces of N_n are full, we have that N_n is by a factor of $n(1 - o(1))$ smaller than Q_n , which turns out to be crucial for our computer searches for SCDs. We now collect a few simple observations about transferring SCDs from N_n to Q_n . These observations are illustrated in Figure 2. Recall that all chains we consider are symmetric and saturated.

Observation 5. *Let $y = (y_1, \dots, y_k)$ be a chain of full necklaces in N_n . Then there are necklace representatives $x = (x_1, \dots, x_k)$ with $x_i \in y_i$ for $1 \leq i \leq k$, such that $\sigma^i(x) = (\sigma^i(x_1), \dots, \sigma^i(x_k))$ for $i = 0, \dots, n-1$ is a family of n disjoint chains in Q_n that visit exactly all elements from y_1, \dots, y_k .*

The easiest way to pick necklace representatives satisfying those conditions is to move up the chain y from its minimal element y_1 to its maximal element y_k , starting with an arbitrary representative $x_1 \in y_1$, and then greedily picking $x_{j+1} \in y_{j+1}$ for $j = 1, \dots, k-1$ such that (x_j, x_{j+1}) is an edge in Q_n .

We refer to the process of translating a chain from N_n to a family of n chains in Q_n as described by Observation 5 as *unrolling*. As an example, consider the chain $(y_1, \dots, y_4) = (\langle \{1\} \rangle, \langle \{1,2\} \rangle, \langle \{1,2,3\} \rangle, \langle \{1,2,3,4\} \rangle)$ in N_5 . The necklace representatives $x = (x_1, \dots, x_4) = (\{1\}, \{1,2\}, \{1,2,3\}, \{1,2,3,4\})$ form a chain in Q_5 , and $\sigma^i(x)$, $i = 0, \dots, 4$, is a family of five disjoint chains in Q_5 that visit exactly all $5 \cdot 4 = 20$ elements from y_1, \dots, y_4 . It is crucial here to observe that the choice of necklace representatives in Observation 5 is *not unique*. In the previous example, we could also choose $x = (x_1, \dots, x_4) = (\{1\}, \{1,5\}, \{1,4,5\}, \{1,2,4,5\})$ as necklace representatives, yielding a *different* family of five disjoint chains in Q_5 .

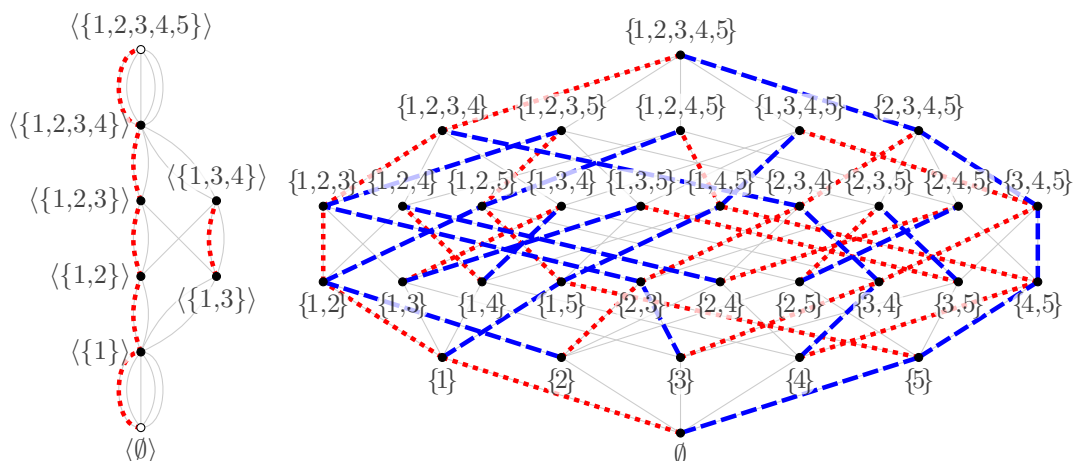

Figure 2: Unrolling an SCD of the necklace poset N_5 (left) to an SCD of the 5-cube (right). The SCD is highlighted by dotted lines, full necklaces are indicated by filled bullets, and deficient necklaces are indicated by empty bullets. Complementing the resulting SCD of Q_5 yields another SCD (dashed lines), which is edge-disjoint from the first one. The capacities of the edges of N_n are visualized by multiple parallel edges.

The notion of unrolling can be extended straightforwardly from a chain of full necklaces to a chain that has one deficient necklace at each of its ends, as captured by the following observation. The crucial insight here is that if a necklace $\langle x \rangle$ is deficient and of size $d < n$, then $\langle x \rangle = \{\sigma^i(x) \mid i = 0, \dots, d-1\}$.

Observation 6. *Let (y_0, \dots, y_{k+1}) be a chain of necklaces in N_n such that y_1, \dots, y_k are full and y_0 and y_{k+1} are deficient and of the same size $d < n$. Then there are necklace representatives (x_0, \dots, x_{k+1}) with $x_i \in y_i$ for $0 \leq i \leq k+1$, such that $\sigma^i(x_0, \dots, x_{k+1})$ for $i = 0, \dots, d-1$, and $\sigma^i(x_1, \dots, x_k)$ for $i = d, \dots, n-1$, is a family of n disjoint chains in Q_n that visit exactly all elements from y_0, \dots, y_{k+1} .*

As an example, consider the chain $y = (y_0, \dots, y_4) = (\langle\{1,5\rangle\rangle, \langle\{1,2,5\rangle\rangle, \langle\{1,2,3,5\rangle\rangle, \langle\{1,2,3,5,6\rangle\rangle, \langle\{1,2,3,5,6,7\rangle\rangle)$ in N_8 . It has one deficient necklace of size $d = 4$ at each of its ends, and all inner necklaces are full. Taking $x = (x_0, \dots, x_4) = (\{1,5\}, \{1,2,5\}, \{1,2,3,5\}, \{1,2,3,5,6\}, \{1,2,3,5,6,7\})$ as necklace representatives, unrolling yields four chains of size 5, namely $\sigma^i(x_0, \dots, x_4)$ for $i = 0, 1, 2, 3$, and it yields four chains of size 3, namely $\sigma^i(x_1, \dots, x_3)$ for $i = 4, 5, 6, 7$.

We say that a chain in N_n is *unimodal* if its minimal and maximal element are necklaces of the same size (possibly deficient), and all other elements are full necklaces. Moreover, we say that an SCD of N_n is *unimodal* if all of its chains are unimodal. Combining Observations 5 and 6 yields the following fact, which allows us to translate an entire SCD from N_n to Q_n .

Observation 7. *Given a unimodal SCD of N_n , $n \geq 1$, unrolling each of its chains yields an SCD of Q_n .*

This observation is illustrated in Figure 2. We refer to the process of unrolling all chains of an SCD of N_n to an SCD of Q_n as *unrolling the SCD*. Recall that in this unrolling process there may be several choices for picking necklace representatives for each chain.

We now want to simultaneously unroll multiple SCDs from N_n to edge-disjoint SCDs of Q_n . This motivates the following definitions: For any edge $e = (\langle x \rangle, \langle y \rangle)$ of N_n where $\langle x \rangle$ is on level $k \leq (n-1)/2$, we define the *capacity* $c(e)$ as the number of distinct elements from $[n]$ can be added to x to reach an element in $\langle y \rangle$. For any edge $e = (\langle y \rangle, \langle x \rangle)$ of N_n where $\langle x \rangle$ is on level $k \geq (n+1)/2$, we define the capacity $c(e)$ symmetrically by $c(e) := c(\langle x \rangle, \langle y \rangle)$, where $\langle x \rangle := \langle [n] \setminus x \rangle$. We can think of the cover graph of N_n with those capacities on its edges e as a multigraph with edge multiplicities $c(e)$; see the left hand side of Figure 2. It is easy to see that the sum of capacities of all edges $e = (\langle x \rangle, \langle y \rangle)$ for fixed $\langle x \rangle$ on level $k \leq (n-1)/2$ is $n-k$, which is equal to the number of neighbors of x in level $k+1$ of the cover graph of Q_n . We say that a family of unimodal SCDs of N_n is *edge-disjoint* if for every edge e in N_n , there are at most $c(e)$ chains in those SCDs containing this edge.

For even $n \geq 4$, the middle level of N_n contains the deficient necklace $\langle \{1, 3, 5, \dots, n-1\} \rangle$. Consequently, any unimodal chain containing this necklace has size 1. It follows that the proof for the upper bound b_n for the maximum number of edge-disjoint SCDs given in the introduction (for Q_n) can be improved by 1, yielding the following lemma.

Lemma 8. *For even $n \geq 4$, there are at most $b_n - 1 = n/2$ unimodal SCDs of N_n that are edge-disjoint.*

Lemma 8 shows that our approach via the necklace poset N_n yields at most four edge-disjoint SCDs of N_8 and at most five edge-disjoint SCDs of N_{10} ; recall the remarks after Table 1. By considering the deficient necklace $\langle \{1, 4, 7\} \rangle$ and its complement in N_9 , a similar ad-hoc argument shows that N_9 has at most $b_9 - 1 = 4$ edge-disjoint SCDs (see [Wil18] for details).

The following lemma was stated and proved in [GJM⁺18, Lemma 7] in slightly different form.

Lemma 9 ([GJM⁺18]). *Let $n \geq 2$ be a prime number. Every family of $s \leq b_n$ unimodal SCDs of N_n that are edge-disjoint can be unrolled to s edge-disjoint SCDs of Q_n .*

In Section 5 we will apply Lemma 9 to prove the case $n = 11$ of Lemma 4.

Note that the conclusion of Lemma 9 does not hold if the dimension n is not prime, but composite. The example in Figure 3 shows that even two chains between two deficient necklaces in N_n cannot always be unrolled so that the resulting sets of chains are edge-disjoint in Q_n . Consequently, in general it may not be possible to unroll two edge-disjoint SCDs of N_n to two edge-disjoint SCDs of Q_n . Nevertheless, the following result shows that unrolling is possible for two known constructions of SCDs of N_n . Specifically, these constructions are due to Griggs, Killian, and Savage [GKS04] for prime n , and due to Jordan [Jor10] for all n , and they will be explained in the next section. It is worth to mention that both constructions in general yield different SCDs for prime n ; see Figure 4.

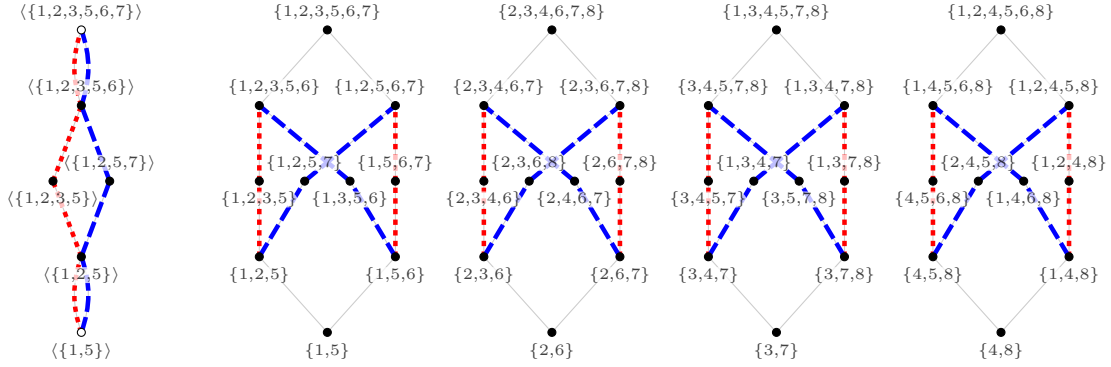

Figure 3: Given the two unimodal chains in N_8 (left; the chains are dashed and dotted), it is impossible to unroll them so that the resulting sets of chains are edge-disjoint in Q_8 (right). In each of the four blocks on the right, extending one of the two dashed chains to include the two extreme elements prevents both dotted chains to be extended.

The next lemma shows that the resulting SCDs of N_n can be unrolled, yielding not only two edge-disjoint SCDs, but even two almost-orthogonal SCDs of Q_n .

Lemma 10. *For every prime $n \geq 2$, the unimodal SCD of N_n constructed as in [GKS04] and its complement can be unrolled to two almost-orthogonal SCDs of Q_n .*

For every $n \geq 1$, the unimodal SCD of N_n constructed as in [Jor10] and its complement can be unrolled to two almost-orthogonal SCDs of Q_n .

In Section 5 we will apply Lemma 10 to prove the cases $n = 7$ and $n = 11$ in Lemma 2, and the case $n = 10$ in Lemma 4.

The proof of Lemma 10 is rather long and technical, and will be given in the next section. It is followed by Section 4, where we describe our computer search for SCDs of the necklace poset using a SAT solver. The reader may want to skip these parts for the moment, and continue in Section 5 with the proofs of Lemmas 2 and 4.

3.1 Proof of Lemma 10

In the remainder of this section we represent subsets of $[n]$ by their characteristic $\{0, 1\}$ -strings of length n . The i th entry of a bitstring x is denoted by x_i . For instance, the set $x = \{1, 3, 5, 6\} \subseteq [6]$ is represented by the bitstring $x = x_1 \dots x_6 = 101011 \in \{0, 1\}^6$. The operation $\sigma(x)$ on the set x translates to a cyclic right-rotation of the bitstring x . Moreover, we write $|x|$ for the number of 1s in x , which is the same as the level of x in Q_n . Also, for any bitstring x and any integer $r \geq 0$, we write x^r for the concatenation of r copies of x .

We begin by recapitulating the SCD constructions in the n -cube and the necklace poset described in the three papers [GK76, GKS04, Jor10]. For the reader's convenience, these constructions are illustrated in Figure 4 for $n = 7$.

The Greene-Kleitman construction in Q_n Greene and Kleitman [GK76] proposed the following explicit construction of an SCD of Q_n . Given any bitstring x of length n , we think of every 0-bit as an opening parenthesis, and every 1-bit as a closing parenthesis, and we match closest pairs of opening and closing parentheses in the natural way. We let $M(x)$ be the set of all index pairs corresponding to matched parentheses in x , and we let $U_0(x)$ and $U_1(x)$ be the index sets of unmatched opening and closing parentheses, respectively. The length of x clearly satisfies $n = 2|M(x)| + |U_0(x)| + |U_1(x)|$. For any x with $U_0(x) \neq \emptyset$, we let $\tau(x)$ be the bitstring obtained from x by flipping the leftmost unmatched 0 to a 1. The union of all chains $(x, \tau(x), \dots, \tau^k(x))$, where $x \in \{0, 1\}^n$ with $U_1(x) = \emptyset$ and $k = |U_0(x)|$, forms an SCD of the n -cube for all $n \geq 1$. This follows easily from the observation that we have $M(x) = M(\tau(x)) = \dots = M(\tau^k(x))$ and $U_0(\tau^k(x)) = \emptyset$ along each chain as before, so the chain is uniquely determined by its matched pairs of parentheses. We denote this SCD by D_n . This is exactly the standard SCD of the n -cube mentioned in the introduction.

The Griggs-Killian-Savage construction in N_n for prime n To construct an SCD of N_n for prime n , Griggs, Killian, and Savage [GKS04] use the standard SCD D_n in Q_n as a starting point and select subchains of D_n , such that exactly one representative of each necklace is contained in one of the subchains.

For this purpose we define, for any $x \in \{0, 1\}^n$, the *block code* $\beta(x)$ as follows: If x has the form $x = 1^{a_1}0^{b_1}1^{a_2}0^{b_2} \dots 1^{a_r}0^{b_r}$ with $r \geq 1$ and $a_i, b_i \geq 1$ for all $i = 1, \dots, r$, then $\beta(x) := (a_1 + b_1, a_2 + b_2, \dots, a_r + b_r)$. Otherwise we define $\beta(x) := (\infty)$. If $\beta(x) \neq (\infty)$, then we say that the block code of x is *finite*. Note that the block code is finite if and only if x starts with 1 and ends with 0. Observe also that for all chains from the standard SCD D_n , the block code of all bitstrings along the chain is the same, except for the two chain endpoints, which have block code (∞) ; see Figure 4. For prime n , we let $R_n^{\text{GKS}} \subseteq \{0, 1\}^n$ be the set of all necklace representatives whose block code is lexicographically minimal in their necklace. As n is prime, this gives exactly one representative per necklace.¹ It was shown in [GKS04] that the representatives R_n^{GKS} induce symmetric and saturated subchains of D_n , and we denote these subchains by D_n^{GKS} . Clearly, the corresponding chains in the necklace poset form an SCD of N_n .

The Jordan construction in N_n for arbitrary n Jordan's construction [Jor10] of an SCD of N_n for arbitrary n also uses the standard SCD D_n in Q_n as a starting point, but selects subchains in a different fashion. We let R_n^{J} be the set of all necklace representatives that have the maximum number of unmatched 1s in their necklace. Note that R_n^{J} may contain several representatives from the same necklace; see Figure 4. It was shown in [Jor10] that these representatives R_n^{J} induce symmetric and saturated subchains of D_n . We now greedily search for pairs of chains that contain two representatives of the same necklace. Jordan showed in her paper that these duplicates always lie symmetrically at the ends of both chains, so we may trim the shorter of the two chains

¹If n is composite, the method fails, as there may be several necklace representatives with the same block code, e.g., $x = 100110$ and $y = 110100$ with $\beta(x) = \beta(y) = (3, 3)$.

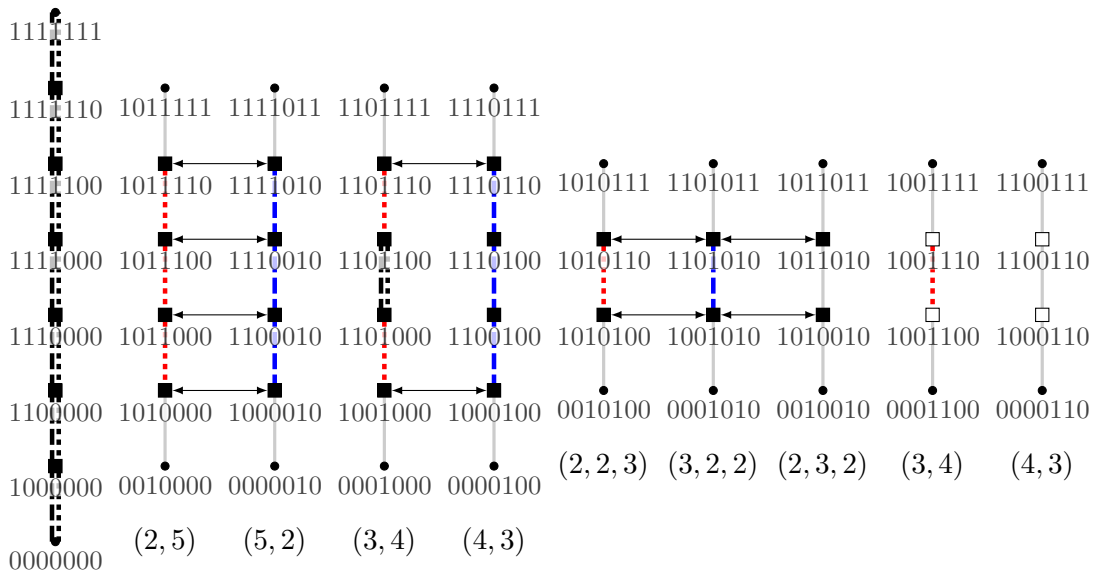

Figure 4: Illustration of the Greene-Kleitman construction of an SCD of Q_n , and the Griggs-Killian-Savage construction and the Jordan construction of an SCD of N_n for $n = 7$. The figure shows only those chains from the standard SCD D_n that contain a bitstring with finite block code, all other chains from D_n are omitted. Bitstrings with finite block code are represented by squares. The block code of the inner bitstrings of each chain is shown below the chains; the block code of all chain endpoints is (∞) . Filled squares represent bitstrings with the maximum number of unmatched 1s in their necklace. The subchains D_n^{GKS} (dotted) and D_n^{J} (dashed) are highlighted. Pairs of representatives from the same necklace are highlighted by double arrows. This is where the trimming procedure applied in the Jordan construction is not unique. Note that the two resulting SCDs of N_n are distinct.

symmetrically at both ends. If both chains have the same size, then we trim any of the two, yielding different resulting subchains. We repeat this trimming process until each necklace has only a single representative left, and we denote the remaining subchains of D_n by D_n^{J} . Clearly, the corresponding chains in the necklace poset form an SCD of N_n . We emphasize again that the outcome of the greedy trimming procedure is not unique, but could be made unique by some lexicographic tie-breaking rule.

Proof of Lemma 10 The following five lemmas are the main steps for proving Lemma 10. The proofs of those lemmas are deferred to the next subsection.

Lemma 11. *Consider two distinct bitstrings x and y with finite block code that lie on the same chain of D_n . Then for every $k \geq 0$, the bitstrings $\sigma^k(\bar{x})$ and $\sigma^k(\bar{y})$ do not lie on the same chain of D_n .*

The next two lemmas capture crucial properties of the subchains D_n^{GKS} of D_n obtained from the Griggs-Killian-Savage construction.

Lemma 12. *For every prime $n \geq 2$ and every chain from D_n^{GKS} , the corresponding necklaces form a unimodal chain in N_n .*

Lemma 13. *For every prime $n \geq 2$, all necklace representatives in R_n^{GKS} except 0^n and 1^n have finite block code.*

The next two lemmas are the analogous statements for the subchains D_n^{J} obtained from the Jordan construction.

Lemma 14. *For every $n \geq 1$ and every chain from D_n^{J} , the corresponding necklaces form a unimodal chain in N_n .*

Lemma 15. *For every $n \geq 1$, all necklace representatives in R_n^{J} except 0^n and 1^n have finite block code.*

With these lemmas in hand, the proof of Lemma 10 is straightforward.

Proof of Lemma 10. We first consider the SCD of N_n for prime $n \geq 2$ obtained via the Griggs-Killian-Savage construction described before, specified by the chains of necklace representatives D_n^{GKS} . We let U_n be the SCD of Q_n obtained by unrolling each chain from this SCD. Furthermore, we let \overline{U}_n be the SCD of Q_n obtained by unrolling each chain from the complement of this SCD, or equivalently, by taking the complement of U_n . In both cases, unrolling is possible because of Lemma 12 (recall Observations 5 and 6), where we also use that complementation preserves unimodality.

It remains to show that U_n and \overline{U}_n are almost-orthogonal SCDs of Q_n . For this consider two distinct bitstrings x' and y' on the same chain in U_n that are neither 0^n nor 1^n . There is a unique $k \geq 0$, such that $x' = \sigma^k(x)$ and $y' = \sigma^k(y)$ for two bitstrings x and y on the same chain in D_n^{GKS} . Consider the following chain of implications:

- x' and y' lie on the same chain in \overline{U}_n .
- $\overline{x'}$ and $\overline{y'}$ lie on the same chain in U_n .
- There is a unique $\ell \geq 0$, so that $\sigma^\ell(\overline{x'})$ and $\sigma^\ell(\overline{y'})$ lie on the same chain in D_n^{GKS} .
- $\sigma^{k+\ell}(\overline{x})$ and $\sigma^{k+\ell}(\overline{y})$ lie on the same chain in D_n^{GKS} .

From Lemma 13 we know that x and y have finite block code. Clearly, if two elements lie on the same chain in D_n^{GKS} , then they also lie on the same chain in D_n . Consequently, applying Lemma 11 falsifies the last of the above statements, so the first one is also false, i.e., we obtain that x' and y' do not lie on the same chain in \overline{U}_n . To complete the proof that U_n and \overline{U}_n are almost-orthogonal, we can verify directly that the unique longest chains in U_n and \overline{U}_n , namely $(0^n, 1^1 0^{n-1}, 1^2 0^{n-2}, \dots, 1^{n-2} 0^2, 1^{n-1} 0^1, 1^n)$ and its complement, intersect only in 0^n and 1^n .

The proof for the SCD of N_n for arbitrary $n \geq 1$ obtained via the Jordan construction, specified by the necklace representatives D_n^{J} , proceeds in an analogous fashion, using Lemmas 14 and 15 instead of Lemmas 12 and 13. \square

It remains to prove Lemmas 11–15, which will be done in the next three subsections.

Proof of Lemma 11 For the proof we will need the following auxiliary lemma.

Lemma 16. *Let $x, y \in \{0, 1\}^n$, and let i and j be two distinct indices such that $x_i x_{i+1} = 01$ and $y_i y_{i+1} \neq 01$, and $x_j x_{j+1} \neq 01$ and $y_j y_{j+1} = 01$. Then the sets $M(\sigma^k(x))$ and $M(\sigma^k(y))$ are distinct for all $k \geq 0$.*

Proof. Clearly, for any bitstring z we have that $(\ell, \ell + 1) \in M(z)$ if and only if $z_\ell z_{\ell+1} = 01$. In the following we consider all indices in x and y modulo n , with $1, \dots, n$ as representatives. As a consequence of our first observation, if $k \neq -i$, then $(k+i, k+i+1)$ is in $M(\sigma^k(x))$ but not in $M(\sigma^k(y))$. Similarly, if $k \neq -j$, then $(k+j, k+j+1)$ is in $M(\sigma^k(y))$ but not in $M(\sigma^k(x))$. As $i \neq j$, the two sets are distinct in any case. \square

Proof of Lemma 11. We assume without loss of generality that $|x| < |y|$, i.e., y is obtained from x by repeatedly applying τ . Furthermore, let i and j be the indices of the leftmost unmatched 0 in x and the rightmost unmatched 1 in y , respectively. More formally, we have $i = \min U_0(x)$ and $j = \max U_1(y)$. As x and y have finite block code, we have $x_1 = y_1 = 1$ and $x_n = y_n = 0$. In particular, these positions are unmatched, so $i > 1$ and $j < n$ are well-defined. Moreover, we clearly have $i \leq j$. Note that x_{i-1} is either matched or an unmatched 1. However, as every block of matched parentheses ends with 1, we have $x_{i-1} = y_{i-1} = 1$ in any case. A similar argument shows that $y_{j+1} = x_{j+1} = 0$. Summarizing, the situation looks as follows:

$$\begin{array}{cccc}
 1 & i & j & n \\
 y = 1 & *** & 1 & 1 & *** & 1 & 0 & *** & 0 \\
 x = 1 & *** & 1 & 0 & *** & 0 & 0 & *** & 0
 \end{array}
 \qquad
 \begin{array}{cccc}
 1 & i & j & n \\
 \bar{y} = 0 & *** & 0 & 0 & *** & 0 & 1 & *** & 1 \\
 \bar{x} = 0 & *** & 0 & 1 & *** & 1 & 1 & *** & 1
 \end{array}$$

From these observations it follows that $\overline{x_{i-1} x_i} = 01$ and $\overline{y_{i-1} y_i} = 00$, and similarly $\overline{x_j x_{j+1}} = 11$ and $\overline{y_j y_{j+1}} = 01$. Applying Lemma 16 to the indices $i-1$ and j in \bar{x} and \bar{y} hence shows that $M(\sigma^k(\bar{x}))$ and $M(\sigma^k(\bar{y}))$ are distinct for all $k \geq 0$. As each chain of D_n is uniquely described by its matched pairs of parentheses, we obtain that $\sigma^k(\bar{x})$ and $\sigma^k(\bar{y})$ do not lie on the same chain, proving the lemma. \square

Proofs of Lemmas 12 and 13

Proof of Lemma 12. This is trivial, as there are only two deficient necklaces for prime n , namely $\langle 0^n \rangle$ and $\langle 1^n \rangle$. \square

Proof of Lemma 13. Each bitstring x other than 0^n and 1^n has two consecutive bits $x_i x_{i+1} = 01$. Consequently, the rotated bitstring $\sigma^{-i}(x)$ starts with 1 and ends with 0 and therefore has finite block code. \square

strictly increase the number of unmatched 1s. A similar argument shows that $x_n = 0$, as otherwise we could rotate x to the right until the last 0-bit reaches the last position, which would strictly increase the number of unmatched 1s. These two observations imply that x has finite block code. \square

4 SAT based computer search

In this section we describe our computer search for SCDs in cubes of small dimension using a SAT solver.

4.1 The reduced necklace graph

We let N_n^- denote the multigraph obtained as follows: We consider the cover graph of N_n , where the edge multiplicities are given by the capacities (as defined before Lemma 8), and we remove all edges between a full necklace and a deficient necklace, whenever the deficient necklace is closer to the middle level(s); see Figure 6. Note here that even though N_n^- is a (multi)graph, it inherits the level structure from the poset N_n , so all the poset notions (chain, SCD, etc.) from before translate to N_n^- in the natural way. The aforementioned edge removals enforce that a chain containing a deficient necklace must either start or end at this necklace. Informally speaking, removing those edges does not harm us when searching for unimodal chains and SCDs, as they must not be contained in any unimodal chain anyway.

4.2 SAT formula for edge-disjoint SCDs of N_n^-

In this section we describe a propositional formula $\Phi(n, s)$ in conjunctive normal form (CNF), whose solutions correspond to s edge-disjoint unimodal SCDs of N_n^- . In the later sections we show how to modify those solutions, so that they can be unrolled to s edge-disjoint (and good almost-orthogonal) SCDs of Q_n . Throughout this section, the integers $n \geq 1$ and $s \geq 2$ are fixed.

We first compute the level sizes of N_n^- , and, based on this, the number c_n of chains and the chain sizes that an SCD must have. Different SCDs will be indexed by $i = 1, \dots, s$, and different chains in the i th SCD will be indexed by $j = 1, \dots, c_n$. We also assume that the chains of the i th SCD are indexed in decreasing order of their size, so chain $j = 1$ is the unique longest chain, and chain $j = c_n$ is a shortest chain.

We use Boolean variables $X_{i,j,e}$ to indicate that edge e of N_n^- is contained in chain j of decomposition i . Moreover, Boolean variables $Y_{i,j,u}$ are used to indicate that node u of N_n^- is contained in chain j of decomposition i . Clearly, we introduce these variables only for pairs (j, e) and (j, u) in the relevant levels. For instance, the node $u = \langle \emptyset \rangle$ can only be contained in the longest chain 1, so we only have a single variable $Y_{i,j,u}$ for fixed i and u , namely $Y_{i,1,u}$.

In the following we describe the clauses of our CNF formula $\Phi(n, s)$ in verbal form.

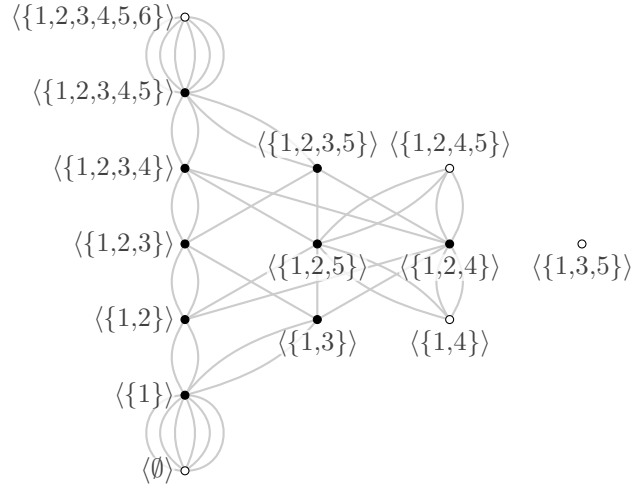

Figure 6: The multigraph N_6^- . As before, full necklaces are indicated by filled bullets, and deficient necklaces are indicated by empty bullets.

Link edge to node variables: If some edge variable $X_{i,j,e}$ is satisfied and the edge e connects nodes u and v , then both corresponding node variables $Y_{i,j,u}$ and $Y_{i,j,v}$ must be satisfied. Moreover, if some node variable $Y_{i,j,u}$ is satisfied and chain j extends above the level of u , then at least one edge variable $X_{i,j,e}$ for an edge e incident with u and a node from a level above must be satisfied. Similarly, if chain j extends below the level of u , then at least one edge variable $X_{i,j,e}$ for an edge e incident with u and a node from a level below must be satisfied. At a deficient necklace u , one or both of these edge sets are empty, and consequently a chain extending beyond the level of u in the corresponding direction will never be mapped to u .

Force chains to be present: For any chain j and a level k visited by this chain, at least one of the node variables $Y_{i,j,u}$, where u runs over all nodes on level k , must be satisfied.

Node-disjoint chains: For any node u on a level visited by two chains j and j' in the same SCD i , at most one of the two node variables $Y_{i,j,u}$ or $Y_{i,j',u}$ must be satisfied.

Enforce unimodality: For any deficient necklace u on some level $k \leq (n-1)/2$, if one of the node variables $Y_{i,j,u}$ is satisfied, then one of the corresponding variables $Y_{i,j,v}$, where v is on level $n-k$ and satisfies $|u| = |v|$, has to be satisfied. Note that there may be deficient necklaces of different sizes on the same level.

Edge-disjoint SCDs: For any two SCDs i and i' , any two chains j and j' from those SCDs, and any edge e between two consecutive levels that are intersected by both chains, at most one of the two edge variables $X_{i,j,e}$ and $X_{i',j',e}$ must be satisfied.

A useful trick to reduce the size of the resulting CNF formula dramatically is to fix some SCDs to be particular standard decompositions, for instance the ones mentioned

in Lemma 10, so that the corresponding edge and node variables are not free, but fixed constants. Similarly, we may also couple certain pairs of SCDs to be complements of each other, so only one set of variables is free, and the other is forced.

4.3 Unrolling by incremental CNF augmentation

Any solution of the CNF formula $\Phi(n, s)$ described before corresponds to s edge-disjoint unimodal SCDs of N_n^- (and N_n). However, as the example in Figure 3 shows, these SCDs cannot always be unrolled to s edge-disjoint SCDs of Q_n . Unfortunately, we have no systematic way to avoid this problem, so we resolve it in an ad-hoc fashion: We compute a satisfying assignment of $\Phi(n, s)$ using a SAT solver, and we test whether the current solution can be unrolled. If not, then we take the first pair of chains from two SCDs that cannot be unrolled simultaneously, and we add an additional clause that prevents this particular pair of chains to appear in a solution, yielding an augmented CNF formula $\Phi'(n, s)$. The advantage of this approach is that an incremental SAT solver has the ability to reuse information about the structure of $\Phi(n, s)$ when solving the augmented instance $\Phi'(n, s)$. We repeat this iterative process until we either find a solution that can be unrolled to s edge-disjoint SCDs of Q_n , or the resulting CNF formula has no satisfying assignment. In practice, this last case usually cannot be detected, as the solvers take too long to certify non-satisfiability.

4.4 Good almost-orthogonal SCDs

We take a similar incremental approach to compute good families of almost-orthogonal SCDs. Again we start with the CNF formula $\Phi(n, s)$, and keep adding constraints that prevent certain pairs of chains to appear. Specifically, we forbid a pair of chains if it cannot be unrolled or if the unrolled chains intersect in more than one node (or in more than two if these are the longest chains). It turns out that adding the following clauses right in the beginning speeds up the incremental search process considerably, as it immediately excludes many local violations of almost-orthogonality.

Forbid diamonds: Consider four edges $e = xv$, $f = vy$, $g = xw$, and $h = wy$ that form a ‘diamond’, i.e., x is on some level k , the elements v and w are on level $k + 1$, and y is on level $k + 2$ of N_n^- , such that for any necklace representative of x , flipping the two bits corresponding to e and f leads to the same representative of y as flipping the two bits corresponding to g and h . For any two SCDs i and i' and any two chains j and j' from those SCDs that intersect all levels k to $k + 2$, not all four edge variables $X_{i,j,e}$, $X_{i,j,f}$, $X_{i',j',g}$, $X_{i',j',h}$ must be satisfied.

The goodness property could be enforced in a similar incremental way, but coincidentally, the solutions we obtained all satisfied this property right away.

4.5 Implementation details

We used the incremental SAT solvers Glucose [ALS13] and MiniSat [ES03]. The unrolling tests and incremental CNF augmentation that drive the SAT solver were implemented in

n	s	SCDs	#variables	#clauses	solver	time	memory
7	4	almost-orthogonal	1.152	1.484	Glucose	0.048 s	11 MB
11	4	almost-orthogonal	132.432	1.437.326	MiniSat	23 min	972 MB
10	5	edge-disjoint	49.900	381.880	Glucose	2:29 h	501 MB
11	6	edge-disjoint	198.648	14.258.688	Glucose	3:51 h	1.6 GB

Table 2: Size of SAT instances and required computing resources. The number of variables and clauses are recorded at the end of the CNF augmentation and take into account internal simplifications carried out by the solver.

C++. Table 2 shows the sizes of the generated SAT instances, running times, and memory requirements for the four families of SCDs that we computed for proving Lemmas 2 and 4 (shown in Figures 7–10).

5 Proofs of Lemmas 2 and 4

To prove Lemmas 2 and 4, we describe families of four good almost-orthogonal SCDs and five edge-disjoint SCDs of the n -cube for $n = 7, 11$ or $n = 10, 11$, respectively. We specify those SCDs in Figures 7–10 in compact form, by unimodal SCDs of the necklace poset N_n , from which the SCDs in the n -cube can be recovered by unrolling as described in Section 3 and by taking complements of some of the resulting SCDs. We specify each chain in one of these SCDs uniquely by a particular choice of necklace representatives (recall Observations 5 and 6 and the remarks between them). The representatives are described by specifying the minimal and maximal elements of each chain, and the elements from $[n]$ that are added/removed from the sets when moving along the chains. The resulting full SCDs of Q_n are provided in files that can be downloaded from the authors’ website [www], together with a simple Python program for verification. In those files, subsets of $[n]$ are encoded by their characteristic bitstrings of length n (as in Section 3.1).

5.1 Proof of Lemma 2

We now describe four good almost-orthogonal SCDs of Q_7 and Q_{11} . The SCDs V_7 and V_{11} defined below are constructed as in [GKS04] (recall Section 3.1), and are then unrolled together with their complements as described in Lemma 10.

Figure 7 shows two SCDs V_7 and W_7 in N_7 , each consisting of 5 chains, that together with their complements $\overline{V_7}$ and $\overline{W_7}$ can be unrolled to four good almost-orthogonal SCDs of Q_7 ; see the file `Q7_4_ortho.txt`. Specifically, the union of all $4 \cdot 14 = 56$ edges given by all chains of size 2 of those SCDs forms one cycle of length 14 and 14 paths on 3 edges each. These are indeed all unicyclic components.

Figure 8 shows two SCDs V_{11} and W_{11} in N_{11} , each consisting of 42 chains, that together with their complements $\overline{V_{11}}$ and $\overline{W_{11}}$ can be unrolled to four good almost-orthogonal SCDs of Q_{11} ; see the file `Q11_4_ortho.txt`. Specifically, the union of all

$4 \cdot 132 = 528$ edges given by all chains of size 2 of those SCDs forms 66 isolated edges, 22 paths on 2, 3, or 7 edges each, 22 trees on 5 edges (the trees have one degree 3 node with paths of lengths 1, 1, and 3 attached to it), and 2 cycles of length 22 with an additional dangling edge attached to each node. These are all unicyclic components.

5.2 Proof of Lemma 4

We now describe five edge-disjoint SCDs of Q_{10} and six edge-disjoint SCDs of Q_{11} . The SCD X_{10} defined below is constructed as in [Jor10] (recall Section 3.1), and is then unrolled together with its complement as described in Lemma 10. The SCDs of Q_{11} were computed with the help of Lemma 9.

Figure 9 shows three SCDs X_{10} , Y_{10} , and Z_{10} in N_{10} , each consisting of 26 chains, that together with the complements \overline{X}_{10} and \overline{Y}_{10} can be unrolled to five edge-disjoint SCDs of Q_{10} ; see the file `Q10_5_edge.txt`.

Figure 10 shows three SCDs X_{11} , Y_{11} , and Z_{11} in N_{11} , each consisting of 42 chains, that together with their complements \overline{X}_{11} , \overline{Y}_{11} , and \overline{Z}_{11} can be unrolled to six edge-disjoint SCDs of Q_{11} ; see the file `Q11_6_edge.txt`.

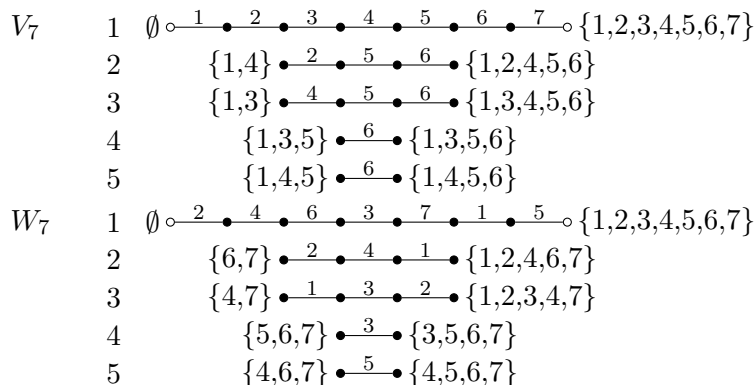
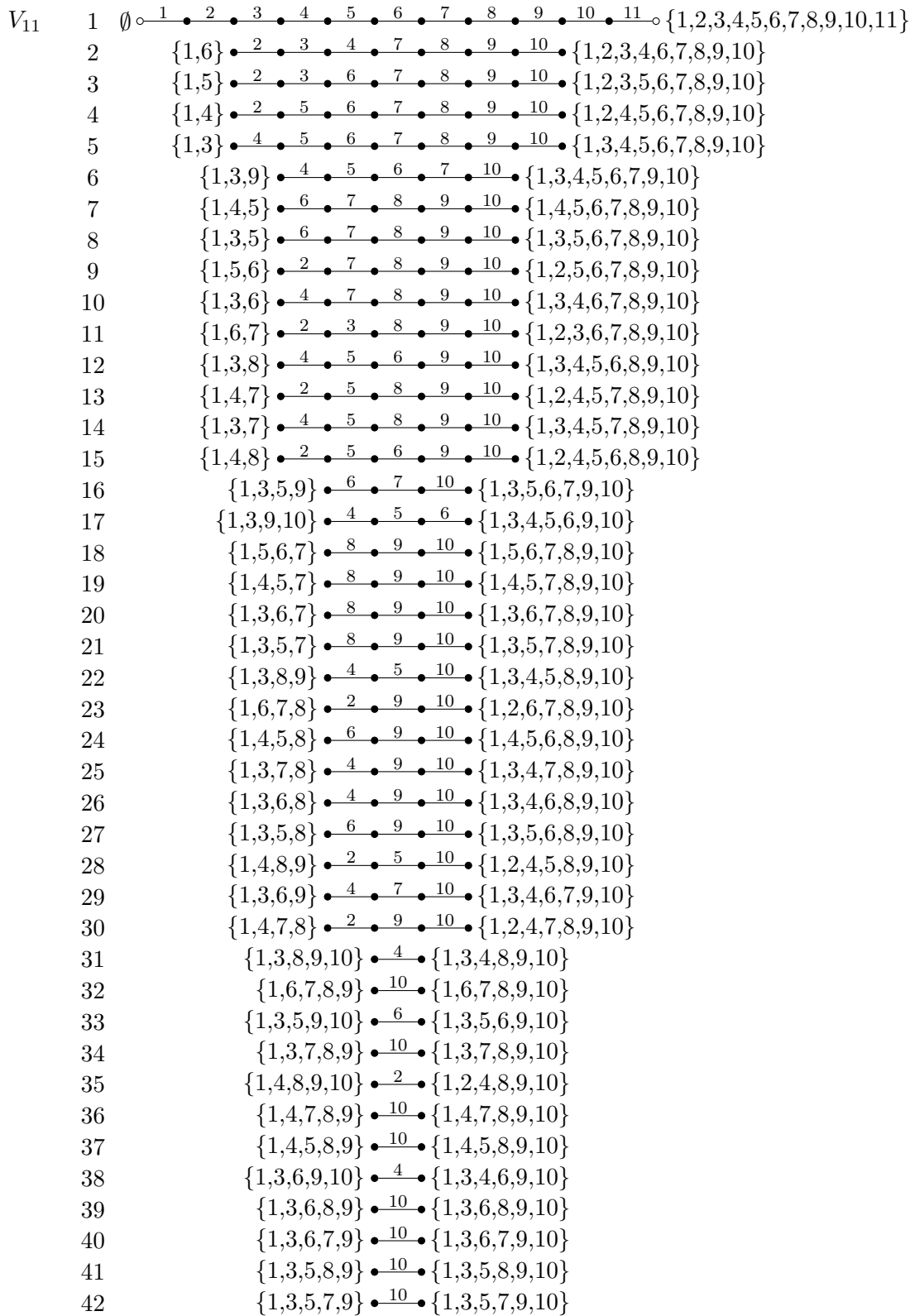

Figure 7: Two SCDs V_7 and W_7 in the necklace poset N_7 that together with their complements \overline{V}_7 and \overline{W}_7 can be unrolled to four good almost orthogonal SCDs in Q_7 .



(figure continues on next page)

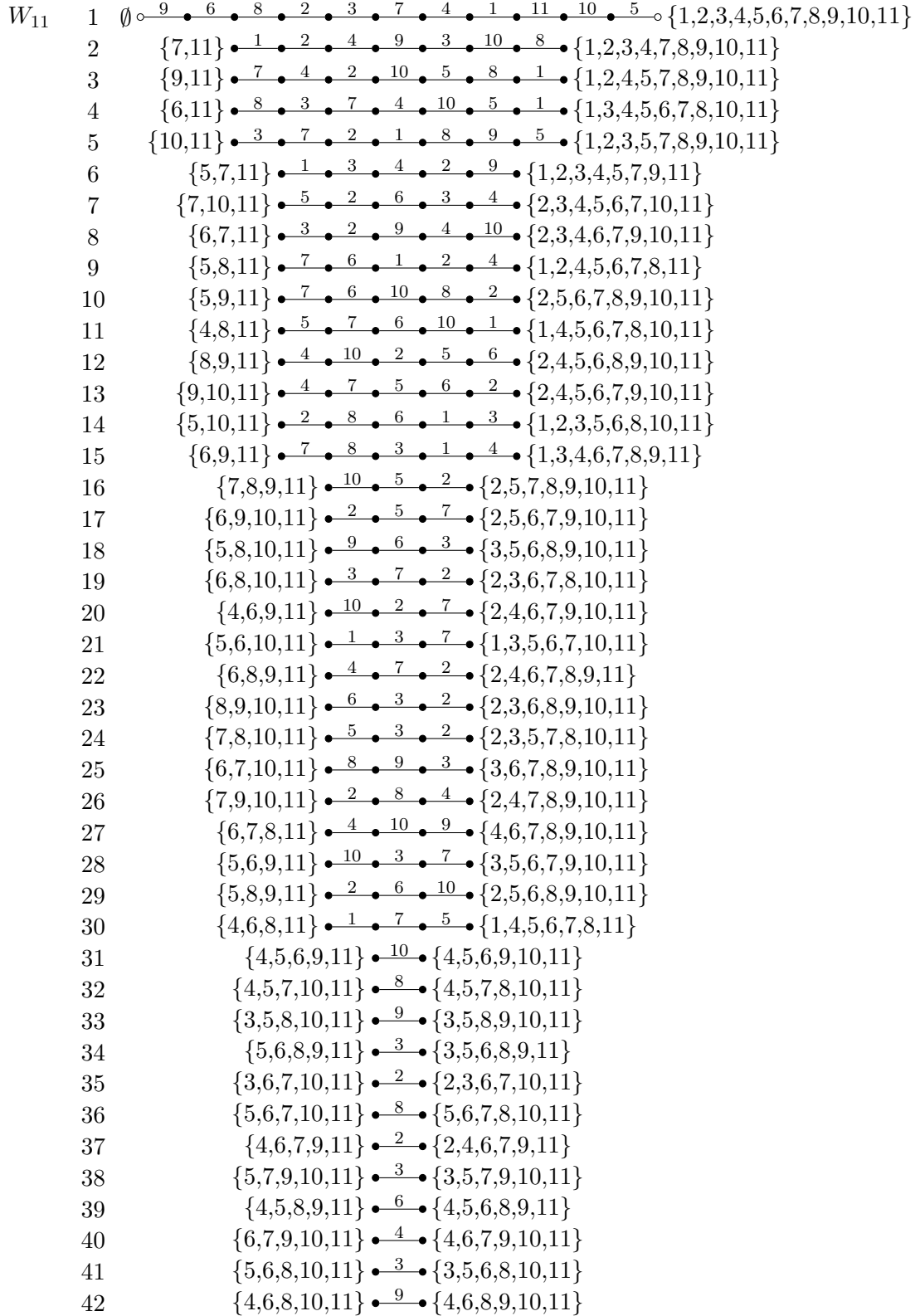
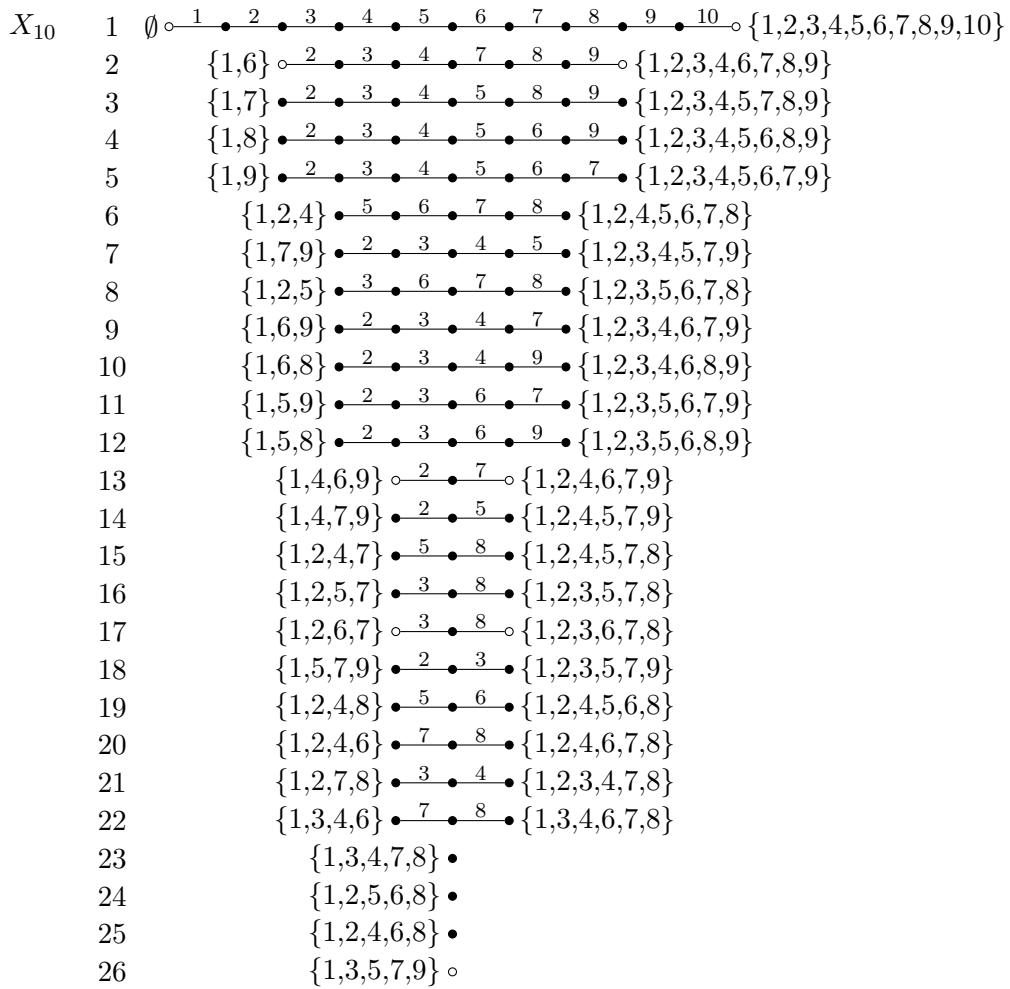
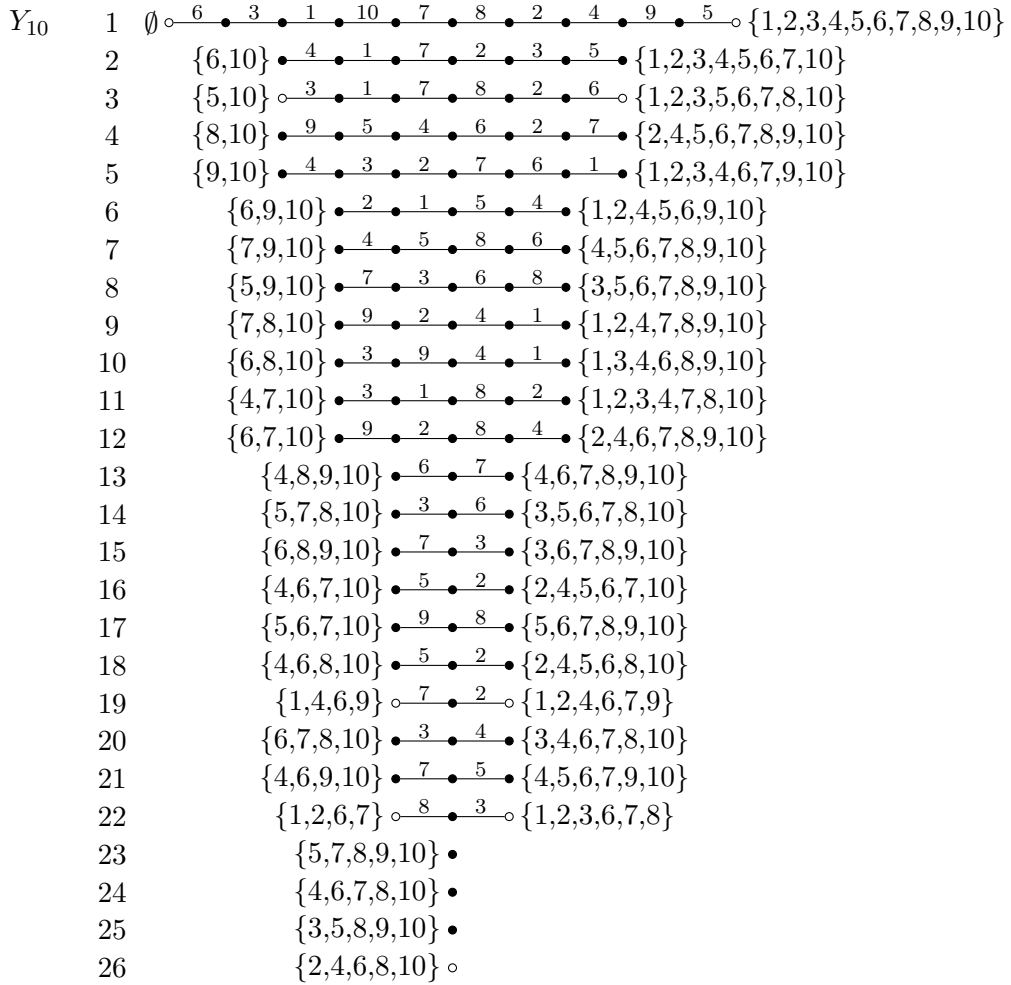

Figure 8: Two SCDs V_{11} and W_{11} in the necklace poset N_{11} that together with their complements $\overline{V_{11}}$ and $\overline{W_{11}}$ can be unrolled to four good almost orthogonal SCDs in Q_{11} .



(figure continues on next page)



(figure continues on next page)

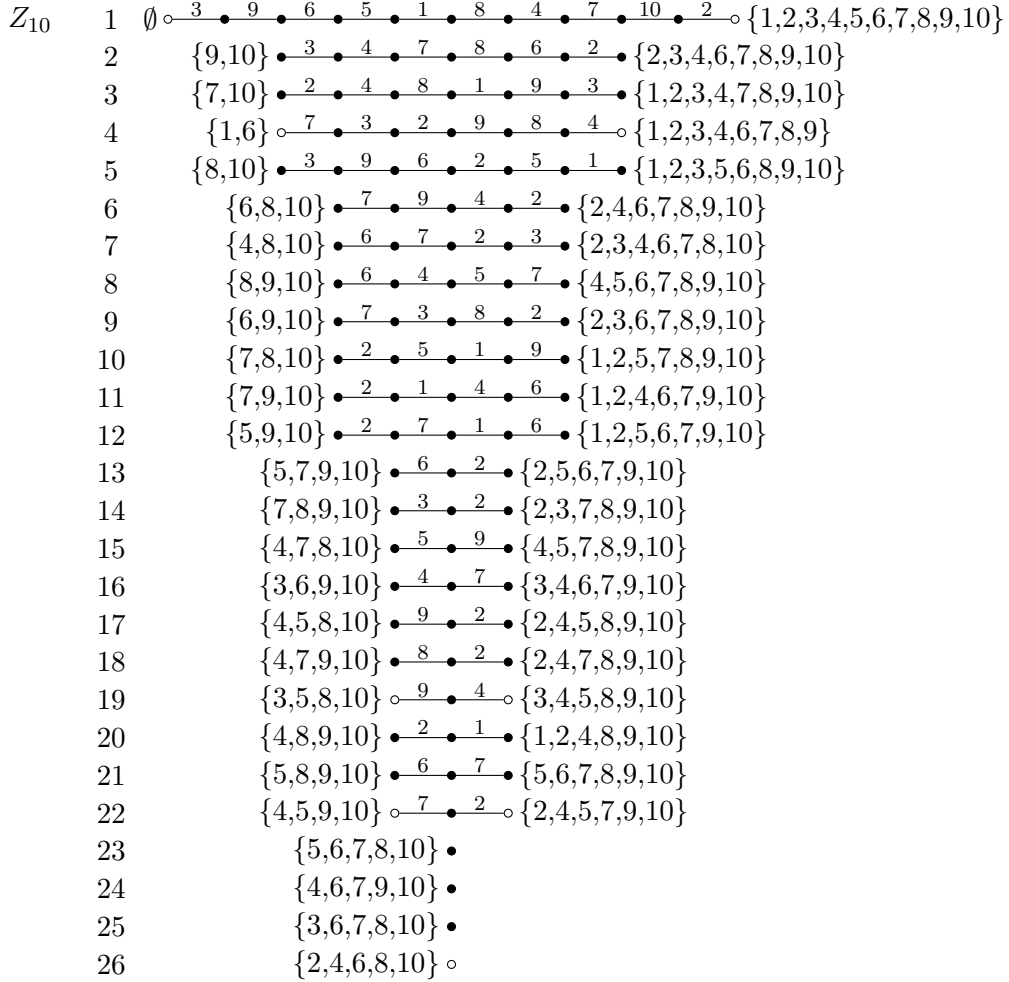
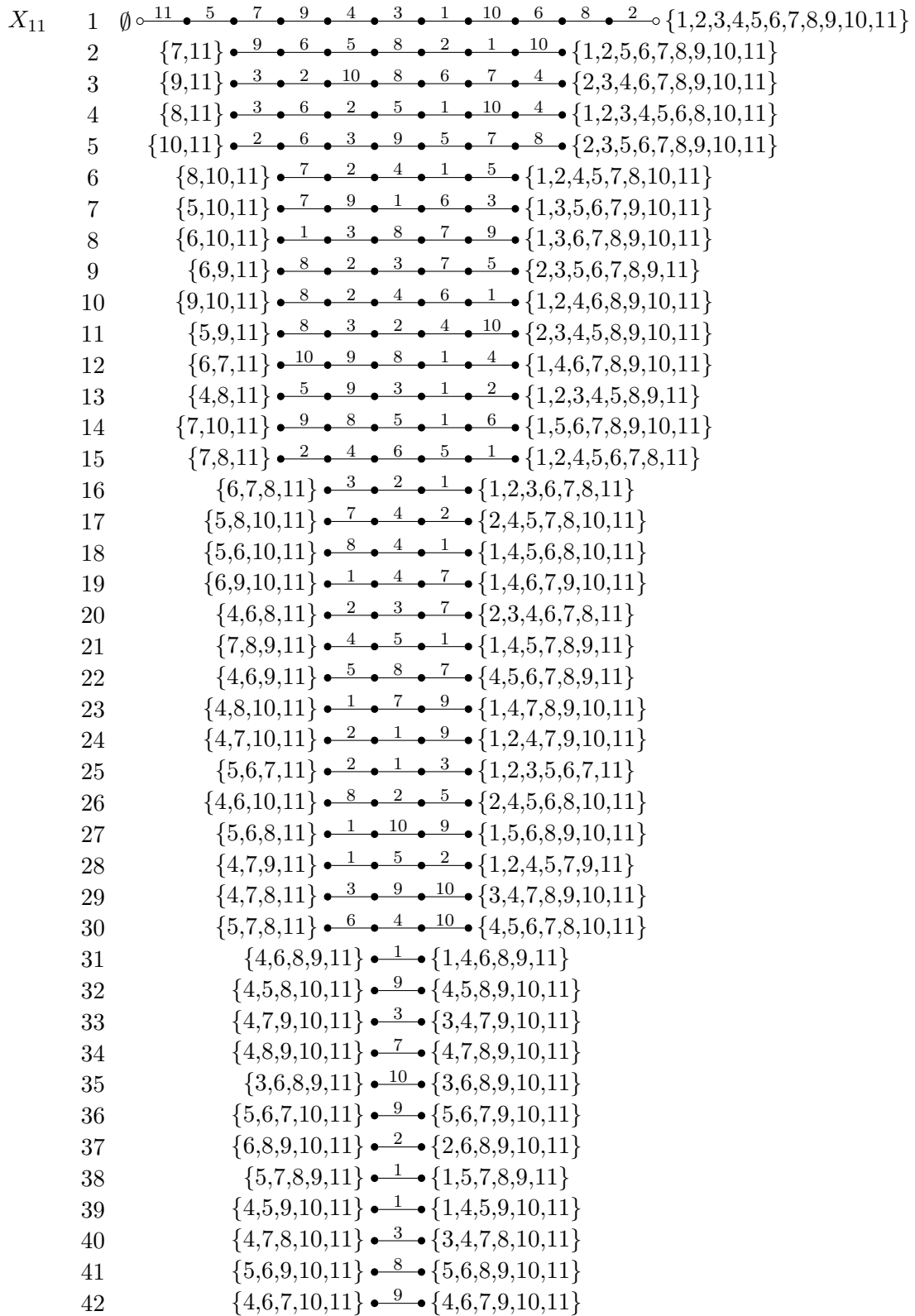
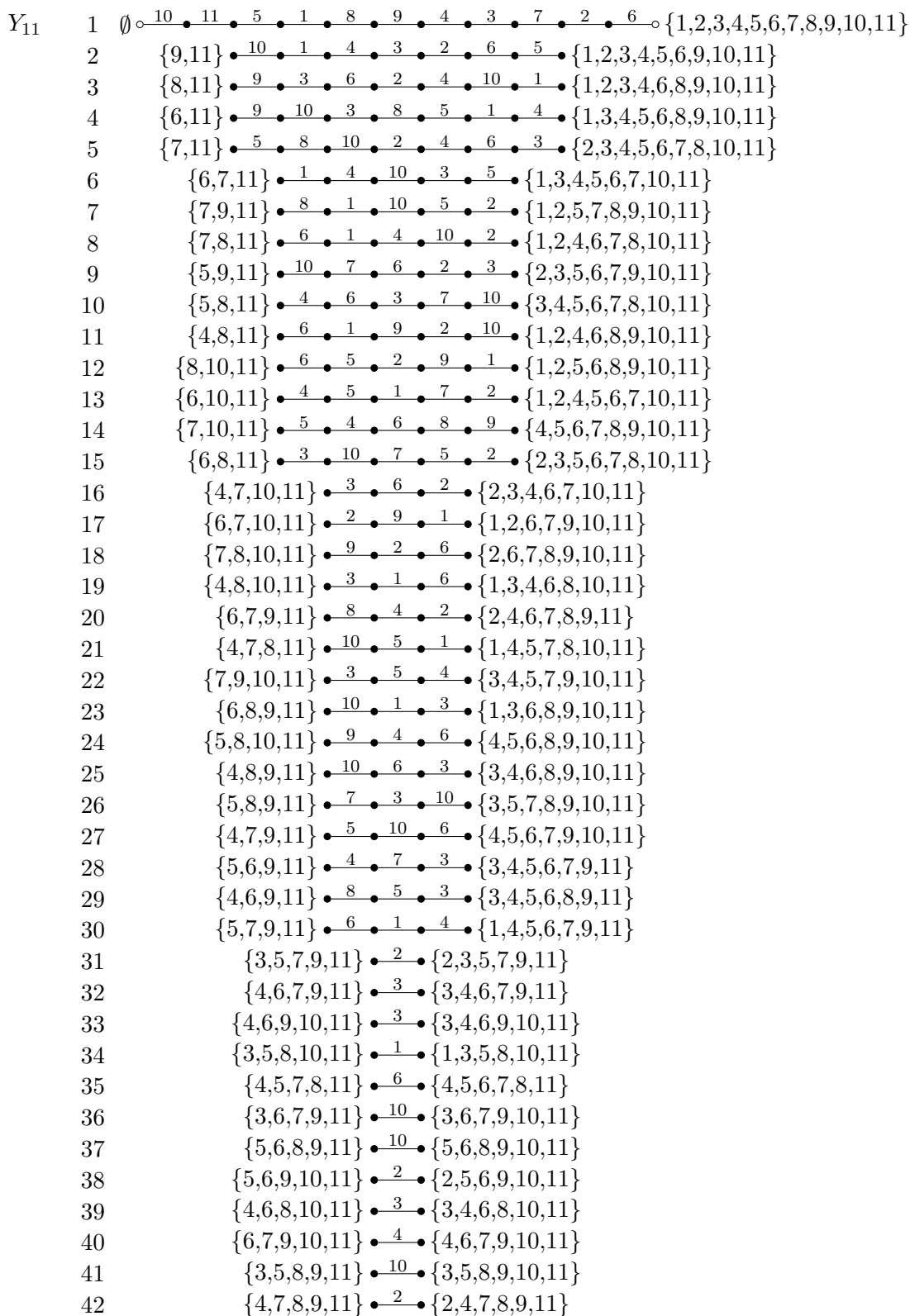

Figure 9: Three SCDs X_{10} , Y_{10} , and Z_{10} in the necklace poset N_{10} that together with the complements $\overline{X_{10}}$ and $\overline{Y_{10}}$ can be unrolled to five edge-disjoint SCDs in Q_{10} .



(figure continues on next page)



(figure continues on next page)

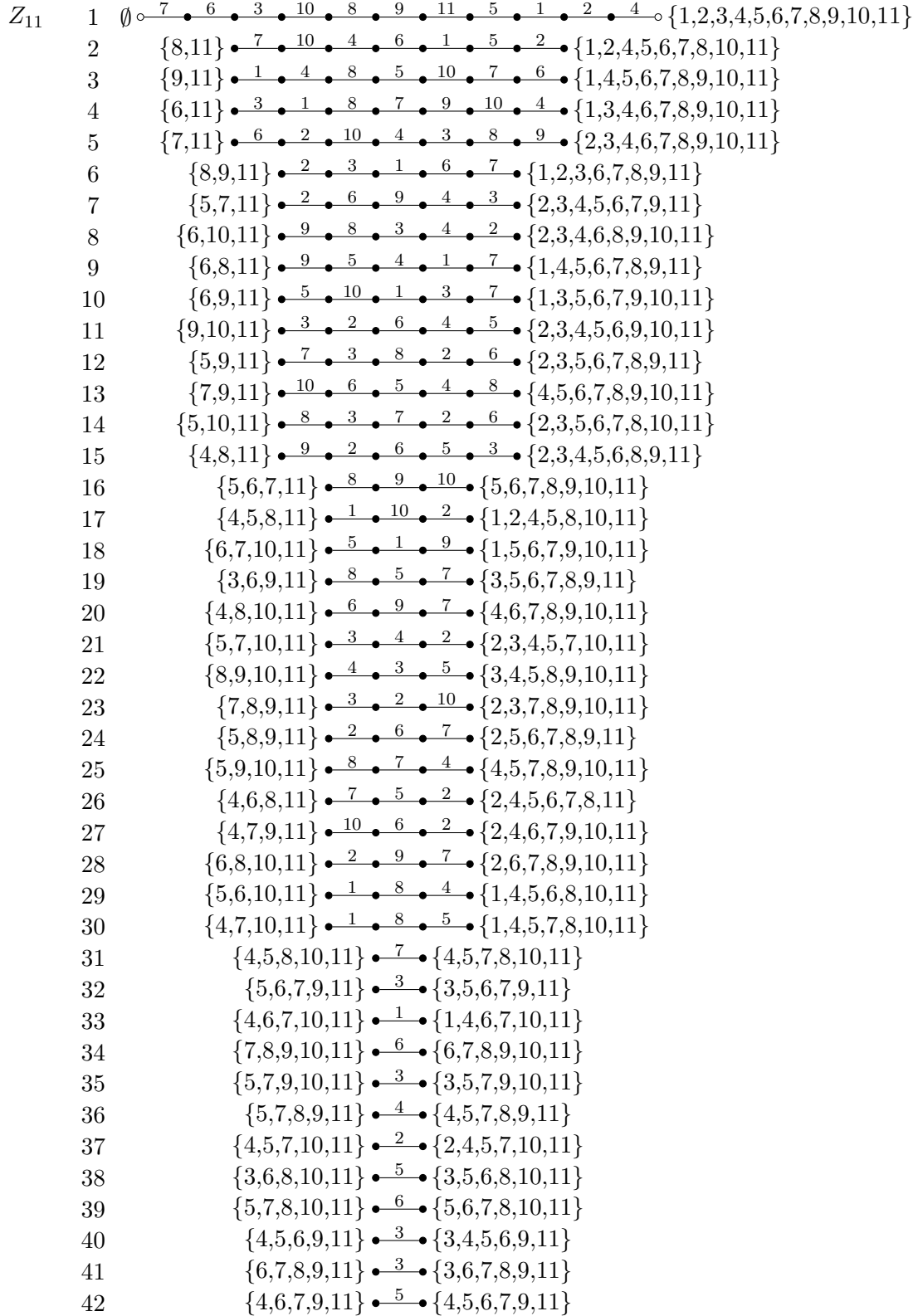

Figure 10: Three SCDs X_{11} , Y_{11} , and Z_{11} in the necklace poset N_{11} that together with their complements $\overline{X_{11}}$, $\overline{Y_{11}}$, and $\overline{Z_{11}}$ can be unrolled to six edge-disjoint SCDs in Q_{11} .

Acknowledgements

We thank Kaja Wille for several inspiring discussions about symmetric chain decompositions. Manfred Scheucher was supported by DFG Grant FE 340/12-1.

References

- [Aig73] M. Aigner. Lexicographic matching in Boolean algebras. *J. Combinatorial Theory Ser. B*, 14:187–194, 1973.
- [ALS13] G. Audemard, J.-M. Lagniez, and L. Simon. Improving Glucose for incremental SAT solving with assumptions: Application to MUS extraction. In *Proceedings of Theory and Applications of Satisfiability Testing - SAT 2013*, pages 309–317, 2013.
- [dBvETK51] N. G. de Bruijn, Ca. van Ebbenhorst Tengbergen, and D. Kruyswijk. On the set of divisors of a number. *Nieuw Arch. Wiskunde (2)*, 23:191–193, 1951.
- [Dha12] V. Dhand. Symmetric chain decomposition of necklace posets. *Electron. J. Combin.*, 19(1):Paper #26, 14 pp., 2012.
- [Dil50] R. P. Dilworth. A decomposition theorem for partially ordered sets. *Ann. of Math. (2)*, 51:161–166, 1950.
- [DMST12] D. Duffus, J. McKibben-Sanders, and K. Thayer. Some quotients of chain products are symmetric chain orders. *Electron. J. Combin.*, 19:Paper #P46, 11 pp., 2012.
- [DST18] S David, H Spink, and M Tiba. Symmetric chain decompositions of products of posets with long chains. *Electron. J. Combin.*, 25(1):Paper #P1.69, 12 pp., 2018.
- [DT15] D. Duffus and K. Thayer. Symmetric chain decompositions of quotients by wreath products. *Electron. J. Combin.*, 22(2):Paper #P2.35, 15 pp., 2015.
- [ES03] N. Eén and N. Sörensson. An extensible SAT-solver. In *Proceedings of Theory and Applications of Satisfiability Testing - SAT 2003*, pages 502–518, 2003.
- [Für85] Z. Füredi. Problem session. In *Kombinatorik Geordneter Mengen*, Oberwolfach, BRD, 1985.
- [GJM⁺18] P. Gregor, S. Jäger, T. Mütze, J. Sawada, and K. Wille. Gray codes and symmetric chains. In *45th International Colloquium on Automata, Languages, and Programming (ICALP 2018)*, volume 107 of *LIPICs*, pages 66:1–66:14, 2018.

- [GK76] C. Greene and D. J. Kleitman. Strong versions of Sperner's theorem. *J. Combinatorial Theory Ser. A*, 20(1):80–88, 1976.
- [GKS04] J. Griggs, C. E. Killian, and C. D. Savage. Venn diagrams and symmetric chain decompositions in the Boolean lattice. *Electron. J. Combin.*, 11(1):Paper #R2, 30 pp., 2004.
- [GLT19] V. Gruslys, I. Leader, and I. Tomon. Partitioning the Boolean lattice into copies of a poset. *J. Combin. Theory Ser. A*, 161:81–98, 2019.
- [Gri77] J. R. Griggs. Sufficient conditions for a symmetric chain order. *SIAM J. Appl. Math.*, 32(4):807–809, 1977.
- [Gri88] J. R. Griggs. Problems on chain partitions. In *Proceedings of the First Japan Conference on Graph Theory and Applications (Hakone, 1986)*, volume 72, pages 157–162, 1988.
- [HS13] P. Hersh and A. Schilling. Symmetric chain decomposition for cyclic quotients of Boolean algebras and relation to cyclic crystals. *Int. Math. Res. Not. IMRN*, (2):463–473, 2013.
- [Jor10] K. K. Jordan. The necklace poset is a symmetric chain order. *J. Combin. Theory Ser. A*, 117(6):625–641, 2010.
- [Kle65] D. J. Kleitman. On a lemma of Littlewood and Offord on the distribution of certain sums. *Math. Z.*, 90:251–259, 1965.
- [Kle70] D. J. Kleitman. On a lemma of Littlewood and Offord on the distributions of linear combinations of vectors. *Advances in Math.*, 5:155–157, 1970.
- [Lew72] M. Lewin. Choice mappings of certain classes of finite sets. *Math. Z.*, 124:23–36, 1972.
- [LO38] J. E. Littlewood and A. C. Offord. On the number of real roots of a random algebraic equation. *J. London Math. Soc.*, 13(4):288–295, 1938.
- [Pik99] O. Pikhurko. On edge decompositions of posets. *Order*, 16(3):231–244, 1999.
- [RSW06] F. Ruskey, C. D. Savage, and S. Wagon. The search for simple symmetric Venn diagrams. *Notices Amer. Math. Soc.*, 53(11):1304–1312, 2006.
- [SK79] J. Shearer and D. J. Kleitman. Probabilities of independent choices being ordered. *Stud. Appl. Math.*, 60(3):271–276, 1979.
- [Spe28] E. Sperner. Ein Satz über Untermengen einer endlichen Menge. *Math. Z.*, 27(1):544–548, 1928.

- [Spi17] H. Spink. Orthogonal symmetric chain decompositions of hypercubes. arXiv:1706.08545, 2017.
- [ST14] N. Streib and W. T. Trotter. Hamiltonian cycles and symmetric chains in Boolean lattices. *Graphs Combin.*, 30(6):1565–1586, 2014.
- [Tom15] I. Tomon. On a conjecture of Füredi. *European J. Combin.*, 49:1–12, 2015.
- [Wil18] Kaja A. Wille. Zerlegung des Hyperwürfels in symmetrische Ketten. Bachelor’s thesis, TU Berlin, 2018. In German.
- [WW77] D. E. White and S. G. Williamson. Recursive matching algorithms and linear orders on the subset lattice. *J. Combinatorial Theory Ser. A*, 23(2):117–127, 1977.
- [www] currently: <http://page.math.tu-berlin.de/~muetze>.