

A new clustering algorithm for prolonging the lifetime of wireless sensor networks

SeyedAkbar Mostafavi¹ | Mahbobe Ghafari² | Mehdi Agha Sarram³

¹ Faculty of Engineering, Department of Computer Engineering, Yazd University, Yazd, Iran, a.mostafavi@yazd.ac.ir

² Faculty of Engineering, Department of Computer Engineering, Yazd University, Yazd, Iran, mahbobe.ghafari@stu.yazd.ac.ir

³ Faculty of Engineering, Department of Computer Engineering, Yazd University, Yazd, Iran, mehdi.sarram@yazd.ac.ir

Summary

Energy efficient resource management is critical for prolonging the lifetime of wireless sensor networks (WSN). Clustering of sensor nodes with the aim of distributing the traffic loads in the network is a proven approach for balanced energy consumption in WSN. The main body of literature in this topic can be classified as hierarchical and distance-based clustering techniques in which multi-hop, multi-level forwarding and distance-based criteria, respectively, are utilized for categorization of sensor nodes. In this study, we propose the Approximate Rank-Order Wireless Sensor Networks (ARO-WSN) clustering algorithm as a combined hierarchical and distance-based clustering approach. ARO-WSN algorithm which has been extensively used in the field of image processing, runs in the order of $O(n)$ for a large data set, therefore it can be applied on WSN. The results shows that ARO-WSN outperforms the classical LEACH, LEACH-C and K-means clustering algorithms in the terms of energy consumption and network lifetime.

KEYWORDS:

Wireless sensor network, network lifetime, Approximate Rank-Order

1 INTRODUCTION

Wireless sensor networks have used for a wide range of applications such as environmental monitoring, military monitoring, health care and crisis management [1]. In these environments without supervision, the sensors can be easily replaced or recharged [2]; therefore, energy conservation in the networks is one of the most important research challenges. One method commonly used to prolong the network lifetime is through collecting data at the cluster heads [3]. In cluster-based approaches, sensors do not need to communicate directly with the base station. Instead, cluster heads are responsible to organize cluster members and send the data

collected within the cluster to the base station. This process leads to a significant reduction in the amount of data transmitted, resulting in lower energy consumption and longer network lifetime [3].

Hierarchical and distance-based clustering are methods employed to optimize energy consumption and increase the lifetime of wireless sensor networks. The combination of these two methods of clustering is the main motive for this study. Approximate Rank-Order is a hierarchical clustering based on the distance criterion used in image processing to clustering millions of images [4]. From here on, we use the ARO shortcut name to refer to the Approximate Rank-Order clustering. In this paper, a clustering algorithm in wireless sensor networks is provided using ARO clustering, in which the clustering step is performed before selecting the cluster head. The idea that the clustering stage should first be done is based on the work done in [5]. This allows energy consumption in the network to be reduced by eliminating overhead advertisements per round and thus increasing the lifetime of the network.

Over the past decade, research activities in the field of clustering wireless sensor networks have grown significantly. A large number of clustering algorithms are proposed in wireless sensor networks; Such as LEACH [6], LEACH-C [7], EEMDC [8], K-means [9], and SCRC-WSN [5]. LEACH is a self-organizing adaptive protocol that uses a distributed clustering algorithm [2]. LEACH-C is a leach-based central control algorithm that will help to form better clusters by dispersing cluster heads across the network [7]. EEMDC is an energy-efficient multi-level and distance-aware clustering mechanism for WSNs. In this mechanism, the area of the network is divided into three logical layers, which depends on the hop-count-based distance from the base station [8]. SCRC-WSN is a spectral classification for robust clustering in wireless sensor networks. This method is a spectral partitioning using the graph theory technics in order to separate the network to a fixed and an optimal number of clusters [5]. In this section, a brief overview of some of these algorithms is presented.

1. Background on Common WSN Clustering Protocols

In this section, we provide a brief review on the most popular WSN clustering protocols to get deeper understanding from their functions. This analysis helps us to analyze the pros and cons of state-of-the-art clustering protocols for WSN.

1.1 Overview of LEACH Protocol

Low Power Adaptive Hierarchy Clustering (LEACH) [6] is a self-organizing adaptive protocol that uses a distributed clustering algorithm [2]. The purpose of LEACH is to randomly select sensor nodes as cluster heads so that energy dissipation in relation to the base station spreads across all sensor nodes in the network. Each clustering cycle consists of the setup phase (cluster formation) and the steady phase (data transfer). During the setup phase, a sensor node selects a random number between 0 and 1. If this random number is less than the threshold $T(n)$, the sensor node is selected as the cluster head. $T(n)$ is calculated as follows [10]:

$$T(n) = \begin{cases} \frac{P}{1 - P * \left[r \bmod \left(\frac{1}{P} \right) \right]} & \text{if } n \in G \\ 0 & \text{otherwise} \end{cases} \quad (1)$$

In equation (1), P is the desired percentage to become a cluster head, r is the number of rounds for the election, and G is the set of nodes that have not been selected as a cluster head in the last round of $1/P$. The cluster heads nodes notify other nodes after they have been selected. When the sensor nodes receive an advertisement message, they determine the cluster to which they want to belong based on the signal strength of the received message. Then, the cluster heads allocate the time on which the sensor nodes can send data to the cluster heads based on a TDMA approach. During the steady-state phase, the sensor nodes can send data to cluster heads. The cluster heads collect data from the nodes in their cluster before sending these data to the base station. After a certain period of time spent on the steady-state phase, the network re-enters the setup phase and enters another round of selection of cluster heads [10].

1.2 Introduction of the LEACH-C algorithm

While using LEACH has the benefits of a random, adaptive, and self-organized clustering algorithm, this protocol does not guarantee the number and placement of cluster head nodes. Therefore, using a central control algorithm to form clusters will help to produce better clusters by dispersing cluster head nodes throughout the network. This idea has been used to create another protocol called LEACH-C, which unlike LEACH uses a centralized clustering algorithm and has a steady-state phase as it is LEACH [7]. The purpose of LEACH-C protocol is to combine energy efficient clustering and routing for application-specific data aggregation to increase network lifetime and reduce latency in data access [11]. In the LEACH-C setup phase, each node sends information about its current position (possibly determined by the GPS receiver) and current energy level for the base station. Base station In addition to forming good clusters (for example, the proper physical location and the number of nodes that are roughly the same), it must be ensured that the energy load is distributed uniformly across all nodes. To do this, the base station calculates the average energy level of the network nodes, nodes whose energy levels are below the average cannot be cluster heads for the current round. This algorithm attempts to minimize the amount of energy for nodes that are not cluster heads to transmit their data to the cluster head, by minimizing the total sum of squared distances between all non-cluster head nodes and closest to the cluster head. After determining the cluster heads of the current round, the base station broadcasts a message containing the cluster head ID to each node. If a node's cluster head ID matches its own ID, the node is a cluster head; otherwise, it is a normal node and determines its TDMA slot for data transmission and goes to sleep until it is time to transmit data [7]. This method increases the network overhead because all sensor nodes must send their location information to each base station at a time in every setup phase [12].

1.3 Introduction of K-means algorithm in WSN

Due to the widespread use of the K-means algorithm in various domains, such as data mining and image processing, in [9] is also used to cluster and extend the lifetime of wireless sensor networks. The K-means algorithm is based mainly on Euclidean distances and selection of cluster head depending on the residual energy of the nodes. So, here, the central node collects information about the node identifier, position, and residual energy for all nodes and stores this information in a list in the central node. After receiving this information from all the nodes, it begins to cluster using the K-means algorithm. The steps in the K-means clustering algorithm in wireless sensor networks are as follows [9]:

1. To form the cluster 'k' of the sensor nodes, the 'k' number of centroids is initially selected at random locations;
2. Euclidian distance is calculated from each node to all centroids and allocated to the centroid nearest. Thus the 'k' initial clusters are formed;
3. The positions of the centroids in each cluster are recalculated and the position change from the previous one is examined;
4. If there is a change in the position of each centroid, all steps are repeated from step 2, otherwise, the clusters will be finalized and the clustering process will end.

2 ENERGY MODEL

In this section, we will introduce the radio model used in this paper to compare clustering algorithms. This radio model is used in [6] for the LEACH algorithm. The energy dissipation model is shown in Fig. 1.

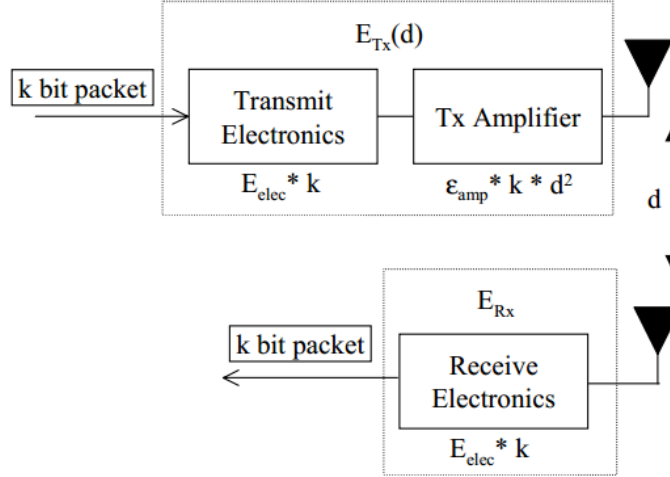

FIGURE 1 The radio model used to calculate energy consumption [6]

In Figure 1, $E_{Tx}(d)$ is the energy spent to transmit k bits over d , and E_{Rx} represents the energy spent to process k bit message. The parameter E_{elec} shows the energy consumed in each bit to run both transmitter and receiver circuits. This parameter depends on many factors such as digital coding, modulation, filtering, and signal propagation [5]. The energy consumed by the radio transmitter is defined by the following equation [7]:

$$E_{Tx}(k, d) = \begin{cases} k \cdot E_{elec} + k \cdot E_{fs} \cdot d^2 & \text{if } d < d_0 \\ k \cdot E_{elec} + k \cdot E_{mp} \cdot d^4 & \text{if } d \geq d_0 \end{cases} \quad (2)$$

Where E_{fs} and E_{mp} represent the amplifier energy respectively in the model of free space channel (energy loss d^2) and in the model of multipath fading channel (energy loss d^4) multipath. They are dependent on d , where d is the distance between the sender and the receiver. If the distance d is less than the threshold d_0 , then the free space model is used; otherwise, the multimode model is used [5]. The threshold value d_0 is presented by Heinzelman et al. in [7]. d_0 is defined as follows:

$$d_0 = \sqrt{\frac{E_{fs}}{E_{mp}}} \quad (3)$$

3 PROPOSED APPROACH

In this paper, we intend to use the ARO algorithm recently proposed by Charles Otto et al. [4] to clustering millions of facial images in order to clustering nodes in a wireless sensor network. In this section, we first introduce Rank-Order algorithm as a prerequisite for familiarity with the ARO algorithm, and after reviewing the ARO algorithm, we outline the proposed approach.

3.1 Introduction of Rank-Order Algorithm

The Rank-Order clustering algorithm was proposed by Zhu et al. [13], which is almost an agglomerative hierarchy clustering using the nearest neighbor based distance measure. The overall flow of the algorithm is that all samples are considered as separate clusters, then the distance between the pairs of clusters is computed and those that are below the threshold are merged. Then, a new set of cluster-to-cluster distances is repeatedly recomputed and perform merges based on the new distances. This requires the definition of a cluster-to-cluster distance metric. In this algorithm, the distance between two clusters is the minimum distance between any two samples in the clusters. The first measurement of the distance used in Rank-Order clustering is obtained by the following equation [4]:

$$d(a,b) = \sum_{i=1}^{O_a(b)} O_b(f_a(i)) \quad (4)$$

Where $f_a(i)$ is the i -th face in the neighbor list of a , and $O_b(f_a(i))$ is the rank of face $f_a(i)$ in the neighbor list of b , which the nearest neighbor lists are generated according to some underlying distance measure (e.g., the Euclidean distance). This asymmetric distance function is used to define a symmetric distance between two faces a and b . as [4]:

$$D(a,b) = \frac{d(a,b) + d(b,a)}{\min(O_a(b), O_b(a))} \quad (5)$$

A cluster-level normalized distance measure is effectively used to restrict mergers to local neighborhoods. Specifically, the minimum distance between the two points in a pair of clusters is calculated and divided by the mean distance [4]:

$$D^N(C_i, C_j) = \frac{1}{\varphi(C_i, C_j)} \times d(C_i, C_j) \quad (6)$$

Where

$$\varphi(C_i, C_j) = \frac{1}{|C_i| + |C_j|} \times \sum_{a \in C_i \cup C_j} \frac{1}{K} \sum_{k=1}^K d(a, f_a(k)) \quad (7)$$

Where $D^N(C_i, C_j)$, is the minimum distance between any two points in the cluster i and j divided by the mean distance of each point in C_i or C_j to their K nearest neighbors. The threshold 1 is always used for this function, and it is tested whether or not the minimum distance between any two points in the clusters is below the average distance of all points in both clusters to their K nearest neighbors [4].

The symmetric rank-order distance function returns low values if the two faces are close to each other and have neighbors in common. After the distances are calculated, clustering begins by assigning each face image as a distinct cluster, and then the symmetric distances between each cluster and the normalized cluster-level distances are calculated, and both clusters are merged with the distance below the specified threshold. Then, the nearest neighboring lists are merged for each newly formed cluster, and the distances between the remaining clusters are recalculated; until no further clusters can be merged. In this case, instead of determining the optimal number of clusters C , a distance threshold is used to measure the rank-order distance along with a neighborhood size for the cluster-level normalized distance; these are the parameters that set the specific number of clusters for a particular dataset being clustered, and their effective values are empirically determined [4].

In terms of runtime, calculation the full nearest neighbor lists for each sample affords $O(n^2)$ cost. Additionally, the actual clustering step used here is iterative, with cost per iteration proportional to the current number of clusters squared, so both the nearest neighbor computation and the clustering step itself are costly with increasing dataset size [4].

3.2 Introduction of the ARO algorithm

The Rank-Order clustering method has an obvious scalability problem that requires calculating the nearest neighbor lists for each sample in the data set, which, if calculated directly, has an $O(n^2)$ cost. Although there are various approximate methods for calculating the nearest neighbors, they are usually only able to calculate a short list of the top k nearest neighbors rather than a comprehensive ranking the dataset [4].

Using approximate methods for faster calculation of the nearest neighbor requires some modification of the original Rank-Order clustering algorithm. In particular, instead of taking into account all the neighbors in the summation equation (4), can sum up to at most the top k neighbors. In addition, instead of using the cluster-level normalized distance from the original algorithm, it is possible to approximate the distance between the pairs of samples for which both are within the other sample's top-200 nearest neighbors. In addition, it should be noted that if only one short list of the top- k neighbors is considered, the presence or absence of a particular instance in this list may be more important than the sample's numerical rank. Thus, a distance measure based on the

sum of the presence/absence of the shared nearest neighbors, instead of the ranks, results in the following distance function [4]:

$$d_m(a,b) = \sum_{i=1}^{\min(O_a(b),k)} I_b(O_b(f_a(i)),k) \quad (8)$$

Where $I_b(x,k)$ is an indicator function with the value of 0 if face x is in face b 's top k nearest neighbors, otherwise it is equal to 1. In practice, this modification leads to better clustering accuracy compared to the sum of ranks in a direct way, as in the original formula. Effectively, this distance function indicates that the presence or absence of shared neighbors towards the top of the nearest neighbor list (within the top-200 ranks) is important, while the numerical values of ranks themselves are not [4].

The normalization method used in the original algorithm is still effective and contributes to more accurate clustering results even with this modification to the original algorithm. The modified distance measure is defined as follows [4]:

$$D_m(a,b) = \frac{d_m(a,b) + d_m(b,a)}{\min(O_a(b), O_b(a))} \quad (9)$$

In addition, in order to improve the runtime of the clustering process, as mentioned earlier, 1) only the distances between samples which appear in each other's nearest neighbor lists are calculated, and 2) instead of multiple merge iterations as in the original algorithm, only one round of merges of individual faces into clusters are done. This means that only one clustering repetition is performed compared to the original algorithm that has runtime C^2 in each cluster iteration, and additionally only check for merges on a subset of all possible pairs (because only 200 nearest neighbors for each sample is considered). This results in the runtime of $O(n)$ from the final clustering step (assuming that the nearest neighbors have been pre-calculated) [4].

The final clustering method used by this algorithm is as follows [4]:

1. Extract dataset;
2. Calculate a set of top- k nearest neighbors for each face in the dataset;
3. Calculate pairwise distances between each face, and those faces in its top- k nearest neighbor list for which the face is also on the neighbor's nearest neighbor list, following equation (9);
4. Merge all pairs of faces with distances below a threshold.

Choosing the threshold to determine the number of clusters, C in a dataset, is one of the most difficult issues of data clustering. In practical applications, it cannot be assumed that the actual number of clusters is predetermined, so this algorithm is evaluated in several effective values of C and the best result is reported [4].

3.3 Proposed ARO-WSN approach

In this paper, we intend to use the ARO algorithm in order to clustering nodes in a wireless sensor network. In addition to using this algorithm in the clustering step, we will also take advantage of the idea employed in [5] where clustering is performed before selecting cluster heads. The proposed approach considers the residual energy of nodes in selecting the cluster. In the following, three steps of the proposed algorithm including clustering, cluster head selection and steady-state will be described.

4.3.1 Clustering step

At this point, network sensors will cluster based on the ARO clustering algorithm. The algorithm uses a distance measurement based on the sum of the presence/absence of shared nearest neighbors, instead of the ranks that are formulated in equation (8). The final clustering method we use is the same as the ARO clustering steps, with the difference that in the third step, instead of using the cluster-level normalized symmetric distance, we use the same asymmetric equation (8) to calculate the distance between the sensor nodes. Therefore, the clustering step of the proposed approach is as follows:

1. Collect the location of the sensor nodes by the base station. Each sensor node knows its location (equipped with a GPS) and transmits it to the base station;
2. Calculate a collection of k nearest neighbors for each sensor node in the network. It should be noted that the meanings of neighboring nodes are nodes that are closer to the node in terms of Euclidean distance;
3. Calculate pairwise distances between each node, and those nodes in its top- k nearest neighbor list for which the node is also on the neighbor's nearest neighbor list, following equation (8);
4. Merge all pairs of nodes with distances below a threshold.

The pseudo code of the clustering step of our proposed approach, which is referred to below as ARO-WSN, is depicted in Fig. 2. In our proposed approach, for the N set of sensor nodes (the value of N varies from 100 to 300 nodes in experiments), the k parameter is considered to be 20. This value has been selected experimentally after several experiments. The threshold value for Equation (8) is also set to 1.5.

ARO-WSN Algorithm (Clustering)
1. Input : $\{(x_1, y_1), \dots, (x_N, y_N)\}$
2. Initialization: number of neighbors: $K = 20$.
3. Each node sends its position to the BS.
4. For any node in network compute Euclidean distance to another nodes and set neighbor list.
5. For all nodes in network repeat bellow steps (6-18)
6. Set $O_a(b) =$ rank of node b in neighbor list of node a ;
7. Set bound = $\min(O_a(b), K)$, sum = 0;
8. For each nodes m in $\{1, \dots, \text{bound}\}$
9. Set $F_a =$ m -th neighbor of node a ;
10. Set $O_b(F_a) =$ rank of node F_a in neighbor list of node b ;
11. If $O_b(F_a) > K$
12. sum = sum +1;
13. End If
14. End For
15. Set distance $(a, b) =$ sum;
16. If distance $(a, b) < 1.5$
17. merge neighbor list a, b ;
18. End If

FIGURE 2 The pseudo code of the ARO-WSN clustering step

4.3.2 Cluster head selection step

After the cluster is set, the next step is to select the cluster head. As previously emphasized, the clustering step is performed only once before executing repetitions, and is the only cluster head to be replaced in each round. In the proposed approach, the selection of cluster heads is random and dependent on the residual energy of the nodes. The selection of cluster heads is such that in each round, it is first tested whether or not the current cluster head energy is greater than the average total energy of the network. If the energy of the cluster head is greater than the average energy of all nodes, it can also be in the next round and it does not give its role to the other node. But if its energy is less than the average energy of the nodes, then randomly one of the other nodes is candidate, and after checking its energy level, if it has the necessary energy, is selected as the cluster head. This node should send an advertisement message with a node identifier in order to be new cluster head in the r round. As a result, each cluster head will be able to collect data from cluster nodes and transfer the collected data to the base station. The pseudo code of the cluster head selection step in the ARO-WSN algorithm is shown in Fig. 3.

ARO-WSN Algorithm (Cluster Head Election)
1. Input : $\{(Eng1), \dots, (EngN)\}$
2. For each round r
3. Set MeanEng = average the total remaining energy in network;
4. For each cluster c in $\{1, 2, \dots, C\}$
5. If CH.energy < MeanEng
6. select random node in cluster c with energy bigger than MeanEng.
7. End If
8. End For
9. End For

FIGURE 3 The pseudo code of the ARO-WSN cluster head selection step

4.3.3 Data transmission

Once clusters and cluster heads are created, each normal node sends the data that sensed from surrounding to its cluster head. Once all data is received, each cluster head sends the collected data directly to the base station. The pseudo code of the data transmission step of the ARO-WSN algorithm is shown in Fig. 4.

ARO-WSN Algorithm (Steady State)
1. For each cluster c in $\{1, 2, \dots, C\}$
2. Collects measurement from appropriate Cluster nodes;
3. Cluster heads send data to the BS;
4. End For
5. Output : { Global area knowledge, the number of clusters C }

FIGURE 4 The pseudo code of the ARO-WSN data transmission step

4 SIMULATION RESULTS

All simulations are based on the following setup. We consider a dense wireless sensor networks with N nodes randomly distributed in a $100m \times 100m$ field. The base station is located outside of the sensing area at location with coordinates $(x_{sink} = 0.5 * x, y_{sink} = 0.75 * y + y)$. The number of nodes in all experiments is constant and equal to 300 nodes, except for testing the effect of node density. Since nodes have limited energy, they consume their energy during the simulation period. When the energy of a node is evacuated, it is considered as a dead node and cannot transmit or receive data [5]. For these simulations, each time a node sends or receives data, it loses energy. The parameters used in this simulation for the energy model of all three algorithms can be found in Table 1.

TABLE 1 The parameters of the radio model used in this simulation

Parameter	Value
$E_{elec} = E_{Tx} = E_{Rx}$	50 nJ/bit
E_{fs}	10 pJ/bit/m ²
E_{mp}	0.0013 pJ/bit/m ⁴
E_{DA}	5 nJ/bit/msg
d_o	88 m
Message size	4000 bits

In the following, our proposed approach will be compared with the following three algorithms:

- The K-means protocol is a distance-based algorithm. Since our proposed approach is also a distance-based algorithm, K-means is a good choice for the comparison.
- The LEACH protocol is one of the first hierarchical protocols. Since our proposed approach is also a hierarchical algorithm, LEACH is a good choice for the comparison.
- The LEACH-C protocol is a centralized version of the LEACH algorithm. Since the ARO-WSN algorithm is also a centralized approach, LEACH-C is a good choice for the comparison.

Our criterion for the network lifetime is the first moment when the battery of each sensor node in the network is completely discharged (FND) and the moment when the battery of all sensor nodes in the network is completely discharged (LND). Simulation results are the multi-run average of a random but constant topology for all algorithms.

4.1 Impact of node density

In this section, we evaluate the lifetime of the wireless sensor network in the algorithms mentioned for different values of N based on two FND and LND metrics. Fig. 5 and Fig. 6 show the effects of node density on network lifetimes, with FND and LND metrics in comparable clustering methods, respectively.

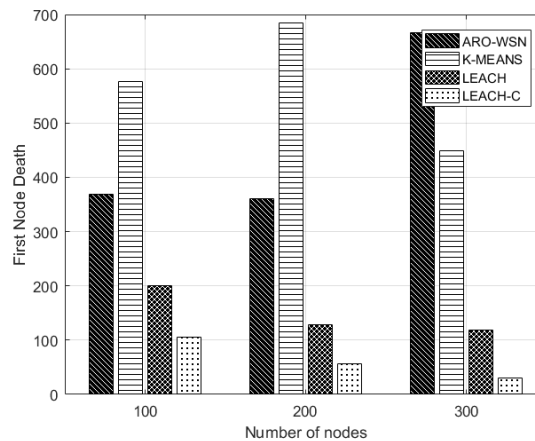

FIGURE 5 Impact of node density on performance of compared algorithms with FND criterion

As shown in Figure 5, for different values of N from 100 to 300, the ARO-WSN algorithm provides a performance improvement compared to the LEACH and LEACH-C algorithms. But the ARO-WSN algorithm in $N = 100, 200$, has failed to improve its performance compared to the K-means algorithm. In the value of $N = 300$, the ARO-WSN algorithm has a greater FND value than K-means. Unlike the ARO-WSN, the K-means algorithm seems to lose its performance at node higher densities. This is also true for LEACH and LEACH-C algorithms. We will further analyze the details of the chart.

In this diagram, the LEACH-C protocol has shown a worse performance than LEACH. This is due to the fact that, in homogeneous environments, the formation of the cluster and the selection of the cluster head in a distributed way is more correct; Because in homogeneous environments, all nodes have the same energy and if cluster formation is done centrally, cluster heads must transfer all the new clustering information to the base station in each round with the same capabilities as the normal nodes. It may be argued that the ARO-WSN algorithm is also a centralized algorithm, so using it in a homogeneous environment is wrong and inefficient. In response to this question, it should be noted that clustering in this algorithm is performed only once before choosing the cluster head. The location of all nodes and members of each cluster is sent only once to the base station, and this

information will not change. Only when the cluster head is updated, and if the current cluster head energy is lower than the average total energy of the network, the advertisement message will be broadcast. Generally, the ARO-WSN and K-mean algorithms are better than LEACH and LEACH-C. Compared to LEACH, this behavior in the performance of these algorithms is due to the fact that the ARO-WSN and K-means algorithms, in addition to having the advantages of hierarchical clustering, are also distance-based. Recall that the energy consumption model in all the compared approaches based on equation 2, depends on the distance between the nodes and the cluster head and the cluster heads to the base station. Therefore, distance-based approaches consume less energy than LEACH, because one of the disadvantages of LEACH is the possibility to select inappropriate cluster heads in terms of location. If the LEACH-C algorithm is compared in a heterogeneous environment with other algorithms, it will perform better; but in the homogeneous environment, it has poor performance for the reasons explained. The ARO-WSN algorithm performs better at higher densities than k-means and experiences the first node death in a longer time period than K-means. Unlike the ARO-WSN, K-means creates a new cluster in each round, which requires more energy. The disadvantages of this work are not shown at lower density, but in higher densities requiring more information to be transmitted, the advantage of forming clusters before the start of repetitions is clearly seen. In Table 2, details of the FND value of each algorithm are shown.

TABLE 2 The FND value of the compared approaches in the different densities of the node

Algorithm \ Number of nodes	ARO-WSN	K-means	LEACH	LEACH-C
100	368	576	201	106
200	361	685	128	56
300	667	449	119	31

In Table 3, we can see the improvement of the ARO-WSN algorithm toward to the compared approaches with FND criterion.

TABLE 3 The improvement percentage of the ARO-WSN algorithm toward to the three compared algorithms in different densities of the node with FND criterion

to \ Compared	K-means	LEACH	LEACH-C
100	-%36.1	%45.3	%71.1
200	-%47.2	%64.5	%84.4
300	%32.6	%82.1	%95.3

In Figure 6, we investigate the impacts of node density on network lifetime with LND criterion in compared clustering methods.

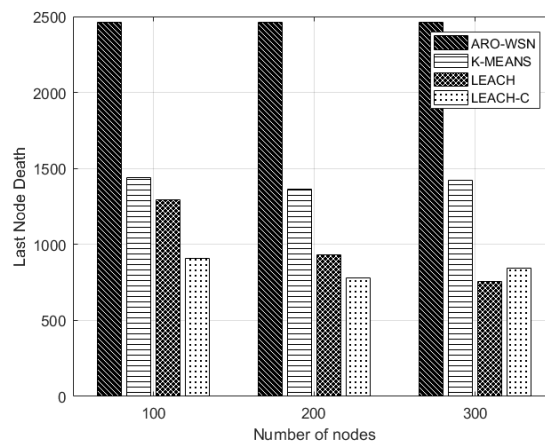

FIGURE 6 Impact of node density on performance of compared algorithms with LND criterion

Although in the FND criterion, the ARO-WSN algorithm failed in the low density to the K-means algorithm, with the LND criterion, it was able to achieve good improvement over all three other algorithms. In more number of rounds, the advantage of performing clustering before selecting the cluster head and fixing the clusters more visible. In Table 4 and Table 5, respectively, the details of the LND value of each algorithm and the improvement percentage of the ARO-WSN algorithm are shown compared to the other three algorithms with the LND criterion.

TABLE 4 The LND value of the compared approaches in the different densities of the node

Algorithm Number of nodes	ARO-WSN	K-means	LEACH	LEACH-C
100	2464	1437	1295	910
200	2463	1365	931	777
300	2461	1420	757	846

TABLE 5 The improvement percentage of the ARO-WSN algorithm toward to the three compared algorithms in different densities of the node with LND criterion

Compared to Number of nodes	K-means	LEACH	LEACH-C
100	/%41.6	/%47.4	/%63
200	/%44.5	/%62.2	/%68.4
300	/%42.2	/%69.2	/%65.6

As shown in Table 4, the ARO-WSN algorithm has almost constant LND value at different densities of the node, indicating that this approach has good stability and scalability at different densities of the node.

4.2 Energy and lifetime

In these experiments, we run compared algorithms under many networks with $N = 300$ nodes. The primary energy of all nodes is equal to 0.5J. The amount of data to send to the base station is unlimited. Figure 7 shows the number of active nodes in time for the ARO-WSN, K-means, LEACH and LEACH-C algorithms.

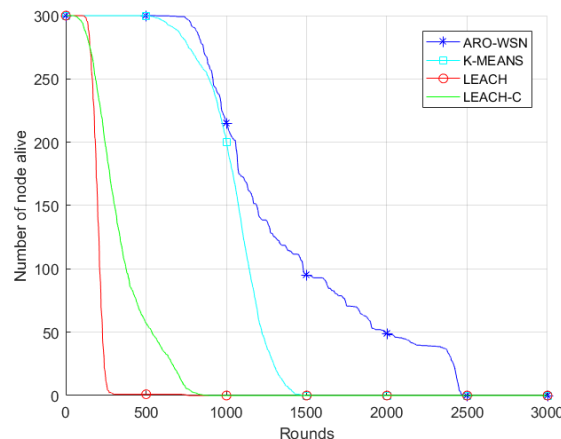

FIGURE 7 Number of alive nodes over time of the compared protocols

As can be seen clearly in Fig. 7, the ARO-WSN algorithm with both FND and LND criterion has significantly improved in relation to the LEACH and LEACH-C algorithms. In comparing two K-means and ARO-WSN algorithms with the FND criterion, cannot claim that ARO-WSN algorithm is superior; because by the average of more runs, these two charts may be overlapped each other in the first node death, as up to the 1000th round are close to each other; but with the LND criterion, the ARO-WSN algorithm has

a relatively large distance with the K-means curve. In Table 6 and Table 7, more details will be shown from the moment of death of the nodes.

TABLE 6 FND value of the compared approaches in the chart of alive nodes over time

ARO-WSN	K-means	LEACH	LEACH-C
563	510	108	51

TABLE 7 LND value of the compared approaches in the chart of alive nodes over time

ARO-WSN	K-means	LEACH	LEACH-C
2474	1492	764	886

TABLE 8 The number of alive nodes in different moments

Algorithm \ Round	ARO-WSN	K-means	LEACH	LEACH-C
300	300	300	1	152
500	300	300	1	57
1000	215	200	0	0
1500	95	0	0	0

TABLE 9 The improvement percentage of the ARO-WSN algorithm toward to the three compared algorithms in the chart of the number of alive nodes with FND criterion

K-means	LEACH	LEACH-C
%9.41	%80	%90

TABLE 10 The improvement percentage of the ARO-WSN algorithm toward to the three compared algorithms in the chart of the number of alive nodes with LND criterion

K-means	LEACH	LEACH-C
%39.3	%69.1	%64.1

In Figure 8, we observe the total residual energy of the network in each round of transmission using compared approaches.

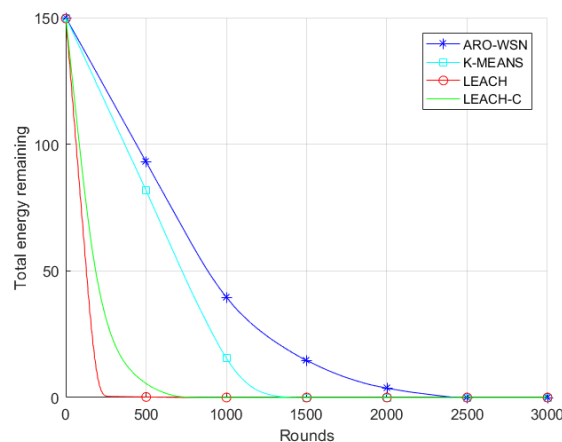

FIGURE 8 The evolution of the remaining energy in the network

Figure 8 shows the remaining energy curves over time for the entire network relative to the compared approaches. This chart clearly and simply depicts the increasing network lifetime. In this diagram, the LEACH algorithm is the first approach in which the total energy of the network ends, and then the LEACH-C algorithm has the second rank in the discharge of network energy. The K-means algorithm, although with a great distance from the LEACH-C algorithm approaches the completion of the entire network energy, about 1,000 rounds faster than the ARO-WSN algorithm experiences the death of the last node and the total energy

depletion of the network. Figure 8 illustrates the fact that the ARO-WSN algorithm has been successful in increasing network lifetime. For more detailed analysis, more details are shown in Table 11.

TABLE 11 Percentage of total energy consumption of the network at different times

Algorithm \ Round	ARO-WSN	K-means	LEACH	LEACH-C
100	%8	%10	%52.6	%39.3
500	%38	%46	%99.8	%96.6
1000	%74	%90	%100	%100
1500	%90.6	%100	%100	%100

According to Table 11, the ARO-WSN algorithm has consumed only 38% of the total network energy in round 500. While K-means, LEACH and LEACH-C algorithms have consumed 46%, 99.8% and 96.6% of total energy, respectively. At round 1500, the K-means, LEACH, and LEACH-C algorithms have consumed all of the network's energy, but the ARO-WSN algorithm has stored about 10% of the total energy, and can still continue to collect information from the environment around the network. Figure 9 shows the number of messages received by the base station for the compared approaches.

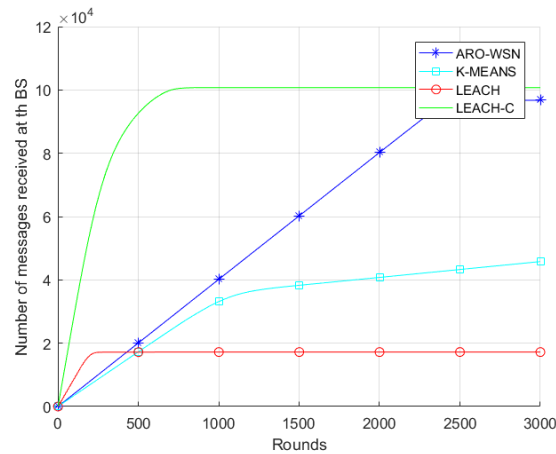

FIGURE 9 Number of messages received at the base station over time

In Figure 9, it has been shown that in each algorithm, the incremental trend of transmission of messages in the corresponding curve is fixed at a specific time moment. This means that at that moment, the last node in the network failed and the network lifetime has been over. In this diagram, the LEACH and LEACH-C algorithms initially transmitted more messages to the base station. These messages are a collection of advertisement messages and data collected by cluster heads. In the implementation of these algorithms, channel failure issues are not considered; therefore, all nodes can transfer data collected from the environment to the cluster head. It can be concluded that the difference in the number of messages transmitted to the base station is related to the advertisement messages broadcasted by the LEACH and LEACH-C algorithms. According to equation (2), the amount of energy consumed depends on the size of the messages; therefore, the greater the number of messages sent and received in the sensors, the greater the power consumption in the network. The faster transmission of the message in the LEACH and LEACH-C algorithms has led to faster energy consumption in both of these approaches, resulting network lifetime faster has finished. Here, the lower number of advertisement messages has caused superiority of the ARO-WSN algorithm, which indeed is the result of the lack of repeating the clustering in each round. The K-means curve is close to the ARO-WSN message transmission curve. This shows that the algorithm acts more cautiously in transmission of messages than two LEACH and LEACH-C algorithms; but as shown in Table 4, the moment of the death of the last node in this algorithm is far from the ARO-WSN algorithm; therefore, there is no more opportunity to transfer message packs to the base station. Further details are shown in Table 12.

TABLE 12 The number of messages received at the base station at different times

Algorithm \ Round	ARO-WSN	K-means	LEACH	LEACH-C
100	4001	3454	8793	28631
500	20059	17259	17180	92607
1000	40151	33116	17205	100720
1500	60206	38283	17205	100720
2000	80241	40783	17205	100720
2500	96740	43283	17205	100720
3000	96740	45783	17205	100720

Fig. 10 and Fig. 11 show the performance of the compared algorithms with different primary energies with FND criterion and LND criterion, respectively.

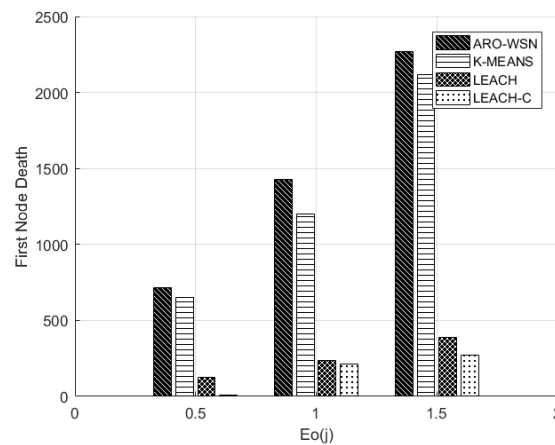
**FIGURE 10** Impact of the initial energy amount on the performance of compared algorithms with FDN criterion

According to Fig. 10, we see that the performance of all the compared algorithms is improved by increasing the initial energy. The ARO-WSN algorithm works better than other algorithms with increasing initial energy. Therefore, it can be concluded that distance partnership in the formation of a cluster can be much more effective than the initial energy level. With increasing primary energy, the difference in FND value between K-means and ARO-WSN distance-based algorithms increases with the two LEACH and LEACH-C algorithms. As noted earlier, there is not much difference between the two ARO-WSN and K-means algorithms with FND criterion. Further details are summarized in Table 13 and Table 14.

TABLE 13 The FND value of compared approaches with different primary energies

Algorithm \ Initial energy	ARO-WSN	K-means	LEACH	LEACH-C
0.5	717	651	126	11
1	1431	1203	235	213
1.5	2268	2119	387	274

TABLE 14 The improvement percentage of the ARO-WSN algorithm toward to the three compared algorithms in different primary energies with FND criterion

Compared to \ Initial energy	K-means	LEACH	LEACH-C
Initial energy			

0.5	%9	%82.4	%98.4
1	%15.9	%83.5	%85.1
1.5	%6.5	%82.9	%87.9

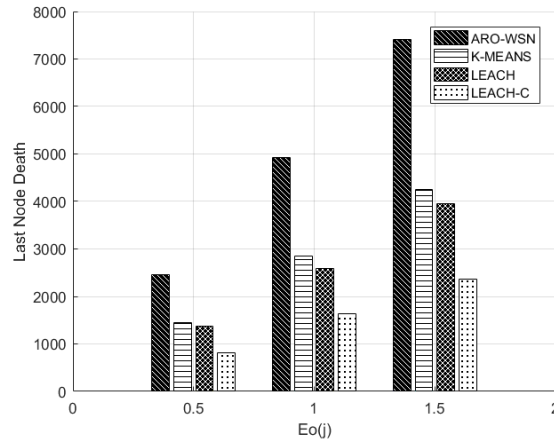

FIGURE 11 Impact of the initial energy amount on the performance of compared algorithms with LDN criterion

Figure 11 gives similar results to Figure 10, with the difference that here the difference the LND value between the two ARO-WSN and K-means algorithms is also significant. Further details are summarized in Table 15 and Table 16.

TABLE 15 The LND value of compared approaches with different primary energies

Algorithm \ Initial energy	ARO-WSN	K-means	LEACH	LEACH-C
0.5	2465	1449	1372	816
1	4928	2845	2590	1641
1.5	7409	4251	3950	2368

TABLE 16 The improvement percentage of the ARO-WSN algorithm toward to the three compared algorithms in different primary energies with LND criterion

Compared to \ Initial energy	K-means	LEACH	LEACH-C
0.5	%41.2	%44.3	%66.8
1	%42.2	%47.4	%66.7
1.5	%42.6	%46.6	%68

4.3 Impact of message size

In all experiments that have been done so far, the size of the messages sent from the nodes to the cluster head and from the cluster head to the base station is constant and equal to 4000 bits. According to Equation (2), the size of the messages is effective in the energy consumption model for sending and receiving messages; therefore, the larger the size of messages sent and received in the sensor nodes, the more energy is consumed and the network lifetime decreases. In this experiment, we want to show the effect of the size of received and sent messages from sensor nodes in the performance of the compared approaches.

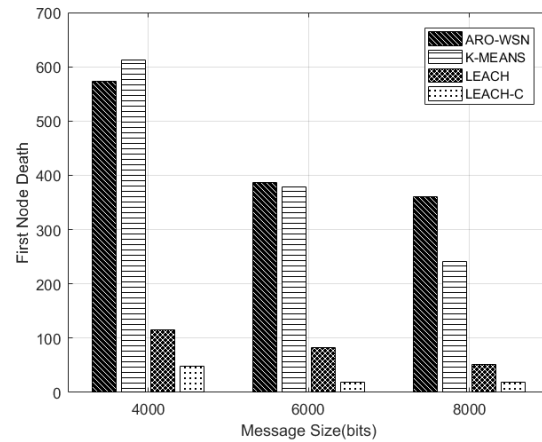

FIGURE 12 Impact of message size on the performance of compared algorithms with FDN criterion

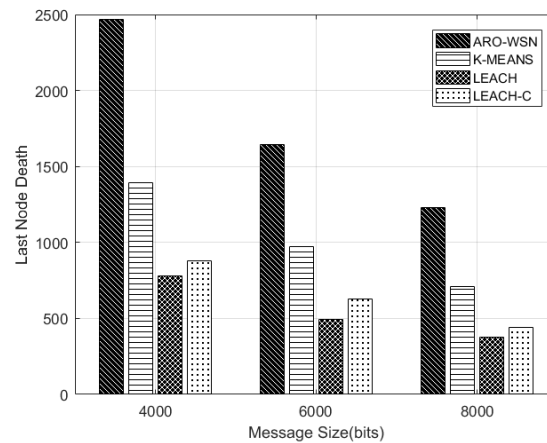

FIGURE 13 Impact of message size on the performance of compared algorithms with LND criterion

Regarding Fig. 12 and Fig. 13, with increasing message size, the first and last node death occurs in all approaches earlier, but the ARO-WSN algorithm still maintains its improvement over other algorithms. Figure 12 shows that in the message size of 4000 bits, the ARO-WSN algorithm has a lower FND value than K-means. This issue is also present in all the graphs that have been presented so far and the proposed algorithm has not been able to improve with the FND criterion toward to the K-means algorithm. As previously mentioned, the clustering step in the ARO-WSN algorithm is performed before selecting the cluster head. Also, cluster head update is only performed if the cluster head energy is less than the average total energy of the network; but in the other three approaches, clustering is performed in each round. The messages exchanged in each round to create new clustering and cluster head updates in these three approaches are greater than the messages sent to the base station in the ARO-WSN algorithm for updating cluster heads (see Fig. 9); therefore, according to equation (2), by increasing the size and number of messages sent and received, more energy is consumed and the lifetime of the network decreases. Further details are shown in Table 17, Table 18, Table 19 and Table 20.

TABLE 17 The FND value of compared approaches in different message sizes

Algorithm	ARO-WSN	K-means	LEACH	LEACH-C
Message size				
4000	537	613	116	49
6000	386	379	83	19
8000	360	242	52	18

TABLE 18 The improvement percentage of the ARO-WSN algorithm toward to the three compared algorithms in different message sizes with FND criterion

Compared to Message size	K-means	LEACH	LEACH-C
4000	-%6.9	%79.7	%91.4
6000	%1.8	%78.4	%95
8000	%32.7	%85.5	%95

TABLE 19 The LND value of compared approaches in different message sizes

Algorithm Message size	ARO-WSN	K-means	LEACH	LEACH-C
4000	2470	1391	781	878
6000	1643	971	495	629
8000	1229	708	374	440

TABLE 20 The improvement percentage of the ARO-WSN algorithm toward to the three compared algorithms in different message sizes with LND criterion

Compared to Message size	K-means	LEACH	LEACH-C
4000	%43.6	%68.3	%64.4
6000	%40.9	%69.8	%61.7
8000	%42.3	%69.5	%64.1

5 CONCLUSION

The purpose of this paper is to increase the lifetime of wireless sensor networks through clustering. Given the hierarchical and distance-based clustering features, the ARO algorithm, which is a hierarchical clustering based on distance and has been used in the image processing to clustering millions of images, was selected in order to clustering network sensors. In addition to using the ARO algorithm at the clustering step, the idea of performing the clustering step before choosing the cluster head was also used in the proposed ARO-WSN approach. This idea will reduce the network power consumption by eliminating overhead advertisements per round and thus increase network lifetime. The simulation results show that the death of the first and the last node in the ARO-WSN compared to the LEACH, LEACH-C, and K-means algorithms occur later. The ARO-WSN, with the criterion of the first node death, has improved by about 63% compared to LEACH, and about 83% compared to LEACH-C. In addition, with the criterion of the last node death, has improved compared to the K-means, LEACH and LEACH-C algorithms, 42%, 59% and 65%, respectively. In terms of energy consumption, when the K-means, LEACH and LEACH-C algorithms consume all the network energy, the proposed approach saves 10% of the total network energy and can still continue to collect information from the surrounding environment. Therefore, the proposed ARO-WSN approach has succeeded in reducing energy consumption through clustering and, consequently, increasing the lifespan of wireless sensor networks.

References

1. Md Azharuddin, Pratyay Kuila, Prasanta K. Jana. Energy efficient fault tolerant clustering and routing algorithms for wireless sensor networks. *Computers & Electrical Engineering*. 2015;41:177-190.
2. J. S. Leu, T. H. Chiang, M. C. Yu, K. W. Su. Energy Efficient Clustering Scheme for Prolonging the Lifetime of Wireless Sensor Network With Isolated Nodes. *IEEE Communications Letters*. 2015;19(2):259-262.
3. D. Izadi, J. Abawajy, S. Ghanavati. An Alternative Clustering Scheme in WSN. *IEEE Sensors Journal*. 2015;15(7):4148-4155.

4. C. Otto, D. Wang, A. K. Jain. Clustering Millions of Faces by Identity. *IEEE Transactions on Pattern Analysis and Machine Intelligence*. 2018;40(2):289-303.
5. B. Elbhiri, S. E. Fkhi, R. Saadane, N. Lasaad, A. Jorio, D. Aboutajdine. A new spectral classification for robust clustering in wireless sensor networks. In: :1-10;2013.
6. W. R. Heinzelman, A. Chandrakasan, H. Balakrishnan. Energy-efficient communication protocol for wireless microsensor networks. In: :10 pp. vol.2; 2000.
7. W. B. Heinzelman, A. P. Chandrakasan, H. Balakrishnan. An application-specific protocol architecture for wireless microsensor networks. *IEEE Transactions on Wireless Communications*. 2002;1(4):660-670.
8. Mehmood Amjad, Khan S., Shams Bilal, Lloret Jaime. Energy-efficient multi-level and distance-aware clustering mechanism for WSNs. *International Journal of Communication Systems*. ;28(5):972-989.
9. P.Sasikumar, S. Khara. K-Means Clustering in Wireless Sensor Networks. In: :140-144; 2012.
10. I. F. Akyildiz, Weilian Su, Y. Sankarasubramaniam, E. Cayirci. A survey on sensor networks. *IEEE Communications Magazine*. 2002;40(8):102-114.
11. Sudhanshu Tyagi, Neeraj Kumar. A systematic review on clustering and routing techniques based upon LEACH protocol for wireless sensor networks. *Journal of Network and Computer Applications*. 2013;36(2):623-645.
12. P. Nayak, A. Devulapalli. A Fuzzy Logic-Based Clustering Algorithm for WSN to Extend the Network Lifetime. *IEEE Sensors Journal*. 2016;16(1):137-144.
13. C. Zhu, F. Wen, J. Sun. A rank-order distance based clustering algorithm for face tagging. In: :481-488; 2011.

How to cite this article: Seyed Akbar Mostafavi, Mahbobe Ghafari, and Mehdi Agha Sarram (), A new clustering algorithm for prolonging the lifetime of wireless sensor networks, *International Journal of Communication Systems*,;: .