

# SPX: Preserving End-to-End Security for Edge Computing

Ketan Bhardwaj, Ming-Wei Shih, Ada Gavrilovska, Taesoo Kim, Chengyu Song<sup>†</sup>

Georgia Institute of Technology

<sup>†</sup> University of California, Riverside

## Abstract

Beyond point solutions, the vision of edge computing is to enable web services to deploy their edge functions in a multi-tenant infrastructure present at the edge of mobile networks. However, edge functions can be rendered useless because of one critical issue: Web services are delivered over end-to-end encrypted connections, so edge functions cannot operate on encrypted traffic without compromising security or degrading performance. Any solution to this problem must interoperate with existing protocols like TLS, as well as with new emerging security protocols for client and IoT devices. The edge functions must remain invisible to client-side endpoints but may require explicit control from their service-side web services. Finally, a solution must operate within overhead margins which do not obviate the benefits of the edge.

To address this problem, this paper presents SPX— a solution for edge-ready and end-to-end secure protocol extensions, which can efficiently maintain end-to-edge-to-end ( $E^3$ ) security semantics. Using our SPX prototype, we allow edge functions to operate on encrypted traffic, while ensuring that security semantics of secure protocols still hold. SPX uses Intel SGX to bind the communication channel with remote attestation and to provide a solution that not only defends against potential attacks but also results in low performance overheads, and neither mandates any changes on the end-user side nor breaks interoperability with existing protocols.

## 1 Introduction

Edge computing promises to support low latency web services by moving them fully or partially (i.e., as application-specific edge functions [17]) to edge computing infrastructure positioned comparatively closer to the data sources. Edge computing infrastructure deployed by mobile network operators [1, 10] has at least two orders of magnitude higher degree of distribution compared

to existing CDNs and cloud datacenters<sup>1</sup>. The high degree of distribution exponentially increases the attack surface, making edge computing more vulnerable, and therefore, less secure. To guarantee security properties like confidentiality and integrity for their users, most web services employ end-to-end encryption (70% over TLS [8]). More recently, due to the high TLS overhead for certain use cases like IoT [23] and messaging [11], newer secure protocols are being used. To carry out any useful processing, edge functions require access to end users' encrypted traffic in decrypted form, at the more vulnerable edge infrastructure.

Summarizing, edge computing raises a pressing need for a solution to securely operate on encrypted traffic, in a manner that provides the *performance* benefits of the edge in terms of low latency, is *secure* considering existing security semantics and threat models, and is *interoperable* with the new use cases and security protocols relevant at the edge.

The existing approaches to making something like this possible are designed for different operating scenarios and assumed usage models, making them inadequate for edge computing. For instance, edge computing applications are posed as the first point of contact for low-end devices (e.g., in IoT deployments) with Internet-based web services. They may employ different security protocols (other than TLS) among them. To be practically deployable, it is critical for edge computing applications and the solutions they adopt to be transparent to those devices, and not to require device-side changes or active participation. Existing techniques fail to address these requirements, or introduce prohibitive performance or security vulnerabilities, as summarized below.

One approach is to use advanced encryption schemes such as homomorphic [24] or searchable [47] encryption, which allow edge functions to carry out some operations on encrypted data. However, the state-of-the-art

<sup>1</sup>100,000s of cellular base stations vs. 1000s of CDNs or 10s of geo-distributed cloud [4, 20, 22].

implementations of these techniques have very high performance overheads that overshadow any latency benefit gained from using edge computing, ruling out their use.

Another approach is to leverage recent solutions designed for network middleboxes that split secure sessions [30, 36] to inspect encrypted traffic. These solutions have several shortcomings. The most severe is their susceptibility to Iago attacks [18] by a curious edge provider employee or to zero-days vulnerabilities such as Heartbleed [14] at the edge infrastructure. Using a shielded execution environment (SEE), such as Intel SGX [9, 35]), as proposed in mbTLS [25] and SafeBricks [41], seems sufficient to address this. However, while these can be applied in principle, using them requires changes in end user devices. mbTLS [25] claims interoperability with legacy devices, however, it only considers TLS, leaving out a large number of devices that may not use TLS but still need to be served by edge computing [23]. SafeBricks [41] proposes to use SEE and IPsec to ensure protection of encrypted traffic for network functions (NFs) running in the cloud. It assumes that IPsec capability is introduced in all end user devices, something that depends on how soon IPsec is integrated in those devices. Further, a tunnel is needed between each client, edge and web service, if we are to make session level end-to-end security guarantees; this can be too heavy for edge computing use cases, making it practically difficult to deploy. In summary, although these approaches are technically apt to address the issues, they may simply be too difficult to apply in edge computing settings due to their different design goals.

Furthermore, any system or protocol that relies on an SEE-based remote attestation [26, 51] to measure the trustworthiness of edge functions and, thereafter, to grant them access to encrypted traffic, can be compromised using two type of well known attacks: the time-of-check-to-time-of-use (TOCTTOU) and the cuckoo attack [39] (details in §4). The root cause of the problem is that the communication with the SEE can be compromised using these attacks. To maintain the same level of security requires a binding between the SEE and the communication channel. However, achieving that securely and transparently is non-trivial, especially for arbitrary security protocols.

**SPX.** To achieve that binding and address the abovementioned challenges, we present **Secure Protocol Extensions (SPX)** – a framework for deriving from end-to-end secure protocols their edge-ready and secure extensions. With SPX, edge functions can operate on encrypted traffic over any existing security protocol, in collaboration with the web services that deploy them, and without violating the end-to-end security semantics of the end users’ secure channel with the web service. SPX uses hardware-provided shielded execution environments (SEE) such as Intel SGX and *augments* the communication among

end users and web services via edge functions with an additional communication between the edge and the web service *at an appropriate step* of the protocol. With SPX, the web services can enable edge functions to access contents of the encrypted traffic while preserving what we refer to as End-to-Edge-to-End ( $E^3$ ) security semantics (§5), equivalent to the same level of security as the original client device–web service connection. SPX achieves this without requiring any changes on the end users’ side. We prototyped SPX for popular existing protocols: TLS (§8), and protocols developed using the Noise protocol framework [40] (§9) to demonstrate its feasibility. The experimental results show that the SPX-based versions of these protocols add only modest 12-15% latency overhead. Considering that from end user devices the next infrastructure tier (e.g., CDNs) has several factors longer latencies than the edge [43], SPX retains the edge performance benefits, despite these overheads.

In summary, this paper makes the following research contributions.

- The notion of  $E^3$  security properties, central to enabling edge computing, made practical through the secure protocol extensions (SPX) approach.
- The SPX design framework for extending secure protocols for the edge. SPX can be applied to any protocol. Its design considers the limitations of SEEs such as Intel SGX, namely limited memory, instantiations or processing capabilities, and makes recommendations for supporting vectored instructions in next generation shielded execution environments to make them more attractive for use in edge computing.
- Concrete SPX implementation for TLS and any protocol developed using the Noise protocol framework, and evaluation of their performance impact on latency, the core reason driving edge computing.

## 2 Motivation

We start with an example scenario to clarify the motivation for the development of SPX.

**Motivating example scenario.** Consider a company like ADT security. It decides to deploy its edge function that analyzes data from sensors deployed at customers’ homes to ensure timely detection of unusual activity, such as house break-ins or fire breakouts, in a cost effective manner. The benefit expected by ADT is improved level of service, due to more timely incident detection, and reduced operating costs, resulting from reduced backhaul bandwidth usage relative to having to deliver all traffic from the sensors to ADT’s backend server. Today, the various sensors in a single home connect to an ADT hub device, deployed at the home, which in turn interacts with their cloud based web service using TLS or other end-

to-end secure protocols. We posit that to lower the costs of such services with the increasing number of sensors and other IoT devices in the homes (e.g, smart switches, appliances, etc.), and to make them more manageable (e.g., in light of the recent incidents [12, 13] caused due to vulnerabilities in devices such as routers, set top boxes, etc.), these hubs will be replaced with edge functions running on a third-party multi-tenant edge infrastructure, such as what will be offered by mobile network operators [3, 7]. In that case, the individual sensors in homes will have to use TLS, or another end-to-end secure protocol, to connect to the web service, and these connections may be transparently routed to a nearby edge location, for ADT to achieve the expected benefits. In this example, a connection must be established between the sensors and ADT’s backend server, while the edge function is able to look at and operate on the encrypted traffic to analyze it.

However, when a sensor connects to an ADT edge function, it is desired that the connection terminates with the same security as if it were terminating at an ADT web service. This is different from today’s scenario where content delivery networks (acting in reverse) are used to aggregate the traffic from hubs or devices. Today, their secure connections are terminated at CDNs where root certificates are installed and security guarantees rely on the physical security of the CDN nodes via business agreements and the TLS protocol, as shown in Figure 1. In edge computing, this may not be acceptable due to the huge attack surface. Further, not all sensors may be capable of supporting TLS due to the additional RTTs, the size of the certificates, and battery constraints [2].

From the example, we derive the following requirements for a practical solution for the edge:

- *Support unmodified end user devices:* It is critical to not require changes in end user devices or the protocols they use. At the same time, edge functions must be enabled to securely operate on encrypted traffic while maintaining security guarantees;
- *Consider vulnerable infrastructure:* With a huge attack surface, the trustworthiness of the privileged software at the edge is questionable especially in multi-tenant settings, as highlighted by the NSA-linked Cisco middlebox zero day vulnerability [6] incident.
- *Pose minimum performance overhead:* A high performance overhead for mechanisms to ensure confidentiality and integrity of encrypted user traffic can absolve the latency benefits expected from the edge functions

However, these requirements do not appear to be addressed in leading industry security specifications.

**Gaps in Industry Specifications.** Leading industry bodies [3, 5, 7] responsible for defining a secure edge computing ecosystem have suggested directly putting the private key material of the certificate into an SEE such as SGX to provide the required security. However, this will

not suffice. First, a certificate “kind of” binds the DNS name to a private key, and browsers/apps on end user devices would only verify the DNS name if it matches the name in the certificate, but the edge function may not have the same DNS name. Second and more importantly, although we trust SEE to provide isolation, it does not guarantee the software running inside SEE is bug free. This is also the main motivation for adding ASLR support in Intel SGX. In case of vulnerability such as Heartbleed, the private key could be leaked very easily. Moreover, schemes based on time invalidation of certificates have known vulnerabilities. Therefore, putting private key material in the SEE is risky. Recent work on SEE-based middleboxes aim to address a similar problem, but by focusing on datacenter-centric assumptions and design constrains, these efforts remain open to certain types of vulnerabilities [41], are limited to certain types of devices and protocols [25], or their impact on the latency overheads is not discussed (see §11).

### 3 Assumptions

We make the following assumptions about operating scenarios. First, we assume that backend services are willing to deploy edge functions on open multi-tenant edge infrastructure. Edge functions handle end-user requests over secure protocols to provide benefits in terms of reduced latency and bandwidth usage. Second, we assume that when a client tries to access a web service, the connection is transparently directed to an edge function of the web service. The redirection can be DNS-based or S1-based, in enterprise and the mobile edge, respectively, or some application level redirection. The mechanism used for redirection is orthogonal to the design of SPX and we assume that all relevant packets in a flow are redirected to an SPX-enabled edge function. Third, we assume that security guarantees provided by existing protocols in end-to-end communication, such as TLS or Noise-based protocols, still hold.

Finally, we assume availability of an OS shielded execution environment (SEE) whose trust can be established via remote attestation. However, we do not make any assumptions around the performance of the available SEE. Designing an SEE-based solutions has inherent performance overhead due to memory encryption, limited or no I/O access in trusted mode, limited addressable memory, and limited number of concurrent SEE executions. In addition, compared to a canonical threading model (e.g., pthreads), multithreading within an enclave is not trivial [9, 35]. Some of these limitations are addressed in the newer architectures, but the fact remains that a shielded execution in an enclave is and will remain a scarce resource on processors. This is important because it obviates some of the trivial solutions. For example, allowing every edge

function to keep a secure channel with the corresponding web service open at all times, and subsequently, to use that channel to get session keys for all clients, say based on a unique nonce of the session, has two short comings: First, it could lead to highly inefficient use and wastage of SEE resources, and second, it still does not suffice for end-to-end security semantics.

## 4 Threat Model

Different from a traditional network threat model, where an adversary usually is in the middle as an observer and launches attacks only over the traffic on a secure channel, we consider a stronger threat model where an adversary has full control over the edge infrastructure, including the operating system, except for the shielded execution environment (SEE). The adversary can freely monitor, intercept, and forward the data over the communication channel between the OS and SEE. For example, if an edge function running in an SEE tries to open a channel to the OS in order to talk to remote clients, the adversary who controls the OS also has the full control over that channel. The rationale behind considering such a threat model is derived from the following observations:

- Edge computing is a multi-stakeholder and multi-tenant environment with different ownership domains, i.e., mobile network operators' edge infrastructure, web services's edge functions, and end users' data.
- The adversary can be a curious edge infrastructure provider (insider) or a malicious edge function exploiting a zero-day vulnerability to gain root access. With that, it can potentially compromise all edge functions and potentially open a back door to the cloud-based web service.
- Finally, the edge infrastructure is typically deployed in physically insecure locations (cellular towers, aggregation points, edge servers, etc.) creating a huge attack surface of edge computing, and protecting it from advanced persistent threats like zero-days, malicious insiders, etc., mandates stronger threat models.

The above observations around edge computing imply that it warrants stricter security and lead us to consider the stronger threat model. We argue that the existing solutions that consider a weaker threat model are not applicable in edge computing scenarios due to their target use cases or operating assumptions. The attacks discussed above could lead to a situation where a malicious edge function has privileged access and can mount Iago attacks [18], and warrant an SEE-based solution.

Furthermore, most of the existing solutions fail to adequately address the lack of binding between communication channel and the SEE when using remote attestation. If a communication channel is not carefully bound, two general types of attacks are possible:

**TOCTTOU attack:** A communication channel is vulnerable to a TOCTTOU attack if the attestation is performed *before* establishing the communication channel. Consider the following scenario: A web service initializes a remote attestation request to measure the target edge function. Next, the malicious edge function with root privileges routes this request to the intended benign edge function. The benign edge function responds with an expected measurement and the web service initializes another encrypted communication channel to an edge function. The malicious edge function routes the new communication to itself instead.

**Cuckoo attack:** A communication channel is vulnerable to a cuckoo attack if the attestation is performed *after* establishing the communication channel. When a web service initializes an encrypted channel to an edge function, the malicious edge function routes the communication to itself. The web service initializes a remote attestation request over the established channel. A malicious edge function then forwards the attestation request to the correct edge function which responds with a correct measurement to the malicious edge function. The malicious edge function then forwards the correct measurement to the web service.

These attacks are possible for two reasons. First, the malicious edge function has full control of its internal network, so it can arbitrarily route network packets to whichever edge function it wants. Second, because there exists a lack of a trusted channel to deliver the certificate, the end-to-end protocol cannot distinguish among malicious and benign edge functions, potentially leaking sensitive key material. However, if we just use a short lived Diffie-Hellman (DH) key bound to the SEE attestation, even if the edge function is compromised, the consequence is much less severe. However, the SEE performance overhead in doing that has to be within acceptable limits to make it suitable for edge computing.

Under the threat model, we assume that the adversary cannot mount any attack directly on the SEE. We assume the SEE is under a strong protection against all external software accesses. We do not consider denial of service attacks of edge functions that can be mounted by the privileged software at edge infrastructure. This is reasonable because devices can simply fallback to interacting with the web service directly in case edge functions are under a denial of service attack. We also do not consider side channel attacks on SEE.

## 5 SPX Overview

The primary goal of any end-to-end protocol like TLS or the Noise-based protocols is to provide privacy and data integrity between two communicating applications. These applications are assumed to be running on two ends, i.e.,

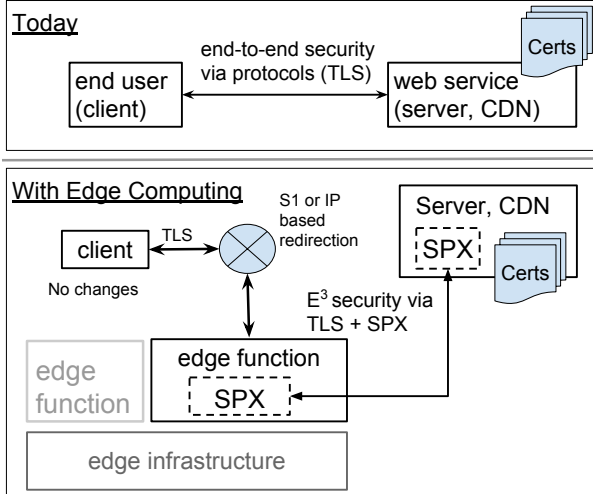

**Figure 1:** Comparing interaction between end users (client) and web services (server) that operate on assumption of end-to-end security using protocols like TLS vs. the interaction between end users client, edge functions and web services which violates assumptions in the protocols rendering security provided by them undefined. With SPX we define it as  $E^3$  security.

client and server. However, in case of edge computing, it is desired that the edge, which is in the middle of the client and server, is afforded access to their communication so as to complete performance-enhancing functions.

SPX enables creation of a secure communication channel between the end user (client) and the edge function transparently, with the same end-to-end security semantics as when the client directly opens a secure channel with the web service (server), as shown in Figure 1. This is needed to enable edge functions to perform useful application-specific processing, beyond just network-level functions. If edge functions cannot access the encrypted data in the messages from a client to a server, edge computing is only of limited use.

In principle, it can be argued that terminating connection at an edge function is still end-to-end secure by simply splitting TLS. However, it should be noted that in that interaction, one end has moved from the web service to the edge function. This termination of the secure session at a potentially insecure edge function is not the same. Thereby, we argue that it does not have same security semantics as terminating it at secure server. We propose SPX with  $E^3$  security semantics as a key enabler in edge computing without compromising the security or usefulness of edge functions.

Concretely, we consider SPX to be satisfying  $E^3$  semantics for a given protocol if and only if SPX preserves the end-to-end security semantics for encrypted network traffic transmitted using that protocol, i.e., it preserves confidentiality, data integrity and authentication between client and server, from every other entity in the system (in-

cluding any privileged software on the edge infrastructure such as OS or hypervisor), except for the edge function.

This is achieved in two steps. First, SPX utilizes SEE to perform the encryption so a malicious edge function (even with root access) can only see the encrypted network traffic. Second, SPX utilizes an attestation-bound handshake protocol to transfer the session key of the supported protocol from the server to the edge at an appropriate point in the protocol. As a result, when establishing the secure channel, the client still authenticates using the server’s credentials (not deployed at edge functions). In other words, the edge function is transparent, e.g., during a handshake, the client will see and authenticate the edge function using the server’s certificate instead of the edge provider’s certificate. Moreover, the authentication key of the SPX-enabled secure protocols (e.g., the private key of the server’s certificate) never leaves the server so the risk of identity theft is lowered and is the same as in today’s cloud-based web services. Finally, by binding the key exchange between the edge function and the server with an SEE-based attestation, SPX is resistant to the two kinds of attacks discussed earlier in §4. Achieving this however requires different design considerations than typical security protocols, discussed next.

## 6 SPX Design Considerations

The design considerations for SPX critical for achieving  $E^3$  security semantics and retaining edge-based performance can be described as follows:

**Ensuring security semantics.** To preserve security semantics, the following key elements must be considered:

*Channel binding:* The key to prevent the TOCTTOU and cuckoo attacks (and other attacks as well) at the edge is to bind an attestation with the corresponding communication channel. In SPX, this is done by including the ephemeral public key in the attestation so the server can verify at the same time (1) that the edge function is indeed running inside an SEE, (2) the integrity of the edge function, and (3) that the ephemeral key pair is indeed generated inside the SEE so no other entity has access to it.

*Channel relaying:* After successful binding, the next important step is when the server shares the session state and session key with edge function, before communicating the completion of the secure connection establishment to the client. This allows an SPX-enabled edge function to relay the same communication channel used for its own handshake to the clients. This is important (i) to ensure that the attested connection is relayed to the client, hence, establishing its security properties, and (ii) requiring additional connections is undesirable from the perspective of the edge function and server resource usage.

**Preserving performance.** As noted earlier, latency performance is a key benefit of edge computing, and any security solution for the edge must preserve this benefit. Below are more performance oriented design elements that must be considered.

*Piggybacking.* SPX messages are piggybacked with existing protocol messages as much as possible. SPX piggybacked markers trigger SPX operations at the edge functions or server. By doing this, SPX minimizes the need for extra interactions between the edge and the server, which reduces the possibility of man-in-the-middle (MITM) attacks. This also maintains at minimum the overhead on the edge and server side, and keeps the client side engaged to avoid timeouts in existing protocols.

*Protocol replication.* Wherever possible, SPX running in the edge function replicates the protocol’s abstract state at the edge, instead of having the edge function maintain all state variables and compute all crypto functions, which can be resource intensive. Replicating state allows SPX-enabled edge functions to keep track of the protocol state and carry out operations like requesting the session key at the right time during a handshake via remote attestation, so as to ensure that even without actually carrying out crypto functions, the channel binding remains secure. This allows SPX to keep the computational overhead associated with carrying out those functions at the edge in check.

*Addressing limitations of SEE hardware.* It is important to consider the limitation of the SEE hardware. For instance, (i) the 6th generation Intel processors have only 128 MB of memory addressable to all the running enclaves, (ii) the number of enclave instantiations running simultaneously is limited, and (iii) running an SGX thread consumes one of the logical CPUs and makes it unavailable to other threads. Although these are soft limitations that are further relaxed in current and future processor generation, a practical SPX solution should not be bound by them. To address this, (i) SPX uses a spilling mechanism, i.e., the session look up table spills over to host memory if the enclave does not have enough memory. However, to ensure  $E^3$  guarantees, SPX uses the SEE *sealing* feature to store session information. To guarantee the confidentiality and integrity of the sealed information, sealing encrypts the information using the hardware generated sealing key. By doing this, with a small performance penalty, SPX-enabled edge functions are only limited by the amount of *host* memory as opposed to memory addressable by the SEE. To mitigate the impact of (ii) SPX enabled edge functions require only one enclave instantiation per edge function as opposed to one enclave instantiation per session. However, SPX cannot share enclaves with two different edge functions without compromising  $E^3$  guarantees, because in that case two edge functions can generate the same ephemeral key and the

same attestation reports. To mitigate the impact of (iii), we need to make sure that the time required in binding is kept to a minimum so that the edge function waiting for attestation response, including session keys, finishes as quickly as possible. This is accomplished by monitoring the state of the handshake.

To ensure that these considerations are always met, we defined a set of key operations common to arbitrary secure protocols, discussed next.

## 7 Designing a Generic SPX

The following key operations are needed to design an SPX for an arbitrary secure protocol.

*Detect (D):* An SPX-enabled edge function must be able to detect the client’s session initiation message which is usually transferred in plain text.

*Relay (R):* Once the edge function detects an initialization of an SPX-enabled protocol, it relays the initialization message to the server and behaves like a transparent proxy until the session is established. It is important that the edge function monitors the entire handshake process so as to extract relevant protocol state (e.g., encryption suite) that is necessary to talk to the client.

*Bind (B):* Piggybacking with the relayed traffic, the edge function sends an additional message that binds the attestation with an ephemeral public key to the server. The ephemeral key pair is generated inside the enclave and will be deleted after the handshake completes. This is the step where the two aforementioned attacks are prevented.

*Forward (F):* To maintain transparency, the edge function must not communicate any SPX-related information in the protocol messages exchanged with clients. The extra steps in the protocol must be handled at the edge so that clients receive the same information as if they were setting up a direct connection with the web service. This function is important to address interoperability and deployment concerns with SPX.

*Grant (G):* When the server finishes the session establishment and the authentication of the edge function is successful (by verifying the attestation report), the server transfers the session key, which is encrypted by the ephemeral public key contained in the attestation, to the edge function through the key exchange channel. On receiving the session key message, an edge function decrypts the key using the corresponding ephemeral private key, registers the session, and begins serving the client’s request thereafter.

*Resume (S):* SPX may optionally also keep state for the session if a protocol supports resume or zero-RTT session setup, e.g., TLS1.3 or Noise protocols with pre-shared keys in IoT devices.

Next, we describe how we applied the above framework to develop SPX for TLS and Noise-based protocols.

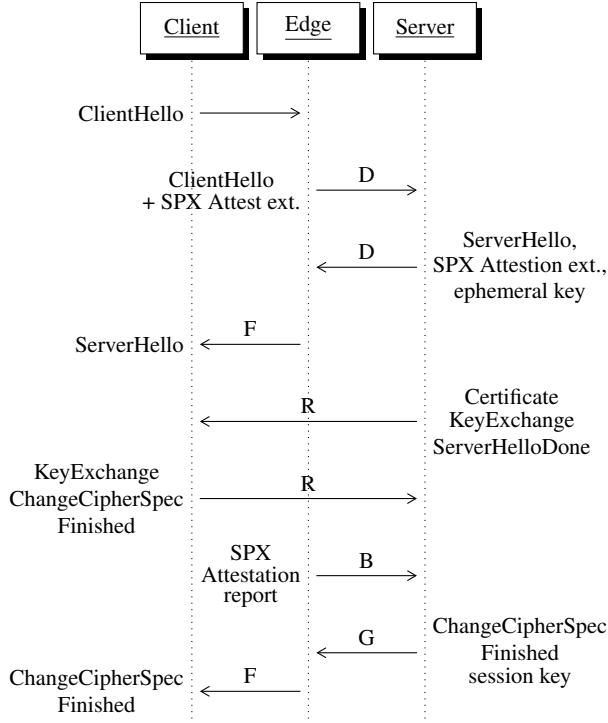

**Figure 2:** Showing the SPX enabled TLS: TLX handshake protocol.

## 8 Design of TLX = TLS + SPX

TLS/SSL [50] has two types of subprotocols: the handshake protocol and the record protocol. The handshake protocol is for negotiating security parameters for the record protocol, authenticating two peers, reporting errors, etc. It is also the key step to prevent MITM attacks. In particular, by using public key encryption, TLS guarantees that only the two communication peers have access to the randomly generated session key that is used in the record protocol. In TLX, we utilize SPX to securely transfer this secret key from the server to the edge function without trusting the edge provider. Figure 2 shows the TLX protocol with SPX operations marked with same letters as defined in §7 and is described below:

A TLX enabled edge function detects a `ClientHello` and SPX adds a request as a TLS extension in the `ClientHello` message which is then forwarded to the server. Having received the request, the server responds by including a response in its `ServerHello` message, again, as a TLS extension. The response can be `OK` or `Not Capable`. An `OK` message is followed by a challenge (nonce), to guarantee the freshness of the attestation and to prevent replay attacks, and a signed ephemeral public key (similar to the `ServerKeyExchange` message), to establish the key exchange channel. Having received the response from the server, SPX strips the server re-

sponse from the `ServerHello` message and relays the rest of the messages to the client. SPX validates the certificate, checks whether it is from the trusted server (similar to public key pinning [21]), and verifies the ephemeral key is signed by the public key which corresponds to the certificate to prevent MITM attacks [31]. While waiting for the client to respond, SPX generates a fresh pair of ephemeral keys and generates an attestation that includes both the public key and the challenge (nonce). Then it sends the attestation and the public key to the server together with the client response. Having received the attestation, the server verifies its freshness, correctness, as well as the legitimacy of the public key. Once every check clears, the server then sends the session key to the edge function encrypted with the exchanged ephemeral key, as well as `ChangeCipherSpec` and `Finished` messages. Note that for transparency, all SPX-related messages will not be included when calculating the hash of handshake messages. SPX strips and decrypts the session key and forwards the rest of the messages to the client. From now on, the edge function can securely communicate with the client using the TLS record protocol with agreed cipher spec.

The handshake is aborted if either the normal TLS handshake fails or an attestation-related error occurs.

## 9 Design of NoiXe = Noise + SPX

**Noise Background:** Noise [40] is a framework for crypto protocols based on the Diffie-Hellman key agreement. A Noise handshake is described by a simple language consisting of tokens arranged into message patterns. Message patterns are arranged into handshake patterns. A handshake pattern specifies the sequential exchange of messages between an initiator (client) and responder (server), and the corresponding crypto state transitions that comprise a handshake. A handshake pattern can be instantiated by crypto functions (DH functions, cipher functions, and a hash function) to give a concrete Noise protocol. A Noise protocol starts with prologue data and some patterns require pre-messages to be exchanged between the parties. Messages include `e`: ephemeral key, `s`: static key, and `dhee`, `dhse`, `dhes`, `dhss`: the sender performs a DH between the corresponding local state, remote state and computes the required hashes. Readers are directed to the Noise specification for further details about the protocol framework [40].

Applications can choose to specify and use their own defined protocol between their end users and the web service. NoiXe allows edge functions to support any secure protocol that can be built using the Noise protocol framework. A Noise protocol starts with prologue exchanged between a server and client. For example, suppose a server communicates a list of Noise protocols that it supports to clients. Applications on the client side will then

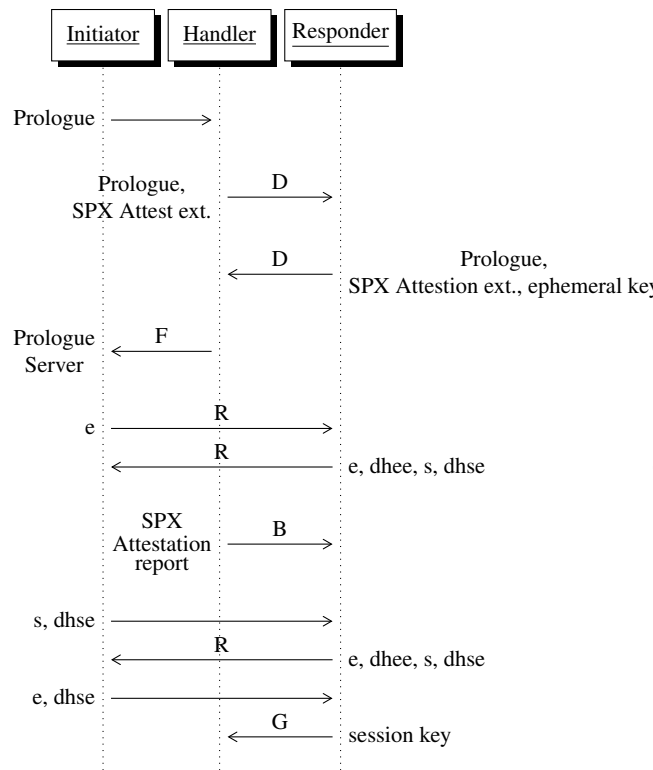

**Figure 3:** Showing the Noise\_XX pattern handshake with SPX enabled Noise framework.

choose among them and execute that protocol to communicate with the server. SPX uses the prologue to perform the detect operation on the edge and server side. When a client tries to connect to a server using a Noise protocol, it is directed to a NoiXe-enabled edge function. The NoiXe edge function leverages the handshake pattern information of the protocol being used to choose the appropriate messages to carry out its other functions. First, it creates a secure channel with the server using the same protocol as requested by the client. Then, the edge function and the server carry out the bind operation, i.e., use the channel to send and receive an attestation report created in a secure enclave using the ephemeral key shared and verified using certificates. On successful mutual attestation, a NoiXe enabled edge function relays the same channel to the client, while acting as a Noise proxy for it to carry out its handshake with the server. This ensures that security expectations of the clients are honored and the channel that was bound is the one that is getting used for the client-server communication.

On the edge function side, after a detect operation, the edge function capable of the equivalent NoiXe protocol initializes a handshake state object for that protocol and keeps it up to date with the state on the server, while acting as a forwarding proxy for communication between the web service and the client. Since Noise uses symmetrical

encryption, there is no need to replicate the execution of the protocol on the edge function side. Instead, it selects the appropriate messages from the protocol’s handshake message pattern (part of the Noise handshake state) to obtain the required information from the server, e.g., current hash state. Finally, the session keys are granted by the server to the edge function before the last message is exchanged between the server and client as part of another attestation report to prevent eavesdropping or impersonation. In the cases where the last message in the handshake pattern is from the client side, the server grants the session keys after it finishes the crypto function. The handshake is only carried out whenever an attestation request can be satisfied (indicated by attestation extension). The handshake is aborted if a requested attestation is not received or is invalid, or the Noise session information does not match the signature in the attestation.

Figure 3 shows the handshake patterns for Noise\_XX between an initiator (client) and responder (server), along with the SPX operations marked with same letters as defined in §7. Noise\_XX is used to start a compound protocol called Noise pipe [11]. Noise pipes do not assume any previous communication between a client and server. The Noise\_XX handshake pattern supports mutual authentication and transmission of static public keys that are stored and used as pre-messages in the next Noise\_IK pattern to create the session. Important to note is that binding happens only after the DH function is performed. Identifying this step requires knowledge about the protocol. NoiXe achieves this by the replicated state and performing the attestation after first DH operation is performed, thus preserving the protocol handshake pattern as well as avoiding MITM attacks. Other protocols are supported in similar manner.

## 10 Implementation

We implemented SPX prototypes for Ubuntu 14.04 using the Intel SGX Linux SDK. We highlight interesting implementation details for TLS and Noise protocols below.

**TLX.** We prototyped TLX by modifying the TLS implementation on top of the mbedTLS libraries. We leveraged the extension feature introduced in TLS 1.2 to integrate attestation request and verification into the handshake. We then ported the modified library into an enclave to support SPX functionality.

**NoiXe.** We modified the Noise protocol framework to support a new role of ‘handler’ to create an intelligent Noise edge function that allows replication of the crypto state of the Noise protocols. To run a Noise protocols in an SGX enclave, we ported the full Noise protocol framework to run inside an enclave, including all its crypto functions. Using it, we implemented a proxy that runs as the edge function and a server that uses the SPX en-



abled Noise framework - NoiXe. We had to disable use of vectorization in blake2 and ChaChaPoly because SSE2 optimizations are not supported in an SGX enclave with 6th generation Intel processors.

**Remote Attestation for Enclave.** Remote attestation in Intel SGX is designed to use trusted servers, i.e., Intel servers or other parties that are granted the processor secret keys under suitable agreements, to verify the attestation measurements. However, in our implementation, we bypassed the use of those servers to simplify our implementation. This does not lead to any loss of generality of our prototype or evaluations because we posit that parties deploying edge functions would act as those trusted entities as per Intel.

## 11 Evaluation

An SPX enabled protocol preserves  $E^3$  semantics while allowing edge function full access to the web traffic, with affordable impact on perceived latencies. The evaluations demonstrate that the design and implementation of SPX achieve this goal.

### 11.1 Security Analysis

**$E^3$  security semantics  $\cong$  end-to-end security.** Using SPX, an edge function gains access to the encrypted traffic but only within a secure SEE enclave. With hardware provided protection, it remains secure from any other software component in the system and any communication from outside the SEE is secured by the protocol, same as in the default two-party case. In that sense, we claim that  $E^3$  security semantics is equivalent to the conventional end-to-end security afforded by encryption using a secure protocol.

**Preserved security properties of protocols.** SPX ensures that the security properties of the original protocol for which it is developed remain preserved. For instance, for TLX, it ensures that the connection between client-edge-server remains same as a client-server connection. First, the identities of all parties can be authenticated, thanks to the bind step between the edge and server, while the client-server are authenticated using the TLS record protocol. Second, the channel attested is the channel that gets used by the edge function to interact with the client, thanks to the relay step. Finally, the grant before the handshake finishes, from within the SEE, ensures that the shared (negotiated) secret remains secure from any other software entity, including privileged software at the edge, ensuring the reliability of the handshake. Similar discussion is valid for any of the Noise-based protocols and their corresponding properties. By preserving security properties, a SPX enabled edge remains secure from attacks that those protocols protect against, including Iago

attacks based on introspection of memory used by applications using these protocols. However, these protocols are not designed to protect against Iago attacks that may use impersonation as they assume end points to be secure.

**Protection from impersonation by privileged attackers.** SPX prevents Iago attacks such as the cuckoo and TOCTTOU attacks by using ephemeral keys during the bind phase and ensuring that the grant is done before the handshake negotiation finishes. By doing this it ensures that no two sessions have the same ephemeral key and a malicious attacker cannot wait for the end of the protocol and try to get access to the shared private key. Further, the sharing remains within the SEE and is never exposed outside of it. These, combined, prevent any privileged attacker from impersonating as a web service to an edge function, or vice versa, to gain access to the session key.

**Comparison with relevant alternatives.** In comparison to recent proposals with similar goals, the SPX approach differs in the following ways. *SafeBricks* proposes to use Intel SGX and controlled development of NFs to protect them against Iago attacks [18] when deployed in the cloud. It relies on IPsec isolation for protection of the traffic. Use of IPsec can be unreasonable in the target use cases for edge computing. For use cases such as IoT data aggregation, and caches for arbitrary clients, end devices may not support IPsec. Further, it remains susceptible to the TOCTTOU and cuckoo attacks as it exchanges secrets after the connection between the client and NF with SEE is established. *mbTLS* proposes to modify TLS in a similar way as proposed by SPX, but is limited to TLS itself. Although, sufficient for use in edge computing with TLS, it cannot be applied if some other protocol is used. In comparison, SPX achieves  $E^3$  security semantics for existing protocols while remaining completely transparent to end user devices making it well suited for edge computing. However, SPX does have impact on performance of those protocols, which we present next.

### 11.2 Performance

SPX ensures that edge functions remain transparent for clients, which is critical in edge computing for practical deployability. In this section, we evaluate the performance overhead incurred to carry out the additional steps proposed by SPX.

**Experimental Setup.** Table 1 lists the experimental setup used in the experiments. We used machines with 6th generation Intel processors with SGX support for the edge functions and web services. We implemented a TCP client, proxy (edge function), and server, which communicate using TLS (mbedTLS library) and Noise protocols using a standard framework as our baselines. Then, we added SPX capability to the edge and server side, i.e.,

Setup	Configuration
Client	Intel(R) Xeon(R) CPU E5-1620 v2 @ 3.70GHz, 16GB DIMM DDR3 Synchronous RAM, Intel Ethernet Connection (2) I219-V
Edge	Intel(R) Core(TM) i7-6700 CPU @ 3.40GHz, 16GB DIMM DDR3 Synchronous RAM, 128 MB configured for SGX, Intel Ethernet Connection (2) I219-V
Server	Intel(R) Core(TM) i7-6700 CPU @ 3.40GHz, 16GB DIMM DDR3 Synchronous RAM, 128 MB configured for SGX, Intel Ethernet Connection (2) I219-V
Network	LAN over 512 Mbps connection. RTT (ms) Client-Proxy: 0.964, Proxy-Server: 0.901, Client-Server: 0.962

**Table 1:** Experimental setup.

implemented the portion that handles the encryption state (proxy and server both) to run in an SGX enclave, and used TLX (modified mbedTLS library) and NoiXe (modified Noise framework libraries). We used 128 bit AES encryption in RSA for TLS with a certificate size 3KB, and ChaChaPoly cipher, 256 SHA2, and 56 bit curve488 key for the Noise based protocols. In both cases, we used a 512 byte attestation report generated by the processor inside an SGX enclave. We used an echo protocol over a TCP socket connection to carry out our experiments. We intentionally used very fast network between the components to be able to accurately highlight the overhead associated with SPX especially free of the network delays which may amortize the effect of some of the overhead. In that sense, the experimental setup demonstrates clearly the performance impact on latency due to SPX given that impact of the RTTs remains constant.

**Workload & Measurements.** We use application kernels that are representative of common processing steps in edge functions as our workload. Further, our measurements are focussed on latency, i.e., the time as seen from unmodified clients which is different than earlier work which primarily focussed on throughput due to their target use cases [25]. We also report the CPU overhead of SPX on the edge computing infrastructure, which is important to highlight given that resources at edge infrastructure may be limited compared to well provisioned cloud or semi-fixed function middleboxes.

**File transfer.** File transfer is representative of multiple use cases such as content caching or IoT sensor data aggregation. Each point in the Figure 4(a) and Figure 5 can be used to characterize a different class of edge functions. For instance, on the lower end 1K file size transfer can be mapped to IoT sensor values where as 1.6 MB file transfer can be thought of as video streaming.

Figure 4(a) and Figure 5 compare the time taken to transfer files of different sizes. We compare SPX with

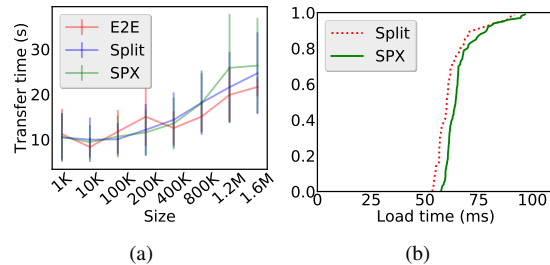

**Figure 4:** (a) Showing time measured on client side in file transfer using TLX (SPX enabled TLS) over TCP. (b) Showing CDF of loading time for locally replayed web page load times for Alexa’s top 100 web pages over TLX.

two baselines corresponding to a direct client-server case without any edge processing (E2E), and a second one corresponding to Split TLS [30]. The other solutions mentioned in §11.1 are not publicly available so we could not include them in the direct performance measurements. The experimental results shown are averaged over 20 runs along with one standard deviation. SPX incurs modest overhead of 12-15% over the insecure Split proxy baseline. This can be attributed to execution inside an SGX enclave, partly due to inherent SGX overhead, and partly due to the copying of encrypted network packets from host to enclave. The overhead is consistent with the reported results in other solutions for introspection of encrypted traffic in middleboxes [25, 41]. In addition, the SPX approach also does not mandate apriori knowledge of what to look for in the encrypted traffic, compared to earlier approaches limited in functionality or with high performance overhead, such as [36, 47]. The higher standard deviation in TLS vs. Noise is due to the packet size used in experiments. TLS experiments used blocks of 1KB for the full file transfer where as Noise mandates the use of messages to be less than or equal to 65535 bytes by design for simplicity in testing, reducing the likelihood of memory handling or integer overflow related issues and efficient implementation of stream ciphers.

**Web page loading.** To understand how SPX would perform in realistic settings where the communication may be over multiple connections and not always of the same size objects, we mimicked the web page loading process with SPX. We recorded and replayed Alexa’s top 100 websites using the Mahimahi tool [37] via a SPX-enable proxy. Figure 4(b) shows the cumulative distribution function (CDF) of the replayed webpage load times with proxy only and with SPX-enabled proxy. Evident from the graph is that there is modest overhead from SPX in full web page loading. We attribute this to the structure of the web pages which include a large number of small objects, where the overhead of SPX is not amortized. However, it is important to consider the fact the we are lo-

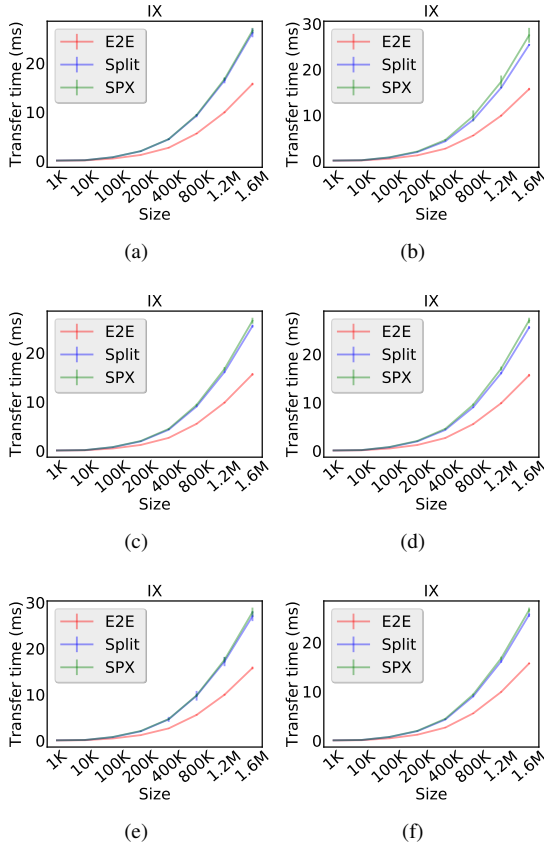
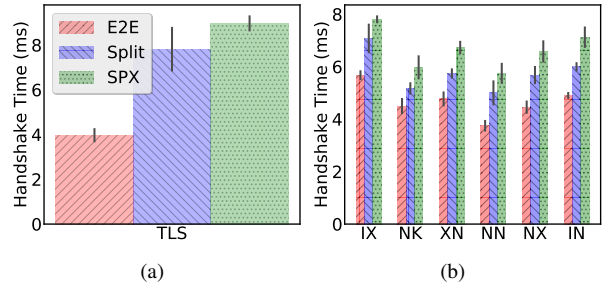

**Figure 5:** Showing time measured on client side in file transfer using different handshake patterns provided by NoiXE (SPX enabled Noise framework) using echo protocol over TCP.

cally replaying web pages over a very fast networks. The web page loading, which is usually in order of seconds finishes in tens of milliseconds, thus presenting the worst case for TLX. This is also evident on the right side in the figure: as the time to load increases, the performance gap diminishes.

**Handshake.** Figure 6 shows the time taken to carry out handshakes when a client connects to a server without any proxy (E2E), with a Split connection proxy, and finally, via an SPX-enabled proxy and server for TLS (Figure 6(a)) and 5 interactive handshake patterns (Figure 6(b)). Readers are directed to the Noise specifications [40] for details about the handshake patterns in Noise and its description terminology. The results shown are averaged over 20 runs to show one standard deviation. We observed an overhead of only 12%-15% over the baseline corresponding to the Split approach, which is the only available approach to enable edge functionality.

**Extra bytes and RTTs on wire during handshake.** In SPX, extra messages are exchanged between the edge and server during setup of up a secure connection. For TLS we only add one extra message between edge



**Figure 6:** Comparing the handshake time of SPX enabled protocols (TLX, NoiXe) as observed on client side.

Protocol	Extra bytes	Extra RTTs
TLX	1152	1
NoiXe	1090	1 or 2

**Table 2:** Overhead due to SPX in terms of extra bytes and RTTs.

and server corresponding to 1 extra RTT and for noise based protocols extra RTTs are 1 or 2 depending on whether the last message is from server or client respectively. The number of extra bytes exchanged between the edge and server due to SPX-enabled edge functions is  $2 * Size_{attestation-report} + Size_{session-key}$  also listed in Table 2. This demonstrates that the overhead of SPX in terms of extra bytes is reasonable, it is dependent on the protocol itself, and SPX is suitable for short-or long-lived connections.

Due to space limitations, and the current prevalence of TLS, we only show results for TLS for the remaining benchmarks. However, we report that we observed similar trends for the Noise protocols as well.

**Scalability with concurrent connections.** Figure 7(a) shows the handshake time measured on the client side for different number of concurrent connections. Evident from the figure is that the performance of SPX is not constrained by the number of concurrent connections. This is important for SPX to be a solution in edge computing scenarios because the edge infrastructure is by definition resource constrained. Further, it also highlights another point: with SPX, edge functions can securely service multiple clients without being limited by the amount of memory addressable by SGX enclaves.

**Scalability of edge functions.** We report that SPX puts substantial overhead of nearly  $\sim 2x$  in terms of CPU time during its operation. This has not been reported in earlier works that utilize SEE to develop introspection solutions for middleboxes. The consumption is due to memory copy of network packets from host to enclave and overhead due to memory page encryption and lack of vector instructions for cryptographic operations. This is substantial on its own. However, compared to BlindBox [47], which uses much more CPU-intensive searchable encryp-

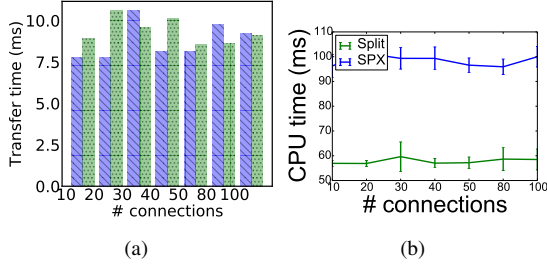

**Figure 7:** (a) Showing variation of time measured in file transfer using TLX with number of concurrent connections (b) Comparing CPU time spent on proxy side measured file transfer using concurrent.

tion while supporting only reduced functionality at the middleboxes with similar security guarantees, SPX provides full access to encrypted traffic with comparatively lower overheads. It may not be suitable for middleboxes which are simply preprovisioned boxes, but is especially important for edge computing, because this implies that developers have full flexibility to implement any logic for their edge functions and required compute capacity can be provisioned accordingly.

## 12 Related Work

In addition to the solutions discussed in the earlier sections [24, 25, 30, 36, 41, 47], SPX builds on other prior work related to secure execution environments.

**Edge function security.** Although several surveys [28, 44, 46, 48] have pointed out security and privacy challenges for edge functions, they do not handle cases of compromised operating systems but instead, focus on securing an execution environment. In an attempt to address the handling of encrypted traffic in edge services, one study [17] proposed Airbox, which is based on Intel SGX. Airbox, however, is not protocol-centric, nor does it address the limitations of the SEE hardware or prevent cuckoo or TOCTTU attacks. SPX fills this gap.

**Secure communication channel.** Assuming a similar threat model in which a host is untrusted, some studies have focused on building a secure communication channel on the same machine. Zhou et al. [54] outline an approach to secure the data-transfer between a user’s I/O device and a program trusted by the user. Jang et al. [29] propose SeCREt, a framework for building a secure channel between SEE and non-SEE. Unlike the approaches in these studies, SPX targets the establishment of secure end-to-end channel. EndBox proposes to run middlebox functions on client side using Intel SGX by leveraging VPN connections between clients and enterprise VPS servers. The approach is not applicable in edge computing as the edge functions run on edge infrastructure and may not be suit-

able to run on individual client devices. A simple example is a web caching edge function which is already prevalent in client browsers, but using caching across clients has its own set of security issues. Further, from a performance perspective, they may not offer acceptable performance which is the core reason to deploy edge functions.

**Use of SEE-based remote attestation.** Several systems built on top of shielded execution environments [15, 16, 19, 27, 38, 42, 45, 49, 52, 53] focus on providing a secure execution environment. However, they do not provide for establishing the trustworthiness of the communication channels with such primitives, which is an inseparable and critical part of edge computing. Several studies [32–34] have used remote attestation to provide a remote party trustworthiness of the local TCB. Haven [16] leverages Intel SGX to prevent code and data from tampering by an untrusted cloud provider. Although the above-mentioned studies are concrete examples of using hardware-assisted remote attestation, they either fail to provide details about how to perform remote attestation in a communication protocol or assume only the naive protocols. SPX fills this gap in the protocol. Another approach replaces the TLS certificate by the attestation identity key (AIK) certificate. However, this solution is not suitable for the multi-tenant virtualized edge-computing scenario because (i) the AIK certificate is typically unique to one host machine, so it is vulnerable to MITM attack; (ii) the associated costs of assigning a TLS certificate to each edge function are high; and (iii) high SEE overhead in decrypting the pre-master secret and generating the attestation. In comparison, the SPX method of binding TLS session with remote attestation on the server side addresses those concerns

## 13 Conclusion

This paper presented a new framework – SPX– to create secure protocol extensions that enable edge functions to operate on encrypted traffic, without compromising end-to-end security properties or edge-related performance benefits. We coined  $E^3$  security properties as equivalent to end-to-end security properties in edge-computing scenarios. We demonstrated the feasibility and performance of SPX by prototyping it for TLS and Noise-based protocols based on Intel SGX. In addition to providing the desired performance and security properties, SPX addresses difficult problems such as interoperability and deployability, to ensure that we place minimum constraints on the developers in the nascent edge-computing ecosystem.

## References

- [1] Att is deploying white box hardware in cell towers to power mobile 5g era. URL <https://goo.gl/h13oSH>.
- [2] Cloudflare: Tls 1.3 is going to save us all, and other reasons

- why iot is still insecure. <https://blog.cloudflare.com/why-iot-is-insecure/>.
- [3] Etsi mobile edge computing. <http://goo.gl/Qef61X>.
  - [4] Google infrastructure maps. URL <https://peering.google.com/#/infrastructure>.
  - [5] 5g security package 3: Mobile edge computing/ low latency / consistent user experience.
  - [6] Nsa-linked cisco exploit poses bigger threat than previously thought. <http://arstechnica.com/security/2016/08/nsa-linked-cisco-exploit-poses-bigger-threat-than-previously-thought/>.
  - [7] Openfog consortium. <https://www.openfogconsortium.org/>.
  - [8] Global internet phenomena spotlight - encrypted traffic. <http://goo.gl/KP0d0n>.
  - [9] Intel software guard extensions programming reference. <https://goo.gl/sy0tRu>.
  - [10] Vodafone mobile edge computing. <https://goo.gl/GWVnha>.
  - [11] Whatsapp encryption overview - technical whitepaper. <https://goo.gl/MuHvjC>.
  - [12] Dyn analysis summary of friday october 21 attack. <http://dyn.com/blog/dyn-analysis-summary-of-friday-october-21-attack/>, 11 2016.
  - [13] Breaking down mirai: An iot DDoS botnet analysis. <https://www.incapsula.com/blog/malware-analysis-mirai-ddos-botnet.html>, 10 2016.
  - [14] A. Alkazimi and E. B. Fernandez. "heartbleed": A misuse pattern for the openssl implementation of the ssl/tls protocol. In *Proceedings of the 23rd Conference on Pattern Languages of Programs, PLoP '16*, pages 6:1–6:8, USA, 2016. The Hillside Group. URL <http://dl.acm.org/citation.cfm?id=3158161.3158169>.
  - [15] Amazon Web Services. AWS CloudHSM, 2013. <http://aws.amazon.com/cloudhsm/>.
  - [16] A. Baumann, M. Peinado, and G. Hunt. Shielding applications from an untrusted cloud with haven. In *Proceedings of the 11th USENIX Symposium on Operating Systems Design and Implementation (OSDI)*, pages 267–283, Broomfield, Colorado, Oct. 2014.
  - [17] K. Bhardwaj, M. Shih, P. Agarwal, A. Gavrilovska, T. Kim, and K. Schwan. Fast, scalable and secure onloading of edge functions using airbox. In *Proceedings of first IEEE/ACM symposium on Edge Computing*.
  - [18] S. Checkoway and H. Shacham. Iago attacks: Why the system call api is a bad untrusted rpc interface. In *Proceedings of the Eighteenth International Conference on Architectural Support for Programming Languages and Operating Systems, ASPLOS '13*, pages 253–264, New York, NY, USA, 2013. ACM. ISBN 978-1-4503-1870-9. doi: 10.1145/2451116.2451145. URL <http://doi.acm.org/10.1145/2451116.2451145>.
  - [19] X. Chen, T. Garfinkel, E. C. Lewis, P. Subrahmanyam, C. A. Waldspurger, D. Boneh, J. Dworkin, and D. R. Ports. Overshadow: A virtualization-based approach to retrofitting protection in commodity operating systems. In *Proceedings of the 13th International Conference on Architectural Support for Programming Languages and Operating Systems*, pages 2–13, Seattle, WA, Mar. 2008.
  - [20] cloudfront. AWS CloudFront Locations. URL <https://aws.amazon.com/cloudfront/details>.
  - [21] C. Evans, C. Palmer, and R. Sleevi. Public key pinning extension for http. <http://tools.ietf.org/html/rfc7469>, 2015.
  - [22] Federal Communications Commission. Antenna Structure Registration. URL <http://wireless.fcc.gov/antenna/index.html>.
  - [23] J. Frahm, C. Pignataro, J. Aparcar, and M. Morrow. Cisco: Securing the internet of things: A proposed framework. <http://www.cisco.com/c/en/us/about/security-center/secure-iot-proposed-framework.html>.
  - [24] C. Gentry. *A Fully Homomorphic Encryption Scheme*. PhD thesis, Stanford, CA, USA, 2009. AAI3382729.
  - [25] C. Gkantsidis, T. Karagiannis, D. Naylor, R. Li, and P. Steenkiste. And then there were more: Secure communication for more than two parties. Technical report, July 2017. URL <https://www.microsoft.com/en-us/research/publication/therewere-secure-communication-two-parties/>.
  - [26] M. Hoekstra, R. Lal, P. Pappachan, V. Phegade, and J. Del Cuvillo. Using innovative instructions to create trustworthy software solutions. In *Proceedings of the 2nd International Workshop on Hardware and Architectural Support for Security and Privacy (HASP)*, pages 1–8, Tel-Aviv, Israel, 2013.
  - [27] O. S. Hofmann, S. Kim, A. M. Dunn, M. Z. Lee, and E. Witchel. Inktag: secure applications on an untrusted operating system. Mar. 2013.
  - [28] R. Illera, S. Ortega, and M. Petychakis. Security and privacy considerations for cloud-based services and cloudlets. 2013.
  - [29] J. Jang, S. Kong, M. Kim, D. Kim, and B. B. Kang. Secret: Secure channel between rich execution environment and trusted execution environment. In *Proceedings of the 2015 Annual Network and Distributed System Security Symposium (NDSS)*, San Diego, CA, Feb. 2015.
  - [30] C. Lesniewski-Laas and M. F. Kaashoek. Ssl splitting: Securely serving data from untrusted caches. In *Proceedings of the 12th Conference on USENIX Security Symposium - Volume 12, SSYM'03*, pages 13–13, Berkeley, CA, USA, 2003. USENIX Association. URL <http://dl.acm.org/citation.cfm?id=1251353.1251366>.
  - [31] J. Liang, J. Jiang, H. Duan, K. Li, T. Wan, and J. Wu. When https meets cdn: A case of authentication in delegated service. In *2014 IEEE Symposium on Security and Privacy*, pages 67–82, 2014.
  - [32] L. Martignoni, P. Poosankam, M. Zaharia, J. Han, S. McCamant, D. Song, V. Paxson, A. Perrig, S. Shenker, and I. Stoica. Cloud Terminal: Secure access to sensitive applications from untrusted systems. In *Proceedings of the 2012 USENIX Annual Technical Conference (ATC)*, pages 165–182, Boston, MA, June 2012.
  - [33] J. M. McCune, B. J. Parno, A. Perrig, M. K. Reiter, and H. Isozaki. Flicker: An Execution Infrastructure for TCB Minimization. In *Proceedings of the 3rd European Conference on Computer Systems (EuroSys)*, pages 315–328, Glasgow, Scotland, Mar. 2008.
  - [34] J. M. McCune, Y. Li, N. Qu, Z. Zhou, A. Datta, V. Gligor, and A. Perrig. Trustvisor: Efficient tcb reduction and attestation. In *Proceedings of the 2010 IEEE Symposium on Security and Privacy, SP '10*, pages 143–158, Washington, DC, USA, 2010. IEEE Computer Society. ISBN 978-0-7695-4035-1. doi: 10.1109/SP.2010.17. URL <http://dx.doi.org/10.1109/SP.2010.17>.
  - [35] F. McKeen, I. Alexandrovich, A. Berenzon, C. Rozas, H. Shafi, V. Shanbhogue, and U. Savagaonkar. Innovative instructions and software model for isolated execution. <https://goo.gl/6mp7ww>.
  - [36] D. Naylor, K. Schomp, M. Varvello, I. Leontiadis, J. Blackburn, D. R. López, K. Papagiannaki, P. Rodriguez Rodriguez, and P. Steenkiste. Multi-context tls (mctls): Enabling secure in-network functionality in tls. In *Proceedings of the 2015 ACM Conference on Special Interest Group on Data Communication, SIGCOMM '15*, pages 199–212, New York, NY, USA, 2015. ACM. ISBN 978-1-4503-3542-3. doi: 10.1145/2785956.2787482. URL <http://doi.acm.org/10.1145/2785956.2787482>.

- [37] R. Netravali, A. Sivaraman, S. Das, A. Goyal, K. Winstein, J. Mickens, and H. Balakrishnan. Mahimahi: Accurate record-and-replay for http. In *Proceedings of the 2015 USENIX Conference on Usenix Annual Technical Conference*, USENIX ATC '15, pages 417–429, Berkeley, CA, USA, 2015. USENIX Association. ISBN 978-1-931971-225. URL <http://dl.acm.org/citation.cfm?id=2813767.2813798>.
- [38] E. Owusu, J. Guajardo, J. McCune, J. Newsome, A. Perrig, and A. Vasudevan. OASIS: On achieving a sanctuary for integrity and secrecy on untrusted platforms. In *Proceedings of the 20th ACM Conference on Computer and Communications Security (CCS)*, pages 13–24, Berlin, Germany, Oct. 2013.
- [39] B. Parno. Bootstrapping trust in a “trusted” platform. In *Proceedings of the 3rd Conference on Hot Topics in Security (HotSec)*, pages 9:1–9:6, 2008.
- [40] T. Perrin. Noise protocol specification. <http://goo.gl/i0PnAU>.
- [41] R. Poddar, C. Lan, R. A. Popa, and S. Ratnasamy. Safebricks: Shielding network functions in the cloud. In *15th USENIX Symposium on Networked Systems Design and Implementation (NSDI 18)*, pages 201–216, Renton, WA, 2018. USENIX Association. ISBN 978-1-931971-43-0. URL <https://www.usenix.org/conference/nsdi18/presentation/poddar>.
- [42] H. Raj, D. Robinson, T. B. Tariq, P. England, S. Saroiu, and A. Wolman. Credo: Trusted computing for guest vms with a commodity hypervisor. Technical Report MSR-TR-2011-130, Microsoft Research, 2011.
- [43] P. Rodriguez. The Edge: Evolution or Revolution. In *ACM/IEEE Symposium on Edge Computing (SEC'17)*, 2017.
- [44] R. Roman, J. Lopez, and M. Mambo. Mobile edge computing, fog et al.: A survey and analysis of security threats and challenges.
- [45] F. Schuster, M. Costa, C. Fournet, C. Gkantsidis, M. Peinado, G. Mainar-Ruiz, and M. Russinovich. Vc3: Trustworthy data analytics in the cloud using sgx. In *Proceedings of the 36th IEEE Symposium on Security and Privacy (Oakland)*, San Jose, CA, May 2015.
- [46] J. Sen. Security and privacy issues in cloud computing. *Architectures and Protocols for Secure Information Technology Infrastructures*, pages 1–45, 2013.
- [47] J. Sherry, C. Lan, R. A. Popa, and S. Ratnasamy. Blindbox: Deep packet inspection over encrypted traffic. In *Proceedings of the 2015 ACM Conference on Special Interest Group on Data Communication, SIGCOMM '15*, pages 213–226, New York, NY, USA, 2015. ACM. ISBN 978-1-4503-3542-3. doi: 10.1145/2785956.2787502. URL <http://doi.acm.org/10.1145/2785956.2787502>.
- [48] H. Suo, Z. Liu, J. Wan, and K. Zhou. Security and privacy in mobile cloud computing. In *Wireless Communications and Mobile Computing Conference (IWCMC), 2013 9th International*, pages 655–659. IEEE, 2013.
- [49] R. Ta-Min, L. Litty, and D. Lie. Splitting interfaces: Making trust between applications and operating systems configurable. In *Proceedings of the 7th USENIX Symposium on Operating Systems Design and Implementation (OSDI)*, Seattle, WA, Nov. 2006.
- [50] T. D. <tim@dierks.org>. The transport layer security (TLS) protocol version 1.2. <http://tools.ietf.org/html/rfc5246>, 2013.
- [51] Trusted Computing Group. Tpm main specification level 2 version 1.2, revision 116, March 2011.
- [52] J. Yang and K. G. Shin. Using hypervisor to provide data secrecy for user applications on a per-page basis. In *Proceedings of the 4th International conference on Virtual Execution Environments*, pages 71–80, 2008.
- [53] F. Zhang, J. Chen, H. Chen, and B. Zang. Cloudvisor: retrofitting protection of virtual machines in multi-tenant cloud with nested virtualization. In *Proceedings of the 23rd ACM Symposium on Operating Systems Principles (SOSP)*, Cascais, Portugal, Oct. 2011.
- [54] Z. Zhou, V. D. Gligor, J. Newsome, and J. M. McCune. Building verifiable trusted path on commodity x86 computers. In *Proceedings of the 33rd IEEE Symposium on Security and Privacy (Oakland)*, San Francisco, CA, May 2012.