

Collapsing Superstring Conjecture

Alexander Golovnev* Alexander S. Kulikov† Alexander Logunov† Ivan Mihajlin‡

September 25, 2018

Abstract

In the Shortest Common Superstring (SCS) problem, one is given a collection of strings, and needs to find a shortest string containing each of them as a substring. SCS admits $2\frac{11}{23}$ -approximation in polynomial time. While this algorithm and its analysis are technically involved, the 30 years old Greedy Conjecture claims that the trivial and efficient Greedy Algorithm gives a 2-approximation for SCS. The Greedy Algorithm repeatedly merges two strings with the largest intersection into one, until only one string remains.

We develop a graph-theoretic framework for studying approximation algorithms for SCS. In this framework, we give a (stronger) counterpart to the Greedy Conjecture: We conjecture that the presented in this paper Greedy Hierarchical Algorithm gives a 2-approximation for SCS. This algorithm is almost as simple as the standard Greedy Algorithm, and we suggest a combinatorial approach for proving this conjecture. We support the conjecture by showing that the Greedy Hierarchical Algorithm gives a 2-approximation in the case when all input strings have length at most 3 (which until recently had been the only case where the Greedy Conjecture was proven). We also tested our conjecture on tens of thousands of instances of SCS.

Except for its conjectured good approximation ratio, the Greedy Hierarchical Algorithm finds *exact* solutions for the special cases where we know polynomial time (not greedy) exact algorithms: (1) when the input strings form a spectrum of a string (2) when all input strings have length at most 2.

*Harvard University

†Steklov Institute of Mathematics at St. Petersburg, Russian Academy of Sciences

‡University of California, San Diego

1 Introduction

The *shortest common superstring problem* (abbreviated as SCS) is: given a set of strings, find a shortest string that contains all of them as substrings. This problem finds applications in genome assembly [Wat95, PTW01], and data compression [GMS80, Gal82, Sto87]. We refer the reader to the excellent surveys [GP14, Muc07] for an overview of SCS, its applications and algorithms. SCS is known to be **NP**-hard [GMS80] and even **MAX-SNP**-hard [BJL⁺91], but it admits constant-factor approximation in polynomial time.

The best known approximation ratio is $2\frac{11}{23}$ due to Mucha [Muc13] (see [GKM13, Section 2.1] for an overview of the previous approximation algorithms and inapproximability results). While this approximation algorithm uses an algorithm for Maximum Weight Perfect Matching as a subroutine, the 30 years old *Greedy Conjecture* [Sto87, TU88, Tur89, B JL⁺91] claims that the trivial *Greedy Algorithm*, whose pseudocode is given in Algorithm 1, is 2-approximate. Ukkonen [Ukk90] shows that for a fixed alphabet, the Greedy Algorithm can be implemented in linear time.

Algorithm 1 Greedy Algorithm (GA)

Input: set of strings \mathcal{S} .

Output: a superstring for \mathcal{S} .

- 1: **while** \mathcal{S} contains at least two strings **do**
 - 2: extract from \mathcal{S} two strings with the maximum overlap
 - 3: add to \mathcal{S} the shortest superstring of these two strings
 - 4: return the only string from \mathcal{S}
-

Blum et al. [BJL⁺91] prove that the Greedy Algorithm returns a 4-approximation of SCS, and Kaplan and Shafrir [KS05] improve this bound to 3.5. A slight modification of the Greedy Algorithm gives a 3-approximation of SCS [BJL⁺91], and other greedy algorithms are studied from theoretical [BJL⁺91, RC18] and practical perspectives [RBT04, CJR18].

It is known that the Greedy Conjecture holds for the case when all input strings have length at most 3 [TU88, CR18b], and it was recently shown to hold in the case of strings of length 4 [KSS15]. Also, the Greedy Conjecture holds if the Greedy Algorithm happens to merge strings in a particular order [WS06, LW05]. The Greedy Algorithm gives a 2-approximation of a different metric called compression [TU88]. The compression is defined as the sum of the lengths of all input strings minus the length of a superstring (hence it is the number of symbols saved with respect to a naive superstring resulting from concatenating the input strings).

Most of the approaches for approximating SCS are based on the *overlap graph* or the equivalent *suffix graph*. The suffix graph has input strings as nodes, and a pair of nodes is joined by an arc of weight equal to their suffix (see Section 2.1 for formal definitions of overlap and suffix). SCS is equivalent to the Traveling Salesman Problem (TSP) in the suffix graph. While TSP cannot be approximated within any polynomial time computable function unless $\mathbf{P} = \mathbf{NP}$ [SG76], its special case corresponding to SCS can be approximated within a constant factor.¹ We do not know the full characterization of the graphs in this special case, but we know some of its properties: Monge inequality [Mon81], Triple inequality [WS06]. These properties are provably not sufficient for proving Greedy Conjecture [WS06, LW05].

¹We remark that SCS is also a special case of Metric TSP which can be approximated within a constant factor [STV18], but this factor is much worse than that for SCS.

While the overlap and suffix graphs give a convenient graph structure, our current knowledge of their properties is provably not sufficient for showing strong approximation factors. Thus, the known approximation algorithms (including the Greedy Algorithm) estimate the approximation ratio via the overlap graph, and also separately take into account string properties. The goal of this paper is to develop a simple combinatorial framework which captures all features of the input strings needed for proving approximation ratios of algorithms.

We continue the study of the so-called *hierarchical graph* introduced by Golovnev et al. [GKM14]. This graph in a sense generalizes de Bruijn graph, it is designed specifically for the SCS problem, and contains more useful information about the input strings than just all pairwise overlaps. We present a simple and natural greedy algorithm in the hierarchical graph. We demonstrate its usefulness by showing that it finds an optimal solution in two well-known polynomially solvable special cases: strings of length 2 and a spectrum of a string.

We then conjecture that this greedy algorithm is 2-approximate. We suggest a combinatorial way of proving this conjecture. For this, we introduce an *even stronger* conjecture that we call *Collapsing Superstring Conjecture*. Roughly, it says that it is possible to transform a doubled optimal solution into a greedy solution. The corresponding transformation, that we call *collapsing*, is just a repeated replacing of two arcs $a\alpha \rightarrow aab \rightarrow ab$ by two arcs $a\alpha \rightarrow \alpha \rightarrow ab$ (where α is an arbitrary string). We support the Collapsing Superstring Conjecture by proving that it holds for the special case when the input strings have length 3.

The Collapsing Superstring Conjecture immediately implies that the Greedy Hierarchical Algorithm is 2-approximate. Remarkably, it seems to be much stronger in the following sense. Let GS be the set of arcs of a greedy solution and let DOS be the set of arcs of a collapsed doubled optimal solution. For proving 2-approximability, it suffices to show that $|GS| \leq |DOS|$. One way of showing this is to prove that $GS \subseteq DOS$. The conjecture, at the same time, states that this inclusion holds with equality.

We implemented the Greedy Hierarchical Algorithm [git18], and tested our conjectures on tens of thousands of datasets (both hand-crafted and generated randomly according to various distributions). We invite the reader to a web interface [web18] to see step by step executions of the described algorithms and to verify the conjectures on various datasets.

2 Definitions

2.1 Shortest Common Superstring Problem

For a string s , by $|s|$ we denote the length of s . For strings s and t , by $\text{overlap}(s, t)$ we denote the longest suffix of s that is also a prefix of t . By $\text{pref}(s, t)$ we denote the first $|s| - |\text{overlap}(s, t)|$ symbols of s . Similarly, $\text{suff}(s, t)$ is the last $|t| - |\text{overlap}(s, t)|$ symbols of t . By $\text{pref}(s)$ and $\text{suff}(s)$ we denote, respectively, the first and the last $|s| - 1$ symbols of s . See Figure 1 for a visual explanation. We denote the empty string by ε .

If U and V are two multisets, then by $U \sqcup V$ we denote the multiset W such that each $w \in W$ has multiplicity equal to the sum of multiplicities it has in sets U and V . For a directed graph $G = (V, E)$, we say that P is a weak path between vertices $u, v \in V$ if replacing all arcs of G with undirected edges produces a graph where P is an undirected path between u and v .

Throughout the paper by $\mathcal{S} = \{s_1, \dots, s_n\}$ we denote the set of n input strings. We assume that no input string is a substring of another (such a substring can be removed from \mathcal{S} on the

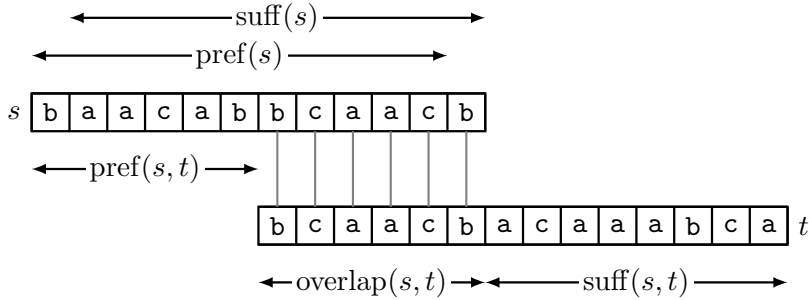

Figure 1: Pictorial explanations of pref , suff , and overlap functions.

preprocessing stage). Note that SCS is a *permutation problem*: to find a shortest string containing all s_i 's in a given order one just overlaps the strings in this order, see Figure 2. This simple observation relates SCS to other permutation problems, including various versions of the Traveling Salesman Problem.

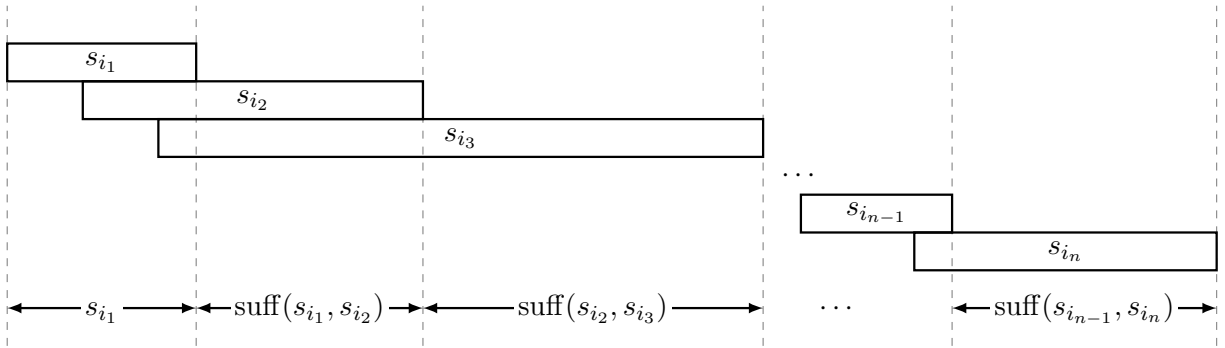

Figure 2: SCS is a permutation problem. The length of a superstring corresponding to a permutation $(s_{i_1}, \dots, s_{i_n})$ is $|s_{i_1}|$ plus the sum of the lengths of suffixes of consecutive pairs of strings.

2.2 Hierarchical Graph

For a set of strings \mathcal{S} , the *hierarchical graph* $HG = (V, E)$ is a weighted directed graph with $V = \{v: v \text{ is a substring of some } s \in \mathcal{S}\}$. For every $v \in V, v \neq \varepsilon$, the set of arcs E contains an *up-arc* $(\text{pref}(v), v)$ of weight 1 and a *down-arc* $(v, \text{suff}(v))$ of weight 0. The meaning of an up-arc is appending one symbol to the end of the current string (and that is why it has weight 1), whereas the meaning of a down-arc is cutting down one symbol from the beginning of the current string. Figure 3(a) gives an example of the hierarchical graph and shows that the terminology of up- and down-arcs comes from placing all the strings of the same length at the same level, where the i -th level contains strings of length i . In all the figures in this paper, the input strings are shown in rectangles, while all other vertices are ellipses.

What we are looking for in this graph is a shortest walk from ε to ε going through all the nodes from \mathcal{S} . It is not difficult to see that the length of a walk from ε to ε equals the length of the string

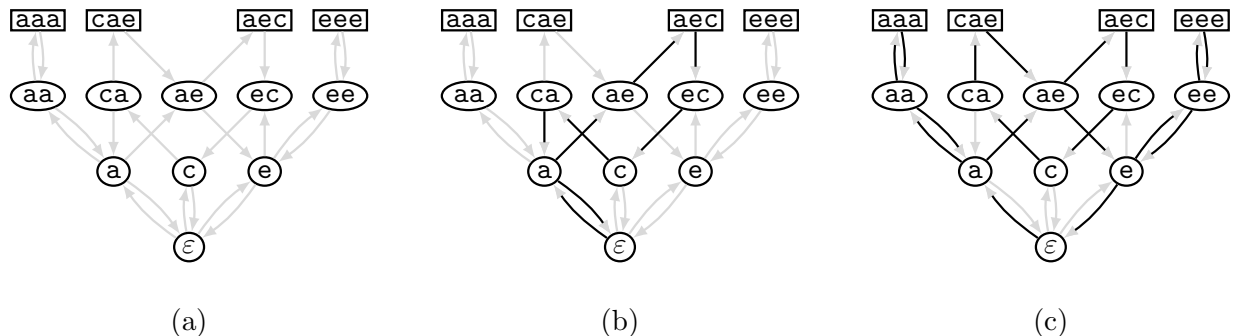

Figure 3: (a) Hierarchical graph for the dataset $\mathcal{S} = \{aaa, cae, aec, eee\}$. (b) The walk $\varepsilon \rightarrow a \rightarrow ae \rightarrow aec \rightarrow ec \rightarrow c \rightarrow ca \rightarrow a \rightarrow \varepsilon$ has length (or weight) 4 and spells the string $aeca$ of length 4. (c) An optimal superstring for \mathcal{S} is $aaaeceaeee$. It has length 9, corresponds to the permutation (aaa, aec, cae, eee) , and defines the walk of length 9 shown in black.

spelled by this walk. This is just because each up-arc has weight 1 and adds one symbol to the current string. See Figure 3(b) for an example.

Hence, the SCS problem is equivalent to finding a shortest closed walk from ε to ε that visits all nodes from \mathcal{S} . Note that a walk may contain repeated nodes and arcs. The multiset of arcs of such a walk must be Eulerian (each vertex must have the same in- and out-degree, and the set of arcs must be connected). It will prove convenient to define a *solution* in a hierarchical graph as an Eulerian multiset of arcs D that goes through ε and all nodes from \mathcal{S} . Given such a solution D , one can easily recover an Eulerian cycle (that might not be unique). This cycle spells a superstring of \mathcal{S} of the same length as D . Figure 3(c) shows a solution corresponding to an optimal superstring.

3 Greedy Hierarchical Algorithm

3.1 Algorithm and Conjecture

In this section, we present a greedy algorithm for finding a superstring in the hierarchical graph. It constructs a solution D in a stingy way. Namely, the algorithm only adds arcs to D if it is absolutely necessary: either to balance the degree of a node or to ensure connectivity (as D must be Eulerian). More precisely, first it considers the input strings \mathcal{S} . Since we assume that no $s \in \mathcal{S}$ is a substring of another $t \in \mathcal{S}$, there is no down-path from t to s in HG . This means that any walk through ε and \mathcal{S} goes through the arcs $\{(\text{pref}(s), s), (s, \text{suff}(s)) : s \in \mathcal{S}\}$. The algorithm adds all of them to D and starts processing all the nodes level by level, from top to bottom. On each level, we process the nodes in the lexicographic order. If the degree of the current node v is imbalanced, we balance it by adding an appropriate number of incoming (i.e., $(\text{pref}(v), v)$) or outgoing (i.e., $(v, \text{suff}(v))$) arcs from the previous (i.e., lower) level. In case v is balanced, we just skip it. The only exception when we cannot skip it is when v lies in an Eulerian component and v is the last chance of this component to be connected to the rest of the arcs in D . We give an example of such a situation below. The pseudocode is given in Algorithm 3.1. Figure 4 shows a few intermediate stages of the algorithm on our working sample dataset.

The advantage of GHA over GA is that GHA is more flexible in the following sense. On every

3.2 Strings of Length 2

Gallant et al. [GMS80] show that SCS on strings of length 3 is **NP**-hard, but SCS on strings of length at most 2 is solvable in polynomial time. In this section we show that GHA finds an optimal solution in this case as well. We note that the standard Greedy Algorithm does not necessarily find an optimal solution in this case. For example, if $\mathcal{S} = \{ab, ba, bb\}$, the Greedy Algorithm may first merge ab and ba , which would lead to a suboptimal solution $ababb$.

First, we can assume that all input strings from \mathcal{S} have length exactly 2. Indeed, since we assume that no input string is a substring of another input string, all strings of length 1 are unique characters which do not appear in other strings. Take any such s_i of length 1. The optimal superstring length for \mathcal{S} is k if and only if the optimal superstring length for $\mathcal{S} \setminus \{s_i\}$ is $k - 1$. The Greedy Hierarchical Algorithm has the same behavior: In Step 2, GHA will include the arcs $(\varepsilon, s_i), (s_i, \varepsilon)$ in the solution, and it will never touch the vertex s_i again (because it is balanced and connected to ε). Thus, s_i adds 1 to the length of the Greedy Hierarchical Superstring as well. By the same reasoning, we can assume that each string of length two is primitive, i.e., contains two distinct characters.

When considering primitive strings $\mathcal{S} = \{s_1, \dots, s_n\}$ of length exactly 2, it is convenient to introduce the following directed graph $G = (V, E)$, where V contains a vertex for every symbol which appears in strings from \mathcal{S} . The graph has $|E| = n$ arcs corresponding to n input strings: for every string $s_i = ab$, there is an arc from a to b . It is known [GMS80] that the length of an optimal superstring in this case is $n + k$ where k is the minimum number such that E can be decomposed into k directed paths, or, equivalently:

Proposition 1 ([GMS80]). *Let G be the graph defined above, and let $G_1 = (V_1, E_1), \dots, G_c = (V_c, E_c)$ be its weakly connected components. Then the length of an optimal superstring is*

$$n + \sum_{i=1}^c \max \left(1, \sum_{v \in V_i} \frac{|\text{indegree}(v) - \text{outdegree}(v)|}{2} \right). \quad (1)$$

We will now show that in this case, GHA finds an optimal solution.

Lemma 1. *Let $\mathcal{S} = \{s_1, \dots, s_n\}$ be a set of strings of length at most 2, and let s be an optimal superstring for \mathcal{S} . Then $GHA(\mathcal{S})$ returns a superstring of length $|s|$.*

Proof. We showed above that it suffices to consider the case of n primitive strings $\{s_1, \dots, s_n\}$ of length exactly 2. For $1 \leq i \leq n$, let $s_i = a_i b_i$, where $a_i \neq b_i$. Consider the partial greedy hierarchical solution D after the Step 2 of the GHA algorithm: $D = \{(a_i, a_i b_i), (a_i b_i, b_i) : 1 \leq i \leq n\}$. (We abuse notation by identifying the set of arcs D with the graph induced by D .) This partial solution has n up-arcs, so its current weight is n .

Note that by the definition of the graph G above, G contains an arc (a, b) if and only if D has the arcs (a, ab) and (ab, b) of the graph HG. Thus, the indegree (outdegree) of a vertex a in G equals the indegree (outdegree) of the vertex a in the partial solution D . Also, two vertices a and b of G belong to one weakly connected component in G if and only if they belong to one weakly connected component in D . Therefore, the expression (1) in G has the same value in the partial solution graph D . (Indeed, the vertices of D corresponding to strings of length 2 are balanced and do not form weakly connected components.)

Now we proceed to Steps 3–11 of GHA. GHA will go through all strings of length 1, and add $|\text{indegree}(v) - \text{outdegree}(v)|$ arcs for each unbalanced vertex v . The Steps 8–11 ensure that each weakly connected component adds at least a pair of arcs. Since exactly a half of added arcs are up-arcs, we have increased the weight of the partial solution D by

$$\sum_{i=1}^c \max \left(1, \sum_{v \in V_i} \frac{|\text{indegree}(v) - \text{outdegree}(v)|}{2} \right).$$

□

3.3 Spectrum of a String

By a k -spectrum of a string s (of length at least k) we mean a set of all substrings of s of length k . Pevzner et al. [PTW01] give a polynomial time exact algorithm for the case when the input strings form a spectrum of an unknown string. We show that GHA also finds an optimal solution in this case.

Lemma 2. *Let $\mathcal{S} = \{s_1, \dots, s_n\}$ be a k -spectrum of an unknown string s . Then $\text{GHA}(\mathcal{S})$ returns a superstring of length at most $|s|$.*

Proof. Since s has n distinct substrings of length k , $|s| \geq n + k - 1$. We will show that GHA finds a superstring of length $n + k - 1$. After Step 2 of GHA, the partial solution $D = \{(\text{pref}(s), s), (s, \text{suff}(s)) : s \in \mathcal{S}\}$. In particular, D is of weight n . For $1 \leq i \leq k - 1$, let u_i be the first i symbols of s , and let v_i be the last i symbols of s . Note that u_{k-1} and v_{k-1} are the only unbalanced vertices of the partial solution D after Step 2: all other strings of length $k - 1$ appear equal number of times as prefixes and suffixes of strings from \mathcal{S} . Therefore, while processing the level $\ell = k - 1$, GHA will add one arc to each of the vertices u_{k-1} and v_{k-1} , and will not add arcs to other strings of length $k - 1$.

In general, while processing the level $\ell = i$, GHA adds one up-arc to u_i and one down-arc to v_i . In order to show this, we consider two cases. If $u_i \neq v_i$, then u_i has an incoming arc from the previous step and does not have outgoing arcs, therefore GHA adds an up-arc to u_i in Step 6. Similarly, GHA adds a down-arc from v_i . Note that there are no other strings of length $i < k - 1$ in the partial solution, so the algorithm moves to the next level. In the case when $u_i = v_i$, we have that all vertices are balanced, but the string u_i is now the shortest string in this only connected component \mathcal{C} of the graph. Therefore, for $i > 0$ we have $\varepsilon \notin \mathcal{C}$, and GHA adds an up- and down-arc to u_i in Step 11.

We just showed that GHA solution for a k -spectrum of a string has the initial set of arcs $D = \{(\text{pref}(s), s), (s, \text{suff}(s)) : s \in \mathcal{S}\}$, and also the arcs $\{(u_{i-1}, u_i), (v_i, v_{i-1}) : 1 \leq i \leq k - 1\}$. Thus, the total number of up-arcs (and the weight of the solution) is $n + k - 1$. □

3.4 Tough Dataset

There is a well-known dataset consisting of just three strings where the classical greedy algorithm produces a superstring that is almost twice longer than an optimal one: $s_1 = \text{cc}(\text{ae})^n$, $s_2 = (\text{ea})^{n+1}$, $s_3 = (\text{ae})^n \text{cc}$. Since $\text{overlap}(s_1, s_3) = 2n$, while $\text{overlap}(s_1, s_2) = \text{overlap}(s_2, s_3) = 2n - 1$, the greedy algorithm produces a permutation (s_1, s_3, s_2) (or (s_2, s_1, s_3)). I.e., by greedily taking the massive overlap of length $2n$ it loses the possibility to insert s_2 between s_1 and s_3 and to get two overlaps of

size $2n - 1$. The resulting superstring has length $4n + 6$. At the same time, the optimal superstring corresponds to the permutation (s_1, s_2, s_3) and has length $2n + 8$.

The algorithm GHA makes a similar mistake on this dataset, see Figure 5. When processing the node $(ea)^n$, GHA does not add two lower arcs to it and misses a chance to connect two components. It is then forced to connect these two components through ε . This example shows that GHA also does not give a better than 2-approximation for SCS.

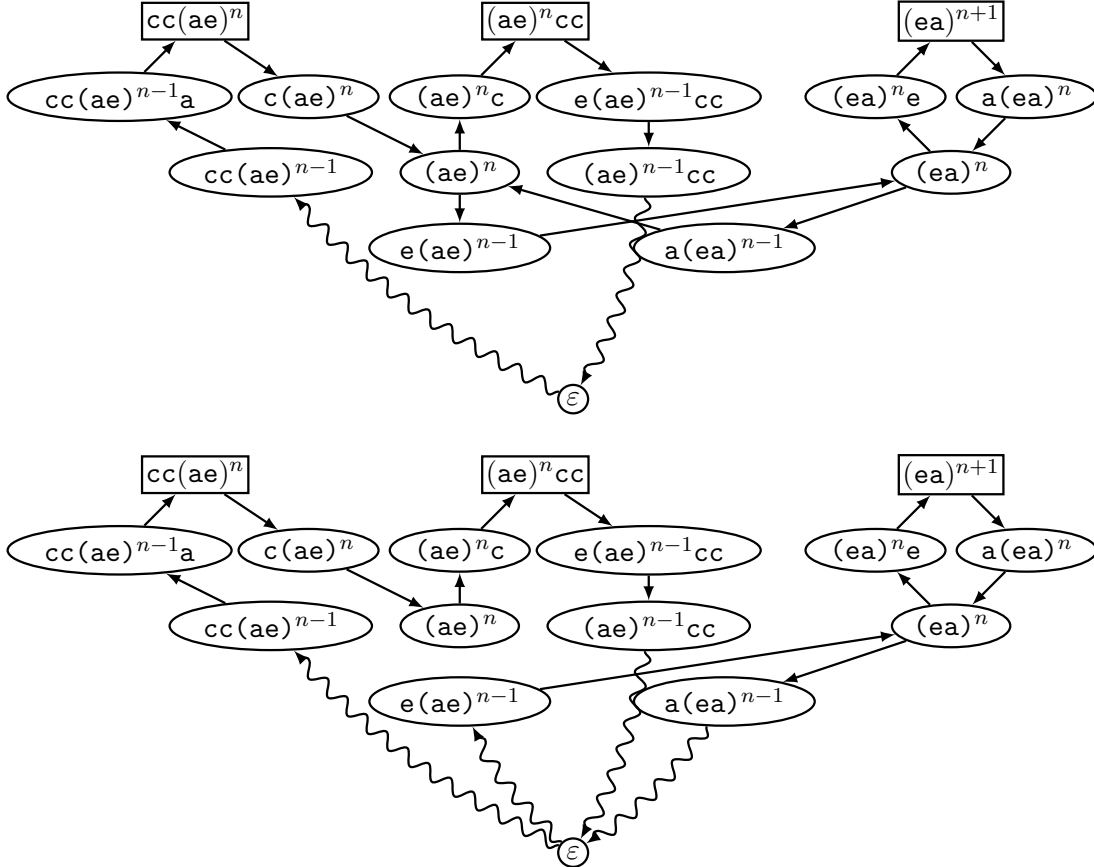

Figure 5: Top: optimal solution for the dataset $\{cc(ae)^n, (ea)^{n+1}, (ae)^n cc\}$. Bottom: solution constructed by GHA.

4 Collapsing Algorithm

In this section, we suggest a way to prove the Greedy Hierarchical Superstring Conjecture. We define a transformation of a superstring s into a different superstring s' of the same set of strings such that $|s'| \leq |s|$. This transformation is done by the Collapsing Algorithm in the hierarchical graph. Informally, the Collapsing Algorithm removes some of the “redundancies” in a superstring. We believe that if one takes *any* superstring s of a set of strings \mathcal{S} , then concatenates two copies of s , and applies the Collapsing Algorithm, then one always gets exactly the set of arcs chosen by the Greedy Hierarchical Algorithm. We call this the Collapsing Superstring Conjecture. If it is true, then for

s equal to an optimal superstring, we get a proof of the Greedy Hierarchical Conjecture. Thus, the Collapsing Superstring Conjecture implies the Greedy Hierarchical Superstring Conjecture.

Moreover, if the Collapsing Superstring Conjecture is true, then it gives an alternative simple 2-approximate algorithm for SCS. Indeed, one can take any trivial solution (for example, concatenate all the input strings), then double this solution, and apply the simple Collapsing Algorithm. This will result in a solution which is no longer than two optimal solutions.

In Section 4.1 we give all formal definitions and algorithms. In Sections 4.2–4.4 we support the conjecture by proving its special case for strings of length 3. We have verified the conjecture on various datasets, and we invite the reader to see its visualizations and to check the conjecture on arbitrary datasets at the webpage [web18].

4.1 Algorithm and Conjecture

The idea of the Collapsing Algorithm is the following. We start with any solution D in the hierarchical graph. We double every arc of D (note that D remains a solution). What we do next can be informally described as follows:

1. Imagine that the arcs of D is a circular thread, and that there is a nail in every node $s \in \mathcal{S}$ corresponding to an input string.
2. We apply gravitation to the thread, i.e., we replace every pair of arcs $(\text{pref}(v), v), (v, \text{suff}(v))$ with a pair $(v, \text{pref}(\text{suff}(v))), (\text{pref}(\text{suff}(v)), \text{suff}(v))$, where a and b are symbols and s is a string. We call this *collapsing*, see Figure 6.

Formally, after doubling every arc of D , we start processing the nodes of the hierarchical graph level by level in the descending order, and in the lexicographic order on every level. If for the current node v there is a pair of arcs $(\text{pref}(v), v), (v, \text{suff}(v)) \in D$, we replace it by a pair of arcs $(\text{pref}(v), \text{pref}(\text{suff}(v))), (\text{pref}(\text{suff}(v)), \text{suff}(v))$ if D remains to be a solution (i.e., it is still connected). There is one exception for this: if $|v| = 1$, then $\text{pref}(\text{suff}(v))$ is undefined and we just remove the pair of arcs. A formal pseudocode of this collapsing procedure is given in Algorithm 3. This way, the algorithm drops down all arcs of the doubled set D that are not needed for connectivity. See Algorithm 4 for a formal pseudocode.



Figure 6: Collapsing a pair of arcs is replacing a pair of dashed arcs with a pair of solid arcs: general case (left) and example (right). The “physical meaning” of this transformation is that to get **bac** from **aba** one needs to cut **a** from the beginning and append **c** to the end and these two operations commute.

When $l > 1$, the collapsing procedure does not change the total length of D . What one normally sees at the beginning of the $l = 1$ iteration is a solution with many redundant pairs of arcs of the

Algorithm 3 Collapse

Input: hierarchical graph $HG(V, E)$, solution D , node $v \in V$.

- 1: **if** $(\text{pref}(v), v), (v, \text{suff}(v)) \in D$ **then**
 - 2: $D \leftarrow D \setminus \{(\text{pref}(v), v), (v, \text{suff}(v))\}$
 - 3: **if** $|v| > 1$ **then**
 - 4: $D \leftarrow D \cup \{(\text{pref}(v), \text{pref}(\text{suff}(v))), (\text{pref}(\text{suff}(v)), \text{suff}(v))\}$
-

Algorithm 4 Collapsing Algorithm (CA)

Input: hierarchical graph $HG(V, E)$, solution D .

Output: solution D' : $|D'| \leq |D|$

- 1: **for** level l in HG in descending order **do**
 - 2: **for** all $v \in V$ s.t. $|v| = l$ in lexicographic order: **do**
 - 3: **while** $(\text{pref}(v), v), (v, \text{suff}(v)) \in D$ and collapsing it does not make D disconnected **do**
 - 4: $\text{COLLAPSE}(HG, D, v)$
 - 5: return D
-

form $(a, \varepsilon), (\varepsilon, a)$. It is exactly this stage of the algorithm where the total length of D is decreased by the collapsing procedure. Figures 7 and 8 illustrate the action of the Collapsing Algorithm in the cases where D is an optimal and naive solution, respectively.

Collapsing Superstring Conjecture. *For any set of strings \mathcal{S} and for any solution D of \mathcal{S} ,*

$$CA(HG(\mathcal{S}), D \sqcup D) = GHA(\mathcal{S}) .$$

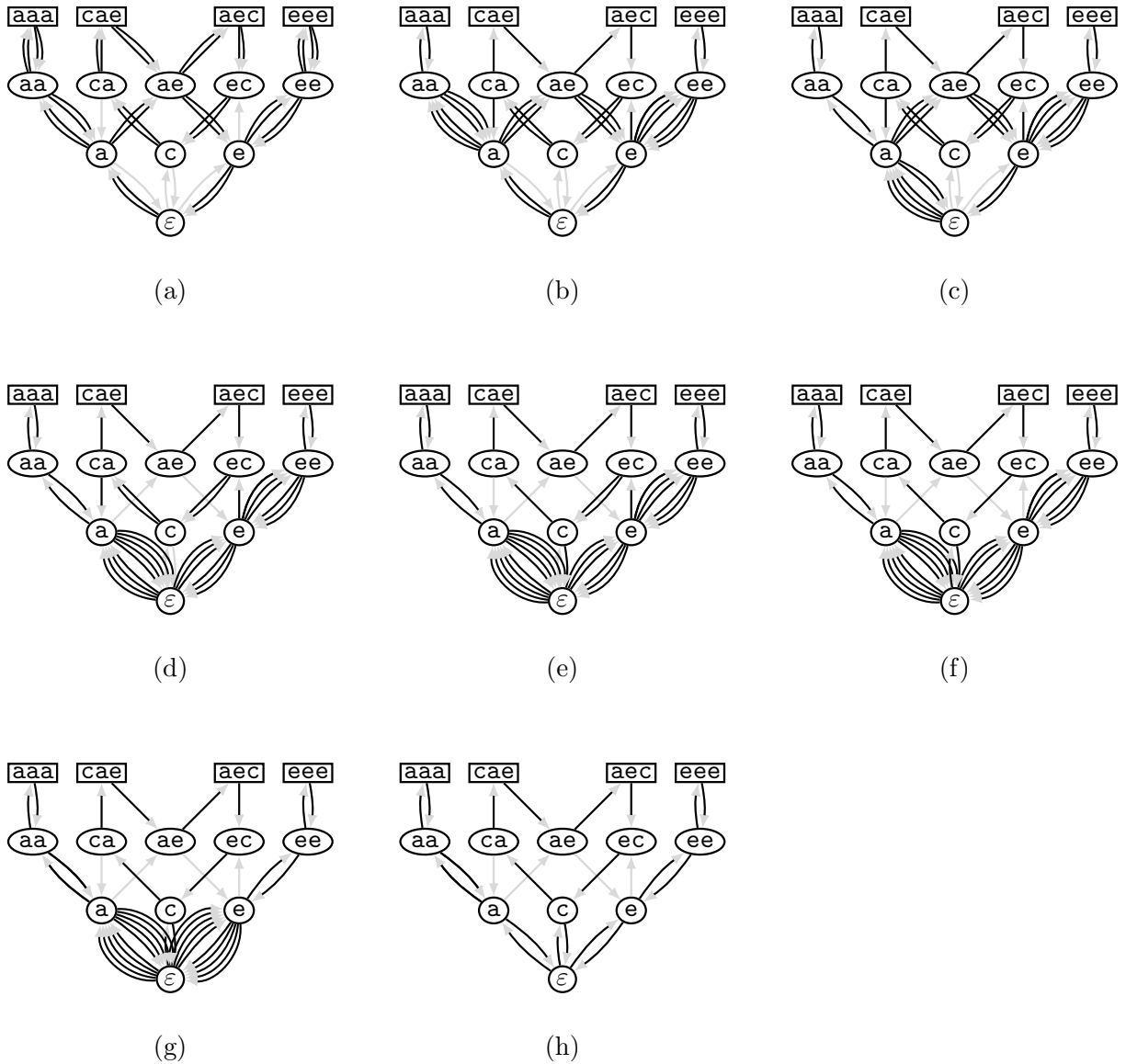

Figure 7: Stages of applying the Collapsing Algorithm to the dataset $\{aaa, cae, aec, eee\}$ and its **optimal** solution. (a) We start by doubling every arc of the optimal solution from Figure 3(c). (b) After collapsing all nodes at level $l = 3$. (c) After processing the node aa at level $l = 2$. Note that the algorithm leaves a pair of arcs $(a, aa), (aa, a)$ as they are needed to connect the component $\{aa, aaa\}$ to the rest of the solution. (d) After processing the ae node. The algorithm collapses all pairs of arcs for this node as it lies in the same component as a node c . (e) After processing the ca node. (f) After processing the ec node. (g) After processing the ee node. Note that at this point the solution has exactly the same length as at the very beginning (at stage (a)). (h) Finally, after collapsing all the unnecessary pairs of arcs from the level $l = 1$. The resulting solution is the same as constructed by the Greedy Hierarchical Algorithm (Figure 4(c)).

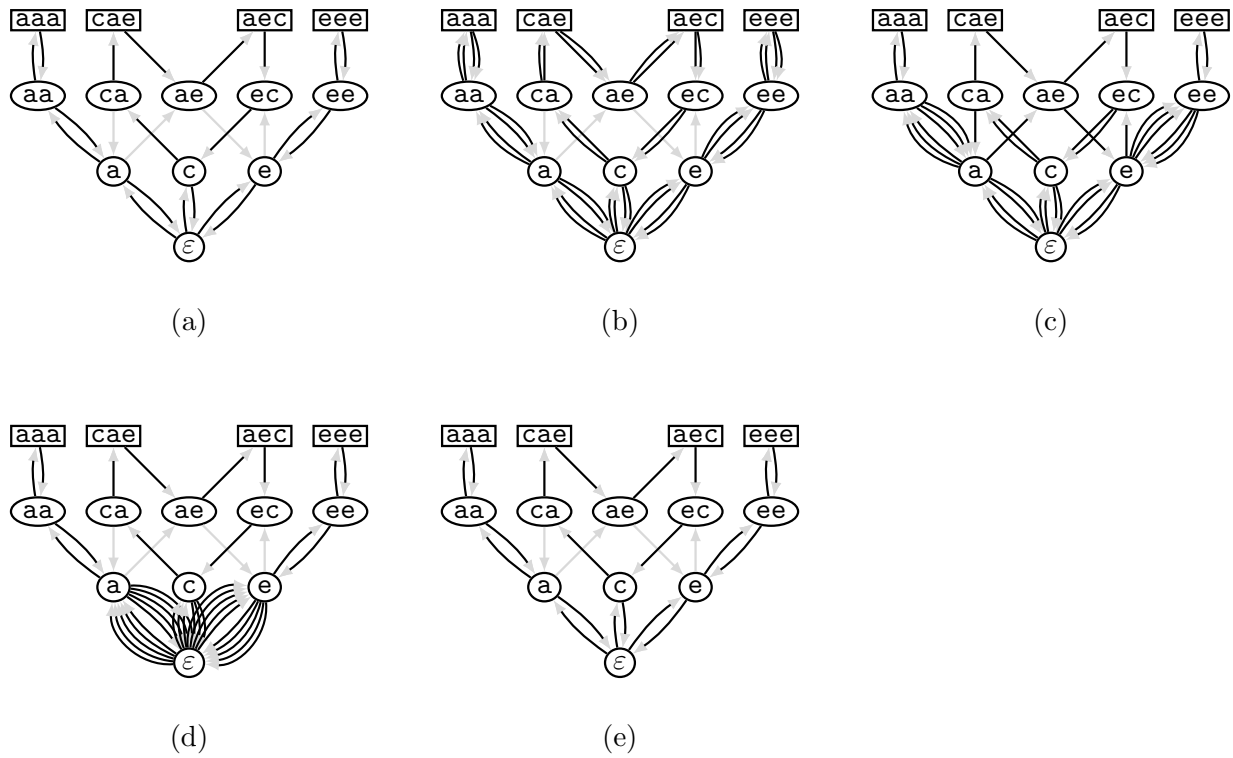

Figure 8: Stages of applying the Collapsing Algorithm to the dataset $\{aaa, cae, aec, eee\}$ and its **naive** solution resulting from overlapping the input strings in the same order as they are given. (a) The solution of length 10 corresponding to the superstring $aacaeeeee$. (b) The doubled solution. (c) After collapsing the $l = 3$ level. (d) After collapsing the $l = 2$ level. (e) After collapsing the $l = 1$ level. The resulting solution is the same as constructed by the Greedy Hierarchical Algorithm (Figure 4(c)).

4.2 Proof of the Special Case: Strings of Length 3

In Sections 4.2–4.4 we prove the Collapsing Superstring Conjecture for strings of length at most 3.

The Collapsing Algorithm (CA) starts with D equal to a doubled (arbitrary) solution, and the Greedy Hierarchical Algorithm (GHA) starts with an empty solution. Then both algorithms consider all vertices of the hierarchical graph $HG = (V, E)$ in the same order (descending order of the levels, lexicographic order within a level). Let s_0 be the first vertex considered by CA and GHA (s_0 corresponds to an input string). For a vertex s , by $V(s)$ we denote the set consisting of s and all the vertices that we processed before s .

Both algorithms continuously change their partial solutions. By D_{cl} and D_{gr} we denote the set of arcs included in the partial solutions D of the algorithms CA and GHA right before they start examining the vertex s . Let $G_{cl} = (V, D_{cl}), G_{gr} = (V, D_{gr})$, where V is the set of vertices of the hierarchical graph HG .

Finally, for CA we define the set $D_{cl}(s)$, consisting of arcs of D_{cl} which are incident to at least one vertex from $V(s) \setminus \{s\}$ (recall that D_{cl} is the set of arcs strictly before the examination of the vertex s). For convenience, for GHA we define $D_{gr}(s)$ in the same way, but note that since GHA always adds arcs adjacent to the vertex it is currently considering, $D_{gr}(s) = D_{gr}$.²

Let us sort all vertices of V in the order in which the two algorithms process them, and let s and t be two consecutive vertices in this order. Now look at the two algorithms processing the vertex s . CA and GHA both only change arcs below s . Since $D_{cl}(t)$ and $D_{gr}(t)$ only include the arcs incident to vertices from $V(t)$, the following holds for both algorithms:

$$D(t) = D(s) \sqcup \bigsqcup_{i=1}^a (\text{pref}(s), s) \sqcup \bigsqcup_{j=1}^b (s, \text{suff}(s)) \quad (2)$$

for some non-negative integers a and b .

In Sections 4.3–4.4 we will prove the following lemma.

Lemma 3. *Let \mathcal{S} be a set of strings of length at most 3. For each vertex s at a level at least 1, if the collapsing algorithm after its examination leaves a arcs $(\text{pref}(s), s)$ and b arcs $(s, \text{suff}(s))$, and the greedy algorithm leaves a_{gr} and b_{gr} arcs, respectively, then $a = a_{gr}, b = b_{gr}$.*

Now we are ready to complete the proof of Collapsing Superstring Conjecture for strings of length at most 3. Note that this also implies that the Greedy Hierarchical Superstring Conjecture holds for the case of strings of length at most 3.

Theorem 1. *For any set \mathcal{S} of strings of length at most 3 and for any superstring C of \mathcal{S} ,*

$$CA(HG(\mathcal{S}), C \sqcup C) = GHA(\mathcal{S}) .$$

Proof. We will prove that

$$\forall s \in V: D_{cl}(s) = D_{gr}(s) .$$

For $s = \varepsilon$, this statement implies the Collapsing Superstring Conjecture, as it asserts that the two algorithms end up with the same multiset of arcs.

²On the other hand, D_{cl} does not necessarily equal $D_{cl}(s)$, because D_{cl} initially consists of arcs connecting all vertices from \mathcal{S} to ε .

We prove this statement by induction on s , where s starts with s_0 and goes through all the vertices of HG in the same order as CA and GHA. The base case $s = s_0$ of the induction argument follows trivially from the definition: $D_{cl}(s_0) = D_{gr}(s_0) = \emptyset$. And the induction step is proven in Lemma 3. \square

4.3 Proof of Lemma 3

We prove Lemma 3 in two steps. The first step (Section 4.3), which works for strings of arbitrary length, shows that the lemma may not hold only in one case. The second step, presented in Section 4.4, shows that for strings of length at most 3 this case does not occur.

First we show that CA can never leave at least 2 up-arcs to s and at least 1 down-arc from s (or vice versa), because in this case it should have applied the Collapse procedure.

Lemma 4. *The cases $a \geq 2, b \geq 1$ and $a \geq 1, b \geq 2$ do not occur.*

Proof. In both cases, the collapsing algorithm has the ability to make at least one collapse at the vertex s . We will show that this collapse is correct, that is, a and b must be reduced by at least one. To this end, it suffices to prove that s , $\text{pref}(s)$ and $\text{suff}(s)$ remain weakly connected after the collapse.

Assume that the level of s is at least 2. Then after the collapse, vertices $\text{pref}(s)$ and $\text{suff}(s)$ will still be weakly connected through the vertex $\text{pref}(\text{suff}(s)) = \text{suff}(\text{pref}(s))$. Since either $a \geq 2$ or $b \geq 2$, the vertex s will remain weakly connected with $\text{pref}(s)$ or $\text{suff}(s)$, and, hence, with both of these vertices (see an example in Figure 9).

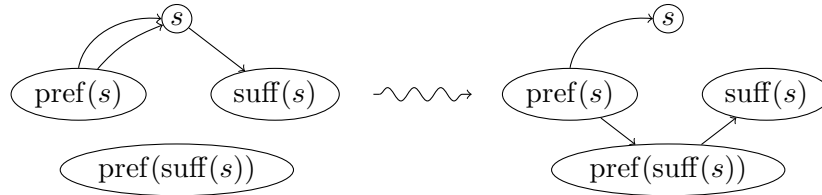

Figure 9: Collapsing the arcs $(\text{pref}(s), s), (s, \text{suff}(s))$ in the case $a \geq 2, b \geq 1$. After collapsing, s is still weakly connected to $\text{suff}(s)$.

Now assume that the level of s is 1. Then $\text{pref}(s) = \text{suff}(s) = \varepsilon$, and after the collapse, s and ε will still be connected. \square

From Lemma 4, we only need to consider four cases:

Case 1: $a > 0, b = 0$;

Case 2: $a = 0, b > 0$;

Case 3: $a = 0, b = 0$;

Case 4: $a = 1, b = 1$.

By the induction hypothesis, we can assume that $D_{cl}(s) = D_{gr}(s)$. This means, in particular, that the sets of arcs in which s is the lowest vertex coincide in both algorithms, because all vertices

with strictly higher levels have already been examined. Since the balance of the vertex s in both algorithms must eventually become 0, the arcs in which s is the top vertex must contribute the same value to the balance of s in both algorithms. In other words,

$$a - b = a_{gr} - b_{gr} .$$

Therefore, it suffices to prove only one of the equalities $a = a_{gr}$ or $b = b_{gr}$.

Cases 1 and 2. In these cases we have $a - b \neq 0$. From $a_{gr} - b_{gr} = a - b$, we get $a_{gr} - b_{gr} \neq 0$. This means that before considering the vertex s , GHA has $\text{upper-indegree}(s) \neq \text{upper-outdegree}(s)$, and it adds arcs in Step 6. GHA either adds $|a - b|$ arcs coming to s if $a > b$ (Case 1), or adds $b - a$ arcs leaving s if $a < b$ (Case 2). Either way, in the first case we have $b_{gr} = 0$, and in the second case $a_{gr} = 0$, as required.

In the two remaining cases we have $a = b$. This means that GHA during the examination of s either adds two arcs $(\text{pref}(s), s), (s, \text{suff}(s))$ in Step 11, or does not change the current partial solution.

Case 3. We need to show that GHA will not add any arcs while examining the vertex s . Suppose, to the contrary, that it adds two arcs $(\text{pref}(s), s), (s, \text{suff}(s))$. This happens if and only if all other vertices in the weakly connected component of s are already examined. In other words, if we denote the weakly connected component of s in G_{gr} by $C_{gr}(s)$, then $C_{gr}(s) \subset V(s)$.

Now we denote the weakly connected component of s in G_{cl} by $C_{cl}(s)$ and show that $C_{cl}(s) = C_{gr}(s)$. Since $\varepsilon \notin C_{gr}(s)$, this means that in the course of the Collapsing Algorithm, we get a weakly connected component that does not contain ε , which is impossible by the definition of CA, and leads to a contradiction.

Let $v \in C_{gr}(s)$. Hence, in G_{gr} there exists a weak path from s to v which contains only arcs from $D_{gr}(s)$, because there are no other arcs in the graph G_{gr} . By the induction hypothesis, $D_{cl}(s) = D_{gr}(s)$. Hence, in G_{cl} there is also a weak path from s to v , and therefore $v \in C_{cl}(s)$.

Let $v \in C_{cl}(s)$. Hence, in G_{cl} there is a weak path from s to v . If it contains only arcs from $D_{cl}(s) = D_{gr}(s)$, then it connects s with v in G_{gr} , and then $v \in C_{gr}(s)$. Suppose that there exists an arc in this path which does not belong to $D_{cl}(s)$. Let (t, u) be the first such arc.

Hence both vertices t and u do not lie in $V(s) \setminus \{s\}$. We also note that $t \neq s$. Indeed, otherwise, either $u = \text{suff}(s)$ or $u = s + c$ for some symbol c (where $+$ denotes string concatenation). But $b = 0$ forbids the first case, and in the second case $(s, s + c) \in D_{cl}(s)$. Therefore, $t \notin V(s)$.

Since (t, u) is the first arc on the path that does not lie in $D_{cl}(s)$, all the arcs in the path before it lie in $D_{cl}(s)$. Let (r, t) be the last such arc. Since $D_{cl}(s) = D_{gr}(s)$, the entire path from s to t lies in $D_{gr}(s)$, therefore $t \in C_{gr}(s)$. But we just showed that $t \notin V(s)$, which contradicts $C_{gr}(s) \subset V(s)$.

This finishes the proof of $C_{cl}(s) = C_{gr}(s)$, which implies that $a_{gr} = b_{gr} = 0$ in Case 3.

Case 4. We will prove that if CA leaves two arcs $(\text{pref}(s), s)$ and $(s, \text{suff}(s))$ after the examination of s , then GHA during its examination of s adds these two arcs, too. As it was previously noted, GHA will add these two arcs if and only if all the other vertices in the weakly connected component of s have already been examined. So, in this case we need to prove that $C_{gr}(s) \subset V(s)$.

Assume towards a contradiction that there is $t \in C_{gr}(s) \setminus V(s)$.

Let us denote by $C'_{cl}(s)$ the weakly connected component of s in the graph

$$G'_{cl} = (V, D_{cl} \setminus \{(\text{pref}(s), s), (s, \text{suff}(s))\}) .$$

In the same way as in Case 3, it implies that $C_{gr}(s) \subset C'_{cl}(s)$. Hence,

$$\exists t \in C'_{cl}(s) \setminus V(s). \quad (3)$$

In Section 4.4 we will show that (3) does not happen for SCS on strings of length at most 3.

4.4 Case Analysis

We denote the level of the vertex s by $\text{level}(s)$, and consider the three possible values of $\text{level}(s)$.

Analysis of vertices at the level 3. In this case $s \in \mathcal{S}$, and the vertex s is incident only to the arcs $(\text{pref}(s), s)$ and $(s, \text{suff}(s))$. The Collapse procedure leaves only one instance of each such arc. Hence, in the graph G'_{cl} , $C'_{cl}(s) = \{s\}$. This implies that (3) does not hold in this case.

Analysis of vertices at the level 2. Assume $C'_{cl}(s) \setminus V(s) \neq \emptyset$. Choose a vertex $t \in C'_{cl}(s) \setminus V(s)$ with the shortest weak path to s . Let $P = v_1 - v_2 - \dots - v_n$ be a weak path from s to t . In particular, $s = v_1$ and $t = v_n$.

Note that if $\text{level}(u) = 1$, then $u \notin V(s)$. Then $\text{level}(v_i) \geq 2$ holds for $i < n$, since otherwise there would be a vertex with a shorter weak path to s . Since for every arc (c, d) of the hierarchical graph $|\text{level}(c) - \text{level}(d)| = 1$, the levels of the vertices (possibly except the last one) of the path P alternate as follows: $\text{level}(v_1) = 2, \text{level}(v_2) = 3, \text{level}(v_3) = 2, \dots$. See an example of P in Figure 10.

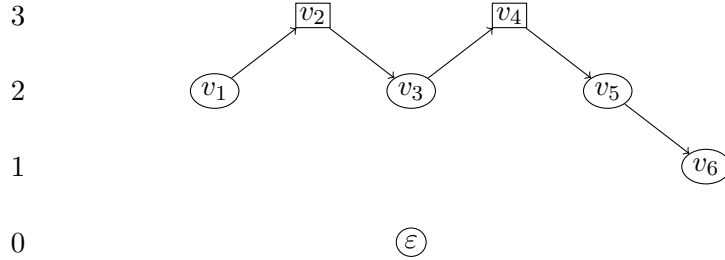

Figure 10: An example of a path P for $n = 6$.

For a vertex v_{2k} at the $\text{level}(v_{2k}) = 3$, let us denote by $u_{2k} = \text{pref}(\text{suff}(v_{2k}))$. The meaning of this vertex is that the pair of arcs $(v_{2k-1}, v_{2k}), (v_{2k}, v_{2k+1})$ can potentially be collapsed into $(v_{2k-1}, u_{2k}), (u_{2k}, v_{2k+1})$. Recall that we are considering Case 4 which means $a = b = 1$, and $s = v_1$ has an up-arc and a down-arc. That is, G_{cl} contains arcs (u_0, v_1) and (v_1, u_2) , where $u_0 = \text{pref}(s)$ and $u_2 = \text{suff}(s)$.

Also, for a pair of arcs (u_{2k}, v_{2k+1}) and (v_{2k+1}, u_{2k+2}) in the graph, let $u_{2k+1} = \text{pref}(\text{suff}(v_{2k+1}))$. Again, the arcs (u_{2k}, v_{2k+1}) and (v_{2k+1}, u_{2k+2}) could potentially be collapsed into (u_{2k}, u_{2k+1}) and (u_{2k+1}, u_{2k+2}) .

Since the arcs (v_{2k-1}, v_{2k}) and (v_{2k}, v_{2k+1}) are the only ones that are incident to the vertex $v_{2k} \in \mathcal{S}$ in the hierarchical graph, the initial (doubled) solution had two copies of each of them. Moreover, since $\text{level}(s) = 2$, all the vertices of the level 3 have already been examined, and therefore at least one collapse has been performed from each vertex v_{2k} at the level 3. Thus, at some point the graph contained the arcs (v_{2k-1}, u_{2k}) and (u_{2k}, v_{2k+1}) (see Figure 11 for an example).

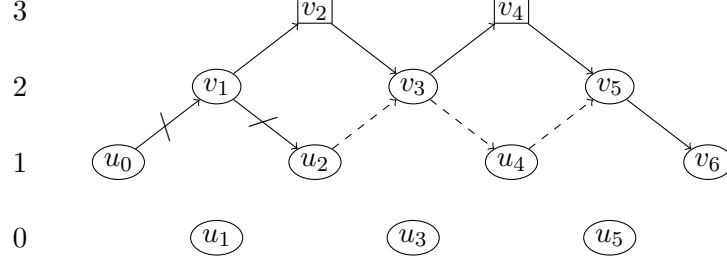

Figure 11: An example of arrangement of the vertices v_i and u_i for $n = 6$. Note that $u_1 = u_3 = u_5 = \varepsilon$. The graph contained the dashed arcs at some point. Removal of arcs $(u_0, v_1), (v_1, u_2)$ would violate weak connectivity of the graph.

Now we will use the fact that the pair of arcs (u_0, v_1) and (v_1, u_2) has not been collapsed. This means that after this collapse, the graph would loose weak connectivity. Note that $u_1 = \varepsilon$; after the collapse u_0 and u_2 would be weakly connected through ε . This means that the weak connectivity could only be violated because there is no other weak path between v_1 and u_2 .

Claim 1. For all k such that $3 \leq 2k + 1 \leq n$ at least one collapse was performed at the vertex v_{2k+1} .

Proof. Suppose that at least one collapse is made at the vertex $v_{2k'+1}$ for all k' such that $3 \leq 2k'+1 < 2k+1$, and the vertex v_{2k+1} was not collapsed. This means that the arc (u_{2k}, v_{2k+1}) belongs to the graph at the current iteration.

By definition, after a collapse from the vertex $v_{2k'+1}$, a pair of arcs $(u_{2k'}, u_{2k'+1}), (u_{2k'+1}, u_{2k'+2})$ is added to the graph. Moreover, any of these arcs can disappear from the graph only after a collapse from the vertex $u_{2k'+1}$. But $\text{level}(u_{2k'+1}) = 1$, and therefore it has not yet been visited by the Collapsing Algorithm. Therefore, both arcs belong to the graph at the current iteration.

Then there exists a weak path Q in the graph of the following form:

$$Q = v_1 - v_2 - \dots - v_{2k+1} - u_{2k} - u_{2k-1} - \dots - u_2.$$

It means that v_1 and u_2 are weakly connected, which leads to a contradiction. \square

From Claim 1 we know that each v_{2k+1} was collapsed. This implies that at the current iteration, for every k such that $3 \leq 2k + 1 \leq n$, the graph contains the weak path $u_2 - \dots - u_{2k} - u_{2k+1}$. We will now show that v_1 and u_2 are weakly connected. To this end, we consider two cases $\text{level}(v_n) = 2$ and $\text{level}(v_n) = 1$.

If $\text{level}(v_n) = 1$, then, since every vertex v_{2k+1} was collapsed at least once, there exist arcs (u_{n-2}, u_{n-1}) and (u_{n-1}, v_n) in the graph. Hence, there exists a weak path of the form $v_1 - v_2 - \dots - v_n - u_{2k+1} - \dots - u_3 - u_2$, and the vertices v_1 and u_2 are weakly connected (see an example in Figure 12).

If $\text{level}(v_n) = 2$, then $n = 2k + 1$ for some k . Hence, by Claim 1, at least one collapse was made from the vertex v_{2k+1} . On the other hand, the vertex $v_{2k+1} \notin V(s)$ (since we chose $t = v_n = v_{2k+1}$ as a vertex not from $V(s)$). Since v_{2k+1} has not been examined yet, it could not be collapsed yet (see an example in Figure 13).

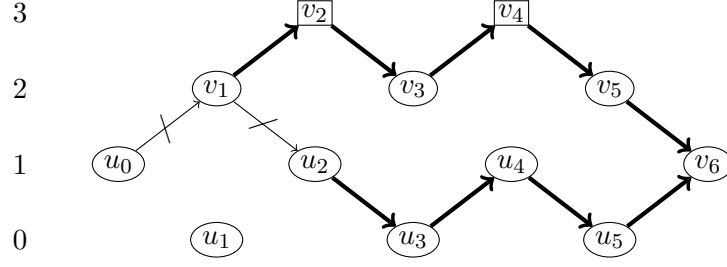

Figure 12: A weak path connecting v_1 and u_2 for $n = 6$.

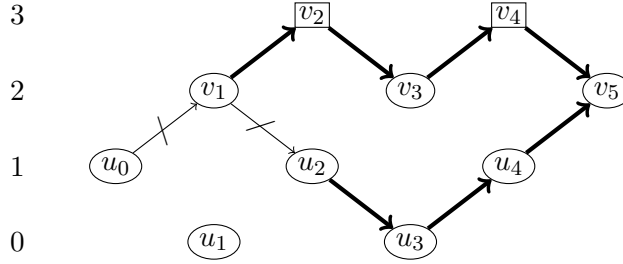

Figure 13: A weak path connecting v_1 and u_2 for $n = 5$.

Analysis of vertices at the level 1. In this case, all the vertices at the levels 2 and 3 are already considered.

Note that the collapse from the vertex s can potentially violate only the connectivity of s and ε . Therefore $\varepsilon \notin C'_{cl}(s)$. Let us take an arbitrary vertex $t \in C'_{cl}(s) \setminus V(s)$. Since the vertices at levels 2 and 3 have been considered by CA, $\text{level}(t) = 1$.

Since t is weakly connected to s , the vertex t is incident to at least one arc. But it cannot be connected with the vertex at the level 0, because only ε is located at this level, and $\varepsilon \notin C'_{cl}(s)$. Hence, t is incident to at least one arc leading to the level 2. Moreover, since $\text{indegree}(t) = \text{outdegree}(t)$, at least one arc from level 2 comes to t , and at least one such arc leaves t .

We will identify vertices with the strings they correspond to. In particular, t corresponds to some string \mathbf{b} consisting of one symbol. We have just shown that there are arcs $(\mathbf{x}\mathbf{b}, \mathbf{b})$ and $(\mathbf{b}, \mathbf{bc})$ for some symbols \mathbf{x} and \mathbf{c} .

First we prove several auxiliary claims.

Claim 2. *The Collapsing Algorithm did not have the arc $(\mathbf{b}, \varepsilon)$ nor $(\varepsilon, \mathbf{b})$ in its partial solution at any previous iteration.*

Proof. If the partial solution of CA had one of these arcs, then it could lose it only after the collapse in the vertex \mathbf{b} . Since this vertex \mathbf{b} has not been examined yet, this arc must still be in the current solution. But this would imply that $\varepsilon \in C'_{cl}(s)$, and lead to a contradiction. \square

Claim 3. *Let \mathbf{a} be an arbitrary symbol. If any of the arcs $(\mathbf{ba}, \mathbf{a})$, $(\mathbf{b}, \mathbf{ba})$, or $(\mathbf{ab}, \mathbf{b})$ was in the partial solution of CA at a previous step, then it still belongs to the partial solution until this iteration.*

Proof. We show a proof for the arc (ba, a) , and the proofs for (b, ba) and (ab, b) are analogous. Note the arc (ba, a) can only be collapsed with the arc (b, ba) . Then, if a collapse actually occurs at the vertex ba , it creates the arc (b, ε) . By Claim 2, there never was any such arc in the graph. \square

Lemma 5. *At the current iteration, there is exactly one copy of the arc (b, bc) .*

Proof. From the discussion above, we know that there must be at least one copy of the arc (b, bc) . Assume that there are at least two such arcs. Then at least two arcs must leave bc .

Suppose that there exists at least one arc (bc, c) . Then, if we make a collapse at the vertex bc , the vertices b , c , and bc still remain weakly connected by the arcs (b, bc) , (b, ε) , and (ε, c) . Hence, this collapse is valid (see Figure 14), but the collapsing algorithm during the examination of the vertex bc did not collapse it. This leads to a contradiction, so there is no arc (bc, c) in the graph.

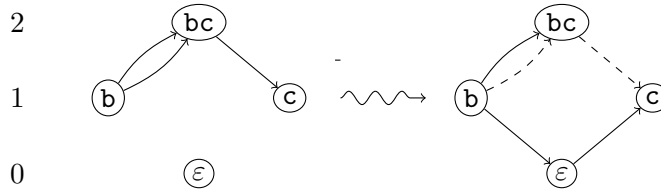

Figure 14: Correctness of the collapse in the case when the graph contains the arc (bc, c) .

Therefore, there is at least one arc (bc, bcd) . Then $bcd \in \mathcal{S}$ must be an input string. Therefore, the original graph contained two copies of the arcs (bc, bcd) and (bcd, cd) . So, at least one collapse was done in the vertex bcd , and it created the arc (bc, c) . But at the current iteration the arc (bc, c) does not exist, so it was also collapsed. This contradicts Claim 3. \square

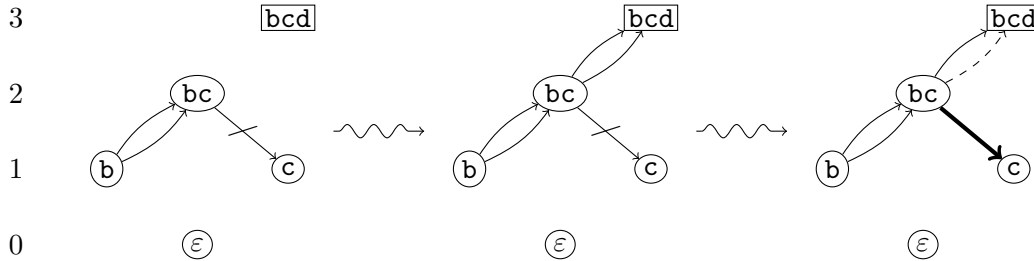

Figure 15: The scheme of the proof of Lemma 5.

Claim 4. *The vertex bc is weakly connected to at least one vertex at the level 3.*

Proof. Assume towards a contradiction that bc is not connected to vertices at level 3. Then bc can only be incident to arcs (b, bc) and (bc, c) . By Lemma 5, there is only one copy of the arc (b, bc) . Hence, there is exactly one copy of the arc (bc, c) . In this case, the Collapsing Algorithm had to collapse this pair of arcs when examining bc (because this operation would only separate bc from all other vertices without violating the connectivity of ε and \mathcal{S}). This contradiction implies that the vertex bc is connected to a vertex on the level 3. \square

By Claim 4, either there exists d such that there is an arc (bc, bcd) , or there is a symbol a such that there is an arc (abc, bc) . Suppose there is no such a , which implies that there must be some d .

Then $bcd \in \mathcal{S}$, and, therefore, initially there were two copies of the arcs (bc, bcd) and (bcd, cd) in the graph. So, at least one collapse was made at the vertex bcd , and it created the arc (bc, c) . The arc (bc, c) could not be collapsed by Claim 3. Hence, some other arc must come to bc , and, by Lemma 5, it cannot be another copy of (b, bc) .

Hence, there is an a such that there is an arc (abc, bc) . Then $abc \in \mathcal{S}$, and from abc exactly one collapse was made, which created two arcs (ab, b) and (b, bc) , which were not collapsed until now by Claim 3.

Therefore, bc contains at least two arcs: (abc, bc) and (b, bc) . Hence, at least two arcs leave bc .

Claim 5. *At the current iteration, there is at least one arc (bc, c) .*

Proof. Assume there is no arc (bc, c) . Then, since at least one arc must leave bc , it is an arc of the form (bc, bcd) . So, $bcd \in \mathcal{S}$. Again, initially the graph contained two instances of the arcs (bc, bcd) and (bcd, cd) , and there was made at least one collapse at the vertex bcd . This collapse created the arc (bc, c) , a contradiction. \square

So, by Lemma 5, there is one arc (b, bc) in the graph, and by Claim 5 there is at least one arc (bc, c) .

We will now show that this pair of arcs should have been collapsed, which will contradict Claim 3. Indeed, even after this collapse, there will be weak paths $b - \varepsilon - c$ and $b - ab - abc - bc$, and hence the connectivity of the vertices b , c and bc will be preserved (see Figure 16).

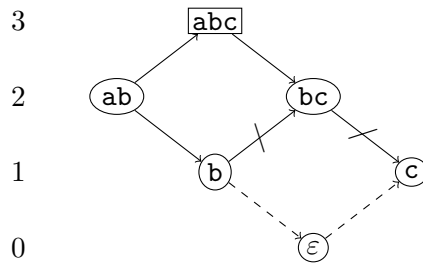

Figure 16: After the collapse at the vertex bc , the vertices b , c and bc will still belong to one weakly connected component. The removed arcs are crossed out, and the new arcs are dashed.

This completes the proofs of Lemma 3 and Theorem 1.

5 Further Directions and Open Problems

One natural open problem is to prove the Collapsing Superstring Conjecture. It would also be interesting to find other applications of the hierarchical graphs. We list two such potential applications below.

Genome assembly. As we illustrated, the hierarchical graph in a sense generalizes de Bruijn graph. The latter one is heavily used in genome assembly [PTW01]. Can one adopt the hierarchical graph for this task? For this, one would need to come up with a compact representation of the graph (as datasets in genome assembly are massive) as well as with a way of handling errors in the input data. Cazaux and Rivals [CR18a] propose a linear-space counterpart of the hierarchical graph.

Exact algorithms. Can one use hierarchical graphs to solve SCS exactly in time $(2 - \varepsilon)^n$? It was shown in Section 1 that the SCS problem is a special case of the Traveling Salesman Problem. The best known exact algorithms for Traveling Salesman run in time $2^n \text{poly}(|\text{input}|)$ [Bel62, HK71, KGK77, Kar82, BF96]. These algorithms stay the best known for the SCS problem as well. The hierarchical graphs were introduced [GKM14] for an algorithm solving SCS on strings of length at most r in time $(2 - \varepsilon)^n$ (where ε depends only on r). Can one use the hierarchical graph to solve exactly the general case of SCS in time $(2 - \varepsilon)^n$ for a constant ε ?

References

- [Bel62] Richard Bellman. Dynamic Programming Treatment of the Travelling Salesman Problem. *J. ACM*, 9:61–63, 1962.
- [BF96] Eric Bax and Joel Franklin. A Finite-Difference Sieve to Count Paths and Cycles by Length. *Inf. Process. Lett.*, 60:171–176, 1996.
- [BJL⁺91] Avrim Blum, Tao Jiang, Ming Li, John Tromp, and Mihalis Yannakakis. Linear approximation of shortest superstrings. In *STOC 1991*, pages 328–336. ACM, 1991.
- [CJR18] Bastien Cazaux, Samuel Juhel, and Eric Rivals. Practical lower and upper bounds for the shortest linear superstring. In *SEA 2018*, volume 103, pages 18:1–18:14. LIPIcs, 2018.
- [CR18a] Bastien Cazaux and Eric Rivals. Hierarchical overlap graph. *arXiv preprint arXiv:1802.04632*, 2018.
- [CR18b] Bastien Cazaux and Eric Rivals. Relationship between superstring and compression measures: New insights on the greedy conjecture. *Discrete Appl. Math.*, 245:59–64, 2018.
- [Gal82] J. K. Gallant. *String compression algorithms*. PhD thesis, Princeton, 1982.
- [git18] Collapsing superstring conjecture. Github repository. <https://github.com/alexanderskulikov/greedy-superstring-conjecture>, 2018.
- [GKM13] Alexander Golovnev, Alexander S Kulikov, and Ivan Mihajlin. Approximating shortest superstring problem using de Bruijn graphs. In *CPM 2013*, pages 120–129. Springer, 2013.
- [GKM14] Alexander Golovnev, Alexander S. Kulikov, and Ivan Mihajlin. Solving SCS for bounded length strings in fewer than 2^n steps. *Inf. Process. Lett.*, 114(8):421–425, 2014.
- [GMS80] John Gallant, David Maier, and James A. Storer. On finding minimal length superstrings. *J. Comput. Syst. Sci.*, 20(1):50–58, 1980.

- [GP14] Theodoros P. Gevezes and Leonidas S. Pitsoulis. *The shortest superstring problem*, pages 189–227. Springer, 2014.
- [HK71] Michael Held and Richard M. Karp. The Traveling-Salesman Problem and Minimum Spanning Trees. *Math. Program.*, 1:6–25, 1971.
- [Kar82] Richard M. Karp. Dynamic Programming Meets the Principle of Inclusion and Exclusion. *Oper. Res. Lett.*, 1(2):49–51, 1982.
- [KKG77] Samuel Kohn, Allan Gottlieb, and Meryle Kohn. A Generating Function Approach to the Traveling Salesman Problem. In *ACN 1977*, pages 294–300, 1977.
- [KS05] Haim Kaplan and Nira Shafrir. The greedy algorithm for shortest superstrings. *Inf. Process. Lett.*, 93(1):13–17, 2005.
- [KSS15] Alexander S Kulikov, Sergey Savinov, and Evgeniy Sluzhaev. Greedy conjecture for strings of length 4. In *CPM 2015*, pages 307–315. Springer, 2015.
- [LW05] Uli Laube and Maik Weinard. Conditional inequalities and the shortest common superstring problem. *Int. J. Found. Comput. Sci.*, 16(06):1219–1230, 2005.
- [Mon81] Gaspard Monge. Mémoire sur la théorie des déblais et des remblais. *Histoire de l’Académie Royale des Sciences de Paris*, 1781.
- [Muc07] Marcin Mucha. A tutorial on shortest superstring approximation, 2007.
- [Muc13] Marcin Mucha. Lyndon Words and Short Superstrings. In *SODA 2013*, pages 958–972. SIAM, 2013.
- [PTW01] Pavel A. Pevzner, Haixu Tang, and Michael S. Waterman. An eulerian path approach to DNA fragment assembly. *Proc. Natl. Acad. Sci. U.S.A.*, 98(17):9748–9753, 2001.
- [RBT04] Heidi J. Romero, Carlos A. Brizuela, and Andrei Tchernykh. An experimental comparison of two approximation algorithms for the common superstring problem. In *ENC 2004*, pages 27–34. IEEE, 2004.
- [RC18] Eric Rivals and Bastien Cazaux. Superstrings with multiplicities. In *CPM 2018*, volume 105, pages 21:1–21:16, 2018.
- [SG76] Sartaj Sahni and Teofilo Gonzalez. P-Complete Approximation Problems. *J. ACM*, 23:555–565, 1976.
- [Sto87] James A. Storer. *Data compression: methods and theory*. Computer Science Press, Inc., 1987.
- [STV18] Ola Svensson, Jakub Tarnawski, and László A Végh. A constant-factor approximation algorithm for the asymmetric traveling salesman problem. In *STOC 2018*, pages 204–213. ACM, 2018.
- [TU88] Jorma Tarhio and Esko Ukkonen. A greedy approximation algorithm for constructing shortest common superstrings. *Theor. Comput. Sci.*, 57(1):131–145, 1988.

- [Tur89] Jonathan S. Turner. Approximation algorithms for the shortest common superstring problem. *Inf. Comput.*, 83(1):1–20, 1989.
- [Ukk90] Esko Ukkonen. A linear-time algorithm for finding approximate shortest common superstrings. *Algorithmica*, 5(1-4):313–323, 1990.
- [Wat95] Michael S Waterman. *Introduction to computational biology: maps, sequences and genomes*. CRC Press, 1995.
- [web18] Collapsing superstring conjecture. Webpage. <http://compsciclub.ru/scs/>, 2018.
- [WS06] Maik Weinard and Georg Schnitger. On the greedy superstring conjecture. *SIAM J. Discrete Math.*, 20(2):502–522, 2006.