

On Computing the Multiplicity of Short Cycles in Bipartite Graphs Using the Degree Distribution and the Spectrum of the Graph

Ali Dehghan and Amir H. Banihashemi, *Senior Member, IEEE*

Department of Systems and Computer Engineering, Carleton University, Ottawa,
Ontario, Canada

Abstract

Counting short cycles in bipartite graphs is a fundamental problem of interest in the analysis and design of low-density parity-check (LDPC) codes. The vast majority of research in this area is focused on algorithmic techniques. Most recently, Blake and Lin proposed a computational technique to count the number of cycles of length g in a bi-regular bipartite graph, where g is the girth of the graph. The information required for the computation is the node degree and the multiplicity of the nodes on both sides of the partition, as well as the eigenvalues of the adjacency matrix of the graph (graph spectrum). In this paper, we extend this result in a number of directions. First, we derive a similar result to compute the number of cycles of length $g + 2, \dots, 2g - 2$, for bi-regular bipartite graphs. Second, using counter-examples, we demonstrate that the information of the degree distribution and the spectrum of a bi-regular bipartite graph is, in general, insufficient to count the cycles of length $i \geq 2g$. Third, we consider irregular bipartite graphs, and show that, in general, the information of degree distribution and spectrum alone is not enough to determine the number of cycles of length i (i -cycles), for any $i > g$, regardless of the value of g . We demonstrate that the same negative result also holds true for half-regular bipartite graphs, and is also applicable to counting g -cycles for $g \geq 6$ and $g \geq 8$, in irregular and half-regular graphs, respectively. As positive results, we compute the number of 4-cycles and 6-cycles in irregular and half-regular bipartite graphs, with $g \geq 4$ and $g \geq 6$, respectively, using only the degree distribution and the spectrum of the graph.

Index Terms: Counting cycles, cycle multiplicity, short cycles, bipartite graphs, Tanner graphs, low-density parity-check (LDPC) codes, bi-regular bipartite graphs, irregular bipartite graphs, half-regular bipartite graphs, girth.

I. INTRODUCTION

The performance of low-density parity-check (LDPC) codes under iterative message-passing algorithms is highly dependent on the structure of the code's Tanner graph, in general, and the distribution of short cycles, in particular, see, e.g., [1], [2], [3], [4], [5]. Cycles play a particularly important role in the error floor performance of LDPC codes, where they are the main substructure of the trapping sets [6], [7], [8], [9], [10], [11]. The close relationship between the performance of graph-based coding schemes and the cycle structure of the graph, especially the number of short cycles, has motivated a flurry of research activity on the study of cycle distribution and the counting of short cycles in bipartite graphs [3], [12], [13], [14], [15].

Counting cycles of a given length in a general graph is known to be NP-hard [16]. The problem remains NP-hard even for bipartite graphs [17]. Karimi and Banihashemi [13] proposed an efficient message-passing algorithm to count the number of cycles of length less than $2g$, in a general graph, where g is the girth of the graph. They also proposed a less complex algorithm for bipartite graphs with quasi-cyclic (QC) structure based on the relationship between the cycle multiplicities and the eigenvalues of the directed edge matrix of the graph [12]. Distribution of cycles in different ensembles of bipartite graphs was studied in [14]. It was shown in [14] that for random irregular and bi-regular bipartite graphs, the multiplicities of cycles of different lengths have independent Poisson distributions with the expected values only a function of the cycle length and the degree distribution, and independent of the block length.

The spectrum $\{\lambda_i\}$ of a graph G , defined as the eigenvalues of its adjacency matrix, is an important characteristic of G . It is known that $\sum_i \lambda_i = 0$, $\sum_i \lambda_i^2 = 2|E(G)|$, where $|E(G)|$ is the number of edges of G , and $\sum_i \lambda_i^3 = 6N_3(G)$, where $N_3(G)$ is the number of 3-cycles of G . The last result, however, cannot be extended to larger cycles, i.e., one cannot count cycles of length larger than 3 as a function of only the spectrum of the graph. For instance, the complete bipartite graph $K_{1,4}$ (with one node on one side and four nodes on the other side of the bipartition), and the graph $C_4 \cup K_1$ (the union of a 4-cycle and a single node) have the same spectrum $\{-2, 0, 0, 0, 2\}$, but they clearly have different number of 4-cycles. Recently, Blake and Lin [15] computed the multiplicity of cycles of length g in bi-regular bipartite graphs as a function of the spectrum of the graph plus the extra information about the number and the degree of the nodes on each side of the bipartition. In [15], it is stated: "While only cycles of length equal to the girth are considered here, it was originally hoped that a more detailed study would yield expressions for

cycle length $g + 2$ although this would involve more complex computations. The authors were unsuccessful in this but hope this work might lead other researchers to consider the problem which could lead to a more analytical approach to code design than has yet been possible.”

Inspired by [15], and in relation to the above statement, in this work, we extend the results of [15] to compute the number of cycles of length $g + 2, \dots, 2g - 2$, in bi-regular bipartite graphs in terms of the graph’s degree distribution and its spectrum. We also show that, in general, the multiplicity of cycles of length $i \geq 2g$ cannot be determined using only the graph’s spectrum and its degree distribution. Similarly, for irregular graphs, it is shown that the degree distribution and spectrum alone are, in general, insufficient to obtain the multiplicity of cycles of length $i > g$, for any value of g and $i > g$. We demonstrate the same (negative) result for half-regular graphs.¹ Moreover, we show that a similar result is applicable to counting g -cycles in irregular and half-regular bipartite graphs with $g \geq 6$ and $g \geq 8$, respectively. As positive results, we compute the multiplicity of 4-cycles in irregular graphs with $g \geq 4$, and 6-cycles in half-regular graphs with $g \geq 6$, in terms of the degree distribution and the spectrum of the graph.

The summary of our results regarding the possibility of computing the number of cycles of different length in different types of bipartite graphs (bi-regular, half-regular, and irregular) with different girth using only the spectrum and the degree distribution of the graph is presented in Table I. In this table, the notation “P” (“IP”) is used to mean that it is possible (impossible), in general, to find the multiplicity of cycles of a given length in a graph from the spectrum and the degree distribution of the graph.

The organization of the rest of the paper is as follows: In Section II, we present some definitions and notations. This is followed in Section III by our results on computing the number of cycles of length $g + 2, \dots, 2g - 2$, in bi-regular bipartite graphs using the spectrum and the degree distribution of the graph. Next, in Section IV, we construct two bi-regular bipartite graphs such that they have the same spectrum, degree distribution and girth, but different number of i -cycles for $i \geq 2g$. This demonstrates that, in general, it is not possible to determine the number of i -

¹A *half-regular* bipartite graph is defined as a bipartite graph whose nodes on one side of the partition all have the same degree. In the context of coding, the terms *variable nodes* and *check nodes* are used to identify the nodes on the two sides of the bipartition of a Tanner graph. In this context, variable nodes represent code symbols and check nodes represent parity-check equations, and a bipartite (Tanner) graph is called *variable-regular (check-regular)* if all the variable (check) nodes have the same degree. The results of this work on half-regular bipartite graphs are equally applicable to both variable-regular and check-regular graphs.

TABLE I

A SUMMARY OF OUR RESULTS ON THE POSSIBILITY OF COUNTING CYCLES OF LENGTH i IN BI-REGULAR, HALF-REGULAR AND IRREGULAR BIPARTITE GRAPHS WITH GIRTH g USING ONLY THE SPECTRUM AND THE DEGREE DISTRIBUTION OF THE GRAPH. (NOTATIONS “P” AND “IP” ARE USED FOR “POSSIBLE” AND “IMPOSSIBLE,” RESPECTIVELY.)

		$i = g$	$i = g + 2, g + 2, \dots, 2g - 2$	$i = 2g, 2g + 2, \dots$
Bi-regular	$g \geq 4$	P	P	IP
Half-regular	$g = 4$	P	IP	IP
	$g = 6$	P	IP	IP
	$g \geq 8$	IP	IP	IP
Irregular	$g = 4$	P	IP	IP
	$g \geq 6$	IP	IP	IP

cycles for $i \geq 2g$ in a bi-regular bipartite graph as a function of only the spectrum and the degree distribution of the graph. In Section V, we study the possibility of computing the multiplicity of short cycles of irregular bipartite graphs using only the spectrum and the degree distribution, and demonstrate through some graph constructions that the answer is generally negative, except for the case of $g \geq 4$, where we derive the number of 4-cycles as a function of graph spectrum and its degree distribution. In Section VI, we continue our study of computing the multiplicity of short cycles in half-regular bipartite graphs, and show that for all girths and cycle sizes, with the exception of 6-cycles in graphs with $g \geq 6$ (and 4-cycles in graphs with $g \geq 4$), the information of only the spectrum and the degree distribution is insufficient to count the cycles. Section VII is devoted to numerical results. The paper is concluded with some remarks in Section VIII.

II. DEFINITIONS AND NOTATIONS

For a given graph G , we denote the node set and the edge set of G by $V(G)$ and $E(G)$, respectively. The shorthands V and E are used if there is no ambiguity about the graph. In this work, we consider undirected graphs with no loops or parallel edges (i.e., simple undirected graphs). An edge $e \in E$ with endpoints $u \in V$ and $w \in V$ is denoted by $\{u, w\}$, or by uw or wu , in brief. The number of edges incident to a node v is called the *degree* of v , and is denoted by $d(v)$. For a given graph G , a *walk* of length k is a sequence of nodes v_1, v_2, \dots, v_{k+1} in V such that $\{v_i, v_{i+1}\} \in E$, for all $i \in \{1, \dots, k\}$. Equivalently, a walk of length k can be described by the corresponding sequence of k edges. Let $\mathcal{W} = v_1, v_2, \dots, v_{k+1}$ be a walk in the

graph G , we say that $\mathcal{W}' = v_{l_0}, v_{l_1}, \dots, v_{l_s}$, for $s \geq 1$, is a subwalk of \mathcal{W} if there is an index i , $1 \leq i \leq k - s + 1$, such that $v_i = v_{l_0}, v_{i+1} = v_{l_1}, \dots, v_{i+s} = v_{l_s}$. A walk v_1, v_2, \dots, v_{k+1} is a *path* if all the nodes v_1, v_2, \dots, v_k are distinct. A walk is called a *closed walk* if the two end nodes are the same, i.e., if $v_1 = v_{k+1}$. Under the same condition, a path is called a *cycle*. In the rest of the paper, the term “path” is used only to refer to the paths that are not cycles. We also use the notation P_n to denote a path with n nodes. The *length* of a walk, path or cycle is the number of its edges. We denote cycles of length k , also referred to as k -cycles, by C_k . We use N_k for $|C_k|$. The length of the shortest cycle(s) in a graph is called *girth* and is denoted by g .

A graph G is *connected*, if there is a path between any two nodes of G . If the graph G is not connected, we say that it is disconnected. A *connected component* of a graph is a connected subgraph such that there are no edges between nodes of the subgraph and nodes of the rest of the graph.

A graph $G = (V, E)$ is called *bipartite*, if the node set V can be partitioned into two disjoint subsets U and W , i.e., $V = U \cup W$ and $U \cap W = \emptyset$, such that every edge in E connects a node from U to a node from W . A graph is bipartite if and only if the lengths of all its cycles are even. Tanner graphs of LDPC codes are bipartite graphs, in which U and W are referred to as *variable nodes* and *check nodes*, respectively. Parameters n and m in this case are used to denote $|U|$ and $|W|$, respectively. Parameter n is the code’s block length and the code rate R satisfies $R \geq 1 - (m/n)$.

The *degree sequences* of a bipartite graph G are defined as the two monotonic non-increasing sequences of the node degrees on the two sides of the graph. For example, the complete bipartite graph $K_{2,3}$ has degree sequences $(3, 3)$ and $(2, 2, 2)$. Clearly, the degree sequences also contain the information about the number of nodes on each side of the graph. A bipartite graph $G = (U \cup W, E)$ is called *bi-regular*, if all the nodes on the same side of the bipartition have the same degree, i.e., if all the nodes in U have the same degree d_u and all the nodes in W have the same degree d_w . It is clear that, for a bi-regular graph, $|U|d_u = |W|d_w = |E(G)|$. A bipartite graph is called *half-regular*, if all the nodes on one side of the bipartition have the same degree. A half-regular Tanner graph can be either variable-regular or check-regular. A Tanner graph $G = (U \cup W, E)$ is called *variable-regular* with variable degree d_v , if for each variable node $u_i \in U$, $d_{u_i} = d_v$. Similarly, a Tanner graph is called *check-regular* with check degree d_c , if for each check node $w_i \in W$, $d_{w_i} = d_c$. Also, a (d_v, d_c) -regular Tanner graph is a bi-regular graph with variable degree d_v and check degree d_c . A bipartite graph that is not bi-regular is called

irregular. With this definition, half-regular graphs are a special case of irregular graphs.

A bipartite graph $G(U \cup W, E)$ is called *complete*, and is denoted by $K_{|U|,|W|}$, if every node in U is connected to every node in W . The notation K_m is used for a complete (non-bipartite) graph with m nodes (in which every node is connected to all the other nodes).

A *tree* is an undirected graph in which any two nodes are connected by exactly one path. Any connected graph is a tree if and only if it does not have any cycle. A *rooted tree* is a tree in which one node is designated as the root. In a given tree, a node v is called *leaf* if $d(v) = 1$. The *height* of a node in a rooted tree is the length of the longest downward path from that node to a leaf. The height of the tree is the height of the root.

Consider the graph $G = (V, E)$, and let $S \subset V$ be any subset of nodes of G . Then, the *node-induced subgraph* (or simply “induced subgraph”) on the set of nodes S is the graph whose node set is S and whose edge set consists of all the edges in E that have both endpoints in S . Similarly, an *edge-induced subgraph* on the set of edges $D \subset E$ is the graph that consists of the edges D together with any nodes that are the endpoints of the edges in D .

The *adjacency matrix* of a graph G is the matrix $A = [a_{ij}]$, where a_{ij} is the number of edges connecting the node i to the node j for all $i, j \in V$. Matrix A is symmetric and since we have assumed that G has no parallel edges or loops, $a_{ij} \in \{0, 1\}$, for all $i, j \in V$, and $a_{ii} = 0$, for all $i \in V$. The set of the eigenvalues $\{\lambda_i\}$ of A is called the *spectrum* of the graph. It is well-known that the spectrum of a disconnected graph is the disjoint union of the spectra of its components [19]. One important property of the adjacency matrix is that the number of walks between any two nodes of the graph can be determined using the powers of this matrix. More precisely, the entry in the i^{th} row and the j^{th} column of A^k , $[A^k]_{ij}$, is the number of walks of length k between nodes i and j . In particular, $[A^k]_{ii}$ is the number of closed walks of length k containing node i . The total number of closed walks of length k in G is thus $tr(A^k)$, where $tr(\cdot)$ is the trace of a matrix.² Since $tr(A^k) = \sum_{i=1}^{|V|} \lambda_i^k$, it follows that the multiplicity of closed walks of different length in a graph can be obtained using the spectrum of the graph.

In the figures of this paper, edges of a graph are shown by straight lines. In this work, we need to closely examine different types of closed walks. To show a closed walk in a graph, we draw a closed curved line alongside the graph following the edges of the walk. We place an

²In this calculation, closed walks with the same set of edges but with different starting edge or with different direction are distinguished and counted separately.

arrow at the location corresponding to the starting edge of the walk to specify the starting edge and the direction of the walk. An example is shown in Fig. 1.

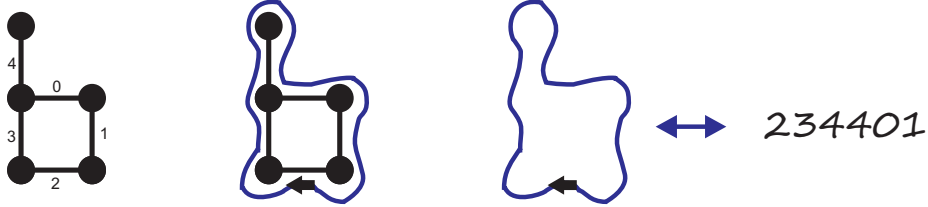

Fig. 1. The representation of a graph and one of its closed walks.

To devise our counter-examples, we often use cycles and paths. The path P_n has the following spectrum:

$$2 \cos\left(\frac{\pi j}{n+1}\right), \quad j = 1, \dots, n, \quad (1)$$

and the spectrum of a cycle of length n , denoted by C_n , is as follows:

$$2 \cos\left(\frac{2\pi j}{n}\right), \quad j = 0, \dots, n-1. \quad (2)$$

In general, the spectrum of a graph does not uniquely determine the graph. Two graphs are called *cospectral* or *isospectral* if they have the same spectrum. For example, the complete bipartite graph $K_{1,4}$, and the graph $C_4 \cup K_1$ (the union of a 4-cycle and a single node) are cospectral, both having the spectrum $\{-2, 0, 0, 0, 2\}$ or $\{-2, 0^3, 2\}$. On the other hand, there are graphs that are known to be uniquely determined by their spectrum. Two examples are the complete graph K_n , and the complete bipartite graph $K_{n,n}$ [18].

It is well-known that a number of properties of a graph G can be uniquely specified based on the information of the graph's spectrum (see, for example, [18]). These include the number of nodes and edges of G , the number of cycles of length three in G , whether G is regular, whether G is regular with any fixed girth, and whether G is bipartite. In particular, a given graph is bipartite if and only if its spectrum is symmetric with respect to the origin. On the other hand, there are some other important properties of a graph, such as the number of cycles of length larger than three, that cannot be determined by the spectrum alone. In this work, we are interested in counting the number of short cycles in bipartite graphs. In particular, to complement the results of [15], we investigate whether such counting problems can be solved for cycles larger than the girth in bipartite graphs that are not bi-regular, by using the spectrum of the graph and the extra information about the node degrees of the graph.

III. COMPUTING THE MULTIPLICITY OF SHORT CYCLES IN BI-REGULAR BIPARTITE GRAPHS

In this section, we compute the multiplicity of k -cycles of bi-regular bipartite graphs with $g \geq 4$, for $g + 2 \leq k \leq 2g - 2$, in terms of the spectrum and the degree sequences of the graph. The results presented in this section complement those of Blake and Lin [15] for g -cycles. The results are obtained by characterizing and counting closed walks of length k that are not cycles, and subtracting their multiplicity from the total number of closed walks of length k . The latter is easily obtained using the spectrum of the graph. In this section, we also provide a brief review of the main result of [15], and propose an alternate approach for the calculation of the number of closed cycle-free walks in a bipartite graph.

A. Categorization of closed walks

A closed walk \mathcal{W} is called *cycle-free* if the edge-induced subgraph on the set of edges of \mathcal{W} does not have any cycle. An example of a closed cycle-free walk is shown in Fig. 2(a). We say a closed walk \mathcal{W} is a *closed walk with cycle*, or CWWC, in brief, if \mathcal{W} is not a cycle but the edge-induced subgraph on the set of edges of \mathcal{W} has at least one cycle. An example of a closed walk with cycle is shown in Fig. 2(b).

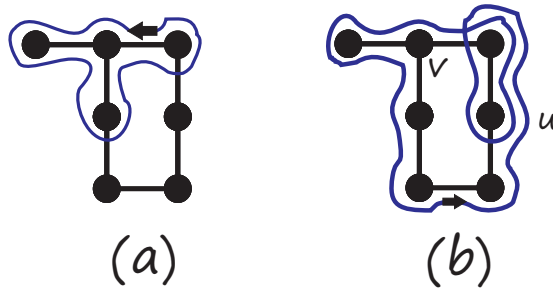

Fig. 2. (a) An example of a closed cycle-free walk of length six, (b) An example of a closed walk of length 10 with cycle or a 10-CWWC.

Lemma 1. *All the closed walks of length k in a graph G can be partitioned into three categories: (i) k -cycles, (ii) closed cycle-free walks of length k , and (iii) closed walks of length k with cycle.*

In this work, two walks e_{i_1}, \dots, e_{i_r} and e_{j_1}, \dots, e_{j_r} are considered identical, and thus counted as one, if and only if for every x in the range $1 \leq x \leq r$, $e_{i_x} = e_{j_x}$. In other words, closed walks that pass through the same set of edges but in different directions or with different starting

edge are considered distinguishable and counted separately. The following theorem then follows immediately from Lemma 1.

Theorem 1. *For a given (d_v, d_c) -regular bipartite graph G , the number of i -cycles is given by:*

$$N_i = \left[\sum_{j=1}^{|V|} \lambda_j^i - \Omega_i(d_v, d_c, G) - \Psi_i(d_v, d_c, G) \right] / (2i), \quad (3)$$

where $\{\lambda_j\}_{j=1}^{|V|}$ is the spectrum of G , and $\Omega_i(d_v, d_c, G)$ and $\Psi_i(d_v, d_c, G)$ are the number of closed cycle-free walks of length i and closed walks with cycle of length i in G , respectively.

The multiplicity $\Omega_i(d_v, d_c, G)$ of closed cycle-free walks of length i in a (d_v, d_c) -regular bipartite graph G was computed in [15]. In the following, we review the result of [15] and also provide an alternate approach for the computation.

B. Calculation of $\Omega_i(d_v, d_c, G)$

1) *Approach of [15]:* Blake and Lin [15] used the following formula to calculate $\Omega_i(d_v, d_c, G)$, for $2 \leq i \leq 2g - 2$:

$$\Omega_i(d_v, d_c, G) = n \times S_{d_v, d_c, i} + m \times S_{d_c, d_v, i}. \quad (4)$$

In (4), parameters n and m are the number of variable and check nodes in G , respectively, and $S_{d_v, d_c, i}$ ($S_{d_c, d_v, i}$) represents the number of closed cycle-free walks of length i from a variable node v (a check node c) to itself. Generating functions were then used to compute the functions $S_{x, y, i}$ recursively. In Table II, we have shown the functions $S_{x, y, i}$ for values of i up to ten.

TABLE II

IN A (d_v, d_c) -REGULAR BIPARTITE GRAPH, THE NUMBER OF CLOSED CYCLE-FREE WALKS OF LENGTH i FROM ANY VARIABLE NODE v (CHECK NODE c) TO ITSELF IS EQUAL TO $S_{d_v, d_c, i}$ ($S_{d_c, d_v, i}$) [15]

i	$Q_{x, y, i}$	$S_{x, y, i}$
2	x	x
4	$x(y-1)$	$x(x+y-1)$
6	$x((y-1)^2 + (x-1)(y-1))$	$x(x^2 + 2x(y-1) + (x-1)(y-1) + (y-1)^2)$
8	$x((y-1)^3 + 3(x-1)(y-1)^2) + x(x-1)^2(y-1)$	$x((y-1)^3 + 3(x-1)(y-1)^2 + (x-1)^2(y-1)) + x(2x((y-1)^2 + (x-1)(y-1)) + x(y-1)^2 + 3x^2(y-1) + x^3)$
10	$x((y-1)^4 + 6(x-1)(y-1)^3) + x(6(x-1)^2(y-1)^2 + (x-1)^3(y-1))$	$Q_{x-1, y-1, 10} + 2Q_{x-1, y-1, 2}Q_{x-1, y-1, 6} + 2Q_{x-1, y-1, 4}Q_{x-1, y-1, 6} + 3Q_{x-1, y-1, 2}Q_{x-1, y-1, 4}^2 + 3Q_{x-1, y-1, 2}^2Q_{x-1, y-1, 6} + 4Q_{x-1, y-1, 2}^3Q_{x-1, y-1, 4} + Q_{x-1, y-1, 2}^5$

2) *Alternate approach:* Let $T_{d_v, d_c, i}$ be a rooted tree of height $\frac{i}{2}$ with the root node of degree d_v at level zero, and the nodes of succeeding levels with alternating degrees d_c and d_v , in odd and even levels of the tree, respectively. In such a tree, all the leaves are in level $\frac{i}{2}$. As an example, the tree $T_{3,4,4}$ is shown in Fig. 3. Let $A(T_{d_v, d_c, i})$ be the adjacency matrix of $T_{d_v, d_c, i}$ such that the root corresponds to the first row of the matrix. Then for a given (d_v, d_c) -regular Tanner graph G , the number of closed cycle-free walks of length i from a variable node v in G to itself (i.e., $S_{d_v, d_c, i}$) is equal to the $(1, 1)$ -th entry of the matrix $A(T_{d_v, d_c, i})^i$. This follows from the fact that there are no cycles in $T_{d_v, d_c, i}$, and thus all the closed walks are cycle-free. Similarly, $S_{d_c, d_v, i}$ is equal to the $(1, 1)$ -th entry of the matrix $A(T_{d_c, d_v, i})^i$. Therefore, to obtain $S_{x, y, i}$ for different values of x, y and i , one can form the adjacency matrix of $T_{x, y, i}$, calculate its i -th power and then take the $(1, 1)$ -th entry of the resulting matrix. Using this technique, we have calculated $S_{x, y, i}$ for some practical values of x, y , and $i = 10, 12$. These are provided in Table III.

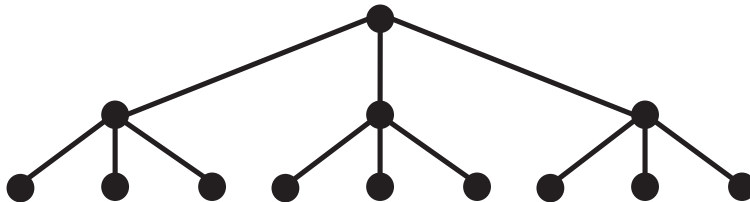

Fig. 3. The tree $T_{3,4,4}$.

C. Calculation of N_g

It is clear that $\Psi_g(d_v, d_c, G) = 0$. Based on this and Theorem 1, we have the following corollary.

Corollary 1. [15] *The total number of cycles of length g in a (d_v, d_c) -regular bipartite graph $G(V, E)$ is equal to:*

$$N_g = \frac{\sum_{i=1}^{|V|} \lambda_i^g - \Omega_g(d_v, d_c, G)}{2g}, \quad (5)$$

where $\{\lambda_i\}$ is the spectrum of G and $\Omega_g(d_v, d_c, G)$ is given by (4).

In the following, we consider two examples of bi-regular bipartite graphs, for which the number of short cycles can be computed using simple combinatorial arguments. We use the same

TABLE III

THE NUMBER OF CLOSED CYCLE-FREE WALKS OF LENGTH i IN AN (x, y) -REGULAR BIPARTITE GRAPH FROM A NODE WITH DEGREE x TO ITSELF FOR DIFFERENT x, y AND i (I.E., $S_{x,y,i}$).

	$x = 2$	$x = 3$	$x = 4$	$x = 5$	$x = 6$	$x = 7$	$x = 8$
$i = 10$							
$y = 2$	252	1278	4144	10500	22716	44002	78528
$y = 3$	852	3535	10104	23325	46956	85827	145968
$y = 4$	2072	7578	19864	43100	82656	145222	238928
$y = 5$	4200	13995	34480	71445	132120	225295	361440
$y = 6$	7572	23478	55104	110100	197796	–	–
$y = 7$	12572	36783	82984	160925	282276	–	–
$y = 8$	19632	54738	119464	225900	–	–	–
$i = 12$							
$y = 2$	–	6486	26408	79860	199812	438074	871056
$y = 3$	4324	23823	82920	223795	512748	–	–
$y = 4$	13204	62190	195352	488980	–	–	–
$y = 5$	31944	134277	391184	–	–	–	–
$y = 6$	66604	256374	–	–	–	–	–
$y = 7$	125164	448731	–	–	–	–	–
$y = 8$	217764	–	–	–	–	–	–

examples in subsequent subsections to demonstrate that the results obtained by our computational technique match the results obtained by combinatorics.

Example 1. Consider the complete bipartite graph $K_{x,x}$. For this graph, $g = 4$, and we are interested in counting the number of 4-cycles and 6-cycles ($2g - 2 = 6$). Let i be 4 or 6. To find an i -cycle, one needs to choose $i/2$ nodes out of the x nodes on each side of the graph with ordering. This results in

$$N_i = \frac{1}{i} \left(\frac{x!}{(x - \frac{i}{2})!} \right)^2,$$

where the division by i is due to the fact that in the above process, each cycle is counted i times. From the above formula, we have: $N_4 = x^2(x - 1)^2/4$ and $N_6 = x^2(x - 1)^2(x - 2)^2/6$. Now, we use Corollary 1 to calculate the number of 4-cycles. The eigenvalues of $K_{x,x}$ are $\{0^{2x-2}, x, -x\}$. Thus, $\sum_i \lambda_i^g = 2x^4$. From Table II, we have: $S_{x,x,4} = x(2x - 1)$. By replacing this in (4), we therefore have: $\Omega_4(x, x, G) = 2x^2(2x - 1)$. Consequently, by Corollary 1, we obtain $N_4 = \left(2x^4 - 2x^2(2x - 1) \right) / 8 = x^2(x - 1)^2/4$, which is the same result as the one we derived by combinatorial arguments.

Example 2. Consider the $(2, 3)$ -regular bipartite graph \mathcal{H} shown in Fig. 4. This graph has 12 variable nodes and 8 check nodes (i.e., $n = 12$ and $m = 8$), and $g = 6$. By inspection, it is clear that \mathcal{H} has two cycles of length six. In the following, we use Corollary 1 to calculate N_6 .

For \mathcal{H} , we have $\sum_i \lambda_i^g = \text{tr}(A(\mathcal{H})^6) = 888$. Also, from Table II, $S_{d_c, d_v, 6} = S_{3, 2, 6} = 54$, and $S_{d_v, d_c, 6} = S_{2, 3, 6} = 36$. Thus, by (4), we have: $\Omega_6(3, 2, \mathcal{H}) = 864$. Consequently, by Corollary 1, we obtain $N_6 = 2$.

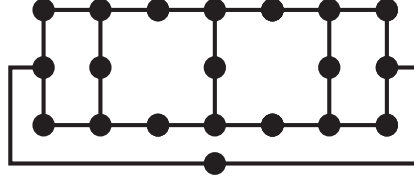

Fig. 4. Graph \mathcal{H} of Example 2

D. Properties and characterization of closed walks with cycle (CWWCs) (of length at most $2g - 2$)

To calculate $\Psi_i(d_v, d_c, G)$ for a (d_v, d_c) -regular bipartite graph G , in the following, we first study some important properties of closed walks with cycles.

Lemma 2. Let G be a bipartite graph with girth g . If \mathcal{W} is a closed walk of length i with cycle in G , where $i \leq 2g - 2$, then there is an edge e in G such that $\mathcal{W} = \mathcal{W}'ee\mathcal{W}''$, or $\mathcal{W} = ee\mathcal{W}'$, or $\mathcal{W} = \mathcal{W}'ee$, or $\mathcal{W} = e\mathcal{W}'e$, where \mathcal{W}' and \mathcal{W}'' are subwalks of \mathcal{W} .

Proof. We prove this by contradiction. Suppose that \mathcal{W} does not have an edge with the property described in the lemma. We start from v , the first node of \mathcal{W} , and visit the edges of \mathcal{W} one by one until we reach the first repeated node u . By our assumption, the closed subwalk from u to itself is a cycle. Call that cycle \mathcal{W}_1 , and remove it from \mathcal{W} . The remaining graph is another closed walk from v back to itself and its size is at least four (otherwise, an edge e , as described in the lemma must exist). Call this closed walk \mathcal{W}_2 . Using a similar argument as before, the closed walk \mathcal{W}_2 must contain a cycle \mathcal{W}_3 . We thus conclude that \mathcal{W} has at least two edge disjoint cycles \mathcal{W}_1 and \mathcal{W}_3 . This implies $i \geq 2g$, which is a contradiction. \blacksquare

Lemma 3. *Let G be a bipartite graph with girth g and \mathcal{W} be a closed walk of length i in G , $i \geq g$. If there is an edge $e = vu$ that appears only once in \mathcal{W} , then the edge-induced subgraph on the set of edges of \mathcal{W} has a cycle.*

Proof. Let $e = vu$ be an edge that appears only once in \mathcal{W} . Consider the edge-induced subgraph G' on the set of edges of $\mathcal{W} \setminus \{e\}$. This subgraph is connected. In G' , consider the shortest path from u to v and call it P . The union of P and e is a cycle. ■

Consider the CWWC \mathcal{W} shown in Fig. 2(b). The closed walk \mathcal{W} consists of a 6-cycle \mathcal{C} and two closed cycle-free walks of length two from nodes u and v (of cycle \mathcal{C}) to themselves. In the following, we prove that any i -CWWC ($i \leq 2g - 2$) consists of one cycle \mathcal{C} and some closed cycle-free walks from the nodes of \mathcal{C} to themselves.

Lemma 4. *Let G be a bipartite graph with girth g . If \mathcal{W} is an i -CWWC, where $i \leq 2g - 2$, then, the walk \mathcal{W} consists of one cycle \mathcal{C} and some closed cycle-free walks from the nodes of \mathcal{C} to themselves.³*

Proof. We prove the claim by induction on the number of edges of the closed walk.

Basis: The smallest CWWC \mathcal{W} has $g + 2$ edges. By definition, the edge-induced subgraph on the set of edges of \mathcal{W} has a cycle, and on the other hand, \mathcal{W} is not a $(g + 2)$ -cycle. Thus, \mathcal{W} consists of one g -cycle and a closed cycle-free walk of length 2 from a node of that g -cycle to itself.

Induction step: Suppose that the claim is true for any closed walk of length i with cycle, where $i \leq 2g - 4$. Now, we prove the claim for all $(i + 2)$ -CWWCs. Let \mathcal{W} be such a closed walk. By Lemma 2, there is an edge $e = uv$ such that $\mathcal{W} = \mathcal{W}'ee\mathcal{W}''$, or $\mathcal{W} = ee\mathcal{W}'$, or $\mathcal{W} = \mathcal{W}'ee$, or $\mathcal{W} = e\mathcal{W}'e$. Remove the two copies of e , just described, from \mathcal{W} , and call the remaining closed walk \mathcal{W}_1 . Now, two cases can be considered:

Case 1. If the edge-induced subgraph on the set of edges of \mathcal{W}_1 has a cycle, then \mathcal{W}_1 is a closed walk of length i with cycle. Thus, by the induction hypothesis, we know that \mathcal{W}_1 consists of

³This result is used later to count the number of CWWCs irrespective of the direction and the starting edge of the walk. The result of this lemma should thus be interpreted accordingly, i.e., for \mathcal{W} to be formed, all the edges of \mathcal{C} are traversed in a given direction, and for each cycle-free subgraph \mathcal{T} attached to one of the nodes of \mathcal{C} , say v , each edge of \mathcal{T} is traversed an even number of times equally in each direction. This means that, in general, there is no requirement that all the traversals through the edges of \mathcal{T} happen sequentially. Nor is there a requirement that the traversals are initiated from v .

one cycle \mathcal{C} and some closed cycle-free walks from the nodes of \mathcal{C} to themselves. It is then easy to see that the same also applies to \mathcal{W} .

Case 2. Suppose that the edge-induced subgraph on the set of edges of \mathcal{W}_1 does not have any cycle. Since, the edge-induced subgraph on the set of edges of \mathcal{W} has a cycle, we conclude that $e = uv$ is neither in \mathcal{W}_1 nor in the edge-induced subgraph on the set of edges of \mathcal{W}_1 . There is, however, a path between the nodes v and u in the edge-induced subgraph of \mathcal{W}_1 . Call this path \mathcal{P} . The length of \mathcal{P} is at least $g - 1$. So, \mathcal{W}_1 has at least $g - 1$ different edges. On the other hand, by Lemma 3, each edge of \mathcal{W}_1 appears at least twice in \mathcal{W}_1 . Thus, the length of \mathcal{W}_1 is at least $2g - 2$, which implies that the length of \mathcal{W} is at least $2g$. But this is a contradiction. So, this case does not occur. ■

If \mathcal{W} is a CWWC of length i and $i \leq 2g - 2$, then it is clear that the edge-induced subgraph on the set of edges of \mathcal{W} does not have two edge-disjoint cycles. In the next lemma, we show that the subgraph has exactly one cycle.

Lemma 5. *Let G be a bipartite graph with girth g . If \mathcal{W} is a CWWC of length i and $i \leq 2g - 2$, then, the edge-induced subgraph on the set of edges of \mathcal{W} has exactly one cycle.*

Proof. By Lemma 4, we know that \mathcal{W} consists of one cycle \mathcal{C} and some closed cycle-free walks from the nodes of \mathcal{C} . Now, we prove that the cycle \mathcal{C} is the only cycle in the edge-induced subgraph on the set of edges of \mathcal{W} . To the contrary, assume that the edge-induced subgraph on the set of edges of \mathcal{W} has another cycle \mathcal{C}' such that \mathcal{C} and \mathcal{C}' share $\ell \geq 1$ edges. Denote the length of cycle \mathcal{C} (\mathcal{C}') by $L(\mathcal{C})$ ($L(\mathcal{C}')$). Since the union of two cycles minus their shared edges contains at least one cycle, and since the girth of the graph G is g , we have:

$$L(\mathcal{C}) + L(\mathcal{C}') - 2\ell \geq g \quad (6)$$

On the other hand, by Lemma 4, the closed walk \mathcal{W} visits every edge of \mathcal{C}' which is not in \mathcal{C} at least twice. We therefore have:

$$i \geq L(\mathcal{C}) + 2(L(\mathcal{C}') - \ell) \quad (7)$$

By combining (6), (7), and the fact that $L(\mathcal{C}') \geq g$, we obtain $i \geq 2g$. But this is a contradiction. ■

We note that the closed cycle-free walks that start from the nodes of cycle \mathcal{C} , as described in Lemma 4, can have some edges in common with \mathcal{C} . For instance, in the CWWC of length 10

shown in Fig. 2(b), the closed cycle-free walk of length 2 from node u traverses twice through one of the edges of the 6-cycle. In the following, we prove that at least one of the edges of \mathcal{C} appears only once in the closed walk with cycle.

Lemma 6. *If G is a bipartite graph with girth g , then for each i , $g + 2 \leq i \leq 2g - 2$, every closed walk \mathcal{W} of length i with cycle has at least one edge that appears only once in \mathcal{W} .*

Proof. By the definition of a closed walk with cycle, the edge-induced subgraph on the set of edges of \mathcal{W} has a cycle \mathcal{C} . If for every edge e in \mathcal{C} , that edge appears at least twice in \mathcal{W} , then the length of \mathcal{W} must be at least $2g$. But this is a contradiction. ■

Lemma 7. *Consider a bipartite graph G with girth g , and let $k < g$. We can then divide $\Psi_{g+k}(d_v, d_c, G)$ by $2(g+k)$ to obtain the number of CWWCs of length $(g+k)$ irrespective of the direction and the starting edge of the closed walk.*

Proof. Let \mathcal{W} be a CWWC of length $g+k$, and let e be an edge that appears exactly once in \mathcal{W} (based on Lemma 6, such an edge exists). The starting edge of \mathcal{W} can be selected such that e appears as the j -th edge of \mathcal{W} , for any j in the range $1 \leq j \leq g+k$. This together with the two directions that can be selected for traversing the edges of \mathcal{W} completes the proof. ■

The general approach we use to calculate $\Psi_{g+k}(d_v, d_c, G)$ is based on employing Lemmas 4 and 5 to count different types of CWWCs of a certain length irrespective of the direction or the starting edge of the walk. We then use Lemma 7 to account for the direction and the starting edge. Suppose that we are interested in counting the CWWCs of length i that consist of a cycle of length $g+k$ and some closed cycle-free walks form the nodes of that cycle, where $i \leq 2g-2$, and $k < g-2$. By Lemmas 4 and 5, in this case, each CWWC consists of a $(g+k)$ -cycle and some closed cycle-free walks $\mathcal{W}_1, \dots, \mathcal{W}_j$ from the nodes of the cycle, such that $g+k + \sum_{l=1}^j |\mathcal{W}_l| = i$. Considering that the length of each closed walk is even, we thus have $1 \leq j \leq \frac{i-g-k}{2}$. To count the CWWCs under consideration, we need to partition the number $\frac{i-g-k}{2}$ into j positive integer numbers (with j in the above range), where each integer number represents half of the length of one of the closed cycle-free walks. The number of ways this partitioning can be performed determines the number of possibilities for the lengths of j closed cycle-free walks. In the following, corresponding to each partitioning, we identify a *category* of CWWCs, i.e., in a given category, the lengths of closed cycle-free walks are fixed. Within each

category, we then identify all the possibilities that closed cycle-free walks with the given lengths can be attached to the nodes of the $(g + k)$ -cycle.

An *integer partition* of a positive integer n is defined as a way of describing n as a sum of positive integers. For example, the integer number 4 has five integer partitions: 4, 3 + 1, 2 + 2, 2 + 1 + 1, and 1 + 1 + 1 + 1. The number of integer partitions of n is given by the *partition function* $p(n)$. For the example just given, $p(4) = 5$. An asymptotic expression for $p(n)$ is given by [20]

$$p(n) \sim \frac{1}{4n\sqrt{3}} \exp\left(\pi\sqrt{\frac{2n}{3}}\right). \quad (8)$$

In this work, however, we are interested in relatively short closed walks with cycles, where the length of the walk is at most $2g - 2$.

E. Calculation of N_{g+2}

To use Theorem 1 for the calculation of N_{g+2} , we need to calculate $\Psi_{g+2}(d_v, d_c, G)$.

Theorem 2. For a (d_v, d_c) -regular bipartite graph G with girth g , we have

$$\Psi_{g+2}(d_v, d_c, G) = N_g \times \left(\frac{g}{2}(d_v + d_c) - g\right) \times 2(g + 2).$$

Proof. We first focus on counting CWWCs of length $g + 2$ irrespective of their starting edge or direction. By Lemma 7, we then need to multiply the obtained value by $2(g + 2)$ to take into account the different starting edges and directions. By Lemma 4, every $(g + 2)$ -CWWC consists of a cycle of length g and some closed cycle-free walks. Since for $i = g + 2$ and $k = 0$, we have $\frac{i-g-k}{2} = 1$, and since $p(1) = 1$, there is only one possibility for the lengths of closed cycle-free walks, i.e., there is only one closed cycle-free walk of length 2 connected to one of the nodes of a g -cycle. This corresponds to a single category of CWWCs. In the following, we partition this single category of $(g + 2)$ -CWWCs into two subcategories: **1.1** In this subcategory, the set of edges of the CWWC consists of the edges of a g -cycle and one extra edge that is incident to one node of the g -cycle. See Fig. 5(a), for an example. **1.2** In this subcategory, the set of edges of the CWWC consists of the edges of a g -cycle, i.e., the closed cycle-free walk of length 2 is connected to one of the nodes of the cycle and traverses one of the edges of the cycle. See Fig. 5(b), for an example.

To find a $(g + 2)$ -CWWC in Subcategory 1.1, first, we need to choose a cycle of length g (the graph has N_g cycles of length g). Then, we need to choose a node v from the cycle (the

cycle has $g/2$ variable nodes and $g/2$ check nodes). Finally, we need to choose an edge which is incident to v and is not in the cycle (each variable node has $d_v - 2$ such edges, and each check node has $d_c - 2$ such edges). Consequently, the total number of $(g + 2)$ -CWWCs in Subcategory 1.1 is equal to $N_g \times [\frac{g}{2}(d_v - 2) + \frac{g}{2}(d_c - 2)] = N_g \times [\frac{g}{2}(d_v + d_c) - 2g]$.

In order to find a $(g + 2)$ -CWWC in Subcategory 1.2, we need to choose a cycle (i.e., N_g options), and an edge from that cycle (i.e., g options). This amounts to $N_g \times g$ choices. We thus have $\Psi_{g+2}(d_v, d_c, G) = N_g \times [\frac{g}{2}(d_v + d_c) - g] \times 2(g + 2)$. ■

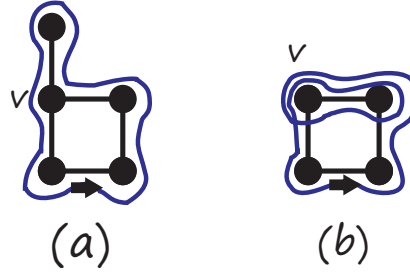

Fig. 5. (a) A 6-CWWC in Subcategory 1.1, (b) A 6-CWWC in Subcategory 1.2.

Example 3. Consider the complete bipartite graph $K_{x,x}$. Using combinatorial arguments, in Example 1, we showed that for this graph, $N_6 = x^2(x - 1)^2(x - 2)^2/6$. Now, we use Theorems 1 and 2, to calculate the number of 6-cycles. We have $\sum_j \lambda_j^6 = \text{tr}(A(K_{x,x})^6) = 2x^6$. From Table II, we obtain $S_{x,x,6} = x(x^2 + 2x(x - 1) + 2(x - 1)^2)$. Thus, by (4), we have $\Omega_6(x, x, G) = 2x \times x(x^2 + 2x(x - 1) + 2(x - 1)^2)$. Also, $N_g \times [\frac{g}{2}(d_v + d_c) - g] \times 2(g + 2) = \frac{x^2(x-1)^2}{4}(2(2x) - 4) \times 12$. Consequently, we have $N_6 = x^2(x - 1)^2(x - 2)^2/6$.

Example 4. Consider the $(2, 3)$ -regular bipartite graph \mathcal{H} shown in Fig. 4. As discussed in Example 2, for this graph, $N_6 = 2$. Here, we use Theorems 1 and 2, to compute N_8 . We have $\text{tr}(A(\mathcal{H})^8) = 4448$. Also, from Table II, we obtain $S_{d_c, d_v, 8} = S_{3, 2, 8} = 258$, and $S_{d_v, d_c, 8} = S_{2, 3, 8} = 172$. Thus, by (4), we have $\Omega_8(3, 2, G) = 4128$. Also, $N_g \times [\frac{g}{2}(d_v + d_c) - g] \times 2(g + 2) = 288$. Consequently, using Theorem 1, we have $N_8 = (4448 - 4128 - 288)/16 = 2$. By inspection of \mathcal{H} , it is clear that this value is correct.

F. Calculation of N_{g+4}

In the following, we calculate $\Psi_{g+4}(d_v, d_c, G)$. This together with Theorem 1 and (4) are then used to compute N_{g+4} .

Theorem 3. *For any (d_v, d_c) -regular bipartite graph G with girth g at least six, we have*

$$\begin{aligned} \frac{\Psi_{g+4}(d_v, d_c, G)}{2(g+4)} &= N_{g+2} \times \left[\frac{g+2}{2}(d_v + d_c) - (g+2) \right] \\ &+ N_g \times \left[\frac{g}{2}(d_v - 2)(d_c - 1) + \frac{g}{2}(d_c - 2)(d_v - 1) \right] \\ &+ N_g \times \left(\left[\binom{\frac{g}{2}}{2} + \frac{g}{2} \right] (d_v - 2)^2 + \left[\binom{\frac{g}{2}}{2} + \frac{g}{2} \right] (d_c - 2)^2 + \left(\frac{g}{2} \right)^2 (d_v - 2)(d_c - 2) \right) \\ &+ N_g \times \left(\binom{g}{2} + 2g + (g+2) \times \left(\frac{g}{2}(d_v - 2) + \frac{g}{2}(d_c - 2) \right) \right), \end{aligned}$$

where N_g and N_{g+2} are the number of cycles of length g and $g+2$ in G , respectively.

Proof. In the following, we prove that the right hand side of the above equation calculates the number of CWWCs of length $g+4$ not taking into account the starting edge or the direction of the walks. Since the girth of the graph is at least six, by Lemma 4, every $(g+4)$ -CWWC consists of one cycle and some closed cycle-free walks. Depending on the length of the cycle, two cases are possible:

Case 1. The closed walk consists of a $(g+2)$ -cycle and some closed cycle-free walks. In this case, similar to the case of Theorem 2, there is one category of CWWCs with two subcategories: (i) The set of the edges of the closed walk consists of the edges of a $(g+2)$ -cycle and one extra edge that is incident to one node of the $(g+2)$ -cycle. (ii) The set of the edges of the closed walk is the same as the set of the edges of a $(g+2)$ -cycle. Similar to Theorem 2, the total number of $(g+4)$ -CWWCs in this case is equal to $N_{g+2} \times \left[\frac{g+2}{2}(d_v + d_c) - (g+2) \right]$.

Case 2. The closed walk consists of a g -cycle and some closed cycle-free walks. For this case, $p(2) = 2$, and there are two categories of $(g+4)$ -CWWCs. In the first category, each CWWC consists of one g -cycle \mathcal{C} and one closed cycle-free walk of length 4 from one of the nodes of \mathcal{C} . In the second category, each CWWC consists of one g -cycle \mathcal{C} and two closed cycle-free walks, each of length 2, from two nodes of \mathcal{C} . The CWWCs in the first and second categories can be partitioned into eight and three subcategories, respectively. See, Figures 6 and 7, respectively. In the following, we count the number of CWWCs in each subcategory of each category by referring to the structure of corresponding CWWCs as shown in Figures 6 and 7.

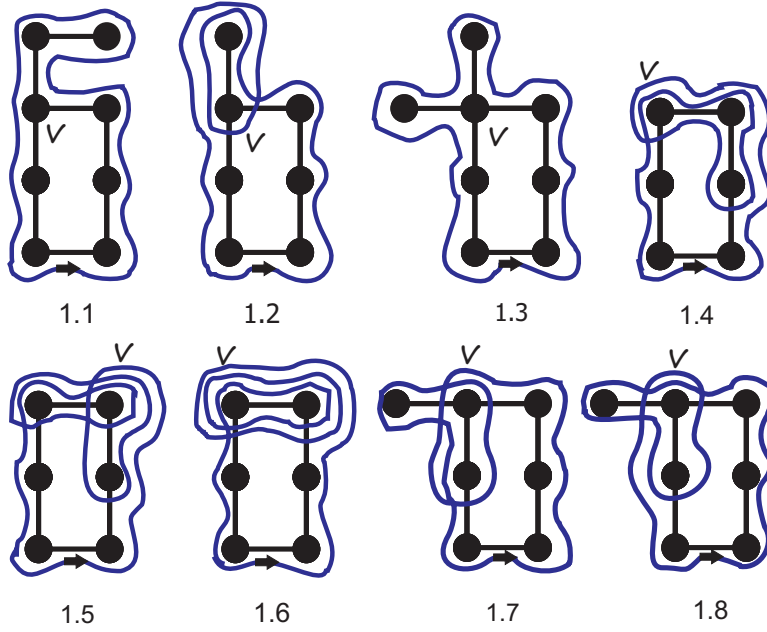

Fig. 6. Different subcategories of $(g + 4)$ -CWWCs in Category 1 of Case 2.

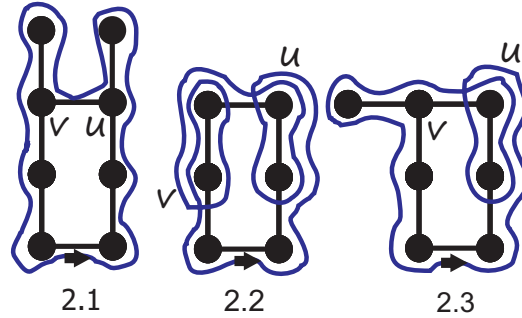

Fig. 7. Different subcategories of $(g + 4)$ -CWWCs in Category 2 of Case 2.

Category 1:

1.1 To find a $(g + 4)$ -CWWC in this subcategory, first, we need to choose a cycle of length g (the graph has N_g cycles of length g). Then we choose a node v from the cycle (the cycle has $\frac{g}{2}$ variable nodes and $\frac{g}{2}$ check nodes). Next, we choose an edge which is incident to v and is not in the cycle (each variable node has $d_v - 2$ such edges and each check node has $d_c - 2$ such edges). Finally, we choose an edge which shares a node with the edge that we picked in the previous step. Consequently, the total number of $(g + 4)$ -CWWCs in this subcategory is equal to $N_g \times [\frac{g}{2}(d_v - 2)(d_c - 1) + \frac{g}{2}(d_c - 2)(d_v - 1)]$.

1.2 It is easy to see that the multiplicity of CWWCs in this subcategory is equal to $N_g \times [\frac{g}{2}(d_v - 2) + \frac{g}{2}(d_c - 2)]$.

1.3 For this subcategory, the number of CWWCs is given by

$$N_g \times \left(\frac{g}{2}(d_v - 2)(d_v - 3) + \frac{g}{2}(d_c - 2)(d_c - 3) \right).$$

1.4 To find a CWWC in this subcategory, we need to choose a cycle of length g , first (N_g possibilities), and then choose two adjacent edges from that cycle (g possibilities). The number of CWWCs in this subcategory is thus equal to $N_g \times g$.

1.5 Similar to the previous subcategory, for this one also the multiplicity of CWWCs is equal to $N_g \times g$.

1.6 The multiplicity for this subcategory is also given by $N_g \times g$.

1.7 To find a CWWC in this subcategory, we need to first choose a g -cycle (N_g possibilities). Then we need to choose a node v from that cycle and also an edge connected to v that is not part of the cycle ($\frac{g}{2}(d_v - 2) + \frac{g}{2}(d_c - 2)$ possibilities). Finally, we need to choose one of the two edges which are incident to v and are in the selected cycle (2 possibilities). The total number of CWWCs in this subcategory is thus $N_g \times (\frac{g}{2}(d_v - 2) + \frac{g}{2}(d_c - 2)) \times 2$.

1.8 Similar to Subcategory 1.7, the number of CWWCs in this subcategory is $N_g \times (\frac{g}{2}(d_v - 2) + \frac{g}{2}(d_c - 2)) \times 2$.

Category 2:

2.1 To find a CWWC in this subcategory, first, we choose a cycle of length g . Then, we choose two nodes v and u from the cycle (these two nodes can be both variable nodes, both check nodes, or one variable node and one check node). Finally, for each selected node, we choose an edge which is incident to that node and is not in the cycle. Thus, the total number of CWWCs in this subcategory is equal to

$$N_g \times \left(\binom{g/2}{2} (d_v - 2)^2 + \binom{g/2}{2} (d_c - 2)^2 + \left(\frac{g}{2}\right)^2 (d_v - 2)(d_c - 2) \right).$$

2.2 For a CWWC in this subcategory, we choose a g -cycle and two edges from that cycle that are not incident. The multiplicity is thus

$$N_g \times \left[\binom{g}{2} - g \right].$$

2.3 In this case, we first choose a g -cycle. Then, we choose a node v and an edge from that

cycle such that the selected edge is not incident to v ($g - 2$ possibilities). Finally, we choose an edge incident to v which does not belong to the selected g -cycle. The multiplicity in this case is thus $N_g \times (g - 2) \times (\frac{g}{2}(d_v - 2) + \frac{g}{2}(d_c - 2))$.

Adding up the multiplicities derived above, we obtain the total multiplicity of $(g + 4)$ -CWWCs given in the theorem. ■

Example 5. Consider the $(2, 3)$ -regular bipartite graph \mathcal{H} shown in Fig. 4. In Examples 1 and 3, we showed that $N_6 = 2$ and $N_8 = 2$. Here, we use Theorems 1 and 3, to compute N_{10} . We have $\text{tr}(A(\mathcal{H})^{10}) = 23408$. Also, from Table II, we obtain $S_{d_c, d_v, 10} = S_{3, 2, 10} = 1278$, and $S_{d_v, d_c, 10} = S_{2, 3, 10} = 852$. Thus, by (4), we have $\Omega_8(3, 2, G) = 20448$. Also, from Theorem 3, $\Psi_{10}(3, 2, \mathcal{H}) = 2880$. Consequently, we have $N_{10} = 4$. By inspection, it is easy to see that \mathcal{H} has in fact four cycles of length 10.

G. Calculation of N_i for $g + 6 \leq i \leq 2g - 2$

To compute N_i , for $g + 6 \leq i \leq 2g - 2$, using Theorem 1, one needs to calculate the corresponding Ψ_i . Such a calculation involves steps similar to those taken in Theorems 2 and 3. For each value of i in the above range, based on Lemma 4, all CWWCs consist of a single cycle and some closed cycle-free walks from the nodes of that cycle. The CWWCs should then be first partitioned based on the length of the cycle ($g, g + 2, \dots, i - 2$), and then for each cycle length $g + 2k, k = 0, \dots, \frac{i-g}{2} - 1$, they should be further partitioned into different categories based on the possible lengths of the closed cycle-free walks (the number of categories is equal to $p(\frac{i-g-k}{2})$). Within each category, subcategories then need to be identified based on different ways that the closed cycle-free walks can be attached to the cycle.

It is easy to see that calculation of each Ψ_i requires the information of all $N_j, g \leq j \leq i - 2$. One can also see that the calculations required for finding the multiplicities of i -CWWCs that consist of a j -cycle are similar to those required for finding the multiplicities of $(i - 2)$ -CWWCs that consist of a $(j - 2)$ -cycle. This can be seen, for example, by comparing the result of Theorem 2 and the first term in the right hand side of the equation in Theorem 3. Similarly, the multiplicity of $(g + 6)$ -CWWCs that consist of a $(g + 4)$ -cycle is given by

$$N_{g+4} \times \left[\frac{g+4}{2}(d_v + d_c) - (g+4) \right] \times 2(g+6).$$

Also, based on the calculations of Theorem 3, the number of $(g + 6)$ -CWWCs that consist of a $(g + 2)$ -cycle is

$$\begin{aligned}
N_{g+2} & \left[\frac{g+2}{2}(d_v - 2)(d_c - 1) + \frac{g+2}{2}(d_c - 2)(d_v - 1) \right] \\
& + \left(\left[\binom{\frac{g+2}{2}}{2} + \frac{g+2}{2} \right] (d_v - 2)^2 + \left[\binom{\frac{g+2}{2}}{2} + \frac{g+2}{2} \right] (d_c - 2)^2 + \left(\frac{g+2}{2} \right)^2 (d_v - 2)(d_c - 2) \right) \\
& + \left(\binom{g+2}{2} + 2(g+2) + (g+4) \times \left(\frac{g+2}{2}(d_v - 2) + \frac{g+2}{2}(d_c - 2) \right) \right) \times 2(g+6).
\end{aligned}$$

IV. COUNTING LARGE CYCLES IN BI-REGULAR BIPARTITE GRAPHS: COUNTER-EXAMPLES

In this section, we demonstrate that the knowledge of spectrum and degree sequences of a bi-regular bipartite graph is not in general sufficient to determine the multiplicity of cycles of length $2g$ and larger. We start by providing a counter-example of two regular bipartite graphs whose spectrum, degree sequences and girth are identical but have different number of cycles of length $2g$ and larger. To construct this counter-example, we use the concept of *switching* in graphs [21], and in particular, *Godsil-McKay switching* [22]. The latter is a graph transformation that maintains the spectrum of the graph. We also prove that Godsil-McKay switching, in general, maintains the degree sequences of a bi-regular bipartite graph and can thus be used to construct cospectral bi-regular bipartite graphs with similar degree sequences, but different cycle distributions for cycle lengths larger than $2g - 2$.

Theorem 4. [*Godsil-McKay switching* [22]] *Let G be a graph and let $\{X_1, \dots, X_\ell, Y\}$ be a partition of the node set $V(G)$ of G . Suppose that for every node $y \in Y$, and every $i \in \{1, \dots, \ell\}$, the node y has either 0 , $\frac{1}{2}|X_i|$ or $|X_i|$ neighbors in X_i . Moreover, suppose that for each $i, j \in \{1, \dots, \ell\}$ (i and j can be equal), all the nodes in X_i have the same number of neighbors in X_j . Construct a new graph G' as follows: For each $y \in Y$ and $i \in \{1, \dots, \ell\}$ such that y has $\frac{1}{2}|X_i|$ neighbors in X_i , delete the corresponding $\frac{1}{2}|X_i|$ edges and join y instead to the $\frac{1}{2}|X_i|$ other nodes in X_i . Then, the graphs G and G' are cospectral.*

In the above process, the node partition $\{X_1, \dots, X_\ell, Y\}$ is called a *Godsil-McKay switching partition*. In the following, we construct a 3-regular bipartite graph G with girth six. We then use Theorem 4 to convert G to G' , such that G' is also 3-regular and bipartite, and G and G' are cospectral. In our construction of G , we use the Heawood graph [23], shown in Fig. 8. The Heawood graph is a 3-regular bipartite graph with girth six.

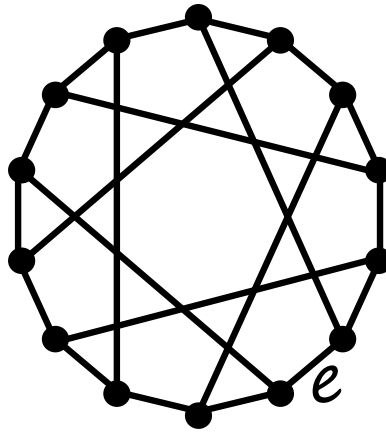

Fig. 8. The Heawood graph.

Construction of G : Consider two disjoint cycles of length 6 and 18 with nodes $d_1d_2 \dots d_6$, and $a_1a_2 \dots a_6b_1 \dots b_6c_1 \dots c_6$, respectively. Add to the graph twelve nodes $v_1, u_1, \dots, v_6, u_6$, and for each $i \in \{1, 2, \dots, 6\}$, add the edges $v_i d_i, v_i a_i, u_i b_i, u_i c_i$. Further add to the graph nodes v', v'', u', u'' , and edges $v'v_1, v'v_3, v'v_5, v''v_2, v''v_4, v''v_6, u'u_3, u'u_5, u''u_4, u''u_6, u'u''$. Now, add a copy of the Heawood graph, and remove one of its circumferential edges such as $e = zz'$ (see Fig. 8). Finally, add the edges u_1z and u_2z' to the graph. The resulting graph is a 3-regular bipartite graph with girth six. We call this graph G . See Fig. 9.

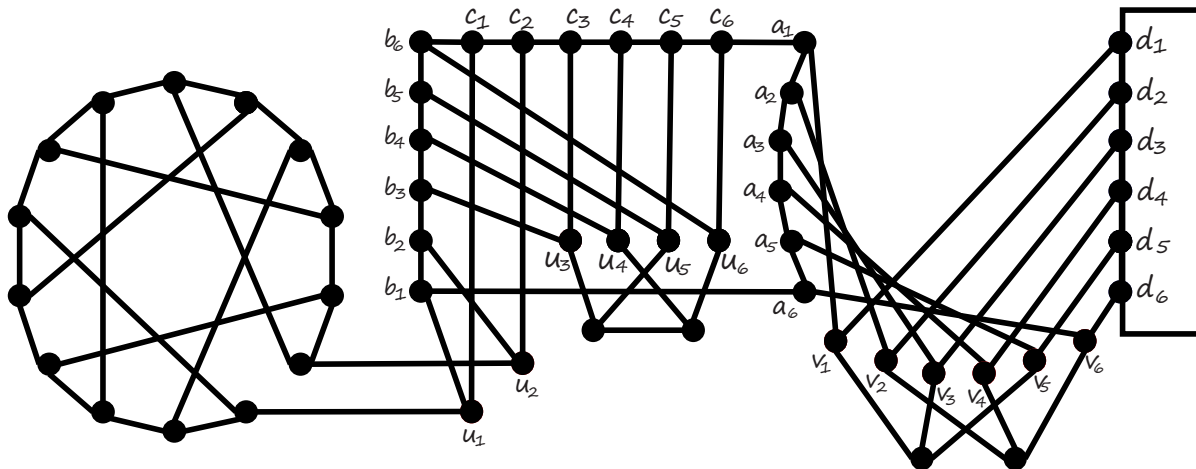

Fig. 9. The 3-regular bipartite graph G .

Construction of G' : We use Theorem 4, and construct G' from G . Let $\ell = 6$, and for each

i , $1 \leq i \leq 6$, let $X_i = \{a_i, b_i, c_i, d_i\}$. Also, Let $Y = V(G) \setminus \cup_{i=1}^6 X_i$. It can be seen that for every node $y \in Y$, and every $i \in \{1, \dots, 6\}$, node y has either 0 or 2 neighbors in X_i (note that for each i , $|X_i| = 4$). Also, for each pair $i, j \in \{1, \dots, \ell\}$, all the nodes in X_i have the same number of neighbors in X_j (see Table IV). Consequently, the partitioning has all the properties of Theorem 4. We can thus apply Godsil-McKay switching, and obtain G' .

TABLE IV

THE (i, j) ENTRY OF THE TABLE SHOWS THE NUMBER OF NEIGHBORS THAT AN ARBITRARY NODE $v \in X_i$ HAS IN THE SET X_j (FOR GODSIL-McKAY SWITCHING PARTITION OF G SHOWN IN FIG. 9).

	X_1	X_2	X_3	X_4	X_5	X_6
X_1	0	1	0	0	0	1
X_2	1	0	1	0	0	0
X_3	0	1	0	1	0	0
X_4	0	0	1	0	1	0
X_5	0	0	0	1	0	1
X_6	1	0	0	0	1	0

Both G and G' are 3-regular bipartite graphs and based on Theorem 4, both have the same spectrum. In Table V, we have listed the number of cycles of length 6 up to 22, for both graphs.⁴ As expected from the results presented in Section III, both graphs have the same cycle distribution for cycles of length up to $2g - 2 = 10$. From the table, however, it can be seen that the multiplicities of cycles of length $2g = 12$ and larger are different in these graphs.

TABLE V

MULTIPLICITIES OF CYCLES OF LENGTH 6 UP TO 22 IN G AND G'

Graph	6-cycles	8-cycles	10-cycles	12-cycles	14-cycles	16-cycles	18-cycles	20-cycles	22-cycles
G	51	54	186	212	460	659	1609	4038	11132
G'	51	54	186	213	458	669	1576	4090	10977

Although, the example just provided was for regular bipartite graphs, one can use the following theorem, whose proof is provided in the Appendix, to construct cospectral (d_v, d_c) -regular

⁴The cycles are counted using a Matlab program by Jeff Howbert [24]. This program counts all cycles in a simple undirected graph up to a specified size limit, using a backtracking algorithm.

bipartite graphs with $d_v \neq d_c$, whose i -cycle multiplicities are different for $i \geq 2g$.

Theorem 5. *Let G be a bi-regular bipartite graph, and suppose that Godsil-McKay switching is used to convert G into G' . Then, the graph G' is also bi-regular and both graphs have the same degree sequences.*

It is important to note that, in general, Godsil-McKay switching does not preserve the degree sequence of a graph. As an example, consider the half-regular bipartite graph G shown in Fig. 10(a). Let $\ell = 3$, and choose $X_1 = \{v_1, v_2, v_3, v_4\}$, $X_2 = \{u_1, u_2, u_3, u_4\}$, $X_3 = \{z_1, z_2, z_3, z_4\}$ and $Y = \{x_1, x_2, x_3\}$. The partitioning has all necessary properties of Theorem 4. (See Table VI, which shows that for each pair $i, j \in \{1, 2, 3\}$, all nodes in X_i have the same number of neighbors in X_j .) We can thus apply Godsil-McKay switching. By applying the switching, we obtain the graph G' , given in Fig. 10(b). One can see that although G' is also half-regular with the same degree of two on the regular side, the degree sequence of the two graphs differ on the irregular side.

TABLE VI

THE (i, j) ENTRY OF THE TABLE SHOWS THE NUMBER OF NEIGHBORS THAT AN ARBITRARY NODE $v \in X_i$ HAS IN THE SET X_j (FOR GODSIL-McKAY SWITCHING PARTITION OF G SHOWN IN FIG. 10(a)).

	X_1	X_2	X_3
X_1	0	1	0
X_2	1	0	1
X_3	0	1	0

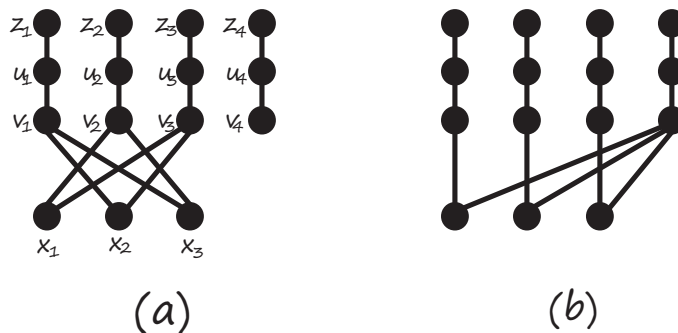

Fig. 10. Two cospectral graphs: (a) G and (b) G' .

V. COMPUTING THE NUMBER OF CYCLES IN IRREGULAR BIPARTITE GRAPHS:
COUNTER-EXAMPLES AND CALCULATION OF N_4

In this section, we consider the problem of counting the cycles of different length in irregular bipartite graphs of different girth g . First, we demonstrate through counter-examples that if $g = 4$, the information of degree sequences and spectrum is, in general, insufficient to count i -cycles for any $i \geq g + 2$. For $g \geq 6$, we show by counter-examples that spectrum and degree sequences cannot, in general, uniquely determine the multiplicity of i -cycles for any $i \geq g$. The results for the case of $g \geq 8$ are provided before those of $g = 6$, since the graphs constructed for the former case are used as building blocks for graph constructions in the latter. We end this section with a positive result, i.e., to compute the number of 4-cycles of an irregular bipartite graph from its spectrum and degree sequences.

A. $g = 4$: Counter-example for i -cycles, $i \geq g + 2$

In this subsection, we construct two half-regular bipartite graphs such that they both have the same spectrum, degree sequence and girth 4, but have different number of i -cycles for $i \geq 6$.

Construction of the graph \mathcal{G} :

Consider two disjoint cycles of length 4 and 12 with node sets $\{v_1, v_2, v_3, v_4\}$, and $\{u_1, u_2, \dots, u_{12}\}$, respectively. Add two nodes w and w' to the union of the cycles, and connect both w and w' to the nodes v_1, v_3, u_1, u_3 . Also, add another node w'' , and connect it to the nodes u_5, u_7, u_9, u_{11} . Finally, add two more nodes x and y to the graph, and connect them to the nodes $v_2, v_4, u_2, u_4, u_6, u_8, u_{10}, u_{12}$. Call the resultant graph \mathcal{G} . The graph \mathcal{G} is bipartite, and has 21 nodes and its girth is 4. See Fig. 11. Consider the node partition $V(G) = U \cup W$ for \mathcal{G} , where $W = \{x, y, v_1, v_3, u_1, u_3, u_5, u_7, u_9, u_{11}\}$. We thus have $n = |U| = 11$ and $m = |W| = 10$. The degree sequence of W is $(8, 8, 4, 4, 4, 4, 3, 3, 3, 3)$, and the degree of each node in U is 4. Thus, \mathcal{G} is variable-regular with variable degree 4.

Construction of \mathcal{G}' from \mathcal{G} : We use Godsil-McKay switching of Theorem 4. We choose $\ell = 2$, $X_1 = \{v_i, u_i : i \text{ is odd}\}$ and $X_2 = \{v_i, u_i : i \text{ is even}\}$. Thus, $|X_1| = |X_2| = 8$. Also, we select $Y = \{w, w', w'', x, y\}$. Nodes w, w' and w'' , each has 4 neighbors in X_1 , and no neighbor in X_2 . Also, each of the nodes x and y has 8 neighbors in X_2 and no neighbor in X_1 . Moreover, for each pair $i, j \in \{1, 2\}$, all nodes in X_i have the same number of neighbors in X_j (see Table VII). The partitioning has all necessary properties of Theorem 4, and thus, we can apply Godsil-McKay switching. By applying the switching, we obtain the graph \mathcal{G}' , which has the same degree sequences as \mathcal{G} . In Table VIII, we have listed the cycle distribution of both graphs

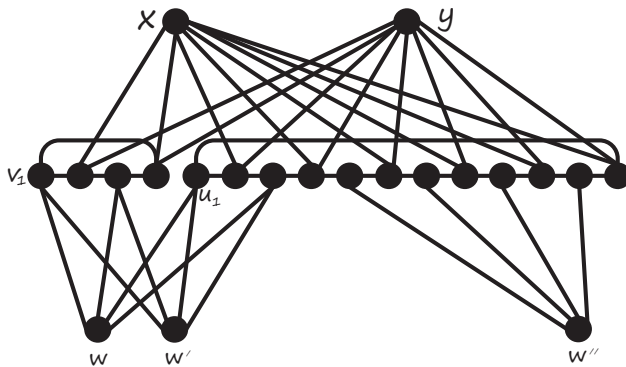
Fig. 11. Graph \mathcal{G} of Subsection V-A.

for cycle lengths up to 18. One can see that \mathcal{G} and \mathcal{G}' , although having the same spectrum, degree sequences and $g = 4$, have different number of i -cycles for $i = 6, 8, \dots, 18$.

TABLE VII

THE (i, j) ENTRY OF THE TABLE SHOWS THE NUMBER OF NEIGHBORS THAT AN ARBITRARY NODE $v \in X_i$ HAS IN THE SET X_j , FOR THE GODSIL-MCKAY SWITCHING PARTITION OF THE GRAPH \mathcal{G} OF FIG. 11.

	X_1	X_2
X_1	0	2
X_2	2	0

TABLE VIII

MULTIPLICITIES OF CYCLES OF LENGTH 4 UP TO 18 IN \mathcal{G} AND \mathcal{G}' , CONSTRUCTED IN SUBSECTION V-A

Graph	4-cycles	6-cycles	8-cycles	10-cycles	12-cycles	14-cycles	16-cycles	18-cycles
\mathcal{G}	60	248	1300	4056	11992	29780	43040	32640
\mathcal{G}'	60	250	1294	4026	11706	28440	41656	32096

B. $g \geq 8$: Counter-examples for i -cycles with $i \geq g$

In this subsection, we consider irregular bipartite graphs with girth g at least eight, and demonstrate that the information of spectrum, and degree sequences is not sufficient, in general, to determine the multiplicity of i -cycles for $i \geq g$. For this, for each $t \geq 1$, we first construct

two irregular bipartite graphs G_t and G'_t such that they have the same spectrum and degree sequences, but different number of $(6 + 2t)$ -cycles (one vs. zero). The disjoint union of these graphs can then be used to provide counter-examples for cospectral irregular graphs with the same degree sequences and the same girth g (for any girth $g \geq 8$), but with different number of i -cycles for any $i \geq g$.

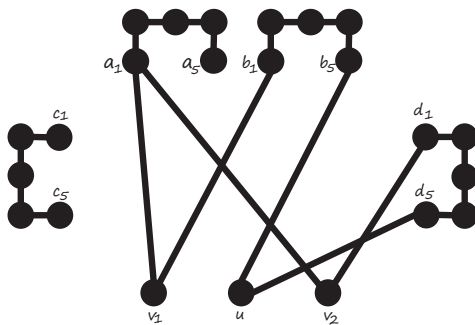

Fig. 12. Graph G_4 constructed in Subsection V-B.

Construction of the graph G_t : Consider the integer $t \geq 1$, and four paths, each of length t , with the node sets $\{a_1, \dots, a_{t+1}\}$, $\{b_1, \dots, b_{t+1}\}$, $\{c_1, \dots, c_{t+1}\}$, and $\{d_1, \dots, d_{t+1}\}$, respectively. Then, add three nodes v_1, v_2 and u , and the edges $v_1a_1, v_1b_1, v_2a_1, v_2d_1, ud_{t+1}$ and ub_{t+1} , to the graph. Call the resultant bipartite graph G_t . As an example, the graph G_4 is shown in Fig. 12. The graph G_t has $4t + 7$ nodes and only one cycle of length $6 + 2t$. From $4t + 7$ nodes, $4t + 3$ are of degree 2, one node has degree 3 and three nodes have degree 1.

Constructing G'_t from G_t : We use Godsil-McKay switching of Theorem 4 with $\ell = t + 1$, and for each i , $1 \leq i \leq t + 1$, we select $X_i = \{a_i, b_i, c_i, d_i\}$. We thus have $Y = \{v_1, v_2, u\}$. It can be seen that, for every node $y \in Y$, and every $i \in \{1, \dots, t + 1\}$, the node y has either 0 or 2 neighbors in X_i (note that for each i , $|X_i| = 4$). Also, for each pair $i, j \in \{1, \dots, t + 1\}$, all the nodes in X_i have the same number of neighbors in X_j . The (i, j) entry of the following matrix

shows the number of neighbors that an arbitrary node $v \in X_i$ has in the set X_j :

$$\begin{bmatrix} 0 & 1 & 0 & 0 & \cdots & 0 & 0 & 0 \\ 1 & 0 & 1 & 0 & \cdots & 0 & 0 & 0 \\ 0 & 1 & 0 & 1 & \cdots & 0 & 0 & 0 \\ \vdots & \vdots & \vdots & \vdots & \ddots & \vdots & \vdots & \vdots \\ 0 & 0 & 0 & 0 & \cdots & 1 & 0 & 1 \\ 0 & 0 & 0 & 0 & \cdots & 0 & 1 & 0 \end{bmatrix}.$$

This matrix shows that for each pair $i, j \in \{1, \dots, \ell\}$, all the nodes in X_i have the same number of neighbors in X_j . Thus, the node partitioning has all the necessary properties of Theorem 4 for the application of Godsil-McKay switching. By applying the switching, we obtain the graph G'_t . For example, corresponding to G_4 in Fig. 12, we obtain the graph G'_4 , shown in Fig. 13. The graph G'_t has the same spectrum and degree sequences as G_t , but does not have any cycle.

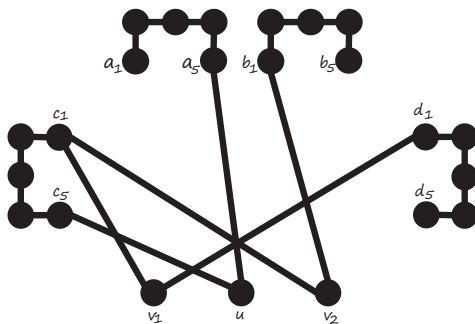

Fig. 13. Graph G'_4 , obtained by Godsil-McKay switching from G_4 , shown in Fig. 12.

Remark 1. Consider the graph G_t , where t is an even number. Consider the partition $V(G_t) = U \cup W$ for the nodes of G_t , where $U = \{v_1, v_2, u\} \cup \{a_i, b_i, c_i, d_i : i \text{ is even}\}$. The graphs G_t and G'_t are variable-regular with variable degree 2. We thus conclude that the number of g -cycles in half-regular bipartite graphs cannot be, in general, computed using the spectrum and the degree sequences of the graph when the girth of the variable-regular bipartite graph is $g = 6 + 2t$, where $t \geq 2$ is an even number.

C. $g = 6$: Counter-examples for i -cycles with $i \geq g$

In this subsection, we first provide a counter-example of two cospectral irregular graphs with similar degree sequences and $g = 6$, but different N_6 . We then construct two irregular bipartite

graphs $G_{t,k}$ and $G'_{t,k}$ with girth 6, such that they both have the same spectrum and degree sequences, but different multiplicity for i -cycles with $i \geq g + 2$.

1) *Counter-example for 6-cycles:* Consider the disjoint union of two 6-cycles and two paths, each of length 5, and call it G_1 (i.e., $G_1 = 2C_6 \cup 2P_5$). Also, consider the disjoint union of a 6-cycle, a 14-cycle and two paths, each of length one, and call it G_2 (i.e., $G_2 = C_6 \cup C_{14} \cup 2P_2$). It is easy to see that G_1 and G_2 are irregular bipartite graphs with the same degree sequences (both have ten nodes with degree 2 and two nodes with degree 1 on each side of the bipartition). Using (1) and (2), one can also see that G_1 and G_2 are cospectral. The girth of both graphs is six, but they have different number of 6-cycles (two vs. one).

2) *Counter-example for i -cycles with $i \geq g + 2$:* Construction of the graph $G_{t,k}$: Let t and k be two integers such that $t > k \geq 0$, and $t + k$ is an even number. Consider the graph G_t which was constructed in Subsection V-B. Add a path of length k with the node set $\{f_1, \dots, f_{k+1}\}$, as well as the edges uf_1 and v_2f_{k+1} to G_t . Call the resultant graph $G_{t,k}$. As an example, the graph $G_{4,2}$ is shown in Fig. 14(a). The graph $G_{t,k}$ has $4t + k + 8$ nodes, out of which, $4t + k + 2$ nodes have degree 2, three have degree 3, and three have degree 1. The graph is also bipartite and has one cycle of length $t + k + 4$, one cycle of length $t + k + 6$ and one cycle of length $6 + 2t$.

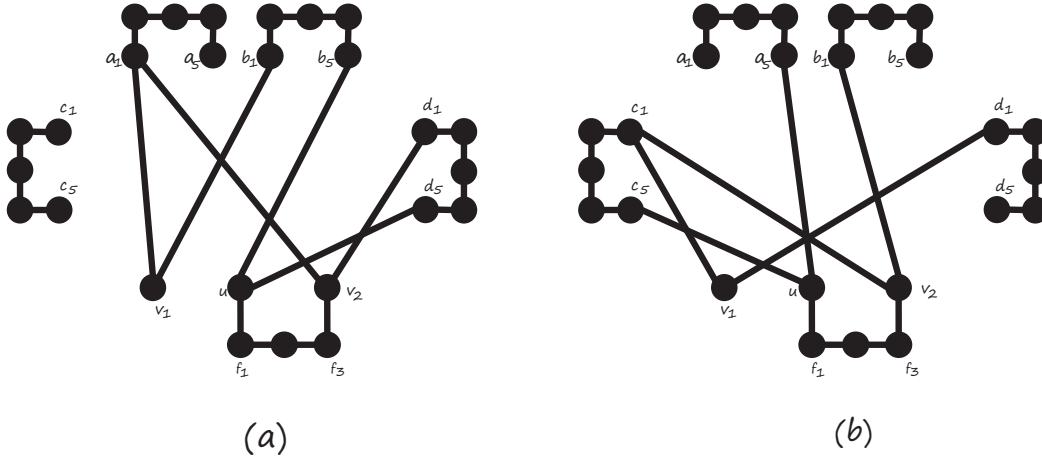

Fig. 14. Graphs (a) $G_{4,2}$ and (b) $G'_{4,2}$.

Construction of $G'_{t,k}$ from $G_{t,k}$: We use Godsil-McKay switching to transform $G_{t,k}$ into $G'_{t,k}$. Let $\ell = t + 1$, and for each i , $1 \leq i \leq t + 1$, let $X_i = \{a_i, b_i, c_i, d_i\}$. We then have $Y = \{v_1, v_2, u, f_1, f_2, \dots, f_{k+1}\}$. All the conditions of Theorem 4 apply to this partition. We call the graph obtained by the switching $G'_{t,k}$. The graph $G'_{t,k}$ can also be generated directly from G'_t ,

the Godsil-McKay switched version of G_t : Add to G'_t a path of length k with the node set $\{f_1, \dots, f_{k+1}\}$, and the edges uf_1 and v_2f_{k+1} . As an example, in Fig. 14(b), the graph $G'_{4,2}$ is shown. The graph $G'_{t,k}$ has the same spectrum and degree sequences as $G_{t,k}$, but has only one cycle of length $t + k + 4$.

Now, for a fixed $i \geq 1$, consider the disjoint union of graphs $G_{2,0}, G_{3,1}, \dots, G_{i+2,i}$, and call it D_i . Also, use D'_i to denote the disjoint union of graphs $G'_{2,0}, G'_{3,1}, \dots, G'_{i+2,i}$. For each $j \in \{0, \dots, i\}$, the graph $G_{j+2,j}$ has one $(2j + 6)$ -cycle, one $(2j + 8)$ -cycle and one $(2j + 10)$ -cycle. Also, the graph $G'_{j+2,j}$ has only one cycle of length $2j + 6$. Considering that the spectrum of a disconnected graph is the disjoint union of the spectra of its components, one can see that D_i and D'_i are cospectral. They also have the same degree sequences and girth $g = 6$. It can however, be seen that while both graphs have only one cycle of length 6, they have different number of k -cycles for each $6 < k \leq 2i + 10$. As an example, the cycle distributions of D_3 and D'_3 are given in Table IX.

TABLE IX
MULTIPLICITIES OF CYCLES OF LENGTH 6 UP TO 16 IN GRAPHS D_3 AND D'_3

Graph	6-cycles	8-cycles	10-cycles	12-cycles	14-cycles	16-cycles
D_3	1	2	3	3	2	1
D'_3	1	1	1	1	0	0

D. Calculation of N_4

Theorem 6. Let G be an irregular bipartite graph with the node set $V(G) = U \cup W$, where $U = \{u_1, u_2, \dots, u_n\}$, $W = \{w_1, w_2, \dots, w_m\}$, and in which, the degree of node u_i is d_i and the degree of node w_i is d'_i . We then have

$$N_4 = \frac{\sum_{j=1}^{|V(G)|} \lambda_j^4 - \sum_{u_j \in U} d_j(2d_j - 1) - \sum_{w_j \in W} d'_j(2d'_j - 1)}{8}, \quad (9)$$

where N_4 and $\{\lambda_j\}$ are the number of 4-cycles and the spectrum of G , respectively.

Proof. In G , the set of closed walks of length 4 can be partitioned into two categories: (1) 4-cycles (2) closed cycle-free walks of length 4. Let $\Omega_i(G), i \geq 2$, denote the number of closed

cycle-free walks of length i in G , and $S_{u,G,i}$ ($S_{w,G,i}$) be the number of closed cycle-free walks of length i from the variable node u (the check node w) to itself in G . We have

$$\Omega_i(G) = \sum_{u \in U} S_{u,G,i} + \sum_{w \in W} S_{w,G,i}, \quad (10)$$

and

$$N_4 = \frac{\sum_{j=1}^{|V(G)|} \lambda_j^4 - \Omega_4(G)}{8}. \quad (11)$$

We can have three different types of closed cycle-free walks of length 4. See Fig. 15. The number of closed cycle-free walks of length 4 of Type 1 from u_j to itself is $d_j(d_j - 1)$. That number for Type 2 is d_j , and for Type 3 is $\sum_{w_k \in N(u_j)} (d'_k - 1)$, where $N(u_j)$ is the set of neighbors of u_j . Thus,

$$S_{u_j,G,4} = d_j^2 + \sum_{w_k \in N(u_j)} (d'_k - 1). \quad (12)$$

Similarly, for a check node w_j , we have:

$$S_{w_j,G,4} = (d'_j)^2 + \sum_{u_k \in N(w_j)} (d_k - 1). \quad (13)$$

By (12):

$$\begin{aligned} \sum_{u_j \in U} S_{u_j,G,4} &= \sum_{u_j \in U} d_j^2 + \sum_{u_j \in U} \sum_{w_k \in N(u_j)} (d'_k - 1) \\ &= \sum_{u_j \in U} d_j^2 + \sum_{w_k \in W} d'_k (d'_k - 1). \end{aligned} \quad (14)$$

Similar to (14), we have:

$$\sum_{w_j \in W} S_{w_j,G,4} = \sum_{w_j \in W} (d'_j)^2 + \sum_{u_k \in U} d_k (d_k - 1). \quad (15)$$

By using (14) and (15) in (10), we have:

$$\Omega_4(G) = \sum_{u_j \in U} d_j(2d_j - 1) + \sum_{w_j \in W} d'_j(2d'_j - 1). \quad (16)$$

Combining (16) with (11) completes the proof. ■

It can be seen that the result of Theorem 6 reduces to that of Theorem 1 for 4-cycles in bi-regular bipartite graphs.

Example 6. Consider the irregular bipartite graph \mathcal{G} shown in Fig. 11. For this graph, we have $\sum_{u_j \in U} d_j(2d_j - 1) + \sum_{w_j \in W} d'_j(2d'_j - 1) = 720$. Also, $\sum \lambda_j^4 = \text{tr}(A(G)^4) = 1200$. Thus, by Theorem 6, we have $N_4 = (1200 - 720)/8 = 60$. This matches the result reported in Table VIII.

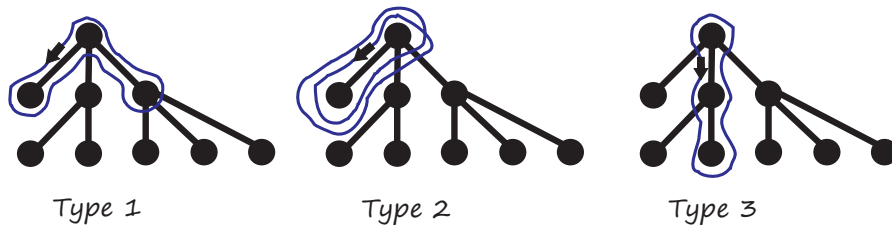

Fig. 15. The three different types of closed cycle-free walks of length 4.

Example 7. Consider a path P_5 of length 4. The spectrum of P_5 is $\{\sqrt{3}, 1, 0, -1, -\sqrt{3}\}$. Thus, we have $\sum \lambda_j^4 = 20$. For P_5 , we also have $\sum_{u_j \in U} d_j(2d_j - 1) + \sum_{w_j \in W} d'_j(2d'_j - 1) = 20$. Thus, by Theorem 6, $N_4 = (20 - 20)/8 = 0$, which is clearly the correct answer.

VI. COUNTING CYCLES IN HALF-REGULAR BIPARTITE GRAPHS: CALCULATION OF N_6 FOR GRAPHS WITH $g \geq 6$ AND COUNTER-EXAMPLES FOR OTHER CASES

The counter-example constructed in Subsection V-A for $g = 4$ was based on half-regular bipartite graphs. We thus know that if $g = 4$, the knowledge of spectrum and degree sequences is not sufficient in general to count the number of i -cycles for $i \geq g + 2$ in half-regular bipartite graphs. On the other hand, the positive result of Subsection V-D is applicable to half-regular graphs and can be used to compute N_4 . Furthermore, in Remark 1, we showed that, in general, one cannot find N_g for $g = 6 + 2t$, where $t \geq 2$ is an even number, in half-regular graphs just by using the information of spectrum and degree sequences. In this section, we complement these results by computing N_6 for half-regular bipartite graphs with $g \geq 6$, in terms of graph's spectrum and degree sequences. We also show by counter-examples that similar results are not available, in general, for g -cycles if $g = 6 + 2t$, where $t \geq 1$ is an odd number, or for i -cycles with $i \geq g + 2$, in graphs with $g \geq 6$.

A. Computing N_6 for half-regular bipartite graphs with $g \geq 6$

In the following, without loss of generality, we assume that the graphs are regular on the variable side, i.e., they are variable-regular.

Theorem 7. Let G be a variable-regular bipartite graph with girth at least six and node set $V(G) = U \cup W$, where $U = \{u_1, u_2, \dots, u_n\}$, $W = \{w_1, w_2, \dots, w_m\}$, and in which, the degree of every node $u_i \in U$ is d_v , and the degree of node w_i is d'_i . We then have

$$\begin{aligned} 12N_6 &= \sum_{j=1}^{|V(G)|} \lambda_j^6 - n \times d_v \left(1 + 3(d_v - 1) + 2(d_v - 1)(d_v - 2) \right) \\ &\quad - \sum_{w_j \in W} \left(d'_j(3d'_j - 2) + 2d'_j(d'_j - 1)(d'_j - 2) + 6d'_j(d'_j - 1)(d_v - 1) \right) \\ &\quad - \sum_{w_j \in W} \left(3d'_j(d'_j - 1 + d_v - 1) \right), \end{aligned}$$

where N_6 and $\{\lambda_j\}$ are the number of 6-cycles and the spectrum of G , respectively.

Proof. For the graph G , we partition the set of closed walks of length 6 into two categories: (1) 6-cycles (2) Closed cycle-free walks of length 6. Let $\Omega_6(G)$ denote the number of closed cycle-free walks of length 6 in the graph G , and let $S_{u,G,6}$ ($S_{w,G,6}$) be the number of closed cycle-free walks of length 6 from the variable node u (check node w) to itself. We thus have: $\Omega_6(G) = \sum_{u \in U} S_{u,G,6} + \sum_{w \in W} S_{w,G,6}$. We have twelve different types of closed cycle-free walks of length 6. See Fig. 16.

Next, we calculate the number of closed cycle-free walks of length 6 for each type:

Type 1 The number of closed walks of Type 1 from any variable node u_j to itself is d_v . This number for the check node w_j is d'_j . Thus, the total number is

$$n \times d_v + \sum_{w_j \in W} d'_j. \quad (17)$$

Types 2, 3, 4 The total number of closed walks of Types 2, 3, and 4 from any variable node u_j to itself is $3d_v(d_v - 1)$. Similarly, for the check node w_j , this number is $3d'_j(d'_j - 1)$. The total number is thus

$$n \times 3d_v(d_v - 1) + \sum_{w_j \in W} 3d'_j(d'_j - 1). \quad (18)$$

Type 5 The number of closed walks of Type 5 from any variable node u_j to itself is $d_v(d_v - 1)(d_v - 2)$. Similarly, for the check node w_j , the number is $d'_j(d'_j - 1)(d'_j - 2)$. So, the total number is

$$n \times d_v(d_v - 1)(d_v - 2) + \sum_{w_j \in W} d'_j(d'_j - 1)(d'_j - 2). \quad (19)$$

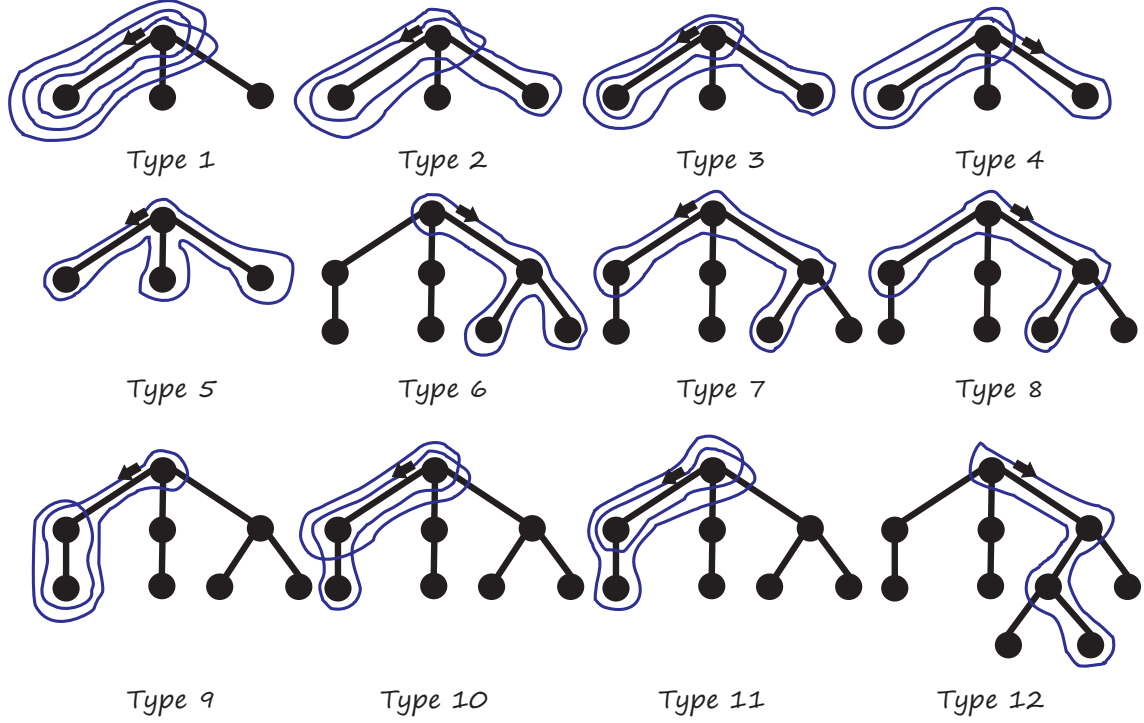

Fig. 16. The twelve different types of closed cycle-free walks of length 6.

Type 6 The number of closed walks of Type 6 from the variable node u_j to itself is $\sum_{w_k \in N(u_j)} (d'_k - 1)(d'_k - 2)$. Similarly, for the check node w_j , the number is $\sum_{u_k \in N(w_j)} (d_v - 1)(d_v - 2)$, and thus the total number is

$$n \times d_v(d_v - 1)(d_v - 2) + \sum_{w_j \in W} d'_j(d'_j - 1)(d'_j - 2). \quad (20)$$

Types 7, 8 The total number of closed walks of Types 7 and 8 from the variable node u_j to itself is $2(d_v - 1) \sum_{w_k \in N(u_j)} (d'_k - 1)$. Similarly, for the check node w_j , the number is $2d'_j(d'_j - 1)(d_v - 1)$. Thus, the total number is

$$4(d_v - 1) \sum_{w_j \in W} d'_j(d'_j - 1). \quad (21)$$

Types 9, 10, 11 The total number of closed walks of Types 9, 10 and 11 from the variable node u_j to itself is $3 \sum_{w_k \in N(u_j)} (d'_k - 1)$. Similarly, for the check node w_j , the number is $3d'_j(d_v - 1)$. Thus the total number is

$$\sum_{w_j \in W} \left(3d'_j(d'_j - 1) + 3d'_j(d_v - 1) \right). \quad (22)$$

Type 12 The number of closed walks of Types 12 from the variable node u_j to itself is $\sum_{w_k \in N(u_j)} \sum_{u_\ell \in N(w_k)} (d_v - 1)$. Similarly, for the check node w_j , the number is $\sum_{u_k \in N(w_j)} \sum_{w_\ell \in N(u_k)} (d'_\ell - 1)$. Thus the total number is

$$\sum_{u_j \in U} \sum_{w_k \in N(u_j)} \sum_{u_\ell \in N(w_k)} (d_v - 1) + \sum_{w_j \in W} \sum_{u_k \in N(w_j)} \sum_{w_\ell \in N(u_k)} (d'_\ell - 1). \quad (23)$$

The two terms in (23) can be simplified as follows:

$$\sum_{u_j \in U} \sum_{w_k \in N(u_j)} \sum_{u_\ell \in N(w_k)} (d_v - 1) = \sum_{w_j \in W} d'_j (d'_j - 1) (d_v - 1),$$

and

$$\sum_{w_j \in W} \sum_{u_k \in N(w_j)} \sum_{w_\ell \in N(u_k)} (d'_\ell - 1) = \sum_{w_j \in W} d'_j (d_v - 1) (d'_j - 1).$$

Consequently, the total number in (23) can be written as

$$2(d_v - 1) \sum_{w_j \in W} d'_j (d'_j - 1). \quad (24)$$

By adding up (17), (18), (19), (20), (21), (22) and (24), we have

$$\begin{aligned} \Omega_6(G) &= n \times d_v \left(1 + 3(d_v - 1) + 2(d_v - 1)(d_v - 2) \right) \\ &\quad + \sum_{w_j \in W} \left(d'_j (3d'_j - 2) + 2d'_j (d'_j - 1)(d'_j - 2) + 6d'_j (d'_j - 1)(d_v - 1) \right) \\ &\quad + \sum_{w_j \in W} \left(3d'_j (d'_j - 1 + d_v - 1) \right) \end{aligned}$$

This, together with $N_6 = (\sum_j \lambda_j^6 - \Omega_6(G))/12$, complete the proof. ■

One can see that the result of Theorem 7 reduces to that of Theorem 1, for the special case of bi-regular bipartite graphs with $g \geq 6$.

Example 8. Consider the variable-regular bipartite graph G shown in Fig. 17. In G , we have $d_v = 2$, and the degree sequence of check nodes is $(6, 4, 3, 3, 3, 2, 2, 1)$. Also, $n = 12$ and $m = 8$. By inspection, it is clear that G has five 6-cycles. Now, we compute the number of 6-cycles by Theorem 7. We have $\text{tr}(A(G)^6) = 1344$, and $\Omega_6(G) = 1284$. Thus, $N_6 = (1344 - 1284)/12 = 5$.

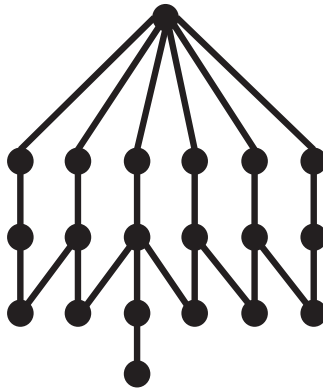

Fig. 17. The variable-regular graph G of Example 8.

B. Counter-examples for g -cycles ($g = 6 + 2t, t \geq 1$ and odd)

Consider the disjoint union of two cycles, each of length $6 + 2t$, and two paths, each of length $6 + t$, and call it G_1 . Also, consider the disjoint union of a $(6 + 2t)$ -cycle, a $(14 + 2t)$ -cycle and two paths, each of length $t + 1$, and call it G_2 . One can see that both G_1 and G_2 are half-regular bipartite graphs and have the same degree sequences (the regular side has $11 + 3t$ degree-2 nodes and the irregular side has $9 + 3t$ degree-2 and 4 degree-1 nodes). Using (1) and (2), one can also see that G_1 and G_2 are cospectral, and both have girth $g = 6 + 2t$. The number of g -cycles N_g , however, is different for each graph (two vs. one).

C. $g \geq 6$: Counter-examples for i -cycles, $i \geq g + 2$

In this subsection, we construct variable-regular bipartite graphs that have the same spectrum, degree sequences and girth $g \geq 6$, but have different multiplicities of i -cycles for $i \geq g + 2$. We first start by constructing two graphs $\mathcal{G}_{t,k}$ and $\mathcal{G}'_{t,k}$, related by Godsil-McKay switching.

Construction of the graph $\mathcal{G}_{t,k}$: Let t and k be two even integers such that $t \geq k \geq 0$ and $t > 0$. Consider the graph $G_{t,k}$ which was constructed in Subsection V-C. For each node z in the set $\{a_i, b_i, c_i, d_i, f_i : i \text{ even}\} \cup \{v_1\}$, add a new node z' to $G_{t,k}$, and connect z to z' . Call the resultant variable-regular graph $\mathcal{G}_{t,k}$. As an example, Fig. 18(a) shows $\mathcal{G}_{4,2}$. The graph $\mathcal{G}_{t,k}$ is bipartite and has one cycle of length $t + k + 4$, one cycle of length $t + k + 6$ and one cycle of length $6 + 2t$. (Note that if $t = k$, then the graph $\mathcal{G}_{t,k}$ has one cycle of length $2t + 4$, and two cycles of length $2t + 6$.)

Construction of the graph $\mathcal{G}'_{t,k}$: We use Godsil-McKay switching of Theorem 4 to construct $\mathcal{G}'_{t,k}$ from $\mathcal{G}_{t,k}$. Let $\ell = 3t/2 + 1$, and for each i , $1 \leq i \leq t + 1$, let $X_i = \{a_i, b_i, c_i, d_i\}$. Also, for each i , $t + 2 \leq i \leq 3t/2 + 1$, let $j = 2(i - t - 1)$, and $X_i = \{a'_j, b'_j, c'_j, d'_j\}$. We thus have $Y = \{v_1, v_2, u, f_1, f_2, \dots, f_{k+1}\} \cup \{f'_i : i \text{ even}\} \cup \{v'_1\}$. It can be seen that this partitioning satisfies all the required conditions of Theorem 4. We thus apply the switching and obtain the graph $\mathcal{G}'_{t,k}$. The graph $\mathcal{G}'_{t,k}$ can also be constructed by the following approach: Consider the graph $G'_{t,k}$ which was constructed in Subsection V-B. For each node z in the set $\{a_i, b_i, c_i, d_i, f_i : i \text{ even}\} \cup \{v_1\}$, add a new node z' to $G'_{t,k}$, and connect z to z' . As an example, Fig. 18(b) shows the graph $\mathcal{G}'_{4,2}$. The graph $\mathcal{G}'_{t,k}$ is also variable-regular bipartite and has the same spectrum and degree sequences as $\mathcal{G}_{t,k}$. It however, has only one cycle of length $t + k + 4$.

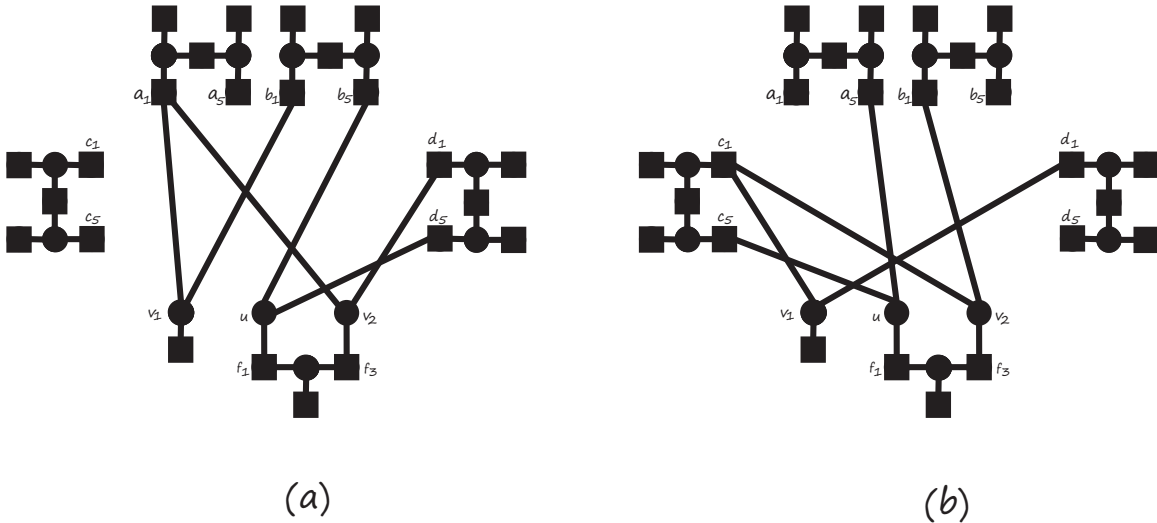

Fig. 18. Graphs (a) $\mathcal{G}_{4,2}$ and (b) $\mathcal{G}'_{4,2}$.

Let i be an even number. The graph $\mathcal{G}_{i+2,i}$ has one $(2i + 6)$ -cycle, one $(2i + 8)$ -cycle and one $(2i + 10)$ -cycle. The graph $\mathcal{G}'_{i+2,i}$, however, has only one cycle of length $2i + 6$. Now, for fixed integers j and k satisfying $j \geq k \geq 1$, consider the disjoint union of graphs $\mathcal{G}_{2k,2k-2}, \mathcal{G}_{2k+2,2k}, \dots, \mathcal{G}_{2j,2j-2}$, and call it $\mathcal{F}_{j,k}$. Also, consider the disjoint union of graphs $\mathcal{G}'_{2k,2k-2}, \mathcal{G}'_{2k+2,2k}, \dots, \mathcal{G}'_{2j,2j-2}$, and call it $\mathcal{F}'_{j,k}$. Both $\mathcal{F}_{j,k}$ and $\mathcal{F}'_{j,k}$ have the same spectrum and degree sequences. They also have the same girth of $4k + 2$, and both have one $(4k + 2)$ -cycle. They however, have different number of ℓ -cycles for any $4k + 2 < \ell \leq 4j + 6$.

To cover the cases where $g = 4(k + 1)$, $k \geq 1$, let k' be an odd number satisfying $k' > 2k + 1$, and consider two graphs G_1 and G_2 , where G_1 is the disjoint union of the cycle $C_{4(k+1)}$ and two

copies of the path $P_{k'}$, and G_2 is the disjoint union of $C_{2(k'+1)}$, and two copies of the path P_{2k+1} . One can see that G_1 and G_2 are half-regular bipartite graphs with similar degree sequences. It can also be seen, using (1) and (2), that both graphs have the same spectrum. The two graphs, however, have different cycle distributions, i.e., while G_1 has one cycle of length $4(k+1)$, G_2 has one cycle of larger length $2(k'+1)$. Now, if one considers the disjoint unions of G_1 and G_2 with a cycle of length $4(k+1)$, then the resultant graphs both have the same girth of $4(k+1)$, but they have different number of cycles of length $2(k'+1)$.

VII. NUMERICAL RESULTS

In this section, we compute the multiplicity of short cycles in the Tanner graphs of some LDPC codes using the closed form formulas that we derived in previous sections. We then compare the results with those obtained by the backtracking algorithm of [24] to verify that they match.

A. Random $(3, 6)$ -regular Tanner graph

We consider a random $(3, 6)$ -regular LDPC code with block length $n = 96$, rate $R = 0.5$ and girth $g = 6$ [25]. For this code, we have $m = n/2 = 48$. We consider the adjacency matrix $A(G)$ of the Tanner graph G of this code, and obtain $\text{tr}(A(G)^6) = 44736$. From Table II, we have: $S_{3,6,6} = 222$, $S_{6,3,6} = 444$, and thus, by (4), we obtain: $\Omega_6(3, 6, G) = 42624$. Consequently, by Theorem 1, we have $N_6 = (44736 - 42624)/12 = 176$.

To compute N_8 , we first find $\text{tr}(A(G)^8) = 507744$. Then, from Table II, we obtain: $S_{3,6,8} = 2226$ and $S_{6,3,8} = 4452$, and by (4), we have: $\Omega_8(4, 8, G) = 427392$. Also, $N_6 \times [\frac{g}{2}(d_v + d_c) - g] \times 2(g+2) = 59136$. Consequently, by Theorem 1, we compute $N_8 = (507744 - 427392 - 59136)/(2 \times 8) = 1326$.

Finally for N_{10} , we first obtain $\text{tr}(A(G)^{10}) = 6592396$. Then, from Table II, we have: $S_{3,6,10} = 23478$ and $S_{6,3,10} = 46956$. Thus, by (4), we obtain: $\Omega_6(3, 6, G) = 4507776$. Also, by Theorem 3, $\Psi_{g+4}(d_v, d_c, G) = 1883040$. Thus, by Theorem 1, we have $N_{10} = (6592396 - 4507776 - 1883040)/20 = 10079$.

All the values obtained for N_6 , N_8 and N_{10} match the results from [24].

B. Random $(4, 8)$ -regular LDPC code

Here, we consider a random $(4, 8)$ -regular LDPC codes with $n = 1000$, $m = 500$, $R = 0.5$ and $g = 6$ [25]. For the Tanner graph G of this code, we have $\text{tr}(A(G)^6) = 1154552$. From Table

II, $S_{4,8,6} = 568$ and $S_{8,4,6} = 1136$. Thus, by (4), we have $\Omega_6(4, 8, G) = 1136000$. Consequently, by Theorem 1, we compute $N_6 = (1154552 - 1136000)/12 = 1546$.

For N_8 , we have $\text{tr}(A(G)^8) = 17157728$. From Table II, $S_{4,8,8} = 8012$ and $S_{8,4,8} = 16024$. Thus, by (4), we have $\Omega_8(4, 8, G) = 16024000$. Also, $N_g \times [\frac{g}{2}(d_v + d_c) - g] \times 2(g+2) = 742080$. Therefore, by Theorem 1, we compute $N_8 = (17157728 - 16024000 - 742080)/(2 \times 8) = 24478$.

For N_{10} , $\text{tr}(A(G)^{10}) = 287190160$. From Table II, $S_{4,8,10} = 119464$ and $S_{8,4,10} = 238928$. Thus, by (4), $\Omega_{10}(4, 8, G) = 238928000$. Also, by Theorem 3, $\Psi_{g+4}(d_v, d_c, G) = 40082360$. Thus, by Theorem 1, we have $N_{10} = (287190160 - 238928000 - 40082360)/20 = 408990$.

All the values obtained for N_6 , N_8 and N_{10} match the results from [24].

C. Margulis (2640, 1320) code

As the next example, we consider Margulis (2640, 1320) code with $g = 8$ [25]. This code is a $(3, 6)$ -regular LDPC code with $n = 2640$ and $m = 1320$. For Tanner graph G of this code, we have $\text{tr}(A(G)^8) = 11774400$. From Table II, $S_{3,6,8} = 2226$ and $S_{6,3,8} = 4452$. Thus, by (4), $\Omega_8(3, 6, G) = 11753280$. By Theorem 1, we then have $N_8 = (11774400 - 11753280)/16 = 1320$.

To compute N_{10} , we first obtain $\text{tr}(A(G)^{10}) = 124924800$. From Table II, $S_{3,6,10} = 23478$ and $S_{6,3,10} = 46956$. Thus, by (4), $\Omega_{10}(3, 6, G) = 123963840$. Also, $N_g \times [\frac{g}{2}(d_v + d_c) - g] \times 2(g+2) = 739200$. By Theorem 1, we thus have $N_{10} = (124924800 - 123963840 - 739200)/(2 \times 10) = 11088$.

Finally for computing N_{12} , $\text{tr}(A(G)^{12}) = 1382325120$, and from Table II, $S_{3,6,12} = 256374$, $S_{6,3,12} = 512748$. Thus, by (4), we have $\Omega_{12}(3, 6, G) = 1353654720$. Also, by Theorem 3, $\Psi_{g+4}(d_v, d_c, G) = 26104320$. Consequently, by Theorem 1, we compute $N_{12} = (1382325120 - 1353654720 - 26104320)/24 = 106920$.

All the above results for N_8 , N_{10} and N_{12} match those from [24].

D. Tanner (155, 64) code

For the final example, we consider the Tanner (155, 64) code [25]. This code is a $(3, 5)$ -regular LDPC code with $n = 155$, $m = 93$ and $g = 8$. To compute N_8 , we calculate $\text{tr}(A(G)^8) = 475230$. From Table II, we obtain $S_{3,5,8} = 1509$ and $S_{5,3,8} = 2515$. Thus, by (4), $\Omega_8(3, 5, G) = 467790$, and using Theorem 1, we compute $N_8 = (475230 - 467790)/16 = 465$.

For N_{10} , we have $\text{tr}(A(G)^{10}) = 4636050$, and from Table II, we obtain $S_{3,5,10} = 13995$ and $S_{5,3,10} = 23325$. Thus, by (4), we have $\Omega_{10}(3, 5, G) = 4338450$. Also, $N_g \times [\frac{g}{2}(d_v + d_c) -$

$g] \times 2(g + 2) = 223200$. Consequently, by Theorem 1, we have $N_{10} = (4636050 - 4338450 - 223200)/(2 \times 10) = 3720$.

Finally, we have $\text{tr}(A(G)^{12}) = 49222110$. From Table II, $S_{3,5,12} = 134277$ and $S_{5,3,12} = 223795$. Thus, by (4), we have $\Omega_{12}(3, 5, G) = 41625870$. Also, by Theorem 3, $\Psi_{12}(3, 5, G) = 7053120$. Consequently, by Theorem 1, we have $N_{12} = (49222110 - 41625870 - 7053120)/24 = 22630$.

VIII. CONCLUDING REMARKS

It has been long known that the number of closed walks in a graph can be computed using the spectrum of the graph. Very recently, Blake and Lin [15] computed the number of shortest cycles in a bi-regular bipartite graph in terms of the spectrum of the graph and the extra information of node degrees and multiplicities on the two sides of the bipartition. In this work, we extended the results of [15] in a number of directions. First, we computed the multiplicity of i -cycles for $g + 2 \leq i \leq 2g - 2$, in bi-regular bipartite graphs, as a function of the spectrum and the node degrees. Second, we demonstrated, by constructing counter-examples, that for such graphs, the information of the spectrum and the node degrees is insufficient, in general, to determine the number of i -cycles for any $i \geq 2g$. Third, we studied the relationship between cycle multiplicities, on the one hand, and the spectrum and degree sequences, on the other hand, in irregular bipartite graphs. We demonstrated that, for irregular graphs, one cannot, in general, find the number of i -cycles for any $i \geq g$, solely based on the spectrum and degree sequences of the graph, regardless of the value of g . The only exception is the multiplicity of 4-cycles in irregular graphs with $g \geq 4$, for which, we derived a closed form equation in terms of the spectrum and the degree sequences. Finally, we studied the problem of computing the multiplicity of short cycles in half-regular bipartite graphs. We showed that in such graphs, for any $g \geq 4$, the information of spectrum and degree sequences alone is insufficient to compute the multiplicity of i -cycles for any $i \geq g + 2$. We also demonstrated a similar result for the multiplicity of g -cycles in half-regular graphs with $g \geq 8$. As a positive result, for half-regular graphs with $g \geq 6$, we computed the number of 6-cycles in terms of the spectrum and the degree sequences of the graph.

In the context of coding, the degree sequences of Tanner graphs play an important role in the performance of the corresponding LDPC codes, particularly in the waterfall region. Given a degree distribution, however, it is well-known that the performance of practical finite-length codes

can have a large variation in the error-floor region. The main cause of such a large variation is the difference in the trapping set distribution of different codes (all with the same degree distribution). Trapping sets, on the other hand, are closely related to the distribution of short cycles in the graph. The results of this work show that, for a given degree distribution, it is in fact the spectrum of the Tanner graph that is responsible for the variations in cycle multiplicities. In this context, it would be interesting to study the relationship between the spectrum of the graph and its trapping set distribution.

IX. APPENDIX – PROOF OF THEOREM 5

For the proof, we first discuss some of the properties of a Godsil-McKay switching partition of a bi-regular bipartite graph. Let $G = (U \cup W, E)$ be a bi-regular graph in which all the nodes in U have the same degree d_v and all the nodes in W have the same degree d_c . Let $\{X_1, \dots, X_\ell, Y\}$ be a Godsil-McKay switching partition for the nodes of G . For each i , we say that the set of nodes X_i is of Type 1 (Type 2), if all nodes of X_i are in U (W). Otherwise, we say that X_i is of Type 3 (if some nodes of X_i are in U and some others are in W). Let X_i be a set of Type 3. Partition X_i into two parts X_i^1 and X_i^2 , where X_i^1 is the subset of nodes of X_i that are in U , and thus X_i^2 contains the nodes of X_i that are in W . Therefore, $|X_i| = |X_i^1| + |X_i^2|$. If X_i is of Type 3, we say it is of Type 3.1, if $|X_i^1| = |X_i^2|$. Otherwise, we say that X_i is of Type 3.2. We then have the following properties for partition sets of different types.

Lemma 8. *Any Godsil-McKay switching partition $\{X_1, \dots, X_\ell, Y\}$ of the nodes of a (d_v, d_c) -regular bipartite graph $G = (U \cup W, E)$ has the following properties:*

- P1. *There is no connection (edge) between the nodes of a Type-3 set and the nodes of a Type-1 or Type-2 set.*
- P2. *There is no connection between the nodes of a Type-3.1 set and the nodes of a Type-3.2 set.*
- P3. *Let X_i and X_j be two sets of Type 3.2. Assume that the nodes in X_i have at least one neighbor in X_j . Then, if $|X_i^1| > |X_i^2|$, we have $|X_j^1| < |X_j^2|$, and if $|X_i^1| < |X_i^2|$, we have $|X_j^1| > |X_j^2|$.*
- P4. *Let X_i be a set of Type 3. If a node $y \in Y$ has a neighbor in X_i , then y is adjacent with $\frac{|X_i|}{2}$ nodes of X_i^1 or y is adjacent with $\frac{|X_i|}{2}$ nodes of X_i^2 (y cannot have neighbors in both X_i^1 and X_i^2).*

P5. For each X_i , each node in X_i is connected to the same number of nodes in $\cup_{j=1}^{\ell} X_j$.

Proof. P1. Let X_i be a set of Type 3 and X_j be a set of Type 2 or Type 1. Since the graph is bipartite, some of the nodes of X_i cannot have any connection to the nodes of X_j . Moreover, all the nodes of X_i must have the same number of neighbors in X_j . This number thus must be zero. P2. Let X_i be a set of Type 3.2 and X_j be a set of Type 3.1. Let $|E'|$ be the number of edges between X_i^1 and X_j^2 , and $|E''|$ be the number of edges between X_i^2 and X_j^1 . Since X_j is a set of Type 3.1, and every node in X_j has the same number of neighbors in X_i , we have $|E'| = |E''|$. On the other hand, since X_i is a set of Type 3.2 and every node in X_i has the same number of neighbors in X_j , we have $|E'| \neq |E''|$, which is a contradiction. The proofs for P3-P5 are straightforward. ■

We now prove Theorem 5. Consider the application of the Godsil-McKay switching to convert a (d_v, d_c) -regular bipartite graph $G = (U \cup W, E)$ into the graph G' . The nodes of G' can be partitioned into two sets U' and W' according to the following rules:

Rule 1. For each node $v \in Y$ in the graph G , assign the corresponding node v in G' to U' (W') if v in G is in U (W).

Rule 2. For each i , if X_i is of Type 1 or Type 2, then for each node v in X_i in the graph G , assign the corresponding node v in G' to U' (W') if v in G is in U (W).

Rule 3. For each i , if X_i is of Type 3, then for each node v in X_i in the graph G , assign the corresponding node v in G' to U' (W') if v in G is in W (U).

Now, we show that $G' = (U' \cup W', E')$ is a bi-regular graph in which all the nodes in U' have the same degree d_v and all the nodes in W' have the same degree d_c . To show this, we examine the degrees of different partition sets Y and X_i 's. For the latter sets, the examination is based on the type of the set.

(i) Set Y : It is clear that the Godsil-McKay switching does not change the degree of any node in Y , and by Rule 1, those nodes in Y with degree d_v (d_c) are in U' (W').

(ii) Type-1 or Type-2 X_i : Let X_i be a set of Type 1. If there is no node $y \in Y$ such that y is adjacent with $\frac{|X_i|}{2}$ nodes of X_i , then the Godsil-McKay switching does not change the degree of any node in X_i . Now, assume that there is a node $y \in Y$ such that y is adjacent to $\frac{|X_i|}{2}$ nodes of X_i . Let $Y_i \subset Y$ be a subset of nodes such that for each node $y \in Y_i$, the node y is adjacent to $\frac{|X_i|}{2}$ nodes of X_i . Since all nodes in X_i have the same degree d_v , and also because for any j , every node in X_i has the same number of connections to the nodes in X_j , all the nodes in

X_i have the same number of neighbors in Y_i . Call this number γ . By counting the number of edges η between X_i and Y_i , we find that $\eta = \gamma|X_i|$. On the other hand, $\eta = |Y_i||X_i|/2$. Thus, $|Y_i| = 2\gamma$. This implies that each node $v \in X_i$ is adjacent to half of the nodes in Y_i (γ of them), and has no connection to the other half. Consequently, the Godsil-McKay switching does not change the degree of any node in X_i . This together with Rule 2 shows that each node in any Type-1 set in U' has degree d_v . The proof for a Type-2 set is similar.

(iii) Let X_i be a set of Type 3.1. By P1 and P2, all the connections to X_i are from Y and Type-3.1 sets. Based on P4, after applying the Godsil-McKay switching, the degree of each node in X_i^1 will be d_c and the degree of each node in X_i^2 will be d_v . Thus, by Rule 3, and the fact that $|X_i^1| = |X_i^2|$, the degree sequence of the graph does not change after switching. Moreover, it is easy to see that after the application of the switching to X_i , the graph still remains bipartite.

(iv) Let X_i be a set of Type 3.2. We consider two cases:

Case 1. Without loss of generality, assume that $d_c > d_v$. In this case, by P4, P5, and the condition $d_c > d_v$, there must be a node $y' \in Y$ such that y' is adjacent with $\frac{|X_i|}{2}$ nodes of X_i^2 . Thus, $|X_i^2| \geq \frac{|X_i|}{2}$, and

$$|X_i^1| < |X_i^2|. \quad (25)$$

Note that (25) is valid for any set X_i of Type 3.2. On the other hand, by P1, P2 and P3, there is at least a set X_j of Type 3.2 such that each node of X_i has at least one neighbor in X_j , and $|X_j^1| > |X_j^2|$. But this is a contradiction with (25). We thus conclude that this case cannot happen.

Case 2. Now, assume that $d_c = d_v$. If there are two nodes y and y' in Y such that y is adjacent to $\frac{|X_i|}{2}$ nodes of X_i^1 and y' is adjacent to $\frac{|X_i|}{2}$ nodes of X_i^2 , then $\frac{|X_i|}{2} \leq |X_i^1|$ and $\frac{|X_i|}{2} \leq |X_i^2|$. This implies $|X_i^1| = |X_i^2| = \frac{|X_i|}{2}$. But this contradicts the definition of Type 3.2 sets. Also, if there is a node $y \in Y$ such that y is adjacent to $\frac{|X_i|}{2}$ nodes of X_i^1 (or X_i^2), but there is no node $y' \in Y$ such that y' is adjacent to $\frac{|X_i|}{2}$ nodes of X_i^2 (or X_i^1), then by P5, we have $d_v \neq d_c$, again a contradiction. Thus, there is no connection between the nodes in Y and those of X_i . Let S be the union of all Type-3.2 sets. Partition S into two sets S^1 and S^2 , where S^1 is a subset of U and S^2 is a subset of W . Each node in S has no neighbor in Y , Type-1, Type-2, or Type-3.1 sets. Now, consider the node-induced subgraph on the set of nodes S . Since the degree of all nodes in G are the same, by counting the number of edges from two sides, we have $|S^1| = |S^2|$. This combined with $d_v = d_c$, and Rule 3 shows that the Godsil-McKay switching does not change

the degree sequence of G . The graph also remains bipartite. This completes the proof.

Remark 2. *From the discussions above, one can see that a Godsil-McKay switching partition of bi-regular bipartite graphs, in which degrees of the two sides are unequal, cannot have Type 3.2 sets. Thus, for practical Tanner graphs in which $d_v \neq d_c$, a valid Godsil-McKay switching partition $\{Y, X_1, \dots, X_\ell\}$ of the nodes can only have X_i 's that are either Type 1, Type 2 or Type 3.1. There can also be connections only between Types 1 and 2, and between Types 3.1 and 3.1. Nodes in Y can be connected to the nodes in all three types of X_i sets.*

REFERENCES

- [1] Y. Mao and A. H. Banihashemi, "A heuristic search for good low-density parity-check codes at short block lengths," in *Proc. IEEE Int. Conf. Commun.*, vol. 1, Helsinki, Finland, Jun. 2001, pp. 41–44.
- [2] X.-Y. Hu, E. Eleftheriou, and D. M. Arnold, "Regular and irregular progressive edge-growth Tanner graphs," *IEEE Trans. Inform. Theory*, vol. 51, no. 1, pp. 386–398, Jan. 2005.
- [3] T. R. Halford and K. M. Chugg, "An algorithm for counting short cycles in bipartite graphs," *IEEE Trans. Inform. Theory*, vol. 52, no. 1, pp. 287–292, Jan. 2006.
- [4] H. Xiao and A. H. Banihashemi, "Error rate estimation of low-density parity-check codes on binary symmetric channels using cycle enumeration," *IEEE Trans. Communications*, vol. 57, no. 6, pp. 1550–1555, Jun. 2009.
- [5] M. Karimi and A. H. Banihashemi, "On the girth of quasi-cyclic protograph LDPC codes," *IEEE Trans. Inform. Theory*, vol. 59, no. 7, pp. 4542–4552, July. 2013.
- [6] R. Asvadi, A. H. Banihashemi, and M. Ahmadian-Attari, "Lowering the error floor of LDPC codes using cyclic liftings," *IEEE Trans. Inform. Theory*, vol. 57, no. 4, pp. 2213–2224, Apr. 2011.
- [7] M. Karimi and A. H. Banihashemi, "Efficient algorithm for finding dominant trapping sets of LDPC codes," *IEEE Trans. Inform. Theory*, vol. 58, no. 11, pp. 6942–6958, Nov. 2012.
- [8] M. Karimi and A. H. Banihashemi, "On characterization of elementary trapping sets of variable-regular LDPC codes," *IEEE Trans. Inform. Theory*, vol. 60, no. 9, pp. 5188–5203, Sep. 2014.
- [9] Y. Hashemi and A. H. Banihashemi, "On characterization and efficient exhaustive search of elementary trapping sets of variable-regular LDPC codes," *IEEE Commun. Lett.*, vol. 19, no. 3, pp. 323–326, March 2015.
- [10] Y. Hashemi and A. H. Banihashemi, "New characterization and efficient exhaustive search algorithm for leafless elementary trapping sets of variable-regular LDPC codes," *IEEE Trans. Inform. Theory*, vol. 62, no. 12, pp. 6713–6736, Dec. 2016.
- [11] Y. Hashemi and A. H. Banihashemi, "Characterization of Elementary Trapping Sets in Irregular LDPC Codes and the Corresponding Efficient Exhaustive Search Algorithms," to appear in *IEEE Trans. Inform. Theory*.
- [12] M. Karimi and A. H. Banihashemi, "Counting short cycles of quasi cyclic protograph LDPC codes," *IEEE Commun. Lett.*, vol. 16, no. 3, pp. 400–403, Mar. 2012.
- [13] M. Karimi and A. H. Banihashemi, "Message-passing algorithms for counting short cycles in a graph," *IEEE Trans. Communications*, vol. 61, no. 2, pp. 485–495, Feb. 2013.
- [14] A. Dehghan and A. H. Banihashemi, "On the Tanner graph cycle distribution of random LDPC, random protograph-based LDPC, and random quasi-cyclic LDPC code ensembles," to appear in *IEEE Trans. Inf. Theory*.
- [15] I. Blake and S. Lin, "On short cycle enumeration in biregular bipartite graphs," *IEEE Trans. Inf. Theory*, Dec. 2017, available online at: <http://ieeexplore.ieee.org/document/8225637/>.

- [16] J. Flum and M. Grohe, “The parameterized complexity of counting problems,” *SIAM J. Comput.*, vol. 33, no. 4, pp. 892–922, 2004.
- [17] H. Müller, “Hamiltonian circuits in chordal bipartite graphs,” *Discrete Math.*, vol. 156, no. 1-3, pp. 291–298, Sep. 1996.
- [18] E. R. van Dam and W. H. Haemers, “Which graphs are determined by their spectrum?,” *Linear Algebra Appl.*, vol. 373, pp. 241–272, 2003. Special issue on the Combinatorial Matrix Theory Conference (Pohang, 2002).
- [19] A. E. Brouwer and W. H. Haemers, *Spectra of graphs*. Universitext, Springer, New York, 2012.
- [20] G. E. Andrews, *The theory of partitions*. Cambridge Mathematical Library, Cambridge University Press, Cambridge, 1998. Reprint of the 1976 original.
- [21] J. J. Seidel, “Graphs and two-graphs,” in *Proceedings of the Fifth Southeastern Conference on Combinatorics, Graph Theory and Computing (Florida Atlantic Univ., Boca Raton, Fla., 1974)*, *Congressus Numerantium, No. X, Utilitas Math., Winnipeg, Man*, pp. 125–143, 1974.
- [22] C. D. Godsil and B. D. McKay, “Constructing cospectral graphs,” *Aequationes Math.*, vol. 25, no. 2-3, pp. 257–268, 1982.
- [23] J. A. Bondy and U. S. R. Murty, *Graph theory with applications*. American Elsevier Publishing Co., Inc., New York, 1976.
- [24] J. Howbert, “Count all cycles in simple undirected graph, version 1.2,” URL: <https://www.mathworks.com/matlabcentral/fileexchange/29438-count-all-cycles-in-simple-undirected-graph>.
- [25] D. J. MacKay, “Encyclopedia of sparse graph codes,” URL: <http://www.inference.phy.cam.ac.uk/mackay/codes/data.html>.