

Towards Practical Implementation of Deep Random Secrecy

Thibault de Valroger ^(*)

Abstract

We have formerly introduced Deep Random Secrecy, a new cryptologic technique capable to ensure secrecy as close as desired from perfection against unlimited passive eavesdropping opponents. We have also formerly introduced an extended protocol, based on Deep Random Secrecy, capable to resist to unlimited active MITM. The main limitation of those protocols, in their initial presented version, is the important quantity of information that needs to be exchanged between the legitimate partners to distill secure digits. We have defined and shown existence of an absolute constant, called Cryptologic Limit, which represents the upper-bound of Secrecy rate that can be reached by Deep Random Secrecy protocols. At last, we have already presented practical algorithms to generate Deep Randomness from classical computing resources. This article is presenting an optimization technique, based on recombination and reuse of random bits; this technique enables to dramatically increase the bandwidth performance of formerly introduced protocols, without jeopardizing the entropy of secret information. That optimization enables to envision an implementation of Deep Random Secrecy at very reasonable cost. The article also summarizes former results in the perspective of a comprehensive implementation.

Key words. Deep Random, Perfect Secrecy, Secret key agreement, Authentication against Man In The Middle attack, unconditional security, quantum resistant

I. Introduction and summary of former work

Modern cryptography mostly relies on mathematical problems commonly trusted as very difficult to solve, such as large integer factorization or discrete logarithm, belonging to complexity theory. No certainty exists on the actual difficulty of those problems. Some other methods, rather based on information theory, have been developed since early 90's. Those methods relies on hypothesis about the opponent (such as « memory bounded » adversary [6]) or about the communication channel (such as « independent noisy channels » [5]) ; unfortunately, if their perfect secrecy have been proven under given hypothesis, none of those hypothesis are easy to ensure in practice. At last, some other methods based on physical theories like quantum indetermination [3] have been described and experimented, but they remain complex to implement.

Considering this theoretically unsatisfying situation, we have proposed in [9] to explore a new path, where proven information theoretic security can be reached, without assuming any limitation about the capacities of the opponent, who is supposed to have unlimited computation and storage power, nor

() See contact and information about the author at last page*

about the communication channel, that is supposed to be perfectly public, accessible and equivalent for any playing party (legitimate partners and opponents). Furthermore, while we were only considering passive unlimited opponents in [9], we consider in this work active unlimited MITM opponents.

In our model of security, the legitimate partners of the protocol are using Deep Random generation to generate their shared encryption key, and the behavior of the opponent, when inferring secret information from public information, is governed by Deep Random assumption, that we introduce. In active opponent scenarios, the legitimate partners have an initial shared authentication secret, that is used only for authentication purpose, not for generating the shared encryption key.

Back on the Deep random assumption

The art of prior probabilities consists in assigning probabilities to a random event in a context of partial or complete uncertainty regarding the probability distribution governing that random event. The first author who has rigorously considered this question is Laplace [10], proposing the famous *principle of insufficient reason* by which, if an observer does not know the prior probability of occurrence of 2 events, he should consider them as equally likely. In other words, if a random variable V can take several values v_1, \dots, v_n , and if no information regarding the prior probabilities $P(V = v_i)$ is available for the observer, he should assign them $P(V = v_i) = 1/n$ in any attempt to produce inference from an experiment of V .

Several authors observed that this principle can lead to conclusion contradicting the common sense in certain cases where some knowledge is available to the observer but not reflected in the assignment principle.

If we denote by I the set of all prior information available to observer regarding the probability distribution of a certain random variable ('prior' meaning before having observed any experiment of that variable), it is then possible to define the set of possible distributions that are compatible with the information I ; we denote this set of possible distributions as:

$$\Omega_I$$

The goal of Prior probability theory is to provide tools enabling to make rigorous inference reasoning in a context of partial knowledge of probability distributions. A key idea for that purpose is to consider groups of transformation, applicable to the sample space of a random variable V , that do not change the global perception of the observer. In other words, given the prior information I regarding the distribution of V , for any distribution $\Phi \in \Omega_I$, and for any transformation τ of such group, the observer has no information enabling him to privilege Φ rather than $\Phi \circ \tau$ as the actual distribution. This idea has been developed by Jaynes [7], in order to avoid the incoherence brought in some cases by the imprudent application of Laplace principle.

We denoted R_G the set of distributions that are invariant by action of G :

$$R_G \triangleq \left\{ \frac{1}{|G|} \sum_{\tau \in G} \Phi \circ \tau \mid \forall \Phi \in \Omega_I \right\}$$

The set of acceptable groups as defined above is denoted Γ_I .

The Deep Random assumption imposes a rule enabling to make rigorous inference reasoning about an observer ξ in a context where that observer ξ only has partial knowledge of a probability distribution.

Let X be a private random variable with values in a measurable set F . X has an unknown probability distribution for ξ , except a prior public information I . Let's also consider J a random variable, correlated to X , with publicly observable values in F . Typically, X represents a secret information that ξ has to determine with the highest possible accuracy, and J represents the public information available to ξ (like for instance the information exchanged during a communication protocol).

For any group G of transformations applying on the sample space F , we denote by $\Omega_{\#}(G)$ the set of all possible conditional expectations when the distribution of X courses R_G . In other words:

$$\Omega_{\#}(G) \triangleq \{Z(J) \triangleq E[X|J] | \forall \Phi(x) \in R_G\}$$

Or also, expressed with Bayesian inference:

$$\Omega_{\#}(G) = \left\{ Z(J) = \frac{\int x P(J|x) \Phi(x) dx}{\int P(J|x) \Phi(x) dx} | \forall \Phi(x) \in R_G \right\}$$

The **Deep Random assumption** prescribes that, if $G \in \Gamma_I$, the strategy Z_{ξ} of the opponent observer ξ , in order to estimate X from the public information J , should be chosen by the opponent observer ξ within the restricted set of strategies:

$$Z_{\xi} \in \Omega_{\#}(G) \tag{A}$$

The Deep Random assumption can thus be seen as a way to restrict the possibilities of ξ to choose his strategy in order estimate the private information X from its knowledge of the public information J . It is a fully reasonable assumption due to the fact that the observer has no information enabling him to privilege Φ rather than $\Phi \circ \tau$ as the actual distribution, $\forall \tau \in G$. More details about the Deep Random Assumption can be found in [12].

Back on the presentation of protocol \mathcal{P} (introduced in [9])

The following protocol has been presented in [9]. In order to shortly remind the notations, let's set $x = (x_1, \dots, x_n)$ and $y = (y_1, \dots, y_n)$ some parameter vectors in $[0,1]^n$ and $i = (i_1, \dots, i_n)$ and $j = (j_1, \dots, j_n)$ some Bernoulli experiment vectors in $\{0,1\}^n$, we denote :

$x \cdot y$ (resp. $i \cdot j$) the scalar product of x and y (resp. i and j)

$$|x| \triangleq \sum_{s=1}^n x_s ; |i| \triangleq \sum_{s=1}^n i_s$$

$\forall \sigma \in \mathfrak{S}_n$, $\sigma(x)$ represents $(x_{\sigma(1)}, \dots, x_{\sigma(n)})$

$$\frac{x}{k} \text{ represents } \left(\frac{x_1}{k}, \dots, \frac{x_n}{k} \right) \text{ for } k \in \mathbb{R}_+^*$$

In that protocol, besides being hidden to any third party (opponent or partner), the probability distributions used by each legitimate partner also need to have specific properties in order to prevent the opponent to efficiently evaluate V_A by using internal symmetry of the distribution.

Those specific properties are:

- (i) Each probability distribution Φ (for A or B) must be « far » from its symmetric projection $\bar{\Phi}(x) \triangleq \frac{1}{n!} \sum_{\sigma \in \mathfrak{S}_n} \Phi \circ \sigma(x)$
- (ii) At least one of the distribution (of A or B) must avoid to have brutal variations (Dirac)

The technical details explaining those constraints are presented in [9]. The set of compliant distributions is denoted $\zeta(\alpha)$ where α is a parameter that quantifies the « remoteness » of a distribution from its symmetric projection.

For such a distribution Φ , a tidying permutation, denoted σ_Φ , is a permutation that realizes the minimum:

$$\min_{\sigma \in \mathfrak{S}_n} \left(\sum_{r,s \in I_0 \times \bar{I}_0} \int_{[0,1]^n} x_{\sigma(r)} x_{\sigma(s)} \Phi(x) dx \right)$$

where $I_0 = \{1, \dots, n/2\}$. Minimizing the above criteria is an efficient way to ensure that $\Phi \circ \sigma_\Phi$ is driven away from its symmetric projection. Again, details are presented in [9].

Here are the steps of the proposed protocol:

A and B are the legitimate partners. The steps of the protocol $\mathcal{P}(\alpha, n, k, L)$ are the followings:

Step 1 – Deep Random Generation: A and B pick independently the respective probability distributions Φ and $\Phi' \in \zeta(\alpha)$, so that Φ (resp. Φ') is secret (under Deep Random assumption) for any observer other than A (resp. B) beholding all the published information. A draws the parameter vector $x \in [0,1]^n$ from Φ . B draws the parameter vector $y \in [0,1]^n$ from Φ' .

Step 2 – Degradation: k being a number $k > 1$, A generates a Bernoulli experiment vectors $i \in \{0,1\}^n$ from the parameter vector $\frac{x}{k}$. A publishes i . B generates a Bernoulli experiment vectors $j \in \{0,1\}^n$ from the parameter vector $\frac{y}{k}$. B publishes j .

Step 3 – Dispersion: A and B also pick respectively a second probability distribution Ψ and $\Psi' \in \zeta(\alpha)$ such that it is also secret (under Deep Random assumption) for any observer other than A (resp. B). Ψ is selected also such that $\int_{|x| \in [k|i| - \sqrt{n}, k|i| + \sqrt{n}]} \Psi(x) dx \geq \frac{1}{2\sqrt{n}}$ in order to ensure that $|i|$ is not an unlikely value for $\approx \left| \frac{x}{k} \right|$ (same for Ψ' by replacing x by y and i by j). Ψ (resp. Ψ') is used to scramble the publication of the tidying permutation of A (resp. B). A (resp. B) computes a permutation $\sigma_d[i]$ (resp. $\sigma'_d[j]$) representing the reverse of the most likely tidying permutation on Ψ (resp. Ψ') to produce i (resp. j). In other words, with i , $\sigma_d[i]$ realizes :

$$\max_{\sigma \in \mathfrak{S}_n} \int_x P(i|x) \Psi \circ \sigma_\Psi \circ \sigma^{-1}(x) dx$$

Then A (resp. B) draws a boolean $b \in \{0,1\}$ (resp. b') and publishes in a random order $(\mu_0, \mu_1) = t^b(\sigma_d[i], \sigma_\Phi)$, (resp. $(\mu'_0, \mu'_1) = t^{b'}(\sigma'_d[j], \sigma_{\Phi'})$) where t represents the transposition of elements in a couple.

Step 4 – Synchronization: A (resp. B) chooses randomly σ_A (resp. σ_B) among (μ'_0, μ'_1) (resp. (μ_0, μ_1)).

Step 5 – Decorrelation: A computes $V_A = \frac{\sigma_{\Phi}^{-1}(x) \cdot \sigma_A^{-1}(j)}{n}$, B computes $V_B = \frac{\sigma_B^{-1}(i) \cdot \sigma_{\Phi'}^{-1}(y)}{n}$. V_A and V_B are then transformed respectively by A and B in binary output thanks to a sampling method described hereafter. At this stage the protocol can then be seen as a broadcast model with 2 Binary Symmetric Channels (BSC), one between A and B and one between A and ξ who computes a certain V_{ξ} , called ξ 's strategy, that is to be transformed in binary output by the same sampling method than for A and B. It is shown in Theorem 1 of [9] that those 2 BSC are partially independent, which enable to create Advantage Distillation as shown in [5].

Step 5' – Advantage Distillation: by applying error correcting techniques with code words of length L between A and B, as introduced in [5], we show in Theorem 1 of [9] that we can then create advantage for B compared to ξ in the error rates of the binary flows resulting from the error correcting code.

Step 6: classical Information Reconciliation and Privacy Amplification (IRPA) techniques then lead to get accuracy as close as desired from perfection between estimations of legitimate partners, and knowledge as close as desired from zero by any unlimitedly powered opponent, as shown in [4].

Steps 1 to 5 are symmetric from a design perspective, but Deep Random Generators create distinct output streams. As the symmetry of the protocol is a desirable property from probability distribution perspective, A and B can alternatively exchange their role after each instantiation of the protocol to annihilate the dissymmetry caused by the fact that they run their proper Deep Random Generator.

The choices of the parameters (α, n, k, L) are theoretically discussed in proof of main Theorem in [9]. They are set to make steps 5, 5' and 6 possible.

The Degradation transformations $x \mapsto \frac{x}{k}$ and $y \mapsto \frac{y}{k}$ with $k > 1$ at step 2 are the ones that prevent the use of direct inference by the opponent, and of course, the Deep Random Generation at step 1 prevents the use of Bayesian inference based on the knowledge of the probability distribution. The synchronization step 4 is designed to overcome the independence between the choices of the distributions of A and B, and needs that the distributions to have special properties ($\in \zeta(\alpha)$) in order to efficiently play their role. It is efficient in 1/4 of cases (when B picks $\sigma_B = \sigma_{\Phi}$ and A picks $\sigma_A = \sigma_{\Phi'}$, which we will call favorable cases). And to prevent ξ from gaining knowledge of σ_{Φ} , Dispersion step 3 mixes σ_{Φ} within (μ_0, μ_1) with another permutation $\sigma_d[i]$ (and $\sigma_{\Phi'}$ within (μ'_0, μ'_1) with another permutation $\sigma'_d[j]$) that (1) is undistinguishable from σ_{Φ} knowing i , and (2) manages to make the estimation of ξ unefficient as shown in [9]. We denote $\Omega'_{\#}$ the following set of strategies (invariant by transposition of (μ_0, μ_1) or (μ'_0, μ'_1)):

$$\begin{aligned} \Omega'_{\#} &\triangleq \left\{ \omega(i, j, (\mu_0, \mu_1), (\mu'_0, \mu'_1)) \mid \forall b, b' \in \{0, 1\}: \omega(i, j, \tau^b(\mu_0, \mu_1), \tau^{b'}(\mu'_0, \mu'_1)) \right. \\ &\quad \left. = \omega(i, j, (\mu_0, \mu_1), (\mu'_0, \mu'_1)) \right\} \end{aligned}$$

Due to Deep Random assumption (A) over the group $\{\text{Id}, t\}$ applied to the distribution of (μ_0, μ_1) and (μ'_0, μ'_1) , the strategy of the opponent can thus be restricted to $V_{\xi} \in \Omega'_{\#}$.

i is entirely determined by $|i|$ and a permutation, which explains the constraint and transformation applied on Ψ in step 3 to make σ_{Φ} and $\sigma_d[i]$ indistinguishable knowing i (same with $\sigma'_d[j]$, $\sigma_{\Phi'}$, and j).

The synchronization step has a cost when considering the favorable cases: ξ knows that Φ and Φ' are synchronized in favorable cases, which means in other words that ξ knows that an optimal (or quasi optimal) permutation is applied to Φ' . This also means that in favorable cases, all happen like if when A picks $\Phi \circ \sigma$ instead of Φ , the result of the synchronization is that B uses $\Phi' \circ \sigma$ instead of Φ' . Starting from the most general strategy $\omega \in \Omega'_\#$ for ξ , we also consider the following additional restrictions applicable to the favorable cases:

- Restriction to the strategies of the form $\omega(i, j)$, because $(\sigma_d[i], \sigma'_d[j])$ depends only on (i, j) and not on Φ neither Φ' ,
- And then restriction to the set of strategies such that $\omega_{i,j} = \omega_{\sigma(i), \sigma(j)}, \forall \sigma \in \mathfrak{S}_n$, in other words strategies invariant by common permutation on i, j .

which leads to define the more restricted set of strategies:

$$\Omega_\#(G, \mathcal{P}) = \{ \omega \in [0,1]^{2^{2n}} \mid \omega(\sigma(i), \sigma(j), \mu_1, \mu_2, \mu'_1, \mu'_2) = \omega(\sigma(i), \sigma(j)) = \omega(i, j), \forall \sigma \in \mathfrak{S}_n \}$$

The step 5 is called Decorrelation because at this step, thanks to the Deep Random Assumption, we have managed to create a protocol that can be equivalently modeled by a broadcast communication over 2 partially independent BSC, as shown in the main Theorem in [9], and also that consequently, it is possible to apply error correcting techniques to create Advantage Distillation as established in [5].

We can use the following very basic technique to transform V_A and V_B in an intermediate binary flow as introduced in step 5: we can typically sample a value in $[0,1]$ like V_A or V_B with a gauge being a multiple of the variance $E \left[\left(V_{A|\sigma_A=\sigma_{\Phi'}} - V_{B|\sigma_B=\sigma_{\Phi}} \right)^2 \right]^{1/2} = O\left(\frac{1}{\sqrt{nk}}\right)$. The multiplicative factor K is chosen such that :

$$\frac{1}{\sqrt{nk}} \ll \frac{K}{\sqrt{nk}} \ll \frac{1}{\sqrt{n}}$$

and therefore, each experiment of the protocol can lead respectively A and B to distill an intermediate digit defined by:

$$\tilde{e}_A = \left\lfloor \frac{(V_A - \rho)\sqrt{nk}}{K} \right\rfloor \bmod 2, \tilde{e}_B = \left\lfloor \frac{(V_B - \rho)\sqrt{nk}}{K} \right\rfloor \bmod 2$$

where ρ is a translation parameter. Regarding the legitimate partners, when B picks $\sigma_B = \sigma_{\Phi}$ and A picks $\sigma_A = \sigma_{\Phi'}$, the choice of σ_A and σ_B remain independent from i, j , so that i and j remain draws of independent Bernoulli random variables, then allowing to apply Chernoff-style bounds for the legitimate partners. When B picks $\sigma_B = \sigma_d[i]$ or A picks $\sigma_A = \sigma'_d[j]$, this is no longer true and V_B or V_A become erratic, which will lead to error detection by error correcting code at step 5'.

The heuristic table analysis of the protocol is then the following:

	B picks $\sigma_B = \sigma_\Phi$ among (μ_0, μ_1)	B picks $\sigma_B = \sigma_d[i]$ among (μ_0, μ_1)
A picks $\sigma_A = \sigma_{\Phi'}$ among (μ'_0, μ'_1)	<p>A and B respective estimations are close in $\sim 100\%$ of cases, and thus both obtain accurate estimation of the combined shared secret in $\sim 100\%$ of cases.</p> <p>ξ cannot make accurate estimation of the combined shared secret in at least $\sim 25\%$ of cases (if ξ tries to have a strategy depending on $(\mu_0, \mu_1, \mu'_0, \mu'_1)$, then $(\sigma_d[i], \sigma'_d[j])$ is indistinguishable from $(\sigma_\Phi, \sigma_{\Phi'})$ and is thus picked by ξ in 25% of cases.</p>	A and B respective estimations are not close which leads to error detection and finally discarding.
A picks $\sigma_A = \sigma'_d[j]$ among (μ'_0, μ'_1)	A and B respective estimations are not close which leads to error detection and finally discarding.	A and B respective estimations are not close which leads to error detection and finally discarding.

This is a heuristic reasoning, and we must rather consider the most general set of strategies $\omega(i, j, \mu_0, \mu_1, \mu'_0, \mu'_1)$ and write the probability equations with the appropriate group transform, under Deep Random assumption, which is done in [9]. In particular, the heuristic conforms to the reality only because the virtual BSC channels have partially independent error variables between the legitimate receiver and the opponent; this necessary condition is shown to be fulfilled in proof of main Theorem of [9]; otherwise, the error correcting method at step 5' would not generate Advantage distillation.

It is critical that Reconciliation technique does not bring additional information to the opponent due to the choice of code words. Indeed, contrariwise the protocol presented in [5] or BB84 in which qbits cloning is impossible, in our case the opponent can try the various possible combinations of choice for σ_A and σ_B , and compare them in terms of matching a code word. To illustrate the issue, let's consider the non-optimal error correcting method described by Maurer in [5]: the codeword v_A chosen by A can only be $(0,0, \dots, 0)_L$ or $(1,1, \dots, 1)_L$ depending on $e_A = 0$ or $e_A = 1$. B publicly discards all decoded sequence v_B that is not $(0,0, \dots, 0)_L$ or $(1,1, \dots, 1)_L$ and obviously decodes accordingly $e_B = 0$ if $|v_B| = 0$, and $e_B = 1$ if $|v_B| = L$. In such scenario, the opponent can use the strategy below (see [9] Proposition 14 and proof of Theorem 1 for justification of this choice)

$$V_\xi(i, j, \sigma_{\xi,A}, \sigma_{\xi,B}) = \frac{2k \left(\left(\sum_{r \in \sigma_{\xi,B}(I_0)} i_r \right) \left(\sum_{r \in \sigma_{\xi,A}(I_0)} j_r \right) + \left(\sum_{r \in \overline{\sigma_{\xi,B}(I_0)}} i_r \right) \left(\sum_{r \in \overline{\sigma_{\xi,A}(I_0)}} j_r \right) \right)}{n^2}$$

where $\sigma_{\xi,B}$ is a permutation chosen by ξ among (μ_1, μ_2) and $\sigma_{\xi,A}$ is a permutation chosen by ξ among (μ'_1, μ'_2) . Then, at each instantiation m of the protocol, we can consider the vector of $\{0,1\}^4$ defined by:

$$T_m = \left\{ \tilde{e}_\xi(\mu'_1, \mu_1)_m, \tilde{e}_\xi(\mu'_1, \mu_2)_m, \tilde{e}_\xi(\mu'_2, \mu_1)_m, \tilde{e}_\xi(\mu'_2, \mu_2)_m \right\}$$

When A encodes a code word with a sequence of L instantiations of the protocol, if, for one of the instance m within the sequence, we have $\sigma_A = \sigma_{\Phi'}$ and $T_m = (0,0,0,0)$ (or $T_m = (1,1,1,1)$), then it is

clear that the code word is $(0,0, \dots, 0)_L$ (or $(1,1, \dots, 1)_L$). This example shows how, even with Deep Randomness indistinguishability applied locally to each instance, the opponent can still take advantage of an imprudent implementation of the error correcting method to break the secrecy. In order to avoid this flaw, and to maintain the invariance by the group of symmetry in the context of adding the error correction at the end of the protocol, it is needed to ensure that:

$$|T_m| = 2, \quad \forall m$$

Indeed, in the above condition, the opponent has no information in any circumstance to privilege $(0,0, \dots, 0)_L$ or $(1,1, \dots, 1)_L$ as the chosen code word. One possible simple strategy for this is to discard all the rounds of generation of $\{\widetilde{e}_A, \widetilde{e}_B\}$ in which the condition is not satisfied. That strategy is the one adopted for simulations presented in Appendix III. Note that this discarding action does not require any additional exchange of information between the legitimate partners because $|T_m|$ can be computed by any party from the public information.

II. The “bit reuse and recombine” optimization technique

The protocol described in Section I requires to exchange $6n$ bits $(i, j, \mu_0(I_0), \mu_1(I_0), \mu'_0(I_0), \mu'_1(I_0))$ in order to distill \widetilde{e}_A and \widetilde{e}_B . This is extremely costly, as we figured in [11] that n should be roughly 5,000 to make Reconciliation efficient.

The technique that we present in this section makes this multiplication factor to vanish by reusing draws without decreasing the entropy of the output digit flow. It thus represents a dramatic improvement of performance.

Here is how it works.

When the protocol is used to transmit a message M , the transmission is sequenced in successive blocks of n instances of the steps 1 to 4 of the protocol. Each block enables to distill n^2 bits \widetilde{e}_A and \widetilde{e}_B with a reuse and recombine technique that is detailed below. Then Information Reconciliation and Privacy Amplification (IRPA) can be applied on those n^2 bits flows to distill fully secure e_A and e_B bit flows.

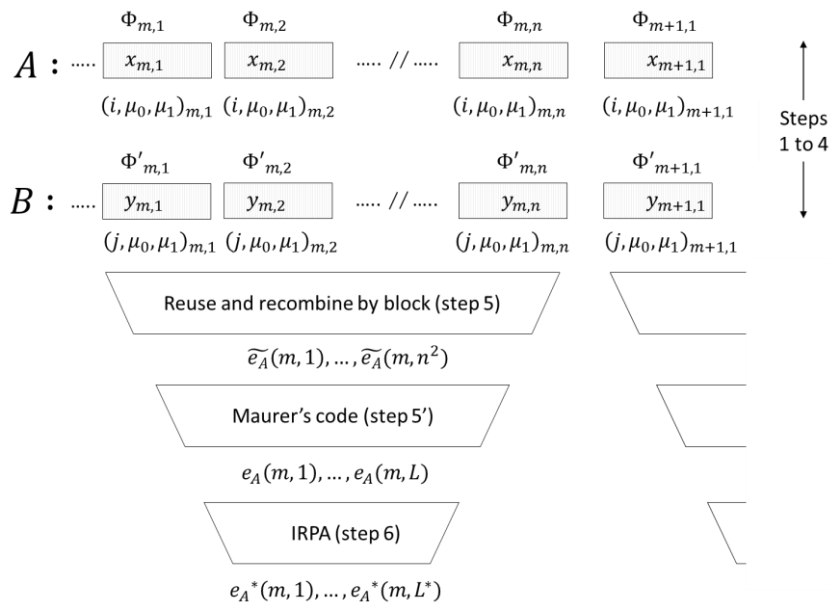

Fig.1

We denote by m the sequence number of a transmission block, and $q \in \mathbb{N}_n^*$ the instance number, and $p \in \mathbb{N}_{n^2}^*$ the index of the output \widetilde{e}_A (resp. \widetilde{e}_B) digit. Then, the recombination uses the following variables:

$$V_A(m, p) \triangleq \frac{\sigma_{\Phi_{m, \lfloor \frac{p-1}{n} \rfloor + 1}}^{-1} \left(x_{m, \lfloor \frac{p-1}{n} \rfloor + 1} \right) \cdot \mu'_{b_{m,p}, m, ((p-1) \bmod n) + 1}^{-1} (j_{m, ((p-1) \bmod n) + 1})}{n}$$

$$V_B(m, p) \triangleq \frac{\sigma_{\Phi'_{m, ((p-1) \bmod n) + 1}}^{-1} (y_{m, ((p-1) \bmod n) + 1}) \cdot \mu'_{b'_{m,p}, m, \lfloor \frac{p-1}{n} \rfloor + 1}^{-1} \left(i'_{m, \lfloor \frac{p-1}{n} \rfloor + 1} \right)}{n}$$

$$\widetilde{e}_A(m, p) \triangleq \left\lfloor \frac{(V_A(m, p) - \rho_{m,p}) \sqrt{nk}}{K} \right\rfloor \bmod 2$$

$$\widetilde{e}_B(m, p) \triangleq \left\lfloor \frac{(V_B(m, p) - \rho_{m,p}) \sqrt{nk}}{K} \right\rfloor \bmod 2$$

We have to justify that:

$$H \left(\{ \widetilde{e}_A(m, p) \}_{p \in \mathbb{N}_{n^2}^*} \right) = H \left(\{ \widetilde{e}_B(m, p) \}_{p \in \mathbb{N}_{n^2}^*} \right) \approx n^2$$

Let's take $\{ \widetilde{e}_A(m, p) \}_{p \in \mathbb{N}_{n^2}^*}$ (by symmetry, the result is the same for $\{ \widetilde{e}_B(m, p) \}_{p \in \mathbb{N}_{n^2}^*}$). One can view

$$\{ V_A(m, p) \}_{p \in \mathbb{N}_{n^2}^*}$$

as a linear system of size n^2 . Let's consider the matrix J_m whose line vectors are the $\mu'_{b_{m,q}}^{-1}(j_{m,q})$.

The linear system above can be written as block matrix

$$\begin{pmatrix} J_m & & 0 \\ & J_m & \\ & \ddots & \\ 0 & & J_m \end{pmatrix}^t (\sigma_{\Phi'_{m,1}}^{-1}(y_{m,1}), \dots, \sigma_{\Phi'_{m,n}}^{-1}(y_{m,n}))$$

For each J_m block, we can apply the result of Proposition AII-2 in Appendix II, with the value of binary random variable parameter being:

$$\theta = \frac{1}{nk} \int_{[0,1]^n} |x| \Phi_{m,r}(x) dx$$

and the sampling parameter q being:

$$\delta = \frac{K\sqrt{n}}{\sqrt{k}}$$

We then have $\delta^n \sqrt{n! \theta^n (1 - \theta)^{n-1} (n\theta - \theta + 1)} \gg 1$, and thus $H \left(\{ \widetilde{e}_A(m, p) \}_{p \in \mathbb{N}_{n^2}^*} \right) \approx n^2$. We note as well ([15], [16]) that the probability of a random $\{0,1\}$ matrix is singular is $O\left(\frac{1}{\sqrt{n}}\right)$.

With this technique, A (resp. B) generates only n pairs $(\mu_0(I_0), \mu_1(I_0))$ rather than n^2 pairs in order to obtain the n^2 distilled digits $\{ \widetilde{e}_A(m, p) \}_{p \in \mathbb{N}_{n^2}^*}$.

Lastly, the fact that the lines of J_m are generated by a distribution in $\zeta(\alpha)$ rather than a uniform distribution over $\{0,1\}^n$ does not jeopardize its entropy, and thus keep the assumption that is nonsingular fairly reasonable. As an example of the above statement, let's determine $H(x)_{\Phi_0}$ where Φ_0 is the distribution given by:

$$P\left(\sum_{s=1}^{n/2} x_s = t\right) = P\left(\sum_{s=n/2+1}^n x_s = t'\right) = \frac{2}{n}, \forall t, t' \in \{0, \dots, n/2\}$$

Its quadratic matrix is:

$$\begin{pmatrix} 1/2 & \dots & 1/3 & 1/4 & \dots & 1/4 \\ \vdots & \ddots & \vdots & \vdots & & \vdots \\ 1/3 & \dots & 1/2 & 1/4 & \dots & 1/4 \\ 1/4 & \dots & 1/4 & 1/2 & \dots & 1/3 \\ \vdots & & \vdots & \vdots & \ddots & \vdots \\ 1/4 & \dots & 1/4 & 1/3 & \dots & 1/2 \end{pmatrix}$$

and it verifies (with notations introduced in [9]):

$$\|M_{\Phi_0} - \overline{M_{\Phi_0}}\|_c = \frac{1}{12} + o\left(\frac{1}{n}\right)$$

We show in Appendix I that $H(x)_{\Phi_0} = \frac{n}{2} - O(\log n)$, which suggests that the probability that J_m is singular remains small even with a distribution in $\zeta(\alpha)$.

Simulations

Simulations for the protocol with 'Reuse and Recombine' optimization technique are presented in Appendix III. Those simulations adopt the same methodology than in [11]. In summary, we obtain in those simulations a lower bound for the Cryptologic Limit of

$$CL \gtrsim 0,0006$$

although it was $CL \gtrsim 0,76 \cdot 10^{-6}$ in [11] without the bit reuse and recombine technique. It should be noted that the simulations in [11] didn't take into account the discarding of rounds with $|T_m| \neq 2$.

Memory vs Bandwidth compromise

It is clear that this technique dramatically improves the bandwidth consumption, but the price to pay is a dramatic increase of the memory needed by each partner to perform the optimized protocol. Indeed they have to create and maintain a memory structure of n^2 bits during the duration of the protocol.

On the other hand, it is possible to take an intermediate stance, where the partners only memorize $w < n$ vectors instead of n . The reuse and recombine method then follows the same logic, the memory structure are nw bits large instead of n^2 , and the bandwidth reduction factor will be w instead of n .

The parameter w can be chosen by a partner as his maximum possibility with regards to his memory capacity, and the corresponding partners can then negotiate $w = \min(w_A, w_B)$ during an initial phase

of the protocol. A Server-Server communication in a rare bandwidth context will use a maximum $w = n$, when a Client-Server will use a smaller w depending on the Client capacity.

Combination of error correcting codes

The bit repetition error correcting method used in [9] is clearly not optimal in terms bandwidth consumption, but it has the power to create Advantage distillation. Typically, it appears in the simulations of Appendix III that, with a repetition code length as small as 4, it is possible to lower the partners' error rate below 30%, which corresponds to a BSC error parameter below 15%. It is established in [13] that, when the BSC error parameter is below 15%, it is possible to use Cascade, a more efficient error correcting protocol than the bit repetition one. Cascade has the drawback to be highly interactive, but it is close to optimal efficiency in terms of bandwidth consumption. It has also been proposed [18] to use optimized versions for BSC of LDPC codes initially introduced by Gallager [17], in order to avoid the interactive complexity of Cascade. Both Cascade and optimized LDPC for BSC work for a range of protocols including QKD and Maurer satellite scenario, and they are also applicable to the Deep Random Secrecy protocols in their Reconciliation phase.

Therefore, it is recommended to adapt the protocol parameters in such a way that the repetition code at step 5' is used with the smallest possible code length needed to drive the error rate below the threshold where one of the above Reconciliation protocols become efficient, in order to reach an acceptable error rate.

III. Extended protocol against active opponent

We have introduced in [14] how the protocol reminded in Section I can be extended to include an authentication scheme, enabling the legitimate partners to resist to active unlimited MITM. In this section, we will (i) remind the results obtained in [14], (ii) show how the extension copes with the "bit reuse and recombine" optimization technique seen in former section, and (iii) discuss some implementation aspects.

The purpose of the extended protocol is still to generate a common secret bit string S between the legitimate partners, but this time in the perspective of an active unlimited MITM.

Without the authentication extension, the protocol can be represented by the diagram below with the "bit reuse and recombine" optimization technique:

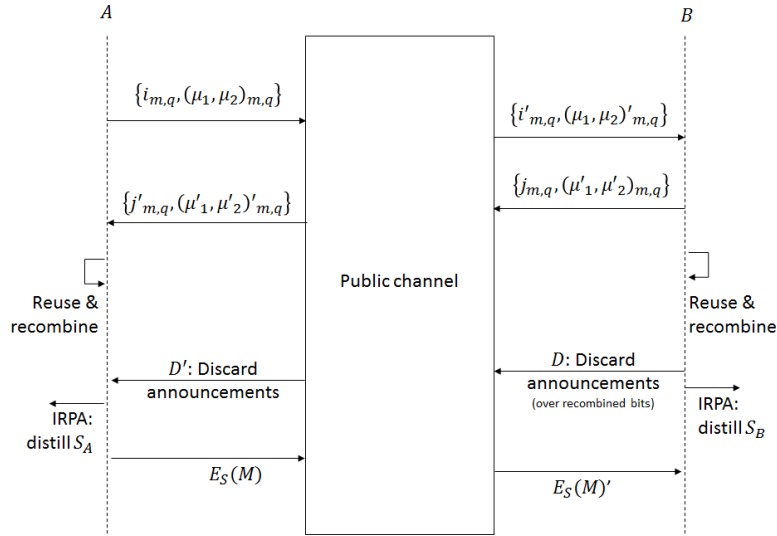

Fig. 2

The purpose of generating S is of course to transmit a secret message M from A to B . The encryption function $E_S(M)$ can be simply $S \oplus M$ if one want the highest security offered by one time pad, or another symmetric key encryption scheme working with a shared secret key S . While we have shown that a passive opponent cannot gain knowledge of S , it is obvious that an active opponent can insert himself in the communication, first playing the role of B with A , which enables him to collect M , and then, optionally, to play the role of A with B to transmit M , or even a different message M' to B .

We will see now how to prevent this MITM attack with an extended version of the protocol \mathcal{P} .

Reminder of the security model

In our 'active opponent scenario', ξ still has unlimited computation and storage power, but is also capable to (i) delete messages from the public channel, (ii) introduce new messages in the public channel at destination of either A or B ; (i)+(ii) is also equivalent to the capacity to modify a message transiting from A to B or from B to A .

A and B are equipped with a DRG, and also with a private 'wallet' containing a shared authentication secret s , that can be updated at any time by the wallet holder. It is assumed as a pre-condition to the protocol that A and B have initially the same value s_0 in their wallet.

It is assumed that the opponent ξ has no access to (i) the content of a private wallet, (ii) anything computed or stored within a DRG.

The goal of the extended protocol is to continue to ensure that, $\forall \varepsilon, \varepsilon' > 0$

- (i) $P(e_A \neq e_B) \leq \varepsilon$
- (ii) $\left| P(e_\xi = e_B) - \frac{1}{2} \right| \leq \varepsilon'$

even with such an active opponent.

Description of the extended protocol \mathcal{P}^*

As formerly exposed in [14], the extended protocol that we propose is possible only because of a specific non-reversibility property of \mathcal{P} . Indeed it is shown in [9] (Lemma3) that, when the public

information (i, j) is given, with the assumption that the distributions are synchronized, then it is impossible to reversely determine x or y with an accuracy equal to the one of a partner's estimation. \mathcal{P}^* is original because, unlike any other protocol that does not benefit from the non-reversibility property of Deep Random Secrecy, it resists to opponents that are both unlimited and active MITM.

The extension presented in [14] consists in adding a mutual verification phase after the bit string S has been generated, and before transmitting the secret message M . M having a length bounded by $|M| \leq L_M$, we denote by N the number of blocks to be sent to distill a message of length L_M ; typically $N = \lceil L_M/L^* \rceil$ (using notations of Fig. 1). This verification is performed by:

- (i) dividing the shared secret into 2 independent piece (s_A, s_B) (with $H(s_A) = H(s_B) = H(s)/2$)

- (ii) sending from A to B (resp. B to A) a verification code

$$c_A = h\left(s_A, \{i_{m,q}, (\mu_1, \mu_2)_{m,q}\}_{m \leq N, q \in \mathbb{N}_n^*}, \{j'_{m,q}, (\mu'_1, \mu'_2)'_{m,q}\}_{m \leq N, q \in \mathbb{N}_n^*}\right)$$

(resp.)

$$c_B = h\left(s_B, \{i'_{m,q}, (\mu_1, \mu_2)'_{m,q}\}_{m \leq N, q \in \mathbb{N}_n^*}, \{j_{m,q}, (\mu'_1, \mu'_2)_{m,q}\}_{m \leq N, q \in \mathbb{N}_n^*}\right)$$

(the characteristics of the verification function h will be discussed hereafter)

- (iii) verifying by B (resp. by A) that the local computation

$$v_A = h\left(s_A, \{i'_{m,q}, (\mu_1, \mu_2)'_{m,q}\}_{m \leq N, q \in \mathbb{N}_n^*}, \{j_{m,q}, (\mu'_1, \mu'_2)_{m,q}\}_{m \leq N, q \in \mathbb{N}_n^*}\right)$$

(resp.)

$$v_B = h\left(s_B, \{i_{m,q}, (\mu_1, \mu_2)_{m,q}\}_{m \leq N, q \in \mathbb{N}_n^*}, \{j'_{m,q}, (\mu'_1, \mu'_2)'_{m,q}\}_{m \leq N, q \in \mathbb{N}_n^*}\right)$$

is equal to the received code ($c'_A = v_A$) (resp. ($c'_B = v_B$))

- (iv) using part of the entropy of S to renew (sending $R(s')$) a new value of the shared authentication secret s' for a next round

- (v) storing by A (resp. B) the new value of shared authentication secret s' in its private wallet.

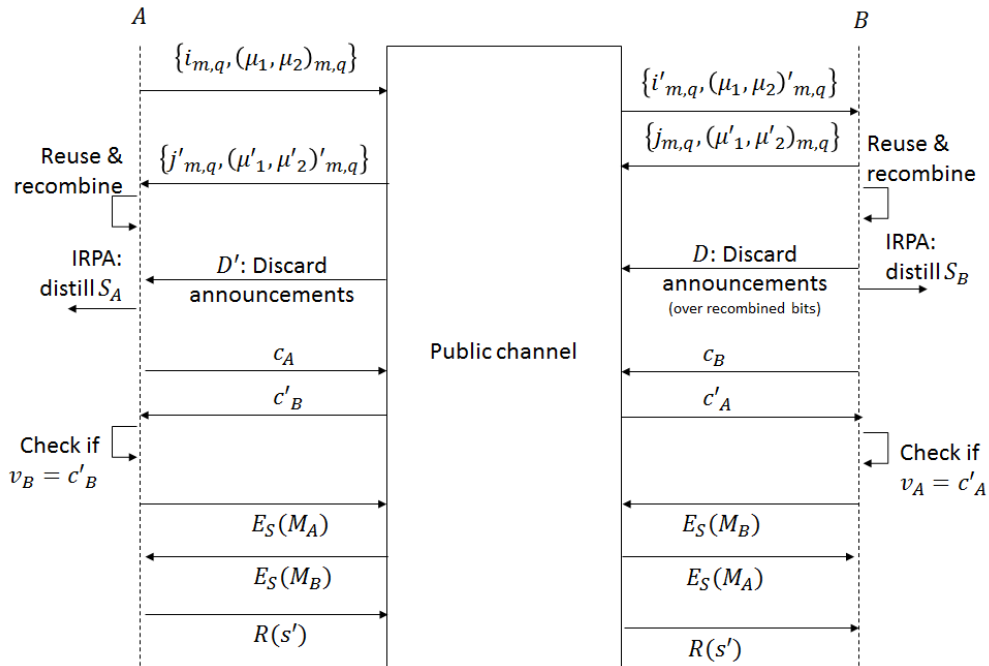

Fig. 3

Assuming that $E_S(M) = S \oplus M$ (secret messages can be sent in both sense, which is why the diagram above represents $E_S(M_A)$ and $E_S(M_B)$), the common shared bit string must have length:

$$|S| \geq H(s) + L_M$$

in order to be able to fully renew the shared authentication secret s after each round.

It should be noted that the above described example presents a mutual authentication. It is of course possible to execute the protocol with a one way authentication only if for instance, say B , is a public resource, in which base only B needs to authenticate to A .

Design considerations for security

We have shown in [14] that the authentication scheme is secure if the verification function h satisfies the following sufficient (but not necessary) properties:

Property 1:

$$\begin{aligned} & \text{if } \{i_{m,q}, (\mu_1, \mu_2)_{m,q}\}_{m \leq N, q \in \mathbb{N}_n^*}, \{j'_{m,q}, (\mu'_1, \mu'_2)'_{m,q}\}_{m \leq N, q \in \mathbb{N}_n^*} \text{ are known, then} \\ & \# \left\{ s \mid h \left(s, \{i_{m,q}, (\mu_1, \mu_2)_{m,q}\}_{m \leq N, q \in \mathbb{N}_n^*}, \{j'_{m,q}, (\mu'_1, \mu'_2)'_{m,q}\}_{m \leq N, q \in \mathbb{N}_n^*} \right) \right. \\ & \quad \left. = h \left(s_A, \{i_{m,q}, (\mu_1, \mu_2)_{m,q}\}_{m \leq N, q \in \mathbb{N}_n^*}, \{j'_{m,q}, (\mu'_1, \mu'_2)'_{m,q}\}_{m \leq N, q \in \mathbb{N}_n^*} \right) \right\} \gg 1 \end{aligned}$$

Property 2:

$$\begin{aligned} & \text{if } \{i_{m,q}, (\mu_1, \mu_2)_{m,q}\}_{m \leq N, q \in \mathbb{N}_n^*}, \{j'_{m,q}, (\mu'_1, \mu'_2)'_{m,q}\}_{m \leq N, q \in \mathbb{N}_n^*} \text{ are known, and } s \neq s' \\ & P \left(h \left(s, \{i_{m,q}, (\mu_1, \mu_2)_{m,q}\}_{m \leq N, q \in \mathbb{N}_n^*}, \{j'_{m,q}, (\mu'_1, \mu'_2)'_{m,q}\}_{m \leq N, q \in \mathbb{N}_n^*} \right) \right. \\ & \quad \left. = h \left(s', \{i_{m,q}, (\mu_1, \mu_2)_{m,q}\}_{m \leq N, q \in \mathbb{N}_n^*}, \{j'_{m,q}, (\mu'_1, \mu'_2)'_{m,q}\}_{m \leq N, q \in \mathbb{N}_n^*} \right) \right) = o_{H(s)}(1) \end{aligned}$$

Property 3:

There does not exist any non-trivial transformation T applying on the space $\{i'_{m,q}, (\mu_1, \mu_2)'_{m,q}\}_{m \leq N, q \in \mathbb{N}_n^}, \{j'_{m,q}, (\mu'_1, \mu'_2)'_{m,q}\}_{m \leq N, q \in \mathbb{N}_n^*}$ such that*

$$\begin{aligned} \forall s, \quad & h \left(s, \{i_{m,q}, (\mu_1, \mu_2)_{m,q}\}_{m \leq N, q \in \mathbb{N}_n^*}, T \left(\{j'_{m,q}, (\mu'_1, \mu'_2)'_{m,q}\}_{m \leq N, q \in \mathbb{N}_n^*} \right) \right) \\ & = h \left(s, T \left(\{i'_{m,q}, (\mu_1, \mu_2)'_{m,q}\}_{m \leq N, q \in \mathbb{N}_n^*} \right), \{j_{m,q}, (\mu'_1, \mu'_2)_{m,q}\}_{m \leq N, q \in \mathbb{N}_n^*} \right) \end{aligned}$$

We propose to use:

$$h_{a,b}(x) \triangleq ((ax + b) \bmod p) \bmod 2^{\frac{H(s_A)}{2}}$$

$$\begin{aligned}
& h\left(s, \{i_{m,q}, (\mu_1, \mu_2)_{m,q}\}_{m \leq N, q \in \mathbb{N}_n^*}, \{j_{m,q}, (\mu'_1, \mu'_2)_{m,q}\}_{m \leq N, q \in \mathbb{N}_n^*}\right) \\
& \triangleq \left(\bigoplus_{l \in \{(m,q) | m \leq N, q \in \mathbb{N}_n^*\}} (h_{a_l, b_l}(i_l + s\bar{l})) \right) \\
& \oplus \left(\bigoplus_{l \in \{(m,q) | m \leq N, q \in \mathbb{N}_n^*\}} (h_{a'_l, b'_l}(j_l + s\bar{j}_l)) \right) \\
& \oplus \left(\bigoplus_{l \in \{(m,q) | m \leq N, q \in \mathbb{N}_n^*\}} (h_{c_l, d_l}(\mu_{1_l} + s\overline{\mu_{1_l}})) \right) \\
& \oplus \left(\bigoplus_{l \in \{(m,q) | m \leq N, q \in \mathbb{N}_n^*\}} (h_{c'_l, d'_l}(\mu'_{1_l} + s\overline{\mu'_{1_l}})) \right) \\
& \oplus \left(\bigoplus_{l \in \{(m,q) | m \leq N, q \in \mathbb{N}_n^*\}} (h_{e_l, f_l}(\mu_{2_l} + s\overline{\mu_{2_l}})) \right) \\
& \oplus \left(\bigoplus_{l \in \{(m,q) | m \leq N, q \in \mathbb{N}_n^*\}} (h_{e'_l, f'_l}(\mu'_{2_l} + s\overline{\mu'_{2_l}})) \right)
\end{aligned}$$

where p is a prime superior to $2^{\frac{H(s)}{2}}$, and $\{a_l, b_l, c_l, d_l, e_l, f_l, a'_l, b'_l, c'_l, d'_l, e'_l, f'_l\}$ are random non-zero integers, fixed as parameters of the protocol (not negotiated); they can typically be the successive outputs of a congruential generator to avoid to store all of them in memory. The permutation μ_{1_l} is written above with its canonical binary form to be able to compute it with arithmetic. $i_l + s\bar{l}$ is a non-linear form on i_l also involving s for each $i_l, \mu_{1_l}, \mu_{2_l}, j_l, \mu'_{1_l}, \mu'_{2_l}$. $\{h_{a,b}(x)\}$ is a well known universal hashing class of functions, thus benefiting from the good probabilistic properties of such class.

The modularity structure of h in terms of using blocks of the form $(h_{a_l, b_l}(i_l + s\bar{l}))$ and composing them by simple \oplus is chosen on purpose; when the sets $\{i_l, (\mu_1, \mu_2)_l\}$ are reused in our reuse and recombine technique, the associated block can be reused without re-computation of the arithmetical operations.

Eventually, note that the computation of h is obviously highly sensitive to errors in the transmission of the $\{i_l, (\mu_1, \mu_2)_l, j_l, (\mu'_1, \mu'_2)_l\}_L$, and therefore it is recommended to associate each $\{i_l, (\mu_1, \mu_2)_l\}$ with an error control checksum.

The size parameters $H(s), L_M, L$ should also be fixed as parameters of the protocol and not negotiated, in order to avoid that they become also vulnerable to MITM attacks.

IV. Implementation considerations

An implementation of Deep Random secrecy for a communicating entity (Partner A) can typically comprise 3 modules, as shown in the diagram below:

- A Deep Random Generator
- A Wallet
- A Communication module

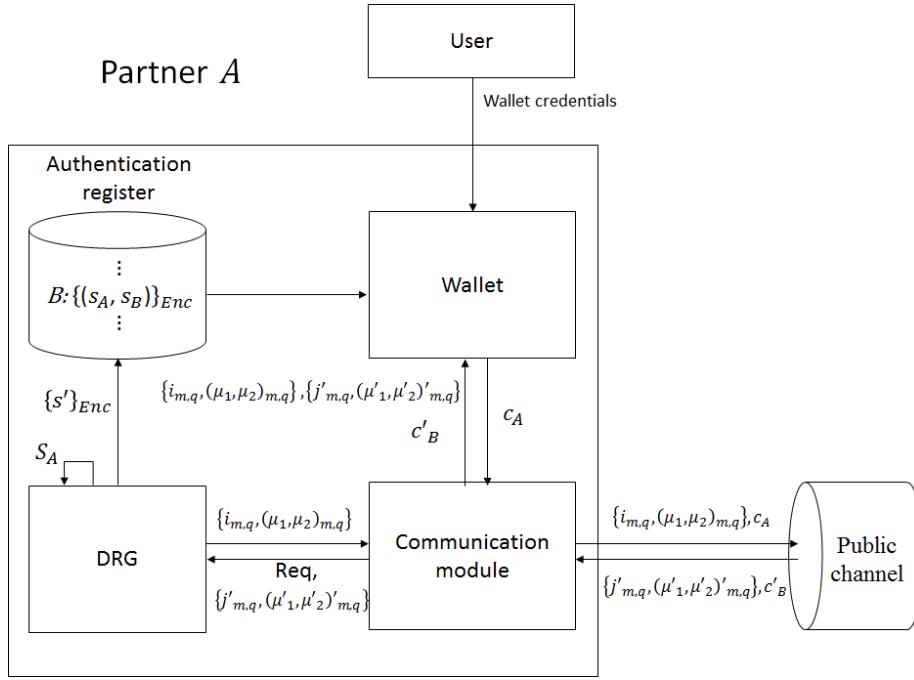

Fig. 4

The Deep Random Generator (DRG)

The Deep Random Generator can be implemented by using the techniques presented in [12], and in particular the ‘partition summing’ method to compute the synchronization permutation σ_{Φ_s} for each new distribution Φ_s generated.

The DRG is supported by a recursive generation process as presented in [12], and should not deliver any usable output before it has reached its ‘maturity period’ as defined in [12]. Once the maturity period has been reached, one may consider the compromise between entropy of the DRG and computation cost. Indeed, the implementation that maximizes DRG’s entropy is to continue running the recursive process without interruption (‘continuous’ implementation strategy), but it is at the cost of a significant burden on the computation power. Another possible implementation is to stop the recursive process once the DRG has reached maturity, and from that moment to iterate only at the time when the generation of a new vector x is requested. That ‘on demand’ strategy of implementation respects the minimal entropy requirement together with being much less greedy in computation power. Devices that have limited computation power (Clients) should adopt the ‘on demand’ implementation strategy. Some powerful entities (DRG servers) may be reserved or dedicated to generate high entropy Deep Randomness, and can then service other entities to “upgrade” their DRG internal state with new possible distributions, by using the combination process described in [12].

It is recommended that a DRG is implemented in a tamper resistant manner, so that the internal state of the generator is kept safe from memory investigation. The scope of the DRG treatments implemented in the tamper resistant environment depends on the tamper resistant memory capacity available. In the ideal, only the public information would be processed outside of the DRG, as suggested in the above diagram.

The Authentication Wallet

The authentication Wallet manages the one way or mutual authentication between A and any partner B_t . The Wallet is associated with a directory called “Authentication register” where, for each registered partner B_t , the current value of the authentication shared secret $(s_A, s_B)_t$ is securely stored (typically encrypted with a master key managed by the Wallet’s user and activated by some Wallet credentials as generically suggested in the diagram above). For one way registered partner (authenticated public resources), the authentication shared secret is half empty $(\cdot, s_B)_t$.

The initialization of authentication shared secret between A and B_t happens during a ‘registration phase’ in which the partners are not yet capable to authenticate each other by mean of the protocol. Thus, some other credential should be exchanged between A and B_t during the ‘registration phase’ in order for them to trust each other. Those ‘identification’ credentials and the initial seed of their authentication shared secret should be exchanged through an unauthenticated instance of the protocol in order to protect them in confidentiality and integrity.

Note that there may happen a loss of synchronization of the authentication shared secret between a pair of partners due to network connection failures. Therefore, in order to make the protocol resistant to such loss of synchronization, it should be allowed to reuse the authentication shared secret a limited number of times (which however should be taken into account in the conditional entropy of c_A and c_B). Beyond that limit, the shared secret should be considered as compromised and the partners should go again through a registration phase.

Advanced protocols

DR-TLS:

The extended protocol presented in this paper supplies primitives to exchange keys, and / or perform a one way or mutually authenticated connection between 2 partners. It is therefore natural to question how such protocol could candidate to replace a popular protocol such as TLS in a post quantum era.

Where our protocol is conceptually even stronger than TLS because it prevents by design MITM attacks, it does not offer the convenience of Public Key infrastructure and signature to easily ‘forward’ the trust from a root authority to any end-user trusting that authority to authenticate its partner. The concept of Public Key cryptography is, by nature, excluded from our security model because the opponent is supposed to have unlimited computation capacity. However, the issuance by a trusted authority of a digital certificate to one of the partner (single TLS authentication) or to both of the partners (TLS mutual authentication) can be replaced by an interactive confirmation by a trusted authority, supporting the registration phase:

Suppose Partner A and Partner B want to enter into registration phase and avoid MITM attacks. Both are already registered with a trusted authority C . Here is how they can proceed:

- 1) A informs C that it wants to register with B , and exchange a session key s_A with C , by using the mutually authenticated key exchange primitive.
- 2) C requests B to exchange a session key s_B , by using the mutually authenticated key exchange primitive.
- 3) A and B use the unauthenticated key exchange primitive to exchange (i) an initial seed of their authentication shared secret, (ii) the values of c_A and c_B as defined in the extended protocol, sent respectively by A and B .

- 4) C sends s_B to A (still through their authenticated channel) which enables A to compute v_B and thus to confirm the identity of B . B can do the same by receiving s_A from C .

Such method can be refined in many ways, like for instance by using Kerberos-like ticketing model in order to avoid that C is systematically requested by both partners willing to register to each other.

DR-SMTP:

One of the interest of Deep Random Secrecy compared to Quantum Key Distribution (QKD), besides obviously to be fully implementable with classical computing and communication resources, is that Deep Random Secrecy supports asynchronous protocols, due to the fact that the public information exchanged along the protocol can be store, duplicated, forwarded, resent at will without jeopardizing the security or the functioning of the protocol. This is of course not true with quantum information that cannot be duplicated, and therefore is by nature highly restricted to synchronous interactions.

The above remark means that it is possible to design an asynchronous messaging protocol, such as SMTP, supported by the Deep Random Secrecy primitives. None of the routing devices involved in the communication need to be sure, or even to know about Deep Random generation, they can just be storage and transmission devices.

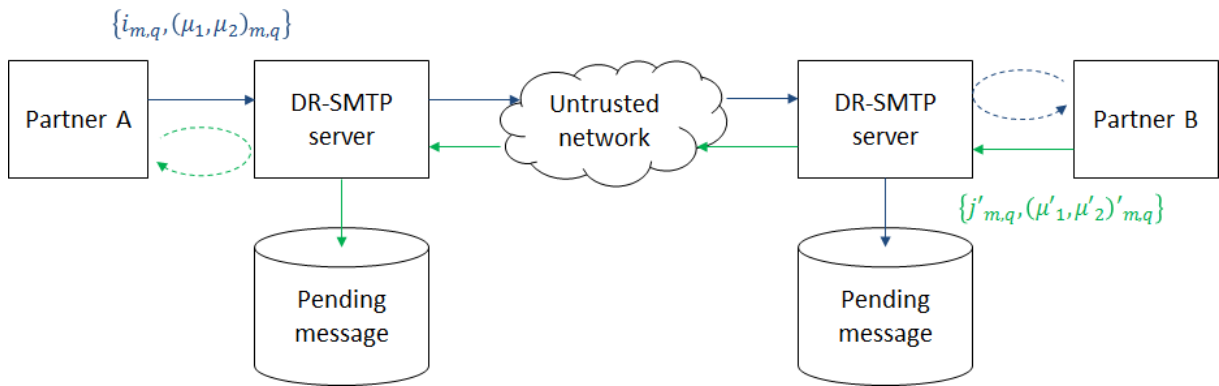

Fig. 5

V. Conclusion

We have proposed an extended set of protocols based on Deep Random Secrecy, benefiting from dramatic improvement in terms of bandwidth efficiency compared to previous presented versions. That improvement is based on reuse and recombination of bits, and we have justified that such reuse does not jeopardize the entropy of the distilled secret information.

We have provided new simulations, based on prior introduced methodology, showing in figures the increase of performance.

The bit reuse and recombine optimization technique has been applied to two primitives: (i) the unauthenticated protocol needing no prior shared knowledge between the partners and resisting to passive unlimited eavesdropper; and (ii) the authenticated protocol needing a short authentication shared secret between the partners, and resisting to active unlimited MITM.

We have also addressed consideration on practical design and implementation. We showed the different modules that should be comprised in a Deep Random Secrecy communication system, in particular, the DRG, and the Authentication Wallet. We have identified the important compromises between computation, memory and bandwidth that need to be considered, and we have discussed the various possibility of implementation for those modules, depending on the capacity of the host.

At last, we have also shown how one can combine the two primitives to implement more elaborated protocols that could be candidate to replace popular protocols such as TLS or SMTP in a post-quantum era.

We have discussed the fact that the performance of the overall protocol is also highly depending on the performance of the Reconciliation and Privacy Amplification techniques that we use. The primitives and simulations presented in this paper only use the basic 'bit repetition' reconciliation technique in order to show the emergence of Advantage Distillation phenomenon. Further work, in the perspective of practical implementation, should study how advanced Reconciliation techniques such as Cascade or LDPC codes can efficiently be introduced in the protocol to improve its efficiency.

References

- [1] C. E. Shannon, « Communication theory of secrecy systems », Bell Syst. Tech. J., Vol. 28, pp. 656-715, Oct. 1949
- [2] A. N. Kolmogorov, « On Tables of Random Numbers », Sankhya. Indian Journal of Statistics A, 25(4) :369-376
- [3] C. H. Bennet and G. Brassard, « Quantum cryptography and its application to provable secure key expansion, public-key distribution and coin-tossing », Proc. IEEE International Conference on Computers, Systems and Signal Processing, Bangalore, India, pp. 175-179, Dec. 1984
- [4] C. H. Bennet, G. Brassard and J.-M. Robert, « Privacy Amplification by Public Discussion », SIAM J. COMPUT., Vol. 17, No. 2, Apr. 1988
- [5] U. M. Maurer, « Secret Key Agreement by Public Discussion from Common Information », IEEE Transactions on Information Theory, Vol. 39, No. 3, May 1993
- [6] C. Cachin and U. M. Maurer, « Unconditional Security Against Memory-Bounded Adversaries », Proceeding of CRYPTO '97, Lecture Notes in Computer Science, Springer, 1997
- [7] E. T. Jaynes, « Prior Probabilities », IEEE Transactions On Systems Science and Cybernetics, vol. sec-4, no. 3, 1968, pp. 227-241
- [8] R. T. Cox, « Probability, frequency and reasonable expectation », American Journal of Physics 17 (1946) 1-13
- [9] T. de Valroger, « Perfect Secrecy under Deep Random assumption », Arxiv.org (<http://arxiv.org/abs/1507.08258> full version)
- [10] P. S. de Laplace, « A philosophical essay on Probabilities », Paris 1814
- [11] T. de Valroger, « Simulations for Deep Random Secrecy protocols », Arxiv.org (<https://arxiv.org/abs/1611.01683>)
- [12] T. de Valroger, « Practical Implementation of a Deep Random Generator », Arxiv.org (<https://arxiv.org/abs/1712.09333>)
- [13] G. Brassard and L. Salvail, « Secret-Key Reconciliation by Public Discussion »
- [14] T. de Valroger, « Deep Random based Key Exchange protocol resisting unlimited MITM », Arxiv.org (<https://arxiv.org/pdf/1801.01456>)
- [15] J. Komlos, On the determinants of (0, 1) matrices, Studia Sci. Math. Hungar. 2 (1967), 7–21.
- [16] Terence Tao, Van Vu, “On the singularity probability of random Bernoulli matrices”, Arxiv.org (<https://arxiv.org/abs/math/0501313> 2008 (v2))
- [17] R. Gallager, “Low density parity check codes” PhD, MIT 1963
- [18] David Elkouss, Anthony Leverrier, Romain Alléaume, Joseph Boutros, “Efficient reconciliation protocol for discrete-variable quantum key distribution” ArXiv.org:0901.2140 2009.

Who is the author ?

I have been an engineer in computer science for 20 years. My professional activities in private sector are related to IT Security and digital trust, but have no relation with my personal research activity in the domain of cryptology. If you are interested in the topics introduced in this article, please feel free to establish first contact at tdevalroger@gmail.com

Appendix I: Entropy of $H(x)_{\Phi_0}$

We have $H(x)_{\Phi_0} = \frac{n}{2} + O(\log n)$

■

$$\begin{aligned} H(x)_{\Phi_0} &= 2 \sum_{t=0}^{n/2} \sum_{x \mid |x|=t} \frac{1}{\binom{n}{2+1} \binom{n/2}{t}} \log \left(\binom{n}{2+1} \binom{n/2}{t} \right) = \frac{2}{\binom{n}{2+1}} \sum_{t=0}^{n/2} \log \left(\binom{n}{2+1} \binom{n/2}{t} \right) \\ &= \frac{2}{\binom{n}{2+1}} \sum_{t=0}^{n/2} \log \left(\binom{n/2}{t} \right) + O(\log n) \end{aligned}$$

We have:

$$\begin{aligned} \sum_{t=0}^{n/2} \log \left(\binom{n/2}{t} \right) &= \log \frac{\left((n/2)! \right)^{n/2+1}}{\left(\prod_{t=0}^{n/2} t! \right)^2} = \left(\frac{n}{2} + 1 \right) \log \left((n/2)! \right) - 2 \log \left(\prod_{t=0}^{n/2} t! \right) \\ &= \left(\frac{n}{2} + 1 \right) \log \left((n/2)! \right) - 2 \sum_{u=1}^{n/2} \left(\frac{n}{2} + 1 - u \right) \log u \end{aligned}$$

Injecting the two equalities below in the above,

$$\begin{aligned} \sum_{t=0}^{n/2} \log t &= \frac{n}{2} \log \frac{n}{2} - \frac{n}{2} + O(1) \\ \sum_{t=0}^{n/2} t \log t &= \frac{n^2}{8} \log \frac{n}{2} - \frac{n^2}{16} + O(n) \end{aligned}$$

we eventually get the result. ■

Appendix II: entropy in linear systems

For $p \in \mathbb{N}^*$, we consider the hyper-parallelepiped $S[0, p]$:

$$S[0, p]_{\{\lambda(r) \in \{0,1\}^n\}}(x_1, \dots, x_n) = \left\{ x \in \mathbb{R}^n \mid 0 \leq \sum_{s=1}^n \lambda_s(r) x_s \leq p \right\}_{1 \leq r \leq n}$$

where we suppose that $\{\lambda(r) \in \{0,1\}^n\}$ is an independent linear system. For $\delta \in \mathbb{N}^*$, $\delta|p$, we also consider the hyper-cubic tiling of \mathbb{R}^n defined by

$$\pi_{t_1, \dots, t_n}(x) = \left\{ x \in \mathbb{R}^n \mid \forall r, \left\lfloor \frac{(\lambda(r) \cdot x - n\rho_r)}{\delta} \right\rfloor = t_r \right\}$$

where $\{\rho_r \in [0,1]\}$ are translation parameters. We eventually consider the checkerboard coloring function associated to that tiling:

$$e_r(x) = \left\lfloor \frac{(\lambda(r) \cdot x - n\rho_r)}{\delta} \right\rfloor \bmod 2$$

Our purpose in this section is to determine the entropy $H(\{e_1(x), \dots, e_n(x)\})$ depending on some statistical properties of the linear system $\{\lambda(r) \in \{0,1\}^n\}$ and the translation parameters $\{\rho_r \in [0,1]\}$.

Proposition AII-1:

We consider the case where $|\lambda(r)| = p$, and $\delta|p$, and $\rho_r = 0 \forall r$. If x is equidistributed over $S[0, p]$, and if $p/\delta \equiv 0 \pmod{2}$, then we have $H(\{e_1(x), \dots, e_n(x)\}) = n$

■ As $p/\delta \equiv 0 \pmod{2}$ and $p > 0$, there exists a vertex (t_1, \dots, t_n) of the tiling that is contained in the interior strict of S . The linear system being independent, there are 2^n cells that are neighboring the vertex and each of them represents a unique combination of $\{e_1(x), \dots, e_n(x)\}$ in $\{0,1\}^n$.

$$\begin{array}{ccc} \bar{S} & & \\ \downarrow \pi_{t_1, \dots, t_n}(x) & \searrow \{e_1(x), \dots, e_n(x)\} & \\ \mathbb{N}_{p-1}^n & \xrightarrow{\tilde{T} = \{t_r \bmod 2\}} & \{0,1\}^n \end{array}$$

With the above diagram, one can see that this argument ensures, by 2δ -translations in any dimension, that any combination of $\{e_1(x), \dots, e_n(x)\}$ in $\{0,1\}^n$ has the exact same number of inverse images by the equi-partitioning surjective function \tilde{T} . The distribution of x being equidistributed over S , the above implies that $H(\{e_1(x), \dots, e_n(x)\}) = n$. ■

The above situation is fairly simple due to the fact that x is equidistributed over $S[0, p]$. We consider now the more complex situation where x is distributed over $[0,1]^n$, and $\{\rho_r\}$ are independent random variable, all being equidistributed over $[0,1]$. In order to simplify the computations, we will also make the reasonable assumption (P) that, $\forall r$:

$$\frac{1}{n} \sum_{s=1}^n \int_{\{0,1\}^n} \lambda_s(r) \Phi_r(\lambda(r)) d\lambda(r) = \theta \quad (P)$$

Proposition AII-2:

We consider the case where the system $\{\lambda(r)\}$ is a random linear system of independent vectors in $\{0,1\}^n$ also verifying (P), and being statistically anisotropic; If x is distributed over $[0,1]^n$, then we have

$$H(\{e_1(x), \dots, e_n(x)\}) \approx n \min\left(1, \delta^n \sqrt{n! \theta^n (1 - \theta)^{n-1} (n\theta - \theta + 1)}\right)$$

■ By considering the statistical translations of the tiling $\pi_{t_1, \dots, t_n}(x)$, we obtain that the average number of solution $x \in [0,1]^n$ for the linear system: $\{e_1(x), \dots, e_n(x)\} = u \in \{0,1\}^n$ is given by

$$E \left[\frac{\text{Vol}([0,1]^n)}{\text{Vol}(\pi_{t_1, \dots, t_n})} \right]$$

Then obviously, $\text{Vol}([0,1]^n) = 1$. By denoting L the matrix associated to the linear system $\{\lambda(r)\}$, we can express the volume of the hyper-parallelepiped π_{t_1, \dots, t_n} as:

$$\text{Vol}(\pi_{t_1, \dots, t_n}) = \text{Vol}(\pi_{0, \dots, 0}) = \text{Vol}(S[0, \delta]) = \int_{[0,1]^n} \left| \text{Det} \left(\frac{1}{\delta} L^{-1} \right) \right| dy = \frac{1}{\delta^n |\text{Det}L|}$$

By applying classical convexity inequality, we get:

$$E \left[\frac{\text{Vol}([0,1]^n)}{\text{Vol}(\pi_{t_1, \dots, t_n})} \right] \geq \frac{1}{E[\text{Vol}(\pi_{t_1, \dots, t_n})]} \geq \delta^n (E[(\text{Det}L)^2])^{\frac{1}{2}}$$

We have of course

$$\text{Det}L = \sum_{\sigma \in \mathfrak{S}_n} \varepsilon(\sigma) \prod_{s=1}^n \lambda_s(\sigma(s))$$

and due to the fact that the vectors are independent and statistically anisotropic (which means that $\lambda(r)$ has the same probability than $\sigma(\lambda(r))$), it is equivalent, when computing $E[(\text{Det}L)^2]$, to assume that the matrix L has independent binary random elements with parameter θ . One can thus apply the result of lemma AII below, and get:

$$E \left[\frac{\text{Vol}([0,1]^n)}{\text{Vol}(\pi_{t_1, \dots, t_n})} \right] \geq \delta^n \sqrt{n! \theta^n (1 - \theta)^{n-1} (n\theta - \theta + 1)}$$

Eventually, the average number of solution $x \in [0,1]^n$ for the linear system: $\{e_1(x), \dots, e_n(x)\} = u \in \{0,1\}^n$ is lower bounded by

$$\delta^n \sqrt{n! \theta^n (1 - \theta)^{n-1} (n\theta - \theta + 1)}$$

■

The following lemma gives a proof for a variation of a well-known result:

Lemma AII

Let L be a random matrix whose elements are independent binary random variables with parameter θ . Then we have:

$$E[(\text{Det}L)^2] = n! \theta^n (1 - \theta)^{n-1} (n\theta - \theta + 1)$$

■ We use the same combinatorial technique than in [9] Lemma 2. We denote, for $\sigma \in \mathfrak{S}_n$, $\text{supp}(\sigma) = \ker(\sigma - \text{id}_{\mathfrak{S}_n}) = \{i, \sigma(i) \neq i\}$ and $|\sigma| = \text{card}(\text{supp}(\sigma))$.

$$(\text{Det}L)^2 = \sum_{\sigma, \mu \in \mathfrak{S}_n} \varepsilon(\sigma)\varepsilon(\mu) \prod_{s=1}^n \lambda_s(\sigma(s))\lambda_s(\mu(s))$$

$$E[(\text{Det}L)^2] = \sum_{\sigma, \mu \in \mathfrak{S}_n} \varepsilon(\sigma)\varepsilon(\mu) \theta^{2(n - \#\{s \in \mathbb{N}_n^* \mid \sigma(s) = \mu(s)\})} \theta^{\#\{s \in \mathbb{N}_n^* \mid \sigma(s) = \mu(s)\}}$$

Reordering by using $\rho = \sigma^{-1} \circ \mu$, and seeing that $\varepsilon(\sigma)\varepsilon(\mu) = \varepsilon(\sigma \circ \mu) = \varepsilon(\sigma^2 \circ \rho) = \varepsilon(\rho)$, we get:

$$E[(\text{Det}L)^2] = n! p^n \sum_{\rho \in \mathfrak{S}_n} \varepsilon(\rho) \theta^{|\rho|}$$

For I a subset of \mathbb{N}_n we define by $|I|$ the cardinality of I and \mathcal{S}_I the subgroup of \mathfrak{S}_n including permutations for which $\text{supp}(\sigma) \subset I$. We will use the general inversion formula, for any function $f: \mathfrak{S}_n \mapsto \mathbb{R}$:

$$F(s) \triangleq \sum_{\substack{\rho \in \mathfrak{S}_n \\ |\rho|=s}} f(\rho)$$

$$G(s) \triangleq \sum_{\substack{I \\ |I|=s}} \sum_{\rho \in \mathcal{S}_I} f(\rho)$$

We first establish a relationship between G and F :

$$G(s) = \sum_{\substack{\rho \in \mathfrak{S}_n \\ |\rho| \leq s}} \left(\sum_{\substack{I \\ |I|=s \\ I \supset \text{supp}(\rho)}} 1 \right) f(\rho) = \sum_{\substack{\rho \in \mathfrak{S}_n \\ |\rho| \leq s}} \binom{n - |\rho|}{s - |\rho|} f(\rho) = \sum_{u=0}^s \binom{n - u}{s - u} F(u)$$

This formula can be reversed by using the classical matrix inverse:

$$\left(\begin{array}{ccc} \dots & \dots & 0 \\ \vdots & \ddots & \vdots \\ \binom{i}{j} & \dots & \end{array} \right)_{i,j \in \mathbb{N}_n}^{-1} = \left(\begin{array}{ccc} \dots & \dots & 0 \\ \vdots & \ddots & \vdots \\ (-1)^{i+j} \binom{i}{j} & \dots & \end{array} \right)_{i,j \in \mathbb{N}_n}$$

(which can be easily seen by considering for instance the inverse of the $\mathbb{R}_n[X]$ endomorphism $P(X) \mapsto P(X + 1)$).

By setting $j' = n - j$ and $i' = n - i$, we have $\binom{n-j}{i-j} = \binom{j'}{j'-i'} = \binom{j'}{i'}$, and thus:

$$\left(\begin{array}{ccc} & \cdots & 0 \\ \vdots & \ddots & \vdots \\ \binom{n-j}{i-j} & \cdots & \end{array} \right)_{i,j \in \mathbb{N}_n}^{-1} = \left(\begin{array}{ccc} & \cdots & 0 \\ \vdots & \ddots & \vdots \\ (-1)^{i+j} \binom{n-j}{i-j} & \cdots & \end{array} \right)_{i,j \in \mathbb{N}_n}$$

from which we take the reverse formula:

$$F(s) = \sum_{u=0}^s (-1)^{u+s} \binom{n-u}{s-u} G(u)$$

Thanks to the above, by choosing $f(\rho) = \varepsilon(\rho)$, we can write $E[(\text{Det}L)^2]$ depending on $G(u)$ as follows:

$$E[(\text{Det}L)^2] = n! \theta^n \sum_{s=0}^n \theta^s \sum_{u=0}^s (-1)^{u+s} \binom{n-u}{s-u} G(u) \quad (\text{LAII.1})$$

As soon as $m \geq 2$, \mathfrak{S}_m contains a transposition τ and we have $\mathfrak{S}_m = \tau \circ \mathfrak{S}_m$, which implies that

$$\sum_{\rho \in \mathfrak{S}_m} \varepsilon(\rho) = 0$$

and therefore,

$$G(u) = \sum_{\substack{I \\ |I|=u}} \sum_{\rho \in \mathfrak{S}_I} \varepsilon(\rho) = \begin{cases} 1 & \text{if } u = 0 \\ n & \text{if } u = 1 \\ 0 & \text{if } u \geq 2 \end{cases}$$

Injecting the above in (LAII.1) we get:

$$\begin{aligned} E[(\text{Det}L)^2] &= n! \theta^n \sum_{s=0}^n \theta^s \left((-1)^s \binom{n}{s} + (-1)^{s+1} n \binom{n-1}{s-1} \right) = n! \theta^n \sum_{s=0}^n \theta^s (-1)^{s+1} (s-1) \binom{n}{s} \\ &= n! \theta^n ((1-\theta)^n + n\theta(1-\theta)^{n-1}) = n! \theta^n (1-\theta)^{n-1} (n\theta - \theta + 1) \end{aligned}$$

■

Appendix III: Simulations for the optimized protocol

Handling dummy DRGs

In our simulation, we don't focus on DRG. As in [11], the DRG of each partner is emulated from the fixed distribution Φ_0 in $\zeta(\alpha)$ with $\sigma_{\Phi_0} = \text{Id}_{\mathcal{S}_n}$.

Input parameters, dispersion and error correcting

As in [11], the simulation is executed for a given set of parameters (n, k, K, L) and, at each execution, it repeats R times the protocol. The dispersion is simulated by the generation of $\sigma_d[i]$ (resp. $\sigma'_d[j]$) in such a way that $i \subset \sigma_d[i](I_0)$ (resp. $j \subset \sigma'_d[j](I_0)$) and randomly, one time over two in average, A (resp. also and independently for B) chooses $\sigma_A = \sigma'_d[j]$ rather than $\sigma_A = \text{Id}$ (resp. $\sigma_B = \sigma_d[i]$ rather than $\sigma_B = \text{Id}$), which simulates the random choice of A (resp. also and independently for B) among (μ'_1, μ'_2) (resp. (μ_1, μ_2)). One can notice that it is useless to introduce random permutation in the draw of Φ_0 because it is easy to verify that $\sigma_d[i]_{[\Phi_0 \circ \mu]} = \mu^{-1} \circ \sigma_d[i]_{[\Phi_0]}$ and thus

$$\Phi_0 \circ \mu \circ \sigma_d[i]_{[\Phi_0 \circ \mu]} = \Phi_0 \circ \sigma_d[i]_{[\Phi_0]}$$

In those simulations, we mainly focus on Advantage Distillation. The effect of Privacy Amplification will be discussed for one of the simulations. Information Reconciliation is not fully considered, but error correcting methods need to be handled at step 5' in order to achieve Advantage Distillation. We will use the (non-optimal) bit repetition method; the codewords v_A chosen by A can only be $(0, 0, \dots, 0)_L$ or $(1, 1, \dots, 1)_L$ depending on $e_A = 0$ or $e_A = 1$. B publicly discards all decoded sequence v_B that is not $(0, 0, \dots, 0)_L$ or $(1, 1, \dots, 1)_L$ and obviously decodes accordingly $e_B = 0$ if $|v_B| = 0$, and $e_B = 1$ if $|v_B| = L$.

The discarding rate is denoted D , corresponding to the average ratio of discarded sequences.

Behavior of the opponent

The behavior of the opponent is tested with 2 canonical strategies among $\Omega_{\#}(G, \mathcal{P})$ and $\Omega'_{\#}(G, \mathcal{P})$:

$$\omega_1(i, j) = \frac{k|i||j|}{n^2}$$

$$\omega_2(i, j, (\mu_1, \mu_2), (\mu'_1, \mu'_2)) = \frac{2k \left(\left(\sum_{r \in \sigma_{\xi, B}(I_0)} i_r \right) \left(\sum_{r \in \sigma_{\xi, A}(I_0)} j_r \right) + \left(\sum_{r \in \overline{\sigma_{\xi, B}(I_0)}} i_r \right) \left(\sum_{r \in \overline{\sigma_{\xi, A}(I_0)}} j_r \right) \right)}{n^2}$$

where $\sigma_{\xi, B}$ is a permutation randomly chosen by ξ among (μ_1, μ_2) and $\sigma_{\xi, A}$ is a permutation randomly chosen by ξ among (μ'_1, μ'_2) . The relevance of the choice of ω_2 is justified in [9] Proposition 14.

A pessimistic approach is adopted in which, the best of the two is selected for the opponent at the end of the execution of a simulation, separately for each measured criteria, when delivering the result (« best » meaning the one that gives the most favorable criteria for the opponent, typically the higher opponent's knowledge rate over the private information, or the lesser Cryptologic Limit).

Output of simulation

Each execution of the simulation outputs 3 information:

- (i) the net error rate for the legitimate partners – denoted ε ,
- (ii) the net knowledge rate for the opponent – denoted ε' , and
- (iii) a lower bound of Cryptologic Limit – denoted CL .

$P(e_A \neq e_B)$ and $\left|P(e_E = e_B) - \frac{1}{2}\right|$ can be seen respectively as the error rate and ‘eavesdropping’ rate, so both with values in $[0,1]$. We decided in [9], by convention that fits the common sense, that $P(e_A \neq e_B)$ cannot be greater than $1/2$, and $P(e_E = e_B)$ cannot be lower than $1/2$; indeed, if $P(e_A \neq e_B) > 1/2$ one can replace e_B by \bar{e}_B (we then denote e_B^* the final choice for e_B), and if $P(e_E = e_B) < 1/2$ one can replace e_E by \bar{e}_E (we then denote e_E^* the final choice for e_E). And therefore, we can define ε as the net error rate, and ε' as the net knowledge rate (by the opponent), with the following formulas:

- (i) $\varepsilon = 2 \left(\min(P(e_A \neq e_B), 1 - P(e_A \neq e_B)) \right) = 2P(e_A \neq e_B^*)$
- (ii) $\varepsilon' = 2 \left(\max(P(e_E = e_B), 1 - P(e_E = e_B)) - \frac{1}{2} \right) = 2 \left(P(e_A = e_E^*) - \frac{1}{2} \right) > 0$

CL as introduced in [9], represents the rate of perfectly reliable bit transmitted over the total amount of bit transmitted, which in the case of the protocol is :

- (iii) $CL = (1 - D) \frac{1 - \varepsilon - \varepsilon'}{6L}$ (one can remark that it is possible to only transmit $\mu_x(I_0)$ instead of μ_x , which can be coded with n bits instead of $n \log_2 n$). Note that, compared to the result presented in [11] which didn't comprise the bit reuse and recombine technique, CL is multiplied by a factor n .

In the proof of main Theorem in [9], it has been explained that the error correction at step 5' may leak additional information to the opponent in the case where the condition

$$|T_m| = \left| \left\{ \tilde{e}_\xi(\mu'_1, \mu_1)_m, \tilde{e}_\xi(\mu'_1, \mu_2)_m, \tilde{e}_\xi(\mu'_2, \mu_1)_m, \tilde{e}_\xi(\mu'_2, \mu_2)_m \right\} \right| = 2$$

is not satisfied. The simulation thus also discards all the rounds of generation of $\{\tilde{e}_A, \tilde{e}_B\}$ that do not satisfy the above condition.

The 3 output information are measured as averaged over all the R repetitions of the protocol within an execution of the simulation.

Presentation of the results

We have executed series of simulations with variations of parameters (K, L) , and with R being equal to at least 5,000.

The simulation program is written in C language, generated with Visual Studio 2015 on Windows 7 - 64 bits. It uses the random generator $RAND()$ of the `stdlib.h` standard library.

In the following results, the sampling parameter K is expressed as a multiple of $\frac{1}{2\sqrt{nk}}$.

In all the graphics below, the abscissa represents the coursing parameter values, the left ordinate represents the values of error rate ε and knowledge rate ε' , the right ordinate represents the values of the Cryptologic Limit's lower bound CL , and the title of the graphic gives the values of the fixed parameters, and the range of the coursing parameter.

The first graphic below presents the effect of increasing the codeword length L . The fixed parameters are ($n = 6000$, $k = 12$, $K = 4$) ; the codeword length is coursing from 2 to 9:

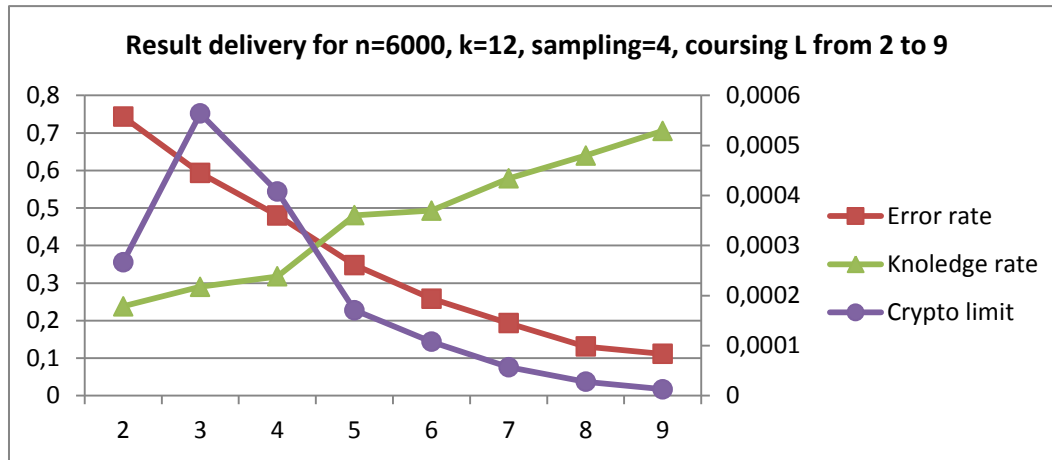

The maximum value for CL is rapidly obtained for $L = 3$. As expected when L increases, the error rate decreases and knowledge increases. The best lower bound for the Cryptologic Limit obtained is roughly $CL \gtrsim 0,0006$, although it was $CL \gtrsim 0,76 \cdot 10^{-6}$ in [11] without the bit reuse and recombine technique. It should be noted that the simulations in [11] didn't take into account the discarding of rounds with $|T_m| \neq 2$.

The second graphic presents the effect of Privacy Amplification. Like in [11], we apply a simple Privacy Amplification method corresponding to the universal hashing function « multiply-add-shift » $h_{a,b}(x) = ((ax + b) \bmod 2^{PA}) \div 2^{PA-1}$, for which parameters a, b are picked for each new output digit (distilled from sequences of PA input digits). The codewords size PA varies from 2 to 12:

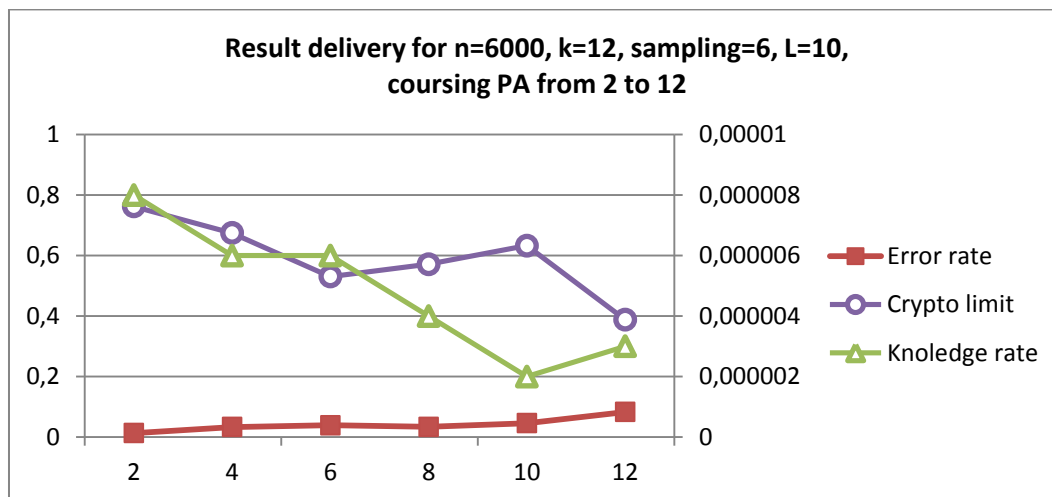

The reduction of the knowledge rate is of course at cost of the increase of the error rate, and at the overall decrease of CL . This simulation is not practically relevant, because Privacy Amplification should be used only after a more efficient Reconciliation method is used to lower the error rate; it is just purposed to show the qualitative effect of Privacy Amplification in the context of a simplistic version of the Deep Random secrecy protocol.