

Approximating Dominating Set on Intersection Graphs of L-frames*

Sayan Bandyapadhyay¹, Anil Maheshwari², Saeed Mehrabi³, and Subhash Suri⁴

- 1 Department of Computer Science, University of Iowa, Iowa City, USA.
sayan-bandyapadhyay@uiowa.edu
- 2 School of Computer Science, Carleton University, Ottawa, Canada.
anil@scs.carleton.ca
- 3 School of Computer Science, Carleton University, Ottawa, Canada.
saeed.mehrabi@carleton.ca
- 4 Department of Computer Science, UC Santa Barbara, USA.
suri@cs.ucsb.edu

Abstract

We consider the Dominating Set (DS) problem on the intersection graphs of geometric objects. Surprisingly, for simple and widely used objects such as rectangles, the problem is NP-hard even when all the rectangles are “anchored” at a line with slope -1. It is easy to see that for the anchored rectangles, the problem reduces to one with even simpler objects: *L-frames*. An *L-frame* is the union of a vertical and a horizontal segment that share one endpoint (*corner* of the *L-frame*). In light of the above discussion, we consider DS on the intersection graphs of *L-frames*.

In this paper, we consider three restricted versions of the problem. First, we consider the version in which the corners of all input *L-frames* are anchored at a line with slope -1, and obtain a polynomial-time $(2 + \epsilon)$ -approximation. Furthermore, we obtain a PTAS in case all the input *L-frames* are anchored at the diagonal from one side. Next, we consider the version, where all input *L-frames* intersect a vertical line, and prove APX-hardness of this version. Moreover, we prove NP-hardness of this version even in case the horizontal and vertical segments of each *L-frame* have the same length. Finally, we consider the version, where every *L-frame* intersects a vertical and a horizontal line, and show that this version is linear-time solvable. We also consider these versions of the problem in the so-called “edge intersection model”, and obtain several interesting results. One of the results is an NP-hardness proof of the third version which answers a question posed by Mehrabi (WAOA 2017).

1 Introduction

Dominating Set (DS) is one of the classical NP-hard problems in the literature of discrete optimization. In this problem, given a graph $G = (V, E)$, the goal is to find a minimum size subset $V' \subseteq V$ such that every vertex not in V' is adjacent to at least one vertex in V' . The problem has applications in several areas including wireless networking, VLSI, and data mining. To cope up with the NP-hardness of DS, researchers have focused their efforts on finding efficient approximation. Indeed, there is a greedy algorithm for DS that admits a $O(\log |V|)$ approximation, and the approximation factor cannot be improved in polynomial time unless $P = NP$. Subsequently, the problem has been extensively studied on numerous graph classes. One such interesting class is the intersection graphs of geometric

* Research of Sayan Bandyapadhyay and Subhash Suri was supported in part by the NSF grant CCF-1525817. Research of Anil Maheshwari is supported in part by NSERC. Saeed Mehrabi is supported by a Carleton-Fields postdoctoral fellowship.



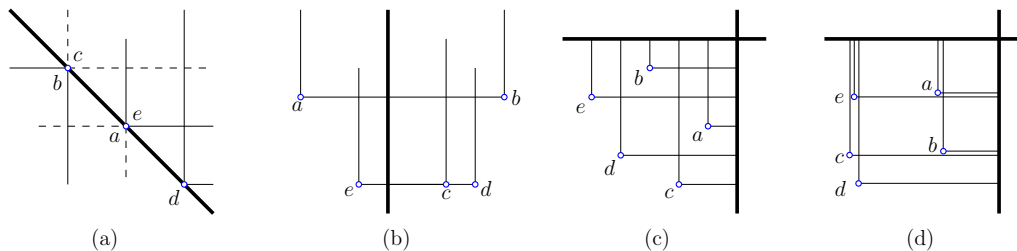

■ **Figure 1** A graph on five vertices $\{a, b, c, d, e\}$ with four different representations (a) diagonal-anchoring, (b) Y-crossing, (c) XY-crossing, and (d) XY-crossing in the edge intersection model. The label of each L -frame indicates the position of its corner.

objects for which DS has been well studied. The motivation to study the problem on such graphs is mainly to exploit the geometry of such graphs to achieve improved approximation algorithms [13, 12]. However, even for the intersection graphs of simple and widely used geometric objects such as axis-aligned rectangles, the DS problem is APX-hard [12] and no constant factor approximation is known. In fact, surprisingly, the problem remains NP-hard even when all the rectangles are “anchored” at a line with slope -1 [22]. It is easy to see that for the intersection graphs of anchored rectangles, the problem reduces to one with even simpler objects: L -frames. With this motivation, in this paper we study the DS problem on the intersection graphs of L -frames, which we define formally in the following.

An L -frame is the union of a vertical and a horizontal line segment that share an endpoint, which is called the *corner* of the L -frame. Thus, each such L -frame can have one of the following shapes: \lrcorner , \llcorner , \ulcorner , \lrcorner . Then, a graph $G = (V, E)$ is the *intersection graph of L -frames* if we can represent each vertex of the graph by an L -frame such that two L -frames have non-empty intersection iff the corresponding vertices are adjacent in G . We study the DS problem specifically on the following three restricted graph classes: 1. *Diagonal-anchoring graphs*, the intersection graphs of L -frames of type \ulcorner and \lrcorner whose corners lie on a diagonal line (a straight line with negative slope); 2. *Y-crossing graphs*, the intersection graphs of L -frames of type \ulcorner and \lrcorner whose horizontal segments intersect a vertical line; and 3. *XY-crossing graphs*, the intersection graphs of L -frames of type \ulcorner that intersect two axis-parallel lines that are perpendicular to each other. Figure 1(a–c) shows an example for each of these classes. See Section 2 for a formal definition of these graphs.

In addition to the standard intersection model, we also consider the DS problem on a slightly different intersection model called the “edge intersection” model. While the standard notion of intersection dates back to 1970s, Golumbic et al. [14] introduced the notion of *edge intersection of L -frames* recently. In this model, two L -frames are considered adjacent if they overlap in strictly more than a single point in the plane. More formally, the L -frames corresponding to the vertices of the graph are drawn on a grid and two vertices are adjacent in the graph iff their corresponding L -frames share at least one grid edge; see Figure 1(d) for an example. To distinguish between the two models we will explicitly refer the edge intersection model whenever discussing a result on this model. Otherwise, we always mean the standard intersection model.

Our results. For diagonal-anchoring graphs, we prove the following theorem.

► **Theorem 1.** *For any $\epsilon > 0$, there is a polynomial-time $(2 + \epsilon)$ -approximation algorithm for DS on diagonal-anchoring graphs. Moreover, the problem admits a PTAS when the L -frames*

are anchored at the diagonal from one side (i.e., exclusively from above or below).

To the best of our knowledge, this is the first PTAS for DS on a non-trivial subclass of the intersection graphs of L -frames. The PTAS is based on the *local search* technique. The novelty in our approach lies in designing a planar graph drawing scheme that is needed for the analysis of the local search algorithm. For diagonal-anchoring case, the classes of intersection graphs of rectangles, right-angled triangles, and L -frames are equivalent. Thus, as a byproduct of Theorem 1, we have the following.

► **Corollary 2.** *There exists a PTAS and a polynomial-time $(2 + \epsilon)$ -approximation algorithm for the DS problem on the intersection graphs of rectangles (resp., right-angled triangles) when they are anchored at the diagonal from, respectively, one side and both sides.*

For Y -crossing graphs, we obtain the following two theorems, that rule out the existence of PTASes both in the standard and the edge intersection models, unless $P = NP$.

► **Theorem 3.** *The DS problem is APX-hard on Y -crossing graphs, even if every L -frame intersects the vertical line from one side. Moreover, the problem is NP-hard even if for each L -frame, the lengths of the horizontal and vertical segments are equal.*

► **Theorem 4.** *The DS problem on Y -crossing graphs (in the edge intersection model) is hard to approximate within a factor of 1.1377, even if every L -frame intersects the vertical line from one side.*

We note here that the inapproximability result of Theorem 4 should be compared with the relatively weaker APX-hardness result in [20] which consists of L -frames of more than one type. For XY -crossing graphs, we show that there is a linear time algorithm for the problem by establishing a connection to the permutation graphs. In contrast to having this linear-time algorithm in the standard intersection model, we prove that the problem is NP-hard in the edge intersection model.

Related work. The primary work on the intersection graphs of L -frames has been devoted to the recognition of such graphs [11, 4, 15]. However, recently the focus has been shifted to the design of improved approximation algorithms for classical optimization problems [19, 20, 7, 4]. As for the DS problem, Mehrabi [20] has recently obtained a constant factor approximation in the plane. Asinowski et al. [1] proved that every circle graph can be represented as an intersection graph of L -frames. Since DS is APX-hard on circle graphs [8], the problem is also APX-hard on the intersection graphs of L -frames. Recently, Pandit [22] proved that DS is NP-hard even for the diagonal-anchoring graphs. However, the approximability of this version of DS was not considered before. Also, to the best of our knowledge, DS was not studied before on the other two classes. However, an $O(n^6)$ time algorithm follows for the XY -crossing case due to the facts, that the XY -crossing graphs form a subclass of the co-comparability graphs [19], and DS can be solved on co-comparability graphs in $O(n^6)$ -time [18].

In the edge intersection model, there is a 4-approximation algorithm for DS on the intersection graphs of L -frames [3, 16]. Further, the problem was recently shown to be APX-hard by Mehrabi [20] who also gave improved 2- and 3-approximations for the XY -crossing and one-sided Y -crossing (all L -frames lie on only one side of the vertical line) graphs, respectively. However, the exact complexity of DS for these restricted cases were not known before [20]. We note that, for the classes of graphs studied in this paper, other optimization problems including hitting set and independent set have already been studied; see e.g. [4, 7, 19].

Organization. We first have some definitions in Section 2. In Section 3, 4, and 5, we describe the results for diagonal-anchoring, Y -crossing, and XY -crossing graphs, respectively.

2 Definitions and Notations

We denote the x - and y -coordinates of a point p by $x(p)$ and $y(p)$, respectively. For two points p and q , we denote the Euclidean distance between p and q by $\text{dist}(p, q)$. For any L -frame l , we denote the corner of l by $\text{cor}(l)$. Throughout this paper, we denote a diagonal line with slope -1 by D , the vertical line $x = 0$ by ℓ_V and the horizontal line $y = 0$ by ℓ_H .

► **Definition 5** (Diagonal-anchoring Graph). Let \mathcal{P} be a set of n L -frames in the plane. A graph $G = (V, E)$ is said to be a *diagonal-anchoring graph*, if there exists a bijective mapping $\pi : V \rightarrow \mathcal{P}$ such that (i) $\pi(u) \cap D = \text{cor}(\pi(u))$, for all $u \in V$ (i.e., $\pi(u)$ is *anchored* at D), and (ii) $(u, v) \in E$ iff $\pi(u)$ and $\pi(v)$ “intersect” each other.

► **Definition 6** (Y -crossing Graph). Let \mathcal{P} be a set of n L -frames in the plane. A graph $G = (V, E)$ is said to be a *Y -crossing graph*, if there exists a bijective mapping $\pi : V \rightarrow \mathcal{P}$ such that (i) the horizontal segment of $\pi(u)$ intersects ℓ_V , for all $u \in V$, and (ii) $(u, v) \in E$ iff $\pi(u)$ and $\pi(v)$ “intersect” each other.

► **Definition 7** (XY -crossing Graph). Let \mathcal{P} be a set of n L -frames. A graph $G = (V, E)$ is said to be a *XY -crossing graph*, if there exists a drawing of the L -frames in \mathcal{P} on a grid in the plane and a bijective mapping $\pi : V \rightarrow \mathcal{P}$ such that (i) $x(\text{cor}(\pi(u))) < 0$, $y(\text{cor}(\pi(u))) < 0$ and $\pi(u)$ intersects both lines ℓ_V and ℓ_H , for all $u \in V$, and (ii) $(u, v) \in E$ iff $\pi(u)$ and $\pi(v)$ “intersect” each other.

We denote the L -frame corresponding to a vertex $u \in V(G)$ by $L(u)$. Throughout the paper, we use u and $L(u)$ interchangeably.

Local search. Consider an optimization problem in which the objective is to compute a feasible subset S' of a ground set S whose cardinality is minimum over all such feasible subsets of S . Moreover, it is assumed that computing some initial feasible solution and determining whether a subset $S' \subseteq S$ is a feasible solution can be done in polynomial time. The local search algorithm for a minimization problem is as follows. Fix some parameter k , and let A be some initial feasible solution for the problem. In each iteration, if there are $A' \subseteq A$ and $M \subseteq S \setminus A$ such that $|A'| \leq k$, $|M| < |A'|$ and $(A \setminus A') \cup M$ is a feasible solution, then set $A := (A \setminus A') \cup M$ and re-iterate. The algorithm returns A and terminates when no such local improvement is possible.

Clearly, the local search algorithm runs in polynomial time. Let \mathcal{B} and \mathcal{R} be the solution returned by the algorithm and an optimal solution, respectively. We can assume that $\mathcal{B} \cap \mathcal{R} = \emptyset$; otherwise, we can remove the common elements of \mathcal{B} and \mathcal{R} and analyze the algorithm with the new sets, which guarantees that the approximation factor of the original instance is upper bounded by that of the new sets. The following result establishes the connection between local search technique and obtaining a PTAS.

► **Theorem 8** ([5, 21]). *Consider the solutions \mathcal{B} and \mathcal{R} for a minimization problem, and suppose that there exists a planar bipartite graph $H = (\mathcal{B} \cup \mathcal{R}, E)$ that satisfies the local exchange property, which is as follows: for any subset $\mathcal{B}' \subseteq \mathcal{B}$, $(\mathcal{B} \setminus \mathcal{B}') \cup N_H(\mathcal{B}')$ is a feasible solution, where $N_H(\mathcal{B}')$ denotes the set of neighbours of \mathcal{B}' in H . Then, the local search algorithm yields a PTAS for the problem.*

3 Diagonal-anchoring Graphs

In this section, we prove Theorem 1. First, we discuss the PTAS in Section 3.1 and then the $(2 + \epsilon)$ -approximation algorithm in Section 3.2.

3.1 One-sided Diagonal-anchoring Case

We are given a set of L -frames each of which is anchored at the diagonal from above. Let $G = (V, E)$ be the corresponding diagonal-anchoring graph. Consider any two L -frames L_1 and L_2 that intersect each other. We say that L_1 and L_2 are *coincident* if $x(\text{cor}(L_1)) = x(\text{cor}(L_2))$. L_1 is said to intersect L_2 from left (resp. from below) if $x(\text{cor}(L_1)) \leq x(\text{cor}(L_2))$ (resp. $x(\text{cor}(L_1)) \geq x(\text{cor}(L_2))$). Notice that L_1 intersects L_2 from left iff L_2 intersects L_1 from below.

Consider the DS problem on G and run the local search algorithm with $k := c/\epsilon$ for some constant c . Let \mathcal{B} be the solution returned by the local search algorithm and \mathcal{R} denote an optimal solution. Consider the bipartite graph $H = (\mathcal{B} \cup \mathcal{R}, E')$ in which the edge set E' is defined as follows. For any vertex $u \in V$, consider the set of all L -frames in $\{\mathcal{B} \cup \mathcal{R}\}$ that intersect $L(u)$ and let (b_i, r_j) , where $b_i \in \mathcal{B}$ and $r_j \in \mathcal{R}$, be a pair for which $\text{dist}(\text{cor}(b_i), \text{cor}(r_j))$ is minimum over all such pairs. Then $(b_i, r_j) \in E'$. We call u a *witness* vertex for the pair (b_i, r_j) .

In the following, we show that H is planar (Lemma 9–13) and will then prove that H satisfies the local exchange property (Lemma 14). Then, by Theorem 8, our local search algorithm yields a PTAS. To distinguish between the edges of G and those of H , we refer to the edges of H as *arcs*. Let $b_i \in \mathcal{B}$ and $r_j \in \mathcal{R}$ such that $(b_i, r_j) \in E'$. We say that (b_i, r_j) is a *top arc* if there is a witness u for (b_i, r_j) , such that *both* $L(b_i)$ and $L(r_j)$ intersect $L(u)$ from left; choose one such u arbitrarily and denote $L(u)$ by $\mathbf{w}(b_i, r_j)$. Otherwise, if there is a witness v for (b_i, r_j) , such that *both* $L(b_i)$ and $L(r_j)$ intersect $L(v)$ from below, (b_i, r_j) is a *down arc*; choose one such v arbitrarily and denote $L(v)$ by $\mathbf{w}(b_i, r_j)$. Otherwise, for any witness w of (b_i, r_j) , $L(b_i)$ and $L(r_j)$ intersect w from different sides, and we call (b_i, r_j) a *mixed arc*; choose one such w arbitrarily and denote $L(w)$ by $\mathbf{w}(b_i, r_j)$.

Drawing of H . To draw H , we map u to $\text{cor}(u)$ on the diagonal D for all $u \in \mathcal{B} \cup \mathcal{R}$. To draw the arcs of H , the idea is to draw each arc either above or below the diagonal depending on whether it is a top arc or a down arc, respectively. A mixed arc is drawn in such a way that some part of the arc is drawn above and some part is drawn below the diagonal (and, hence crosses the diagonal). We next give the details of each case.

Let $b_i \in \mathcal{B}$ and $r_j \in \mathcal{R}$ such that $(b_i, r_j) \in E'$ and assume w.l.o.g. that $x(\text{cor}(b_i)) < x(\text{cor}(r_j))$. Moreover, let

$$O := \left(\frac{x(\text{cor}(b_i)) + x(\text{cor}(r_j))}{2}, \frac{y(\text{cor}(b_i)) + y(\text{cor}(r_j))}{2} \right),$$

and consider the circle C centred at O with radius $\text{dist}(\text{cor}(b_i), \text{cor}(r_j))/2$. If the arc (b_i, r_j) is a top arc (resp., down arc), then we draw it on the half circle of C that lies above (resp., below) the diagonal D starting from $\text{cor}(b_i)$ and ending at $\text{cor}(r_j)$; see Figure 2(a)—(b) for an illustration. A mixed arc is drawn in a slightly different way. For a mixed arc (b_i, r_j) , assume w.l.o.g. that $L(b_i)$ intersects $\mathbf{w}(b_i, r_j)$ from left while $L(r_j)$ intersects $\mathbf{w}(b_i, r_j)$ from below. Notice that $x(\text{cor}(b_i)) < x(\text{cor}(\mathbf{w}(b_i, r_j))) < x(\text{cor}(r_j))$. To draw (b_i, r_j) , let

$$O_1 := \left(\frac{x(\text{cor}(b_i)) + x(\text{cor}(\mathbf{w}(b_i, r_j)))}{2}, \frac{y(\text{cor}(b_i)) + y(\text{cor}(\mathbf{w}(b_i, r_j)))}{2} \right),$$

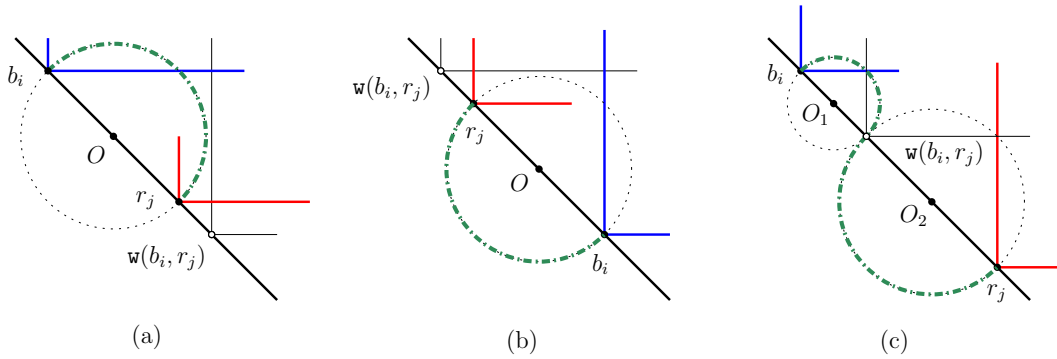

■ **Figure 2** Drawing of (a) a top arc, (b) a down arc, and (c) a mixed arc.

$$O_2 := \left(\frac{x(\text{cor}(w(b_i, r_j))) + x(\text{cor}(r_j))}{2}, \frac{y(\text{cor}(w(b_i, r_j))) + y(\text{cor}(r_j))}{2} \right),$$

and consider the following two circles: the circle C_1 that is centred at O_1 and has the radius $\text{dist}(\text{cor}(b_i), \text{cor}(w(b_i, r_j)))/2$, and the circle C_2 that is centred at O_2 with radius $\text{dist}(\text{cor}(w(b_i, r_j)), \text{cor}(r_j))/2$. See Figure 2(c). We draw the first part of arc (b_i, r_j) on the half circle of C_1 that lies above the diagonal starting from $\text{cor}(b_i)$ and ending at $\text{cor}(w(b_i, r_j))$ and then the second part on the half circle of C_2 that lies below the diagonal starting from $\text{cor}(w(b_i, r_j))$ and ending at $\text{cor}(r_j)$. See Figure 3 for an exemplary drawing of a graph H .

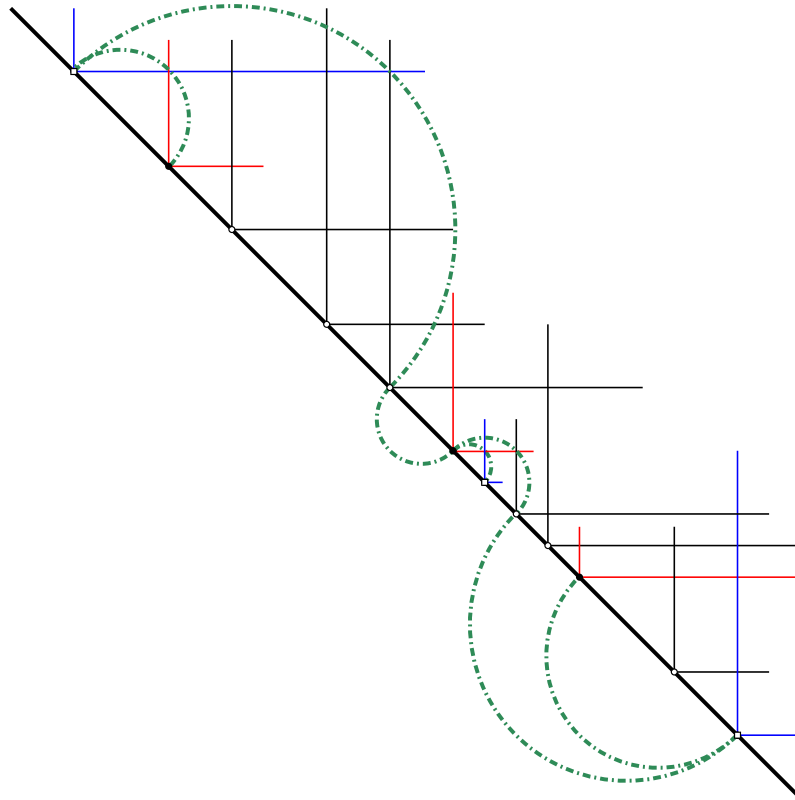

■ **Figure 3** An exemplary drawing of graph H . The corner of the L -frames that are in \mathcal{R} (resp. \mathcal{B}) are marked by black circles (resp. white squares).

Planarity of H . Clearly, no top arc crosses a down arc (except perhaps at their endpoints). To show the planarity of H , we show that — no top arc crosses another top arc, no down arc crosses another down arc, and no mixed arc crosses a top, a down or another mixed arc.

► **Lemma 9.** *No two top arcs in H cross each other.*

Proof. Suppose for a contradiction that two top arcs $(a, b), (c, d) \in E'$ cross each other, and w.l.o.g. assume that $x(a) < x(c) < x(b) < x(d)$. Since (a, b) is a top arc, we must have $x(\text{cor}(\mathfrak{w}(a, b))) \geq x(b)$; for a similar reason, we must have $x(\text{cor}(\mathfrak{w}(c, d))) \geq x(d)$. We now consider two cases. (i) If $x(\text{cor}(\mathfrak{w}(a, b))) \leq x(\text{cor}(\mathfrak{w}(c, d)))$, then $L(c)$ must intersect $\mathfrak{w}(a, b)$, which is a contradiction because in that case we should have added (a, c) or (c, b) to E' corresponding to $\mathfrak{w}(a, b)$ instead of (a, b) . (ii) If $x(\text{cor}(\mathfrak{w}(a, b))) > x(\text{cor}(\mathfrak{w}(c, d)))$, then $L(b)$ must intersect $\mathfrak{w}(c, d)$ — this is also a contradiction because in that case we should have added (c, b) or (b, d) to E' corresponding to $\mathfrak{w}(c, d)$ instead of (c, d) . ◀

► **Lemma 10.** *No two down arcs in H cross each other.*

Proof. Suppose for a contradiction that two down arcs $(a, b), (c, d) \in E'$ cross each other, and w.l.o.g. assume that $x(a) < x(c) < x(b) < x(d)$. Since (a, b) is a down arc, we must have $x(\mathfrak{w}(a, b)) \leq x(a)$; for a similar reason, we must have $x(\mathfrak{w}(c, d)) \leq x(c)$. We now consider two cases. (i) If $x(\mathfrak{w}(a, b)) \geq x(\mathfrak{w}(c, d))$, then $L(c)$ must intersect $\mathfrak{w}(a, b)$, which is a contradiction because in that case we should have added either (a, c) or (c, b) to E' corresponding to the witness $\mathfrak{w}(a, b)$ instead of the arc (a, b) . (ii) If $x(\mathfrak{w}(a, b)) < x(\mathfrak{w}(c, d))$, then $L(b)$ must intersect $\mathfrak{w}(c, d)$ — this is a contradiction because in that case we should have added either (c, b) or (b, d) to E' corresponding to the witness $\mathfrak{w}(c, d)$, instead of the arc (c, d) . ◀

It remains to show that no mixed arc crosses a top arc, a down arc or another mixed arc.

► **Lemma 11.** *No mixed arc crosses a top arc in H .*

Proof. Suppose for a contradiction that a mixed arc (a, b) crosses a top arc (c, d) and assume w.l.o.g. that $x(a) < x(b)$ and $x(c) < x(d)$. If $x(c) < x(a)$, then we must have $x(a) < x(d) < x(\text{cor}(\mathfrak{w}(a, b)))$ — otherwise, the two arcs would not cross. First, we know that $x(\text{cor}(\mathfrak{w}(c, d))) \geq x(d)$. If $x(\text{cor}(\mathfrak{w}(c, d))) < x(\text{cor}(\mathfrak{w}(a, b)))$, then $L(a)$ intersects $\mathfrak{w}(c, d)$ before intersecting $\mathfrak{w}(a, b)$, which is a contradiction because in that case we should have added either the top arc (c, a) or the top arc (a, d) to E' corresponding to $\mathfrak{w}(c, d)$ instead of (c, d) ; see Figure 4(a). If $x(\text{cor}(\mathfrak{w}(c, d))) > x(\text{cor}(\mathfrak{w}(a, b)))$, then $L(d)$ intersects $\mathfrak{w}(a, b)$ before intersecting $\mathfrak{w}(c, d)$, which is again a contradiction as we should have added either the top arc (a, d) or the mixed arc (d, b) to E' corresponding to $\mathfrak{w}(a, b)$ instead of (a, b) . See Figure 4(b).

Now, suppose that $x(c) > x(a)$. Then, we must have $x(a) < x(c) < x(\text{cor}(\mathfrak{w}(a, b))) < x(d)$ as the two arcs would not intersect otherwise. Since (c, d) is a top arc, we must have $x(\text{cor}(\mathfrak{w}(c, d))) \geq x(d)$ and so $L(c)$ would intersect $\mathfrak{w}(a, b)$ before intersecting $\mathfrak{w}(c, d)$; see Figure 4(c). This is a contradiction because we should have added either the top arc (a, c) or the mixed arc (c, b) to E' corresponding to $\mathfrak{w}(a, b)$ instead of (a, b) . ◀

► **Lemma 12.** *No mixed arc crosses a down arc in H .*

Proof. Suppose for a contradiction that a mixed arc (a, b) crosses a down arc (c, d) and assume w.l.o.g. that $x(\text{cor}(a)) < x(\text{cor}(b))$ and $x(\text{cor}(c)) < x(\text{cor}(d))$. First, suppose that $x(\text{cor}(d)) > x(\text{cor}(b))$. Then, we must have $x(\text{cor}(\mathfrak{w}(a, b))) < x(\text{cor}(c)) < x(\text{cor}(b))$ — otherwise, the two arcs would not cross. Since (c, d) is a down arc, we know that $x(\text{cor}(\mathfrak{w}(c, d))) \leq x(\text{cor}(c))$. If $x(\text{cor}(\mathfrak{w}(c, d))) < x(\text{cor}(\mathfrak{w}(a, b)))$, then $L(c)$ must intersect $\mathfrak{w}(a, b)$, which is a contradiction because we should have added either (a, c) or (c, b)

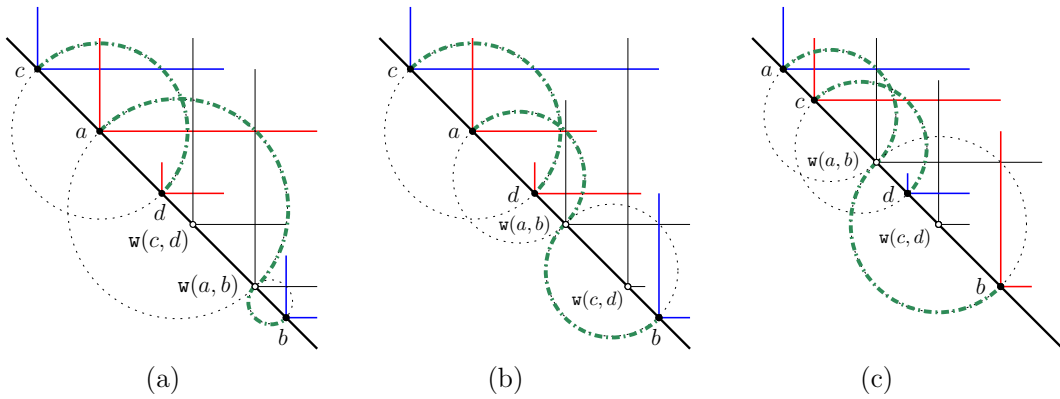

■ **Figure 4** An illustration in supporting the proof of Lemma 11.

to E' corresponding to the witness $w(a,b)$, instead of the arc (a,b) ; see Figure 5(a). If $x(\text{cor}(w(c,d))) > x(\text{cor}(w(a,b)))$, then $L(b)$ must intersect $w(c,d)$, which is a contradiction as in that case we should have added (c,b) or (b,d) to E' corresponding to the witness $w(c,d)$, instead of the arc (c,d) ; see Figure 5(b).

Now, suppose that $x(\text{cor}(d)) < x(\text{cor}(b))$. Then, we must have that $x(\text{cor}(c)) < x(\text{cor}(w(a,b))) < x(\text{cor}(d))$ as otherwise the two arcs would not cross; see Figure 5(c). Since (c,d) is a down arc, we must have $x(\text{cor}(w(c,d))) \leq x(\text{cor}(c))$ and so $L(d)$ must intersect $w(a,b)$ — this is a contradiction because in that case we should have added (a,d) or (d,b) to E' corresponding to the witness $w(a,b)$, instead of the arc (a,b) . ◀

► **Lemma 13.** *No two mixed arcs cross each other in H .*

Proof. Let (a,b) and (c,d) be two mixed arcs in H . First, (a,b) and (c,d) do not cross each other on the diagonal D because crossing on the diagonal means that $w(a,b)$ and $w(c,d)$ are coincident and so we should have had only one arc among $\{a,b,c,d\}$ in H for both $w(a,b)$ and $w(c,d)$. As such, we assume in the following that $w(a,b)$ and $w(c,d)$ are not coincident.

If (a,b) and (c,d) cross each other, then they can have at most two crossings, and in case of two, one is above and the other is below the diagonal. We show that no such types of crossings are possible. First, suppose that (a,b) and (c,d) cross each other above the diagonal, and assume w.l.o.g. that $x(a) < x(c) < x(w(a,b)) < x(w(c,d))$. See Figure 6(a). Then, it is easy to see that $L(c)$ would intersect $w(a,b)$ before intersecting $w(c,d)$ and so we should have added either the top arc (a,c) or the mixed arc (c,b) to E' corresponding

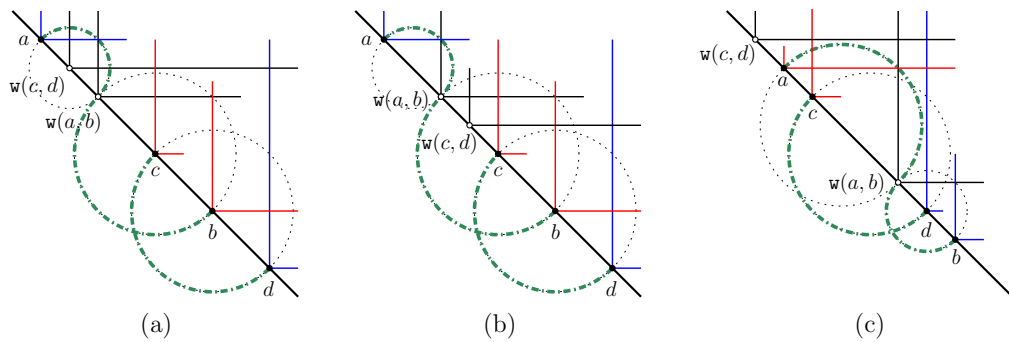

■ **Figure 5** An illustration in supporting the proof of Lemma 12.

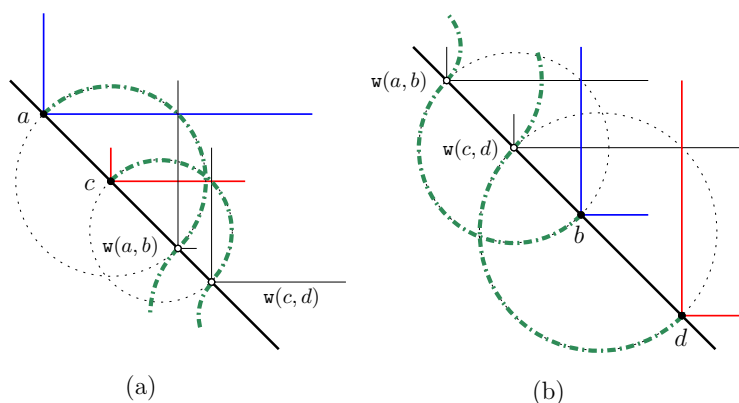

■ **Figure 6** An illustration in support of the proof of Lemma 13.

to $w(a, b)$ instead of (a, b) (see Figure 6(a)). Now, suppose that (a, b) and (c, d) cross each other below the diagonal and assume w.l.o.g. that $x(w(a, b)) < x(w(c, d)) < x(b) < x(d)$. See Figure 6(b). Then $L(b)$ must intersect $w(c, d)$ before intersecting $w(a, b)$ and so we should have added either the down arc (b, d) or the mixed arc (c, b) to E' corresponding to the witness $w(c, d)$ instead of the arc (c, d) (see Figure 6(b)). This concludes the proof. ◀

By Lemma 9–13, it follows that H is a planar graph. The following lemma along with the planarity of H completes the proof.

► **Lemma 14.** *Graph $H = (\mathcal{B} \cup \mathcal{R}, E)$ satisfies the local exchange property.*

Proof. To prove the lemma, it is sufficient to show that for any vertex $u \in V$, there are $b_i \in \mathcal{B}$ and $r_j \in \mathcal{R}$ such that both $L(b_i)$ and $L(r_j)$ intersect $L(u)$ and $(b_i, r_j) \in E'$. Take any vertex $u \in V$ and let $S \subseteq \mathcal{B} \cup \mathcal{R}$ be the set of all L -frames that intersect $L(u)$. Notice that $S \cap \mathcal{B} \neq \emptyset$ and $S \cap \mathcal{R} \neq \emptyset$ because each of \mathcal{B} and \mathcal{R} is a feasible solution to the DS problem on G . Now, consider $b \in S \cap \mathcal{B}$ and $r \in S \cap \mathcal{R}$ for which $\text{dist}(\text{cor}(b), \text{cor}(r))$ is minimum over all such pairs (b, r) . We know by definition of H that $(b, r) \in E'$, which proves the lemma. ◀

3.2 Diagonal-anchoring Case

Given a diagonal-anchoring graph $G = (V, E)$, let $\{X, Y\}$ be a partition of the vertices of G such that the L -frames corresponding to vertices in X (resp. Y) are anchored at D from above (resp. below). By abusing notations, we refer to these two sets of L -frames also as X and Y . For any $\epsilon > 0$, set $\epsilon' := \epsilon/2$. We apply the local search algorithm for the one-sided case with parameter c/ϵ' to the L -frames in X and Y independently, and let S_X and S_Y be the solutions returned by the algorithm, respectively. We return $S := S_X \cup S_Y$ as the final solution. Let OPT , OPT_X and OPT_Y denote an optimal solution for the DS problem on the L -frames in $X \cup Y$ (i.e., graph G), X and Y , respectively.

Consider the solution OPT . Let $S \subseteq \text{OPT}$ be a minimum size set of L -frames that dominates all the L -frames in X . If there is an L -frame $P \in S$ that is in Y , then P can only dominate those L -frames in X that are anchored at the diagonal at the same point as P , in which case we can replace P by one of those L -frames from X . As such, there exists a set $S' \subseteq X$ of size at most $|S| \leq |\text{OPT}|$ that dominates the L -frames of X . It follows that $|\text{OPT}_X| \leq |\text{OPT}|$. Similarly, one can show that $|\text{OPT}_Y| \leq |\text{OPT}|$. Now, by using the result from Section 3.1, we

have $|S_X| \leq (1 + \epsilon')|\text{OPT}_X|$ and $|S_Y| \leq (1 + \epsilon')|\text{OPT}_Y|$. It follows that,

$$|S| \leq |S_X| + |S_Y| \leq (1 + \epsilon')|\text{OPT}_X| + (1 + \epsilon')|\text{OPT}_Y| \leq 2(1 + \epsilon')|\text{OPT}| = (2 + \epsilon)|\text{OPT}|.$$

4 **Y-crossing Graphs**

In this section, we prove Theorems 3 and 4. We begin by proving Theorem 3.

APX-hardness for one-sided Y-crossing graphs. We prove that the problem is APX-hard on Y-crossing graphs, even if all the L -frames intersect ℓ_V from the left. To this end, we show a gap-preserving reduction from the DS problem on *circle graphs*, which is known to be APX-hard [8]. Recall that a graph is called a circle graph, if it is the intersection graph of chords of a circle. Take any circle graph $G = (V, E)$ with n vertices, and consider a geometric representation of G . By a closer look at the APX-hardness proof [8], we can assume that no two chords share an endpoint; that is, there are exactly $2n$ distinct points on the circle determining the endpoints of the chords. Cut the circle at an arbitrary point p and consider the ordering $M := \langle p_1, p_2, \dots, p_{2n} \rangle$ of the endpoints of chords visited in counter-clockwise along the circle starting at p . Now, let C be a circle with radius one that is centred at the origin $(0, 0)$ of the Cartesian coordinate system. Consider each endpoint p_i (where $1 \leq i \leq 2n$) in the order given by M , and let $x_i := i/(2n + 1)$. Then, we map p_i to the point $(x_i, \sqrt{1 - x_i^2})$ on the top right quadrant of circle C . Let $e := (p_j, p_k)$ be a chord of G . Then, the L -frame corresponding to e is the unique L -frame that lies inside C and connects the two points mapped on C corresponding to p_j and p_k ; see Figure 7(b) for an illustration. Finally, we complete the construction by extending the horizontal segment of every L -frame to the right until it intersects the vertical line $x = 1$. See Figure 7(c). Clearly, we can shift the entire arrangement of the L -frames one unit to the left to ensure that the vertical line ℓ_V is the y -axis. Let $G' = (V', E')$ be the Y-crossing graph corresponding to the constructed L -frames. Clearly, the construction can be done in polynomial time. Moreover, since the $2n$ endpoints of chords of the input representation are pairwise distinct, the points mapped to the circle C are in general position; that is, no two such points have the same x - or the same y -coordinates. The first part of Theorem 3 follows by the next lemma.

► **Lemma 15.** *G has a dominating set of size k iff G' has a dominating set of size k .*

Proof. First, we show that there is a one-to-one correspondence between the vertices of G and those of G' such that $(i, j) \in E$ iff $(i, j) \in E'$. The one-to-one correspondence between the vertices of these two graphs is clear from the construction. Now, suppose that $(i, j) \in E$. This means that the endpoints of vertices i and j appear in M as either $\langle p_i, p_j, p_{i'}, p_{j'} \rangle$ or $\langle p_j, p_i, p_{j'}, p_{i'} \rangle$, where p_i and $p_{i'}$ with $i < i'$ (resp., p_j and $p_{j'}$ with $j < j'$) correspond to the endpoints of i (resp., j). By the mapping used in the construction, this ordering is preserved on the circle C (when going from $(1, 0)$ to $(0, 1)$ along C) and so the L -frames $L(i)$ and $L(j)$ intersect each other inside C ; that is, $(i, j) \in E'$. Conversely, if $(i, j) \notin E$, then their endpoints appear in M as either $\langle p_i, p_j, p_{j'}, p_{i'} \rangle$ or $\langle p_j, p_i, p_{i'}, p_{j'} \rangle$, where p_i and $p_{i'}$ with $i < i'$ (resp., p_j and $p_{j'}$ with $j < j'$) correspond to the endpoints of i (resp., j). Consequently, this ordering is preserved on C by the mapping (when going from $(1, 0)$ to $(0, 1)$ along C) and so $L(i)$ and $L(j)$ do not intersect each other inside C ; that is, $(i, j) \notin E'$.

Moreover, extending the horizontal segments of L -frames in G' until they intersect the vertical line ℓ_V , does not introduce any new crossing between the L -frames because the horizontal segments have pairwise distinct y -coordinates. It is now straightforward to see

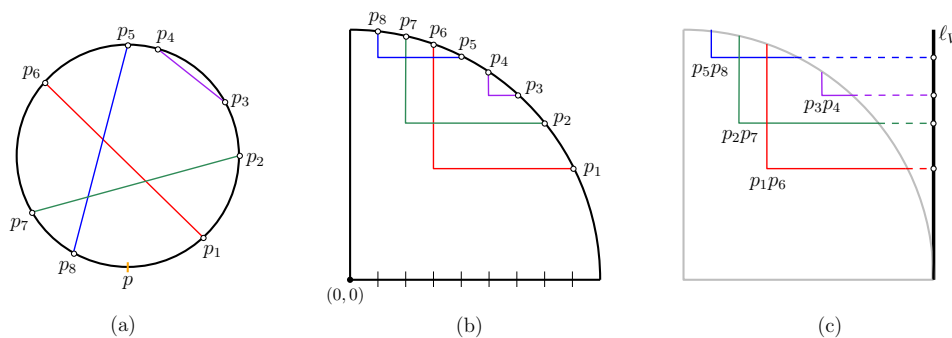

■ **Figure 7** An illustration supporting the proof of Theorem 3.

that G has a dominating set of size k iff G' has a dominating set of size k , which is clearly a gap-preserving reduction. ◀

NP-hardness for symmetric Y-crossing graphs. We show that the DS problem is NP-hard on Y-crossing graphs even if the lengths of the vertical and the horizontal segments of each L -frame are the same. The reduction is from a variant of 3SAT. For any 3SAT instance, one can define a bipartite graph on the clauses and the variables which we refer to as the incidence graph. For any clause c_j , if c_j contains a literal corresponding to a variable v_i , the edge (v_i, c_j) is added to the graph. A drawing of a planar incidence graph is called *planar rectilinear* if it has the following properties. Each variable vertex is drawn as a horizontal segment on the x -axis and the clause vertices are drawn as horizontal segments above and below the x -axis. Also for each edge (v_i, c_j) , the horizontal segment corresponding to c_j has a vertical connection to the horizontal segment corresponding to v_i . Moreover, this vertical connection does not intersect any other horizontal segments. See Figure 8 for an example. A planar rectilinear drawing of an incidence graph is called *monotone* if all the positive (resp. negative) clauses are drawn above (resp. below) the x -axis. In the Planar Monotone Rectilinear 3SAT problem the incidence graph of any instance has a planar rectilinear and monotone drawing. The problem is known to be NP-hard even when the drawing is given [9]. We reduce this problem to the DS problem on Y-crossing graphs. The construction is as follows.

Let n be the number of variables. Due to the hierarchical structure of the clauses lying above and below the x -axis, respectively in the given drawing, one can modify the drawing in a way such that for each clause, the length of the horizontal segment corresponding to it is the same as the length of the vertical segments corresponding to it. Let T be the new drawing. We construct the instance I of DS from T in the following way. For each clause c_j , removing all the vertical connections except the leftmost one creates an L -frame. We add this L -frame (L_j) to our instance. For each variable x_i , we add two L -frames: one (L_{i1}) above and the other (L_{i2}) below the x -axis. The vertical segments of the two L -frames are the maximum length vertical connections corresponding to it lying above and below x -axis, respectively. For the variable L -frames, their horizontal segments lie on the right of their vertical segment. Also for any variable L -frame above (resp. below) the x -axis, the corner is the topmost (resp. bottommost) point of the vertical segment. The two L -frames corresponding to each variable are shifted accordingly so that they intersect at a point on the x -axis (see Figure 8). Also for each variable x_i , we add an auxiliary L -frame L_i^a that intersects only the two L -frames corresponding to it as shown in Figure 8. Lastly, we rotate

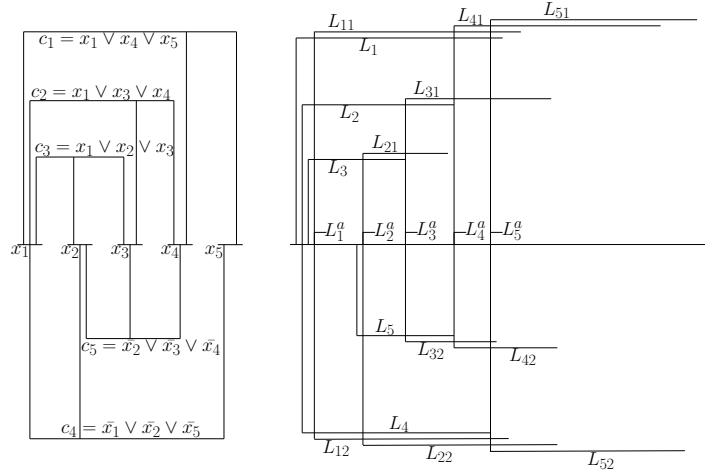

■ **Figure 8** The left figure shows a drawing of an instance of Planar Monotone Rectilinear 3SAT. The right figure shows the corresponding instance of DS (before rotation).

the created instance clockwise by 90° . Now, we have the following observation.

► **Observation 4.1.** For all i, j , L_{i1} (resp. L_{i2}) intersects L_j iff the clause c_j contains the literal x_i (resp. \bar{x}_i).

The following lemma completes the proof of the second part of Theorem 3.

► **Lemma 16.** *The instance I has a dominating set of size n iff the 3SAT instance is satisfiable.*

Proof. Suppose I has a dominating set D of size n . We construct a satisfiable assignment in the following way. Consider any variable x_i . As L_i^a intersects only L_{i1} and L_{i2} , one of these three L -frames must be in the dominating set. The size of D being n , only one of the above mentioned three L -frames can be in D and no clause L -frame can be in D . If L_{i1} is in D , we set x_i to be true. Otherwise, we set x_i to be false. Now consider any clause c_j . Let x_i be a variable such that a L -frame corresponding to x_i is in D that intersects L_j . Note that there exists such an x_i . Now if L_{i1} is the chosen L -frame that dominates L_j , then L_{i1} is in D and by Observation 4.1 c_j must be a positive clause. It follows that, we have set x_i to be true and thus c_j is satisfied. Similarly, one can show that if L_{i2} is the chosen L -frame that dominates L_j , then also c_j is satisfied.

Now suppose that we are given a satisfiable assignment of the 3SAT instance. We construct a dominating set in the following way. For any variable x_i , if x_i is set to be true, then we select L_{i1} . If x_i is set to be false, then we select L_{i2} . We claim that the selected L -frames form a dominating set. It is easy to see that the selected L -frames dominate the variable and auxiliary L -frames. Now consider any clause L -frame L_j . There must be a variable x_i that satisfies c_j . If c_j is positive, the literal x_i must be set to true and we select L_{i1} . By Observation 4.1 L_{i1} intersects L_j , and thus L_j is being dominated. If c_j is negative, one can similarly show that L_j is also being dominated. ◀

Inapproximability for Y-crossing graphs in the edge intersection model. We now prove Theorem 4. To this end, we reduce the Vertex Cover problem to DS on Y-crossing graphs. In Vertex Cover, we are given a graph $G = (V, E)$ with n vertices, and the goal is to find a

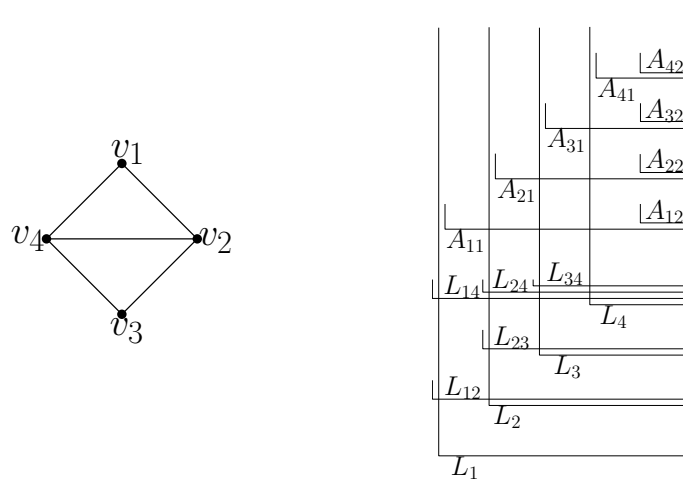

■ **Figure 9** The left figure shows an example graph with 4 vertices. The right figure shows the corresponding instance of DS.

subset $V' \subseteq V$ such that for any edge $(v_i, v_j) \in E$, $V' \cap \{v_i, v_j\} \neq \emptyset$. Let $VC(G)$ be the size of any minimum size vertex cover of G . As noted in [2], from the work of Dinur and Safra [10] the following theorem can be derived.

► **Theorem 17.** [10] Let $\frac{1}{3} < p < p_{max} = \frac{3-\sqrt{5}}{2}$ and $q = 4p^3 - 3p^4$. For any constant $\epsilon > 0$, given any unweighted graph $G = (V, E)$ with bounded degrees, it is NP-hard to distinguish between “Yes”: $VC(G) < (1 - p + \epsilon)|V|$, and “No”: $VC(G) > (1 - q - \epsilon)|V|$.

Given the vertex cover graph $G = (V, E)$, we construct an instance I of DS. In the instance I , all the L -frames lie on the left of the line $x = 0$ and intersect the line, and thus each has the \perp shape. The construction is as follows. For each vertex v_i , we have an L -frame L_i that intersects $x = 0$ at the point $(0, 2i)$ as shown in Figure 9. Note that these L -frames do not intersect each other. For each edge (v_i, v_j) with $i < j$, we have an L -frame L_{ij} that intersects $x = 0$ at $(0, 2j)$, and thus intersects (i.e., has a common horizontal grid edge) with v_j . It also intersects (has a common vertical grid edge) with v_i (see Figure 9). Also, for each vertex v_i , we have two auxiliary L -frames A_{i1} and A_{i2} that intersect $x = 0$ at $(0, 2n + i)$, and A_{i1} shares a vertical grid edge with L_i . Note that the only L -frame A_{i2} intersects is A_{i1} . Also, all the L -frames intersect the vertical line $x = 0$.

► **Lemma 18.** G has a vertex cover of size k iff I has a dominating set of size $k + n$.

Before proving Lemma 18, we first need the following observations.

► **Observation 4.2.** For $1 \leq i < j \leq n$, the only L -frames that L_{ij} intersects are L_i, L_j and L_{tj} , where $(v_t, v_j) \in E$ with $t < j$.

► **Observation 4.3.** The only L -frames that get dominated by the L -frames in $\{A_{i1} : 1 \leq i \leq n\}$ are L_i and A_{i2} for $1 \leq i \leq n$.

► **Observation 4.4.** Any dominating set contains at least one of A_{i1} and A_{i2} for each $1 \leq i \leq n$. Also for any dominating set of size k , there is a dominating set D of size at most k such that D contains A_{i1} for all $1 \leq i \leq n$ and does not contain any A_{i2} for $1 \leq i \leq n$.

Proof of Lemma 18. Suppose G has a vertex cover of size k . We construct a dominating set D of size $k + n$ in the following way. At first add all the L -frames $\{A_{i1} : 1 \leq i \leq n\}$ to D .

Then for each v_i in the vertex cover, add L_i to D . Clearly $|D| = k + n$. By Observation 4.3, D dominates any L_i and A_{i2} for $1 \leq i \leq n$. Now consider any L_{ij} . Note that we have added at least one of L_i and L_j to D , and hence D dominates L_{ij} as well.

Now suppose we have a dominating set D' of size $k + n$. By Observation 4.4, we can assume that D' contains A_{i1} for all i and does not contain any A_{i2} . Thus D' contains k L -frames corresponding to the vertices and the edges. Now suppose D' contains an edge L -frame L_{ij} . By Observation 4.2 and 4.3, the only L -frames that cannot get dominated by D' by the removal of L_{ij} from D' are L_{tj} , where $(v_t, v_j) \in E$ with $t < j$. Thus if we replace L_{ij} by L_j in D' , D' still remains a dominating set. Thus, we can assume w.l.o.g. that D' does not contain any L_{ij} . Now we construct a subset $V' \subseteq V$ by selecting vertices corresponding to the vertex L -frames contained in D' . Clearly $|V'| = k$. We claim that V' is a vertex cover. Consider any edge (v_i, v_j) . Then by Observation 4.3, at least one of L_i and L_j must be in D' . It follows that at least one of v_i and v_j is present in V' which finishes the proof. ◀

► **Lemma 19.** *Let $\frac{1}{3} < p < p_{max} = \frac{3-\sqrt{5}}{2}$ and $q = 4p^3 - 3p^4$. For any constant $\epsilon > 0$, given a Y -crossing graph (in the edge intersection model) H with $O(n)$ vertices, it is NP-hard to distinguish between:*

Yes: H has a dominating set of size $< (2 - p + \epsilon)n$.

No: The size of any dominating set of H is $> (2 - q - \epsilon)n$.

Thus the gap between the sizes of the minimum dominating set in the “yes” and the “no” cases approaches $\frac{2-4p^3+3p^4}{2-p} \approx 1.1377$ for $p = p_{max}$. Hence the proof of Theorem 4 follows.

5 XY-crossing Graphs

In this section, we consider XY-crossing graphs. We first show that every XY-crossing graph is a permutation graph, and thus DS is linear-time solvable on such a graph [6]. Geometrically, a graph G is a permutation graph if there are two embeddings of its vertices on two parallel lines such that, when connecting a vertex from the first line to the same vertex on the other line using a line segment, the edge set of the graph is realized exactly by the intersections of those segments. That is, two vertices appear in different order on the parallel lines (and, so their line segments intersect) whenever they are adjacent in the graph. By taking the two orderings in which the endpoints of the L -frames in a XY-crossing graph intersect the two lines ℓ_V and ℓ_H , respectively, we can construct the geometric representation of a permutation graph having the same edges. Hence, the claim follows.

NP-hardness for XY-crossing graphs in the edge intersection model. We show a reduction from the EDGE DOMINATING SET problem that is known to be NP-hard, even on planar bipartite graphs [17]. Recall that the objective of the EDGE DOMINATING SET problem on a graph is to choose a minimum-cardinality set S of edges of the graph such that every edge not in S shares at least one endpoint with one edge in S . Given a planar bipartite graph $G = (A \cup B, E)$, we construct a XY-crossing graph G' in polynomial time such that G has an edge dominating set of size k iff G' has a dominating set of size k (in the edge intersection model). To this end, let $A = \{a_1, \dots, a_r\}$ and $B = \{b_1, \dots, b_s\}$, and for each vertex $a_i \in A$ (resp., vertex $b_j \in B$), consider the point $(-i, 0)$ (resp., point $(0, -j)$) of the Cartesian coordinate system in the plane. Then, for each edge $(a_i, b_j) \in E(G)$, add to $V(G')$ the unique L -frame that connects $(-i, 0)$ to $(0, -j)$ and has the point $(-i, -j)$ as its corner. See Figure 10. Let G' be the resulting graph. Clearly, G' is a XY-crossing graph under the

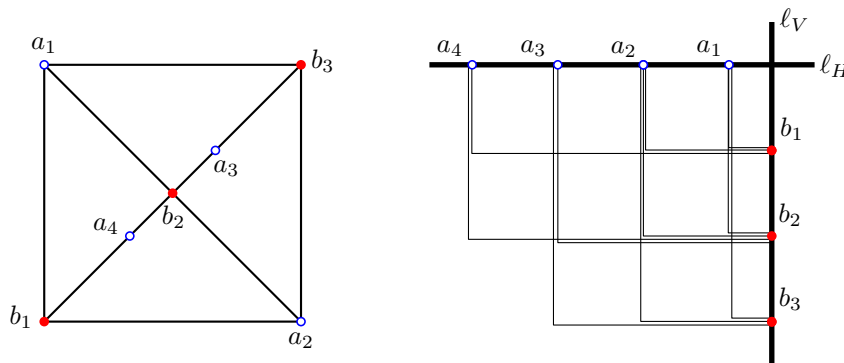

■ **Figure 10** A bipartite graph on 7 vertices (left) and its XY-crossing representation in the edge intersection model (right).

edge intersection model and it can be constructed in polynomial time. Moreover, notice the one-to-one correspondence between the edges of G and the L -frames in G' . It is now easy to see that G has an edge dominating set of size k iff G' has a dominating set of size k (in the edge intersection model).

References

- 1 Andrei Asinowski, Elad Cohen, Martin Charles Golumbic, Vincent Limouzy, Marina Lipshteyn, and Michal Stern. Vertex intersection graphs of paths on a grid. *J. Graph Algorithms Appl.*, 16(2):129–150, 2012.
- 2 Pranjal Awasthi, Moses Charikar, Ravishankar Krishnaswamy, and Ali Kemal Sinop. The hardness of approximation of euclidean k-means. In *SoCG-2015, Netherlands*, 754–767.
- 3 Ayelet Butman, Danny Hermelin, Moshe Lewenstein, and Dror Rawitz. Optimization problems in multiple-interval graphs. *ACM Trans. Algorithms*, 6(2):40:1–40:18, 2010.
- 4 Daniele Catanzaro, Steven Chaplick, Stefan Felsner, Bjarni V. Halldórsson, Magnús M. Halldórsson, Thomas Hixon, and Juraj Stacho. Max point-tolerance graphs. *Discrete Applied Mathematics*, 216:84–97, 2017.
- 5 Timothy M. Chan and Sarel Har-Peled. Approximation algorithms for maximum independent set of pseudo-disks. *Discrete & Computational Geometry*, 48(2):373–392, 2012.
- 6 H. S. Chao, Fang-Rong Hsu, and Richard C. T. Lee. An optimal algorithm for finding the minimum cardinality dominating set on permutation graphs. *Discrete Applied Mathematics*, 102(3):159–173, 2000.
- 7 José R. Correa, Laurent Feuilloley, Pablo Pérez-Lantero, and José A. Soto. Independent and hitting sets of rectangles intersecting a diagonal line: Algorithms and complexity. *DCG*, 53(2):344–365, 2015.
- 8 Mirela Damian and Sriram V. Pemmaraju. Apx-hardness of domination problems in circle graphs. *Inf. Process. Lett.*, 97(6):231–237, 2006.
- 9 Mark de Berg and Amirali Khosravi. Optimal binary space partitions for segments in the plane. *Int. J. Comput. Geometry Appl.*, 22(3):187–206, 2012.
- 10 Irit Dinur and Samuel Safra. On the hardness of approximating minimum vertex cover. *Annals of Mathematics*, 162(1):439–485, 2005.
- 11 Gideon Ehrlich, Shimon Even, and Robert Endre Tarjan. Intersection graphs of curves in the plane. *J. Comb. Theory, Ser. B*, 21(1):8–20, 1976.
- 12 Thomas Erlebach and Erik Jan van Leeuwen. Domination in geometric intersection graphs. In *LATIN 2008, Búzios, Brazil, April 7-11, 2008, Proceedings*, pages 747–758, 2008.

- 13 Matt Gibson and Imran A. Pirwani. Algorithms for dominating set in disk graphs: Breaking the $\log n$ barrier - (extended abstract). In *ESA 2010, UK*, pages 243–254, 2010.
- 14 Martin Charles Golumbic, Marina Lipshteyn, and Michal Stern. Edge intersection graphs of single bend paths on a grid. *Networks*, 54(3):130–138, 2009.
- 15 Daniel Gonçalves, Lucas Isenmann, and Claire Pennarun. Planar graphs as L -intersection or L -contact graphs. In *SODA 2018, New Orleans, USA*, pages 172–184, 2018.
- 16 Daniel Heldt, Kolja B. Knauer, and Torsten Ueckerdt. Edge-intersection graphs of grid paths: The bend-number. *Discrete Applied Mathematics*, 167:144–162, 2014.
- 17 Joseph D. Horton and Kyriakos Kilakos. Minimum edge dominating sets. *SIAM J. Discrete Math.*, 6(3):375–387, 1993.
- 18 Dieter Kratsch and Lorna Stewart. Domination on cocomparability graphs. *SIAM J. Discrete Math.*, 6(3):400–417, 1993.
- 19 Abhiruk Lahiri, Joydeep Mukherjee, and C. R. Subramanian. Maximum independent set on B_1 -VPG graphs. In *COCOA 2015, Houston, TX, USA*, pages 633–646, 2015.
- 20 Saeed Mehrabi. Approximating domination on intersection graphs of paths on a grid. In *WAOA 2017, Vienna, Austria*, 2017.
- 21 Nabil H. Mustafa and Saurabh Ray. Improved results on geometric hitting set problems. *Discrete & Computational Geometry*, 44(4):883–895, 2010.
- 22 Supantha Pandit. Dominating set of rectangles intersecting a straight line. In *CCCG 2017, Ottawa, Ontario, Canada*, pages 144–149, 2017.