

Catalan States of Lattice Crossing: Application of Plucking Polynomial

Mieczyslaw K. Dabkowski

Jozef H. Przytycki

Abstract

For a Catalan state C of a lattice crossing $L(m, n)$ with no returns on one side, we find its coefficient $C(A)$ in the Relative Kauffman Bracket Skein Module expansion of $L(m, n)$. We show, in particular, that $C(A)$ can be found using the plucking polynomial of a rooted tree with a delay function associated to C . Furthermore, for C with returns on one side only, we prove that $C(A)$ is a product of Gaussian polynomials, and its coefficients form a unimodal sequence.

Keywords: Catalan States, Gaussian Polynomial, Knot, Kauffman Bracket, Link, Lattice Crossing, Plucking Polynomial, Rooted Tree, Skein Module, Unimodal Polynomial

Mathematics Subject Classification 2000: Primary 57M99; Secondary 55N, 20D

1 Introduction

Our work finds its roots in the theory of skein modules of 3-manifolds. Let us recall some standard notation and terminology. $F_{g,n}$ denotes an oriented surface of genus g with n boundary components, $I = [0, 1]$, and $M^3 = F_{g,n} \times I$. The $KBSM^1$ of M^3 has a structure of an algebra $S_{2,\infty}(M^3)$ (*Skein Algebra* of M^3), with the multiplication defined by placing a link L_1 above a link L_2 . The algebra $S_{2,\infty}(M^3)$ appears naturally in a study of quantizations of $SL(2, \mathbb{C})$ -character varieties of fundamental groups of surfaces [1, 15]. Therefore, in several important cases $(g, n) \in \{(0, 2), (0, 3), (1, 0), (1, 1), (1, 2)\}$, these algebras have been well studied and understood (see, for instance Theorem 2.1, Corollary 2.2, and Theorem 2.2 in [2]). Furthermore, a very elegant formula for the product in $S_{2,\infty}(F_{1,0} \times I)$ was found by Charles Frohman and Razvan Gelca in [7]. Inspired by these results, we started our quest for a formula of a similar type in $S_{2,\infty}(F_{0,4} \times I)^2$ (see [6]). In this paper, we unravel a surprising connection between our skein algebra, Gaussian polynomials and rooted trees.

The Relative Kauffman Bracket Skein Module ($RKBSM$) was defined in [11]. As shown in [12], $RKBSM$ of $D^2 \times I$ with $2k$ fixed points on $\partial(D^2 \times I)$ is a free module with a basis consisting of all crossingless connections C (called *Catalan states*) between boundary points. Let $R_{m,n}^2$ be an $m \times n$ -rectangle and $N^3 = R_{m,n}^2 \times I$. We fix $2(m+n)$ points $(x_i, \frac{1}{2}), (x'_i, \frac{1}{2}), i = 1, 2, \dots, n; (y_j, \frac{1}{2}), (y'_j, \frac{1}{2}), j = 1, 2, \dots, m$ on $\partial(N^3)$, so that their projection onto $\partial(R_{m,n}^2)$ is as in Figure 1.1. Let $\mathcal{S}_{2,\infty}^{(m,n)}(N^3)$ denote the $RKBSM$ of N^3 with the $2(m+n)$ points fixed. Consider $m \times n$ tangle $L(m, n)$ ($m \times n$ -lattice crossing) obtained by placing n vertical parallel lines above m horizontal parallel lines as in Figure 1.2.

$\text{Cat}(m, n)$ shall denote the set of all crossingless connections between $2(m+n)$ points on $\partial(N^3)$. We can place an order on $\text{Cat}(m, n)$ so that it becomes a basis of $\mathcal{S}_{2,\infty}^{(m,n)}(N^3)$ (see [12]), and now we have

$$L(m, n) = \sum_{C \in \text{Cat}(m, n)} C(A) C,$$

¹For an oriented 3-manifold M^3 , *Kauffman Bracket Skein Module* ($KBSM$) was defined in 1987 by J. H. Przytycki ([11]).

²For $M^3 = F_{0,4} \times I$, the presentation of the algebra $S_{2,\infty}(M^3)$ was found by D. Bullock and J.H. Przytycki (see Theorem 3.1 in [2]).

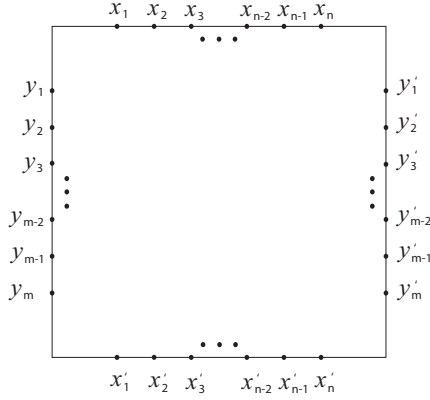

Figure 1.1

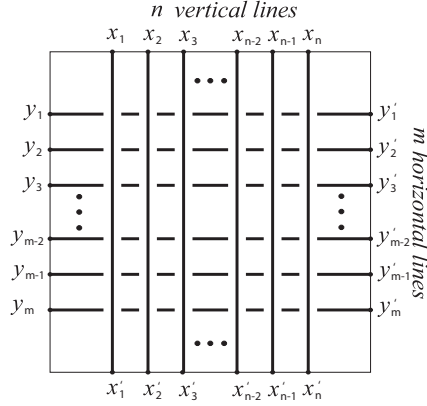

Figure 1.2

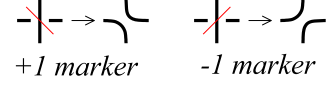

Figure 1.3

for some Laurent polynomials $C(A) \in \mathbb{Z}[A^{\pm 1}]$. In this paper we aim to determine $C(A)$, for all Catalan states C with no returns on a fixed side of $\mathbb{R}_{m,n}^2$.

Let $\mathcal{K}(m, n)$ be the set of all Kauffman states of $L(m, n)$, i.e. the set of all choices of positive and negative markers for mn crossings as in Figure 1.3. For $s \in \mathcal{K}(m, n)$, denote by D_s its corresponding diagram obtained by smoothing all crossings of $L(m, n)$ according to s . Furthermore, let $|D_s|$ be the number of closed components of D_s and C_s be the Catalan state resulting from removal of said components. Define the function $\mathbf{K} : \mathcal{K}(m, n) \rightarrow \text{Cat}(m, n)$ by $\mathbf{K}(s) = C_s$. For $L(m, n)$, the Kauffman state sum is given by:

$$L(m, n) = \sum_{s \in \mathcal{K}(m, n)} A^{p(s)-n(s)} (-A^2 - A^{-2})^{|D_s|} \mathbf{K}(s),$$

where $p(s)$ and $n(s)$ stand for the number of positive and negative markers determined by s , respectively. Hence, for $C \in \text{Cat}(m, n)$, its coefficient is given by:

$$C(A) = \sum_{s \in \mathbf{K}^{-1}(C)} A^{p(s)-n(s)} (-A^2 - A^{-2})^{|D_s|}$$

if $\mathbf{K}^{-1}(C) \neq \emptyset$ (C is a *realizable* Catalan state), otherwise $C(A) = 0$ (C is *non-realizable*). In [6] we gave necessary and sufficient conditions for $\mathbf{K}^{-1}(C) \neq \emptyset$ and found a closed form formula for the number of realizable Catalan states. Furthermore, for C with no arcs starting and ending on the same side of $\mathbb{R}_{m,n}^2$, a formula for $C(A)$ was also obtained³ (see [6]). Let $\text{Cat}_F(m, n)$ denote the subset of all realizable Catalan states of $L(m, n)$ that have no returns on the floor of $\mathbb{R}_{m,n}^2$. In this paper, we consider a submodule of $\mathcal{S}_{2,\infty}^{(m,n)}(N^3)$ generated by $\text{Cat}_F(m, n)$ along with the projection $L_F(m, n)$ of $L(m, n)$ onto the aforementioned submodule. In particular, we show the following:

- 1) For $C \in \text{Cat}_F(m, n)$, its coefficient $C(A)$ can be determined using the plucking polynomial Q of a rooted tree with a delay function⁴ associated to C .
- 2) For $C \in \text{Cat}_F(m, n)$ with returns allowed only on the ceiling of $\mathbb{R}_{m,n}^2$, the coefficient $C(A)$ is a product of Gaussian polynomials and its coefficients form a unimodal sequence.

The paper is organized as follows. In the second section, we define a poset associated with Kauffman states $s \in \mathbf{K}^{-1}(C)$ and use it to compute $C(A)$. Next, in section three, for a Catalan state

³In fact, it was derived by J. Hoste and J. H. Przytycki in 1992 while writing [9] although it was not included in the final version of their paper. Also, as we were told by M. Hajij, a related formula was noted by S. Yamada [16], [8].

⁴Polynomial Q was defined in [13], [14] and its properties were explored in depth in [3], [4], and [5].

$C \in \text{Cat}_F(m, n)$, we define a rooted tree $\mathcal{T}(C)$ with a delay function and the plucking polynomial $Q(\mathcal{T}(C))$. We show that $C(A)$ can be computed using $Q(\mathcal{T}(C))$, the highest and the lowest coefficients of $C(A)$ are equal to one, and all its coefficients in between are positive. In section four, we discuss several important properties of $C(A)$. In particular, using results of [13], [14], and [5], for C with returns on its ceiling only, we obtain as corollaries that $C(A)$ has unimodal coefficients, and we give criterion for a Laurent polynomial to be $C(A)$. Finally, in the last section, we give a closed formula for $C(A)$, where $C \in \text{Cat}(m, 3)$.

2 Poset of Kauffman States

In this section, for Catalan states with no returns on the floor, we construct a poset of Kauffman states which we later use to compute $C(A)$. Given a Catalan state C , its boundary is $\partial C = X \cup X' \cup Y \cup Y'$, where $X = \{x_1, \dots, x_n\}$, $X' = \{x'_1, \dots, x'_n\}$, $Y = \{y_1, \dots, y_m\}$, and $Y' = \{y'_1, \dots, y'_m\}$ (see Figure 2.1). Arcs e_0 joining y_1 and x_1 and e_n joining x_n and y'_1 as well as all arcs e_i that join x_i and x_{i+1} ($i = 1, 2, \dots, n-1$) will be called *the innermost upper cups*. More generally, for a Catalan state C , we will refer to arcs with both ends in X or with one end in X and the other in either Y or Y' as upper cups.

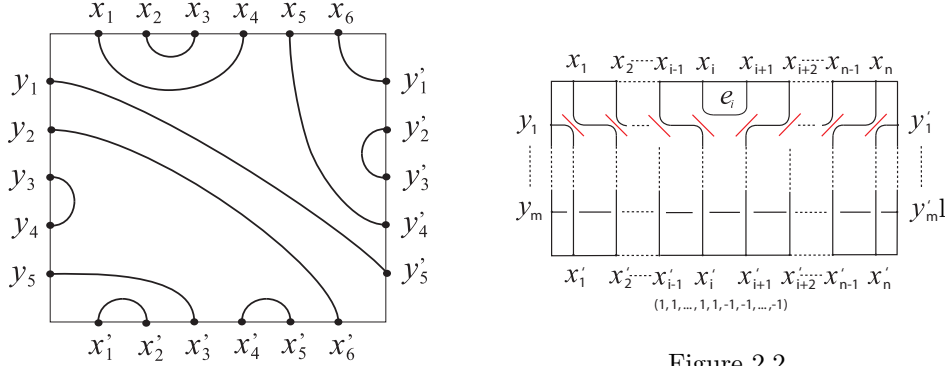

Figure 2.1

Figure 2.2

Let C be a Catalan state of $L(m, n)$. We say that C has no *returns on the floor*, $C \in \text{Cat}_F(m, n)$, if none of its $(m+n)$ arcs have both ends in X' . For such a state, there are precisely m arcs with none of its endpoints in X' . Consider the set of Kauffman states $\mathbf{K}^{-1}(C)$ of $L(m, n)$ which realize $C \in \text{Cat}_F(m, n)$. Each Kauffman state $s \in \mathcal{K}(m, n)$ can be identified with an $m \times n$ matrix $(s_{i,j})$, where $s_{i,j} = \pm 1$. Denote by $\mathcal{K}_F(m, n)$ the subset of $\mathcal{K}(m, n)$ consisting of all states s with rows s_i in the form:

$$s_i = (\underbrace{1, 1, \dots, 1}_{b_i}, \underbrace{-1, \dots, -1}_{n-b_i}),$$

where $0 \leq b_i \leq n$ (see Figure 2.2). In the next proposition, we show that $C(A)$ in $L_F(m, n)$ can be computed using only Kauffman states $s \in \mathcal{K}_F(m, n)$ with $\mathbf{K}(s) = C$. In particular, this significantly reduces the number of Kauffman states that one needs to consider⁵.

Proposition 2.1 *The projection of $L(m, n)$ onto the submodule of $\mathcal{S}_{2, \infty}^{(m, n)}(M^3)$ generated by $\text{Cat}_F(m, n)$ is given by*

$$L_F(m, n) = \sum_{s \in \mathcal{K}_F(m, n)} A^{p(s) - n(s)} \mathbf{K}(s),$$

⁵To compute $L_F(m, n)$ we need to consider $(n+1)^m$ Kauffman states instead of 2^{mn} .

Proof. We compute $L_F(m, n)$ starting from the top row of crossings to the bottom (row by row) using the Kauffman bracket skein relation and omitting states with returns on the floor (observe that we will never get trivial components). When doing so, we should not take into the account Kauffman states with change of markers from -1 to 1 in a row (see Figure 2.3) as they result in lower caps after the regular isotopy of diagrams (see Figure 2.4).

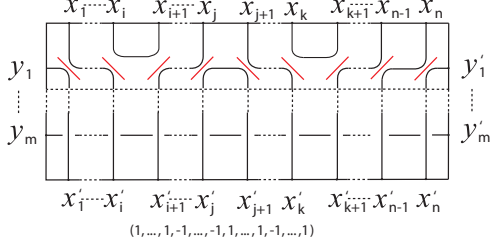

Figure 2.3

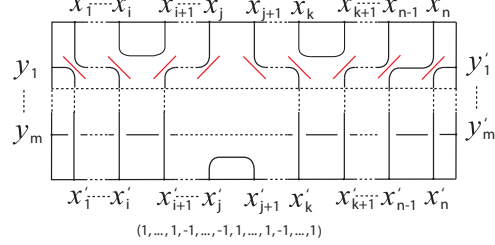

Figure 2.4

Therefore, all Catalan states with no returns on the floor can be obtained using only Kauffman states $\mathcal{K}_F(m, n)$. In particular, we have

$$L_F(m, n) = \sum_{s \in \mathcal{K}_F(m, n)} A^{p(s)-n(s)} \mathbf{K}(s).$$

Hence, the coefficient $C(A)$ of the Catalan state $C \in \text{Cat}_F(m, n)$ can be computed using the formula:

$$C(A) = \sum_{s \in A(C)} A^{p(s)-n(s)},$$

where $A(C)$ consists of all Kauffman states representing C (i.e. $A(C) = \{s \in \mathcal{K}_F(m, n) \mid \mathbf{K}(s) = C\}$).

■

Let $\mathcal{P}(m, n) = \{0, 1, 2, \dots, n\}^m$ be the set of all sequences $\mathbf{b} = (b_1, b_2, \dots, b_m)$, where $0 \leq b_j \leq n$, and $j \in \{1, 2, \dots, m\}$. The sets $\mathcal{K}_F(m, n)$ and $\mathcal{P}(m, n)$ are in bijection, so denote by $\mathbf{b}(s) \in \mathcal{P}(m, n)$ the sequence corresponding to $s \in \mathcal{K}_F(m, n)$; analogously, by $s(\mathbf{b}) \in \mathcal{K}_F(m, n)$, we denote the Kauffman state corresponding to $\mathbf{b} \in \mathcal{P}(m, n)$. Given $\mathbf{b} \in \mathcal{P}(m, n)$, we denote by $C(\mathbf{b})$ the Catalan state obtained from \mathbf{b} (i.e. $C(\mathbf{b}) = \mathbf{K}(s(\mathbf{b}))$).

Proposition 2.2 *For every $C \in \text{Cat}_F(m, n)$, there is a sequence $\mathbf{b} \in \mathcal{P}(m, n)$ such that $C(\mathbf{b}) = C$.*

Proof. Every realizable Catalan state C (not necessarily in $\text{Cat}_F(m, n)$) has at least one innermost upper cup e_{b_1} (see Figure 2.5). Otherwise, as shown in Figure 2.6, C has no upper cups below the dotted line which also cuts C in $n + 2$ points. Hence, it follows that C is non-realizable⁶. The statement of Proposition 2.2 follows by induction on m .

If $m = 1$ there are $n + 1$ Catalan states with no returns on the floor and a single innermost upper cup (see Figure 2.7), so Proposition 2.2 holds with $b = (b_1)$.

Let $m \geq 2$ and $C \in \text{Cat}_F(m, n)$. Assume that the statement holds for all numbers smaller than m . As we noted before, C has an innermost upper cup e_{b_1} and we can deform the diagram of C to that in Figure 2.5. Consider the Catalan state C' shown in the bottom of Figure 2.5. Since C' is in $\text{Cat}_F(m - 1, n)$, then by the inductive hypothesis, there is a sequence (b_2, \dots, b_m) that realizes it. We conclude that $\mathbf{b} = (b_1, b_2, \dots, b_m)$ realizes C which finishes our proof. ■

⁶As we have shown in [6] (see Lemma 2.1 and Theorem 2.5), a Catalan state $C \in \text{Cat}(m, n)$ is realizable if and only if every vertical line cuts C at most m times and every horizontal line cuts C at most n times.

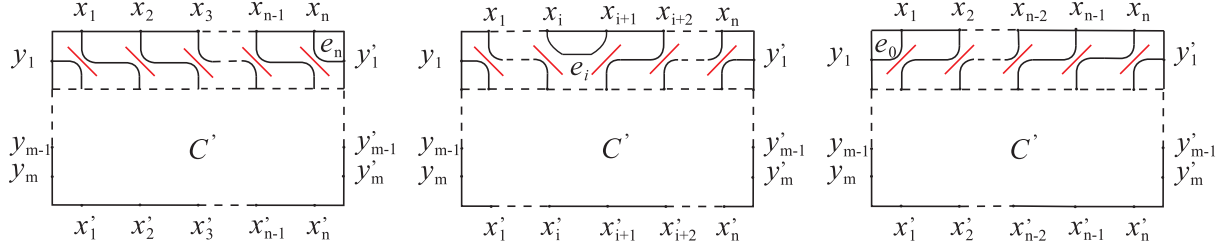

Figure 2.5

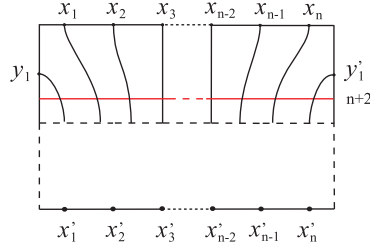

Figure 2.6

It is clear (from our proof of Proposition 2.2) that for $m \geq 2$, there might be several sequences⁷ $\mathbf{b} \in \mathcal{P}(m, n)$ with $C(\mathbf{b}) = C$. Therefore, for $C \in \text{Cat}_F(m, n)$, we let

$$\mathfrak{b}(C) = \{\mathbf{b} \in \mathcal{P}(m, n) \mid C(\mathbf{b}) = C\}.$$

We note that, for $C \in \text{Cat}_F(m, n)$, there is a bijection between the set $A(C)$ of all Kauffman states representing C and the set $\mathfrak{b}(C)$.

Definition 2.3 Let $\mathbf{b} = (b_1, b_2, \dots, b_m) \in \mathcal{P}(m, n)$ be a sequence with $b_i < b_{i+1} < n$ for some i ($1 \leq i \leq m$). Let P_i an operation defined by

$$P_i(\mathbf{b}) = (b_1, \dots, b_{i-1}, b_{i+1} + 1, b_i + 1, b_{i+2}, \dots, b_m),$$

and P_i^{-1} be its inverse. Sequences $\mathbf{b}, \mathbf{b}' \in \mathcal{P}(m, n)$ are called P -equivalent if \mathbf{b}' and \mathbf{b} differ by a finite number of $P_i^{\pm 1}$ operations.

Proposition 2.4 If $\mathbf{b} \in \mathfrak{b}(C)$ and $\mathbf{b}' \in \mathcal{P}(m, n)$ is P -equivalent to \mathbf{b} then $\mathbf{b}' \in \mathfrak{b}(C)$.

Proof. It suffices to show that if $\mathbf{b} \in \mathfrak{b}(C)$ and $\mathbf{b}' = P_i(\mathbf{b})$, then $\mathbf{b}' \in \mathfrak{b}(C)$. This is evident from Figure 2.8 since operations P_i correspond (geometrically) to a change of order in which arcs of C (with no ends on the floor) are realized. ■

Using P_i operations, we define a poset structure on $\mathcal{P}(m, n)$ as follows: \mathbf{b}' covers \mathbf{b} (i.e. $\mathbf{b} \ll \mathbf{b}'$) iff there is $1 \leq i < m-1$, such that $\mathbf{b}' = P_i(\mathbf{b})$. Let \preceq be the transitive closure of \ll . Clearly, $(\mathcal{P}(m, n), \preceq)$ is a poset. Hence $(\mathfrak{b}(C), \preceq)$ is also a poset.

Proposition 2.5 Let $C \in \text{Cat}_F(m, n)$ and $\vec{G}(C) = (V, E)$ be the directed graph with vertices $V = \mathfrak{b}(C)$ and directed edges

$$E = \{(\mathbf{b}, \mathbf{b}') \in V \times V \mid \mathbf{b} \ll \mathbf{b}'\}.$$

Let $G(C)$ be the graph obtained from $\vec{G}(C)$ by ignoring the edge orientations. Then $G(C)$ is a connected graph.

⁷The Catalan state C in $\text{Cat}_F(m, n)$ has exactly one representative \mathbf{b} iff $\mathbf{b} = (b_1, b_2, \dots, b_m)$ with $b_1 = b_2 = \dots = b_k = n-1$, $b_{k+1} = \dots = b_m = n$ for some $1 \leq k \leq m$, or $b_1 = b_2 = \dots = b_k = 1$, $b_{k+1} = \dots = b_m = 0$, for for some $1 \leq k \leq m$.

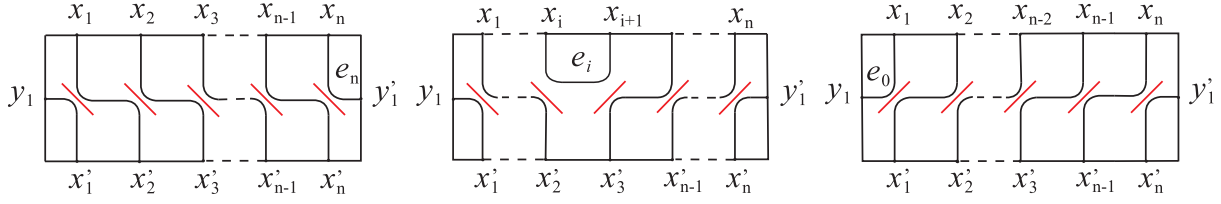

Figure 2.7

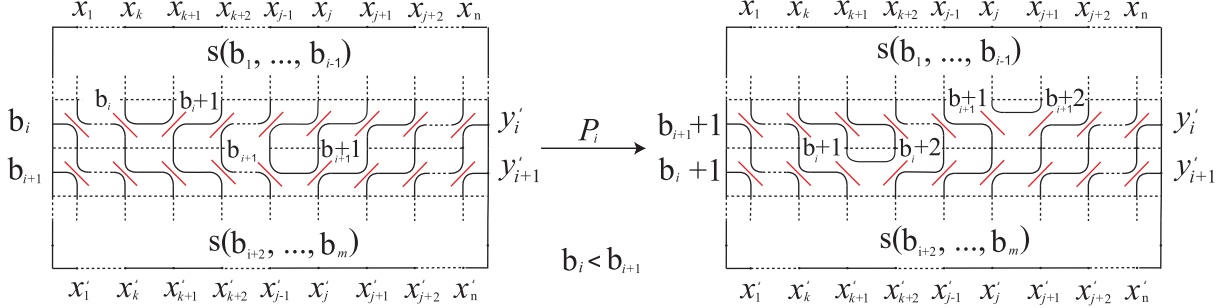

Figure 2.8

Proof. Connectedness of the graph $G(C)$ follows by induction on m . For $m = 1$, the statement is obvious since $\mathbf{b}(C)$ has only one element. Assume that for all $C' \in \text{Cat}_F(m-1, n)$, the graph $G(C')$ is connected and let $\mathbf{b} = (b_1, b_2, \dots, b_m)$, $\mathbf{b}' = (b'_1, b'_2, \dots, b'_m) \in V$. If $b_1 = b'_1$ then sequences $\mathbf{a} = (b_2, \dots, b_m)$, $\mathbf{a}' = (b'_2, \dots, b'_m) \in \mathbf{b}(C')$, where $C' \in \text{Cat}_F(m-1, n)$ is obtained from C by removing its top corresponding to $b_1 (= b'_1)$. By inductive assumption, the graph $G(C')$ is connected, so \mathbf{a} and \mathbf{a}' are P -equivalent and consequently, \mathbf{b} and \mathbf{b}' are also P -equivalent. Therefore, there is a path in $G(C)$ joining vertices \mathbf{b} and \mathbf{b}' . WLOG, we can assume that $0 \leq b'_1 < b_1 \leq n$ (in fact $b'_1 \leq b_1 - 2$ because $e_{b'_1}$ and e_{b_1} are the innermost cups). In the sequence $\mathbf{a}' = (b'_2, \dots, b'_m)$ that represents $C' \in \text{Cat}_F(m-1, n)$ there is b'_k corresponding to the innermost upper cup e_{b_1} of C . By inductive assumption one changes \mathbf{a}' to $\mathbf{a}'' = (b''_2, b''_3, \dots, b''_m) \in \mathbf{b}(C')$ using $P_i^{\pm 1}$ operations, where $b''_2 = b_1 - 1$ represents the innermost upper cup e_{b_1} in C . Now, P_1 operation changes the sequence $(b'_1, b_1 - 1, b''_2, b''_3, \dots, b''_m)$ to $(b_1, b'_1 + 1, b''_3, \dots, b''_m)$. Using the same argument as in the first case (i.e. $b_1 = b'_1$), we see that \mathbf{b} and \mathbf{b}' are in the same connected component of $G(C)$. It follows that the graph $G(C)$ is connected. ■

We observe that, if $\mathbf{b} \ll \mathbf{b}'$ then $|\mathbf{b}'| = |\mathbf{b}| + 2$, hence the directed graph $\vec{G}(C)$ has no directed cycles, i.e. $\vec{G}(C)$ is a *Hasse diagram* of the poset $(\mathbf{b}(C), \preceq)$.

Let $|\mathbf{b}| = \sum_{i=1}^m b_i$ denote the weight of sequence $\mathbf{b} \in \mathcal{P}(m, n)$. Define $\mathbf{b}_{\mathbf{m}}, \mathbf{b}_{\mathbf{M}} \in \mathbf{b}(C)$ to be a minimal and a maximal sequence representing C in the lexicographic order on $\mathbf{b}(C)$ ⁸ respectively.

Proposition 2.6 *Let $C \in \text{Cat}_F(m, n)$ and $\mathbf{b}_{\mathbf{m}}, \mathbf{b}_{\mathbf{M}} \in \mathbf{b}(C)$ be defined as the above. Then $\mathbf{b}_{\mathbf{m}}, \mathbf{b}_{\mathbf{M}}$ are unique elements having the smallest and the largest weight, respectively.*

Proof. Let $\mathbf{b}_{\mathbf{M}} = (b_1, b_2, \dots, b_m)$ and $\mathbf{b}' = (b'_1, b'_2, \dots, b'_m)$ be another sequence representing C (if it exists). We show that $|\mathbf{b}'| < |\mathbf{b}_{\mathbf{M}}|$ by induction on m . For $m = 1$, the statement holds since $\mathbf{b}(C)$ has exactly one element. Assume that the statement is valid for all numbers smaller than m . If $b'_1 = b_1$ we can compare shorter sequences (b_2, \dots, b_m) and (b'_2, \dots, b'_m) . Using induction assumption we conclude that the first sequence has the larger weight, i.e. $|\mathbf{b}'| < |\mathbf{b}_{\mathbf{M}}|$.

⁸Recall, $\mathbf{b} = (b_1, b_2, \dots, b_m) \prec_{lex} \mathbf{b}' = (b'_1, b'_2, \dots, b'_m)$ iff there is k , such that $b_i = b'_i$ for $i < k$ and $b_k < b'_k$.

Suppose b'_1 is smaller than b_1 . There exists $b'_k < n$ ($k > 1$) which represents the innermost upper cup e_{b_1} in C . We consider the following cases:

(i) $b'_2 = \dots = b'_{k-1} = n$. Changing order of cups $e_{b'_1}$ and e_{b_1} in $(b'_1, n, \dots, n, b'_k, \dots, b'_m)$, where $b'_k = b_1 + k - 3$, results in a sequence $(b_1, n, \dots, n, b'_1 + k - 1, \dots, b'_m)$, with the weight larger by 2.

(ii) There is b'_i different than n , for some $1 < i < k$. Let j be the smallest such index (so $b'_i = n$ for $1 < i < j$). Notice that the arc giving the innermost upper cup e_{b_1} in C on the level j has index $b_1 + j - 3$. There are two possibilities:

If $b'_j < b_1 + j - 3$, then the sequence $(b'_j, \dots, b'_k, \dots, b'_m)$ represents the Catalan state with two innermost cups $e_{b'_j}$ and $e_{b_1 + j - 3}$, where $e_{b'_j}$ is to the right of $e_{b_1 + j - 3}$. By inductive assumption, the sequence does not have the maximal weight, as it is not maximal in the lexicographical order (i.e. $b'_j < b_1 + j - 3$).

If $b'_j > b_1 + j - 3$ then b'_j represents the innermost upper cup $e_{b'_j - j + 3}$ in C which is to the right of e_{b_1} . This, however, contradicts the maximality of \mathbf{b}_M in the lexicographic order.

Therefore, \mathbf{b}_M is a unique element with the maximal weight in $\mathfrak{b}(C)$. A proof for \mathbf{b}_m is similar. ■

Example 2.7 Figure 2.9 (diagram on the right) shows the Hasse diagram $\vec{G}(C)$ associated to the Catalan state $C \in \text{Cat}_F(4, 4)$ (see the diagram on the left), and the maximal sequence $\mathbf{b}_M = (3, 4, 4, 3)$ that realizes C (see the middle).

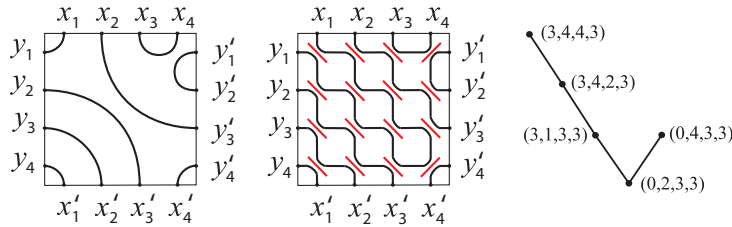

Figure 2.9

From the definition of $\mathfrak{b}(C)$ it directly follows that

$$C(A) = \sum_{\mathbf{b} \in \mathfrak{b}(C)} \left(\prod_{i=1}^m A^{2b_i - n} \right) = \sum_{\mathbf{b} \in \mathfrak{b}(C)} A^{2|\mathbf{b}| - mn}.$$

For the Catalan state in Figure 2.9, in particular, we have:

$$C(A) = 1 + 2A^4 + A^8 + A^{12}.$$

3 Coefficient $C(A)$ and Plucking Polynomial

In this section we explore the relationship between coefficients of Catalan states and the plucking polynomial of associated rooted trees. We would like to stress the fact that the definition of the plucking polynomial was strongly motivated by [6].⁹

3.1 Rooted Tree with Delay Function Associated to $C \in \text{Cat}_F(m, n)$

Let C be a Catalan state in $\text{Cat}(m, n)$. We define, in a standard way, a planar tree $T'(C)$ by taking the dual graph to C . That is, the set of $(m + n)$ arcs of C splits the rectangle $\mathbb{R}_{m,n}^2$ into $m + n + 1$ bounded regions R_i . For each region R_i we have a vertex and, two vertices are adjacent in $T'(C)$ iff their corresponding regions share boundary in common (see Figure 3.1).

⁹In fact, the plucking polynomial for rooted trees was discovered just after the paper [6] was finished.

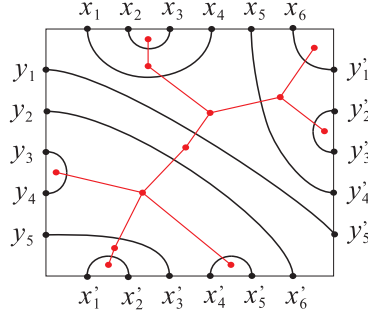

Figure 3.1

For a Catalan state C with no returns on the floor ($C \in \text{Cat}_F(m, n)$), we use a modified version of the tree $T'(C)$ described above. Let $A = \{a_1, a_2, \dots, a_n\}$ be the set of arcs of C with an end on the floor of $\mathbb{R}_{m,n}^2$, and $\{c_1, c_2, \dots, c_m\}$ be the set of arcs of $C - A$. Denote by $T(C) = (V, E)$ the dual graph to $C - A$ and observe that $T(C)$ is an embedded planar tree with $m + 1$ vertices $v \in V$ (corresponding to regions of $C - A$) and m edges $e \in E$ (corresponding to arcs¹⁰ of $C - A$). There is an obvious choice for the root $v_0 \in V$ of $T(C)$, i.e. v_0 is the vertex assigned to the regions containing (as a part of its boundary) the floor of $\mathbb{R}_{m,n}^2$ (see right of Figure 3.2).

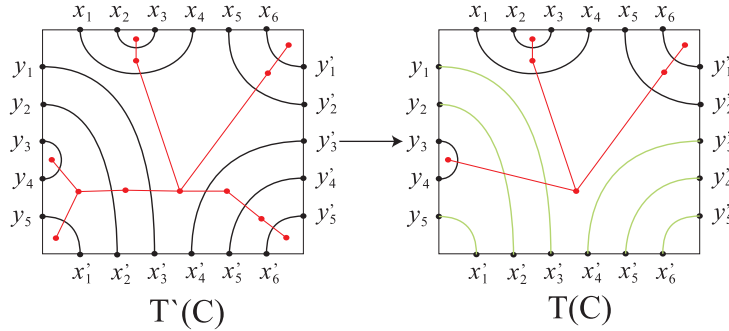

Figure 3.2

For a vertex $u \in V(T)$, let $d(u)$ be the number of vertices adjacent to u (degree of u). A vertex $v \neq v_0$ of degree one ($d(v) = 1$) is called a leaf. Denote by $L(T, v_0)$ the set of all leaves of (T, v_0) . Let $h : C - A \rightarrow \{0, 1, \dots, m\}$ be defined by setting $h(c)$ to be 0, if c has both ends in X ; and $h(c)$ to be the maximal index i of the end point y_i or y'_i of the arc $c \in C - A$, otherwise. Define the delay function $f : L(T(C), v_0) \rightarrow \{1, 2, \dots, m\}$ by putting $f(v) = \max\{1, h(c)\}$, where c corresponds to the edge e incident to v . Let $\mathcal{T}(C) = (T(C), v_0, f)$ be the *rooted tree with a delay function f* associated to $C \in \text{Cat}_F(m, n)$ (see Figure 3.3). We note that there might be several different Catalan states C with the same $\mathcal{T}(C)$ (compare Figure 3.3 and Figure 3.4).

3.2 Plucking Polynomial of Rooted Trees with Delay Function

We recall, after [13, 14], the definition of the plucking polynomial of a plane rooted tree with a delay function from leaves to positive integers. Let (T, v_0) be a plane rooted tree (we assume that our trees are growing upwards, see Figure 3.5). For $v \in L(T, v_0)$ consider the unique path from v to v_0 , and let $r(T, v)$ be the number of vertices of T to the right of the path.

¹⁰Each edge $e \in E$ is dual to a unique arc $c \in C - A$.

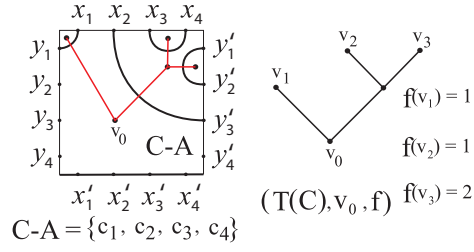
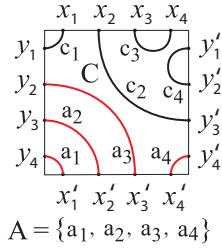

Figure 3.3

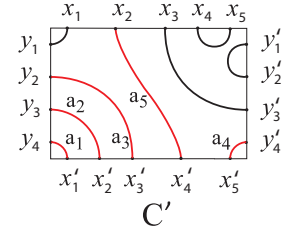

Figure 3.4

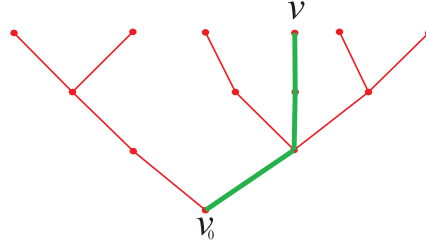

Figure 3.5

Definition 3.1 Let (T, v_0, f) be a plane rooted tree T with the root v_0 and delay function f . Denote by $L_1(T)$ the set of all leaves v of T with $f(v) = 1$. The plucking polynomial $Q(T, f)$ of (T, v_0, f) is a polynomial in variable q defined as follows: If T has no edges, we put $Q(T, f) = 1$; otherwise

$$Q(T, f) = \sum_{v \in L_1(T)} q^{r(T,v)} Q(T - v, f_v),$$

where $f_v(u) = \max\{1, f(u) - 1\}$ if u is a leaf of T , and $f_v(u) = 1$ if u is a new leaf of $T - v$.

Remark 3.2 Clearly, $Q(T, f) = 0$ if $L_1(T) = \emptyset$ and, we note that this is never the case when T is a tree with the delay function associated to a Catalan state.

Example 3.3 In Figure 3.6, computations of $Q(\mathcal{T}(C))$ are shown for $\mathcal{T}(C)$ associated to the Catalan state C in Figure 3.3.

$$\begin{aligned} Q(\mathcal{T}(C)) &= q^1 Q(\mathcal{T}(C) - a_1) + q^3 Q(\mathcal{T}(C) - a_2) \\ &= q^1 Q(\mathcal{T}(C) - a_1) + q^3 Q(\mathcal{T}(C) - a_2) + q^3 Q(\mathcal{T}(C) - a_3) + q^4 Q(\mathcal{T}(C) - a_4) \\ &= q^1 Q(\mathcal{T}(C) - a_1) + q^2 Q(\mathcal{T}(C) - a_2) + q^3 Q(\mathcal{T}(C) - a_3) + q^3 Q(\mathcal{T}(C) - a_4) + q^4 Q(\mathcal{T}(C) - a_5) \\ &= q^1 Q(\mathcal{T}(C) - a_1) + q^2 Q(\mathcal{T}(C) - a_2) + q^3 Q(\mathcal{T}(C) - a_3) + q^3 Q(\mathcal{T}(C) - a_4) + q^4 Q(\mathcal{T}(C) - a_5) \\ &= (q + q^2 + 2q^3 + q^4) Q(\mathcal{T}(C) - a_1) = q + q^2 + 2q^3 + q^4 \end{aligned}$$

Figure 3.6

Our next result establishes a relationship between the coefficient $C(A)$ ($C \in \text{Cat}_F(m, n)$) and the plucking polynomial $Q(\mathcal{T}(C))$ of a rooted tree $\mathcal{T}(C)$ associated to C .

Theorem 3.4 *Let C be a Catalan state with no returns on the floor, $\text{mindeg}_q Q(\mathcal{T}(C))$ be the minimum degree of q in $Q(\mathcal{T}(C))$ and $Q_A(\mathcal{T}(C))$ its evaluation at $q = A^{-4}$. Then the coefficient $C(A)$ of C in $L_F(m, n)$ is given by*

$$C(A) = A^{2|\mathbf{b}_M| - mn - 4 \cdot \text{mindeg}_q Q(\mathcal{T}(C))} Q_A(\mathcal{T}(C)).$$

In particular, if C has returns only on its ceiling or the left side, then $C(A) = A^{2|\mathbf{b}_M| - mn} Q_A(\mathcal{T}(C))$.

Proof. The above statement holds since, in the definition of $Q(\mathcal{T}(C))$, we just follow computations of $C(A)$ outlined in Proposition 2.1 (using the "row by row" approach). In particular, we observe that deleting b_1 from the sequence $\mathbf{b} = (b_1, b_2, \dots, b_m) \in \mathbf{b}(C)$ (i.e. assigning markers according to b_1 in the first row of $L(m, n)$) results in removing a leaf $v \in L_1(\mathcal{T}(C))$ which corresponds to the innermost upper cup e_{b_1} of C . Coefficients of the Laurant polynomial $C(A)$ can then be found by comparing it with $Q(\mathcal{T}(C))$. That is, we observe that if a P_i move is applied on \mathbf{b} , the new sequence $P_i(\mathbf{b})$ adds a new monomial to $C(A)$ obtained by multiplying the monomial $A^{2|\mathbf{b}| - mn}$ by a factor of A^4 . Since each sequence $\mathbf{b} \in \mathbf{b}(C)$ yields a unique order of removing vertices from $\mathcal{T}(C)$, each \mathbf{b} contributes a monomial $q^{n(\mathbf{b})}$ to $Q(\mathcal{T}(C))$. Therefore, a P_i move on \mathbf{b} results in adding a monomial $q^{n(\mathbf{b})}$ multiplied by q^{-1} to $Q(\mathcal{T}(C))$. We describe this in detail for a P_1 move on $\mathbf{b} = (b_1, b_2, b_3, \dots, b_m)$. By definition, the move changes \mathbf{b} to $(b_2 + 1, b_1 + 1, b_3, \dots, b_m)$, hence the monomial $A^{2|\mathbf{b}| - mn}$ corresponding to \mathbf{b} changes to $A^{4+2|\mathbf{b}| - mn}$. Now we observe that, a P_1 move induces a change of order of leaves $v_1 \in L_1(\mathcal{T}(C))$, $v_2 \in L_1(\mathcal{T}(C) - v_1)$ which results in decreasing $r(\mathcal{T}(C), v_1) + r(\mathcal{T}(C) - v_1, v_2)$ by 1 (i.e. the corresponding monomial is multiplied by q^{-1}). Since the graph $G(C)$ is connected, we conclude that

$$C(A) = A^{u(C)} Q_A(\mathcal{T}(C)),$$

for some $u(C)$ that depends only on C . Now, to find $u(C)$, it suffices to compare the maximal power of $C(A)$ with the minimal power of the variable q in $Q(\mathcal{T}(C))$ (i.e. $\text{mindeg}_q Q(\mathcal{T}(C))$). The formula given in the theorem follows and, in particular, if C has only returns on its top or the left side then $\text{mindeg}_q Q(\mathcal{T}(C)) = 0$, so $C(A) = A^{2|\mathbf{b}_M| - mn} Q_A(\mathcal{T}(C))$. ■

Corollary 3.5 *Let C be a Catalan state with no returns on the floor and*

$$C(A) = A^{\text{mindeg}_A C(A)} \sum_{i=0}^N a_i A^{4i}$$

be its coefficient in $L_F(m, n)$, where $N = \frac{1}{4}(\text{maxdeg}_A C(A) - \text{mindeg}_A C(A))$. Then $a_0 = a_N = 1$ and $a_i > 0$, for all $i = 1, 2, \dots, N - 1$.

4 Coefficients of Catalan States with Returns on One Side

The recursion for $Q(\mathcal{T}(C))$ given in Definition 3.1 can be used to prove many important results about $C(A)$. In particular, we can find a closed form formula for coefficients $C(A)$ of Catalan states C with returns on the ceiling only. Furthermore, for such states the polynomial $Q(\mathcal{T}(C))$ depends only on the tree $Q(\mathcal{T}(C))$ rather than its particular planar embedding (see Theorem 4.1). To simplify our notations, let T stand for the rooted tree (T, v_0) . We recall also the notation of the q -analogue of an integer m and q -analogue of a multinomial coefficient. The q -analogue of an integer m is defined by $[m]_q = 1 + q + q^2 + \dots + q^{m-1}$, and let $[m]_q! = [1]_q \cdot [2]_q \cdot \dots \cdot [m]_q$. Therefore, the q -analogue of the multinomial coefficient $\binom{a_1 + a_2 + \dots + a_k}{a_1, a_2, \dots, a_k}_q$ is given by

$$\binom{a_1 + a_2 + \dots + a_k}{a_1, a_2, \dots, a_k}_q = \frac{[a_1 + a_2 + \dots + a_k]_q!}{[a_1]_q! [a_2]_q! \cdot \dots \cdot [a_k]_q!}.$$

In particular, the binomial coefficient (Gauss polynomial) is defined by

$$\binom{a_1 + a_2}{a_1}_q = \binom{a_1 + a_2}{a_1, a_2}_q.$$

Basic properties of the plucking polynomial $Q(T)$ are summarized in the following theorem, [13, 14].

Theorem 4.1 (i) *Let $T = T_1 \vee T_2$ be the wedge product of rooted trees T_1 and T_2 having the common root v_0 . Then,*

$$Q(T) = \binom{|E(T)|}{|E(T_1)|, |E(T_2)|}_q Q(T_1) Q(T_2).$$

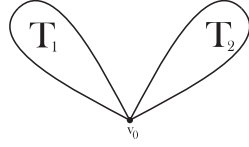

Figure 4.1

(ii) (Wedge Product Formula) *If $T = \bigvee_{i=1}^k T_i$ is the wedge product of rooted trees T_i , $i = 1, 2, \dots, k$ which have the common root v_0 , then*

$$Q(T) = \binom{|E(T)|}{|E(T_1)|, |E(T_2)|, \dots, |E(T_k)|}_q \prod_{i=1}^k Q(T_i).$$

(iii) (Product Formula) *Let $v \in V(T)$ and denote by T^v the rooted subtree of T with the root v . Assume that $T^v = \bigvee_{i=1}^{k(v)} T_i^v$, where T_i^v are rooted trees with the common root v , and let*

$$W(v) = \binom{|E(T^v)|}{|E(T_1^v)|, |E(T_2^v)|, \dots, |E(T_{k(v)}^v)|}_q$$

be the weight of v . Then, $Q(T) = \prod_{v \in V(T)} W(v)$.

In particular, $Q(T)$ does not depend on a plane embedding.

Remark 4.2 Since $C(A) = A^{2|\mathbf{b}_M| - mn} Q_A(\mathcal{T}(C))$, the result of Theorem 4.1 (ii) gives us a closed form formula for computing $C(A)$, i.e.

$$C(A) = A^{2|\mathbf{b}_M| - mn} \left(\prod_{v \in V(T)} W_A(v) \right),$$

where $W_A(v)$ is the Laurant polynomial in A obtained from $W(v)$ by substituting $q = A^{-4}$.

Here we list some further, important from our perspective, properties of $Q(T)$ and its coefficients (see [13], [14], and [5] for proofs). Naturally, these imply the corresponding properties of $C(A)$.

Corollary 4.3 *Let C be a Catalan state with the associated rooted tree $\mathcal{T}(C)$ as in Figure 4.2, (Figure 4.3 shows an example of such a C) then*

$$C(A) = A^{2|\mathbf{b}_M| - mn} \binom{a_1 + a_2 + \dots + a_k}{a_1, a_2, \dots, a_k}_{q=A^{-4}}$$

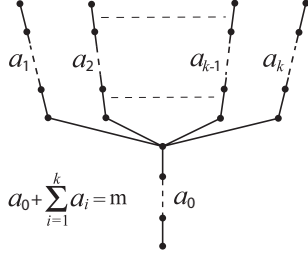

Figure 4.2

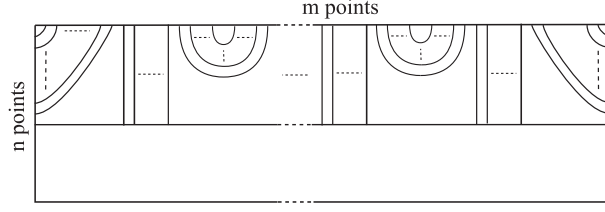

Figure 4.3

Theorem 4.4 Let $C \in \text{Cat}_F(m, n)$ be a Catalan state with returns on its top only and $T = \mathcal{T}(C)$ be the corresponding rooted tree. If

$$Q(T) = \sum_{i=0}^N a_i q^i,$$

then

- (i) $a_0 = a_N = 1$ and $a_i > 0$, $i = 0, 1, 2, \dots, N$.
- (ii) $a_i = a_{N-i}$, $i = 0, 1, 2, \dots, N$, i.e. $Q(T)$ is a palindromic polynomial (also called symmetric polynomial).
- (iii) The sequence $\{a_i\}_{i=0}^N$ is unimodal¹¹, i.e. there is k such that $a_0 \leq a_1 \leq \dots \leq a_{k-1} \leq a_k \geq a_{k+1} \geq \dots \geq a_N$.
- (iv) $Q(T)$ is a product of q -binomial coefficients (Gaussian polynomials).
- (v) $Q(T)$ is a product of cyclotomic polynomials.
- (vi) The degree of the polynomial $Q(T)$ is given by

$$\deg(Q(T)) = \sum_{v \in V(T)} \deg(W(v)),$$

where $W(v)$ is defined as in Theorem 4.1 (iii) and $\deg(W(v)) = \sum_{1 \leq i < j \leq k(v)} |E(T_i^v)| |E(T_j^v)|$.

We can characterize polynomials which can be expressed as $Q(T)$ for some rooted tree T .

Theorem 4.5 [3, 5] Let $P(q)$ be a polynomial. Then $P(q) = Q(T)$ for some rooted tree T if the following conditions are satisfied:

- (i) $P(q)$ is a product of Gaussian polynomials, and
- (ii) $P(q) = \frac{[N]_q!}{[b_1]_q [b_2]_q \dots [b_k]_q}$, where $2 \leq b_1 \leq b_2 \leq \dots \leq b_k < N$.

5 Applications

In this section, we consider the case of a realizable Catalan state $C \in \text{Cat}(m, n)$ which admits a horizontal cross-section of size n or a vertical one of size m . Recall, for a Catalan state $C \in \text{Cat}(m, n)$, we denote by \bar{C} the Catalan state obtained from C by reflecting C about the x -axis (see Figure 5.1).

¹¹Conditions for the strict unimodality of coefficients are given in [4].

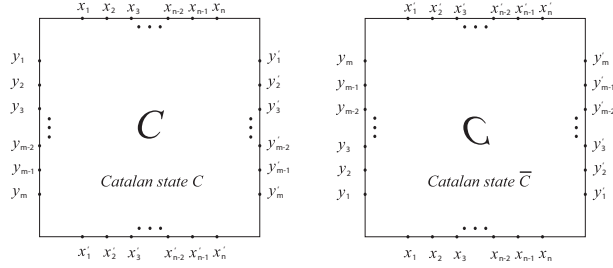

Figure 5.1

Theorem 5.1 Let $C \in \text{Cat}(m, n)$ be a realizable Catalan state with a cross-section of size m , that is, the product¹² $C_1 *_v C_2 = C$ and the common boundary of C_1 and C_2 is intersected by arcs of C exactly n times (see Figure 5.2 and an example shown in Figure 5.3). Then C_1 and \bar{C}_2 are in $L_F(m, n)$ and

$$C(A) = C_1(A) \bar{C}_2(A)$$

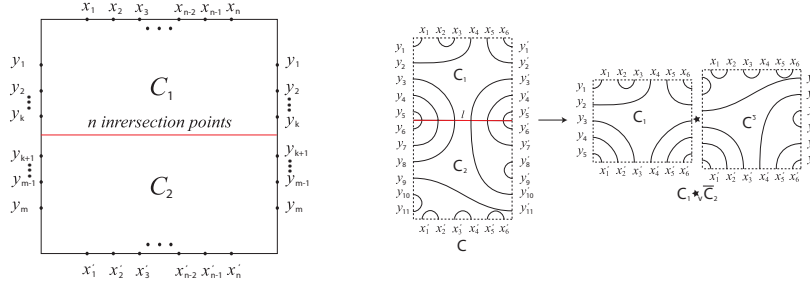

Figure 5.2

Figure 5.3

Example 5.2 Consider Catalan states $C = C^{(m)}$ (with no nesting) shown in Figure 5.4, we have

$$C^{(m)}(A) = \begin{cases} A \frac{(A^2 + A^{-2})^{m+1} - 1}{(A^2 + A^{-2})^2 - 1} & \text{if } m \text{ is odd} \\ (A^2 + A^{-2}) \frac{(A^2 + A^{-2})^m - 1}{(A^2 + A^{-2})^2 - 1} & \text{if } m \text{ is even} \end{cases}$$

The formula follows by induction

$$C^{(2k+1)}(A) = A(1 + (A^2 + A^{-2})C^{(2k)}) \text{ and } C^{(2k)} = A^{-1}(A^2 + A^{-2})C^{(2k-1)}.$$

We observe that not all roots of $C^{(m)}(A)$ are roots of unity. Furthermore, the polynomial $C(A)$ is symmetric, but it is not a product of cyclotomic polynomials.

Example 5.3 Consider the Catalan state C as in Figure 5.5. By Theorem 5.1, $C(A) = A(1 + A^{-4} + A^{-8}) = A[3]_{A^{-4}}$. Thus, for $C^k = C *_v C *_v \dots *_v C$, we have $C^k(A) = A^k ([3]_{A^{-4}})^k$. Notice that for $k > 1$, it does not satisfy condition (ii) of Theorem 4.5.

Corollary 5.4 For a realizable $C \in \text{Cat}(m, 3)$, the coefficients $C(A)$ (up to a power of A) is a product of $[2]_{A^4}$, $[3]_{A^4}$, and $\frac{(A^2 + A^{-2})^{2k} - 1}{(A^2 + A^{-2})^2 - 1}$. In particular, $C(A)$ is symmetric (palindromic), its highest and the lowest coefficients are equal to 1, and there are no gaps. Furthermore, if C has a horizontal line cutting it in exactly 3 points, then $C(A)$ (up to a power of A) is a product of powers of $[2]_{A^4}$, $[3]_{A^4}$.

¹²The operation $*_v$ corresponds to the product in Temperley-Lieb algebra as described by Louis Kauffman [10].

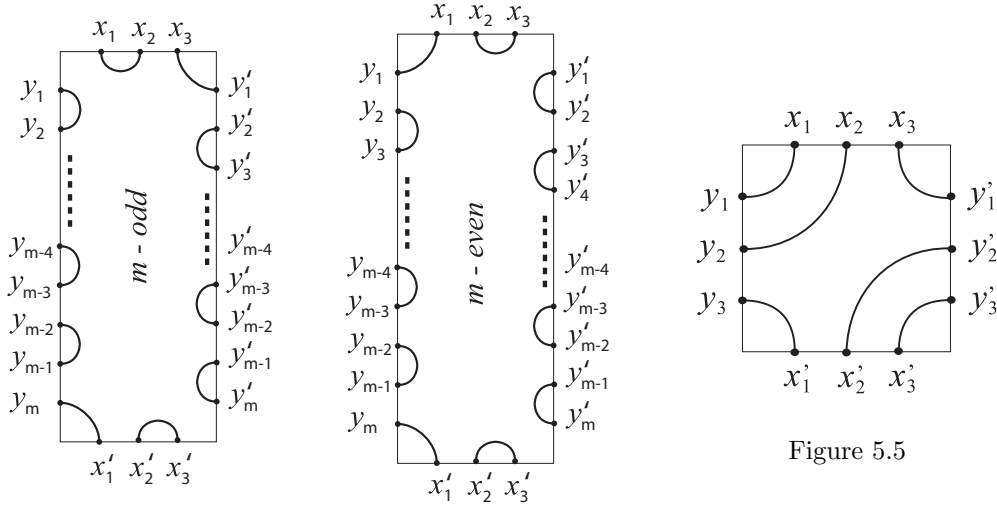

Figure 5.4

Figure 5.5

Proof. Our proof follows by a careful case analysis using Theorem 5.1. ■

We note that if $n = 4$ (that is, $C \in \text{Cat}(m, 4)$) then $C(A)$ is not necessarily symmetric. For example, for the Catalan state in Figure 2.9, we have

$$C(A) = 1 + 2A^4 + A^8 + A^{12}.$$

6 Acknowledgments

J. H. Przytycki was partially supported by the Simons Collaboration Grant-316446 and CCAS Dean's Research Chair award. Authors would like to thank Ivan Dynnikov and Krzysztof Putyra for many useful computations/discussions.

References

- [1] D. Bullock, Rings of $\text{SL}_2(\mathbb{C})$ characters and the Kauffman bracket skein module, *Comment. Math. Helv.* **72**(4), 1997, pp. 521–542; E-print: <http://arxiv.org/abs/q-alg/9604014>.
- [2] D. Bullock, J.H. Przytycki, Multiplicative Structure of Kauffman Bracket Skein Module Quantizations, *Proceedings of the American Mathematical Society*, **128**(3), 2000, pp. 923-931; E-print: <http://front.math.ucdavis.edu/math.QA/9902117>.
- [3] Z. Cheng, S. Mukherjee, J.H. Przytycki, X. Wang, S.Y. Yang, Realization of plucking polynomials, *Journal of Knot Theory and Its Ramifications*, **26**(2), 2017, 1740016 (9 pages).
- [4] Z. Cheng, S. Mukherjee, J.H. Przytycki, X. Wang, S.Y. Yang, *Strict unimodality of q-polynomials of rooted trees*, *Journal of Knot Theory and Its Ramifications*, to appear, E-print: [arXiv:1601.03465](https://arxiv.org/abs/1601.03465).
- [5] Z. Cheng, S. Mukherjee, J.H. Przytycki, X. Wang, S.Y. Yang, *Rooted Trees with the Same Plucking Polynomial*; E-print: [arXiv:1702.02004](https://arxiv.org/abs/1702.02004).
- [6] M.K. Dabkowski, C. Li, J.H. Przytycki, Catalan states of lattice crossing, *Topology and its Applications*, **182** (2015), pp 1-15; E-print: [arXiv:1409.4065](https://arxiv.org/abs/1409.4065) [math.GT].

- [7] C. Frohman, R. Gelca, Skein Modules and the Noncommutative Torus, *Transactions of the American Mathematical Society*, **352**(10), 2000, pp. 4877-4888.
- [8] M. Hajij, The colored Kauffman skein relation and the head and tail of the colored Jones polynomial, Volume **26**(3), 2017, 1741002 (14 pages); E-print: [arXiv:1401.4537](https://arxiv.org/abs/1401.4537).
- [9] J. Hoste, J. H. Przytycki, The skein module of genus 1 Whitehead type manifolds, *Journal of Knot Theory and Its Ramifications*, **4**(3), 1995, pp. 411-427.
- [10] L.H. Kauffman, *On knots*, Annals of Math. Studies, **115**, Princeton University Press, 1987.
- [11] J.H. Przytycki, Skein modules of 3-manifolds, *Bull. Ac. Pol.: Math.*, **39**(1-2), 1991, pp. 91-100; E-print: [arXiv:math/0611797](https://arxiv.org/abs/math/0611797) [math.GT].
- [12] J.H. Przytycki, Fundamentals of Kauffman bracket skein modules, *Kobe Math. J.*, **16**(1), 1999, pp. 45-66; E-print: [arXiv:math/9809113](https://arxiv.org/abs/math/9809113) [math.GT].
- [13] J.H. Przytycki, *Teoria węzłów i związanych z nimi struktur dystrybutywnych* (in Polish) (*Knot Theory and distributive structures*), Wydawnictwo Uniwersytetu Gdańskiego, Second Edition, Gdańsk 2016.
- [14] J.H. Przytycki, q -polynomial invariant of rooted trees; *Arnold Mathematical Journal*, **2**(4), 449-461, 2016; E-print: [arXiv:1512.03080](https://arxiv.org/abs/1512.03080) [math.CO].
- [15] J.H. Przytycki, A.S. Sikora, On skein algebras and $Sl_2(\mathbb{C})$ -character varieties, *Topology*, **39**(1), 2000, pp. 115-148; E-print: <http://front.math.ucdavis.edu/q-alg/9705011>.
- [16] S. Yamada, A topological invariant of spatial regular graphs, *Proc. Knots*, 90, De Gruyter, Berlin, 1992, pp. 447-454.

Mieczysław K. Dabkowski
 Department of Mathematical Sciences
 University of Texas at Dallas
 Richardson TX, 75080
e-mail: mdab@utdallas.edu

Jozef H. Przytycki
 Department of Mathematics
 The George Washington University
 Washington, DC 20052
e-mail: przytyck@gwu.edu
 and University of Gdańsk