

Integrating Small Satellite Communication in an Autonomous Vehicle Network: A Case for Oceanography

André G. C. Guerra^{a,*}, António Sérgio Ferreira^b, Maria Costa^b, Diego Nodar-López^c, Fernando Aguado Agelet^c

^a*Departamento de Física e Astronomia, Centro de Física do Porto, Faculdade de Ciências, Universidade do Porto, Portugal*

^b*Laboratório de Sistemas e Tecnologia Subaquática, Faculdade de Engenharia, Universidade do Porto, Portugal*

^c*Escola de Enxeñaría de Telecomunicación, Universidade de Vigo, España*

Abstract

Small satellites and autonomous vehicles have greatly evolved in the last few decades. Hundreds of small satellites have been launched with increasing functionalities, in the last few years. Likewise, numerous autonomous vehicles have been built, with decreasing costs and form-factor payloads. Here we focus on combining these two multifaceted assets in an incremental way, with an ultimate goal of alleviating the logistical expenses in remote oceanographic operations. The first goal is to create a highly reliable and constantly available communication link for a network of autonomous vehicles, taking advantage of the small satellite lower cost, with respect to conventional spacecraft, and its higher flexibility. We have developed a test platform as a proving ground for this network, by integrating a satellite software defined radio on an unmanned air vehicle, creating a system of systems, and several tests have been run successfully, over land. As soon as the satellite is fully operational, we will start to move towards a cooperative network of autonomous vehicles and small satellites, with application in maritime operations, both *in-situ* and remote sensing.

Keywords: Small Satellites, Autonomous Vehicles, Satellite Communication, System of Systems, Maritime Operations, Field Trials

1. Introduction

Oceans are a fundamental piece of the Earth ecosystem, not only because they cover more than 70% of the Earth surface, but also by playing a central role in the world climate. Therefore, performing measurements of all its features, with both large temporal and spatial resolution, is an important task for several disciplines. Besides scientific objectives, there are also economic and security issues, which most coastal countries have been trying to tackle for several years. This has been mainly achieved through the use of conventional ships or static assets, which currently allow for several *in situ* methods of measuring ocean features. Albeit their small scales, the measurements performed are very accurate and can even be used to calibrate Earth observation satellites.

In the last few years, autonomous vehicles, either underwater, surface or aerial, increased the capabilities of traditional assets, by surveying larger areas in less time and at a smaller cost. The use of autonomous systems provides numerous unparalleled advantages to typical, human-centred, approaches to problem solving when dealing with operational scenarios such as surveillance [1], search and rescue [2], oceanographic and/or atmospheric studies [3, 4]. Advances in autonomous vehicles are in a state of rapid evolution not only due to the lowering of hardware costs, which impact directly the feasibility of more ambitious

endeavours, but also due to the increase in quantity and quality of open-source alternatives to regular commercial autopilot and payload solutions. These variables have set the stage for an ever increasing plethora of applications for autonomous systems not just centred on a single vehicle paradigm but more inline with a multiple system approach. Consequently, networked vehicles have been a topic of great interest due to the extended capabilities which can be extracted for problem solving purposes [5].

Multi-vehicle operational setups have been spearheaded by the LSTS (*Laboratório de Sistemas e Tecnologia Subaquática*) from the University of Porto for quite sometime. Several developments have culminated in a robust software toolchain and in low-cost vehicle solutions, whose discussion will be further expanded in section 2. Moreover, all integration developments are regularly tried and tested in large scale multiple vehicle deployments [6]. However, these large scale multiple deployments lead to an increased level of difficulty in terms of guaranteed interoperability in teams of heterogeneous vehicles [7, 8].

The challenge of implementing network interoperability is of particular interest since unmanned assets can be seen simultaneously middle and end nodes in a multi-hop network. Furthermore, there is always a limitation in terms of range and bandwidth of communication. Therefore, there has been an increasing tendency of providing redundancy for the networked system by implementing different simultaneous communication channels in each asset [9]. While allowing to overcome some limitations of each individual communication channel, this added redundancy creates, at the same time, a more robust communication backbone for the underlying vehicle network. In this regard, and specially when dealing with remote and/or spatially

*Corresponding author

Email addresses: aguerra@fc.up.pt (André G. C. Guerra), asbf@lsts.pt (António Sérgio Ferreira), mariacosta@lsts.pt (Maria Costa), diego.nodar@space.uvigo.es (Diego Nodar-López), faguado@tsc.uvigo.es (Fernando Aguado Agelet)

large covering operations, a *de facto* communication element of a multi-channel backbone is the satellite link. Providing a global and reliable means of communication, while empowering local gateways, or replacing them all together if needed, has long caught the attention of groups working in remote locations, hence positioning satellite communication as a paramount player in robust networking in multi-vehicle scenarios.

Nowadays the most well know satellite communication systems are INMARSAT, Iridium, and Argos, for the particular case of maritime applications. Some of these systems have a large cost not only for the user to have access to them, but also for the provider to set up and maintain them. Their characteristics, both in terms of platforms used as well as user terminals, are examined in section 3.

In the last two decades, cheaper spacecraft, which use commercial off-the-shelf (COTS) components, have been growing in number, capabilities and possible applications, the so-called small satellites [10]. These spacecraft, classified as micro (< 100kg), nano (< 10kg) and pico (< 1kg) satellites, have among other advantages an inherent cost reduction, although still following industry standards. Therefore, a constellation can be, in principle, constructed at a lower price, assuring thus a continuous cover of some sites or even the globe. Nevertheless, with the known limitations of small satellites, for instance, the limited power generation capability, they cannot be used for all kinds of communication systems. An example of a small communication satellite system, created initially to support small scientific and humanitarian operations, is the HumSat system (discussed in section 4). This system is already on the second version, where two way communication is one of the most important new features.

Our main goal is thus to have an integrated operational scenario with autonomous vehicles and small satellites linked and working together. An overview of this scenario can be found in section 5.

Firstly, this choice would free us from expensive current satellite communication while, at the same time, maintaining the satellite link as an integral part of the communication backbone. Secondly, by equipping the spacecraft with other payloads, it would expand the satellite’s operational portfolio, making it part of the remote observation system, and helping the autonomous vehicles navigate the monitored area, and ultimately to be “at the right place at the right time”.

The first step to accomplish our goal, is to have the autonomous vehicles and small satellites talking to each other. To this end, we integrated a HumSat software defined radio (SDR) on an unnamed air vehicle (UAV). Several bench tests were carried out, to make sure everything was working as intended, together with some field trials. The work developed by LSTS and the University of Vigo (UVigo), and the obtained results, are described in section 6.

By using a SDR, and in particular the HumSat SDR, we have a system that can be reconfigured as required. For example, any vehicle equipped with the SDR can act as a storage node, if for some reason the satellite is not available, forwarding the data when a link to the ground station or the satellite is available. Therefore, this flexibility allows to create a system of systems.

2. LSTS Networked Systems

Currently the LSTS is composed of a multi-disciplinary research team, including faculty members and students, with Electrical, Computer, and Mechanical Engineering and Computer Science backgrounds. Vehicles in the LSTS fleet are engineered for networked operations, and use modular hardware and software components to facilitate development, maintenance, and operations. The LSTS open source software toolchain allows the operators at the LSTS control stations to command and control all types of vehicles in an uniform manner.

2.1. Software toolchain

The LSTS toolchain¹, represented in Figure 1, is an open-source software suite for mixed-initiative control (humans in the planning and control loops) [11] of unmanned ocean and air vehicles operating in communication challenging environments with support for Disruptive Tolerant Networking (DTN) protocols [12]. The unique features of the toolchain are built on experience with the coordinated operation of heterogeneous vehicles [9].

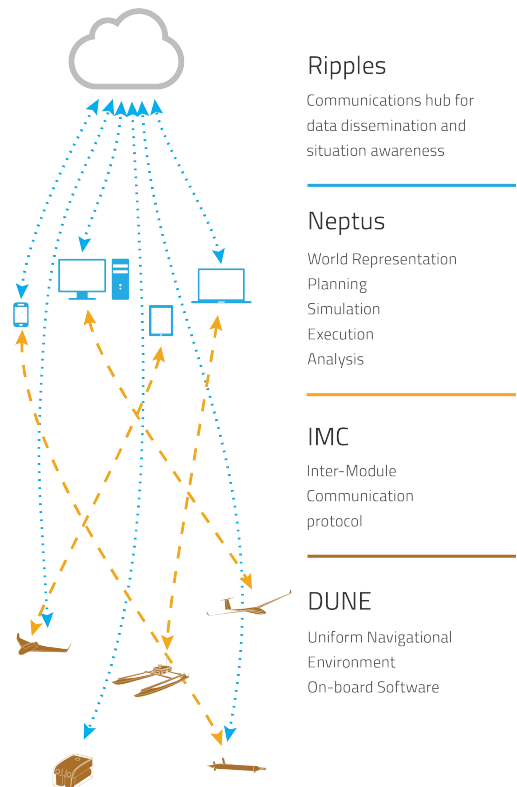

Figure 1: Visual representation of the LSTS toolchain layers.

Ripples is a communication hub for data dissemination and situation awareness. It serves as a web entry point for storing situational awareness information like asset positions, mission specifications and collected data. Ripples is used to collect data

¹The open source software can be found at <https://github.com/LSTS>.

from different sources and to maintain a global situation awareness. All data being sent and received from remote devices is stored in Ripples, enabling coordination among geographically distributed teams, even in communication restricted environments.

Neptus is a distributed command and control infrastructure for the operation of all types of unmanned vehicles. It supports the different phases of a typical mission life cycle: planning, simulation, execution and post-mission analysis. It can be adapted by operators to fit mission-specific requirements and extended by developers through a comprehensive plug-in framework.

IMC (Inter-Module Communication) protocol is a message oriented protocol designed and implemented to build interconnected systems of vehicles, sensors and human operators. These are thus able to pursue common goals cooperatively by exchanging real-time information about the environment and updated objectives. IMC abstracts hardware and communication heterogeneity by providing a shared set of messages that can be serialized and transferred over different means.

DUNE (Unified Navigational Environment) is an on-board software running on the vehicles. It is responsible not only for every interaction with sensors, payload and actuators, but also for communication, navigation, control, manoeuvring, plan execution and vehicle supervision. It is written to be independent of CPU architecture, as well as operating system.

2.2. Autonomous vehicle system

Although there are various vehicles available at the LSTS, we opted to start integrating smaller UAVs as our test platform. This was done due to the simplicity of the hardware integration, and the fact that the communication links on these vehicles are very straightforward in their configurations.

The UAV currently used by LSTS is the X8 Skywalker delta wing. It is a COTS vehicle, modified at the LSTS, which has been used within various types of operational scenarios in previous projects.

The glider shape and size allows for a logistically light operation setup with a short preparation time (about 20 minutes for the first flight, where the UAV is mounted and all consoles turned on, and around 5 minutes for subsequent flights). Furthermore, the vehicle possesses a wide oval internal area, which allows for easy accommodation of different kinds of payload. This proved important for the physical integration process of the HumSat system, due to its prototype nature. It is thus a vehicle perfected for low altitude reconnaissance scenarios, with live video feed, and for remote sensor scenarios.

As presented in Table 1, the main construction material of the X8 is Expanded PolyOlefin (EPO) foam. The X8 has no documented turbulence restrictions and no minimum visibility conditions for operation. Moreover, it has no strict outside air temperature limitations, except for the ones we have determined at the LSTS (0 °C and 40 °C). Regarding any in-flight icing issues, the LSTS X8 does not operate in any environment that would allow such a scenario.

Table 1: X8 Vehicle Specifications.

Parameter	Value
Model Designation	X8 Skywalker
Design	Fixed wing delta wing
Material	EPO Foam
Motor Type	Electric
Fuel/Energy	LiPo battery
Length	0.80 m
Wingspan	2.12 m
Body Diameter	Oval (from 0.15 m to 0.30 m)
Brakes	None
Hydraulic System	None
Parachute	None
Weight Empty	1.2 kg
Mean Take-Off Weight	4.3 kg
Indicated Air Speed (Min Cruise Max)	15 18 23 (m/s)
Wind Tolerance (Head Cross Gust)	17 15 19 (m/s)
Maximum Endurance	50 min
Maximum Range	20 000 m
Maximum Altitude	350 m
Maximum rate of climb	2 m/s
Maximum rate of descent	3 m/s
Maximum bank angle	30 deg
Turn radius Turn rate limits	31 m 32 deg/s

3. Commercial satellite communication systems

Most satellite communication systems are designed for large volumes of data, *i.e.* the user has at his disposal video, voice and data communication. Nevertheless, there are systems designed specifically for performing primarily data collection. The objective for these systems is to have multiple small ground terminals, transmitting small amounts of information, which are then collected by satellites passing above, and downlinked afterwards to a ground station.

3.1. INMARSAT

The first dedicated maritime satellite communication service was INMARSAT. The system is arranged in a four-ocean-region configuration [13], with a total of twelve operational satellites [14]. The new network of spacecraft, called Global Express, is composed of three satellites plus a spare one at a Geostationary orbit (GEO), *i.e.* at an altitude of about 35 800 km [15]. Each satellite has a mass at launch of about 6 100 kg and measures 6.98 m × 33.8 m, when deployed. Five solar panels are used to generate over 13 kW, after 15 years in orbit, and a Xenon ion propulsion maintains the satellite orbit. There are several ground stations, distributed over the globe, routing all data received to each customer over the internet.

The customer has several different equipments available to use the system, including handheld satellite phones (*e.g.* the Isat-Phone 2) or satellite radios (*e.g.* the Fleet One Handset) [15]. These radios, attached to fixed antennas weighting 2.5 kg and measuring 27.5 cm × 22.1 cm, can provide up to 100 kbits/s, consuming around 100 W [16]. Smaller options, *e.g.* the IsatM2M service, has modems measuring just 12.6 cm × 12.6 cm × 4.9 cm (for powered vehicles) or 43.2 cm × 14.7 cm × 2.5 cm (for a modem equipped with batteries) [17]. For the latter, the weights goes up to 1.3 kg, including batteries. Antennas for these modems

measure $12.6\text{ cm} \times 9.3\text{ cm} \times 7.4\text{ cm}$. Since the satellites are at a high orbit, both terminals need more power to send data. Therefore, the consumption can go up to 9 W when transmitting.

3.2. Iridium

One of the most well-known satellite communication services is Iridium. The system uses 66 satellites (without counting spares) distributed by 11 orbital planes [13]. Unlike any other communication system, these satellites are cable of changing messages between them, with each satellite linked to four others [18].

Iridium is build of low Earth orbit (LEO) satellites, at an altitude of approximately 780 km. The new spacecraft, the Iridium NEXT, have life spans closer to 12.5 years [19], and are smaller ($2.4\text{ m} \times 9.4\text{ m}$ when deployed), lighter (with a mass of 860 kg), and require less power to operate (2.2 kW), when compared to INMARSAT [19].

The user terminals are commercialised by other companies and are usually small, with omnidirectional antennas and limited power available. Nowadays, one of the top of the line systems includes a broadband connection and three independent voice lines, using an equipment with 1.35 kg and a 12.5 kg antenna [20]. This system claims to have data transfer rates of up to 134 kbits/s, consuming up to 31 W during data transmission. There are also small transceivers capable of transmitting short burst data, for instance, for data telemetry (with less than 340 bytes) [20]. Data rates for these can reach 2.4 kbits/s [20]. Another commercial example is the RockBlock communication equipment, from Rock Seven, which weights 0.076 kg, measures $7.6\text{ cm} \times 5.2\text{ cm} \times 1.9\text{ cm}$ [21], and the transceiver consumes less than 1 W for transmitting [20].

The companies that sell the terminals lease the access to the system and charge for each voice or data call (*i.e.* duration or volume of data exchanged). For example, Rock Seven nowadays charges \$10/month so a transceiver can connect to the system, and about \$0.14/message (each message is composed of a maximum of 50 bytes) [22]. CLS Group charges around 1 €/kbytes of data transmitted, for the large bandwidth real-time system [23]. Others charge \$0.75/minute to \$1.50/minute, for outgoing calls, and several dollars per minute for incoming ones.

3.3. Argos

Argos is operated and managed by the CLS Group, which charges about 4 €/day, with a maximum of 63 €/month [23]. Version 2 of the system offers global coverage and Doppler location capability, with terminals transmitting messages at a regular interval, without a downlink acknowledgement. With the new version (Argos 3) two way communication is implemented, and the terminals, now called Platform Messaging Transceivers, only send messages when a satellite is in view [24].

The lighter Argos 3 equipment available (mass of 0.08 kg), is manufactured by Elta (exclusively for CLS), measures $1.8\text{ cm} \times 4.3\text{ cm} \times 10\text{ cm}$ and consumes up to 5 W [25]. A heavier option is produced by Kenwood ($2.5\text{ cm} \times 6\text{ cm} \times 8\text{ cm}$ with a mass of 0.16 kg and a power consumption of also 5 W) [26]. All transmitters use UHF to communicate, and have a structured

message composition (with maximum 31 bytes of user data per message [23]). Average data rate for both transceivers is about 400 bits/s [23].

Argos does not have its own dedicated satellites. Instead, it depends on other large spacecraft to function (*e.g.* MetOp, 4 087 kg, and NOAA 5th generation, 2 232 kg) [27]. All of these satellites are sun synchronous (altitude of about 800 km) and, although designed for other purposes, they are equipped with Argos payloads, a receiver (16 kg) and a transmitter (8 kg), providing a data rate of up to 4.8 kbits/s [24]. For the orbit of these satellites, and the transmitters used, this means that up to 3.1 kbytes are upload each pass (in interactive mode with downlink acknowledgement) [23]. Daily this means an average data transmitted of 10 kbytes, depending on the transceiver latitude [23].

The ground segment is composed of three main stations, which receive all user data from the satellites. Apart from those, there are several regional ones, that perform data relay (*i.e.* receive data if the station and transmitter are under the same footprint).

4. A different comms approach – The HumSat system

4.1. Introduction

Building upon the advantages of small satellites, a new communication system started to be developed in 2011, the HumSat system. A project supported mainly by the UN office for outer space affairs (UNOOSA) and the European Space Agency (ESA), was initiated as a cooperation between the University of Vigo, the California Polytechnic State University, the National Autonomous University of Mexico, and the Regional Center for Education in Space Science and Technology in Latin America and Caribbean Countries [28]. It is also supported by the International Astronautical Federation.

It is a smaller system than all previous ones, still under development, but very similar to the Argos concept. Table 2 shows a comparison of this system with the ones described above.

The initial aim was to provide a free non-guaranteed store and forward data system to serve areas not covered by telecommunication services, for humanitarian purposes [29]. Another objective was to have sensors in remote areas transmitting messages to users, without having to set up a communication network [28].

The system is now moving slowly from a technological demonstrator to commercial applications, the HumSat 2.0 [29]. The plan is not only to maximize the number of users, but to include two-way communication and new added value services, such as data relay between terminals, encrypted communication, prioritization, reliable communications and group of terminals management capabilities. Different access schemes are being devised, as well as error correction algorithms and fixed and mobile terminals support. All of them enabled by the deployment of a constellation of small satellites.

All HumSat satellites have been controlled using the same operation software and tools. UVigo built a ground station at the university, with two redundant stations capable of receiving

Table 2: Comparison between satellite communication services (data from Refs. [20, 22, 24, 23]).

System	Orbit Altitude [km]	Comm. Type	Transmitting Power [†] [W]	Data rate [†] [kbits/s]	Data Amount per Message [‡] [bytes]	System of systems
INMARSAT	35 800 (GEO)	Voice	100	100	—*	No
		Data	9	—*	6 400	
Iridium	780 (LEO)	Voice	31	134	-	No
		Data	1	2.4	50	
Argos	800 (LEO)	Data	1	4.8	31	No
HumSat	600 (LEO)	Data	1	1.2	32	Yes

[†] Values shown are top limits.

* Information not available.

four simultaneous polarisation signals [29]. Nevertheless, to command and downlink data from these small satellites it is not necessary a big antenna. Besides supporting the operation of the two satellites described above, it was also used to communicate with other small satellites.

4.2. User Segment

The transmitter of the HumSat system is called by UVigo as the user terminal. There are two options available, either use an automatic or autonomous platform, or to integrate the HumSat transmitter directly on the user equipment. The first is an almost plug and play solution, which simply relays data coming from the user sensors [29]. For the second terminal the user needs to prepare both the hardware and software to link the transmitter to its equipment. We focus here on this last option as it is smaller, lighter and consumes less power.

This transmitter is a simple board with three modules, a radio frequency (RF) stage, a control stage, and a power stage, as shown in Figure 2. The board shown weighs 30 g and measures 13 cm × 5.3 cm. The interface to connect to the board is similar to an Arduino Shield. The RF connector, to link the terminal to an antenna, is an U.FL connector.

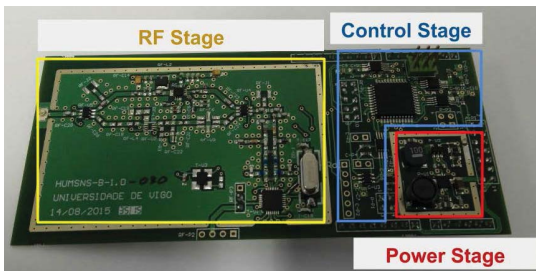

Figure 2: HumSat transmitter photo with labels (from UVigo).

To power the board an unregulated line from 4.3 V and 17 V has to be used, and the board regulates itself accordingly. The board consumes in standby less than 0.14 W, and up to 3.2 W when transmitting at 30 dBm. If just 27 dBm are used for transmitting, it consumes 2.4 W.

The communication interface is performed over a universal asynchronous receiver/transmitter (UART) serial bus, with a bit rate of 9.6 kbits/s. The RF output signal has a frequency between 400 MHz and 470 MHz, and a maximum possible power output of 30 dBm, both selected by the user. The signals have a GMSK (Gaussian Minimum Shift Keying) modulation, with a data rate of up to 1.2 kbits/s.

HumSat 2.0 terminals will have a similar electrical configuration. However, the board is expected to be smaller and capable of higher data rates. Furthermore, smart terminals are being designed to be dynamically integrated with newer sensors [29].

4.3. Space Segment

Although up to now Argos and HumSat seem very similar, one of the main differences is the spacecraft they use. HumSat uses a constellation of small satellites, in particular CubeSats, although only a few at a time have been launched yet.

The first satellite, HumSat-D, was launched in 2013, and was an adaptation of the previous UVigo small satellite, Xatcobeo (Figure 3). It was a CubeSat, with 10 cm × 10 cm × 10 cm, and weighted 1 kg. Using solar cells distributed through most faces, it produced around 3 W. This was sufficient to power the satellite and its communication payload. This consisted in a single electronics board and one turnstile omnidirectional antenna (with four monopoles). No attitude control was even necessary to operate the satellite. Launched from a Dnepr-1 rocket as a secondary payload, its final orbit altitude was 600 km, and was operational for over a year [30].

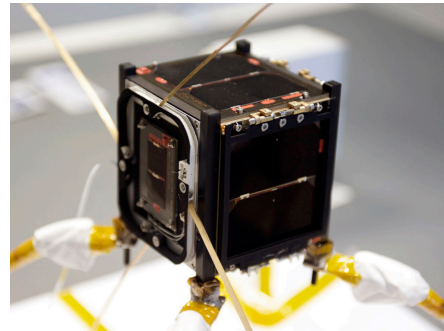

Figure 3: Xatcobeo satellite (from ESA-UVigo/INTA)

With HumSat-D UVigo wanted a demonstrator and guide for the remaining satellites of the system [29]. The next one was called Serpens, and was built for the University of Brasilia with the support of UVigo, funded by the Brazilian space agency. This was a bigger CubeSat (10 cm × 10 cm × 30 cm and 3 kg). The objective of this satellite was to test different combinations of the payload and user terminals for future implementations. Additionally, this satellite included an enhanced payload which was able to counteract external interferences in UHF band, detected with the first satellite.

5. An Integrated System: Mission scenarios

The main driver for the developments presented here is to enable multi-vehicle systems to operate in an integrated and coordinated fashion, by providing them with a robust and stable communication backbone with an ultimate goal of reducing cost and complexity in remote maritime operations. We endeavour to show that, through the use of new small satellite technology, the underlying cost overhead of using satellite communication can be significantly reduced. At the same time, we can empower the observation and data collection capabilities of the network, by also having these satellites participate with their own on-board payload.

A pristine example of an operational scenario is the Portuguese continental shelf. To monitor and carry out surveillance of its current 1.72 million km² area, or the proposed extension of 4 million km² (Figure 4), with just conventional methods, represents a large investment, monetary and human. Therefore, a robust autonomous network like the one described here is fundamental to support these tasks [31].

Looking at Figure 4, the mission scenario has various layers of active communication links. These links range from short-range (Wi-Fi/RF), through medium-range (GSM/4G), up to satellite communication. Moreover, these links are not frozen and can be re-arranged as assets are entering and leaving the operation area. The plug-and-play modality is fundamental for the viability of a system of systems, and a central reason why the developed efforts here were built upon a pre-existent software tool-chain, devised to handle such operational setups.

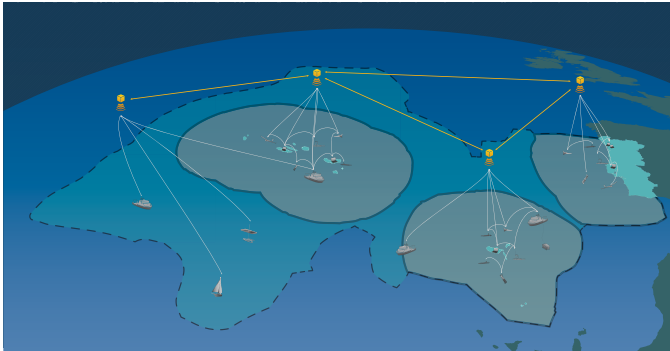

Figure 4: Operational scenario of an integrated network of autonomous vehicles and small satellites.

Although we plan to start with a single small satellite, a constellation of spacecraft will serve the goal better. Since this constellation will take time to build, the scalability of the network can be initially probed through the use of various UAVs which, provided with sufficient SDRs, can emulate the satellites. Although the range and scope of the scenario will not be as far-reaching as with satellites, a lot can be inferred regarding issues of bandwidth and network capacity for the radios.

Even though the project used to fund part of this work is centred in a forest fire project with UVigo [32], all developments can be easily ported to oceanographic scenarios, since the network created is agnostic to the type of data being streamed and collected.

To facilitate system integration and testing, we began with the LSTS X8 UAV, focusing on transmitting only the vehicle's position and velocity. Nevertheless, as the project evolves more metadata will be sent through the satellite, since the communication protocol supports message segmentation and reassembly, to handle information too extensive for a single burst. The X8 already has Wi-Fi and GSM communication, and we can thus use these for redundancy during the SDR tests.

6. System integration and test

6.1. Hardware

Hardware integration of the HumSat system implies adding the SDR board, and an UHF antenna, to the UAV payload. For the LSTS's X8 delta wing this is quite straightforward, considering both its main CPU and the SDR board have a 3V3 TTL (Transistor–Transistor Logic) serial communication. Figure 5 depicts where the SDR is placed within the X8 avionics.

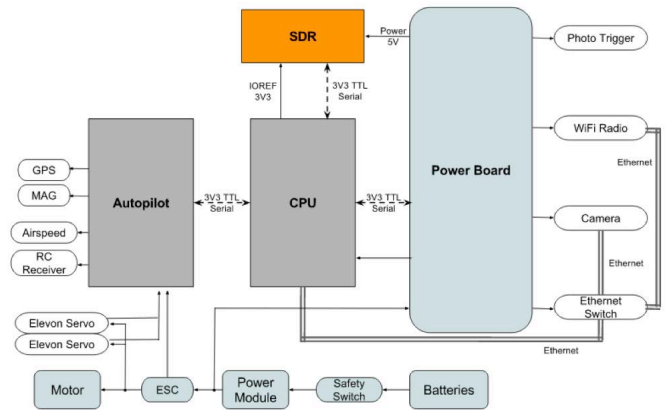

Figure 5: X8 Avionics – Block Diagram.

For selecting the antenna, and placing it on the vehicle, the main concern is to match the radiation pattern to our needs. In particular, the UAV is required to communicate both with a satellite and ground assets, as discussed in section 5. Therefore, the selected antenna is a UHF Dipole 433 MHz [33], and is installed on the nose of the vehicle (see Figure 9).

6.2. Software

All software developments made to integrate the SDR system were done on top of the software toolchain developed at the LSTS, previously described in section 2. A driver task, named SatComms, collects and parses messages, determines when the satellite is in view of the vehicle (and messages can be transmitted), and manages the interaction with the HumSat transmitter (using an adaptation of UVigo's libraries) [34].

SatComms falls within the Transports scope (communication and logging) on DUNE's code organization. During operations the user has full control of the task, being able to change several parameters related to radio configurations, satellite orbital information (period, communication window and last passage),

if data is to be transmitted whenever possible, and which type of data.

Bandwidth constraints of the satellite communication system are a major concern, with the current version limited to 32 bytes messages. This is circumvented by fragmenting data into smaller parts and then reassembling them back to its original state. The two main reasons for this solution are the fact that it was already implemented within the LSTS toolchain, and because it is a message type independent solution.

6.3. Tests and Results

To test and validate the SDR hardware and software integration, since the real satellite is still to be deployed (2018), UVigo provided a satellite simulator. This simulator is able to run the same software that will go on-board the future satellite and thus mimics its behaviour. The test set was divided in three stages: workbench tests, communication dry-run and finally field trials.

6.3.1. Workbench Tests

A closed-loop setup was devised to verify every step of the implementation. It is composed by an exact replica of the UAV avionics (an X8 Testbed), the HumSat SDR transmitter and a dummy antenna, a satellite simulator (provided by UVigo for testing purposes) and a laptop running Neptus (a Neptus Workstation). Part of this setup is shown in figure 6.

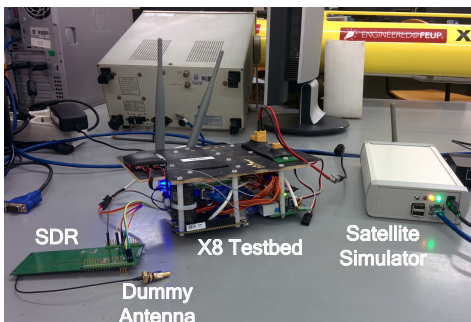

Figure 6: X8 avionics Testbed with HumSat transmitter connected and UVigo satellite simulator.

This Hardware-in-the-Loop (HITL) setup is used to validate the SatComms task behaviour in a simulated environment, in particular the data fragmentation, transmission and reconstruction outcome. At this stage, all systems are connected in the same network and the simulator is configured to send the incoming data to the Neptus Workstation (IP and Port). The Neptus Workstation received all message fragments and was able to reconstruct the data. A few changes were necessary on Neptus to handle repeated message fragments correctly, since the SDR forwards, for redundancy, four times each message.

6.3.2. Communication Dry-Run

Following the software developments validation, we setup a test to emulate a real operational scenario. This requires, apart from the equipment used before, two communication gateways².

²The LSTS Manta Communication Gateways is a portable communication hub, allowing multiple communication channels to be active at the same time.

Both gateways are capable of providing a 3G connection, each with a different external IP, thus creating isolated networks. The LSTS server needs to be active as it will serve as a data router.

In this testing setup, shown in figure 7, the simulator is connected to one communication gateway (gateway A), whilst the Testbed (linked to the SDR) and the Neptus Workstation (which will play the part of a remote DPC, Deferred Procedure Call) are connected to another gateway (gateway B). We placed the Testbed (plus SDR) and the Neptus Workstation on the same network only for logistical convenience, since we also need to have a local workstation to command the Testbed.

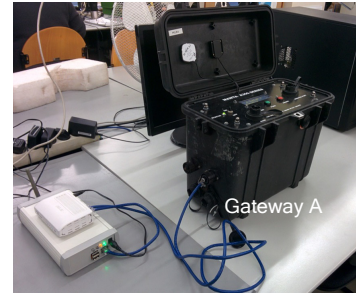

(a) Network A

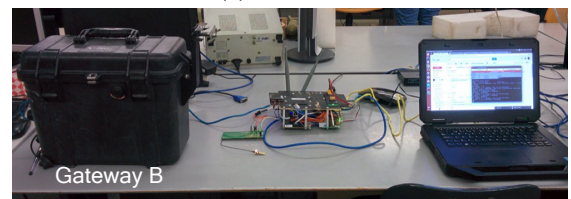

(b) Network B

Figure 7: Communication Dry-Run scenario test setup.

The satellite simulator is configured to send the incoming data to the LSTS server (which is in the laboratory connected to the Internet), using gateway A. In turn, the server routes the data received from the IP of gateway A to the IP of gateway B, which delivers the incoming server traffic to the Neptus Workstation. A schematic of the links is depicted in figure 8. The Neptus Workstation can distinguish between the traffic received from the UAV and the one coming from the satellite. In fact, the only way the Neptus Workstation can receive the data that is being sent with the SDR is through the routing communication done by the LSTS server

A test sequence was carried out to verify everything was working as expected. The tests made, the desired outcome and the results are enumerated, in sequence, in table 3.

6.3.3. Field Trials

After testing and evaluating the SDR integration developments in the workbench, the next step was to confirm the results at the airfield. We installed the HumSat transmitter in the vehicle's belly (vertically, for space optimization purposes) and the UHF antenna on the nose (opposite side to Pitot tube), as shown in figure 9.

The operational setup is identical to the "Communication Dry-Run" scenario. The only difference is the use of the real

Table 3: Communication Dry-Run validation tests.

Test	Description	Expected Outcome	Results
Configure network interface in Simulator	Manual configuration of eth0	Connection established between gateway and simulator	OK
Configure Simulator <i>NeptusConnections</i>	Configure IP and port values	Connection established with LSTS server	OK
Connect communication gateways to internet	Enable “Mobile Internet” in both gateways and give external IPs to POC at LSTS	Mobile Internet successfully established and external IP attributed	OK
Route incoming communication [client]	Add iptable rule to route incoming data from LSTS server to Neptus workstations	Iptable rule successfully saved	OK
Route incoming communication [server]	Configure LSTS server firewall to route incoming simulator data to field operation network	Connection established between LSTS server and Neptus Workstation	OK
Testbed power up	Power up!	Wait for system in “SERVICE” and SatComms task active	OK
Start Simulator	Power up and run script “LSTS”	Simulator ready to receive data	OK [†]
Configure Satellite	Enable satellite and configure last passage parameter	Set parameter and warns about sent option state	OK
Start transmission!	Enable send option	Wait for satellite to appear and starts sending data	OK
Check transmission	Check if dune is transmitting OK	HumSat terminal confirms transmission OK	OK
Check Simulator reception	Check if simulator is receiving packets	Simulator receiving packets	OK
Check Neptus reception	Check if Neptus is receiving data	Neptus shows incoming MessageParts	OK
Check message reconstruction in Neptus	Check if data received is being correctly reconstructed	Neptus shows data reconstructed correctly	OK

[†] Only on second attempt. On the first one, LSTS server was routing data to a port not available, causing the script to crash.

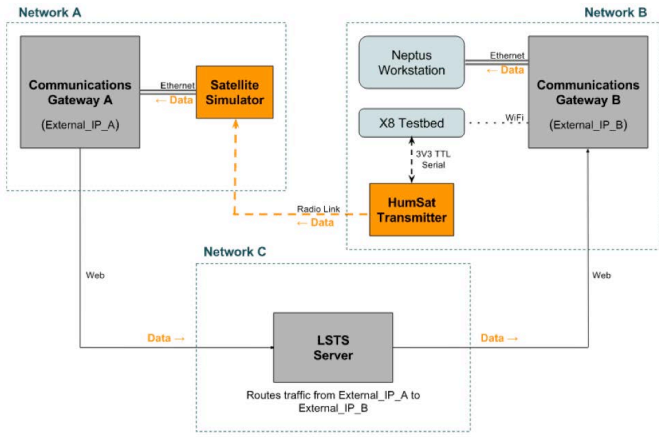

Figure 8: Communication Dry-Run scenario test setup – Block Diagram.

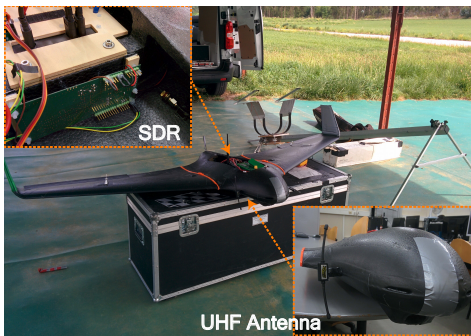
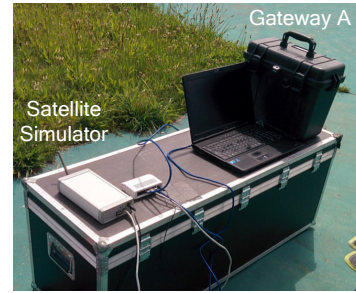
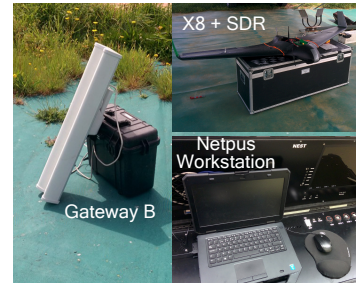

Figure 9: X8 with SDR and UHF antenna installed.



(a) Network A



(b) Network B

Figure 10: Field trials operational setup.

X8 instead of the X8 Testbed. Figure 10 presents the setup used during the field trials, and Table 4 displays the scripted field mission step-by-step, with the obtained results during the field trials.

During the flight tests we were able to gauge that, with the current HumSat configuration, just one satellite, and a communication window of about 5 minutes, approximately 45 kilobytes would be sent from the vehicle to the satellite. In a multi-vehicle scenario, even with a single spacecraft, larger streams of information can be shared among the vehicles, which can then schedule their data transmission, so that a large data packet (*e.g.* an image, an environmental log or some navigational data) can be transmitted and reconstructed on the command and control station. The field trials were carried out on April 2017, with the

Table 4: Field mission script.

Op. Phase	Test	Description	Expected Outcome	Results
Setup	Configure network interface in Simulator	Manual configuration of eth0	Connection established between gateway and simulator	OK
	Configure Simulator NeptusConnections	Configure IP and port values	Connection established with LSTS server	OK
	Connect communication gateways to internet	Enable "Mobile Internet" in both gateways and give external IPs to POC at LSTS.	Mobile Internet successfully established and external IP attributed.	OK
	Route incoming communication [client]	Add iptable rule to route incoming data from LSTS server to Neptus workstation	Iptable rule successfully saved.	OK
	Route incoming communication [server]	Configure LSTS server firewall to route incoming simulator data to field operation network	Connection established between LSTS server and Neptus Workstation	OK
Pre-flight	Power up UAV	Power up UAV and check all systems	Everything working as expected	OK
	Check SDR communication	Check if Satcomms is working properly	Satcomms reports status active	OK
	Check SDR range	Do SDR + UHF antenna range test on the ground	Receive data successfully when UAV is away (as far as possible)	OK
	UAV takeoff	Catapult launch	UAV in air and OK	OK
Flight	Survey plan upload	Make survey plan above desire location and upload it to vehicle	Vehicle synchronizes plan successfully	OK
	Configure Satellite	Enable satellite and configure last passage parameter	Set parameter and warns about sent option state	OK
	Start transmission!	Enable send option	Wait for satellite to appear and starts sending data	OK
	Survey Plan Execution	Start plan previously uploaded	Plan execution starts	OK
	Check transmission	Check if dune is transmitting OK	HumSat terminal confirms transmission OK	OK
	Check Simulator reception	Check if simulator is receiving packets	Simulator receiving packets	OK
	Check Neptus reception	Check if Neptus is receiving data	Neptus shows incoming MessageParts	OK
	Check message reconstruction in Neptus	Check if data received is being correctly reconstructed	Neptus shows data reconstructed correctly	OK [†]
	Waits for end of transmission	Loiter away from plan location after survey completed while communication window is open.	Loiter while transmitting.	OK
UAV Land	UAV retrieval	UAV landing safely!	OK	

[†] On the first flight there were some problems receiving all MessageParts, since the UAV was forced to fly away from the simulator area due to very strong winds. On the second trial the flight occur at the determined area, and all data was received and reconstructed.

next steps already envisioned for mid 2018, when we expect to have a real satellite in operation.

7. Conclusions

In this work we have described the LSTS vehicle system as well as UVigo's SDR board in detail. For the LSTS, the toolchain as well as the vehicles have been deployed around the world, with many hours of accumulated operations. Although the HumSat system from UVigo is more recent, it has been validated with the launch of two small satellites, and several ground terminals deployed in places such as Antarctica, South and North America, and Europe.

Additionally, we characterised some of the current commercial satellite communication systems. Even though there are several options available, we focus on the ones that could be representative of the different options for sea operational scenarios. Moreover, we discussed a large bandwidth and real time system, INMARSAT, one with limited bandwidth and gaps in the communication, Argos, and a mixed system that can offer both options and does not require a large transmitting power, Iridium. These solutions depend on the user's objectives, and have a wide range of prices.

Finally, we have presented the efforts of integrating the Hum-Sat SDR system on-board of a small, low cost, UAV. The development team created additional software for the LSTS toolchain, which allows the use of the SDR as a viable communication channel, in spite of the current limitations to the amount of data which can be streamed through this channel. Moreover, a preliminary analysis of the bandwidth issues with the SDR technology was assessed, and important conclusions for the next version of the radio prototype were drawn. These will influence the next prototype iteration of the SRD system.

8. Future Work

The modifications to the current proposed solution deal with both hardware and software components. One of the main issues, already being addressed, is the possibility of upgrading the HumSat SDR to allow centralised full-duplex communication, since the current prototype only has one-way. This would enable each vehicle to receive as well as transmit data, increasing the robustness of the communication network, without using two SDRs. It would also simplify communication logistics and accommodation problems in small UAVs. Another issue, is the

number of messages that have to be sent to the satellite to transmit a simple variable as the vehicle's estimated state. Since the main reason, apart from the HumSat 32 bytes data length, is the overhead created by the IMC communication protocol, steps are being taken to employ a minimalistic version of this protocol for the satellite channel. With this approach, less messages would have to be transmitted for each package of data, maximising thus successful variable reconstruction on the Neptus Workstation (*i.e.* the UAV ground station). All of these solutions will be tested in the next batch of field flight tests.

Although a fully fledged test will be difficult without a complete satellite constellation in place, the scalability of the proposed solution can still be inferred by the use of multiple UAVs in the operation area as smaller relay nodes. These will help identifying issues about the network before having the logistical costs associated with the spacecraft launches while, at the same time, allow for evaluating the synergies of the SDR technology with the remaining communication links available to the autonomous vehicle teams.

The reality of creating a fully multimedia satellite service would require a considerable initial investment, even taking into account the reduced cost of small satellites when compared with conventional commercial ones. It would have to take into account not only the costs of developing and building the necessary number of spacecraft, but also to cope with the logistics involved in launching all small satellites, and making sure that they reached their correct positions. Nonetheless, a small satellite constellation, providing just low speed data connection will, at least in principle, have a smaller cost. Moreover, the overall success of the small satellites approach, to keep up with the large communication spacecraft, is correlated with specific pieces of technology which are key for future missions. Examples of these include new and miniaturised high gain antennae, improved software defined radios, high efficient amplifiers, and better orbit and attitude control.

Acknowledgements

The work of André Guerra is supported by the Fundação para a Ciência e a Tecnologia (Portuguese Agency for Research) fellowship PD/BD/113536/2015. André Guerra would also like to thank his PhD supervisor, Orfeu Bertolami, for several discussions and suggestions on the subject of this paper, and for reviewing it. The work of Maria Costa and Sérgio Ferreira was partially supported by Marinfo (NORTE-01-0145-FEDER-000031) and STRIDE (NORTE-01-0145-FEDER-000033). The work of Diego Nodar and Fernando Aguado was partially supported by the Spanish Ministry of Economy, Industry and Competitiveness under projects HumSat 2.0 (ESP2013-47935-C4-1-R) and IMONSS (ESP2016-79184-R). The work of Maria Costa, Sérgio Ferreira, Diego Nodar and Fernando Aguado was partially supported by Interreg Sudoe programme under grant number SOE1/P4/E0437 (Fire-RS project). The authors would like to thank all the support from the people in the Laboratório de Sistemas e Tecnologia Subaquática (LSTS) and Centro Gallego de Innovación Aeroespacial (CINAE).

References

- [1] G. Zhou, S. Reichle, UAV-based multi-sensor data fusion processing, *International Journal of Image and Data Fusion* 1 (3) (2010) 283–291. doi:10.1080/19479832.2010.497343.
- [2] E. Bitton, K. Goldberg, Hydra: A framework and algorithms for mixed-initiative UAV-assisted search and rescue, in: 2008 IEEE International Conference on Automation Science and Engineering, IEEE, 2008, pp. 61–66. doi:10.1109/COASE.2008.4626527.
- [3] P. McGillivray, J. B. Sousa, R. Martins, Connecting the dots. Networking maritime fleets of autonomous systems for science and surveillance, *Marine Technology Reporter* (2012) 32–38.
- [4] J. Fortuna, F. Ferreira, R. Gomes, A. S. Ferreira, J. B. Sousa, Using low cost open source UAVs for marine wild life monitoring - Field Report, *IFAC Proceedings Volumes* 46 (30) (2013) 291–295. doi:10.3182/20131120-3-FR-4045.00055.
- [5] J. Eckert, D. Eckhoft, R. German, Flying Ad-Hoc Network communication for detecting thermals: Feasibility and insights, in: Third International Conference on Innovative Computing Technology (INTECH 2013), IEEE, 2013, pp. 333–338. doi:10.1109/INTECH.2013.6653654.
- [6] J. B. Sousa, J. Pereira, J. Pinto, P. C. Lourenfo, J. M. Galocha, J. Fontes, M. Silva, K. Rajan, T. A. Johansson, J. Alves, A. Munafó, K. Pelekanakis, R. Petrocchia, M. Carreiro Silva, M. Incze, *Rapid Environmental Picture Atlantic exercise 2015: A field report*, in: OCEANS 2016 MTS/IEEE Monterey, IEEE, 2016, pp. 1–6. doi:10.1109/OCEANS.2016.7761496. URL <http://ieeexplore.ieee.org/document/7761496/>
- [7] B. Bagdatli, K. Griendling, D. Kalpakchian, E. Jones, S. Ussery, J. Ball, J. Kallman, D. Mavris, A method for examining the impact of interoperability on mission performance in a system-of-systems, in: 2010 IEEE Aerospace Conference, IEEE, 2010, pp. 1–15. doi:10.1109/AERO.2010.5446884.
- [8] C. Fuchs, A. S. Ferreira, J. B. Sousa, G. Gonçalves, Adaptive Consoles for Supervisory Control of Multiple Unmanned Aerial Vehicles, in: M. Kurosu (Ed.), *Human-Computer Interaction. Interaction Modalities and Techniques*, Springer Berlin Heidelberg, 2013, pp. 678–687. doi:10.1007/978-3-642-39330-3_73.
- [9] A. S. Ferreira, J. Pinto, P. S. Dias, J. B. Sousa, The LSTS software toolchain for persistent maritime operations applied through vehicular ad-hoc networks, in: 2017 International Conference on Unmanned Aircraft Systems (ICUAS), IEEE, 2017, pp. 609–616. doi:10.1109/ICUAS.2017.7991471.
- [10] A. G. C. Guerra, F. Francisco, J. Villate, F. Aguado Agelet, O. Bertolami, K. Rajan, On small satellites for oceanography: A survey, *Acta Astronautica* 127 (2016) 404–423. doi:10.1016/j.actaastro.2016.06.007.
- [11] J. Pinto, P. S. Dias, R. Martins, J. Fortuna, E. Marques, J. B. Sousa, The LSTS toolchain for networked vehicle systems, in: OCEANS 2013 MTS/IEEE Bergen: The Challenges of the Northern Dimension, IEEE, 2013, pp. 1–9. doi:10.1109/OCEANS-Bergen.2013.6608148.
- [12] D. Merani, A. Berni, J. Potter, R. Martins, An Underwater Convergence Layer for Disruption Tolerant Networking, in: 2011 Baltic Congress on Future Internet and Communications, IEEE, 2011, pp. 103–108. doi:10.1109/BCFIC-RIGA.2011.5733227.
- [13] B. G. Evans (Ed.), *Satellite Communication Systems*, IET, The Institution of Engineering and Technology, Michael Faraday House, Six Hills Way, Stevenage SG1 2AY, UK, 1999. doi:10.1049/PBTE038E.
- [14] P. Chini, G. Giambene, S. Kota, A survey on mobile satellite systems, *International Journal of Satellite Communications and Networking* (2009) 29–57. doi:10.1002/sat.941.
- [15] Inmarsat plc., *inmarsat*, visited June 15, 2017 (2013). URL www.inmarsat.com
- [16] Inmarsat plc., *Fleet One - INMARSAT terminal specification* (2014).
- [17] Orbcomm, *ORBCOMM*, visited June 17, 2017 (2017). URL www.orbcomm.com
- [18] R. Hobby, An introduction to the Iridium, in: *IEE Colloquium on Communication Opportunities Offered by Advanced Satellite Systems*, Vol. 1998, IEE, London, UK, 1998, pp. 1–1. doi:10.1049/ic:19980875.
- [19] Orbital ATK, *Iridium NEXT - Fact Sheet*, retrieved June 20, 2017 (2015). URL https://www.orbitalatk.com/space-systems/commercial-satellites/communications-satellites/docs/FS002_{_}11_{_}0A_{_}3862IridiumNEXT.pdf
- [20] CLS America, *Iridium Services & Hardware - 2017 Catalog* (2016).

- [21] Rock Seven Mobile Services Ltd, RockBLOCK v2 - Developer Guide (2016).
- [22] Rock Seven Mobile Services Ltd, [Rock Seven](#), visited June 20, 2017 (2014).
URL www.rock7mobile.com
- [23] B. Yann, CLS America, Personal communication (2017).
- [24] CLS America, Argos-3 – The New Generation, Tech. rep. (2011).
- [25] Elta, Terminals and Beacons – PMT Argos 3 (2017).
- [26] CLS America, Argos-3 PMT-K – Platform messaging transceiver (2009).
- [27] European Space Agency, [Satellite Missions Directory - Earth Observation Missions - eoPortal](#), visited June 20, 2017 (2017).
URL <https://directory.eoportal.org>
- [28] A. Castro, R. Walker, F. Emma, F. Aguado Agelet, R. Tubio, W. Balogh, Hands-on experience: The HumSAT system and the ESA GEOID initiative, ESA Bulletin – European Space Agency 149 (2012) 45–50.
- [29] F. Aguado Agelet, D. Nodar-López, A. G. Muiño, Satellite Communication Systems based on Small Satellite Platforms, in: 3rd IAA Conference On University Satellite Missions And Cubesat Workshop, International Academy of Astronautics, Rome, 2015, iAA-CU-15-OS-0P.
- [30] European Space Agency, [HumSat / GEOID / GENSO](#), visited June 07, 2017 (2017).
URL <https://directory.eoportal.org/web/eoportal/-/humsat>
- [31] O. Bertolami, A. G. C. Guerra, F. Francisco, J. Villate, Pequenos satélites em Portugal, contribution to Portugal Space 2030, Fundação para a Ciência e a Tecnologia (2017).
- [32] Universidade de Vigo, Universidade do Porto, Laboratoire d'Analyse et d'Architecture des Systèmes, Fire-RS - Wildfire Picosatellite Constellation & UAVs Remote Sensing: Active fire mapping and management (2016).
- [33] FPVMODEL.COM, [HAWKEYE UHF Dipole 433MHZ Antenna](#), visited April 12, 2017 (2015).
URL https://www.fpvmodel.com/hawkeye-uhf-dipole-433mhz-antenna_{_}g847.html
- [34] A. G. C. Guerra, M. Costa, [SatComms Task Software Files](#), found in LSTS/dune GitHub repository, feature/humsat branch, and dune/src/Transports/ folder (2017).
URL <https://github.com/LSTS/>