

# Complexity of locally-injective homomorphisms to tournaments

Stefan Bard<sup>1a</sup>, Thomas Bellitto<sup>b</sup>, Christopher Duffy<sup>c</sup>,  
Gary MacGillivray<sup>a</sup>, Feiran Yang<sup>a</sup>

<sup>a</sup>Department of Mathematics and Statistics, University of Victoria, CANADA

<sup>b</sup>Univ. Bordeaux, CNRS, LaBRI, UMR 5800, F-33400 Talence, FRANCE

<sup>c</sup>Department of Mathematics and Statistics, University of Saskatchewan, CANADA

## 1. INTRODUCTION

Given two graphs  $G = (V_G, E_G)$  and  $H = (V_H, E_H)$ , a *homomorphism* from  $G$  to  $H$  is a function  $f : V_G \rightarrow V_H$  such that for every  $uv \in E_G$ ,  $f(u)f(v) \in E_H$ . A homomorphism from  $G$  to  $H$  is referred to as an  $H$ -colouring of  $G$  and the vertices of  $H$  are regarded as *colours*. The graph  $H$  is called the *target* of the homomorphism. These definitions extend to directed graphs by requiring that the mapping must preserve the existence as well as the direction of each arc.

A *locally-injective homomorphism*  $f$  from  $G$  to  $H$  is a homomorphism from  $G$  to  $H$  such that for every  $v \in V$  the restriction of  $f$  to  $N(v)$  (or possibly  $N[v] = N(v) \cup \{v\}$ ) is injective. The complexity of locally-injective homomorphisms for undirected graphs has been examined by a variety of authors and in a variety of contexts [6, 7, 10, 11, 12, 13, 14, 21]. Locally-injective homomorphisms of graphs find application in a range of areas including bio-informatics [1, 8, 9] and coding theory [14].

Here we consider locally-injective homomorphisms of *oriented graphs*, that is, directed graphs in which any two vertices are joined by at most one arc. Given a vertex  $v$ , an arc from  $v$  to  $v$  is called a *loop*. A directed graph with a loop at every vertex is called *reflexive*; a directed graph with no loops is called *irreflexive*.

To define locally-injective homomorphisms of oriented graphs, one must choose the neighbourhood(s) on which the homomorphism must be injective. Up to symmetry, there are four natural choices:

- (1)  $N^-(v)$ .
- (2)  $N^+(v)$  and also  $N^-(v)$ .
- (3)  $N^+(v) \cup N^-(v)$ .
- (4)  $N^+[v] \cup N^-[v] = N^+(v) \cup N^-(v) \cup \{v\}$ .

For irreflexive targets, (2), (3) and (4) are equivalent. Under (4), adjacent vertices must always be assigned different colours, and hence whether or not the target contains loops is irrelevant. Therefore, we may assume that targets are irreflexive when considering (4). Then, a locally-injective homomorphism to an irreflexive target satisfying (4) is equivalent to a locally-injective homomorphism to the same irreflexive target under either (2) or (3). As such, we need not consider (4) and are left with three distinct cases.

Taking (1) as our injectivity requirement defines *in-injective homomorphism*; taking (2) defines *ios-injective homomorphism*; and taking (3) defines *iot-injective homomorphism*. Here “ios” and “iot” stand for “in and out separately” and “in and out together” respectively.

The problem of in-injective homomorphism is examined by MacGillivray, Raspaud, and Swarts in [18, 19]. They give a dichotomy theorem for the problem of in-injective homomorphism to reflexive oriented graphs; and one for the problem of in-injective homomorphism to irreflexive tournaments. The problem of in-injective homomorphism to irreflexive oriented graphs  $H$  is shown to be NP-complete when the maximum in-degree of  $H$ ,  $\Delta^-(H)$ , is at least 3, and Polynomial when  $\Delta^-(H) = 1$ . For the case  $\Delta^-(H) = 2$  they show that an instance of directed graph homomorphism polynomially transforms to an instance of in-injective homomorphism to a target with maximum

<sup>1</sup>Corresponding author: sbard@uvic.ca

in-degree 2. As such the restriction of in-injective homomorphism to targets  $H$  so that  $\Delta^-(H) = 2$  constitutes a rich class of problems.

The remaining problems, ios-injective homomorphism and iot-injective homomorphism, are considered by Campbell, Clarke and MacGillivray [4, 5, 17]. In this paper we extend the results of Campbell, Clarke and MacGillivray to provide dichotomy theorems for the restriction of the problems of iot-injective homomorphism and ios-injective homomorphism to reflexive tournaments.

Preliminary results are surveyed in Section 2. In Section 3, we show that ios-injective homomorphism is NP-complete for reflexive tournaments on 4 or more vertices. In Section 4, we show that iot-injective homomorphism is also NP-complete for reflexive tournaments on 4 or more vertices. We close with a brief discussion of injective homomorphisms to irreflexive tournaments.

## 2. KNOWN RESULTS

For a fixed undirected graph  $H$ , the problem of determining whether an undirected graph  $G$  admits a homomorphism to  $H$  (i.e., *the  $H$ -colouring problem*) admits a well-known dichotomy theorem.

**Theorem 2.1** (HELL, NEŠETRIL, 1990 [15]). *Let  $H$  be an undirected graph. If  $H$  is irreflexive and non-bipartite, then  $H$ -colouring is NP-complete. If  $H$  has a loop, or is bipartite, then  $H$ -colouring is Polynomial.*

A conjectured dichotomy theorem for the complexity of  $H$ -colouring of directed graphs can be found in [2], and three separate proofs of this conjectured theorem have been announced [3, 20, 22].

For fixed small reflexive tournaments  $T$ , Campbell, Clarke and MacGillivray give the following result for the complexity of ios-injective  $T$ -colouring and iot-injective  $T$ -colouring, where ios-injective  $T$ -colouring and iot-injective  $T$ -colouring are defined analogously to  $H$ -colouring.

**Theorem 2.2** (CAMPBELL, CLARKE AND MACGILLIVRAY, 2009 [4, 5, 17]). *If  $T$  is a reflexive tournament on 2 or fewer vertices, then ios-injective  $T$ -colouring and iot-injective  $T$ -colouring are Polynomial. If  $T$  is a reflexive tournament on 3 vertices, then ios-injective  $T$ -colouring and iot-injective  $T$ -colouring are NP-complete.*



FIGURE 1. The two reflexive tournaments on three vertices: the reflexive three-cycle  $C_3$  and the reflexive transitive tournament on three vertices  $TT_3$ .

## 3. IOS-INJECTIVE HOMOMORPHISMS

In this section we prove a dichotomy theorem for ios-injective  $T$ -colouring, where  $T$  is a reflexive tournament. We show that both ios-injective  $T_4$ -colouring and ios-injective  $T_5$ -colouring are NP-complete (see Figures 2 and 3). We then show that any instance of ios-injective  $T$ -colouring, where  $T$  is a reflexive tournament on at least 4 vertices, polynomially reduces to an instance of ios-injective  $T'$  colourings, where  $T'$  is  $T_4$ ,  $T_5$ ,  $C_3$  or  $TT_3$  (see Figures 1, 2 and 3). The dichotomy theorem follows from combining these results with the result in Theorem 2.2.

We begin with a study of ios-injective  $T_4$ -colouring. To show ios-injective  $T_4$ -colouring is NP-complete we provide a transformation from edge 3-colouring. We construct an oriented graph  $H$  from a graph  $G$  so that  $G$  has an edge-3-colouring if and only if  $H$  admits an ios-injective homomorphism to  $T_4$ . The key ingredients in this construction are a pair of oriented graphs,  $H_x$  and  $H_{uv}$ , given in Figures 4 and 5, respectively.

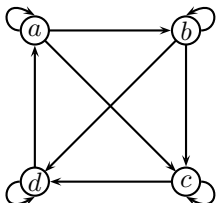

FIGURE 2.  $T_4$  – the only strongly connected reflexive tournament on four vertices.

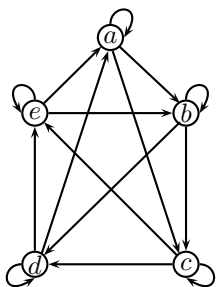

FIGURE 3.  $T_5$  – the only reflexive tournament on five vertices where all the vertices have in-degree and out-degree three.

**Lemma 3.1.** *In any ios-injective  $T_4$ -colouring of  $H_x$*

- (1) *the vertices 5, 17 and 29 are coloured  $a$ ; and*
- (2) *vertex 37 is coloured  $d$ .*

*Proof.* (1) By symmetry, it suffices to show the claim for vertex 5. Let us first note that the vertices 5 and 9 have out-degree 3 and can therefore only be coloured  $a$  or  $b$ , as these are the only vertices of out-degree 3 in  $T_4$ . If vertex 9 is coloured  $a$ , then its two in-neighbours, vertices 7 and 8, are coloured  $d$  and  $a$ . However, this is impossible as no vertex of out-degree three in  $T_4$  has both  $d$  and  $a$  as out-neighbours. Hence, vertex 9 is coloured  $b$ . If vertex 5 is coloured  $b$ , then vertices 7 and 8 would be both in- and out-neighbours of vertices coloured  $b$ . Thus, each of vertices 7 and 8 are coloured  $b$ . This is a violation of the injectivity requirement. Therefore vertex 5 (and by symmetry, the vertices 17 and 29) must be coloured  $a$ .

(2) Notice that the square vertices in the  $H_x$  (vertices 4, 16 and 28) cannot be coloured  $a$ ; they each have an in-neighbour that already has an out-neighbour coloured  $a$ . These square vertices have a common out-neighbour and so must receive distinct colours by the injectivity requirement. As none is coloured  $a$ , these three vertices are coloured  $b$ ,  $c$  and  $d$ , in some order. The only vertex

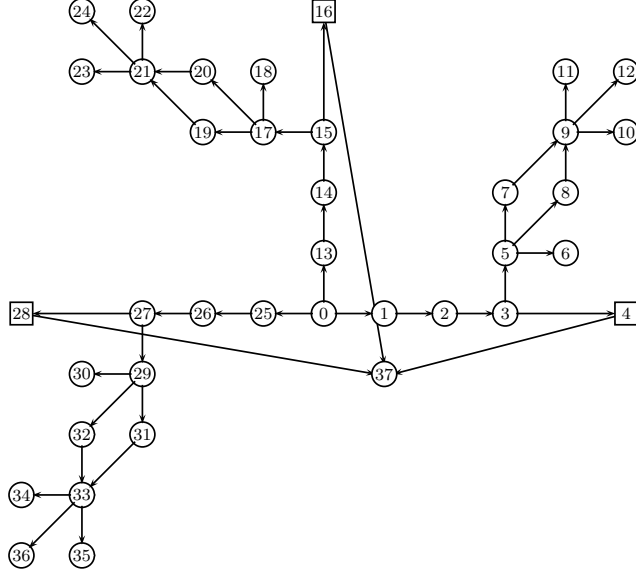

FIGURE 4.  $H_x$

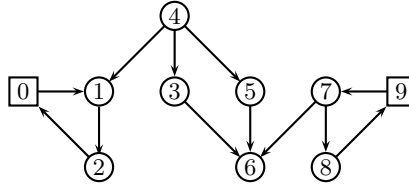

FIGURE 5.  $H_e$

that is an out-neighbour of  $b$ ,  $c$  and  $d$  in  $T_4$  is  $d$ . And so, the common out-neighbour of vertices 4, 16 and 28 (i.e., vertex 37) has colour  $d$ .  $\square$

**Lemma 3.2.** *Let  $H'_e$  be an oriented graph formed from a copy of  $H_e$  and two copies of  $H_x$  by identifying vertex 0 in  $H_e$  with any square vertex in one copy of  $H_x$  and identifying vertex 9 in  $H_e$  with any square vertex in the second copy of  $H_x$ . In any iot-injective  $T_4$ -colouring of  $H'_e$ , the vertices 0 and 9 in the subgraph induced by  $H_e$  have the same colour.*

*Proof.* Let  $H'_e$  be constructed as described. Consider an iot-injective  $T_4$ -colouring of  $H'_e$ . We examine the colours of the vertices in the subgraph induced by the copy of  $H_e$ . By Lemma 3.1 and the construction of  $H'_e$ , vertices 0 and 9 each have an in-neighbour that has an out-neighbour coloured  $a$ . By the injectivity requirement neither vertex 0 or 9 is coloured  $a$ . We proceed in cases to show that vertices 0 and 9 receive the same colour.

*Case I: Vertex 0 is coloured  $b$ .* Suppose vertex 0 is coloured  $b$ . It cannot be that vertex 1 is coloured  $d$ , as vertex 0 has an out-neighbour coloured  $d$  – vertex 37 in a copy of  $H_x$ . It cannot be that vertex 1 is coloured  $c$  as no 3-cycle of  $T_4$  contains both a vertex coloured  $b$  and a vertex coloured

$c$ . Thus, vertex 1 must be coloured  $b$ . The vertex 2 is both an in-neighbour and an out-neighbour of vertices coloured  $b$  and is therefore coloured  $b$ . The vertex 4 is an in-neighbour of vertex 1, and so cannot be coloured  $b$  as vertex 1 already has an in-neighbour coloured  $b$ . The vertex 4 must thus be coloured  $a$ . By injectivity, the out-neighbours of vertex 4 must receive distinct colours that are out-neighbours of  $a$  in  $T_4$ . Therefore vertices 3 and 5 are coloured  $a$  and  $c$  in some order, as vertex 1 is coloured  $b$ . The only common out-neighbour of  $a$  and  $c$  in  $T_4$  is  $c$ . As such, the vertex 6 must be coloured  $c$ . By injectivity, each of the in-neighbours of vertex 6 must receive distinct colours that are in-neighbours of  $c$  in  $T_4$ . And so vertex 7 must be coloured  $b$ . As vertex 9 cannot be coloured  $a$  and it has an out-neighbour coloured  $b$ , namely vertex 7, we have that vertex 9 must be coloured  $b$ . Thus vertices 0 and 9 have the same colour.

*Case II: Vertex 0 is coloured  $c$ .* Suppose vertex 0 is coloured  $c$ . The out-neighbours of  $c$  in  $T_4$  are  $c$  and  $d$ . It cannot be that vertex 1 is coloured  $d$ , as vertex 0 has an out-neighbour coloured  $d$  – vertex 37 in a copy of  $H_x$ . And so vertex 1 is coloured  $c$ .

The vertex 4 has an out-neighbour coloured  $c$ , and so must be coloured  $a$  or  $b$  or  $c$ . Since vertex 0 is coloured  $c$ , vertex 4 cannot be coloured  $c$  without violating injectivity. We claim vertex 4 is coloured  $b$ .

If vertex 4 is coloured  $a$ , then by injectivity, vertices 3 and 5 are coloured  $a$  and  $b$ , in some order. The only out-neighbour of  $a$  and  $c$  in  $T_4$  that has in-degree 3 is  $c$ . As such vertex 6 is coloured  $c$ . The vertex  $c$  in  $T_4$  has three in-neighbours –  $a$ ,  $b$ , and  $c$ . As vertex 6 has in-neighbours coloured  $a$  and  $b$  (namely, vertices 3 and 5), then by injectivity the third in-neighbour of vertex 6 (namely, vertex 7) is coloured  $c$ . In  $T_4$ ,  $c$  has two out-neighbours:  $c$  and  $d$ . Since vertex 7 is coloured  $c$  and already has an out-neighbour coloured  $c$ , vertex 8 must be coloured  $d$ . The vertex 9 has an in-neighbour coloured  $d$ . Only vertices  $a$  and  $d$  in  $T_4$  have  $d$  as an in-neighbour. Therefore vertex 9 is coloured with  $a$  or  $d$ . However, we have shown previously that vertex 9 cannot be coloured  $a$ . This implies, that vertex 9 is coloured  $d$ . However, vertex 9 has an out-neighbour coloured  $c$ . Since  $c$  is not an out-neighbour of  $d$  in  $T_4$ , we arrive at a contradiction. Thus vertex 4 is not coloured  $a$ . Therefore vertex 4 is coloured  $b$ .

Since vertex 4 is coloured  $b$ , vertices 3 and 5 are coloured  $b$  and  $d$ , in some order. The only common out-neighbour of  $b$  and  $d$  in  $T_4$  is  $d$ . Therefore vertex 6 is coloured  $d$ . Hence, by injectivity, the vertex 7 is coloured  $c$ . Since vertex 7 has an out-neighbour coloured  $d$ , vertex 8, another out-neighbour of vertex 7 must be coloured  $c$ . Since 9 has both an in-neighbour and an out-neighbour coloured  $c$ , the vertex 9 must be coloured  $c$ . Thus vertices 0 and 9 have the same colour.

*Case III: Vertex 0 is coloured  $d$ .* Suppose the vertex 0 is coloured  $d$ . It cannot be that vertex 1 is coloured  $d$ , as vertex 0 has an out-neighbour coloured  $d$  – vertex 37 in a copy of  $H_x$ . Vertex  $d$  has two out-neighbours in  $T_4$ :  $a$  and  $d$ . Therefore vertex 1 is coloured  $a$ .

The vertex 4 has out-degree 3 and an out-neighbour coloured  $a$ . Vertex  $a$  is the only vertex in  $T_4$  to have out-degree 3 and have  $a$  as an out-neighbour. Therefore vertex 4 is coloured  $a$ . By injectivity the vertices 3 and 5, the remaining out-neighbours of vertex 4, are coloured  $b$  and  $c$ . The vertex 7 cannot be coloured  $d$  since 9 already has an out-neighbour coloured  $d$  – vertex 37 in a copy of  $H_x$ . Moreover, vertex 7 is an in-neighbour of 6, which already has in-neighbours coloured  $c$  and  $b$ . Hence, the vertex 7 must be coloured  $a$ . In  $T_4$  the only in-neighbours of  $a$  are  $a$  and  $d$ . Thus vertex 9 is coloured  $a$  or  $d$ . Recall from remarks at the start of the proof that vertex 9 cannot be coloured  $a$ . Therefore vertex 9 is coloured  $d$ , as required.  $\square$

**Theorem 3.3.** *The problem of ios-injective  $T_4$ -colouring is NP-complete.*

*Proof.* The transformation is from edge 3-colouring. Recall that edge-3-colouring is NP-complete even when restricted to subcubic graphs [16].

Let  $G$  be a graph with maximum degree at most 3 and let  $\tilde{G}$  be an arbitrary orientation of  $G$ . We create an oriented graph  $H$  from  $\tilde{G}$  as follows. For every  $v \in V(G)$  we add  $H_x$ , a copy of

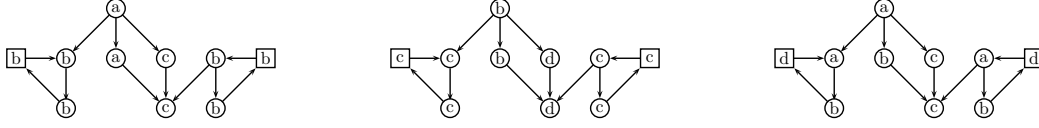

FIGURE 6. Colouring the copies of  $H_{uv}$  in Theorem 3.3.

the oriented graph given in Figure 4, to  $H$ . For every arc  $uv \in E(\tilde{G})$  we add  $H_{uv}$ , a copy of the oriented graph given in Figure 5, to  $H$ . To complete the construction of  $H$ , for each arc  $uv \in E(\tilde{G})$  we identify the vertex 0 in  $H_{uv}$  with one of the three square vertices (i.e., vertices 4, 16, or 28) in  $H_u$  and identify the vertex 9 in  $H_{uv}$  with one of the three square vertices in  $H_v$ . We identify these vertices in such a way that each square vertex in a copy of  $H_x$  is identified with at most one square vertex from a copy of  $H_e$ . We note that this is always possible as vertices in  $G$  have degree at most three.

We claim  $G$  has a edge-3-colouring if and only if  $H$  has an ios-injective  $T_4$ -colouring. Suppose an ios-injective  $T_4$ -colouring of  $H$  is given. This ios-injective  $T_4$ -colouring induces an edge-3-colouring of  $G$ : the colour of an edge in  $uv \in E(G)$  is given by colour of vertices 0 and 9 in corresponding copy of  $H_{uv}$  contained in  $H$ . By Lemma 3.2 this colour is well-defined. Recall that for each copy of  $H_x$ , the vertices 4, 16 and 28 are respectively each identified with either vertex 0 or vertex 9 in some copy of  $H_e$ . Therefore by Lemma 3.1 we have that each of the edges incident with any vertex receive different colours and no more than 3 colours, namely  $b$ ,  $c$ , and  $d$ , are used on the edges of  $G$ .

Suppose an edge-3-colouring of  $G$ ,  $f : E(G) \rightarrow \{b, c, d\}$  is given. For each  $uv \in E(G)$  we colour  $H_{uv}$  using one of the ios-injective  $T_4$ -colourings given in Figure 6. We choose the colouring of each copy of  $H_{uv}$  so that vertices 0 and 9 in that copy are assigned the same colour as  $uv$  by  $f$ . To complete the proof, we show that such a colouring can be extended to all copies of  $H_x$  contained in  $H$ .

Recall that for each copy of  $H_x$ , the vertices 4, 16 and 28 are respectively each identified with either vertex 0 or vertex 9 in some copy of  $H_{uv}$ . Since  $f$  is a edge 3-colouring of  $G$ , for each  $x \in V(G)$ , each of the vertices 4, 28 and 16 in  $H_x$  are coloured with distinct colours from the set  $\{b, c, d\}$  when we colour each copy of  $H_{uv}$  using Figure 6.

Observe that for any 2-element subset,  $\{u_1, u_2\} \subset \{4, 16, 28\}$  there is an automorphism of  $H_x$  that swaps vertices  $u_1$  and  $u_2$  and fixes the remaining vertex in  $\{4, 16, 28\} \setminus \{u_1, u_2\}$ . As such we may assume, without loss of generality, that vertices 4, 16 and 28 are respectively coloured  $b$ ,  $c$  and  $d$  in each copy of  $H_x$ . The ios-injective  $T_4$ -colouring given in Figure 7 extends a pre-colouring of the vertices 4, 16 and 28 with colours  $b$ ,  $c$ , and  $d$ , respectively, to an ios-injective  $T_4$ -colouring of  $H_x$ . Therefore  $G$  has a edge-3-colouring if and only if  $H$  admits an ios-injective  $T_4$ -colouring

Since the construction of  $H$  can be carried out in polynomial time, ios-injective  $T_4$ -colouring is NP-complete  $\square$

We give a similar argument for  $T_5$  (see Figure 3). The transformation is from ios-injective  $C_3$ -colouring [4]. We construct an oriented graph  $H$  from a graph  $G$  so that  $G$  admits an ios-injective homomorphism to  $C_3$  if and only if  $H$  admits an ios-injective homomorphism to  $T_5$ . The key ingredient in this construction is the oriented graph  $J_v$ , given in Figure 8.



Therefore vertex 0 in  $J_{v_1}$  is coloured  $a$ . Repeating this argument, we conclude that vertices 4, 8, 12 and 16 in  $J_{v_2}$  receive colours  $c, e, b$  and  $d$ , respectively. Continuing in this fashion gives that in an oriented ios-injective  $T_5$  colouring of  $J_n$  each of the vertices labeled 0 (respectively, 4, 8, 12 and 16) receive the same colour.  $\square$

**Theorem 3.5.** *The problem of deciding whether a given oriented graph  $G$  has an ios-injective  $T_5$ -colouring is NP-complete.*

*Proof.* The transformation is from ios-injective  $C_3$ -colouring. By [4], ios-injective  $C_3$ -colouring is NP-complete.

Let  $G$  be a graph with vertex set  $\{v_0, v_1, \dots, v_{|V(G)|-1}\}$ . Let  $\nu_G = |V(G)|$ . We construct  $J$  from  $G$  by first adding a copy of  $J_{\nu_G}$  to  $G$  and then, for each  $1 \leq i \leq \nu_G$ , adding an arc from vertex 11 in  $J_{v_i}$  to  $v_i$ .

We show that  $J$  has an ios-injective  $T_5$ -colouring if and only if  $G$  has an ios-injective  $C_3$ -colouring.

Consider an ios-injective  $T_5$ -colouring of  $J$ . Since  $T_5$  is vertex-transitive we can assume without loss of generality that the vertex 8 in each copy of  $J_v$  is coloured  $a$ . Therefore in each  $J_{v_i}$ , vertices 9, 10 and 11 are coloured, in some order, with colours  $a, b, c$ ; and vertex 12 is coloured  $c$ .

We claim that  $v_i$  is coloured with  $b, d$  or  $e$  for all  $0 \leq i \leq \nu_G - 1$ . If  $v_i$  has colour  $a$ , then vertex 12 in  $J_{v_i}$  has both an in-neighbour and an out-neighbour coloured  $a$ . Therefore vertex 12 has colour  $a$ . This contradicts that vertex 12 has colour  $c$ . If  $v_i$  has colour  $c$ , then vertex 11 in  $J_{v_i}$  has two out-neighbours coloured  $c$ , a violation of the injectivity requirement. Therefore  $v_i$  is coloured with one of  $b, d$  or  $e$  for each  $0 \leq i \leq \nu_G - 1$ . Since vertices  $b, d$  and  $e$  of  $T_5$  induce a copy of  $C_3$  in  $T_5$ , restricting an ios-injective  $T_5$ -colouring of  $J$  to the vertices of  $G$  yields an ios-injective  $C_3$ -colouring of  $G$ .

Let  $\beta$  be an ios-injective  $C_3$ -colouring of  $G$  using colours  $b, c$  and  $d$ . We extend such a colouring to be an ios-injective  $T_5$ -colouring of  $J$  as follows. For each copy of  $J_v$ , let

- $\beta(0) = \beta(19) = b$ ;
- $\beta(4) = d$ ;
- $\beta(8) = \beta(18) = a$ ;
- $\beta(12) = c$ ; and
- $\beta(16) = \beta(17) = e$

The remaining vertices in each  $J_{v_i}$  are assigned colours based upon  $\beta(v_i)$  as shown in Figure 9.

Therefore  $J$  has an ios-injective  $T_5$ -colouring if and only if  $G$  has an ios-injective  $C_3$ -colouring. Since  $J$  can be constructed in polynomial time, ios-injective  $T_5$ -colouring is NP-complete.  $\square$

We now present a reduction to instances of ios-injective  $T$ -colouring for when  $T$  has a vertex  $v$  of out-degree at least four. This reduction allows us to polynomially transform an instance of ios-injective  $T$ -colouring to an instance of ios-injective  $T'$ -colouring, where  $T'$  is  $T_4, T_5, C_3$  or  $TT_3$ .

**Lemma 3.6.** *If  $T$  is a reflexive tournament on  $n$  vertices with a vertex of out-degree at least four, then there exists a reflexive tournament  $T'$  on at least three vertices that has strictly fewer vertices than  $T$  so that ios-injective homomorphism to  $T'$  polynomially transforms to ios-injective homomorphism to  $T$ .*

*Proof.* Let  $T$  be a reflexive tournament on  $n$  vertices so that  $T$  has a vertex, say  $v$ , of out-degree at least 4. Let  $G$  be an oriented graph with vertex set  $\{w_0, w_1, \dots, w_{|V(G)|-1}\}$ . Let  $\nu_G = |V(G)|$ . We construct  $H$  from  $G$  by adding to  $G$

- vertices  $x_0, x_1, \dots, x_{\nu_G-1}$ .
- an arc from  $x_i$  to  $w_i$  for all  $0 \leq i \leq \nu_G - 1$ .
- $\nu_G$  irreflexive copies of  $T$ , labeled  $T_i$ , for  $0 \leq i \leq \nu_G - 1$ .



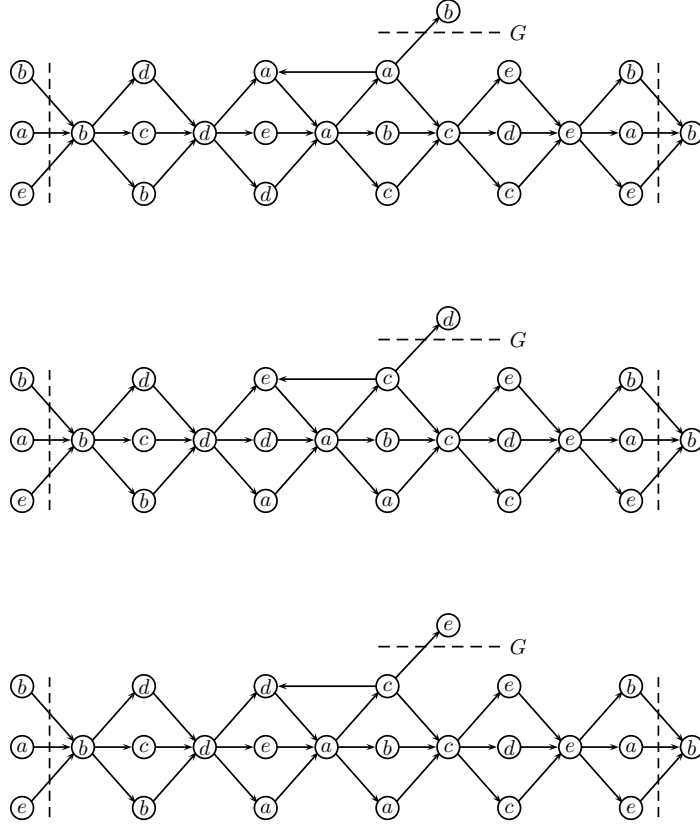

FIGURE 9. Colouring the vertices of  $J_{v_i}$  using the colour of  $v_i$ .

Let  $v_i \in T_i$  be the vertex corresponding to  $v \in V(T)$ . We complete our construction by adding arcs so that  $x_{i-1 \pmod{\nu_G}}, v_i$  and  $x_i$  induce a directed path of length two. See Figure 10.

*Claim 1:* In an ios-injective  $T$ -colouring of  $H$  no two vertices of  $T_i$  have the same colour. Since  $T$  has a vertex of out-degree at least 4 we observe that  $T$  has at least 4 vertices. In an ios-injective colouring, a vertex cannot have three vertices of the same colour in its neighbourhood. Let  $\phi$  be an ios-injective  $T$ -colouring of  $H$ . Since there is an arc between every pair of vertices in  $T_i$ , no three vertices of  $T_i$  receive the same colour under  $\phi$ . Since  $T_i$  has at least four vertices, there exists  $x, y \in T_i$  so that  $\phi(x) \neq \phi(y)$ . Without loss of generality assume that the arc between  $x$  and  $y$  in  $T_i$  has its head at  $y$ . Consider some vertex  $z \in T_i$ . Since  $T_i$  is a tournament, there is an arc, in some direction between  $x$  and  $z$  and one between  $y$  and  $z$ . We claim that  $\phi(z) \neq \phi(x)$  and  $\phi(z) \neq \phi(y)$ . We proceed based on the direction of the arc between  $x$  and  $z$  and the arc between  $y$  and  $z$ .

*Case I:*  $z$  is an out-neighbour of both  $x$  and  $y$ . If  $\phi(x) = \phi(z)$ , then  $x$  has two out-neighbours coloured  $\phi(x)$ , a violation of injectivity. If  $\phi(y) = \phi(z)$ , then  $\phi(x)\phi(y) \in E(T)$  and  $\phi(y)\phi(z) \in E(T)$ . This contradicts that  $T$  is a tournament.

*Case II:*  $z$  is an in-neighbour of  $x$  and an out-neighbour of  $y$ . If  $\phi(x) = \phi(z)$ , then  $\phi(x)\phi(y) \in E(T)$  and  $\phi(z)\phi(x) \in E(T)$ . This contradicts that  $T$  is a tournament. If  $\phi(y) = \phi(z)$ , then  $\phi(x)\phi(y) \in E(T)$  and  $\phi(y)\phi(z) \in E(T)$ . This contradicts that  $T$  is a tournament.

The remaining cases follow similarly to Case I or Case II. Therefore every vertex in  $T_i$  receives a distinct colour.

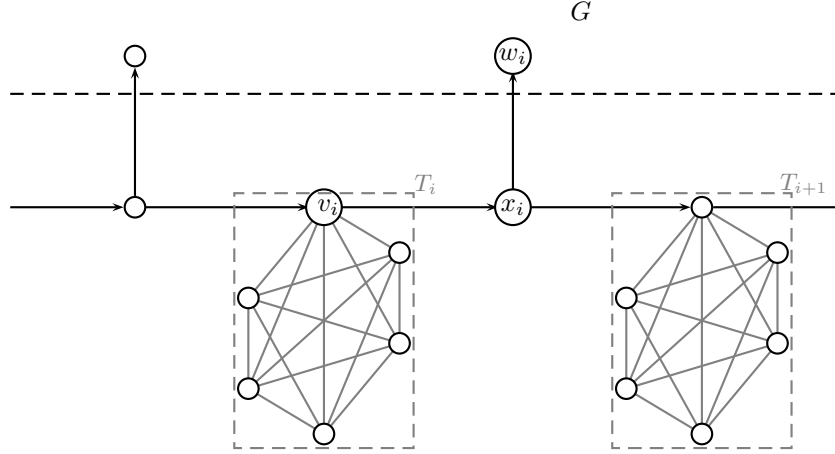

FIGURE 10. The construction of  $H$  in Lemma 3.6.

*Claim 2: In an ios-injective  $T$ -colouring of  $H$  every vertex in the set*

$$\{x_0, x_1, \dots, x_{\nu_G-1}\} \cup \{v_0, v_1, \dots, v_{\nu_G-1}\}$$

*is coloured  $v$ .* By the previous claim all the colours of  $T$  are used exactly once in each  $T_i$ . Therefore the only possible colour for an out-neighbour or an in-neighbour of  $v_i$  is  $\phi(v_i)$ . Therefore for each  $i$ , we have  $\phi(v_i) = \phi(x_i) = \phi(x_{i+1 \pmod{\nu_G}})$ . Therefore every vertex in the set  $\{x_0, x_1, \dots, x_{\nu_G-1}\} \cup \{v_0, v_1, \dots, v_{\nu_G-1}\}$  receives the same colour. Since each vertex in  $T_i$  maps to a unique vertex in  $T$ , if  $\phi(v_i) \neq v$  then there is an automorphism of  $T$  that maps  $\phi(v_i)$  to  $v$ . As such, we may assume without loss of generality that  $\phi(v_i) = v$  for all  $0 \leq i \leq \nu_G - 1$ .

Let  $T'$  be the reflexive tournament induced by the strict out-neighbourhood of  $v$  in  $T$ . Note that  $T'$  is a reflexive tournament on at least 3 vertices and  $T'$  is a proper subgraph of  $T$ .

We show that  $H$  has an ios-injective  $T$ -colouring if and only if  $G$  has an ios-injective  $T'$ -colouring.

Let  $\phi$  be an ios-injective  $T$ -colouring of  $H$ . By our previous claim, each  $x_i$  has an in-neighbour and an out-neighbour with colour  $v$ , namely  $v_i \in V(T_i)$  and  $v_{i-1} \in V(T_{i-1})$ . Therefore  $\phi(w_i)$  is an out-neighbour of  $v$  in  $T$ . That is,  $\phi(w_i) \in V(T')$ . Therefore the restriction of  $\phi$  to the vertices of  $G$  yields an ios-injective  $T'$ -colouring of  $G$ .

Let  $\beta$  be an ios-injective  $T'$ -colouring of  $G$ . For all  $0 \leq i \leq \nu_G - 1$  and all  $u \in V(T)$ . Let  $u_i \in V(T_i)$  be the vertex corresponding to  $u \in V(T)$ .

We extend  $\beta$  to be an ios-injective  $T$ -colouring of  $H$  as follows:

- $\beta(x_i) = \beta(v_i) = v$  for all  $0 \leq i \leq \nu_G - 1$ ; and
- for all  $u_i \in T_i$ , let  $\beta(u_i) = u$ .

Hence, ios-injective  $T'$ -colouring can be polynomially transformed to ios-injective  $T$ -colouring.  $\square$

If a reflexive tournament  $T$  has no vertex of out-degree at least 4, but has a vertex of in-degree at least 4, a similar argument holds. We modify the construction by reversing the arc between  $x_i$  and  $w_i$  in the construction of  $H$ .

**Theorem 3.7.** *Let  $T$  be a reflexive tournament. If  $T$  has at least 3 vertices, then the problem of deciding whether a given oriented graph  $G$  has an ios-injective homomorphism to  $T$  is NP-complete. If  $T$  has 1 or 2 vertices, then the problem is Polynomial.*

*Proof.* If  $T$  is a reflexive tournament on no more than three vertices, the result follows by Theorem 2.2. Suppose then that  $T$  has four or more vertices. If  $T = T_4$ , or if  $T = T_5$ , then the result follows from Theorem 3.3 or Theorem 3.5. Tournaments  $T_4$  and  $T_5$  respectively are the only tournaments on 4 and 5 vertices respectively with no vertex of out-degree 4. Since the average out-degree of a reflexive tournament on  $n > 5$  vertices is  $\frac{n-1}{2} + 1 > 3$ , every reflexive tournament on at least six vertices has a vertex with out-degree at least 4. Therefore if  $T$  has at least four vertices,  $T \neq T_4$  and  $T \neq T_5$ , then  $T$  has a vertex with either in-degree or out-degree at least 4. By repeated application of Lemma 3.6 an instance of ios-injective homomorphism to  $T$  polynomially transforms to instance of either ios-injective homomorphism to  $T_4$ ; ios-injective homomorphism to  $T_5$  or ios-injective homomorphism to a target on 3 vertices.  $\square$

#### 4. IOT-INJECTIVE HOMOMORPHISMS

In this section we prove a dichotomy theorem for iot-injective  $T$ -colouring, where  $T$  is a reflexive tournament. We employ similar methods as in Section 3. We first show that both iot-injective  $T_4$ -colouring and iot-injective  $T_5$ -colouring are NP-complete. We then provide a reduction to instances of iot-injective  $T$ -colouring to either iot-injective  $T_4$ -colouring; iot-injective  $T_5$ -colouring; or a case covered by Theorem 2.2. Combining these results yields the desired dichotomy theorem.

We begin with a study of iot-injective  $T_4$ -colouring. To show iot-injective  $T_4$ -colouring is NP-complete we provide a transformation from edge 3-colouring. We construct an oriented graph  $F$  from a graph  $G$  so that  $G$  has an edge-3-colouring if and only if  $F$  admits an iot-injective homomorphism to  $T_4$ . The key ingredients in this construction are a pair of oriented graphs;  $F_x$  and  $F_e$  given in Figures 11 and 12, respectively.

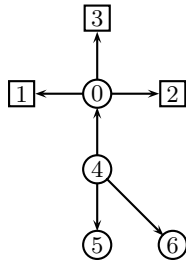

FIGURE 11.  $F_x$

**Lemma 4.1.** *In any iot-injective  $T_4$ -colouring of  $F_x$ , vertex 0 is coloured  $b$  and vertex 4 is coloured  $a$ .*

*Proof.* Consider some iot-injective  $T_4$ -colouring of  $F$ . Vertex 0 of  $F_x$  has out-degree 3. Since each vertex of  $T_4$  has at most three out-neighbours (including itself), vertex 0 must have the same colour as one of its out-neighbours. To satisfy the injectivity constraint, if a colour appears on an out-neighbour of vertex 0, that colour cannot appear on an in-neighbour of vertex 0. Therefore vertex 4 does not have the same colour as vertex 0. Both vertices 4 and 0 have out-degree 3, and there is an arc from 4 to 0. Vertex  $a$  in  $T_4$  is the only vertex to have out-degree 3 and have a strict out-neighbour with out-degree 3. Therefore vertex 4 is coloured  $a$  and vertex 0 is coloured  $b$ .  $\square$

**Lemma 4.2.** *In any iot-injective  $T_4$ -colouring of  $F_e$ , vertex 7 is coloured  $a$  and vertex 9 is coloured  $b$ .*

This proof of this lemma follows similarly to the proof of Lemma 4.1. As such, it is omitted.

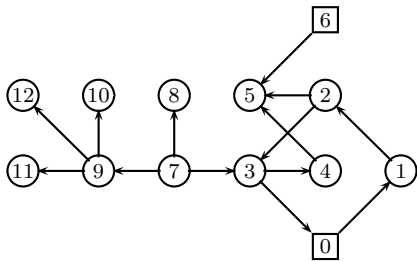

FIGURE 12.  $F_e$

**Lemma 4.3.** *Let  $F'_e$  be the oriented graph formed from a copy of  $F_e$  and two copies of  $F_x$  by identifying vertex 0 in the copy of  $F_e$  with any square vertex in one copy of  $F_x$  and identifying vertex 6 in the copy of  $F_e$  with any square vertex in the second copy of  $F_x$ . In any iot-injective  $T_4$ -colouring of  $F'_e$ , the vertices 0 and 6 in the subgraph induced by  $F_e$  have the same colour.*

*Proof.* Let  $F'_e$  be constructed as described. Consider an iot-injective  $T_4$ -colouring of  $F'_e$ . We examine the colours of the vertices in the subgraph induced by the copy of  $F_e$ . By Lemma 4.1 and the construction of  $F'_e$ , vertices 0 and 6 in  $F_e$  have an in-neighbour coloured  $b$  – vertex 0 in a copy of  $F_x$ . Since  $a$  is not an in-neighbour of  $b$  in  $T_4$ , vertex 0 in the copy of  $F_e$  cannot be coloured  $a$ . We proceed in cases based on the possible colour of vertex 0 in copy of  $F_e$ .

*Case I: Vertex 0 is coloured  $b$ .* Since the vertex 0 already has a neighbour coloured  $b$  (vertex 0 in a copy of  $F_x$ ), vertex 3, an in-neighbour of vertex 0 in  $F_e$ , cannot be coloured  $b$ . Since  $b \in V(T_4)$  has only  $a$  and  $b$  as in-neighbours, we have that vertex 3 is coloured  $a$ . By Lemma 4.2 vertex 3 has a neighbour coloured  $a$  – namely vertex 7. By the injectivity constraint, this colour cannot appear on any other neighbour of vertex 3. As such, vertices 2 and 4 are coloured  $d$  and  $c$  respectively. The only common out-neighbour of  $d$  and  $c$  in  $T_4$  is  $d$ . Therefore vertex 5 is has colour  $d$ . In  $T_4$  vertex  $d$  has three in-neighbours –  $b, c, d$ . Since  $c$  and  $d$  both appear on an in-neighbour of vertex 5, we have that vertex 6 is coloured with  $b$ .

*Case II: Vertex 0 is coloured  $c$ .* Vertex  $c$  in  $T_4$  has two in-neighbours:  $a$  and  $c$ . Therefore vertex 3 in  $F_e$  must have one of these colours.

Assume vertex 3 is coloured  $c$ . In this case, the injectivity constraint implies that vertex 1 is not coloured  $c$ . Since  $c$  and  $d$  are the only out-neighbours of  $c$  in  $T_4$ , vertex 1 must be coloured  $d$ . Vertex 2, an in-neighbour of vertex 3, is coloured with one of  $a, b$  or  $c$ , the in-neighbours of  $c$  in  $T_4$ . By Lemma 4.2 vertex 3 has a neighbour coloured  $a$  – vertex 7. By assumption vertex 0 has colour  $c$ . Therefore by injectivity, vertex 2 has colour  $b$ . This is a contradiction, as the arc between vertex 1 and vertex 2 does not have the same direction as the arc between vertex  $c$  and vertex  $b$  in  $T_4$ . Therefore vertex 3 is coloured  $a$ .

In  $T_4$ , the in-neighbours of  $a$  are  $a$  and  $d$ , and the out-neighbours of  $a$  are  $a, b$  and  $c$ . Since vertex 7 is coloured  $a$ , no other neighbour of vertex 3 can be coloured  $a$ . Therefore vertex 2, an in-neighbour of vertex 3, must have colour  $d$ . Since vertex 0 is coloured  $c$ , vertex 4, an out-neighbour of vertex 3 must have colour  $b$ . Vertex 5, a common in-neighbour of vertices 2 and 4, must be coloured with a common in-neighbour of  $d$  and  $b$  in  $T_4$ . The only such vertex in  $T_4$  is  $d$ . Therefore vertex 5 has colour  $d$ .

Vertex  $d$  in  $T_4$  has three in-neighbours:  $b$ ,  $c$  and  $d$ . These three colours must appear on the in-neighbours of vertex 5. Since vertex 2 is coloured  $d$  and vertex 4 is coloured  $b$ , we have that vertex 6 is coloured  $c$ , as required.

*Case III: Vertex 0 is coloured  $d$ .* Recall by Lemma 4.2 that vertex 3 has a neighbour coloured  $a$  – vertex 7. Since vertex 0 is coloured  $d$ , vertex 3 is coloured with a vertex that is an out-neighbour of  $a$  and an in-neighbour of  $d$  in  $T_4$ . The only such vertices are  $b$  and  $c$ . However, vertex 0 has a neighbour coloured  $b$  (vertex 0 in a copy of  $F_x$ ). Therefore vertex 3 has colour  $c$ . Vertex 4 must have a colour that is an out-neighbour of  $c$  in  $T_4$ . The only such colours are  $c$  and  $d$ . Since vertex 0, an out-neighbour of vertex 3, is coloured  $d$ , we have that vertex 4 has colour  $c$ . Vertex 2 must have a colour that is an in-neighbour of  $c$  in  $T_4$ . The only such colours are  $a, b$  and  $c$ . Vertex 7, an in-neighbour of vertex 3, has colour  $c$ . Vertex 4, a neighbour of vertex 3, has colour  $c$ . Therefore by injectivity vertex 2 has colour  $b$ . Vertex 5 must be coloured with a common out-neighbour of  $b$  and  $c$  in  $T_4$ . The only such colours are  $c$  and  $d$ . Since vertex 3, an out-neighbour of vertex 2, has colour  $c$ , we have by injectivity that vertex 5 has colour  $d$ . The in-neighbours of vertex 5 must be coloured with the in-neighbours of  $d$  in  $T_4$ . Vertex  $d$  has three in-neighbours in  $T_4$  –  $b, c$  and  $d$ . Since vertex 2 has colour  $b$  and vertex 4 has colour  $c$ , we have by injectivity that vertex 6 has colour  $d$ .  $\square$

**Theorem 4.4.** *The problem of iot-injective  $T_4$ -colouring is NP-complete.*

*Proof.* The transformation is from edge 3-colouring. Recall that edge 3-colouring is NP-complete even when restricted to subcubic graphs [16].

Let  $G$  be a graph with maximum degree at most 3 and let  $\tilde{G}$  be an arbitrary orientation of  $G$ . We create an oriented graph  $F$  from  $\tilde{G}$  as follows. For every  $v \in V(G)$  we add  $F_v$ , a copy of the oriented graph given in Figure 11, to  $F$ . For every arc  $uv \in E(\tilde{G})$  we add  $F_{uv}$ , a copy of the oriented graph given in Figure 12, to  $F$ . To complete the construction of  $F$ , for each arc  $uv \in E(\tilde{G})$  we identify the vertex 0 in  $F_{uv}$  with one of the three square vertices (i.e., vertices 1, 2, or 3) in  $F_u$  and identify the vertex 6 in  $F_{uv}$  with one of the three square vertices in  $F_v$ . We identify these vertices in such a way that each square vertex in a copy of  $F_x$  is identified with at most one square vertex from a copy of  $F_e$ . We note that this is always possible as vertices in  $G$  have degree at most three.

We claim that  $G$  has an edge 3-colouring if and only if  $F$  has an iot-injective  $T_4$ -colouring.

Suppose an iot-injective  $T_4$ -colouring of  $F$  is given. This iot-injective  $T_4$ -colouring induces an edge-3-colouring of  $G$ : the colour of an edge in  $uv \in E(G)$  is given by colour of vertices 0 and 6 in corresponding copy of  $F_{uv}$  contained in  $F$ . By Lemma 4.3 this colour is well-defined. Recall that for each copy of  $F_x$ , the vertices 1, 2 and 3 are respectively each identified with either vertex 0 or vertex 6 in some copy of  $F_e$ . By Lemma 4.1, vertices 1, 2 and 3 in a copy of  $F_x$  cannot be coloured  $a$ . By injectivity, vertices 1, 2 and 3 in a copy of  $F_x$  all are assigned different colours. Therefore each of the edges incident with any vertex receive different colours and no more than 3 colours, namely  $b, c$ , and  $d$ , are used on the edges of  $G$ . Therefore  $G$  has an edge 3-colouring.

Suppose a 3-colouring of  $G$ ,  $f : E(G) \rightarrow \{b, c, d\}$  is given. For each  $uv \in E(G)$  we colour  $F_{uv}$  using one of the iot-injective  $T_4$ -colourings given in Figure 14. We choose the colouring of each of  $F_{uv}$  so that vertices 0 and 6 are assigned the same colour as  $uv$  by  $f$ . To complete the proof, we show that such colouring can be extended to all copies of  $F_x$  contained in  $F$ .

Recall that for each copy of  $F_x$ , the vertices 1, 2 and 3 are respectively each identified with either vertex 0 or vertex 6 in some copy of  $F_e$ . Since  $f$  is a edge 3-colouring of  $G$ , for each  $x \in V(G)$ , each of the vertices 1, 2 and 3 in  $F_x$  are coloured with distinct colours from the set  $\{b, c, d\}$  when we colour each copy of  $F_e$  using Figure 14.

Observe that for any 2-element subset,  $\{u_1, u_2\} \subset \{1, 2, 3\}$  there is an automorphism of  $F_x$  that swaps vertices  $u_1$  and  $u_2$  and fixes the remaining vertex in  $\{1, 2, 3\} \setminus \{u_1, u_2\}$ . As such we may assume, without loss of generality, that vertices 1, 2 and 3 are respectively coloured  $b, c$  and  $d$  in

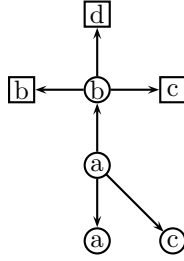

FIGURE 13. Colouring  $F_x$ .

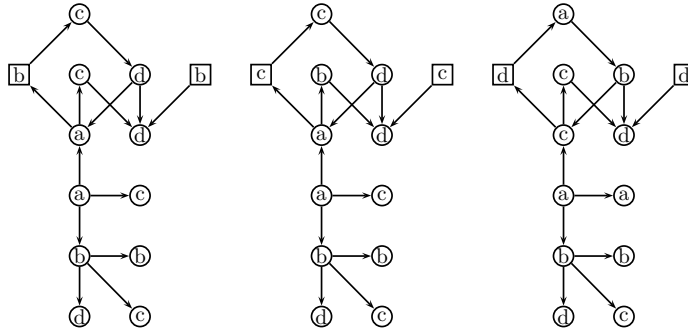

FIGURE 14. Colouring the  $F_e$  for associated edge colours of  $b$ ,  $c$ , and  $d$ .

each copy of  $F_x$ . The iot-injective  $T_4$ -colouring given in Figure 13 extends a pre-colouring of the vertices 1, 2 and 3 with colours  $b$ ,  $c$ , and  $d$ , respectively, to an iot-injective  $T_4$ -colouring of  $F_x$ . Therefore  $F$  has an iot-injective  $T_4$ -colouring.

Since the construction of  $F$  can be carried out in polynomial time, iot-injective  $T_4$ -colouring is NP-complete.  $\square$

We provide a similar argument for iot-injective  $T_5$ -colouring. The transformation is from iot-injective  $C_3$ -colouring [4]. We construct an oriented graph  $D$  from a graph  $G$  so that  $G$  admits an iot-injective homomorphism to  $C_3$  if and only if  $D$  admits an iot-injective homomorphism to  $T_5$ . The key ingredient in the construction is the oriented graph,  $D_v$ , given in Figure 15.

For each  $n > 0$  let  $D_n$  be the oriented graph constructed from  $n$  disjoint copies of  $D_v$ , say  $D_{v_0}, D_{v_1}, \dots, D_{v_{n-1}}$ , by letting vertex 8 of  $D_{v_i}$  be an in-neighbour of vertex 0 in  $D_{v_{i+1} \pmod n}$  for all  $0 \leq i \leq n - 1$ .

**Lemma 4.5.** *For any positive integer  $n$ , in an oriented iot-injective  $T_5$ -colouring of  $D_n$  each of the vertices labeled 0 receive the same colour.*

*Proof.* Since  $T_5$  is vertex-transitive, assume without loss of generality that vertex 0 in  $D_{v_0}$  receives colour  $d$  in some iot-injective  $T_5$ -colouring of  $D_n$ . Observe that vertex 4 has three out-neighbours. Since each vertex of  $T_5$  has at most three out-neighbours (including itself), vertex 4 must have the same colour as one of its out-neighbours. To satisfy the injectivity constraint, no in-neighbour of vertex 4 has the same colour as vertex 4. Further, vertex 4 has two in-neighbours, vertices 1 and 2,

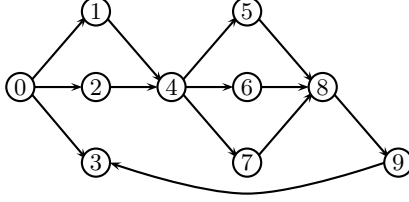

FIGURE 15.  $D_v$

that are out-neighbours of a vertex coloured  $d$ . Only vertices  $a$  and  $b$  in  $T_5$  have two in-neighbours that are out-neighbours of  $d$ . Therefore vertex 4 has colour  $a$  or  $b$ .

If vertex 4 has colour  $b$ , then vertices 1 and 2 are coloured with the vertices of  $T_5$  that are out-neighbours of  $d$  and in-neighbours of  $b$ . The only such vertices in  $T_5$  that satisfy these criteria are  $a$  and  $e$ . Therefore vertices 1 and 2 are coloured with  $a$  and  $b$ , in some order. Vertex  $d$  has three out-neighbours in  $T_5 - a, b$  and  $d$ . Since vertices 1 and 2 are coloured with  $a$  and  $b$ , in some order, the third out-neighbour of vertex 0, vertex 3, is coloured with  $d$ . Vertex  $b$  in  $T_5$  has three out-neighbours -  $b, c$  and  $d$ . Therefore the out-neighbours of vertex 4, vertices 5, 6 and 7, are coloured, in some order, with these colours. Vertices  $b, c$  and  $d$  in  $T_5$  have only  $d$  as a common out-neighbour. Therefore the common out-neighbour of vertices 5, 6 and 7, vertex 8, is coloured  $d$ . This is a contradiction, as now vertex 9 has two vertices coloured 8 in its neighbourhood. Therefore vertex 4 has colour  $a$ .

Vertex  $a$  in  $T_5$  has three out-neighbours -  $a, b$  and  $c$ . Thus the out-neighbours of vertex 4 are coloured with  $a, b$  and  $c$ , in some order. The only common out-neighbour of  $a, b$  and  $c$  in  $T_5$  is  $c$ . Therefore vertex 8 has colour  $c$ . This implies that vertex 9 in  $D_{v_0}$  and 0 in  $D_{v_1}$  have colours from the set  $\{c, d, e\}$ , the out-neighbours of  $c$  in  $T_5$ . Since vertex 8 has a neighbour coloured  $c$ , neither vertex 0 in  $D_{v_1}$  nor 9 (in  $D_{v_0}$ ) can have this colour. Further, since vertex 3 has a neighbour coloured  $d$ , vertex 9 has cannot be coloured  $d$ . Thus vertex 9 in  $D_{v_0}$  has colour  $e$  and vertex 0 in  $D_{v_1}$  has colour  $d$ .

Repeating this argument implies that every vertex labeled 0 has colour  $d$ . □

**Theorem 4.6.** *The problem of iot-injective  $T_5$ -colouring is NP-complete.*

*Proof.* The transformation is from iot-injective  $C_3$ -colouring. By [4], iot-injective  $C_3$  colouring is NP-complete.

Let  $G$  be an oriented graph with vertex set  $\{v_0, v_1, \dots, v_{|V(G)|-1}\}$ . Let  $\nu_G = |V(G)|$ . We construct  $D$  from  $G$  by first adding a copy of  $D_{\nu_G}$  to  $G$  and then, for each  $1 \leq i \leq \nu_G$ , adding an arc from vertex 5 in  $D_{v_i}$  to  $v_i$ .

We show that  $D$  has an iot-injective  $T_5$ -colouring if and only if  $G$  has an iot-injective  $C_3$ -colouring.

Consider  $\phi$ , an iot-injective  $T_5$ -colouring of  $D$ . Since  $T_5$  is vertex-transitive we may assume that vertex 0 in  $D_{v_0}$  has colour  $d$ . By Lemma 4.5, for all  $0 \leq i \leq \nu_G - 1$ , the vertex in  $D_{v_i}$  labeled 0 has colour  $d$ . Further, by the argument in the proof of Lemma 4.5, we conclude for all  $0 \leq i \leq \nu_G - 1$ ,

that the vertex in  $D_{v_i}$  labeled 4 has colour  $a$  and the vertex labeled 8 has colour  $c$ . By the injectivity requirement, the neighbours of the vertex labeled 5 in each copy of  $D_v$  have distinct colours. Since the vertices 4 and 8 have colours  $a$  and  $c$ , respectively, only colours  $b, c$  or  $d$  can appear at  $v_i$ , for all  $0 \leq i \leq \nu_G - 1$ . Since  $b, c, d$  induce a copy of  $C_3$  in  $T_5$ , we conclude that the restriction of  $\phi$  to the vertices of  $G$  is indeed an iot-injective  $C_3$ -colouring.

Let  $\beta$  be an iot-injective  $C_3$ -colouring of  $G$  using colours  $b, c$  and  $d$ . We extend such a colouring to be an iot-injective  $T_5$ -colouring of  $D$  as follows.

For each copy of  $D_v$ , let

- $\beta(0) = \beta(1) = d$ ;
- $\beta(2) = \beta(9) = e$ ;
- $\beta(3) = \beta(4) = a$ ;
- $\beta(6) = b$ ; and
- $\beta(8) = c$

The remaining vertices in each  $D_{v_i}$  are assigned colours based upon  $\beta(v_i)$  as in Figure 16.

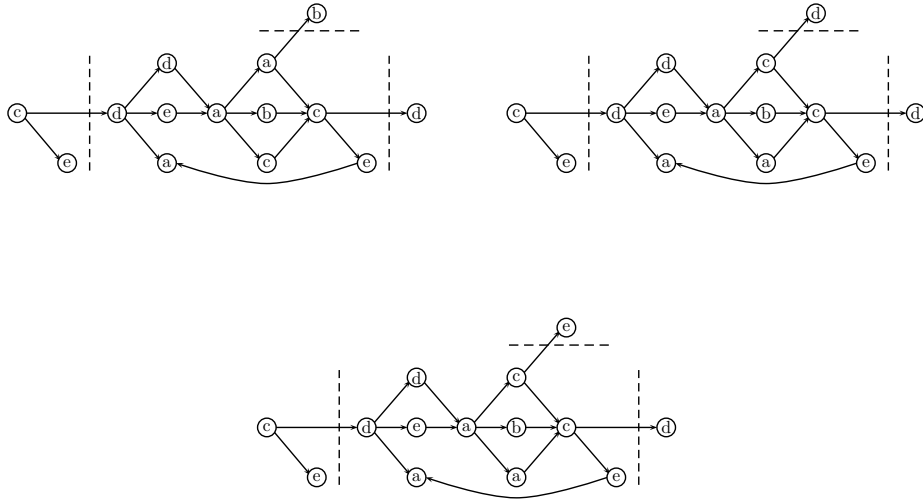

FIGURE 16. Colouring the vertices of  $D_{v_i}$  using the colour of  $v_i$ .

Therefore  $D$  has an iot-injective  $T_5$ -colouring if and only if  $G$  has an iot-injective  $C_3$ -colouring. As  $D$  can be constructed in polynomial time, iot-injective  $T_5$ -colouring is NP-complete.  $\square$

We now present a reduction to instances of iot-injective  $T$ -colouring for when  $T$  has a vertex  $v$  of out-degree at least four. This reduction allows us to polynomially transform an instance of iot-injective  $T$ -colouring to an instance of iot-injective  $T'$ -colouring, where  $T'$  is  $T_4$ ,  $T_5$ ,  $C_3$  or  $TT_3$ .

**Lemma 4.7.** *If  $T$  is a reflexive tournament on  $n$  vertices with a vertex of out-degree four or more, then there exists a reflexive tournament  $T'$  on at least three vertices that has strictly fewer vertices than  $T$  so that iot-injective homomorphism to  $T'$  polynomially transforms to iot-injective homomorphism to  $T$ .*

*Proof.* Let  $T$  be a reflexive tournament on  $n$  vertices with a fixed vertex  $v$  of out-degree four or more. Let  $T^*$  be the graph obtained by removing from  $T$  all the arcs with their tail at  $v$ .



Let  $G$  be an oriented graph with vertex set  $\{w_0, w_1, \dots, w_{|V(G)|-1}\}$ . Let  $\nu_G = |V(G)|$ . We construct  $C$  from  $G$  by adding to  $G$

- $\nu_G$  disjoint irreflexive copies of  $T : T_0, T_1, \dots, T_{\nu_G-1}$ ;
- $\nu_G$  disjoint irreflexive copies of  $T^* : T_0^*, T_1^*, \dots, T_{\nu_G-1}^*$ ;
- and for all  $u \in V(T)$  where  $u \neq v$ , an arc from the vertex corresponding to  $u$  in  $T_{i-1}^*$  to the vertex corresponding to  $u$  in  $T_i$ , for all  $0 \leq i \leq \nu_G - 1$

Let  $v_i$  and  $v_i^*$  be the vertices corresponding to  $v$  in  $T_i$  and  $T_i^*$ , respectively. We complete the construction of  $C$  by adding an arc from  $v_i$  to  $v_i^*$  for all  $0 \leq i \leq \nu_G - 1$ . See Figure 17

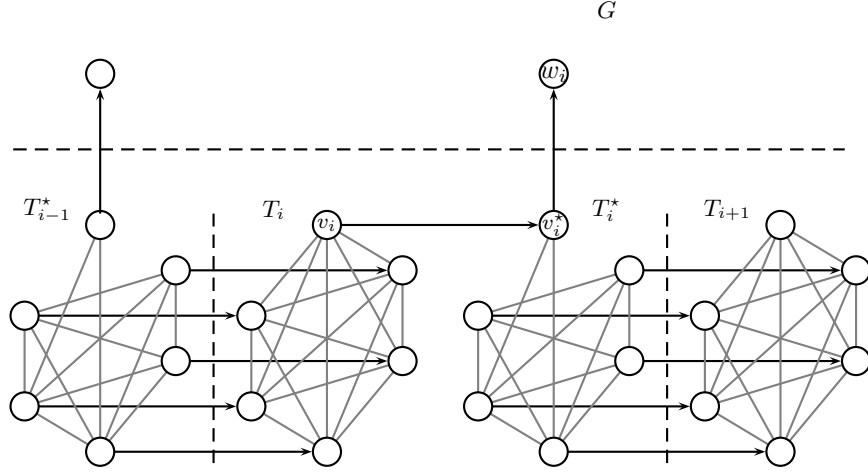

FIGURE 17. The construction of  $C$  in Lemma 4.7.

*Claim 1:* In an iot-injective  $T$ -colouring of  $C$ ,  $v_i$  and  $v_i^*$  have the same colour. Since  $v_i$  has  $n$  neighbours, in any iot-injective  $T$ -colouring of  $C$ ,  $v_i$  is assigned the same colour as one of its neighbours. If two vertices of  $T_i$  are assigned the same colour, then a common neighbour of such vertices in  $T_i$  has a pair of neighbours with the same colour. This is a violation of the injectivity requirement. Therefore no two vertices of  $T_i$  are assigned the same colour. As such the neighbour of  $v_i$  that has the same colour as  $v_i$  must be  $v_i^*$ .

*Claim 2:* In an iot-injective  $T$ -colouring of  $C$ ,  $v_i$  and  $v_{i+1}$  have the same colour. We show that  $v_{i+1}$  has the same colour as  $v_i^*$ . The result then follows from the previous claim. We proceed based on the out-degree of  $v$  in  $T$ . If  $v$  has out-degree  $n$  in  $T$ , then by construction  $v_i$  has out-degree  $n$  in  $T_i$  and  $v_{i+1}$  has out-degree  $n$  in  $T_{i+1}$ . By the argument in the previous claim, each vertex in  $T_i$  is assigned a distinct colour from  $V(T)$ . Since  $v$  is the only vertex of out-degree  $n$  in  $T$ , it must be that  $v_i$  and  $v_{i+1}$  have colour  $v$ .

Assume now that  $v$  has at least one out-neighbour, say  $y$ , in  $T$ . Let  $y_i$  and  $y_i^*$  be the vertices corresponding to  $y$  in  $T_i$  and  $T_i^*$ , respectively. Observe that  $T_i \setminus \{v_i\}$  is a tournament on  $n - 1$  vertices. By the argument in the previous claim, each vertex in  $T_i \setminus \{v_i\}$  is assigned a distinct colour from  $V(T)$  and this colour is distinct from the one assigned to  $v_i^*$ . In particular,  $v_i^*$  and  $y_i^*$  do not have the same colour. Since every vertex of  $T_i^*$  is adjacent to  $y_i^*$ , no pair of vertices in  $T_i^*$  are assigned the same colour. Consider  $u \in V(T)$  such that  $u \neq v$ . Let  $u_i$  and  $u_i^*$  be the vertices corresponding to  $u$  in  $T_i$  and  $T_i^*$ , respectively. By the injectivity constraint, no pair of vertices in the neighbourhood of  $u_{i+1}$  have the same colour. Since there are  $n$  available colours and  $u_{i+1}$  has  $n - 1$  neighbours in  $T_{i+1}$ , the only possibility for the colour of  $u_{i+1}$  is the colour of  $u_i^*$ . Therefore no

vertex of  $T_{i+1} \setminus \{v_{i+1}\}$  has the same colour as  $v_i^*$ . Since there are  $n$  available colours and  $v_{i+1}$  has  $n - 1$  neighbours,  $v_{i+1}$  has the same colour as  $v_i^*$ . The result now follows from the previous claim.

Let  $T'$  be the reflexive sub-tournament of  $T$  induced by the strict out-neighbourhood of  $v$ . We show  $G$  has an iot-injective  $T'$ -colouring if and only if  $C$  has an iot-injective  $T$ -colouring.

Consider an iot-injective  $T$ -colouring of  $C$ ,  $\phi$ . By the claims above,  $\phi(v_i^*) = \phi(v_i) = \phi(v_j) = \phi(v_j^*)$  for all  $1 \leq i, j \leq \nu_G - 1$ . Since each vertex in  $T_i$  is assigned a distinct colour from  $T$  and  $T \cong T_i$ , if  $\phi(v_i) \neq v$ , then there is an automorphism of  $T$  that maps  $v$  to  $\phi(v_1)$ . As such we may assume, without loss of generality that  $\phi(v_i) = v$  for all  $1 \leq i \leq \nu_G - 1$ . Since  $w_i$  is an out-neighbour of  $v_i^*$  for each  $1 \leq i \leq \nu_G - 1$  we have that  $\phi(w_i)$  is contained in the out-neighbourhood of  $v$  for all  $1 \leq i \leq \nu_G - 1$ . That is,  $\phi(w_i) \in V(T')$  for all  $1 \leq i \leq \nu_G - 1$ . Therefore the restriction of  $\phi$  to  $G$  is an iot-injective homomorphism to  $T'$ .

Consider now an iot-injective  $T'$  colouring of  $G$ ,  $\beta$ . We extend  $\beta$  to be an iot-injective  $T$ -colouring of  $C$  as follows. For each  $z \in V(T)$  let  $z_i$  and  $z_i^*$  be the corresponding vertices in  $T_i$  and  $T_i^*$ , respectively. We extend  $\beta$  so that  $\beta(z_i) = \beta(z_i^*) = z$ . It is easily verified that  $\beta$  is an iot-injective  $T$ -colouring of  $C$ .  $\square$

As following the proof of Theorem 3.6, the construction of  $C$  can be modified for tournaments that have a vertex of in-degree at least 4 to give the corresponding result.

Similar to the case of ios-injective colouring, our results compile to give a dichotomy theorem.

**Theorem 4.8.** *Let  $T$  be a reflexive tournament. If  $T$  has at least 3 vertices, then the problem of deciding whether a given oriented graph  $G$  has an iot-injective homomorphism to  $T$  is NP-complete. If  $T$  has 1 or 2 vertices, then the problem is Polynomial.*

## 5. A NOTE ON IRREFLEXIVE-INJECTIVE HOMOMORPHISMS

No dichotomy theorem has emerged yet for iot-injective homomorphism, and hence ios-injective homomorphism, to irreflexive tournaments. The results of [4, 17] tell us that the problem is not only Polynomial for the irreflexive tournaments on two vertices or less but also for the irreflexive tournaments on three vertices. Preliminary work suggests that the problem is Polynomial on two of the irreflexive tournaments on four vertices but NP-complete on the remaining two, and on many irreflexive tournaments on more vertices (including at least ten of the twelve irreflexive tournaments on five vertices). The problem has not been proven Polynomial on any irreflexive tournament on five vertices or more.

## REFERENCES

- [1] Gaëlle Brevier, Romeo Rizzi, and Stéphane Vialette. Pattern matching in protein-protein interaction graphs. In *Fundamentals of Computation Theory, 16th International Symposium, FCT 2007, Budapest, Hungary, August 27-30, 2007, Proceedings*, pages 137–148, 2007.
- [2] Andrei Bulatov, Peter Jeavons, and Andrei Krokhin. Classifying the complexity of constraints using finite algebras. *SIAM J. Comput.*, 34(3):720–742, 2005.
- [3] Andrei A Bulatov. A dichotomy theorem for nonuniform csps. *arXiv preprint arXiv:1703.03021*, 2017.
- [4] Russell J. Campbell, Nancy E. Clarke, and Gary MacGillivray. Injective homomorphisms to small tournaments. *Unpublished*, 2016.
- [5] Russell J. Campbell, Nancy E. Clarke, and Gary MacGillivray. Obstructions to some injective oriented colourings. *Unpublished*, 2016.
- [6] Min Chen, Gena Hahn, André Raspaud, and Weifan Wang. Some results on the injective chromatic number of graphs. *J. Comb. Optim.*, 24(3):299–318, 2012.
- [7] Alain Doyon, Gena Hahn, and André Raspaud. Some bounds on the injective chromatic number of graphs. *Discrete Mathematics*, 310(3):585–590, 2010.
- [8] Isabelle Fagnot, Gaëlle Lelandais, and Stéphane Vialette. Bounded list injective homomorphism for comparative analysis of protein-protein interaction graphs. *J. Discrete Algorithms*, 6(2):178–191, 2008.

- [9] Guillaume Fertin, Romeo Rizzi, and Stéphane Vialette. Finding exact and maximum occurrences of protein complexes in protein-protein interaction graphs. In *Mathematical Foundations of Computer Science 2005, 30th International Symposium, MFCS 2005, Gdansk, Poland, August 29 - September 2, 2005, Proceedings*, pages 328–339, 2005.
- [10] Jirí Fiala and Jan Kratochvíl. Complexity of partial covers of graphs. In *Algorithms and Computation, 12th International Symposium, ISAAC 2001, Christchurch, New Zealand, December 19-21, 2001, Proceedings*, pages 537–549, 2001.
- [11] Jirí Fiala and Jan Kratochvíl. Partial covers of graphs. *Discussiones Mathematicae Graph Theory*, 22(1):89–99, 2002.
- [12] Jirí Fiala and Jan Kratochvíl. Locally injective graph homomorphism: Lists guarantee dichotomy. In *Graph-Theoretic Concepts in Computer Science, 32nd International Workshop, WG 2006, Bergen, Norway, June 22-24, 2006, Revised Papers*, pages 15–26, 2006.
- [13] Jirí Fiala, Jan Kratochvíl, and Attila Pór. On the computational complexity of partial covers of theta graphs. *Discrete Applied Mathematics*, 156(7):1143–1149, 2008.
- [14] Gena Hahn, Jan Kratochvíl, Jozef Sirán, and Dominique Sotteau. On the injective chromatic number of graphs. *Discrete Mathematics*, 256(1-2):179–192, 2002.
- [15] Pavol Hell and Jaroslav Nešetřil. On the complexity of  $H$ -coloring. *J. Comb. Theory, Ser. B*, 48(1):92–110, 1990.
- [16] Ian Holyer. The NP-completeness of edge-coloring. *SIAM J. Comput.*, 10(4):718–720, 1981.
- [17] Russell J. Campbell. Reflexive injective oriented colourings. *M.Sc. Thesis, Department of mathematics and Statistics, University of Victoria, Canada*, 2009.
- [18] Gary MacGillivray, André Raspaud, and Jacobus Swarts. Obstructions to locally injective oriented improper colourings. *European J. Combin.*, 35:402–412, 2014.
- [19] Gary MacGillivray and Jacobus Swarts. The complexity of locally injective homomorphisms. *Discrete Mathematics*, 310(20):2685–2696, 2010.
- [20] Arash Rafiey, Jeff Kinne, and Tomás Feder. Dichotomy for digraph homomorphism problems. *Unpublished*, 2016.
- [21] Paweł Rzázewski. Exact algorithm for graph homomorphism and locally injective graph homomorphism. *Inf. Process. Lett.*, 114(7):387–391, 2014.
- [22] Dmitriy Zhuk. The proof of csp dichotomy conjecture. *arXiv preprint arXiv:1704.01914*, 2017.