

# V1: A Visual Query Language for Property Graphs

LIOR KOGAN, independent researcher<sup>1</sup>

V1<sup>2</sup> is a declarative visual query language for schema-based property graphs. V1 supports property graphs with mixed (both directed and undirected) edges and half-edges, with enumerated, multivalued and composite properties, and with empty property values. V1 supports temporal data types, operators, and functions, and can be extended to support additional data types, operators, and functions (one spatiotemporal model is presented). V1 is generic, concise, has rich expressive power, and is highly receptive and productive.

---

CCS Concepts: • Information systems → Query representation; • Theory of computation → Database theory → Database query languages (principles); • Information Systems → Data management systems → Database design and models → Graph-based database models

## KEYWORDS

Property Graph, Query Language, Visual Language, Pattern Matching

## 1 INTRODUCTION

The *property graph* is an increasingly popular data model. An important task when dealing with property graphs is pattern matching. Given property graph  $G$  and a query pattern  $P$  expressed in some pattern language  $L$ , *pattern matching* is the process of finding subgraphs of  $G$  that *match*  $P$ . The definition of what is meant by a *match* varies according to  $L$ . Another important task is calculating *non-inherent properties* of vertices, edges, and subgraphs. Non-inherent properties may also be defined and used in pattern expressions, and their values can be reported in query results.

Query languages define syntax and semantics for expressing patterns. Expressive pattern languages combine structural constraints, inherent and non-inherent property values constraints, and usually support path semantics, aggregations, and negations.

Visual query languages have a potential to be much more ‘user-friendly’ than their textual counterparts in the sense that patterns may be constructed and understood much more quickly, with much less mental effort. A long-standing challenge is to design generic visual query languages that have rich expressive power and are highly receptive and productive.

---

<sup>1</sup> Author's e-mail address: [koganlior1@gmail.com](mailto:koganlior1@gmail.com)

<sup>2</sup> V1 is named after the primary visual cortex in our brain, which is also known as visual area one (V1).

This work as well as the V1 language itself are licensed under the CC BY-NC-SA 4.0 license. To view a copy of this license, visit <https://creativecommons.org/licenses/by-nc-sa/4.0/>. Obtain permission prior to any use beyond those covered by the license. Contact copyright holder by emailing [koganlior1@gmail.com](mailto:koganlior1@gmail.com).

V1 is a rich generic declarative visual query language for schema-based property graphs. V1 supports property graphs with mixed (both directed and undirected) edges and half-edges, with enumerated, multivalued and composite properties, and with empty property values. V1 supports temporal data types, operators, and functions, and can be extended to support additional data types, operators, and functions.

After introducing the property graph data model, property graph schema, patterns and pattern languages, V1 is presented. The language's building-blocks are explained one by one, accompanied by more than 350 example patterns.

## 2 THE PROPERTY GRAPH DATA MODEL

A *graph* consists of a set of vertices (nodes), together with a set of edges. Each edge connects two of the vertices to each other. Sometimes half-edges (unary edges) - edges that are attached to only one vertex - are supported as well. A graph may be directed, undirected, or mixed.

A *property graph* is a

- *Vertex-labeled graph*: Each vertex has a label (string). In some definitions a vertex has a set of labels.
- *Edge-labeled graph*: Each edge has a label (string).
- *Vertex-attributed graph*: Each vertex has a set of descriptive features called *attributes*
- *Edge-attributed graph*: Each edge has a set of attributes as well

Each attribute has a name, a value data type (e.g. string, integer), and a value (e.g. "weight": int = 450). Composite attributes are sometimes supported as well. Composite attributes are composed of a set of sub-attributes - each has a name, a value data type and a value (e.g. "name" = ("first": string = "Brandon", "last": string = "Stark"))

The following semantics is commonly applied:

- Graph vertices represent entities. An entity is an object or a 'thing' whose existence is independent and which is distinguishable from other objects (e.g. a certain person, a certain horse, a certain dragon).
- Graph edges represent relationships or interactions between pairs of entities - directional (e.g. owns(Person, Dragon); offspring(Person, Person)) or bidirectional (e.g. sibling(Person, Person)). Directed edges represent directional relationships, while undirected edges represent bidirectional relationships.
- Half-edges, if supported, usually represent entity actions (e.g. sleeps(Dragon)).
- A vertex's label denotes the entity's type (e.g. "Person", "Horse", and "Dragon").
- An edge's label denotes the relationship's type (e.g. 'owns', 'member of').
- Attributes represent inherent properties of entities (e.g. 'name' for a person) and of relationships (e.g. 'timeframe' for an 'owns' interaction and for a 'sleeps' action).

The term “property graph” was popularized by Rodriguez and Neubauer [2, 3], though property graphs were previously introduced, sometimes with other names (e.g. Singh et al. [4] named them M\*3 (multi-modal, multi-relational, multifeatured) networks).

A *property graph schema* is defined by

- A set of entity types. For each entity type:
  - The entity type’s name (label)
  - A set of properties. For each property: name (key) and value data type
- A set of relationship types. For each relationship type:
  - The relationship type’s name(s). In some implementations, directional relationship types may have a name in each direction (e.g. “owns”, “owned by”; “parent of”, “offspring of”), while in other implementations directional relationship types are named only in one preferred direction.
  - The relationship type’s directionality: *directional* (sometimes called *unidirectional*, *asymmetric*) (e.g. ‘owns’, ‘offspring of’) or *bidirectional* (sometimes called *non-directional*, *symmetric*, *reciprocal*) (e.g. ‘sibling of’)
  - A set of pairs of entity types for which the relationship type holds (e.g. owns(Person, Horse); owns(Person, Dragon) )
  - A set of properties. For each property: name (key) and value data type

There is no commonly agreed-upon formal property graph model definition, nor a standard property graph data definition language. Definitions may vary in many aspects, including:

- The supported property data types (primitive types, enumerated, multivalued(list, set), composite)
- The relationship types’ supported directionality (directional / bidirectional / mixed)
- Support of unary relationships - relationships that are attached to only one entity
- Supported schema constraint types (mandatory properties / support of empty property values, relationships cardinality, property value constraints, etc.)
- Support of entity type hierarchies
- Support of relationship type hierarchies

A property graph may be:

- *Schema-based* (also called *schema-driven*, *schema-full*). A *schema-based property graph* is a property graph that conforms to a given schema.
- *Schema-free* (also called *schemaless*). A schema-free property graph neither defines nor enforces entity-types or relationships-types; each vertex and each edge, regardless of their label, may have properties with any name and of any data type.
- *Schema-mixed* (also called *schema-hybrid*), where a schema is defined, but additional elements (e.g. additional properties) may be used.

A schema is a model for representing knowledge in a certain domain. It is much easier to define patterns when knowledge is presented in a consistent manner.

In order to match patterns such as “*Any person who owns a white horse*” one first needs to:

#### 4 • L. Kogan

- Define entity types: ‘Person’ and ‘Horse’
- Define a relationship type: ‘owns’
- Define that the ‘owns’ relationship type holds from entities of type ‘Person’ to entities of type ‘Horse’
- Define a property for the ‘Horse’ entity type: ‘color’
- Define the data type of ‘color’ as string, or better - define ‘color’ as an enumerated data type
- Ensure that all the data conforms to the schema

### 3 PATTERNS AND PATTERN LANGUAGES

A *pattern* defines a set of constraints on the structure and on the property values of property graphs. Each property (sub)graph either *matches* the pattern or not. A given (sub)graph may match a pattern in more than one way.

Here are two examples (expressed in English, not in a formal pattern language):

- *P1: Any person who owns at least five white horses*

*P1* defines the set of graphs where

- There is a vertex  $p$  with label “person”
  - There are at least five vertices  $h1..h_n$ , each with label “horse”
  - Each of  $h1..h_n$  has a property “color” and its value is “white”
  - There are relationships from  $p$  to  $h1..h_n$ , each with label “owns”
- *P2: Any person whose date of birth is between 1/1/970 and 1/1/980, who owns a white Horse, who owns a dragon whose name begins with ‘M’, and over the course of the last month - his dragon froze at least three dragons belonging to members of the Masons Guild*

*P2* defines the set of graphs where

- There is a vertex  $p$  with label “person”
- $p$  has a property “birth date” of type “date” and its value is between 1/1/970 and 1/1/980
- There is at least one vertex  $h$  with label “horse”
- There is a relationship from  $p$  to  $h$  with label “owns”
- $h$  has a property “color” and its value is “white”
- There is at least one vertex  $d$  with label “dragon”
- There is a relationship from  $p$  to  $d$  with label “owns”
- $d$  has a property “name” with a value that begins with ‘M’
- There are at least three vertices  $d1..d_n$ , each with label “dragon”
- There are relationships from  $d$  to any of  $d1..d_n$ , each with label “freezes”
- Each of these relationships has a property “tf” (stands for “time frame”) with a sub-property “since” whose value is in the range  $[now()-months(3), now()]$
- There is at least one vertex  $g$  with label “guild”
- $g$  has a property “name” and its value is “Masons”

- There is one or more vertices  $p1..p_n$ , each with label “person”
- There are relationships from any of  $p1..p_n$  to  $g$ , each with label “member of”
- There are relationships from each of  $p1..p_n$  to one or more of  $d1..d_n$ , each with label “owns”, where each of  $p1..p_n$  and each of  $d1..d_n$  are connected with at least one relationship

Given property graph  $G$  and a query pattern  $P$ , *pattern matching* is the process of finding all subgraphs of  $G$  that match  $P$ . Any subgraph that matches the pattern is called an *assignment*.

Any assignment to  $PI$  is composed of:

- A ‘Person’ entity
- ‘Horse’ entities - of five or more of his horses, each has a property “color” and its value is “white”
- The ‘own’ relationships between the Person entity to those Horse entities

A *pattern language* defines:

- Syntax and semantics for expressing patterns
- Syntax and semantics for expressing pattern matching query results

The language’s *syntax* defines how symbols may be combined to create well-formed patterns and results. The language’s *semantics* define which (sub)graphs are valid assignments given a well-formed pattern. The language’s semantics also define if an answer to a pattern query is (i) the set of all assignments, or (ii) the union of all assignments. (ii) is often preferred since it avoids exponential explosion for many queries.

In schema-based languages, patterns are usually defined using the same schema as the property-graph they are matched against. Patterns can also be validated against a given schema.

Pattern languages differ in many aspects, including:

- *Genericity* - general-purpose (e.g. schema-driven) vs. domain-specific
- *Pattern representation* - textual vs. visual (sometimes called *graphical*, *diagrammatic*)
- *Declarative languages* describe *the pattern itself*, without specifying how to match it. On the other end of the spectrum, *Imperative languages* describe *how a pattern should be matched*, without specifying the pattern itself.
- *Expressive power* - The breadth of patterns that can be expressed (formal languages are always limited in a Gödelian sense)
- *Receptivity and Productivity* - How intuitive is it (for a human) to understand existing patterns and to construct new ones
- *Conciseness* - The fewness of symbols needed to express patterns
- *Aesthetics* - The quality of queries being visually appealing
- *Pattern matching complexity* - How complex is it to match patterns

V1 introduces the concept of *calculated properties* – non-inherent properties of graph-entities<sup>3</sup>, of groups of graph-entities, and of graph-relationships, that are defined as part of a pattern. For example, for a given pattern-entity, a calculated property may represent the sum of the values of a given property of all relationships with a given relationship-type that are adjacent to it. Values of calculated properties are part of the reported query results, thus extending V1 capabilities beyond pattern matching.

#### 4 VISUAL QUERY LANGUAGES

Query-posers would like to pose complex queries in a manner that is coherent with the way they think. They want to do it with minimal technical training, minimal effort and minimal trial and error. The ability to express patterns in a way that is aligned with their mental processes is crucial to the flow of their work, and to the value of the insights they are able to deduce.

Many potential query-posers won't use textual query languages (e.g. Gremlin [5], Cypher [6]), as the learning curve may be too sharp for someone with little or no prior experience in programming. Even experienced query-posers that do use textual query languages often spend a lot of time on the technicalities.

Visual query languages have a potential to be much more 'user-friendly' than their textual counterparts in the sense that patterns may be constructed and understood much more quickly and with much less mental effort. Given a schema, interactive visual query building tools can allow query-posers to compose patterns by selecting valid entity types, relationship types, and properties, hence, composing valid patterns with minimal typing.

A long-standing challenge is to design a visual query language that is generic, has rich expressive power, and is highly receptive and productive. V1 attempts to answer this challenge.

#### 5 A SONG OF ICE AND FIRE

The following scenario, loosely based on George R. R. Martin's *A Song of Ice and Fire* [1], will serve to demonstrate the expressive power of the V1 language.

The subjects of Sarnor, Ombor, and the other kingdoms of the known world like their horses. There is one thing they love even more - that is their dragons. They own dragons of ice and fire. Like all well-behaved dragons, their dragons love to play. Dragons always play in couples. When playing, dragons often get furious, fire at each

---

<sup>3</sup> The term "entity" bears two meanings: an entity in a pattern, and an entity in a graph. Similarly, the term "relationship" bears two meanings. When the context may be ambiguous, we use the terms "*pattern-entity*" and "*pattern-relationship*" to refer to pattern elements, and the terms "*graph-entity*" and "*graph-relationship*" to refer to graph elements. The terms "*concrete entity*", "*typed entity*" and "*untyped entity*" always refer to pattern elements.

other (fire breath) and freeze one another (cold breath). Dragons usually freeze one another for periods of several minutes, but on occasion, if they are really furious, they can freeze one another for periods of several hours. The subjects enjoy watching their dragons play. Fascinated by these magnificent creatures, they wrote thousands of books, which document each fire breath and each cold breath over the last 900 years. The kings of Sarnor and Omber regularly pose queries about their history. Quite often, it takes the royal historians and royal analysts several days to come up with answers, during which the kings tend to get pretty impatient. Lately, the high king of Sarnor posed a very complex query, and after waiting for results for more than two moons, he ordered the chief analyst to be executed. He then summoned his chief mechanics and ordered them to develop an apparatus which he could use to pose queries and get results quickly.

The engineers started by:

- Collecting all queries posed by their master over the last few years
- Constructing a property graph schema (entity types, relationship types - and their properties) using which these queries can be expressed

The schema was composed of the following entity types (and their properties):

- **Person** - name {first: *string*, last: *string*}, gender: *enum*, birth date: *date*, death date: *date*, height: *int* [cm]
- **Dragon** - name: *string*
- **Horse** - name: *string*, color: *enum*, weight: *int* [Kg]
- **Guild** - name: *string*
- **Kingdom** - name: *string*

and of the following relationship types (and their properties):

- **owns**(Person/Guild, Horse/Dragon) - tf: *dateframe* {since: *date*, till: *date*}
- **fires at**(Dragon, Dragon) - time: *datetime*
- **freezes**(Dragon, Dragon) - tf: *datetimeframe* {since: *datetime*, till: *datetime*}
- **offspring of**(Person, Person)
- **knows**(Person, Person) - since: *date*
- **member of**(Person, Guild) - tf: *dateframe* {since: *date*, till: *date*}
- **subject of**(Person, Kingdom)
- **registered in**(Guild, Kingdom)
- **originated in**(Horse/Dragon, Kingdom)

The *Date* data type holds a date. The *Datetime* data type holds a timestamp: date and time.

The *dateframe* and *datetimeframe* data types are composite data types that represent time frames, each has two sub-properties: *since* and *till*. For *dateframe* - the two sub-properties are of type *date*, and for *datetimeframe* - the two sub-properties are of type *datetime*. Person's name is a composite property.

The engineers then represented the whole known history using a property graph that conforms to this schema.

## 6 VI BASICS

The following sections define the syntax and semantics of the V1 language<sup>4</sup>. We start with the basics, adding more language elements as we go along.

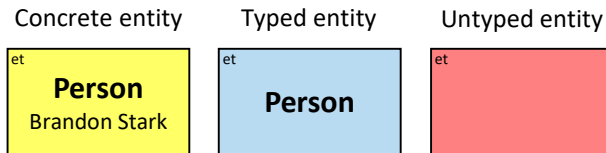

◆ Query start

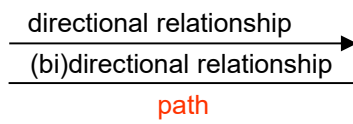

### Syntax

Patterns are generally read from left to right. Each pattern starts with (a small black diamond), continues with a (yellow, blue, or red rectangle), and continues with zero or more ( (black arrow, black line, or red line) followed by a (yellow, blue, or red rectangle) ). More complex pattern structures are described in the following sections.

### Semantics

Yellow, blue, and red rectangles represent entities. A **yellow rectangle** represents a *concrete entity*: a specific person, a specific horse, etc. The text inside a yellow rectangle denotes the entity type, and the value of the entity's leading properties (e.g. first name and last name of a person). A **blue rectangle** represents a *typed entity*: an entity of a given type. A blue 'Person' for example means that in any assignment - only concrete 'Person' entities can match the pattern. A **red rectangle** represents an *untyped entity*: an entity of any type (unless type constraints are defined. See section 20 – Untyped entities).

A pair of entities can be connected with:

- A horizontal **black arrow** - representing a *directional relationship*,
- A horizontal **black line** - representing either a *bidirectional relationship*, or a *directional relationship* where either direction is acceptable, or
- A horizontal **red line** - representing a *path* (see section 22 - Paths)

<sup>4</sup> V1 has two equivalent syntaxes for expressing patterns: A visual syntax - described here, and a textual (JSON) syntax which is not described in this paper. There is a bijective mapping between patterns expressed in these two syntaxes.



Each relationship has a label above the arrow/line that denotes the relationship's type.

The relationship type between two entities should be valid according to the schema. As said before - for each relationship type, the schema defines a set of pairs of entity types for which the relationship type holds (e.g. `owns(Person, Horse)`; `owns(Person, Dragon)` ).

For every blue rectangle, red rectangle, black arrow, and black line – a pattern matching engine would look in the property graph for assignments. Concrete entities are assigned to blue and red rectangles. Concrete relationships are assigned to black arrows and lines. An assignment to the pattern is a set of graph-entities and graph-relationships that match the whole pattern. An answer to a V1 pattern query is the union of all assignments.

Here are some basic patterns:

**Q1:** *Any dragon owned by Brandon Stark* (two versions)

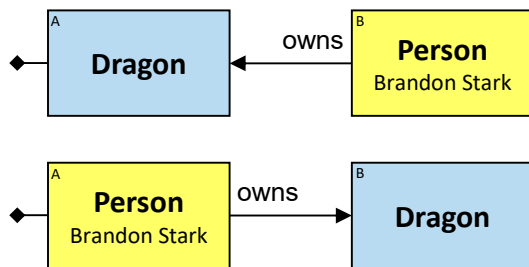

**Q2:** *Any dragon that at least once was frozen by a dragon owned by Brandon Stark*

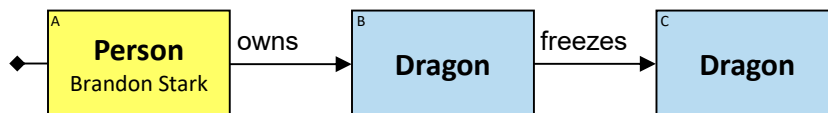

**Q184:** *Any dragon that at least once froze or was frozen by a dragon owned by Brandon Stark*

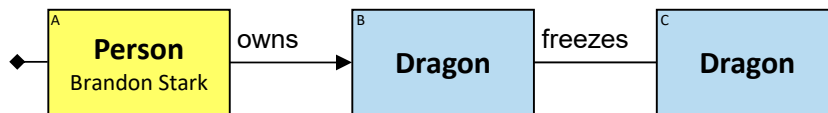

Both directions of the *freeze* relationship are acceptable. Therefore - a line (instead of an arrow) is used in the pattern.

## 7 EXPRESSION CONSTRAINTS

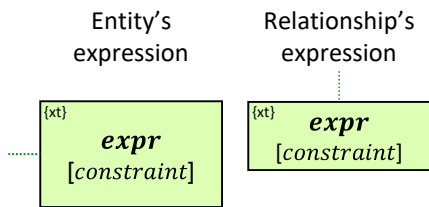

A **green rectangle** is connected to a pattern-entity (concrete / ensemble / typed / logical / untyped) - on its right, or to a pattern-relationship - on its bottom, and represents the value of an entity's / relationship's property or the value of an expression. It contains:

- An *expression tag* ('*xt*') (see section 25 – Expression tags)
- An *expression* ('*expr*')
- Optional: a *constraint* on the value of the expression which is composed of:
  - A comparison operator, and
  - An expression, a range expression, or a set of expressions (according to the operator)

An *expression* can be

- A constant value,
- A property name or a sub-property name of the attached entity/relationship,
- An expression tag (e.g. '{1}'),
- An aggregation tag which is a *calculated property* of the attached entity,
- A split tag which is a *calculated property* of the attached entity,
- expression *op* expression, where *op* is an operator (e.g. '3+{1}'),
- (expression)
- 'expression.*f*', where *f* is a parameterless function (e.g. '{1}.duration' ),
- 'expression.*f*(expression, expression, ...)', where *f* is a function with parameters, or
- '*f*(expression, expression, ...)' (e.g. '{max({1}, {2})}'. See Q317), where *f* is a global function

A *range expression* has one the following formats:

- (expression, expression),
- (expression, expression],
- [expression, expression), or
- [expression, expression]

A *set expression* has the following format:

- {expression, expression, ...}

If the expression left of the constraint is not simply a property name, a sub-property name, or a constant – it is a *calculated property* of the assigned graph-entity/graph-relationship.

**A constraint filters assignments - to only those assignments for which the value of the expression for the assigned entity/relationship satisfies the constraint.**

Constraints cannot be defined for concrete entities.

For untyped entities, green rectangles can be composed only of properties that are common to all valid entity types. Valid entity types for an untyped entity can be defined explicitly (using entity type constraints. See section 20 – Untyped entities) and implicitly (according to the types of the pattern-entities and pattern-relationships which are connected to the untyped entity).

A sub-property of a composite property is denoted as “property name”.”sub-property name” (e.g. “name.first”, “tf.since”).

**Q3:** *Any person who owns a dragon, and whose first name is Brandon* (version 1)

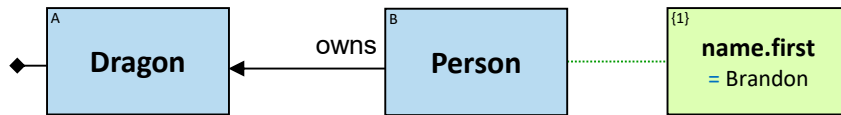

**Q190:** *Any person who owns a dragon since 1/1/1011 or since a later date* (version 1)

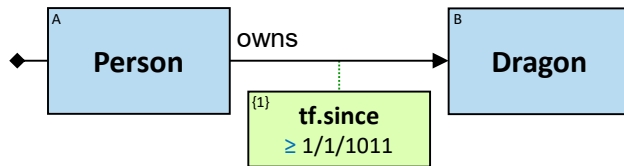

## 8 DATA TYPES, OPERATORS, AND FUNCTIONS

V1 supports the following *primitive data types*:

- integer types
- real types (floating-point)
- *string*
- *date*
- *datetime*
- *duration*

and the following composite data types:

- *dateframe* {since: *date*, till: *date*}
- *datetimeframe* {since: *datetime*, till: *datetime*}

Composite data types may contain sub-properties of any primitive, multivalued, or composite data type (non-recursively). Multivalued data types may contain either a list or a set of any primitive or composite data type.

Operators:

- $\text{int} + \text{int} \rightarrow \text{int}$ ,  $\text{int} - \text{int} \rightarrow \text{int}$ ,  $\text{int} * \text{int} \rightarrow \text{int}$ ,  $\text{int} / \text{int} \rightarrow \text{real}$
- $\text{real} + \text{real} \rightarrow \text{real}$ ,  $\text{real} - \text{real} \rightarrow \text{real}$ ,  $\text{real} * \text{real} \rightarrow \text{real}$ ,  $\text{real} / \text{real} \rightarrow \text{real}$
- auto type casting:  $\text{int} \rightarrow \text{real}$
- $\text{date} + \text{duration} \rightarrow \text{date}$ ,  $\text{date} - \text{duration} \rightarrow \text{date}$
- $\text{date} - \text{date} \rightarrow \text{duration}$
- $\text{datetime} + \text{duration} \rightarrow \text{datetime}$ ,  $\text{datetime} - \text{duration} \rightarrow \text{datetime}$
- $\text{datetime} - \text{datetime} \rightarrow \text{duration}$

Functions over *real type* expressions:

- $\text{real.floor} \rightarrow \text{int}$  - the greatest integer that is less than or equal
- $\text{real.ceil} \rightarrow \text{int}$  - the least integer that is greater than or equal
- $\text{real.trunc} \rightarrow \text{int}$  - truncates a real toward zero
- $\text{real.round} \rightarrow \text{int}$  - rounds a real to the nearest integer
- $\text{real.mRound}(\text{int}) \rightarrow \text{int}$  - rounds a real to the nearest multiple of a given integer
- $\text{real.mRound}(\text{real}) \rightarrow \text{real}$  - rounds a real to the nearest multiple of a given real

Parameterless functions are denoted without parentheses.

Functions over *integer type* expressions:

- $\text{int.mRound}(\text{int}) \rightarrow \text{int}$  - rounds an integer to the nearest multiple of a given integer

Functions over *string* expressions:

- `string.length` → int
- `string.toLower` → string
- `string.toUpper` → string

Functions over *datetime* expressions:

- `datetime.date` → date
- `datetime.year`, `datetime.month`, `datetime.day` → int
- `datetime.hour`, `datetime.min`, `datetime.sec` → int
- `datetime.dayofweek`, `datetime.dayofyear`, `datetime.weekofyear` → int
- `datetime.yearsSinceEpoch`, `datetime.monthsSinceEpoch`, `datetime.weeksSinceEpoch`, `datetime.daysSinceEpoch`, `datetime.hoursSinceEpoch`, `datetime.minsSinceEpoch`, `datetime.secsSinceEpoch` → real
- `datetime.hoursSinceMidnight`, `datetime.minsSinceMidnight`, `datetime.secsSinceMidnight` → real

Functions over *date* expressions:

- `date.year`, `date.month`, `date.day` → int
- `date.dayofweek`, `date.dayofyear`, `date.weekofyear` → int
- `date.yearsSinceEpoch`, `date.monthsSinceEpoch`, `date.weeksSinceEpoch`, `date.daysSinceEpoch` → real

**Q190:** Any person who owns a dragon since 1/1/1011 or since a later date (version 2)

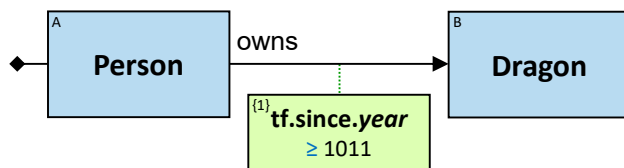

Functions over *dateframe* / *datetimeframe* expressions:

- `dateframe.dates` → [date] (list of dates) (see Q286, Q287, Q327)
- `dateframe.duration` → duration
- `datetimeframe.duration` → duration
- `dateframe.overlap(dateframe)` → duration
- `datetimeframe.overlap(datetimeframe)` → duration

Functions over *duration* expressions:

- `duration.seconds` → real
- `duration.minutes` → real
- `duration.hours` → real
- `duration.days` → real (see Q328)
- `duration.weeks` → real. One week = 7 days
- `duration.months` → real. One month = 30.4375 days

- `duration.years` → real. One year = 365.25 days

Global functions:

- `seconds(real)` → duration (e.g. `seconds(6)` is a duration of 6 seconds)
- `minutes(real)` → duration
- `hours(real)` → duration
- `days(real)` → duration (see Q216, Q289)
- `weeks(real)` → duration. One week = 7 days
- `months(real)` → duration. One month = 30.4375 days (see Q110)
- `years(real)` → duration. One year = 365.25 days (see Q317)
- `now()` → `datetime`
- `min(t, t, ...)` → `t`, where `t` is an expression of an ordinal type
- `max(t, t, ...)` → `t`, where `t` is an expression of an ordinal type

Constraints over ordinal expressions (integer types, real types, `date`, `datetime`, `duration`):

- `= expr / ≠ expr / > expr / ≥ expr / < expr / ≤ expr`
- `[not] in range-expr`
- `[not] in set-expr`

<code>expr</code> <code>= expr</code>	<code>expr</code> <code>≠ expr</code>
<code>expr</code> <code>&lt; expr</code>	<code>expr</code> <code>≥ expr</code>
<code>expr</code> <code>&gt; expr</code>	<code>expr</code> <code>≤ expr</code>
<code>expr</code> <code>in [v1, v2]</code>	<code>expr</code> <code>not in [v1, v2]</code>
<code>expr</code> <code>in {expr1, expr2, ...}</code>	<code>expr</code> <code>not in {expr1, expr2, ...}</code>

Constraints over `string` expressions:

- `= expr / ≠ expr`
- `[not] in set-expr`
- `[not] contains expr`
- `[not] starts with expr`
- `[not] ends with expr`
- `[not] matches regex`

<b><i>expr</i></b> = <i>expr</i>	<b><i>expr</i></b> ≠ <i>expr</i>
<b><i>expr</i></b> in { <i>expr</i> 1, <i>expr</i> 2, ...}	<b><i>expr</i></b> not in { <i>expr</i> 1, <i>expr</i> 2, ...}
<b><i>expr</i></b> contains <i>expr</i>	<b><i>expr</i></b> not contains <i>expr</i>
<b><i>expr</i></b> starts with <i>expr</i>	<b><i>expr</i></b> not starts with <i>expr</i>
<b><i>expr</i></b> ends with <i>expr</i>	<b><i>expr</i></b> not ends with <i>expr</i>
<b><i>expr</i></b> matches <i>regex</i>	<b><i>expr</i></b> not matches <i>regex</i>

Constraints over *date* / *datetime* expressions:

- [not] contained in *dateframe* / *datetimeframe*

Constraints over *dateframe* / *datetimeframe* properties:

- [not] starts during *dateframe* / *datetimeframe*
- [not] ends during *dateframe* / *datetimeframe*
- [not] contains *date* / *datetime*
- [not] contains *dateframe* / *datetimeframe*
- [not] contained in *dateframe* / *datetimeframe*

Implementations may support additional data types, operators, functions, and constraints.

Implementations may support *opaque data types* - data types where the internal data representation is not exposed. For each opaque data type - a set of functions and operators may be defined (see *location* in Section 53 - Application: Spatiotemporality).

## 9 EMPTY VALUES

V1 supports empty property values. Empty values may mean different things: the value of the property may be unknown (missing), the property may have no value (e.g. a person with no middle name), a date that has not yet arrived (e.g. empty death date), etc. Properties (of any type) may be evaluated either to a concrete value or as *empty*. Regardless of the data semantics, V1 has several constructs that are useful in many cases:

<b>since</b> < 1/1/1010	<b>since</b> < 1/1/1010
<b>since</b> empty	<b>since</b> not empty

- A constraint with a **blue comparison operator**: If the left-hand side is evaluated as *empty* - the constraint is evaluated as false; otherwise - it is evaluated according to values of the expressions
- A constraint with a **red comparison operator**: If the left-hand side is evaluated as *empty* - the constraint is evaluated as true; otherwise - it is evaluated according to the values of the expressions
- An ‘empty’ constraint - if the expression is evaluated as *empty* - the constraint is evaluated as true; otherwise - it is evaluated as false
- A ‘not empty’ constraint - if the expression is evaluated as *empty* - the constraint is evaluated as false; otherwise - it is evaluated as true

The result of any operator and any function on empty operands should be well defined.

For non-multivalued operands, operators where one or both of the values is *empty* - are evaluated as *empty* (e.g.  $3 + \text{empty} = \text{empty}$ ).

See Q8, Q11, Q267

## 10 UNITS

Numeric constants may represent measures such as weight, height, and duration. Different users, or even the same user in different contexts, may want to define constraints on the value of properties using different unit types: [Kg] or [lbs]; [cm] or [ft], [sec] or [min].

To avoid ambiguity, units can be defined for relevant properties. If defined – units are always displayed. When constructing a pattern, if more than one unit type is defined for a property - interactive pattern building tools may allow users to select which units to use.

See Q304, Q117, Q265, Q95



11 QUANTIFIERS #1

Vertical quantifiers (or simply ‘quantifiers’) can be used when there is a need to satisfy more than one constraint. Here are two simple examples:

**Q3:** *Any person who owns a dragon, and whose first name is Brandon (version 2)*

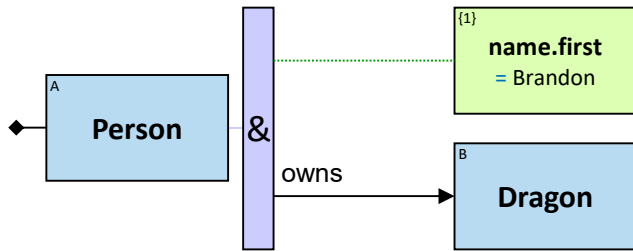

**Q304:** *Any person who owns a white horse, and who owns a horse weighing more than 200 Kg*

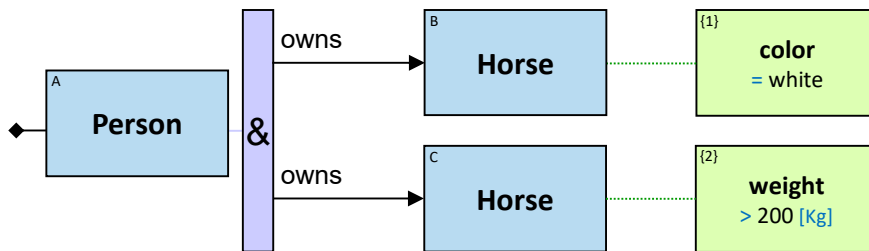

Note that the same graph-entity can match more than one pattern-entity. Either the same horse or different horses may be assigned to Entity tags B and C (this can be avoided: see *identity constraints* and *nonidentity constraints* in section 13 – Entity tags).

A quantifier has one connection on its left side and two or more branches on its right side. Let *b* denote the number of branches. We’ll name the left side of the quantifier ‘the left component’, and anything that follows a branch, up to the end of the branch, ‘a right component’.

**The first way to use quantifiers:** The left component ends with an entity (concrete / ensemble / typed / logical / untyped), and each right component starts with:

- A relationship (optionally preceded by an ‘X’, a ‘↗’ or an ‘O’),
- A path (optionally preceded by an ‘X’, a ‘↗’ or an ‘O’),
- A green rectangle (entity’s expression value constraint/tag), or
- A quantifier

In this usage, a quantifier may be preceded by an ‘O’ (see Q147, Q149)

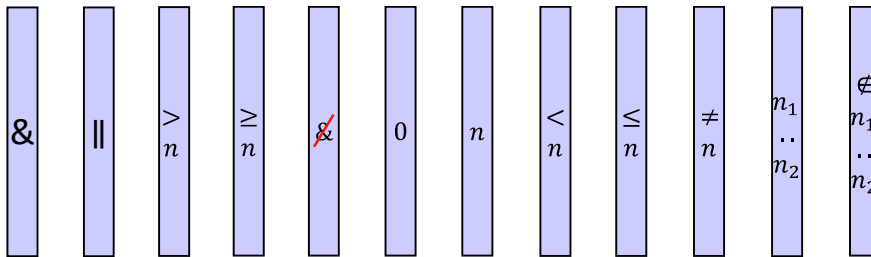

V1 defines 12 quantifiers:

- **All** (denoted '&') - An assignment matches the pattern *only if* it matches the left component and all the right components.
- **Some** (denoted '|')

An assignment  $A$  matches a pattern  $P$  *only if* it matches a pattern  $Q$  where

- $Q$ 's left component is identical to  $P$ 's
- $Q$  has  $i$  right components identical to  $P$ 's,  $1 \leq i \leq b$ , and no other right components
- If there is only one right component - the quantifier is removed (the left and right components are merged). Otherwise - the quantifier is replaced with an "All" quantifier
- **> n** ( $n \in [0, b-1]$ )

An assignment  $A$  matches a pattern  $P$  *only if* it matches a pattern  $Q$  where

- $Q$ 's left component is identical to  $P$ 's
- $Q$  has  $i$  right components identical to  $P$ 's,  $n < i \leq b$ , and no other right components
- If there is only one right component - the quantifier is removed (the left and right components are merged). Otherwise - the quantifier is replaced with an "All" quantifier
- **≥ n** ( $n \in [1, b]$ )

An assignment  $A$  matches a pattern  $P$  *only if* it matches a pattern  $Q$  where

- $Q$ 's left component is identical to  $P$ 's
- $Q$  has  $i$  right components identical to  $P$ 's,  $n \leq i \leq b$ , and no other right components
- If there is only one right component - the quantifier is removed (the left and right components are merged). Otherwise - the quantifier is replaced with an "All" quantifier
- **Not all** (denoted by an '&' with stroke)

An assignment  $A$  matches a pattern  $P$  *only if* it matches a pattern  $Q$  where

- $Q$ 's left component is identical to  $P$ 's

- $Q$  has  $i$  right components identical to  $P$ 's,  $1 \leq i < b$ , and no other right components
- If there is only one right component - the quantifier is removed (the left and right components are merged). Otherwise - the quantifier is replaced with an "All" quantifier

and there is no assignment  $B$  with a similar left component as  $A$ 's that matches a pattern  $R$  where

- $R$ 's left component and all its right components are identical to  $P$ 's
- The quantifier is replaced with an "All" quantifier

- **None** (denoted '0')

An assignment  $A$  matches a pattern  $P$  *only if* it matches a pattern  $Q$  where

- $Q$ 's left component is identical to  $P$ 's
- The quantifier and the right components are removed

and there is no assignment  $B$  with a similar left component as  $A$ 's that matches a pattern  $R$  where

- $R$ 's left component is identical to  $P$ 's
- $R$  has  $i$  right components identical to  $P$ 's,  $1 \leq i \leq b$ , and no other right components
- If there is only one right component - the quantifier is removed (the left and right components are merged). Otherwise - the quantifier is replaced with an "All" quantifier

- **= n** ( $n \in [1, b]$ )

An assignment  $A$  matches a pattern  $P$  *only if* it matches a pattern  $Q$  where

- $Q$ 's left component is identical to  $P$ 's
- $Q$  has  $n$  right components identical to  $P$ 's, and no other right components
- If there is only one right component - the quantifier is removed (the left and right components are merged). Otherwise - the quantifier is replaced with an "All" quantifier

and, if  $n \neq b$ , there is no assignment  $B$  with a similar left component as  $A$ 's that matches a pattern  $R$  where

- $R$ 's left component is identical to  $P$ 's
- $R$  has  $i$  right components identical to  $P$ 's,  $i > n$ , and no other right components
- The quantifier is replaced with an "All" quantifier

- **< n** ( $n \in [2, b]$ )

An assignment  $A$  matches a pattern  $P$  *only if* it matches a pattern  $Q$  where

- $Q$ 's left component is identical to  $P$ 's
- $Q$  has  $i$  right components identical to  $P$ 's,  $1 \leq i < n$ , and no other right components

- If there is only one right component - the quantifier is removed (the left and right components are merged). Otherwise - the quantifier is replaced with an "All" quantifier

and there is no assignment  $B$  with a similar left component as  $A$ 's that matches a pattern  $R$  where

- $R$ 's left component is identical to  $P$ 's
- $R$  has  $i$  right components identical to  $P$ 's,  $i \geq n$ , and no other right components
- The quantifier is replaced with an "All" quantifier

- $\leq n$  ( $n \in [1, b]$ )

An assignment  $A$  matches a pattern  $P$  only if it matches a pattern  $Q$  where

- $Q$ 's left component is identical to  $P$ 's
- $Q$  has  $i$  right components identical to  $P$ 's,  $1 \leq i \leq n$ , and no other right components
- If there is only one right component - the quantifier is removed (the left and right components are merged). Otherwise - the quantifier is replaced with an "All" quantifier

and there is no assignment  $B$  with a similar left component as  $A$ 's that matches a pattern  $R$  where

- $R$ 's left component is identical to  $P$ 's
- $R$  has  $i$  right components identical to  $P$ 's,  $i > n$ , and no other right components
- The quantifier is replaced with an "All" quantifier

- $\neq n$  ( $n \in [0, b]$ )

$\equiv (< n) \vee (> n)$

- $n1..n2$  ( $n1 \in [1, b]$ ,  $n2 \in [2, b]$ ,  $n1 < n2$ )

An assignment  $A$  matches a pattern  $P$  only if it matches a pattern  $Q$  where

- $Q$ 's left component is identical to  $P$ 's
- $Q$  has  $i$  right components identical to  $P$ 's,  $n1 \leq i \leq n2$ , and no other right components
- If there is only one right component - the quantifier is removed (the left and right components are merged). Otherwise - the quantifier is replaced with an "All" quantifier

and there is no assignment  $B$  with a similar left component as  $A$ 's that matches a pattern  $R$  where

- $R$ 's left component is identical to  $P$ 's
- $R$  has  $i$  right components identical to  $P$ 's,  $i > n2$ , and no other right components
- If there is only one right component - the quantifier is removed (the left and right components are merged). Otherwise - the quantifier is replaced with an "All" quantifier

- $\notin n1..n2$  ( $n1 \in [2, b-1], n2 \in [3, b], n1 < n2$ ) (not in  $n1..n2$  but more than 0)

$$\equiv (< n1) \vee (> n2)$$

“Only if” denotes a necessary but not sufficient condition, since assignments must satisfy all constraints expressed in the pattern.

Quantifiers may be chained. Here is an example:

**Q8:** Any person born prior to 970 and passed away, or whose father born no later than 1/1/950

The following data semantics is assumed: empty death date means that the person is still alive.

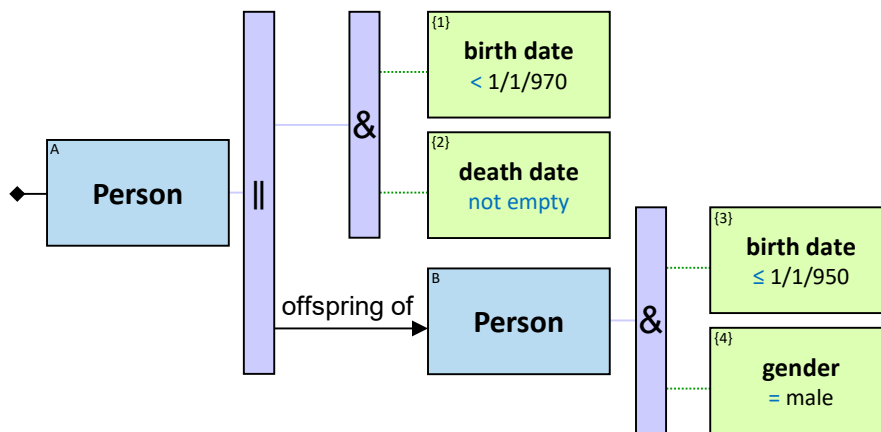

12 QUANTIFIERS #2

**A second way to use quantifiers:** The left component ends with a relationship or with a path, and each right component starts with either

- An entity (concrete / ensemble / typed / logical / untyped), or
- A quantifier

The following examples demonstrate both ways to use quantifiers:

**Q11:** *Any current member of the Masons Guild, who since 1011 or later knows someone who left the Saddlers guild or the Blacksmiths guild - on June 1010 or later*

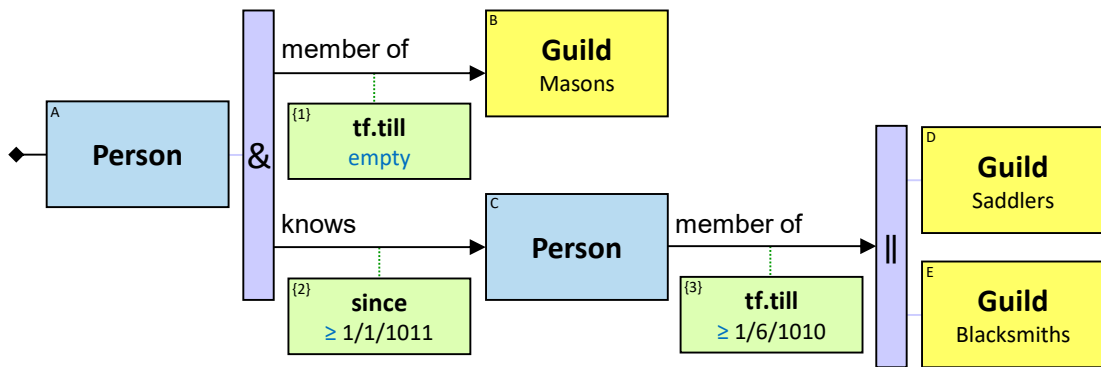

Note that the constraint ‘member of tf.till *empty*’ is based on the assumption that an empty value means that the person is still a member. Alternatively, it could have meant that the *till* date is unknown. This depends on the semantics of the *till* property in the given property graph.

**Q10:** *Any person whose first name is Brandon, who owns some dragon B which froze a dragon C that (i) belongs to an offspring of Rogar Bolton, and (ii) froze a dragon that belongs either to Robin Arryn or to Arrec Durrandon. B froze C at least once in 1010 or after - for longer than 100 seconds*

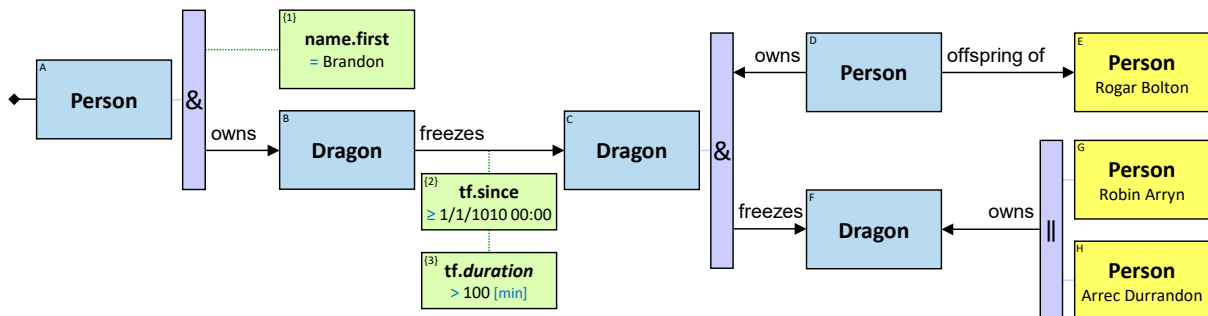

## 13 ENTITY TAGS

There is a letter in the top-left corner of any entity rectangle (concrete / ensemble / typed / logical / untyped). This letter is called an ‘entity tag’.

Entity tags are used for three purposes:

- Entity tags appear in the query’s result as well: any assignment to an entity in the answer is tagged with the same tag as the pattern’s entity it was assigned to. This helps the query poser understand why any given entity is part of the answer.
- Entity tags may be used within aggregators, to count or to limit the number of assignments or assignment combination (see section 28 - L1 aggregation, section 31 - M1 min/max aggregation, and section 48 - P1 min/max aggregation)
- Entity tags are used to express *identity constraints* and *nonidentity constraints*.

An *identity constraint* is used when the same (identical) graph-entity should be assigned to:

- Several typed pattern-entities of the same type
- Several untyped pattern-entities

In addition, *identity constraints* are automatically enforced whenever the same concrete entity / the same ensemble is used more than once (see Q25v2, Q26v2)

Example:

**Q4:** *Any person whose dragon was frozen by a dragon owned by (at least) one of his parents*

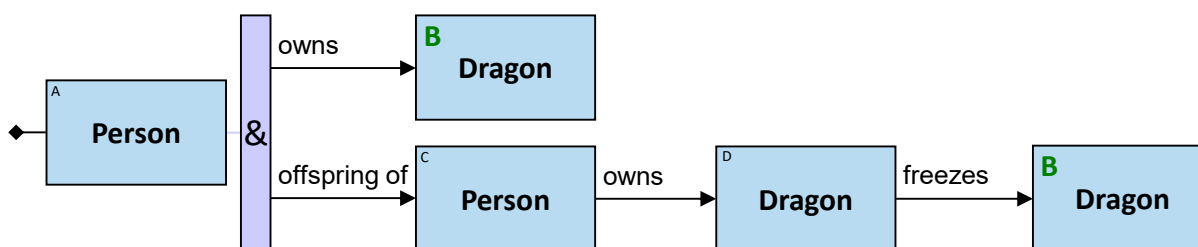

Entity tag ‘B’ is used to enforce identical assignment to two ‘dragon’ pattern-entities.

In order to visually emphasize the identity constraint, all ‘B’ tags are bold and green.

Here is another example:

**Q9:** Any dragon pair (A, B) where A froze B both in 1980 and in 1984

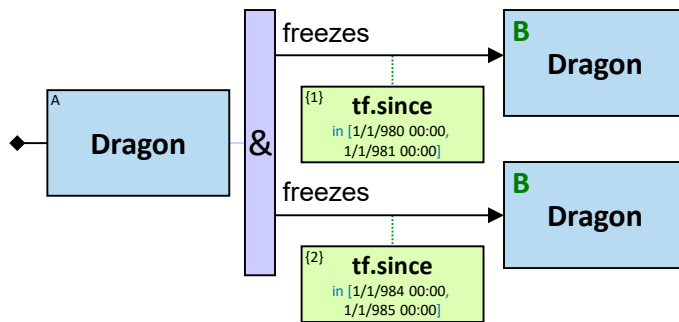

A *nonidentity constraint* is used when different (nonidentical) graph-entities should be assigned to several typed pattern-entities (of the same type) / untyped pattern-entities. Here is an example:

**Q5:** Any person whose dragon was frozen by a dragon owned by two of his parents

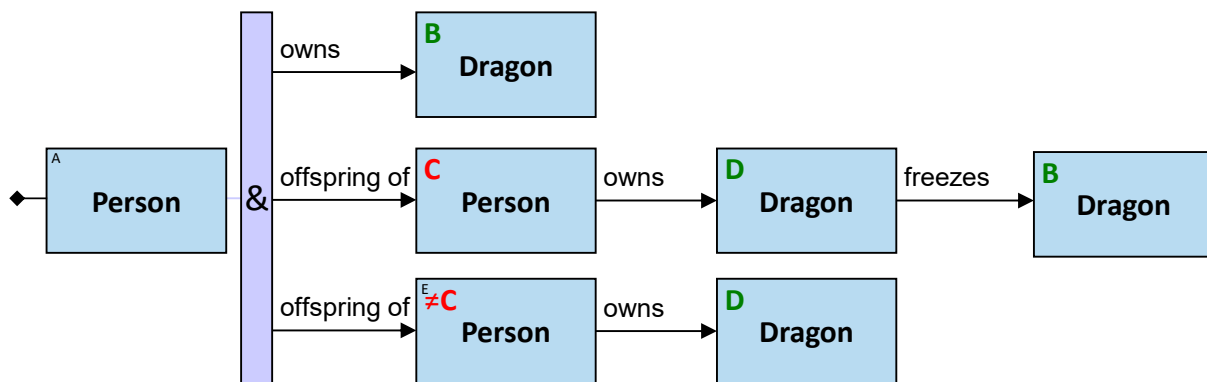

Without enforcing nonidentity, the same parent can be assigned to both C and E.

In order to visually emphasize the nonidentity constraint, the 'C' tag and all '≠C' tags are bold and red.

Here are some more examples:



**Q6:** Any person whose dragon was frozen by two dragons – one owned by one of his parents, the other owned by another parent (none, one, or both dragons may be owned by both parents)

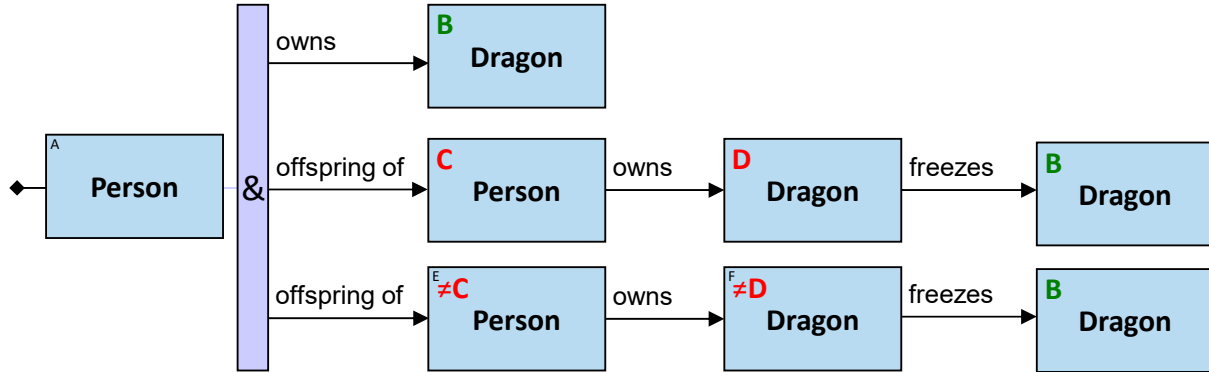

**Q7:** Any person whose dragon was either (i) frozen by a dragon owned by two of his parents, or (ii) frozen by two dragons – one owned by one of his parents and the other owned by his other parent

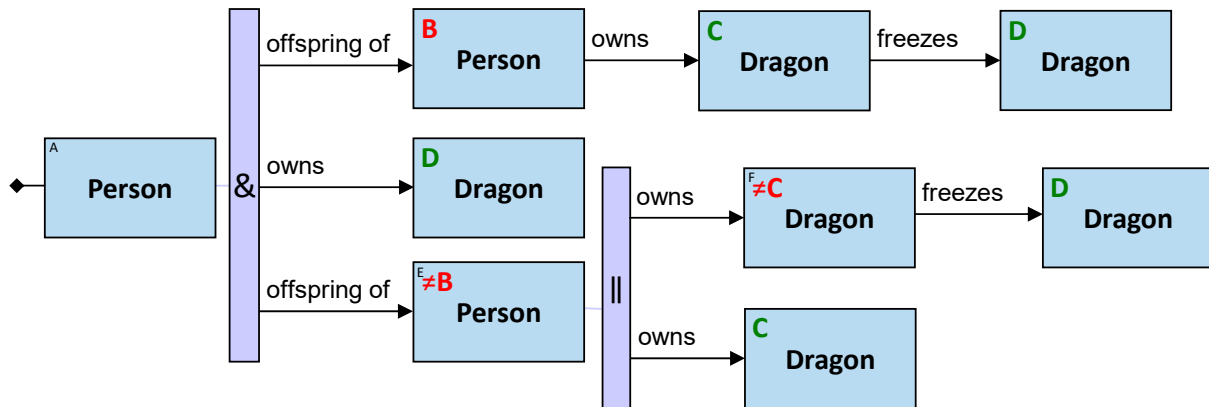

**Q24:** Any person who has (at least) two parents and owns a dragon that was frozen by a dragon that is not owned by either of his parents

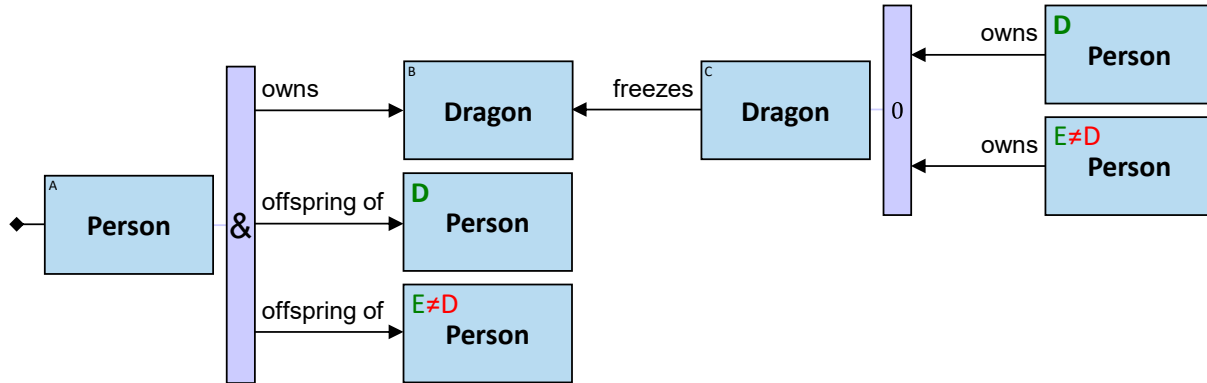

Q24 demonstrates usage of both identity constraints and nonidentity constraints for the same pattern-entity.

Several nonidentity constraints may be defined for the same rectangle (e.g.  $\neq C$ ,  $\neq D$ )

Identity and nonidentity constraints are evaluated as follows:

- Step 1: All assignments to the pattern, without the identity/nonidentity constraints, are found.
- Step 2: If for some assignment a constraint is not relevant (e.g. identity/nonidentity between a pair of entities in two branches of a "Some" quantifier, where the assignment includes only one branch) - the assignment is valid.
- Step 3: If for some assignment a constraint is relevant (e.g. identity/nonidentity between entities in two branches of a "Some" quantifier, where the assignment includes both branches) - the assignment is valid only if the constraint is satisfied.

#### 14 NO-EXISTANCE AND NO-CONNECTION

Sometimes we need to express a pattern using negative terms. For example: *any person whose first name is Brandon, and who **doesn't** own a white horse*. Such patterns are composed of:

- The left 'positive' component - ends with an entity (*any person whose first name is Brandon*) or with a quantifier
- A no-existence / a no-connection language element ("*doesn't*")
- The right 'negative' component - starts with a relationship/path (*own a white horse*)

The example above covers two cases: (i) there may be no white horses at all, or (ii) there may be white horses, but none of them is owned by a person whose first name is Brandon.

## No-existence No-connection



When it doesn't matter which is the case - *any person whose name is Brandon and doesn't own a white horse* is a valid assignment to the pattern - the **no-existence language element** (depicted with a pink 'X' box) can be used.

An assignment matches the pattern *only if*:

- It matches a pattern composed only of the left component (there is an assignment to *a person whose first name is Brandon*)
- It has no superset that matches a pattern composed of the left component chained to the right component (without the 'X' box) (There is no assignment to *a person whose first name is Brandon that owns a white horse*)

An 'X' may not appear directly before a relationship or a path with an aggregation (see section 27 - Aggregation constraints and aggregation tags)

In certain cases, we need an assignment to match the pattern *only if*:

- It matches a pattern composed only of the left component (there is an assignment to *a person whose first name is Brandon*)
- It has no superset that matches a pattern composed of the left component chained to the right component (without the 'X' box) (There is no assignment to *a person whose first name is Brandon that owns a white horse*)
- Such superset can be constructed by adding instances of the relationship/path that starts the right component (after adding a single *owns* relationship instance - there is an assignment to *a person whose first name is Brandon that owns a white horse*)

In such cases, the **no-connection language element** (depicted with a pink '↗' box) can be used.

'↗'s are usually used directly before a relationship or a path with an aggregation (see Q126, Q63-Q66, Q165)

Trivially, since pattern-entities right of an 'X' are required to have no assignments - the query result includes no assignments to them. All such pattern-entities are depicted with a gray icon on their top-right (see section 18 - Latent pattern-entities). On the other hand, pattern-entities right of a '↗' are required to have assignments which are included in the query result.

Examples:

**Q12:** Any person who doesn't own a horse

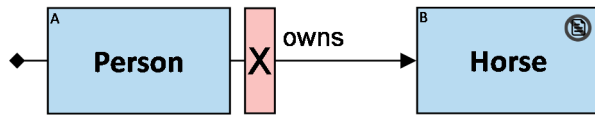

**Q13:** Any horse that is not owned by a person

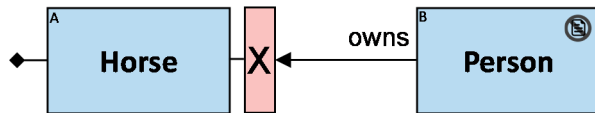

**Q14:** Sweetfoot - if it is not owned by a person

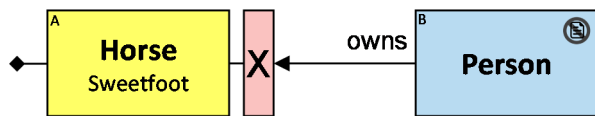

**Q15:** Brandon Stark - if he doesn't own a horse

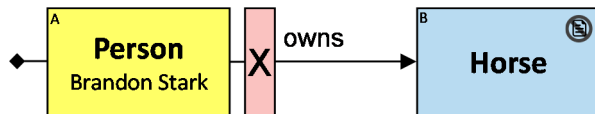

**Q16:** Any person who doesn't own Sweetfoot

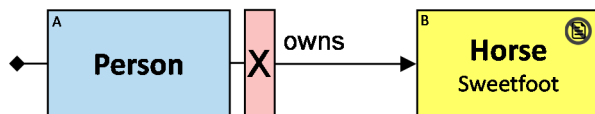

**Q17:** Any horse that is not owned by Brandon Stark

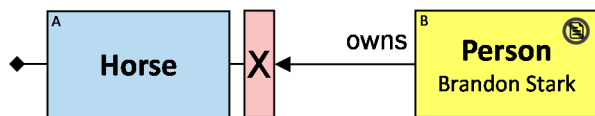

**Q18:** *Brandon Stark - if he doesn't own Sweetfoot*

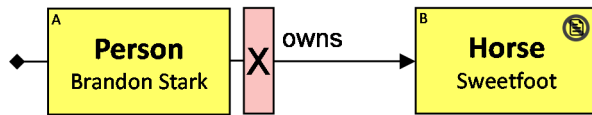

**Q19:** *Sweetfoot - if it is not owned by Brandon Stark*

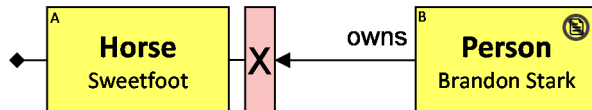

**Q22:** *Any horse not owned by a person who owns a dragon*

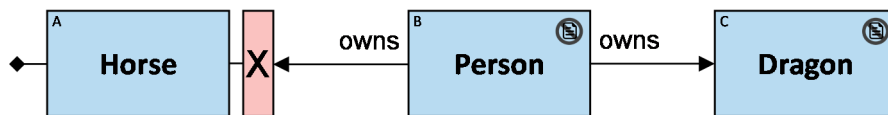

Note that the left component is 'horse' while the right component is 'owned by a person who owns a dragon'. The right component is anything that follows the 'X' - up to the end of the branch.

Valid assignments:

- Any horse that is not owned
- Any horse that none of its owners is a person (e.g. a horse owned by a guild)
- Any horse that each person who owns it - doesn't own a dragon

**Q23:** *Any horse not owned by a person who doesn't own a dragon*

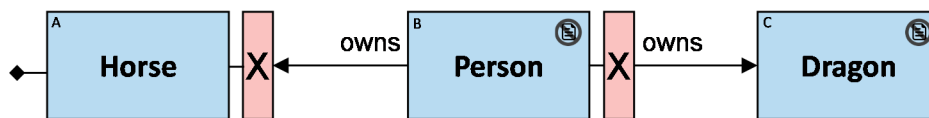

Valid assignments:

- Any horse that is not owned
- Any horse that none of its owners is a person (e.g. a horse owned by a guild)
- Any horse that each person who owns it - also owns a dragon

**Q256:** Any person who doesn't own a white horse

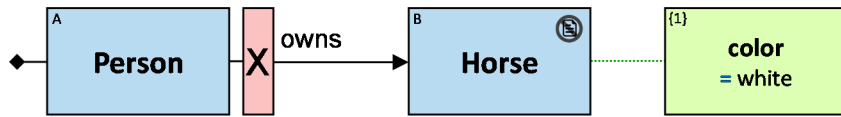

**Q257:** Any person who didn't become a horse owner on or after 1011

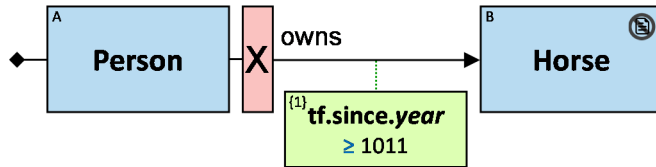

**Q258:** Any person who didn't become a white horse owner on or after 1011

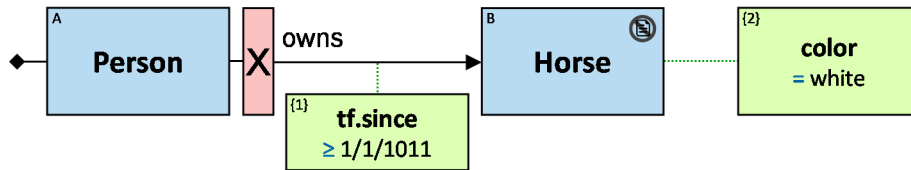

An 'X' / a '↗' may also appear before a relationship that directly follows a quantifier's branch:

**Q20:** Any horse that is neither owned by Rogar Bolton nor by Robin Arryn (two versions)

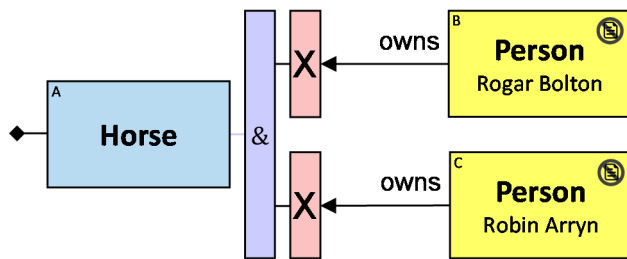

This pattern can also be represented using the "None" quantifier:

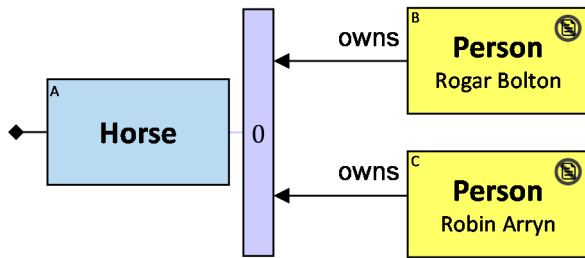

**Q21:** Any horse that is not owned by both Rogar Bolton and Robin Arryn (two versions)

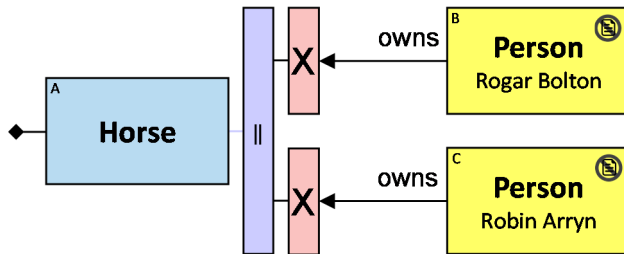

This pattern can also be represented using the "Not all" quantifier, but there is a slight difference: in the version above, if either Rogar Bolton or Robin Arryn owns the horse - the owner won't be a part of the answer, while in the version below - the owner will be a part of the answer.

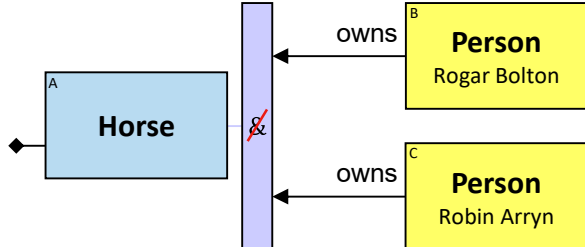

**Q25:** Any dragon (C) that wasn't fired at by Balerion, but was fired at by a dragon that Balerion fired at (two versions)

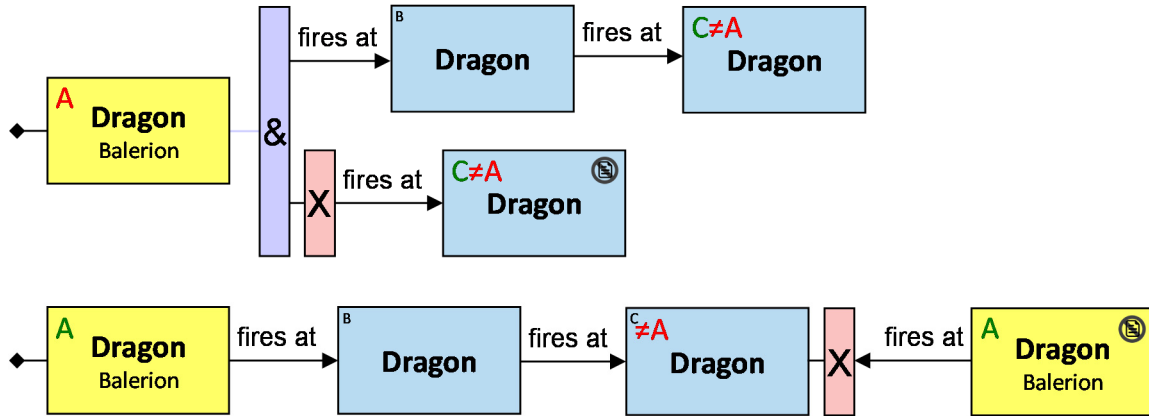

**Q26:** Any guild that people who are members of the same guild as Brandon Stark are member of, but Brandon is not a member of that guild (four versions)

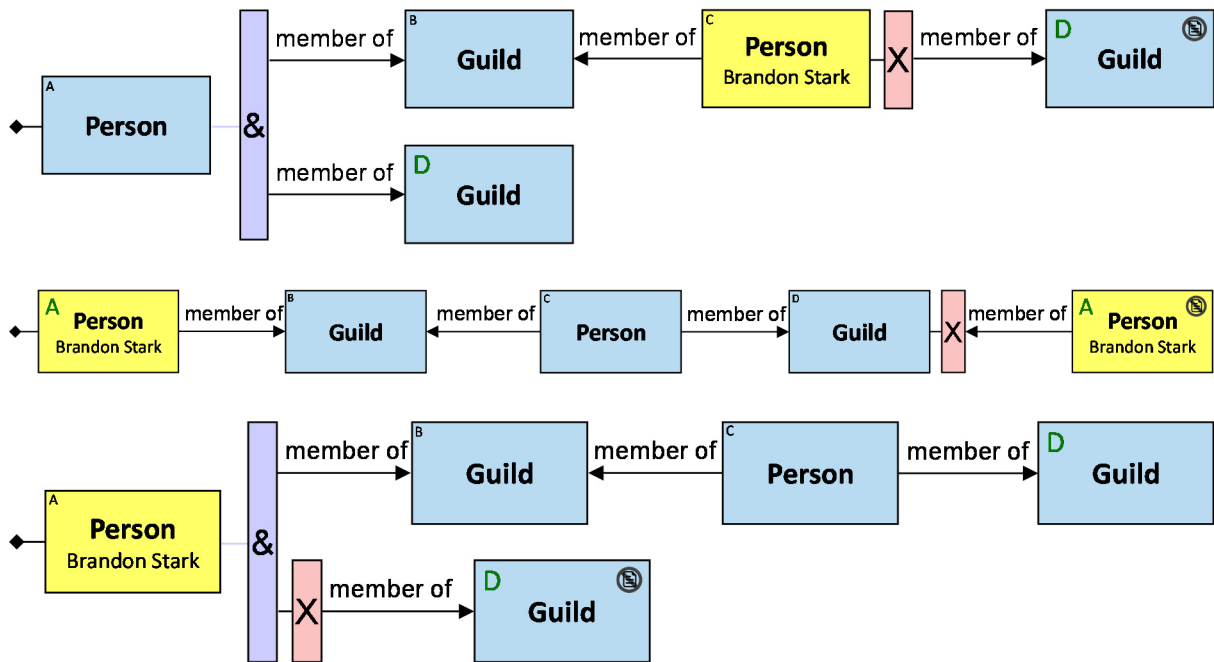



15 QUANTIFIERS #3

**A third way to use quantifiers:** A quantifier may start a pattern. On the quantifier's left side - the pattern's start, while each right component may start with either

- An entity (concrete / ensemble / typed / logical / untyped), or
- A quantifier

The "None" quantifier may not start a pattern.

Here is a fourth way to represent Q26:

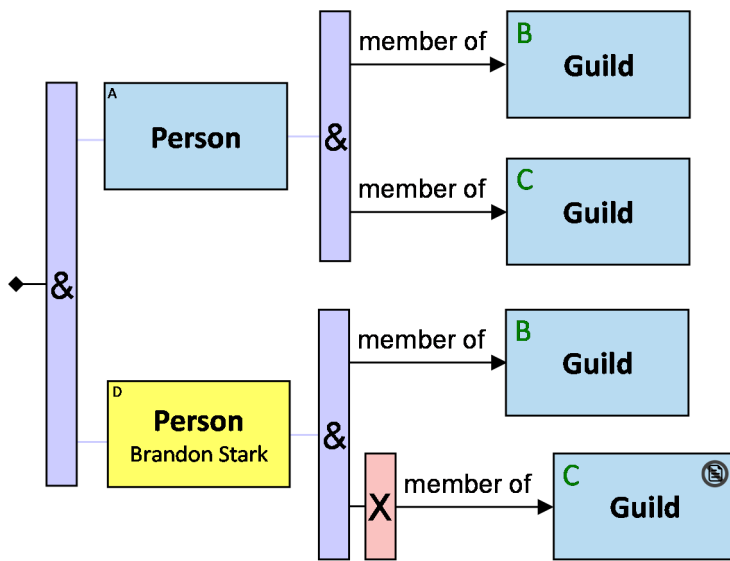

See also Q108, Q27, Q320, Q279v2 and Q282.

16 COMBINER

Combiner



A combiner combines two or more branches of the same quantifier. On its left side are relationships, and on its right side - an entity.

The entity type on a combiner's right side must match all the relationship types on its left side.

Here are some examples:

**Q30:** Any dragon pair (A, B) where A both froze B and fired at B (two versions)

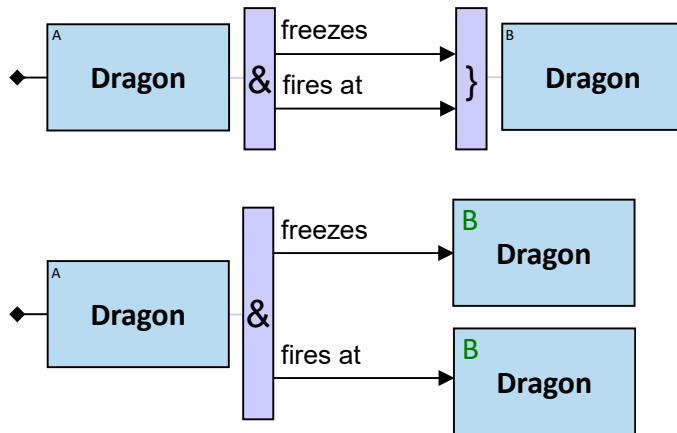

The entity on the right side of a combiner has the same assignment for all the branches.

**Q187:** Any dragon that was frozen by Balerion: (at least once in 1/1/1010 or later) and (at least once - for less than 10 minutes) - same or different freezes

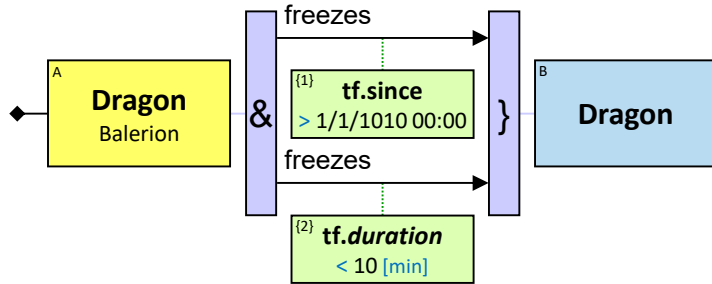

Note that the same graph-relationship may be assigned to the two ‘freezes’ pattern-relationships.

**Q29:** Any dragon that froze or fired at some dragon (two versions)

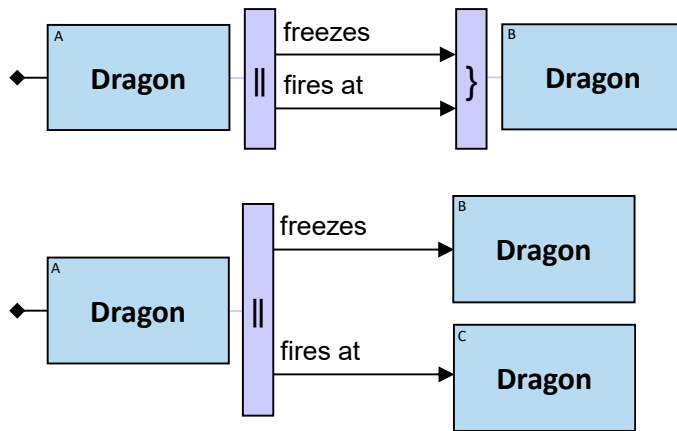

See also note under Q121 - combiner right of an L1 aggregator.

**Q189:** Any dragon that was frozen by Balerion: (at least once in 1/1/1010 or later) or (at least once for less than 10 minutes) **Alternative wording:** Any dragon that was frozen by Balerion at least once: (in 1/1/1010 or later, or for less than 10 minutes)

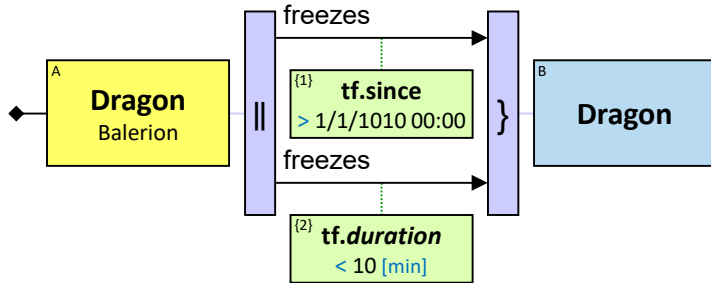

**Q35:** Any dragon pair (A, B) where A froze B but didn't fire at B

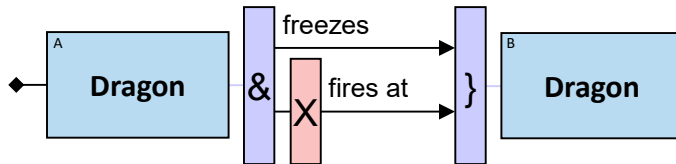

When a combiner combines branches of an "All" quantifier: for at least one branch - the entity directly right of the combiner must not be implicit latent in the context of the branch.

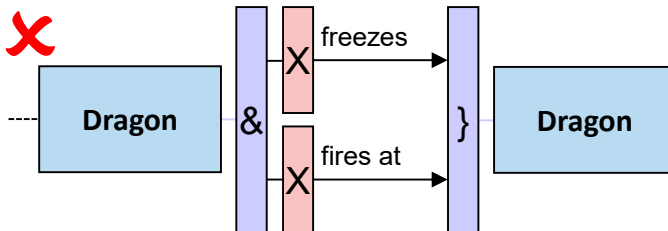

When a combiner combines branches of any quantifier except "All": the entity directly right of the combiner must not be implicit latent in the context of any branch.

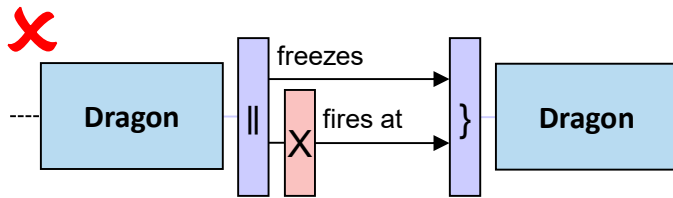

**Q31:** Any dragon pair  $(A, B)$  where  $A$  froze  $B$ ,  $A$  fired at  $B$ ,  $B$  froze  $A$ , and  $B$  fired at  $A$

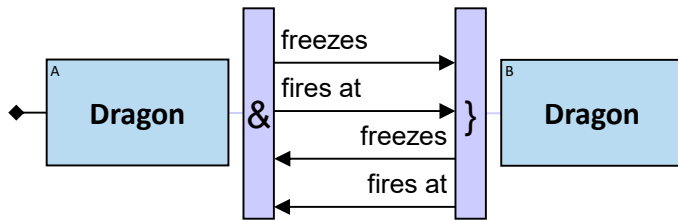

**Q32:** Any dragon pair  $(A, B)$  where  $A$  fired at  $B$ , and  $A$  fired at some dragon that fired at  $B$

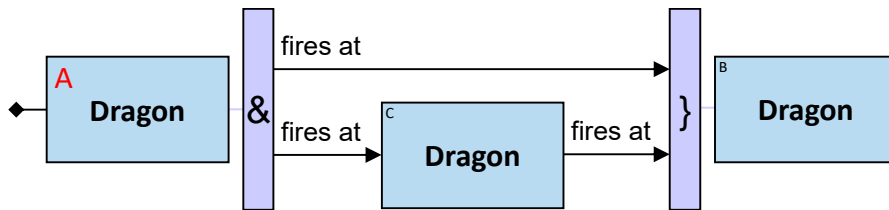

**Q170:** Any dragons triplet  $(A, B, D)$  where  $A$  fired at  $B$ ,  $A$  fired at some dragon that fired at  $B$ ,  $B$  froze  $D$ , and  $B$  froze some dragon that froze  $D$

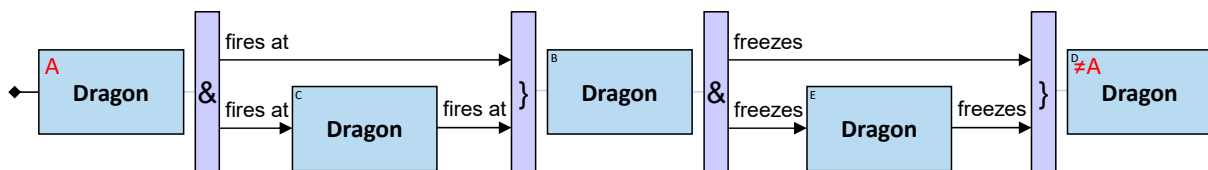

**Q33:** Any dragon A that froze some dragon B, froze some dragon that froze B, and fired at some dragon

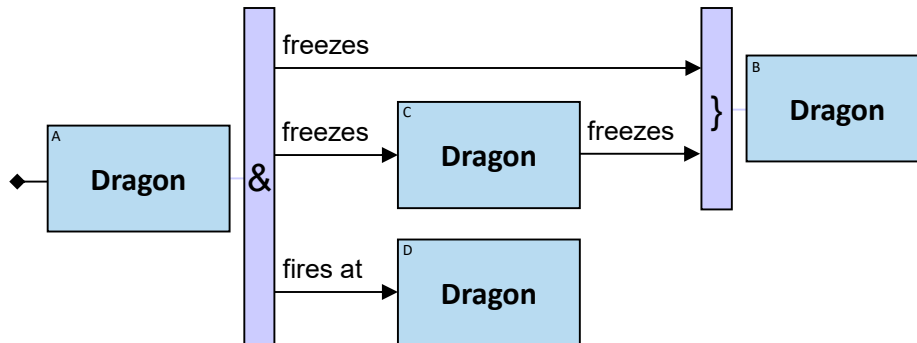

**Q34:** Any dragon A that froze some dragon B, froze some dragon that froze B, fired at some dragon D and fired at some dragon that fired at D (B and D may be the same dragon or different dragons)

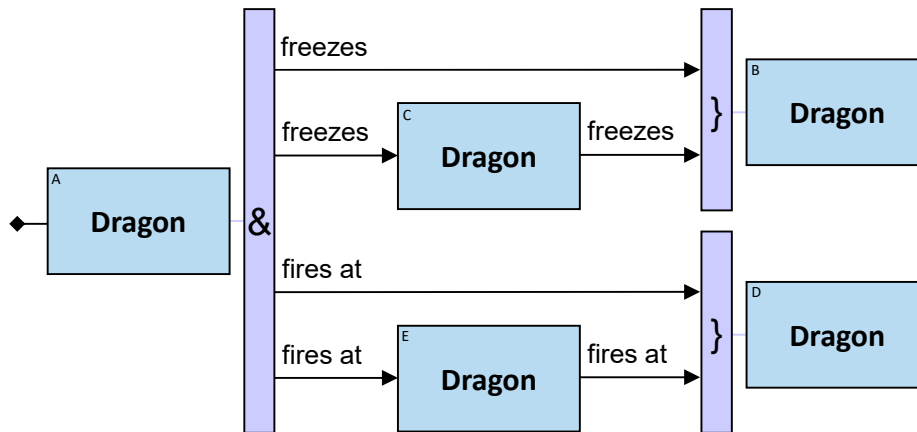

## 17 CHAINS, HORIZONTAL QUANTIFIERS, AND HORIZONTAL COMBINERS

Green rectangles below a relationship may be **chained**. When chained, each green rectangle serves as a filtering step. The constraints are met only if there is an assignment that passes all filtering steps.

A chain of relationship expressions has a similar semantics to those of entity expressions following an “All” vertical quantifier.

Here is an example:

**Q188:** Any dragon that was frozen by Balerion at least once - in 1/1/1010 or later - for less than 10 minutes

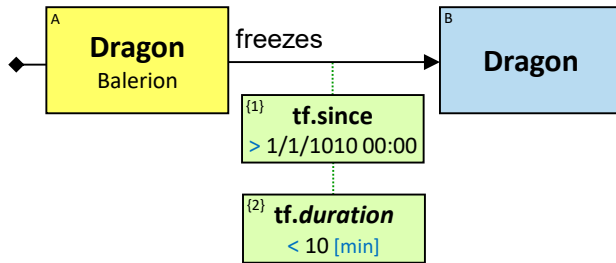

11 horizontal quantifier types are defined (as for vertical quantifiers, except “All”). Their semantics are similar to those of vertical quantifiers.

A horizontal quantifier may appear below

- a relationship
- a green rectangle (relationship’s expression value constraint/tag)
- an orange rectangle (an aggregation constraint/tag)
- a horizontal quantifier
- a split

On its bottom there two or more branches. Each branch starts with either

- a green rectangle (relationship’s expression value constraint/tag), or
- a horizontal quantifier

A horizontal combiner may be used to combine two or more branches. Above it - green rectangles, each defined in a different branch of the same horizontal quantifier. Below it - another chained stage which starts with

- a green rectangle (relationship’s expression value constraint/tag),
- an orange rectangle (an aggregation constraint/tag), or
- a horizontal quantifier

or

- A horizontal combiner

An orange rectangle may not appear in a horizontal quantifier’s branch. It may appear above a horizontal quantifier, or below a horizontal combiner.

**Q300:** Any dragon pair (A, B) where A froze B, and at least two of the following conditions are satisfied: (i) the freeze duration was longer than 10 minutes (ii) the freeze started after 1/1/980 (iii) the freeze ended before 1/2/980

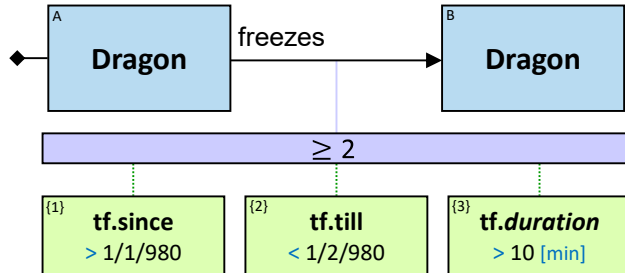

**Q301:** Any dragon pair (A, B) where A froze B for more than 10 minutes, and either the freeze started after 1/1/980 or the freeze ended before 1/2/980 (two versions)

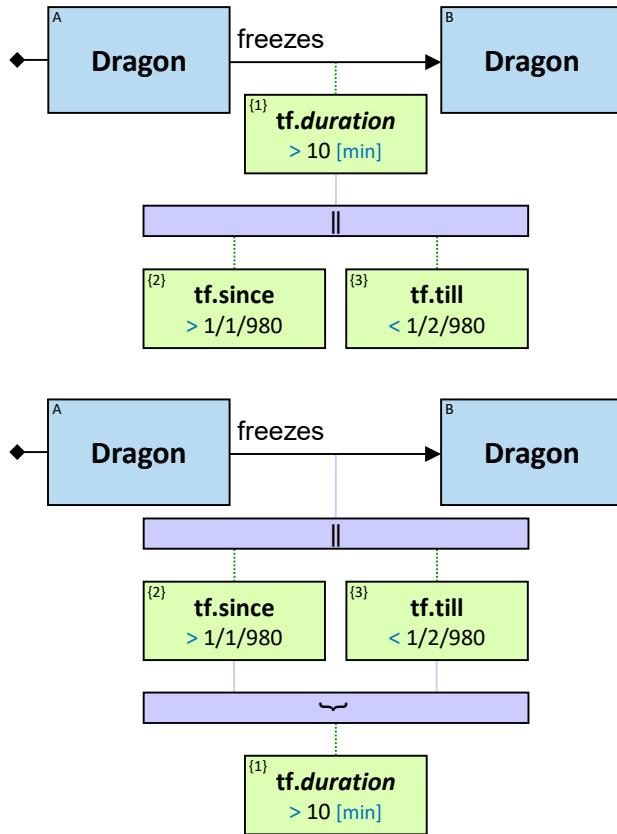



## 18 LATENT PATTERN-ENTITIES



Latent pattern-entities are pattern-entities which their assignments (if any) are not reported as part of the answer.

There are two types of latent pattern-entities: implicit and explicit.

**Implicit latent** pattern-entities are required to have no assignments, hence no assignments would be reported as part of the answer. These include pattern-entities that appear

- right of an 'X' (see Q12, Q22, Q288)
- right of a "None" quantifier (see Q20v2)
- zero-count in L1 aggregations where the *per* part is not a Cartesian product that encloses the *B* entities (see Q81, Q82)
- zero-count in L2 aggregations where the *per* part is not a Cartesian product that encloses the relationship (see Q83, Q84; see Q279v1 for counterexample where the *per* part is such a Cartesian product)

Implicit latent pattern-entities are depicted with a gray icon on their top-right. Such icons should be automatically appended by an interactive pattern builder / visualizer tool, and may not be added / manipulated manually.

**Explicit latent** pattern-entities are non-implicit latent pattern-entities, which the pattern composer marks as latent. Though they may have assignments - those assignments should not be reported. Any non-implicit latent pattern-entity can be marked as explicit latent.

Explicit latent pattern-entities are depicted with a red icon on their top-right.

Here are two examples:

**Q142:** *Any person who owns a white horse, and has a parent who owns a horse. The parent and his horse are not part of the answer*

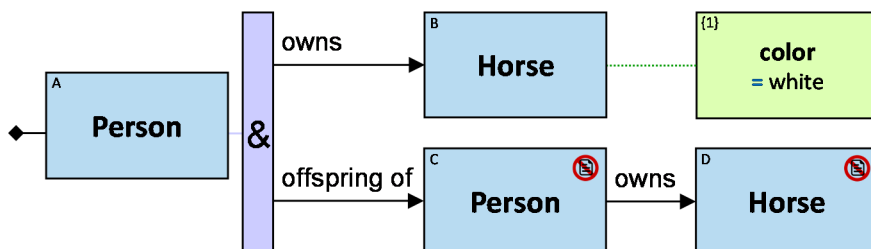

**Q143:** *Any person who owns a white horse, and has a parent that doesn't own a horse. The parent is not part of the answer*

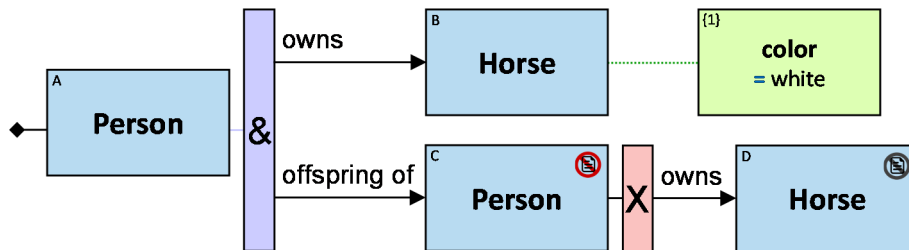

Concrete, ensemble, typed, logical and untyped entities may all be latent - implicit or explicit.

At least one pattern-entity should be non-latent.

## 19 OPTIONAL COMPONENTS



Anything right of an 'O' is **optional**: if it has a valid assignment - it will be part of the answer. Otherwise - it won't.

- An 'O' may be located directly before a relationship, a path, or a quantifier (excluding a quantifier at the start of the pattern)
- An 'O' may not be located so that on its right there are only latent entities
- An 'O' may appear right of another 'O' (see Q146)

When an 'O' starts a quantifier's branch - this branch does not affect the evaluation of the quantifier (see Q148, Q150)

- A quantifier must have at least one branch that doesn't start with an 'O'

Here are some examples:

**Q144:** Any person who owns a white horse. If he has a parent who owns a horse - the parent and his horse will be part of the answer as well

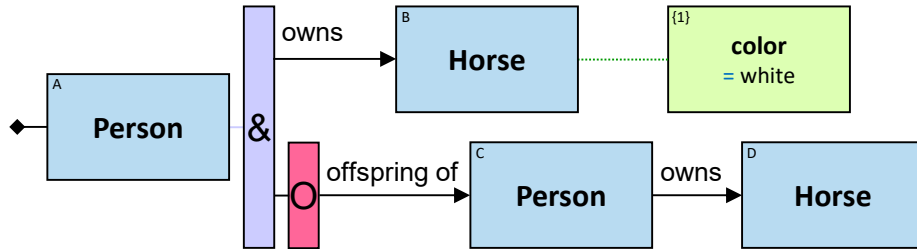

**Q145:** Any person who owns a white horse. If he has a parent that doesn't own a horse - the parent will be part of the answer as well

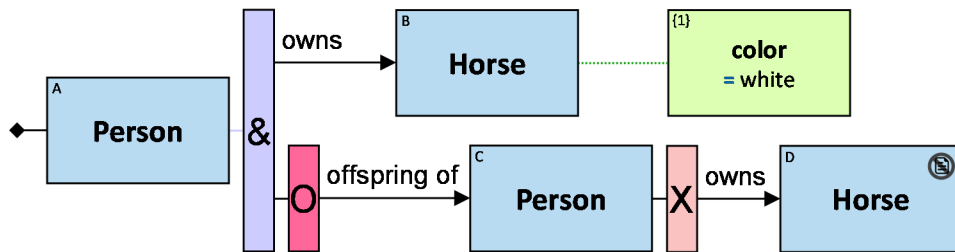

**Q146:** Any person who owns a white horse. If he has a parent - the parent will be part of the answer as well. If his parent owns a horse - this horse will be part of the answer as well

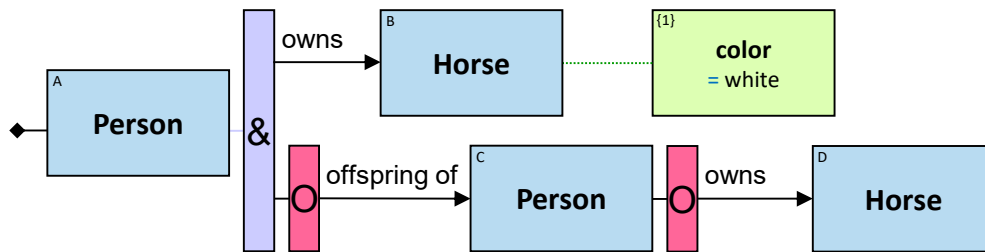

**Q147:** Any person. If he owns both a horse and a dragon - they will be a part of the answer as well

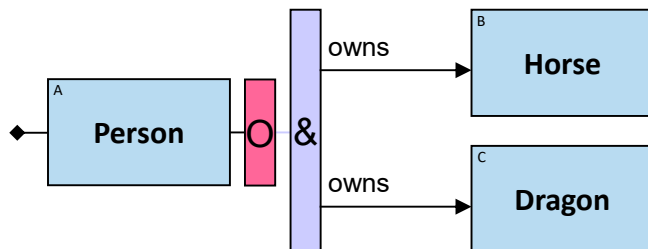

**Q148:** Any person who owns both a horse and a dragon. If he has a parent - the parent will be part of the answer as well

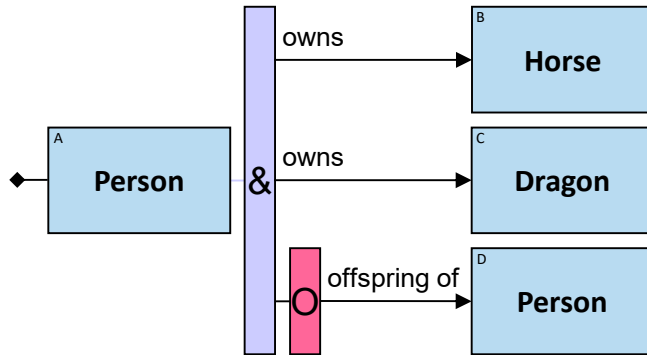

**Q149:** Any person. If he owns a horse - it will be a part of the answer as well. If he owns a dragon - it will be a part of the answer as well

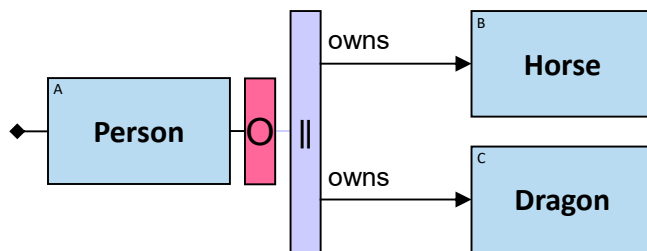

**Q150:** Any person who owns a horse or a dragon. If he has a parent - the parent will be part of the answer as well

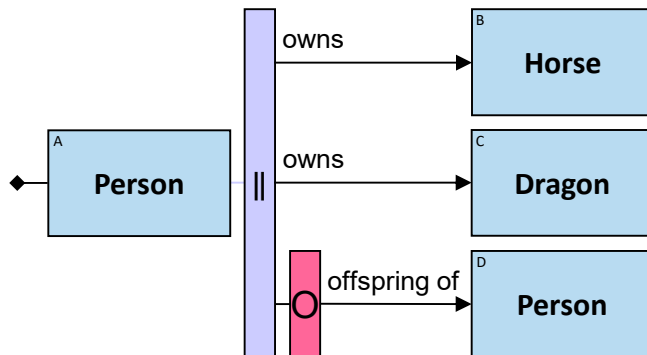

Any expression tag / aggregation tag / split tag defined right of an 'O' is evaluated as *empty* when the optional part has no valid assignment (see Q140, Q141, Q317, Q318).

The number of assignments to an entity tag defined right of an ‘O’ is zero when the optional part has no valid assignments (see Q321).

20 UNTYPED ENTITIES

Sometimes the same relationship type can hold between different pairs of entity types (e.g. owns(Person, Dragon); owns(Guild, Dragon) ). Untyped entities can be used to express patterns such as “any dragon and its owners”, when the owner can be either a person or a guild.

In its simplest form, an empty red rectangle represents an entity of any type.

**Q36:** Any person who owns something

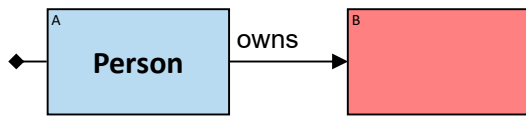

The entity type is **implicitly constrained** because of the relationship type. In Q36, the entity type is constrained to things that a person can own.

**Q49:** Any three dragons with a cyclic freeze pattern, and their owners (if any)

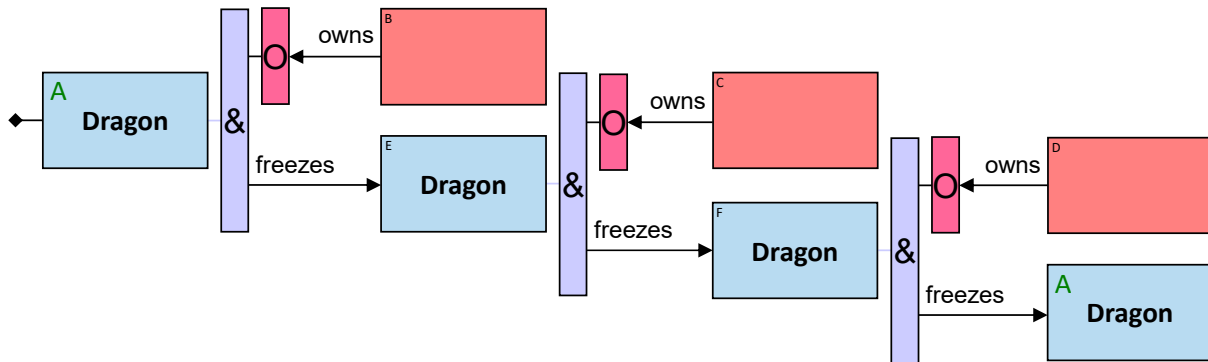

The entity types of all owners are implicitly constrained to things that can own a dragon.

In addition to the implicit type constraints - **explicit type constraints** can be enforced by defining a set of allowed types or a set of disallowed types. Here are two examples:

**Q37:** Any person who owns a horse or a dragon

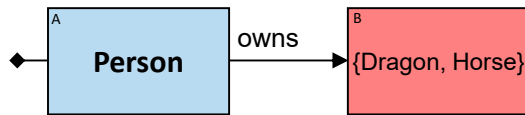

Since both *horse* and *dragon* entity types have a *name* property of the same data type (string) - the following pattern is valid:

**Q291:** Any person who owns a horse or a dragon whose name begins with 'M'

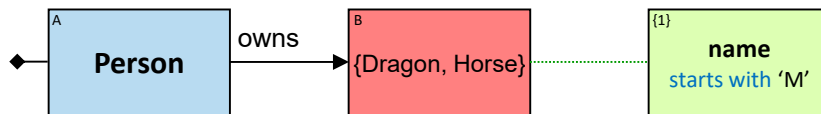

**Q38:** Any person who owns something which is neither a horse nor a dragon

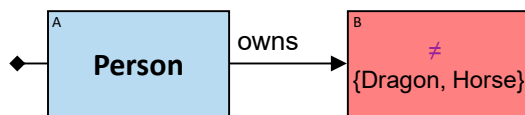

Even when an untyped entity is on either side of an 'X' - the entity's type is constrained by pattern-relationship types. Here are some examples:

**Q39:** Any entity of a type that can own a dragon, but doesn't

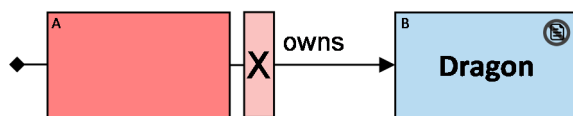

**Q40:** Any dragon that has no owner

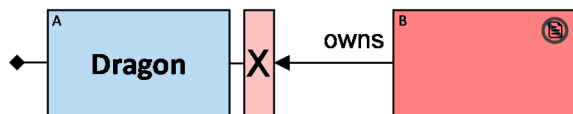

**Q41:** Any entity of a type that can be owned, but is not owned

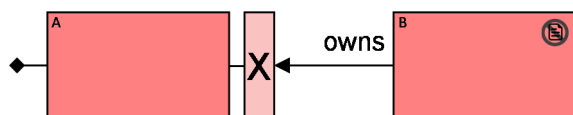

**Q42:** Any entity of a type that can own something, but owns nothing

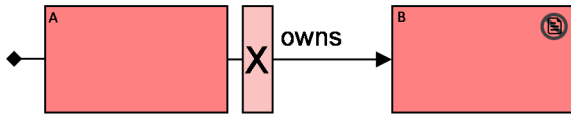

**Q43:** Any dragon that all of its owners (if any) are people

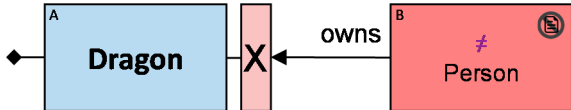

## 21 NULL ENTITIES

The data model may support relationships to *null entities*:

Sometimes the identity of an entity on one side of a relationship is unknown. In other times, the identity of an entity on one side of a relationship is not stored, since it is not important in our domain. We only care about the relationship and its properties. Practically, the types of such entities may even not be part of the schema.

Two possible use-cases for *null entities*:

- For some/all of the dragons, we may know that they were owned in given timeframes, but we don't know/care who/what owned them. Still - we want to be able to store and query such information.
- We want to store '*single-ended relationships*'. For example, we may want to store timeframes in which each dragon was sleeping - each timeframe as a 'sleeps' relationship between a dragon and a *null entity*.

In summary - a *null entity* is used as a placeholder where a real entity is unimportant, unknown, or not even exist. But still, the existence of a relationship, as well as the values assigned to the relationship's properties - are important.

*Graph null entities* are of entity type null. *Null entity type* has no properties. Not even a technical Identifier.

A *null entity type* may be defined in one side of a pair of entity types for which a relationship type holds (e.g. owns(Person/Guild/Null, Dragon) ). Null may even be the only allowed entity type for one side of a relationship type (e.g. Sleeps(Dragon, Null) ).

Each *graph null entity* can be connected by only one relationship (the *degree* of each *graph null entity* is 1).

A relationships connected to a null entity realizes a *half-edge (unary edge)* graph element.

As part of a pattern:

- Concrete *null entities* are not allowed
- A typed entity may be of type *null*
- For untyped entity with no explicit type constraints - *null entities* may be assigned
- For untyped entity with explicit type constraints - *null entities* may be explicitly allowed / disallowed

A typed entity may be of type *null* / an untyped entity may explicitly allow *null entities* only when it is connected to only one entity:

- There is no relationship/path on its right (it is a terminal node) or there is no relationship/path on its left (if starts the query)
- It is not directly after a combiner, nor directly before a quantifier
- It is not being aggregated - except for zero-count L1 / L2 aggregation
- Its single connection is either a relationship of a type that supports *null entities* in this side, or a path that may end with such relationship
- Its entity tag is not reused (no identity nor nonidentity constraints)

## 22 PATHS

A path connects two pattern-entities - similar to a pattern-relationship. However, while a pattern-relationship represents a graph-relationship between two graph-entities, a path represents either a relationship or an indirect connection: a sequence of graph-relationships and graph-entities between two graph-entities. The graph-entities along a path are all distinct from one another.

A path resolves to at least one relationship. Each path has a length. The length of the path equals to the number of graph-entities along the path, hence, a relationship is actually a path with length 0. The number of relationships along a path is always larger by one than the number of entities along the path.

A path is depicted by a red line between two pattern-entities. Above the line is a constraint on the path length, expressed using one of the following operators:  $= n$ ,  $< n$ ,  $\leq n$ ,  $in [n1..n2]$ ,  $in \{n1, n2, \dots\}$ , where all numbers are positive integers.

An assignment to a path consists of all the relationships and the entities along the path.

Here are two examples:

**Q53:** *Any person within graph distance  $\leq 4$  from Rogar Bolton*

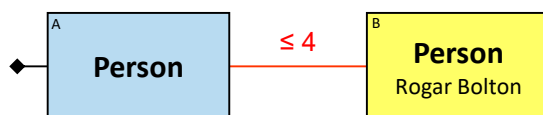



**Q55:** Any entity within graph distance  $\leq 3$  from Rogar Bolton, Robin Arryn, and Arrec Durrandon

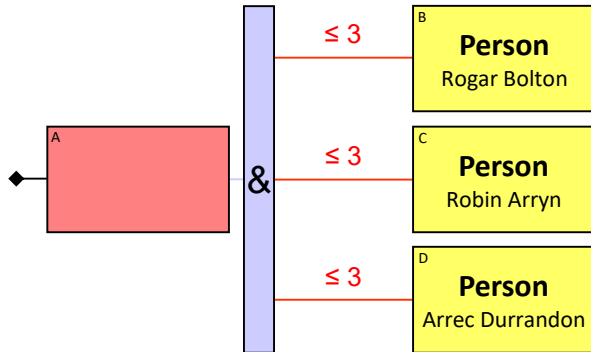

Constraints may be defined for both the entities and the relationships along the path:

Relationship constraints are listed in red curly brackets above the path's line. The brackets may list:

- Allowed relationship types - e.g. {fires at, freezes}
- Constraints on the number of relationships of each allowed type - e.g. {freezes < 2, fires at = 2}
- Constraints on the number of relationships of each allowed type in each direction - e.g. {→ freezes = 2, ← freezes = 1}
- Disallowed relationship types constraints - e.g. {freezes = 0}

Entity constraints are listed in red curly brackets below the path's line. The brackets may list:

- Allowed entity types - e.g. {Dragon}.
- Constraint on the number of entities of each allowed type - e.g. {Dragon < 1}
- Disallowed entity types - e.g. {Dragon = 0}

A path cannot be composed of *null entities* since they are terminal nodes. Therefore, the list of allowed entity types may not contain *null*. Similarly, the list of disallowed entity types may not contain *null* as it is implicitly disallowed.

Here are some examples:

**Q44:** Any path with length  $\leq 4$  between these two dragons, which is composed only of 'freezes' relationships



**Q45:** Any path with length  $\leq 4$  between these two dragons, which is composed only of 'freezes' and 'fired at' relationships

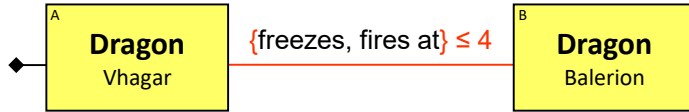

**Q54:** Any person within graph distance  $\leq 3$  from Rogar Bolton, Robin Arryn, and Arrec Durrandon

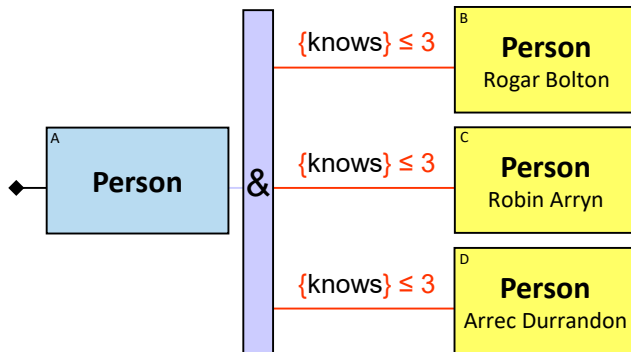

**Q46:** Any path with length  $\leq 4$  between a dragon owned by Rogar Bolton to a dragon owned by Robin Arryn, which is composed of up to two 'freezes' relationships, and only of 'Dragon' entities

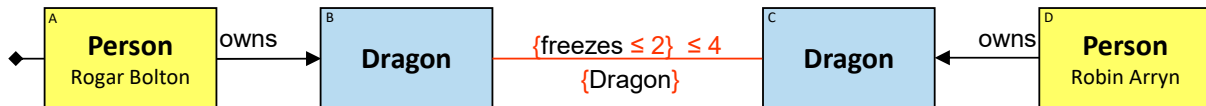

### 23 SHORTEST PATHS

Instead of specifying a constraint on the path length - path length can be limited to the shortest ones that subject to the entities/relationships constraints. If for example, the shortest path length that subjects to the constraints is 3 - only paths with length 3 are valid assignments.

Here are two examples:

**Q47:** All shortest paths between these two dragons



**Q48:** All shortest paths between these two dragons, which are neither composed of 'freezes' relationships nor 'Dragon' entities

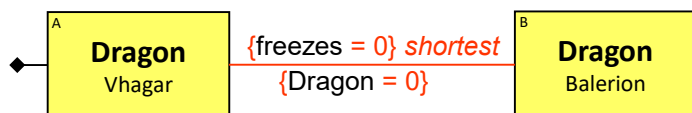

Shortest path may not appear directly right of an 'X' or a '→'.

## 24 PATH SEGMENTS

An alternative to constraints on the entities and the relationships along the path are constraints on **path segment types**. A path segment type is a valid chain of pattern-entities (concrete / ensemble / typed / logical / untyped) and pattern-relationships that starts and ends with a pattern-entity. There is an 'overlap' between successive segment types:

Each path is composed of consecutive path segments.

When a path segment contains a sequence of more than one entity:

- The type of the rightmost entity type of a segment must match the type of the leftmost entity in its successor
- The type of the leftmost entity type in the first segment of a path must match the entity type preceding the path
- The type of the rightmost entity type in the last segment of a path must match the entity type following the path

A red table below the path defines constraints on the path's segments types. The table has three columns:

- A constraint on the number of allowed path segments of this type along the path
- The path segment type
- An indication whether a 'mirror image' of this path segment type is allowed as well

Here are some examples:

**Q56: constraints on path segment types**

In this example, three path segment types are allowed

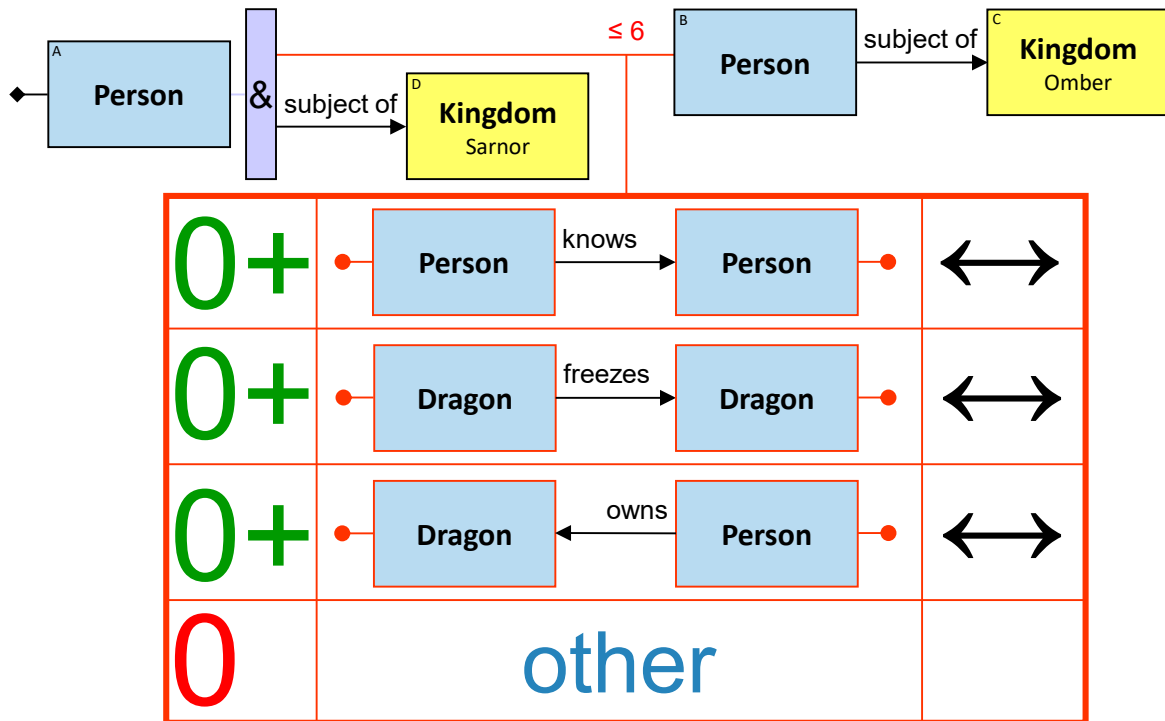

**Q57: constraints on path segment types**

In this example, one path segment type is disallowed, there must be between two and three path segments of one of two types, and any other path segments are allowed

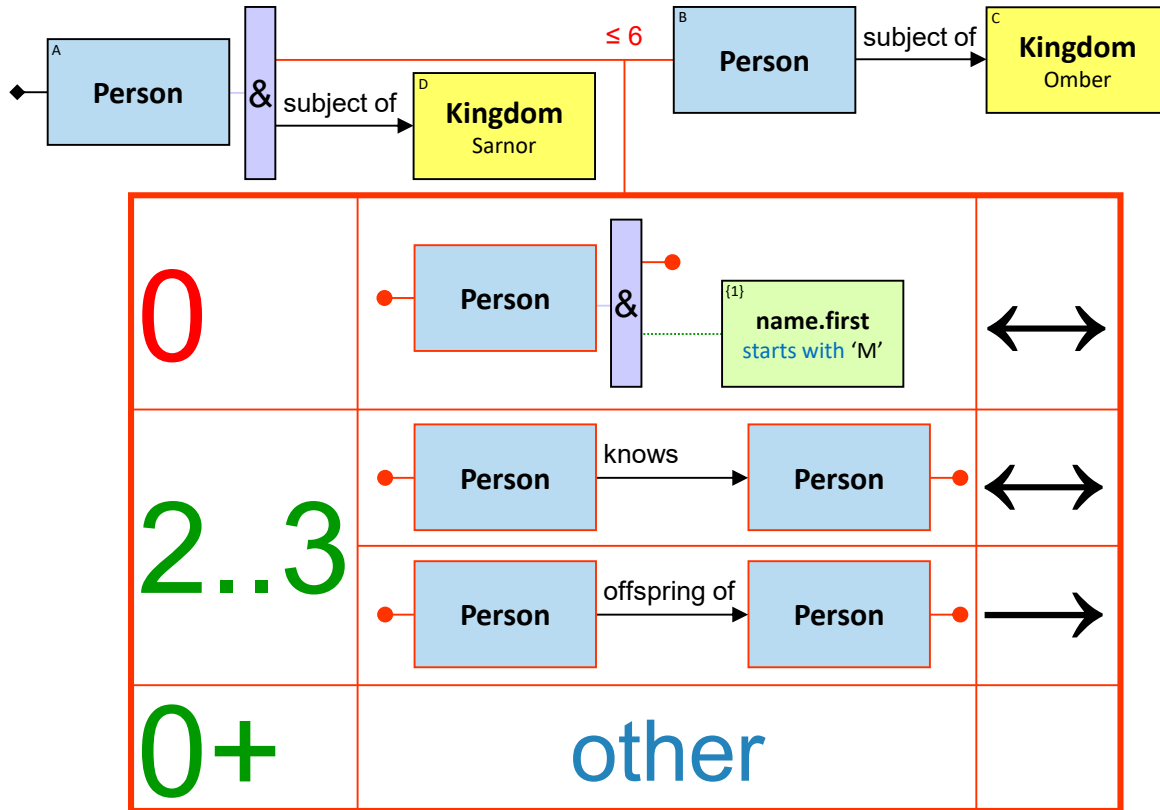

**Q58:** constraints on path segment types

In this example, the path must contain Rogar Bolton. Any other path segments are allowed

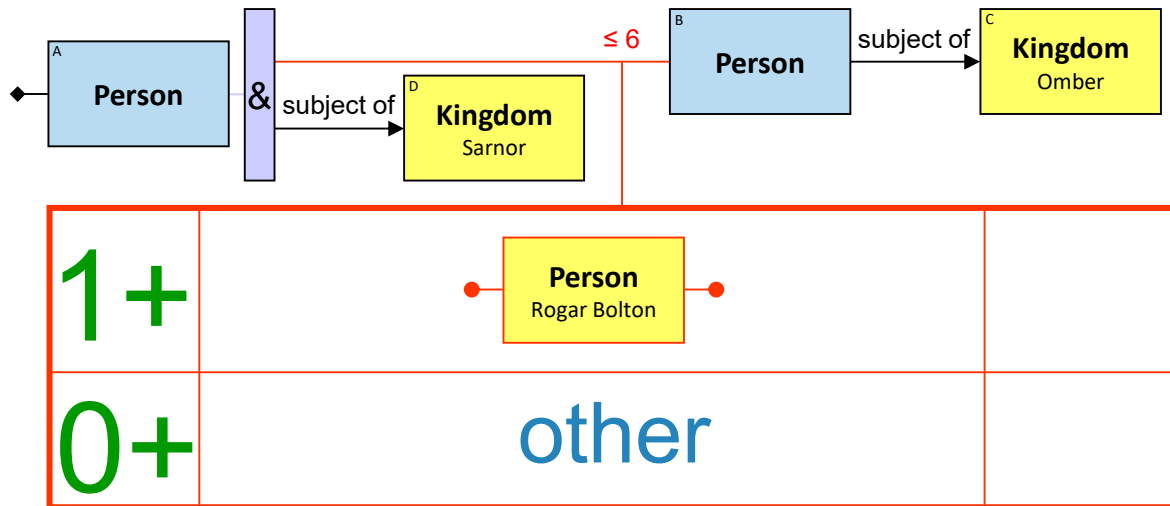

**Q322:** Any dragon that was owned by at least five consecutive generations of the same dynasty

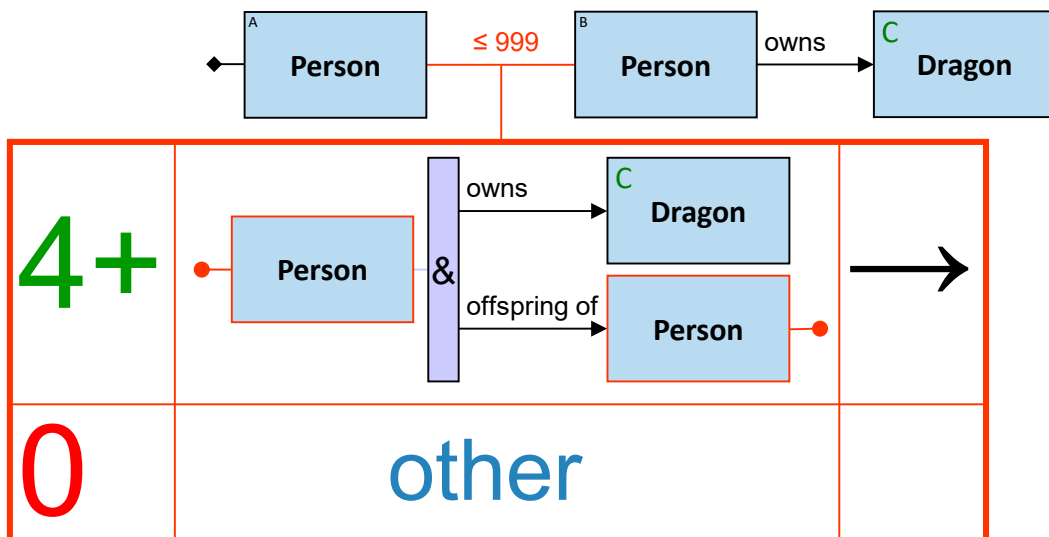

**Q323:** Any dragon that was owned by at least five (not necessarily consecutive) generations of the same dynasty

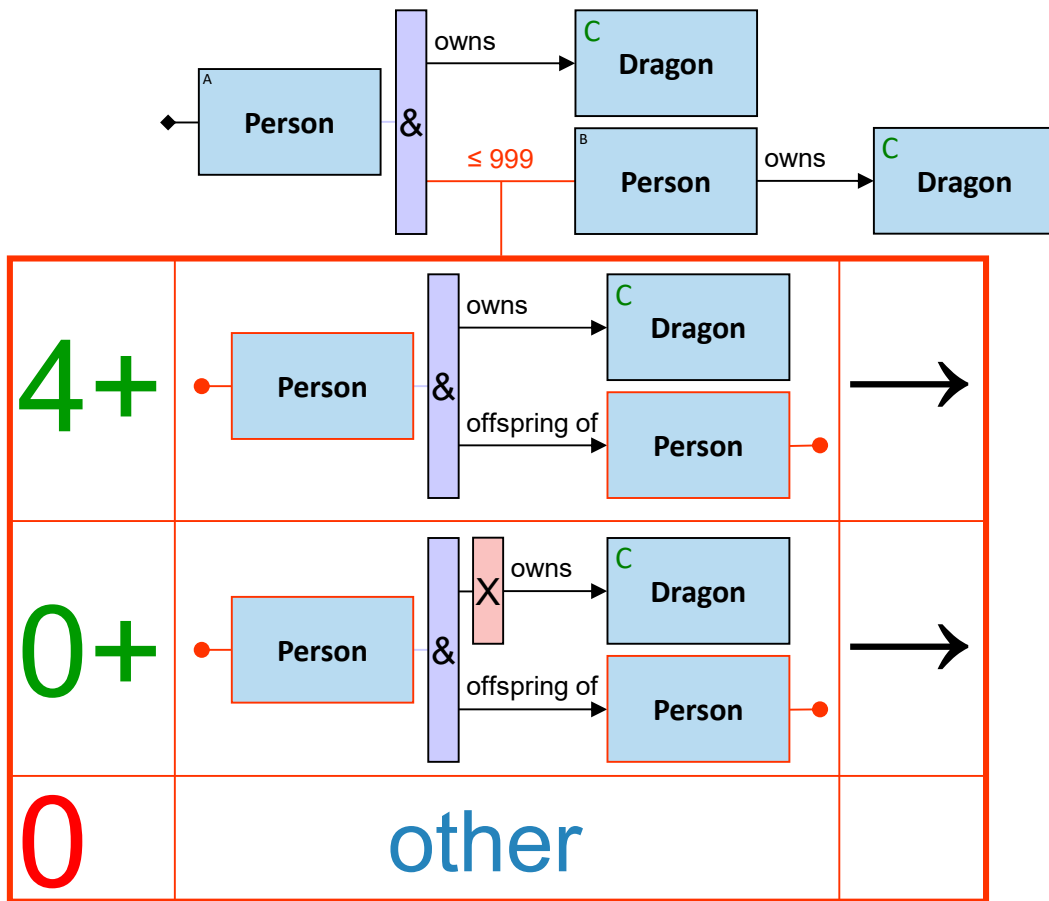

See also Q290

25 EXPRESSION TAGS

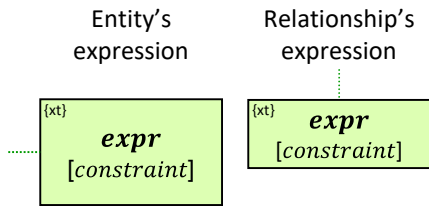

**Expression tag**, (*{xt}*) - Each green rectangle (entity's expression / relationship's expression) has an expression tag on its top-left corner, depicted by an index wrapped in curly brackets. The indexing of expression tags, aggregation tags, and split tags is joint, and each tag is unique.

An expression tag serves as a placeholder for the value of the expression in a given assignment. Expression tags may be used:

- as part of another expression tag's definition (see Q267v2, Q317)
- as part of another expression tag's constraint (see Q108, Q109)
- as part of an aggregation tag's definition (see Q116, Q117)
- as part of an aggregation tag's constraint (see Q120)
- as part of a min/max aggregation (see Q130, Q131)
- as part of a split definition (see Q226, Q227)
- as part of a split constraint (see Q255)

If an expression tag is used in any of these usages - it is depicted in bold purple. Otherwise - it is depicted in black.

Here are some examples:

**Q108:** *Any person who has the same birth-date as Brandon Stark*

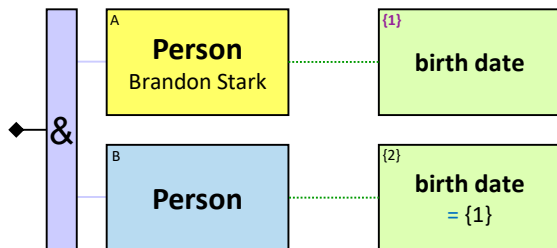



**Q109:** Any person whose parent owned a horse or a dragon prior to his birth

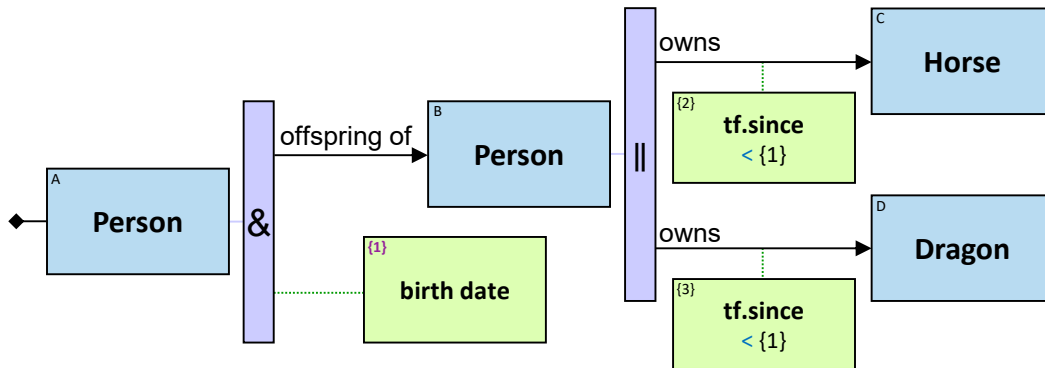

Note that if a branch contains a green rectangle with no constraint - the branch is always satisfied.

**Q110:** Any three dragons with cyclic freezes of more than 100 minutes, in chronological order, within a 6-month period, and their owners (if any)

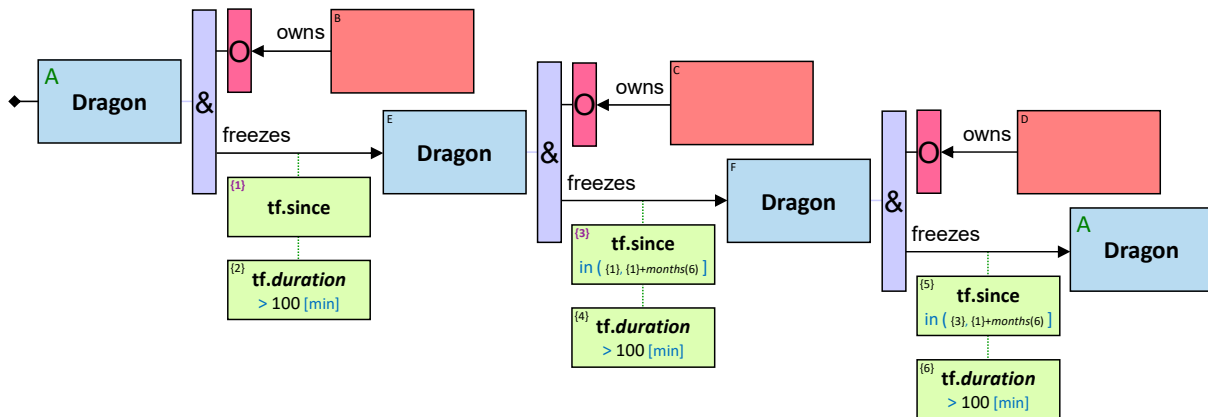

**Q111:** Any person who doesn't know someone with a birth date similar to his

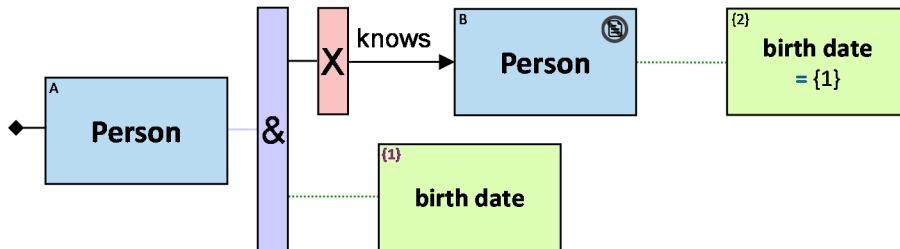

Composite properties, as well as sub-properties, are tagged and can be referenced similar to ordinary properties. Here are some examples:

**Q112:** *Any person who owned a horse and a dragon in the same time frames (two versions)*

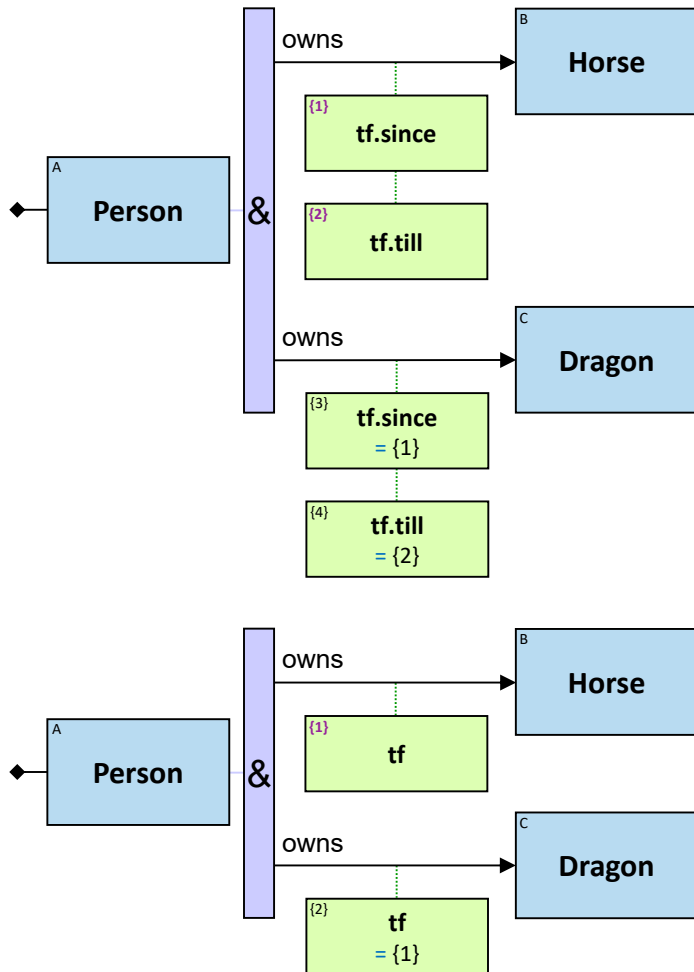

**Q266:** Any person who has the same name (first and last) as his parent (two versions)

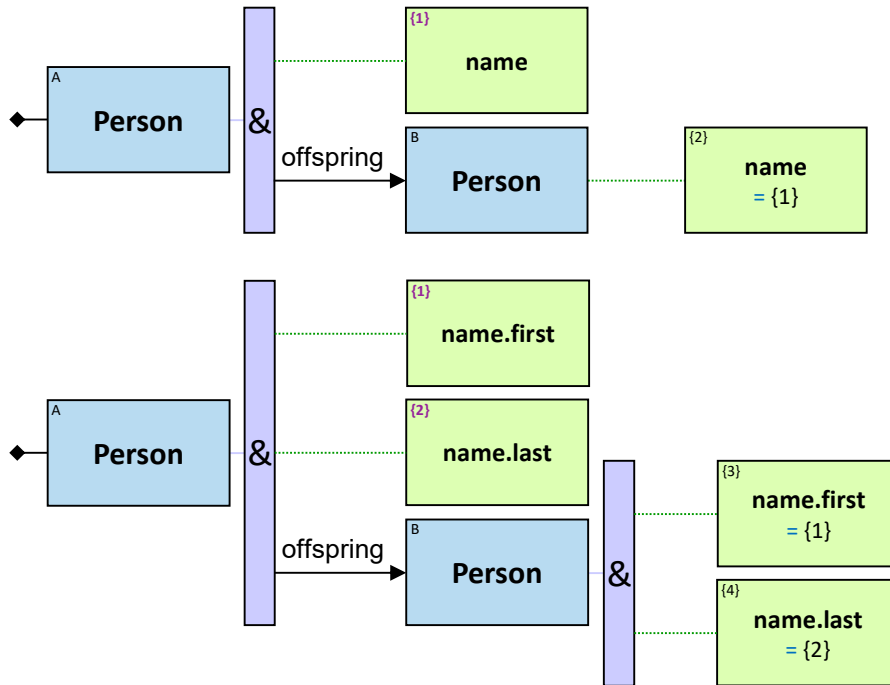

**Q267:** Any person who was a member of two guilds at intersecting timeframes (two versions)

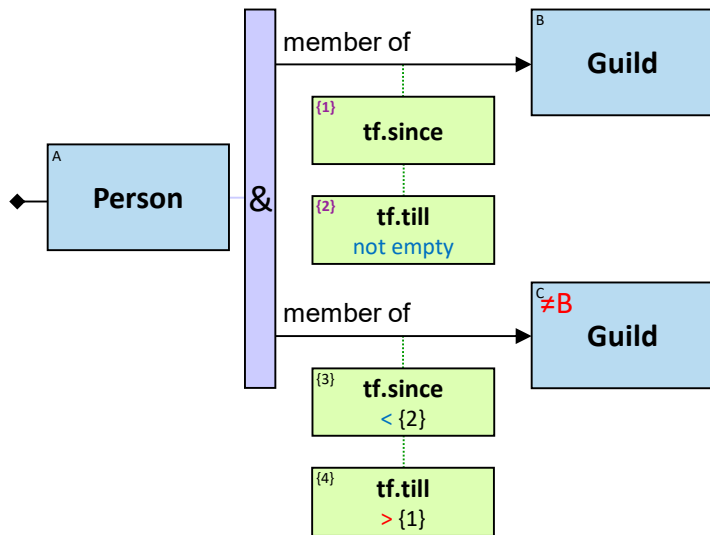

(Assuming that at least one of the *tf.till* values is not empty. See also note under Q11). Note the red comparison operator.

This is another option, but note that the *overlap* function returns 0 if either of the *since/till* values is empty:

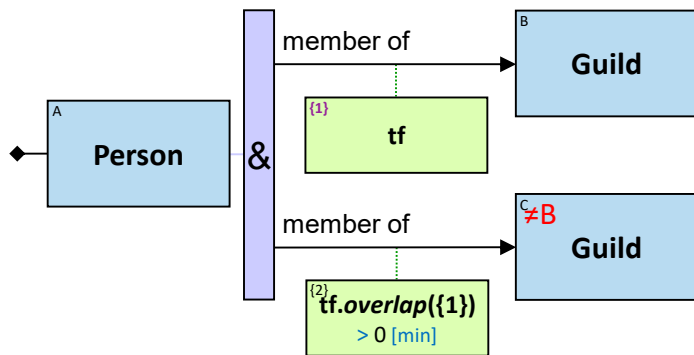

26 ENTITY TYPE TAGS



A red rectangle (denoting an untyped entity) may contain an **entity type tag**, depicted by a numeric index wrapped in **purple triangular brackets**. An entity type tag serves as a placeholder for the entity type in a given assignment, and can be used to define constraints on the type of other untyped entities.

Here are some examples:

**Q50:** Any person who owns (at least) two things of the same type

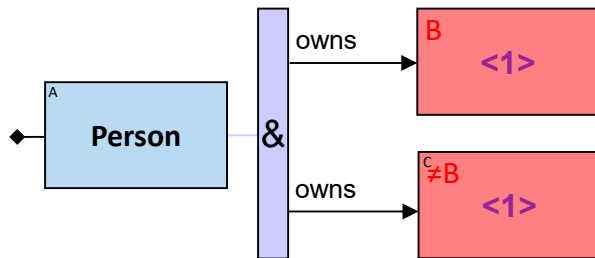

**Q51:** Any person who owns (at least) two things of different types

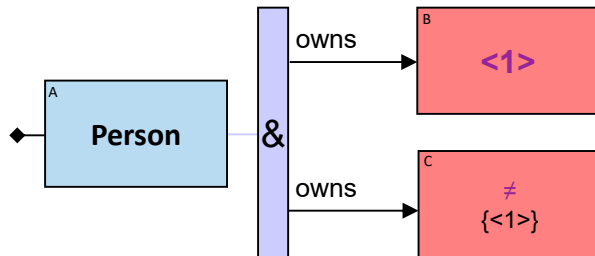

**Q52:** Any person who owns (at least) two things of different types, both are not horses

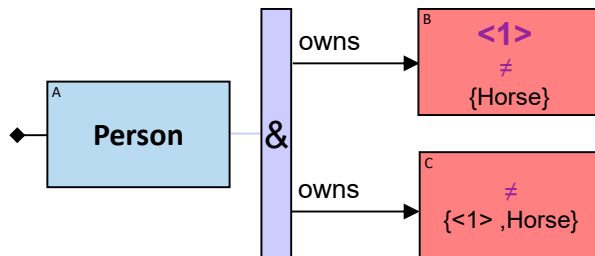

27 AGGREGATION CONSTRAINTS AND AGGREGATION TAGS

Sometimes we need to constrain assignments based on counts. Here are some examples:

1<sup>st</sup> example: *Any person having more than two parents*

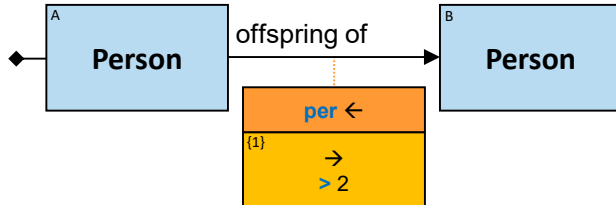

2<sup>nd</sup> example: *Any dragon that froze dragons more than 10 times*

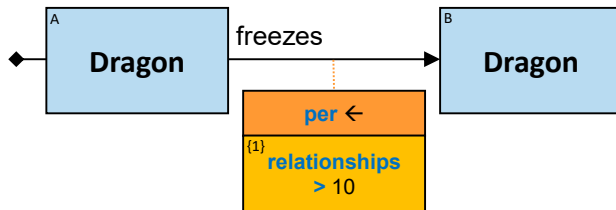

3<sup>rd</sup> example: *Any dragon pair (A, B) where A froze B for a cumulative duration longer than 100 minutes*

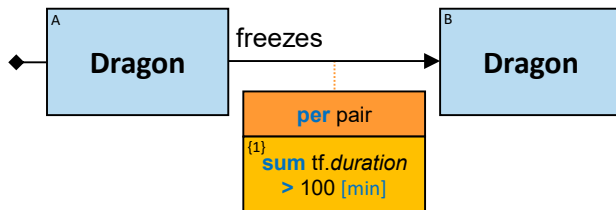

An orange rectangle represents an aggregation. It is composed of two parts:

- The top part (dark orange) defines how assignments are divided into sets
- The bottom part (light orange) defines how to aggregate each set, and may contain a constraint of the value of the aggregation

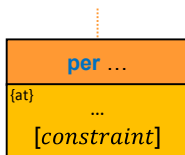

**Evaluating aggregations:**

Aggregations are not evaluated per assignment, but per set of assignments.

- Step 1: All assignments to the pattern without this aggregation (subject to aggregators evaluation order), are found
  - In the 1<sup>st</sup> example: Any pair of people (A, B) where A is an offspring of B
  - In the 2<sup>nd</sup> and 3<sup>rd</sup> examples: Any pair of dragons (A, B) where A froze B
  - See notes for L1/L2 aggregations when the constraint has the form ‘= 0’, ‘≥0’ or ‘in [0, expr]’
- Step 2: The assignments are divided into sets. In each set - all assignments to an element in the ‘per’ part of the aggregation are identical
  - In the 1<sup>st</sup> and 2<sup>nd</sup> examples: In each set - all assignments to A are identical
  - In the 3<sup>rd</sup> example: In each set - all assignments to both A and B are identical
- Step 3: Per each set of assignments - the aggregation tag (‘at’) is calculated
  - In the 1<sup>st</sup> example: Per person A: at = number of people he is offspring of
  - In the 2<sup>nd</sup> example: Per dragon A: at = cumulative number of its ‘freezes’ relationships to all dragons
  - In the 3<sup>rd</sup> example: Per pair of dragons A, B: at = sum of the duration of the ‘freezes’ relationships from A to B
- Step 4: Per each set of assignments : an (optional) aggregation constraint is evaluated
  - In the 1<sup>st</sup> example: Constraint: at > 2
  - In the 2<sup>nd</sup> example: Constraint: at > 10
  - In the 3<sup>rd</sup> example: Constraint: at > 1000 [min]
- Step 5: Sets of assignments for which the constraint is satisfied - are reported as valid assignments

Next, we’ll define four aggregation types: L1, L2, L3 and L4. Steps 1, 2, 4 and 5 are identical for all types. Step 3 is different, as sets are aggregated in different ways.

Let’s now get more formal.

Let *S* denote the set of all assignments to the pattern without this aggregation (subject to aggregators evaluation order) (that’s step 1 above).

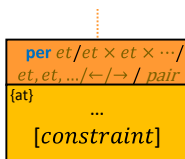

**Top part**

The top part has an identical structure for all aggregation types (L1, L2, L3, L4, M1, M2, M3, M4, R1, P1, P2, P3, P4 and S1).

Let *T* denote a list where each element holds an entity tag (*et*) or a Cartesian product of entity tags (*et1 × et2 × ...*).

The top part has one of the following formats:

- ‘*per et*’:  $T$  contains a single element:  $T[1] = et$
- ‘*per ←*’:  $T$  contains a single element:  $T[1] =$  entity-tag directly left of the aggregation
- ‘*per et1 × et2 × ...*’:  $T$  contains a single element:  $T[1] = et1 × et2 × ...$  (L1: see Q248, Q243, Q244)
- ‘*per et1, et2, ...*’:  $T = [et1, et2, ...]$
- ‘*per →*’:  $T$  contains all the entity-tags directly right of the aggregation (similar to ‘*per et1, et2, ...*’) (L1: see Q249, Q250 where  $T$  contains more than one element)
- ‘*per pair*’:  $T$  contains a single element:  $T[1] = et1 × et2$ , where  $et1$  is the entity-tag directly left of the aggregation and there is a single entity-tag directly right of the aggregation -  $et2$  (L2: see Q75)

When possible, the visual notations ‘←’ and ‘→’ are used instead of entity tags.

Next, let  $TA$  denote a list where each element  $TA[m]$  is a list of all unique assignments to  $T[m]$  in  $S$ . ( $TA[m][n]$  contains the  $n^{\text{th}}$  unique assignment to  $T[m]$ ).

Let  $S(m,n)$  denote a subset of  $S$ : the set of all assignments composed of  $TA[m][n]$ . ( $S(m,n)$  contains the set of all assignments to the pattern which are composed of the  $n^{\text{th}}$  unique assignment to  $T[m]$ ). (that’s step 2 above).

### Bottom part

**Aggregation tag** - ‘*at*’ - Each orange rectangle has an aggregation tag on the top-left corner of its lower part, depicted by an index wrapped in curly brackets. The aggregation tag’s value is calculated separately for each  $(m,n)$ . For example, if the number of parents a person have is assigned to  $\{2\}$ ,  $\{2\}$  has a different assignment per each person. The indexing of expression tags, aggregation tags, and split tags is joint, and each tag is unique.

For each  $m$ ,  $at$  is a *calculated property* of the  $n^{\text{th}}$  unique assignment to  $T[m]$ .

Aggregation tags may be used:

- as a parameter / part of a parameter to a function applied to some expression tag
- as part of an expression tag’s constraint
- as part of another aggregation tag’s definition (see Q129, Q181)
- as part of another aggregation tag’s constraint (see Q125, Q127)
- as part of a min/max aggregation (see Q91, Q132)
- as part of a split definition (see Q253)
- as part of a split constraint (see Q254)

If an aggregation tag is used in any of these usages - it is depicted in bold purple. Otherwise - it is depicted in black.



28 L1 AGGREGATION

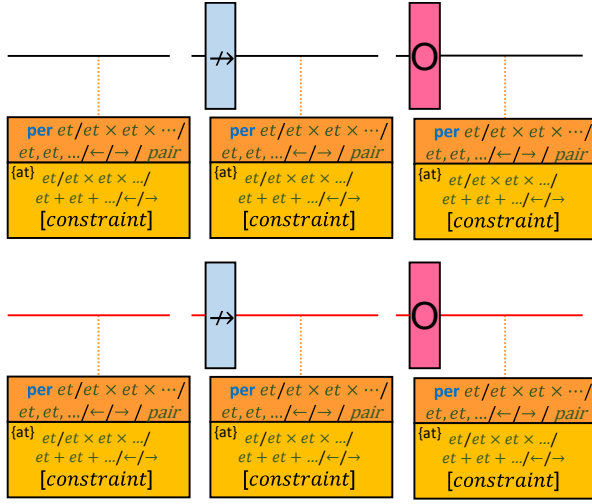

**Bottom part:**

Let  $B$  denote a list where each element holds an entity tag ( $et$ ) or a Cartesian product of entity tags ( $et1 \times et2 \times \dots$ ).

The bottom part has one of the following formats:

- ‘ $et$ ’:  $B$  contains a single element:  $B[1] = et$  (see Q136, Q247, Q166, Q165, Q122)
- ‘ $\leftarrow$ ’:  $B$  contains a single element:  $B[1] =$  entity-tag directly left of the aggregation (see Q249, Q250)
- ‘ $et1 \times et2 \times \dots$ ’:  $B$  contains a single element:  $B[1] = et1 \times et2 \times \dots$
- ‘ $et1 + et2 + \dots$ ’:  $B = [et1, et2, \dots]$  (see Q295)
- ‘ $\rightarrow$ ’:  $B$  contains all the entity tags directly right of the aggregation (similar to ‘ $et1 + et2 + \dots$ ’) (see Q294, Q175, Q176 where  $B$  contains more than one element)

L1 appears below a relationship / path / quantifier-input.

- A relationship / path with an L1 below it may be wrapped by a ‘ $\square$ ’ or an ‘O’.
- A quantifier-input with an L1 below it may be wrapped by an ‘O’. Any branch which does not start with an entity’s expression may be wrapped by an ‘X’, a ‘ $\square$ ’ or an ‘O’.
- When L1 appears directly before a quantifier / sequence of quantifiers - at least one branch must start with a relationship / path that is not wrapped by an ‘X’.

When the constraint has the form ‘ $= 0$ ’, ‘ $\geq 0$ ’ or ‘ $in [0, expr]$ ’, we’ll first wrap the relationships / paths preceding any entity tag composing  $B$  with an ‘O’ (if not already wrapped).

Let  $BA(m,n,o)$  denote the set of all assignments to  $B[o]$  in  $S(m,n)$ .

For each  $(m,n)$ :

- **aggregation tag:**  $at(m,n) = |BA(m,n,1) \cup BA(m,n,2) \cup \dots|$

We are using *cardinality(union(all assignments to all elements in B))* instead of *sum(cardinality(assignment to one element in B))* since two elements in  $B$  may be have the same assignment (see Q175), and we are counting *distinct* assignments to all elements in  $B$  per  $\{m,n\}$ .

- Optional: a **constraint** on  $at(m,n)$  in one of these forms:
  - $= expr / \neq expr / > expr / \geq expr / < expr / \leq expr$
  - $in (expr .. expr) / in (expr .. expr] / in [expr .. expr) / in [expr .. expr]$
  - $in \{expr, expr, \dots expr\}$

' $\neq expr$ ', ' $< expr$ ' and ' $\leq expr$ ' are satisfied only if  $at(m,n) > 0$ .

When the constraint has the form ' $= 0$ ', ' $\geq 0$ ' or ' $in [0, expr]$ ' - All entity tags composing  $B$  must be defined right of the aggregator (see Q81, Q64, Q165).

**For each  $(m,n)$ :  $S(m,n)$  is reported only if  $at(m,n)$  satisfies the constraint**

Notes:

- $T$  and  $B$  may not intersect.
- L1 location:
  - If all entities in  $T \cup B$  are in a sequence: if all the entities in  $T$  appear right of all the entities in  $B$ : left of the rightmost entity in  $T$  (see Q247). Otherwise: right of the leftmost entity in  $T$  (see Q243)
  - If some entities in  $T \cup B$  are defined in different branches of a quantifier: directly before the quantifier (see Q27, Q249, Q299)
  - As part of an aggregation chain (see Q158)
- All entities composing  $T$  and  $B$  should be within scope at the aggregator (see section 40 – Tag rules).

Examples:

**Q59:** Any person having more than two parents

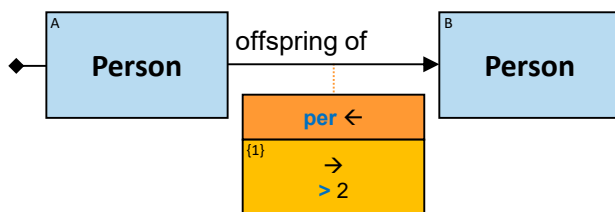

**Q60:** Any dragon that was frozen by exactly five dragons

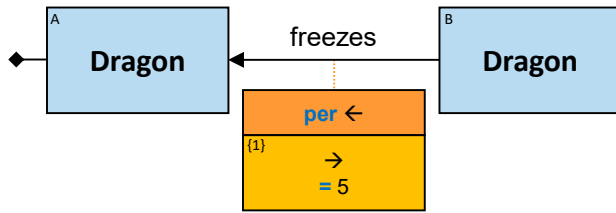

Note that if some dragon A was frozen by some dragon B more than once - B would still be counted only once per A. L1 counts *distinct* entity assignments.

**Q61:** Any entity that owns more than two entities

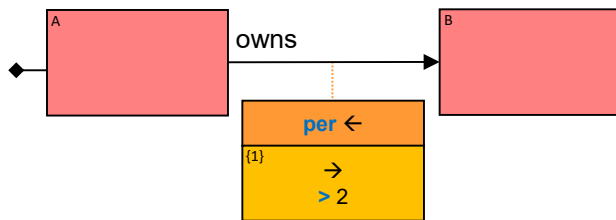

**Q62:** Any person who is within graph distance  $\leq 4$  from more than five people

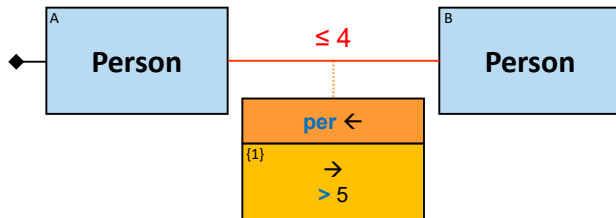

**Q136:** Any dragon A that froze (dragons that froze dragons B). The cumulative number of distinct Bs (per A) is greater than 100 (two versions)

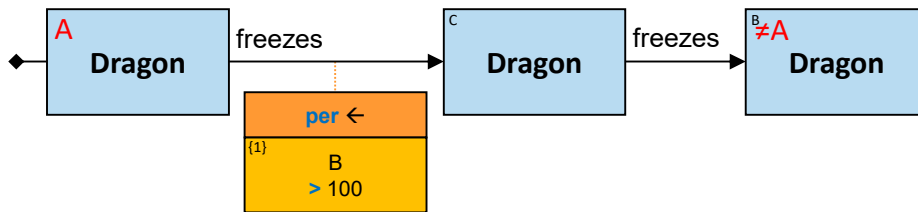

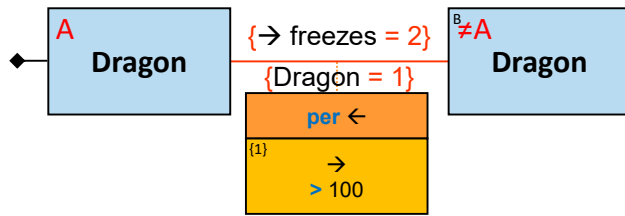

*Q81: Any dragon that didn't freeze any dragons*

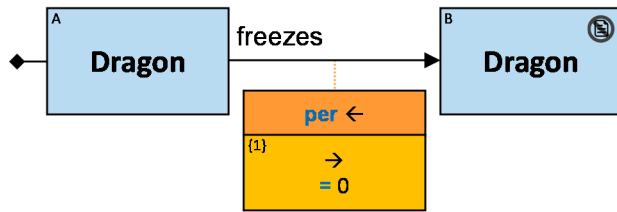

*Q82: Any dragon that was never frozen*

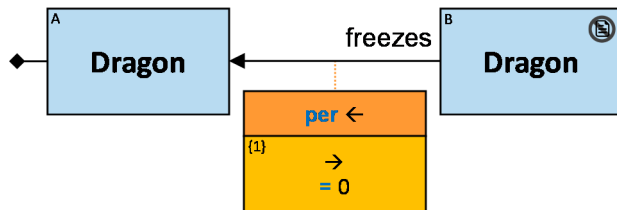

*Q177: Any dragon pair (A, B) were A was frozen by at least 10 B's, and froze each one of those (two versions)*

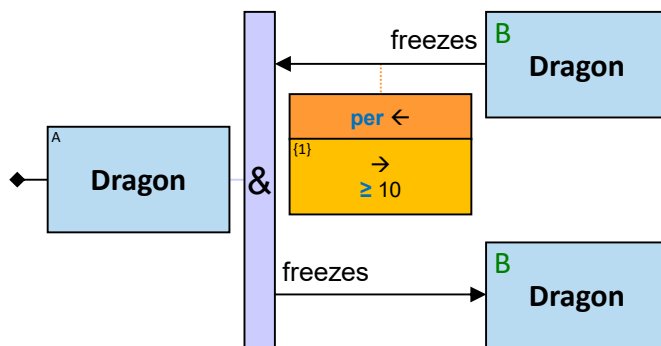

First, any pair (A, B) that matches the pattern is found. Then, the aggregation constraint is checked:

For each assignment to A:

- There are at least 10 assignments to B such that (B froze A, and A froze B)

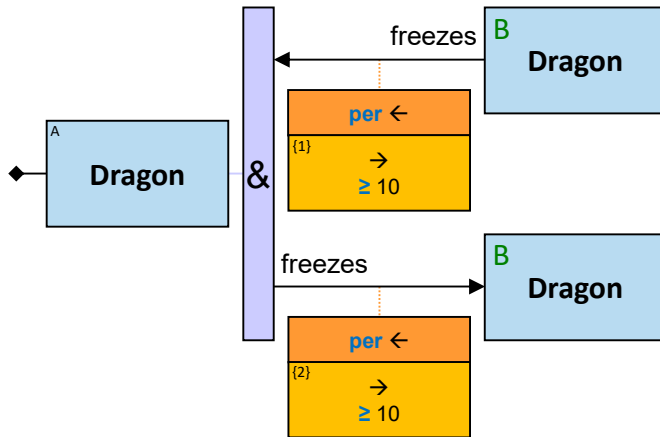

For each assignment to A:

- There are at least 10 assignments to B such that (B froze A, and A froze B)
- There are at least 10 assignments to B such that (A froze B, and B froze A)

**Q178:** Any dragon A that was frozen by at least 10 dragons and either (i) A froze only one dragon - which is not one of those, or (ii) A froze at least two dragons

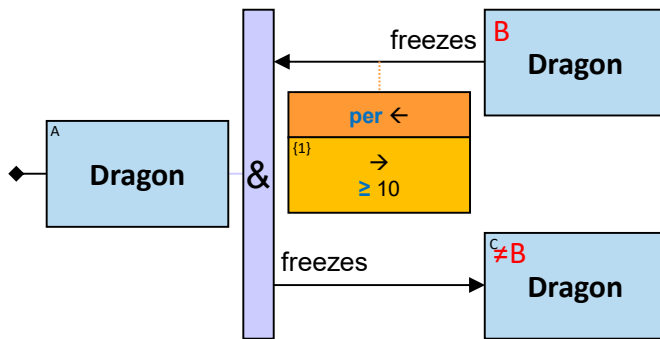

First, any triplet (A, B, C) that matches the pattern is found. Then, the aggregation constraint is checked:

For each assignment to A:

- There are at least 10 assignments to B such that (B froze A, and A froze a dragon that is not B)

Hence, for each assignment to A:

- At least 10 dragons froze A and either (i) A froze only one dragon - which is not one of those, or (ii) A froze at least two dragons

**Q85:** Any dragon that froze at least 10 dragons, and was frozen by at least 10 dragons (two versions)

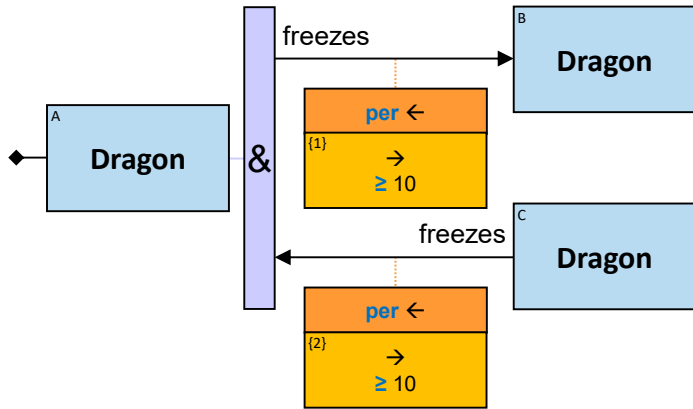

This 2<sup>nd</sup> version is for illustrative purposes only...



First, any triplet (A, B, C) that matches the pattern is found. Then, the aggregation constraints are checked:

For each assignment to A:

- There are at least 10 assignments to B such that (B froze A, and A froze a dragon that is not B)
- There are at least 10 assignments to C such that (A froze C, and A was frozen by a dragon that is not C)

Hence, for each assignment to A:

- At least 10 dragons froze A and either (i) A froze only one dragon - which is not one of those, or (ii) A froze at least two dragons

and also

- A froze at least 10 dragons and either (i) only one dragon froze A - which is not one of those, or (ii) at least two dragons froze A

Hence:

- A froze at least 10 dragons, and at least 10 dragons froze A

**Q101:** Any person who owns at least 10 white horses

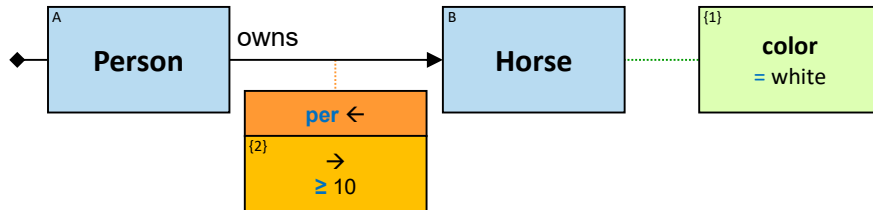

**Q102:** Any dragon that was frozen by at least two dragons; each of these two dragons was frozen by at least one dragon

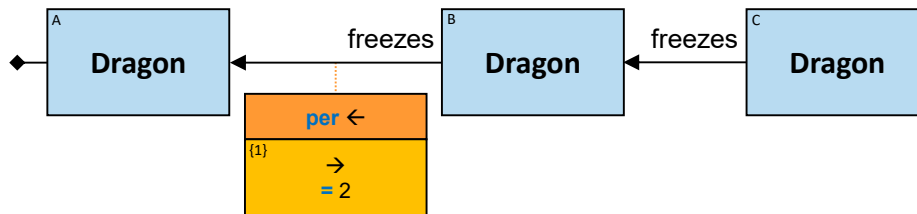

**Q246:** Any dragon B that froze dragons and that was frozen by more than 10 dragons

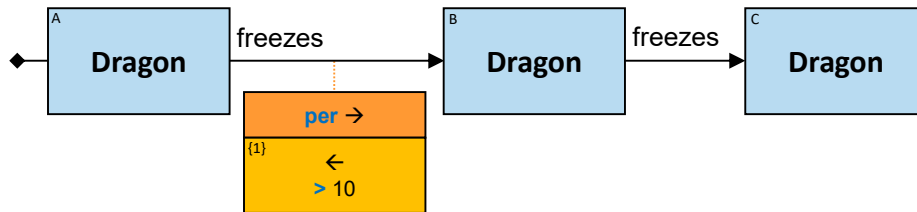

**Q247:** Any dragon C that more than 10 dragons (cumulatively) froze dragons that froze it

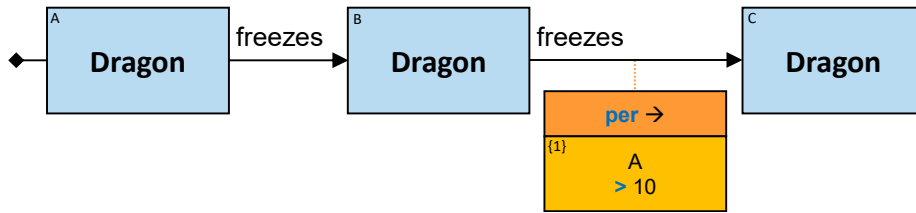

**Q166:** Any dragon that more than five Sarnorian subjects own a dragon that froze it

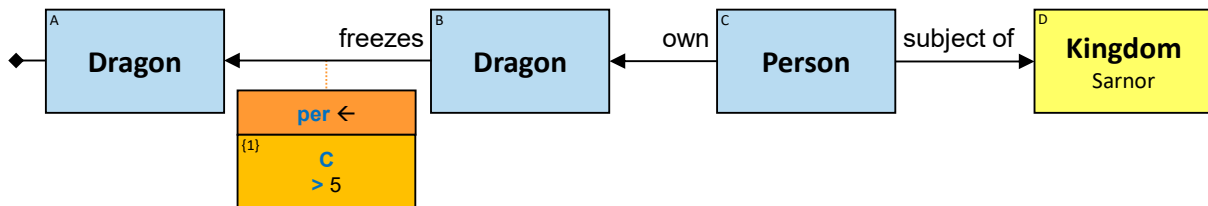

**Q113:** Any person who knows at least five people with a birth data similar to his

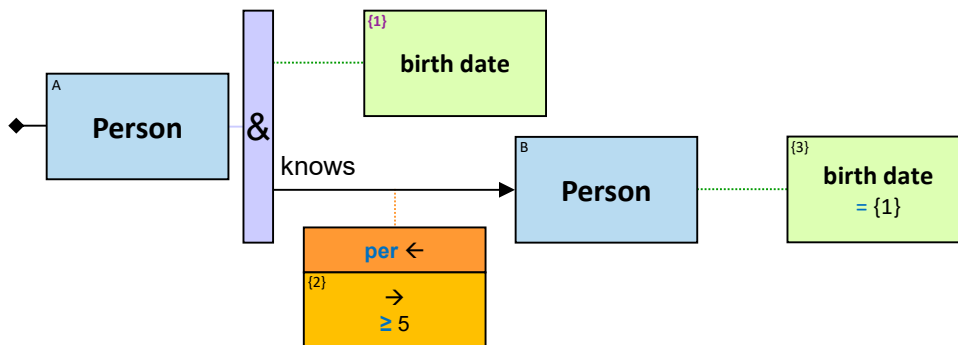

**Q114:** Any person who owns more than five horses of the same color

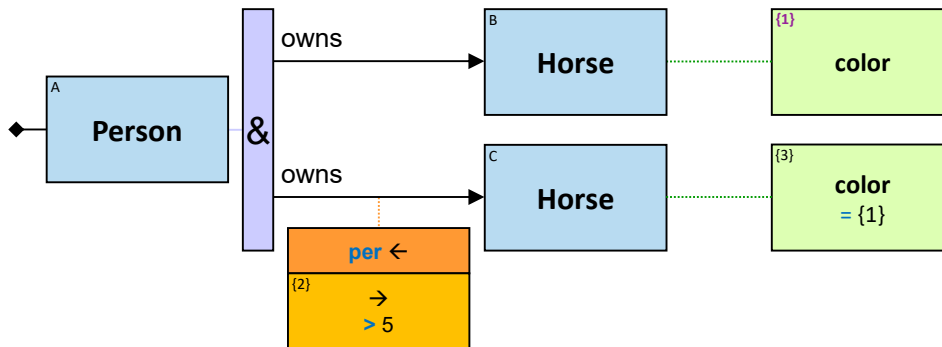



**Q125:** Any dragon that the number of dragons it froze is greater than the number of dragons that froze it

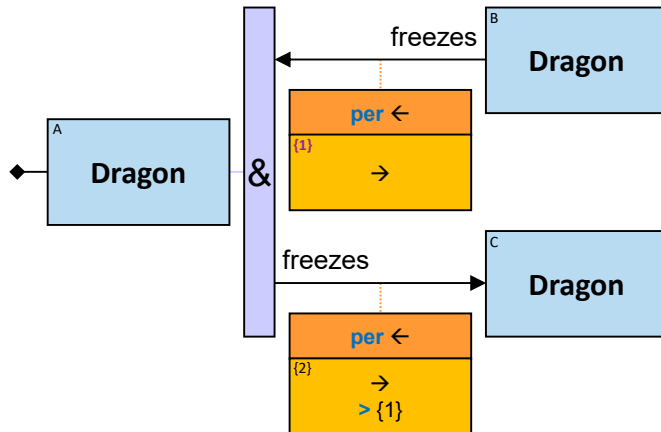

**Q126:** Any dragon that the number of dragons it froze is greater than the number of dragons it didn't freeze

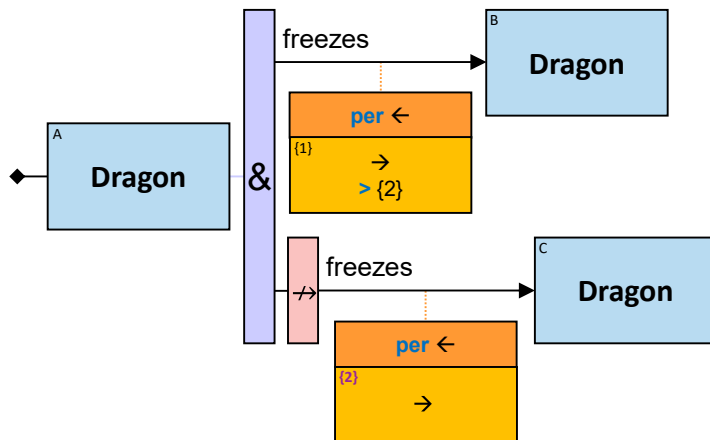

**Q292:** Any person that at least 80% of his horses are black

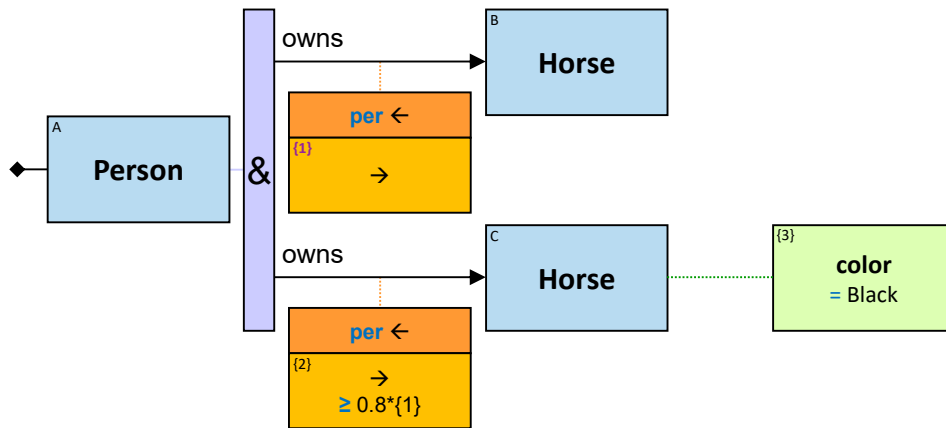

**Q63:** Any Masons Guild member who more than five Masons Guild members don't know

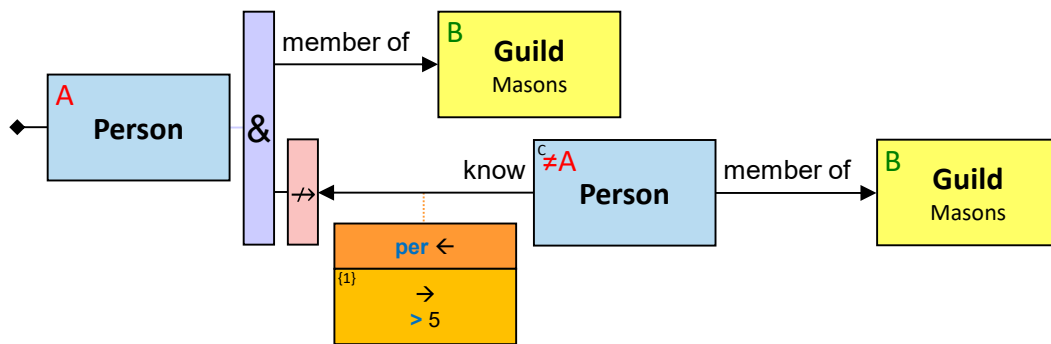

**Q65:** Any person who doesn't own more than two things whose spouse owns

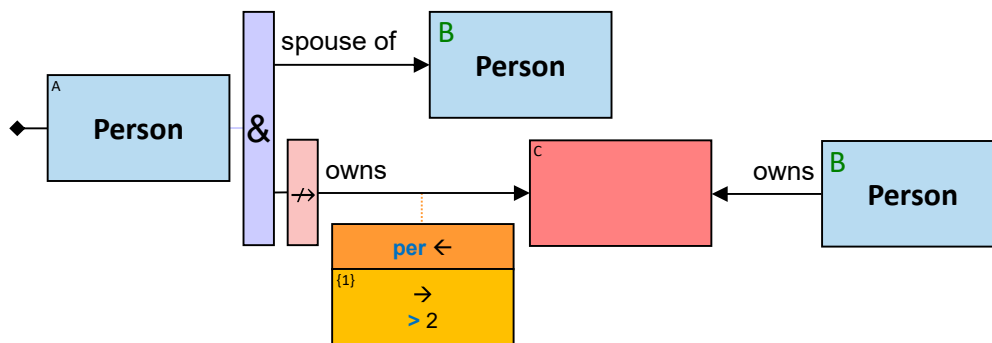

**Q64:** Any *dragon* that between zero and four (dragons owned by Sarnorian subjects) didn't freeze it

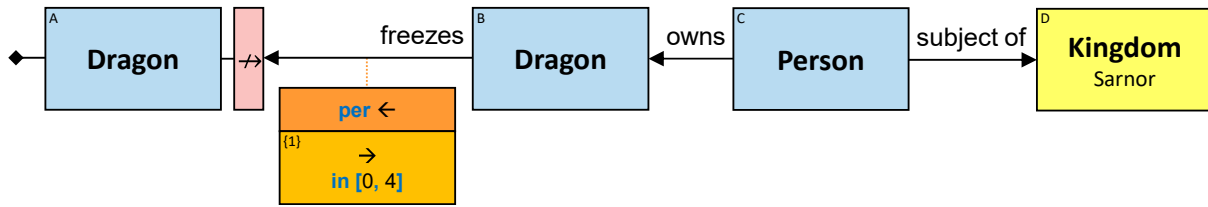

**Q165:** Any *dragon* that between zero and four (Sarnorian subjects own a dragon that didn't freeze it)

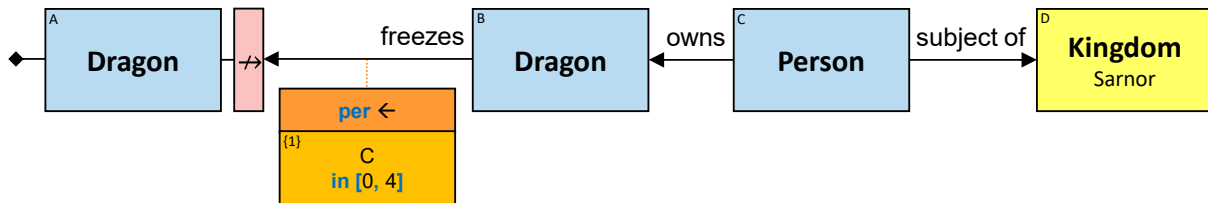

**Q66:** Any person from whom more than five people are not within graph distance  $\leq 6$

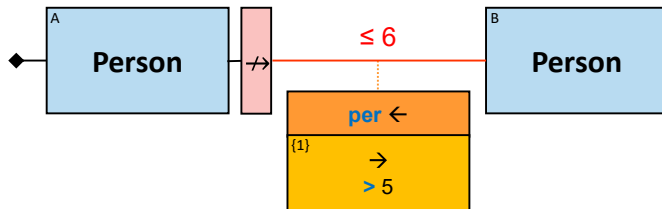

**Q151:** Any person who owns more than 10 horses, at least one is Sarnorian. Only the Sarnorian horses will be returned

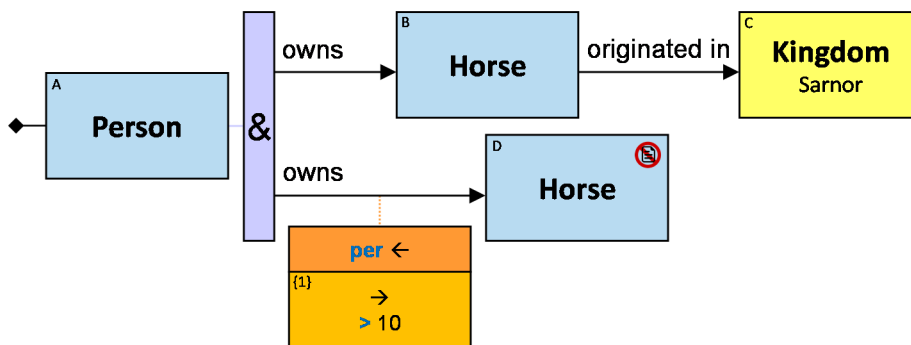

**Q152:** Any person who owns more than 10 horses. Only the Sarnorian horses will be returned

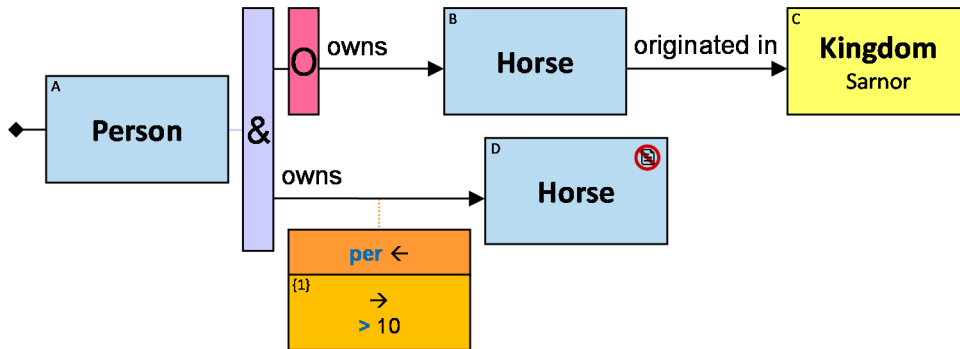

**Q305:** Any person that the number of horses he owns + the number of dragons he owns - is at least 10

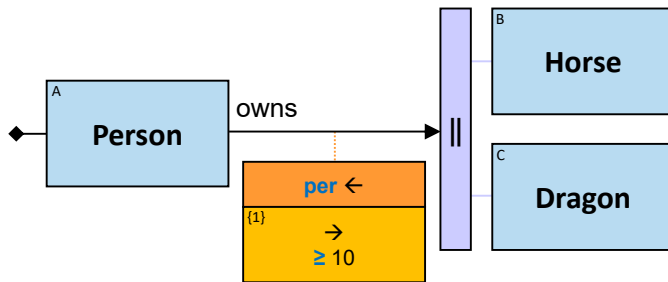

**Q121:** Any dragon that froze or fired at at least 10 dragons

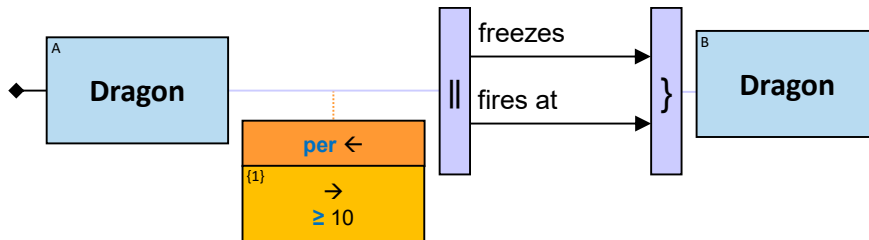

(‘→’ is the entity directly right of the combiner (in this example - B))

Note that each dragon that was both frozen and fired at - would be counted only once.

**Q122:** Any dragon that fired at dragon B, and fired at a dragon that fired at B - for at least 10 different B's

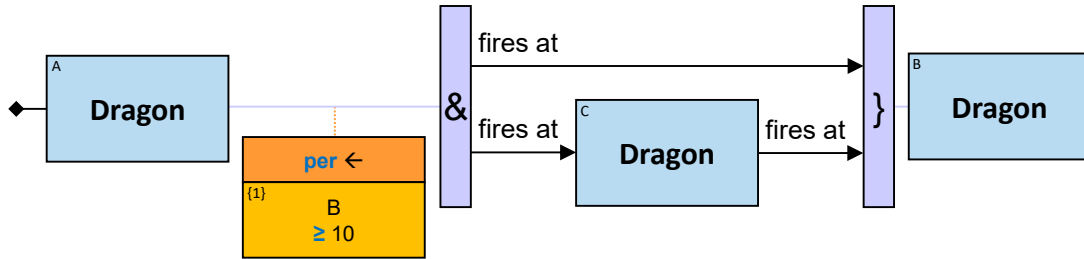

**Q294:** Any dragon that fired at Balerion and at least nine other dragons

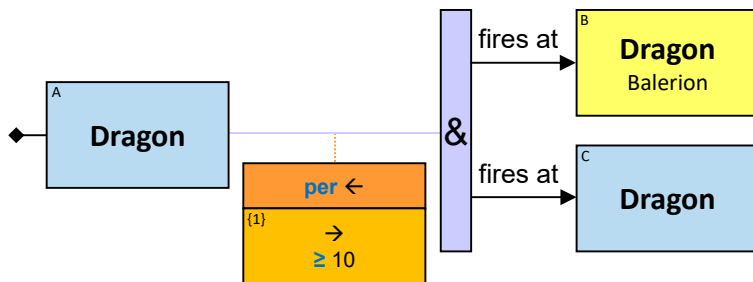

**Q175:** Any dragon that froze at least once, and fired at least once. The number of dragons it froze/fired at - is at least 10

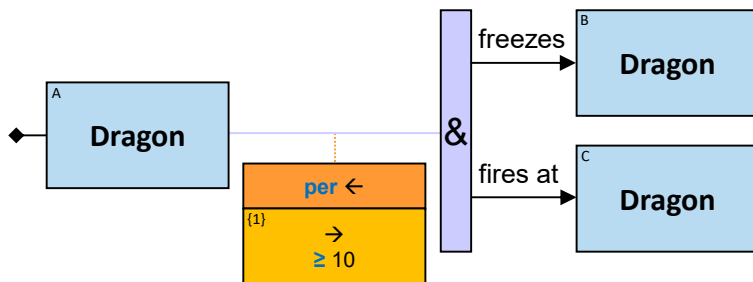

Note that if a dragon was both froze and fired at - it would be counted only once. L1 counts *distinct* entity assignments.

**Q298:** Any person *A* where (i) *A* doesn't own horses weighing less than 100 Kg, (ii) there is at least one horse weighing between 100 and 200 Kg that *A* doesn't own, (iii) there is at least one horse weighing between 200 and 300 Kg that *A* owns, and (iv) the number of horses weighing between 100 and 200 Kg that *A* doesn't own + the number of horses weighing more than 200 Kg that *A* owns - is at least 10. Horses weighing between 200 and 300 Kg are not reported (only their owners are reported)

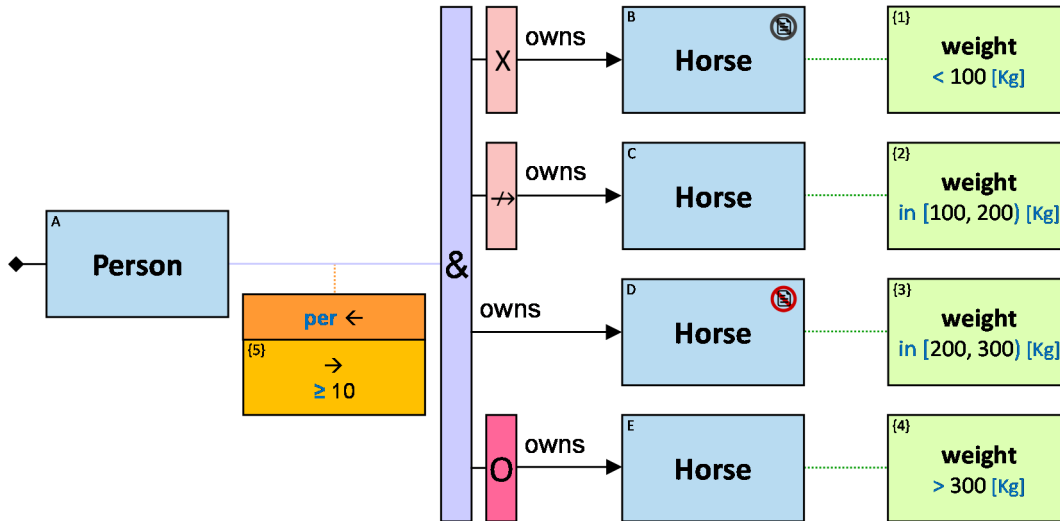

1<sup>st</sup> step: all assignments to the pattern, without the aggregation, are found:

Any person *A* where (i) *A* doesn't own horses weighing less than 100 Kg, (ii) there is at least one horse weighing between 100 and 200 Kg that *A* doesn't own, and (iii) there is at least one horse weighing between 200 and 300 Kg that *A* owns.

2<sup>nd</sup> step: aggregation per *A* assignment:

For each assignment to person *A* found in the 1<sup>st</sup> step - leave only those for which the number of horses weighing between 100 and 200 Kg that *A* doesn't own + the number of horses weighing more than 200 Kg that *A* owns - is at least 10.

**Q176:** Any dragon that either (i) froze at least one dragon and fired at at least one dragon it didn't froze. The number of dragons it froze/fired at is at least 10, or (ii) froze at least 10 dragons

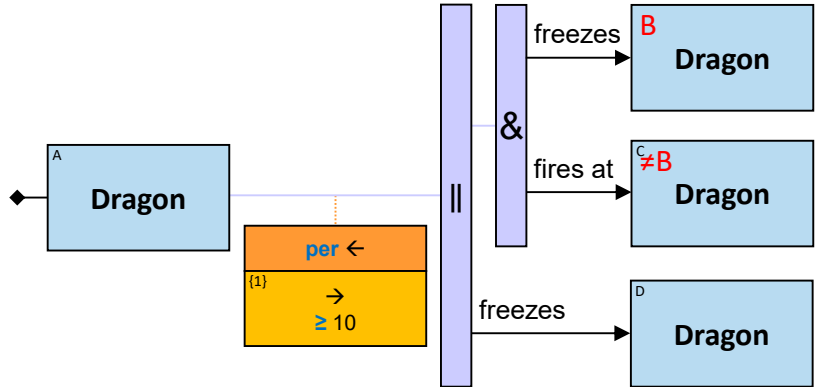

**Q295:** Any person that the number of horses he owns + the number of dragons his dragons froze - is at least 10

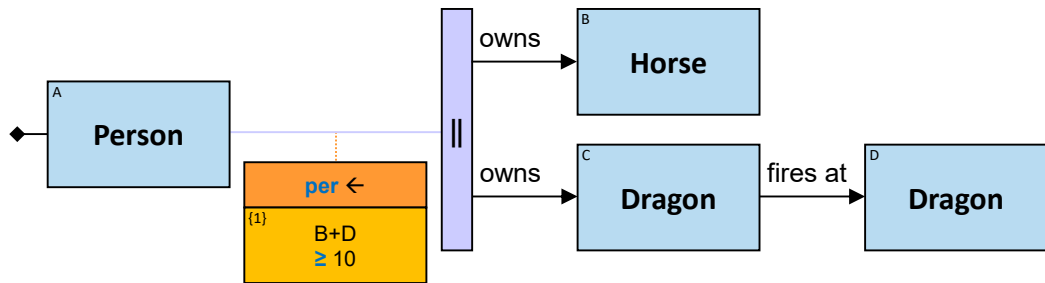

**Q293:** Any person that at least 80% of the horses owned by him and/or by (at least) one of his parents - are jointly owned by him and by (at least) one of his parents

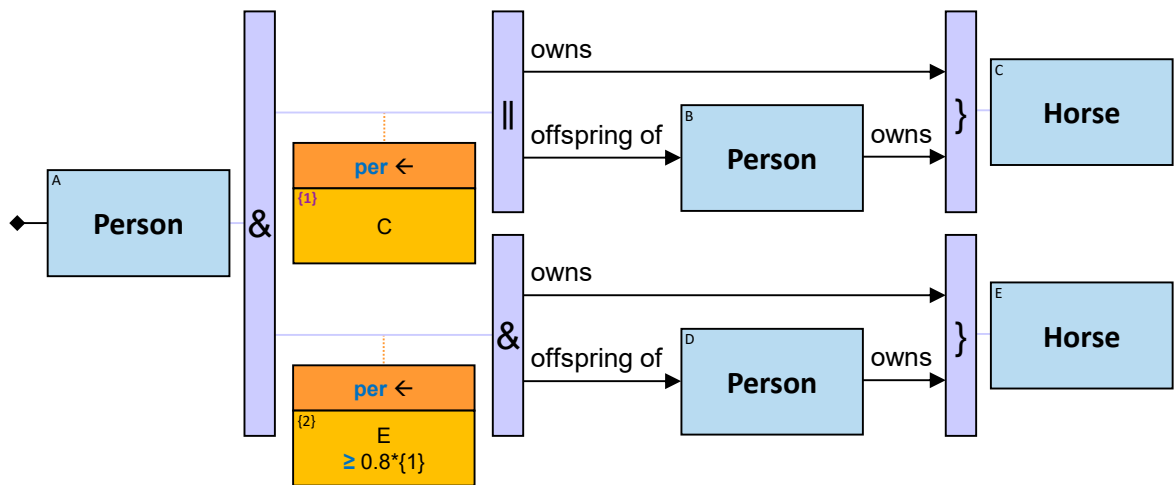

**Q288:** Any person *A* who owns a dragon that froze more dragons than any dragon owned by any of *A*'s ancestors

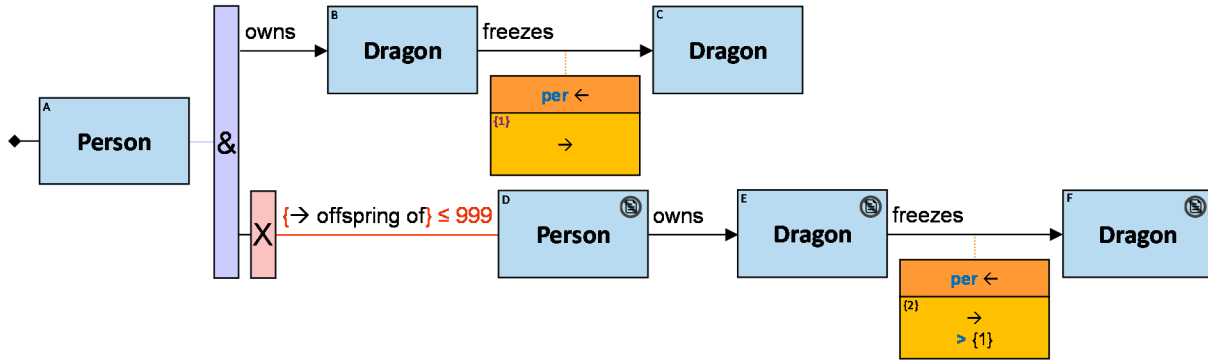

**Q290:** Any path of maximal length 10 between Rogar Bolton and Robin Arryn that doesn't contain hubs (in this pattern - hubs are entities with degree  $\geq 1000$ )

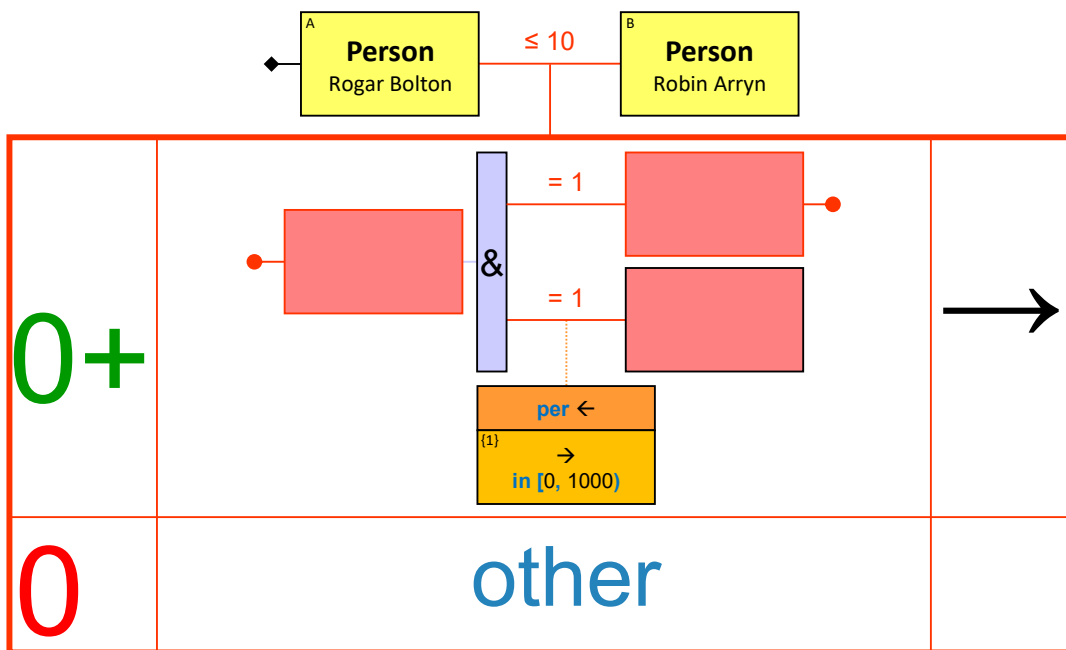



**Q249:** Any dragon that froze at least one dragon, **and** fired at at least one dragon. Any dragon frozen - was frozen by at least 10 dragons. Any dragon fired at - was fired at by at least 10 dragons

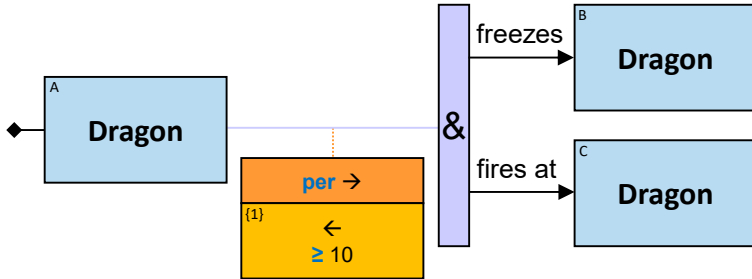

**Q250:** Any dragon that froze at least one dragon, **or** fired at at least one dragon. Any dragon frozen - was frozen by at least 10 dragons. Any dragon fired at - was fired at by at least 10 dragons

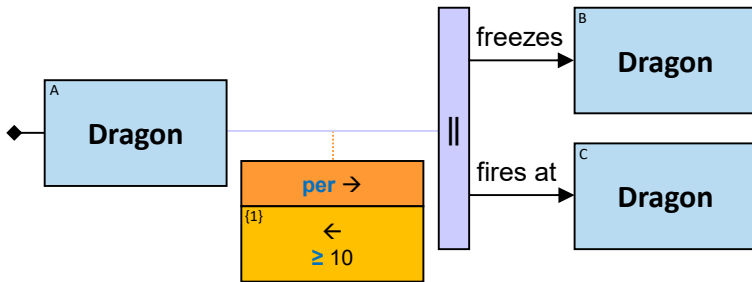

**Q299:** See evaluation below

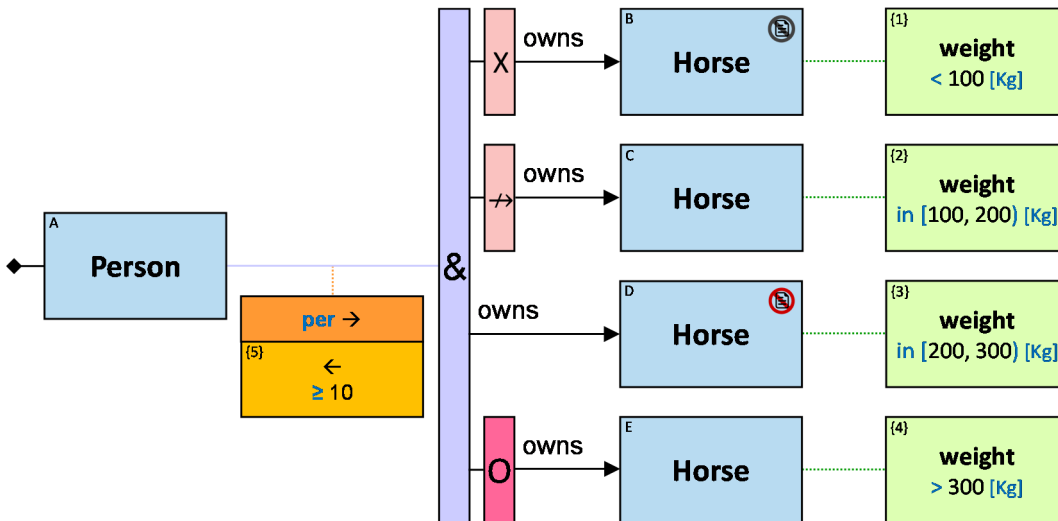

1<sup>st</sup> step: all assignments to the pattern, without the aggregation, are found (same as Q298):

Any person A where (i) A doesn't own horses weighing less than 100 Kg, (ii) there is at least one horse weighing between 100 and 200 Kg that A doesn't own, and (iii) there is at least one horse weighing between 200 and 300 Kg that A owns.

2<sup>nd</sup> step: aggregation per C assignment, aggregation per D assignment, and aggregation per E assignment:

For each assignment to horse C found in the 1<sup>st</sup> step - leave only those that at least 10 person A assignments found on the 1<sup>st</sup> step don't own. For each assignment to horses D or E found in the 1<sup>st</sup> step - leave only those that at least 10 person A assignments found on the 1<sup>st</sup> step own.

Horses weighing between 200 and 300 Kg are not reported (only their owners are reported).

*Q248: Any dragon pair (A, C) where A froze more than 10 dragons that froze C*

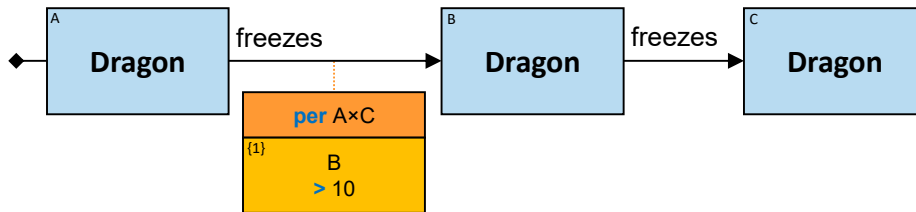

*Q243: Any pair of people (A, D) where at least five of A's dragons froze one or more D's dragons*

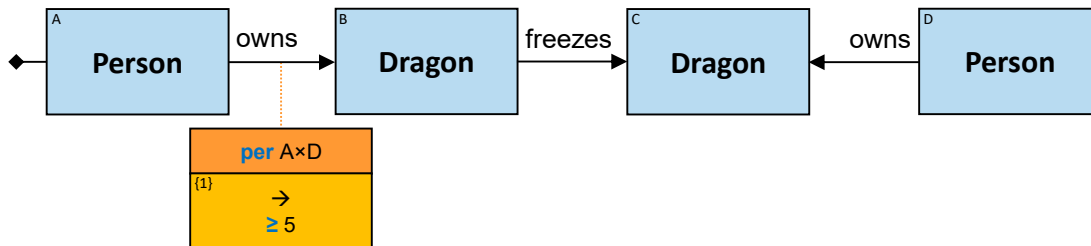

**Q244:** Any pair of people (A, D) where at least five of A's dragons froze D's dragons, and at least five D's dragons were frozen by one or more A's dragons

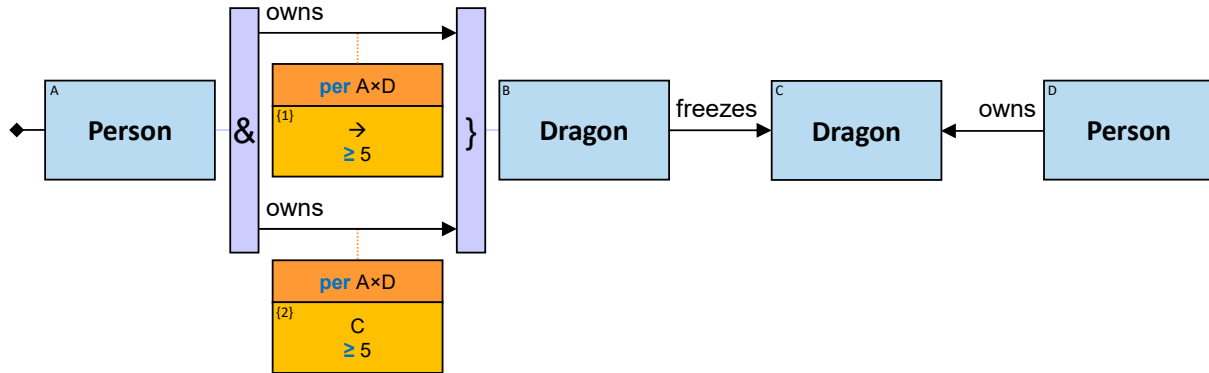

**Q27:** Any person that there are globally at least 500 horses that their colors are as the the colors of the horses he owns

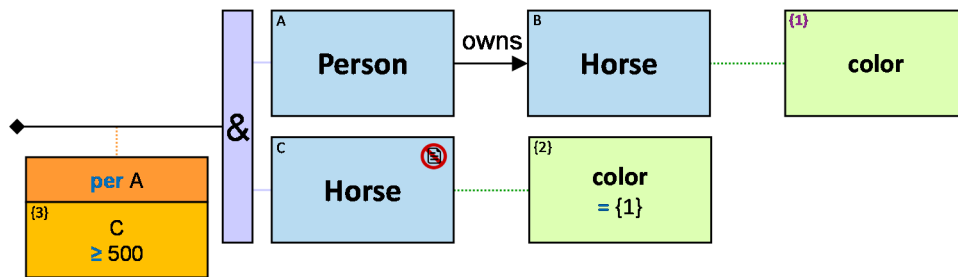

(Compare with Q28)

**Q320:** Any person that there are globally more horses that their colors are as the colors of the horses he owns than dragons that their colors are as the colors of the dragons he owns

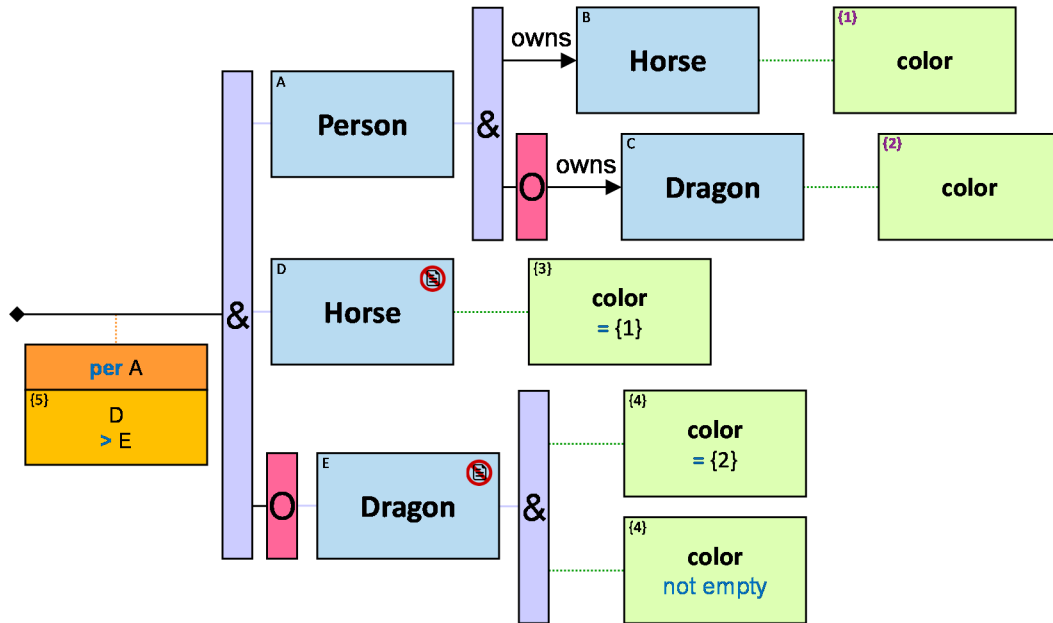

29 L2 AGGREGATION

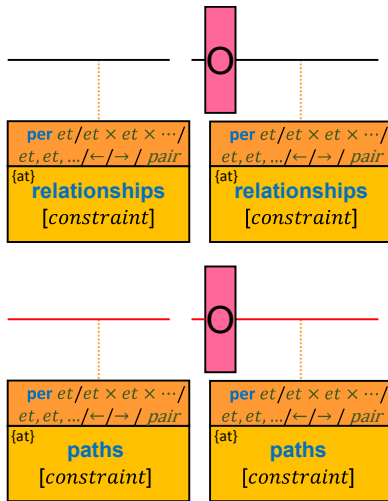

**Bottom part:**

The bottom part has one of the following formats:

- ‘relationships’ - when L2 appears below a relationship, or directly before a quantifier / sequence of quantifiers where all branches start (i) with a relationship or (ii) with a path wrapped by an ‘X’ or a ‘↔’ or (iii) with a green rectangle
- ‘paths’ - when L2 appears below a path, or directly before a quantifier / sequence of quantifiers with at least one branch that starts with a path not wrapped by an ‘X’ nor by a ‘↔’

L2 appears below a relationship / path / quantifier-input.

- A relationship / path with an L2 below it may be wrapped by an ‘O’.
- A quantifier-input with an L2 below it may be wrapped by an ‘O’. Any branch which does not start with an entity’s expression may be wrapped by an ‘X’, a ‘↔’ or an ‘O’.
- When L2 appears directly before a quantifier / sequence of quantifiers - at least one branch must start with a relationship / path that is not wrapped by an ‘X’ nor by a ‘↔’.

Let  $R$  denote a list where each element holds a pattern-relationship / a pattern-path.

When L2 appears below a relationship / path -  $R$  contains a single element:  $R[1]$  = the relationship/path L2 appears below it.

When L2 appears below a quantifier-input - each element in  $R$  is the relationship / path that follows one branch of the quantifier, excluding relationships / paths wrapped by an ‘X’ or a ‘↔’.

When the constraint has the form ‘= 0’, ‘≥0’ or ‘in [0, expr]’, we’ll first wrap the relationships / paths composing *R* with an ‘O’ (if not already wrapped).

Let  $RA(m,n,o)$  denote the set of all assignments to  $R[o]$  in  $S(m,n)$ .

For each  $(m,n)$ :

- **aggregation tag:**  $at(m,n) = |RA(m,n,1) \cup RA(m,n,2) \cup \dots|$

We are using *cardinality(union(all assignments to all elements in B))* instead of *sum(cardinality(assignment to one element in B))* since two elements in *R* may be have the same assignment (see Q296), and we are counting *distinct* assignments to all elements in *B* per  $\{m,n\}$ .

- Optional: a **constraint** on  $at(m,n)$  in one of these forms:
  - = *expr* / ≠ *expr* / > *expr* / ≥ *expr* / < *expr* / ≤ *expr*
  - in (*expr* .. *expr*) / in (*expr* .. *expr*] / in [*expr* .. *expr*) / in [*expr* .. *expr*]
  - in {*expr*, *expr*, ... *expr*}

‘≠ *expr*’, ‘< *expr*’ and ‘≤ *expr*’ are satisfied only if  $at(m,n) > 0$ .

**For each (m,n): *S(m,n)* is reported only if  $at(m,n)$  satisfies the constraint**

Notes:

- L2 location:
  - (i) Below the relationship / path whose assignments are counted
  - (ii) Before a quantifier which assignments to relationships / paths on its right are counted (see Q297, Q174, Q251)
  - (iii) As part of an aggregation chain (see Q96, Q93, Q100) subject to (i) or (ii)
- All entities composing *T* should be within scope at the aggregator (see section 40 – Tag rules).

Examples:

**Q71:** Any dragon that froze dragons more than 10 times (cumulatively)

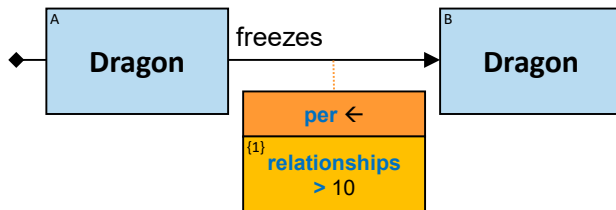

**Q72:** Any dragon A that was frozen exactly 10 times (cumulatively) (2 versions)

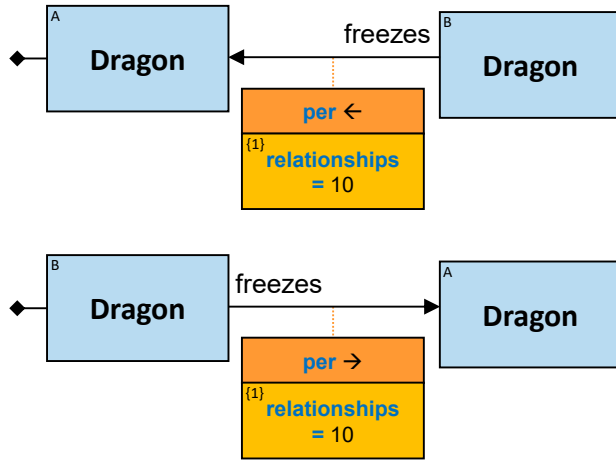

**Q74:** Any dragon that the number of times it was frozen (cumulatively) is not 10

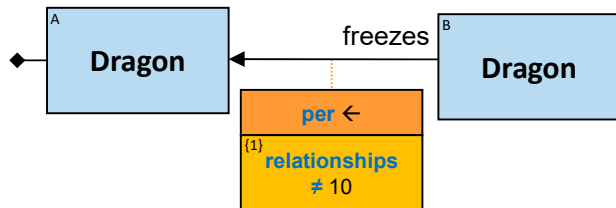

**Q79:** Any person with more than five paths (cumulatively) with length ≤ 4 to other people

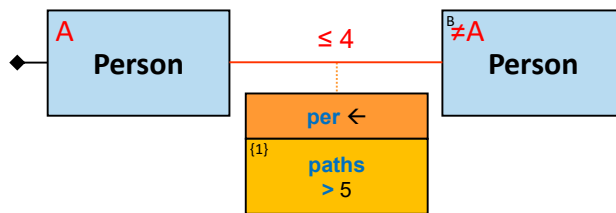

**Q83:** Any dragon that didn't freeze any dragon

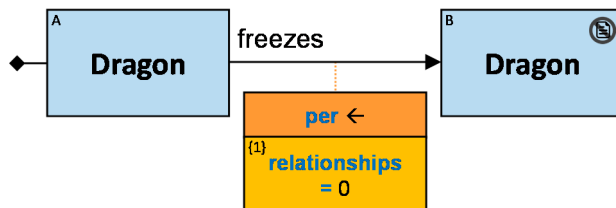

**Q73:** Any dragon that froze dragons no more than 10 times (cumulatively)

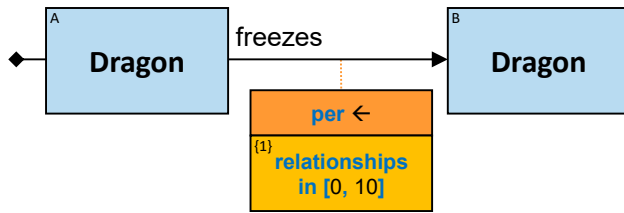

**Q84:** Any dragon with no paths with length  $\leq 3$  to other dragons

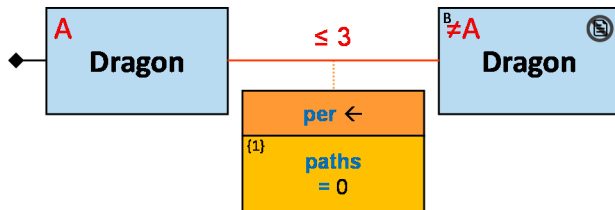

Anything right of a 'per ←: paths = 0' constraint won't be part of the query's result.

**Q104:** Any person who owned white horses at least 10 times (same or different horses)

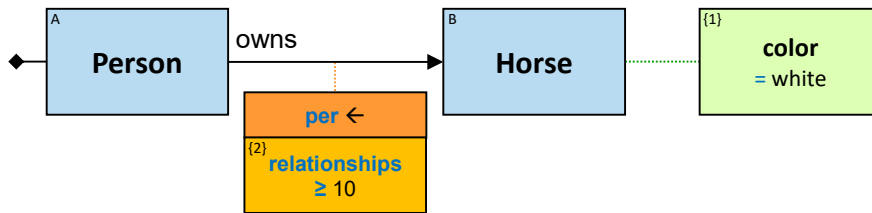

**Q105:** Any dragon A that was frozen exactly two times (cumulatively) by (dragons that each was frozen by at least one dragon)

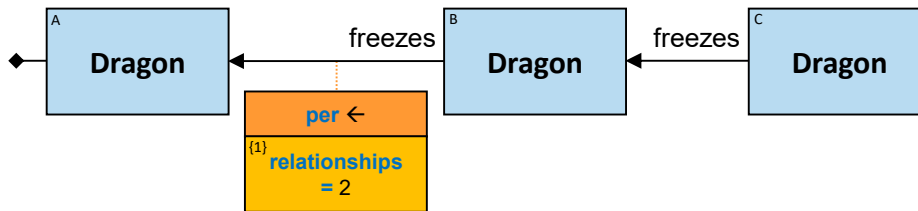



**Q245:** Any dragon B that was frozen at least once, and froze dragons exactly twice (cumulatively)

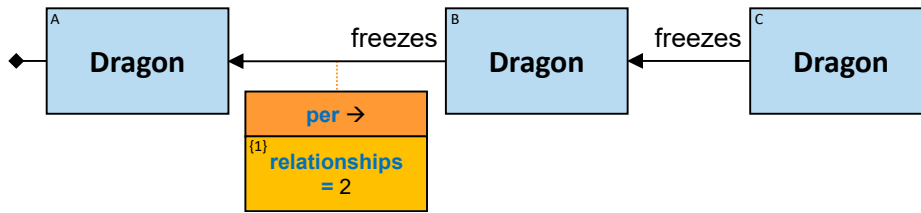

**Q127:** Any dragon that froze more times dragons owned by Sarnorian subjects than dragons owned by Ombrian subjects

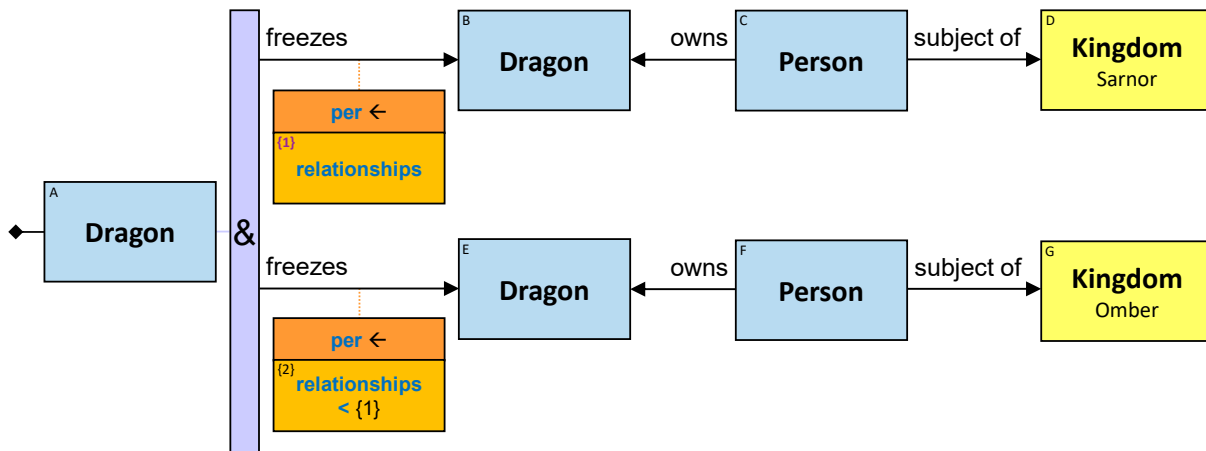

**Q123:** Any dragon that either froze or fired at dragons - at least 10 times

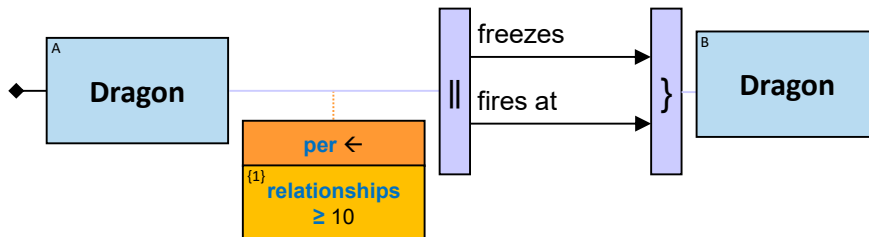

(counting the number of relationship assignments directly right of the quantifier -per A)

**Q185:** Any dragon that was frozen by Balerion: at least once in 1/1/1010 or later, at least once for less than 10 minutes, more than 10 times (in 1/1/1010 or later, or for less than 10 minutes)

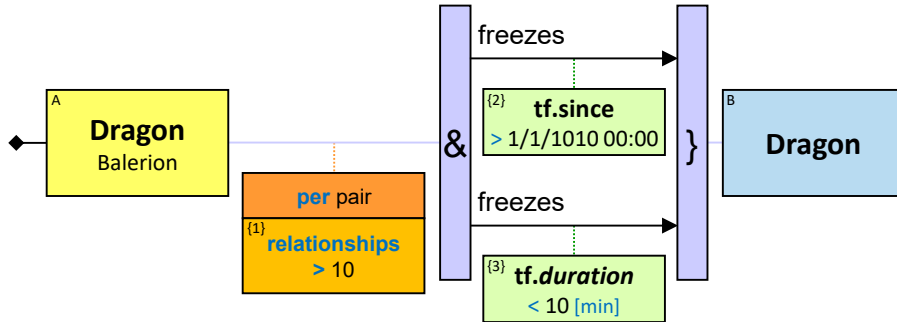

(counting the number of *distinct* 'freezes' relationships)

**Q296:** Any person who owned horses at least 10 times - each horse is either white or weighs more than 100 Kg (two versions)

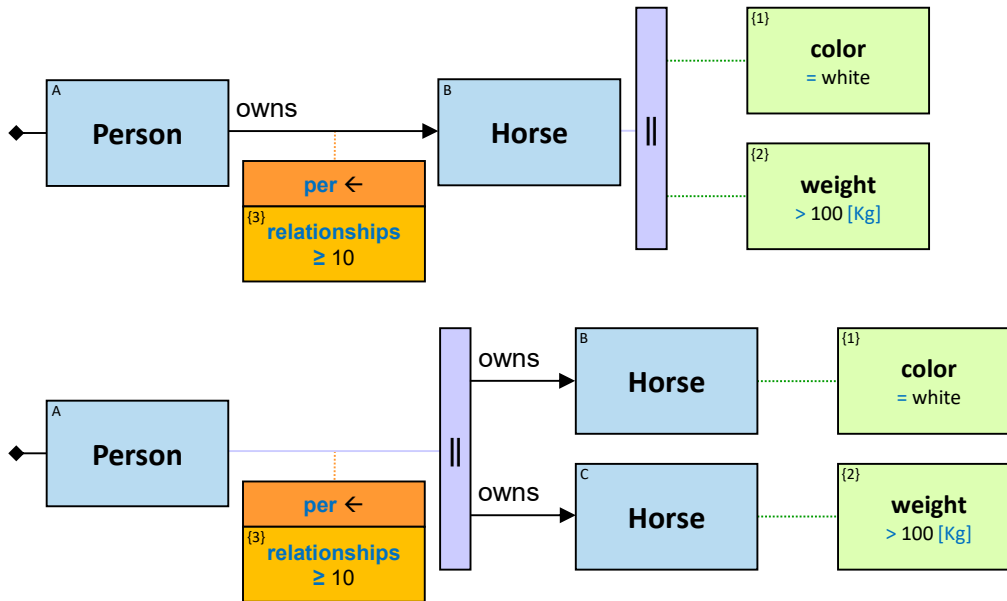

Note that if B and C have identical assignments (a white horse that weighs more than 100 Kg), the two assignments to the 'owns' relationships would be counted only once, since they are identical. L2 counts *distinct* relationship / path assignments.

**Q297:** Any dragon that the number of times it fired at dragons + the number of paths with length  $\leq 3$  from it to horses - is at least 10

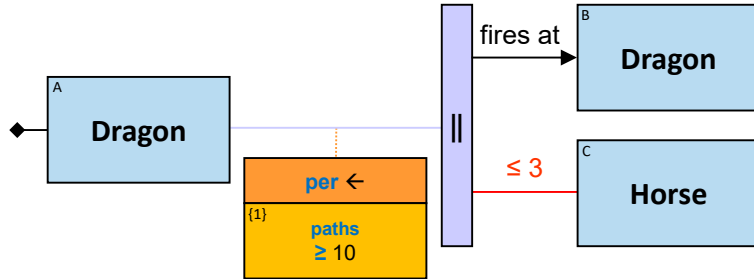

When both relationship assignments and path assignments are counted - the label in the aggregator is 'paths'.

**Q124:** Any dragon that either (froze a dragon) or (fired at a dragon that fired at a dragon) - at least 10 times

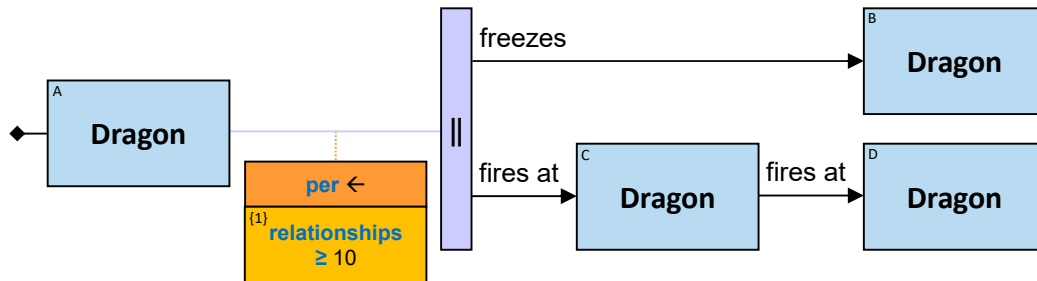

**Q173:** Any dragon that fired at at least two dragons, and fired at least 10 times

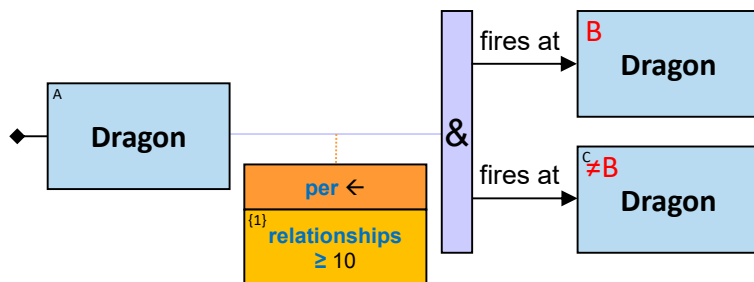

(counting the number of *distinct* 'fired at' relationships)

**Q174:** Any dragon that either (i) froze at least one dragon and fired at at least one dragon it didn't freeze, or (ii) froze at least two dragons. If (i): the number times it froze / fired at dragons is at least 10; otherwise: the number of times it froze dragons is at least 10

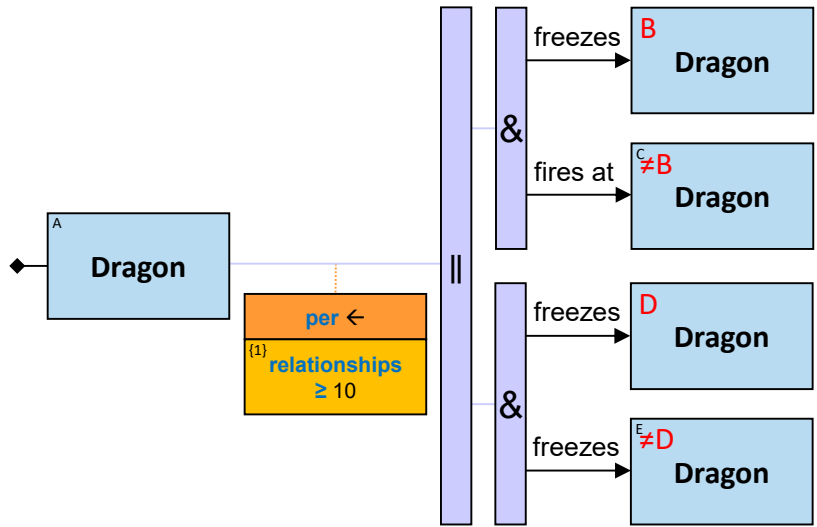

**Q251:** Any dragon that either (i) froze at least one dragon and fired at at least one dragon it didn't freeze, or (ii) froze at least two dragons. Any dragon that was frozen - was frozen at least 10 times; any dragon that was fired at - was fired at at least 10 times

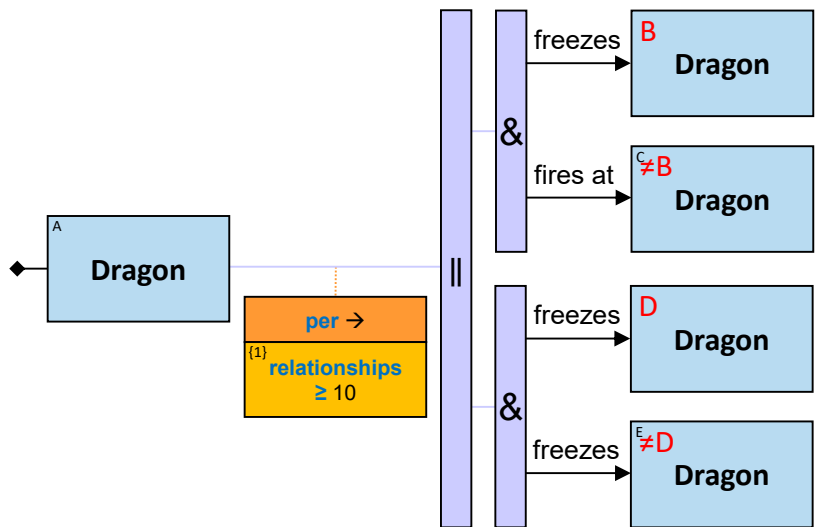

*Q75: Any dragon pair (A, B) where B froze A between eight and 10 times*

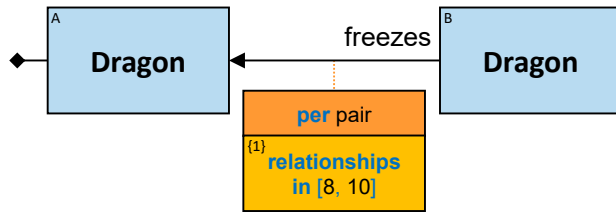

*Q76: Any dragon that froze Balerion between eight and 10 times*

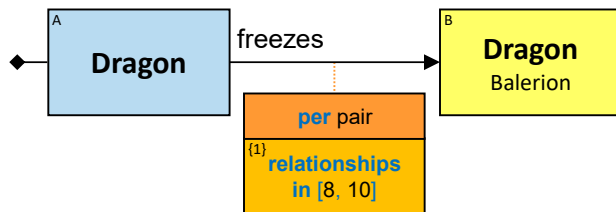

*Q242: Any pair of people (A, D) where at least five times any of A's dragons froze any of D's dragons*

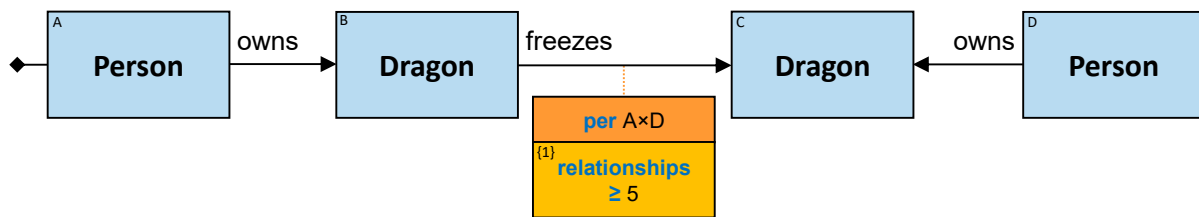

*Q279: Any pair of people (A, D) where A's dragons didn't freeze D's dragons (two versions)*

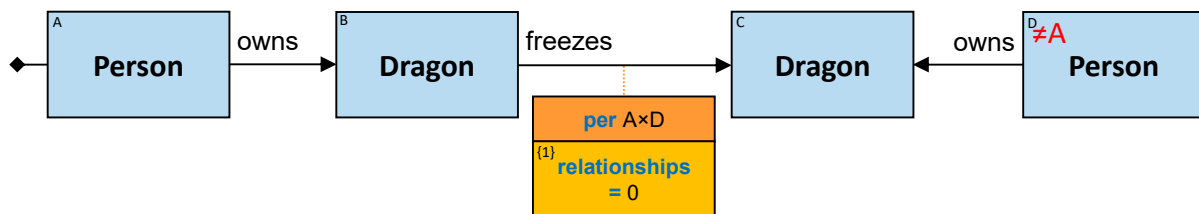

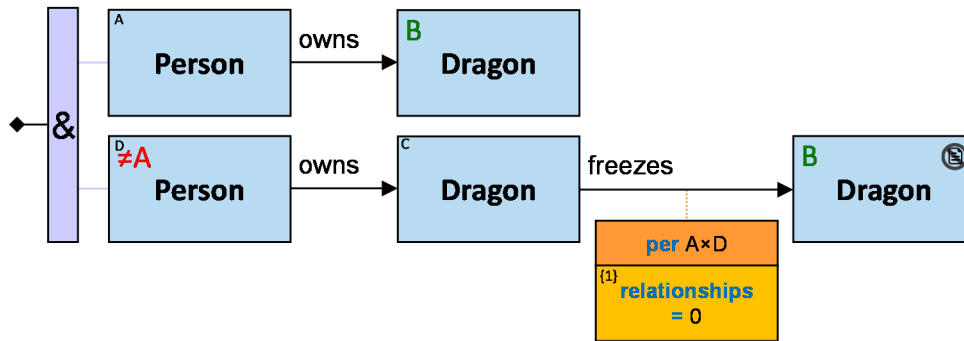

### 30 L3 AGGREGATION

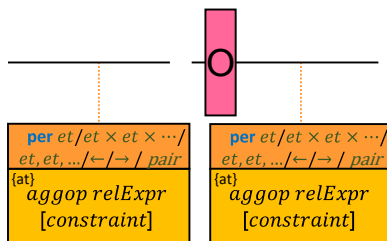

#### Bottom part:

Let  $R$  denote the relationship L3 appears below it.

The bottom part contains the following elements:

- *aggop* is *min/max/avg/sum* - for aggregating values of an ordinal expression, or *distinct/list/set* - for aggregating values of any expression. *distinct* returns the number of distinct values; *list* and *set* return a list/set of all the values. Empty values are not aggregated.
- *relExpr* is an expression containing at least one property of  $R$

L3 appears below a relationship. The relationship may be wrapped by an ‘O’.

Let  $BA(m,n)$  denote the list of the values of *relExpr* for all assignments to  $R$  in  $S(m,n)$ .

For each  $(m,n)$ :

- **aggregation tag:**  $at(m,n) = \text{aggop}(BA(m,n)[1], BA(m,n)[2], \dots)$
- Optional for each *aggop* except *list/set*: a **constraint** on  $at(m,n)$  in one of these forms:
  - $= \text{expr} / \neq \text{expr} / > \text{expr} / \geq \text{expr}$
  - $\text{in } (\text{expr} .. \text{expr}) / \text{in } (\text{expr} .. \text{expr}] / \text{in } [\text{expr} .. \text{expr}) / \text{in } [\text{expr} .. \text{expr}]$

- *in* {*expr*, *expr*, ... *expr*}
- if *aggop* is *distinct*: ' $\neq$  *expr*', ' $<$  *expr*' and ' $\leq$  *expr*' are satisfied only if  $at(m,n) > 0$

For each  $(m,n)$ :  $S(m,n)$  is reported only if  $at(m,n)$  satisfies the constraint

Notes:

- L3 location:
  - (i) Below the relationship whose property is referenced
  - (ii) As part of an aggregation chain (see Q163, Q95, Q277) subject to (i)
- All entities composing  $T$  should be within scope at the aggregator (see section 40 – Tag rules).

Examples:

**Q87:** Any dragon that was frozen at least once, and the cumulative duration he was frozen is less than 100 minutes

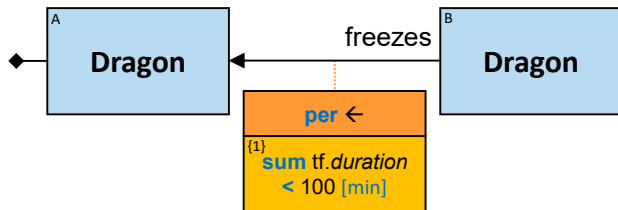

**Q88:** Any dragon pair (A, B) where A froze B at least once, but the cumulative freezing duration is 0 minutes

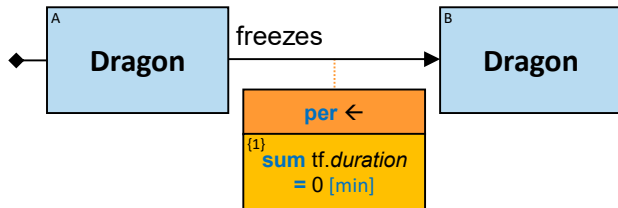

**Q89:** Any dragon that freezes dragons for more than three different durations

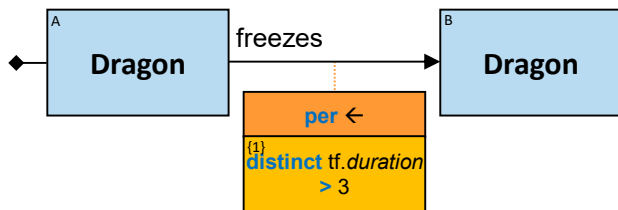

**Q86:** Any dragon pair (A, B) where A froze B for a cumulative duration longer than 100 minutes

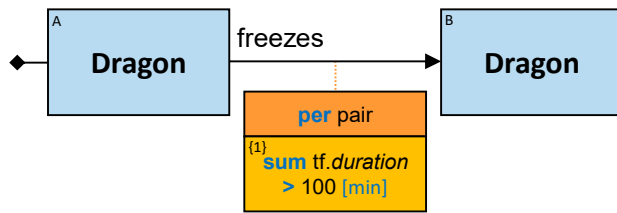

**Q98:** Any dragon pairs (A, X) where A froze more than three dragons and (A froze X more than 10 times or for a cumulative duration of more than 100 minutes)

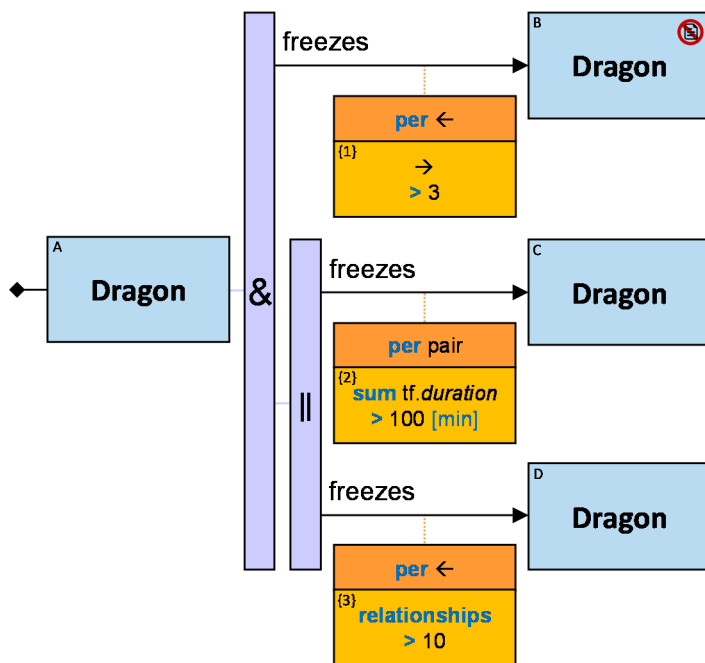



31 L4 AGGREGATION

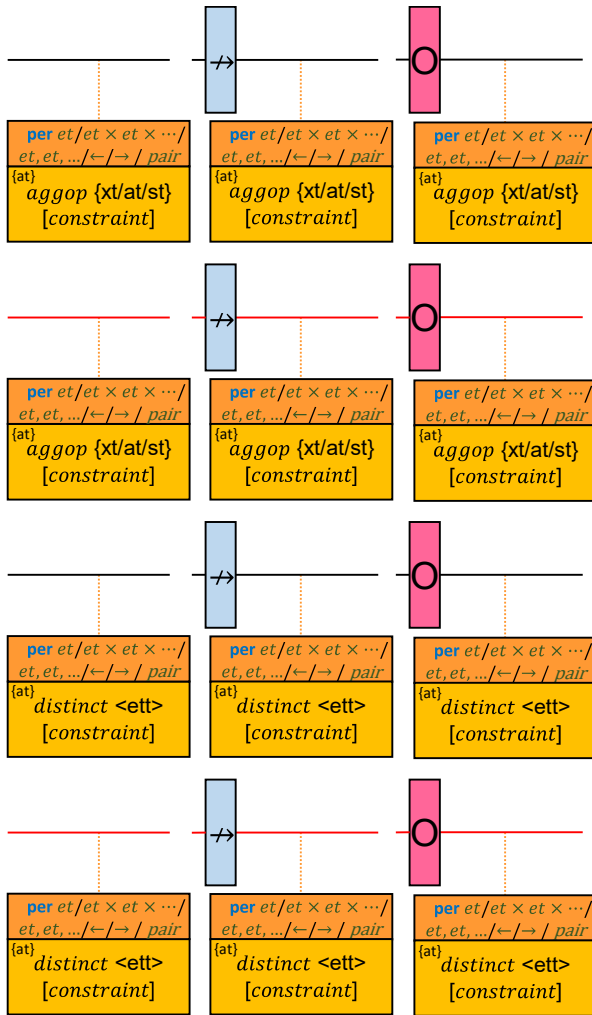

**Bottom part:**

The bottom part contains the following elements:

- *aggop* is *min/max/avg/sum* - for aggregating values of an ordinal expression, or *distinct/list/set* - for aggregating values of any expression. *distinct* returns the number of distinct values; *list* and *set* return a list/set of all the values. Empty values are not aggregated.
- $\{xt\}/\{at\}/\{st\}/\langle ett \rangle$  is an expression tag / aggregation tag / split tag / entity type tag - defined on top of the aggregation (see Q277v2) or right of the aggregation (see Q116, Q118, Q137, Q169)

L4 appears below a relationship / path / quantifier-input. The relationship / path / quantifier may be wrapped by a '→' or an 'O'

Let  $BA(m,n)$  denote the list of the values of  $\{xt\}/\{at\}/\{st\}/\langle ett \rangle$  for all assignments in  $S(m,n)$ .

For each  $(m,n)$ :

- **aggregation tag:**  $at(m,n) = \text{aggop}(BA(m,n)[1], BA(m,n)[2], \dots)$
- Optional: for each *aggop* except *list/set*: a **constraint** on  $at(m,n)$  in one of these forms:
  - $= \text{expr} / \neq \text{expr} / > \text{expr} / \geq \text{expr}$
  - $\text{in } (\text{expr} .. \text{expr}) / \text{in } (\text{expr} .. \text{expr}] / \text{in } [\text{expr} .. \text{expr}) / \text{in } [\text{expr} .. \text{expr}]$
  - $\text{in } \{\text{expr}, \text{expr}, \dots \text{expr}\}$
  - if *aggop* is *distinct*:  $\neq \text{expr}$ ,  $< \text{expr}$  and  $\leq \text{expr}$  are satisfied only if  $at(m,n) > 0$

**For each  $(m,n)$ :  $S(m,n)$  is reported only if  $at(m,n)$  satisfies the constraint**

Notes:

- L4 location:
  - If all entities in  $T$  are in a sequence: L4 appears directly right of the leftmost member of  $T$
  - If entities in  $T$  are in different branches: L4 appears directly before the quantifier
  - Before a quantifier (see Q158 and note below)
  - As part of an aggregation chain (see Q277)
- All entities composing  $T$  should be within scope at the aggregator (see section 40 – Tag rules).

Examples:

**Q116:** Any person that the number of distinct colors of his owned horses - is between one and three

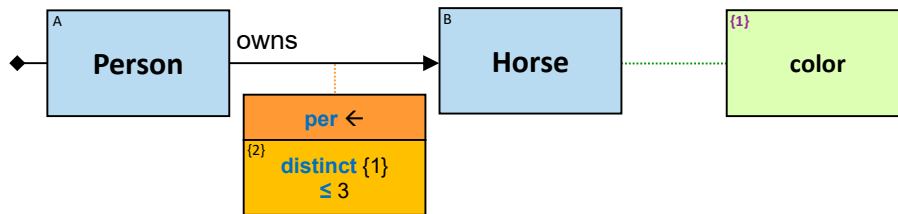

**Q117:** Any person whose owned horses' average weight is greater than 450 Kg

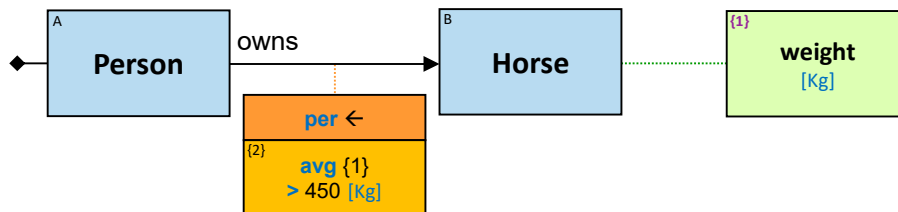

If a horse was owned twice - it would be counted only once.

**Q134:** Any person that the number of distinct colors of all horses owned by people he knows - is between one and three

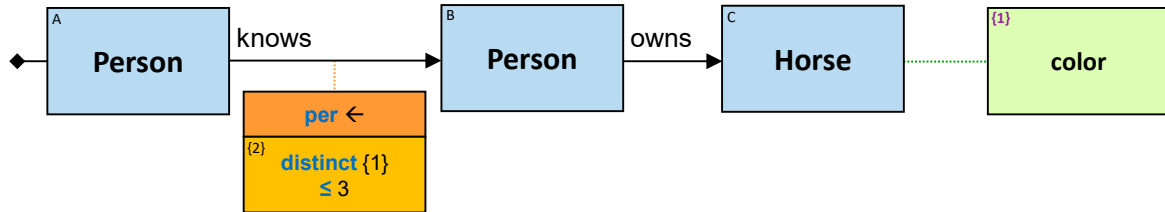

**Q229:** Any person that the number of distinct colors of all horses owned by people he knows or he is offspring of - is between one and three

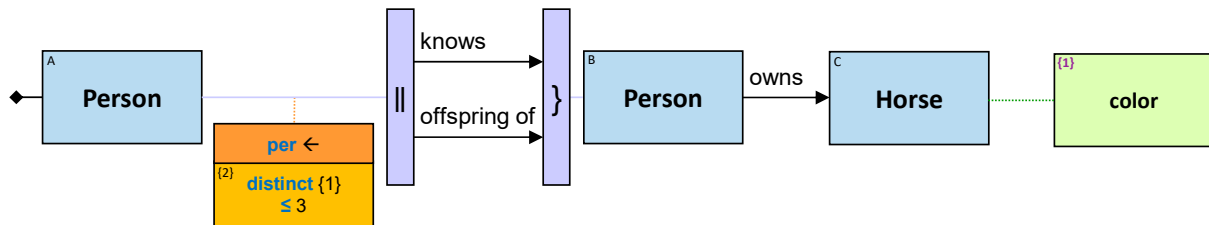

**Q135:** Any person that the average weight of all horses owned by people he knows - is greater than 450 Kg

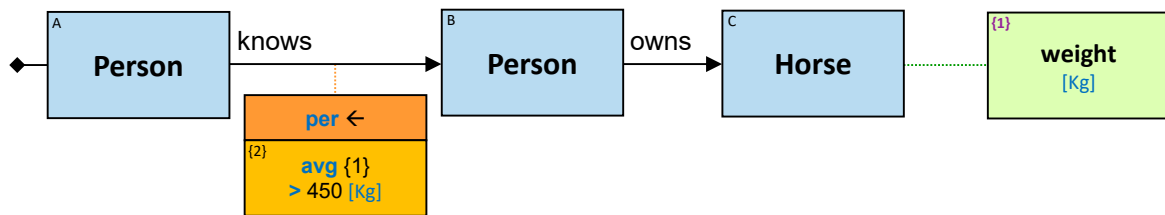

Note that if some person A knows two people that jointly own a horse - the weight of this horse would be counted twice.

**Q137:** Any dragon A that froze dragons B - each froze at least one dragon which is not A. All these B's together froze dragons for more than 100 minutes cumulatively

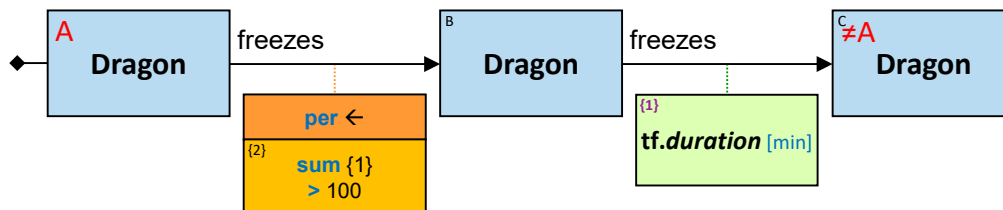

**Q139:** Any person who owns horses of the same number of colors as the number of colors of the horses owned by his parents cumulatively

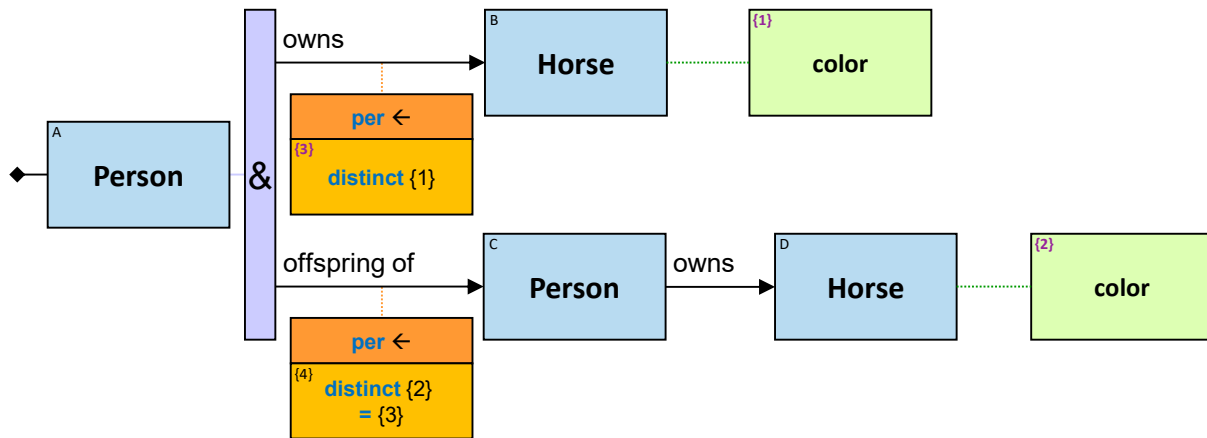

**Q167:** Any person who owns entities of at least three types

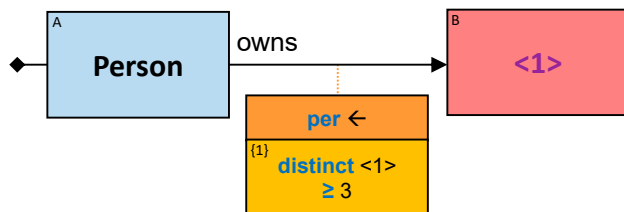

## 32 MIN/MAX AGGREGATIONS

Sometimes we need to limit assignment combinations to a set of entities, based on some value, to [all but] the  $k$  combinations with the lowest/highest value. Here are some examples:

- Any person and his five oldest offspring
- Any dragon and the three dragons he froze the largest number of times
- Any dragon and the four dragons it froze for the longest cumulative duration

Min/Max aggregations are used to limit the reported assignment combinations to [all but] the  $k$  combinations with:

- the lowest/highest count of the number of assignment combinations to some entities, or
- the lowest/highest count of the number of assignments to a relationship / path, or
- the minimal/maximal value of some aggregation operation (e.g. min/max/sum) over the value of some property or some tag

**Top part**

As explained for L1/L2/L3/L4 (see section 27 - Aggregation constraints and aggregation tags), with the following addition:

- The top part of M1/M2/M3/M4/R1 is optional. When not given -  $T[l]$  is empty,  $TA[l]$  is empty and  $S(l, l)$  is the set of all assignments in  $S$ .

33 M1 MIN/MAX AGGREGATION

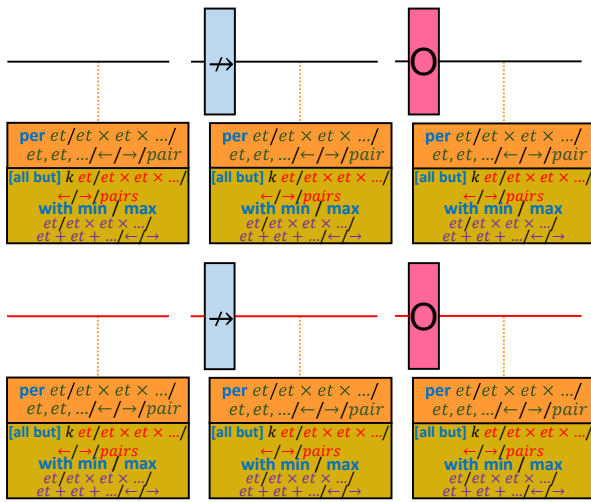

Let  $B$  denote an entity tag ( $et$ ) or a Cartesian product of entity tags ( $et1 \times et2 \times \dots$ ).

Let  $M$  denote a list where each element holds an entity tag ( $et$ ) or a Cartesian product of entity tags ( $et1 \times et2 \times \dots$ ).

**Bottom part:**

- $k$ : positive integer
- optional: “all but”
- One of the following formats:
  - ‘ $et$ ’:  $B = et$
  - ‘ $\leftarrow$ ’:  $B =$  entity-tag directly left of the aggregation
  - ‘ $et1 \times et2 \times \dots$ ’:  $B = et1 \times et2 \times \dots$
  - ‘ $\rightarrow$ ’:  $B =$  entity-tag directly right of the aggregation (valid when there is a single entity-tag)
  - ‘ $pairs$ ’:  $B = et1 \times et2$ , where  $et1$  is the entity-tag directly left of the aggregation and there is a single entity-tag directly right of the aggregation -  $et2$
- One of the following:

- min
- max
- One of the following formats (with *min/max ...*):
  - ‘*et*’: *M* contains a single element:  $M[1] = et$
  - ‘ $\leftarrow$ ’: *M* contains a single element:  $M[1] = \text{entity-tag directly left of the aggregation}$
  - ‘ $et1 \times et2 \times \dots$ ’: *M* contains a single element:  $M[1] = et1 \times et2 \times \dots$
  - ‘ $et1 + et2 + \dots$ ’:  $M = [et1, et2, \dots]$
  - ‘ $\rightarrow$ ’: *M* contains all the entity tags directly right of the aggregation (similar to ‘ $et1 + et2 + \dots$ ’)

M1 appears below a relationship / path / quantifier-input.

- A relationship / path with an M1 below it may be wrapped by a ‘ $\rightarrow$ ’ or an ‘O’.
- A quantifier-input with an M1 below it may be wrapped by an ‘O’. Any branch which does not start with an entity’s expression may be wrapped by an ‘X’, a ‘ $\rightarrow$ ’ or an ‘O’.
- When M1 appears directly before a quantifier / sequence of quantifiers - at least one branch must start with a relationship / path that is not wrapped by an ‘X’.

Let  $BA(m,n)$  denote the list of all assignments to *B* in  $S(m,n)$ .  $BA(m,n)[o]$  is the *o*’th assignment.

Let  $MA(m,n,o,p)$  denote the set of all assignments to  $M[p]$  in the subset of  $S(m,n)$  that contains  $BA(m,n)[o]$ .

$MC(m,n,o) = MA(m,n,o,1) \cup MA(m,n,o,2) \cup \dots$  - the set of unique assignments to elements in *M* in the subset of  $S(m,n)$  that contains  $BA(m,n)[o]$ .

For each  $(m,n)$ :

- We’ll find the *k o*’s for which  $|MC(m,n,o)|$  is minimal/maximal
- For each of these *o*’s:  $S(m,n)$  is reported if it contains  $BA(m,n)[o]$

**For each (m, n): from the set of assignments in *S* which cover  $TA[m] [n]$  - [all but] the *k* assignment combinations to entities *B* with the minimal / maximal positive number of assignment combinations of entities *M* are reported**

Notes:

- *T*, *B*, and *M* may not intersect.
- M1 location:
  - If *T* is empty - M1 appears directly right of the leftmost entity in *B*.
  - If *T* is not empty and all the entities in *T* appear right of all the entities in *B*: left of the rightmost entity in *T*. Otherwise: right of the leftmost entity in *T*
  - If entities in  $T \cup B$  are defined in different branches of a quantifier: directly before the quantifier
- All entities composing *T*, *M* and *B* should be within scope at the aggregator (see section 40 – Tag rules).

- Suppose the bottom part is “5 ... with max ...” but there are only three assignment combinations - Only those three will be reported.
- Suppose the bottom part is “5 ... with max ...” but there are 10 assignment combinations with equal maximum - Still only five will be reported.

Examples:

*Q67: The three people with the largest number of parents*

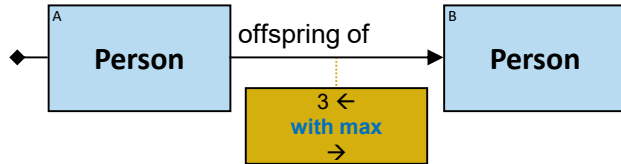

*Q68: The two dragons that were frozen by the largest number of dragons*

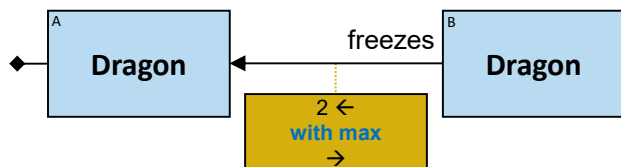

*Q69: The two entities that own the largest number of entities*

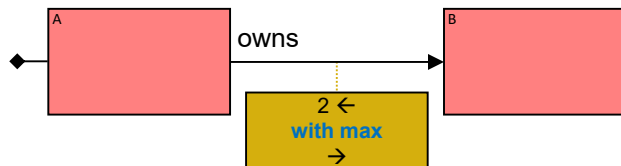

*Q70: The five people who the number of people within graph distance  $\leq 4$  from them - is the smallest*

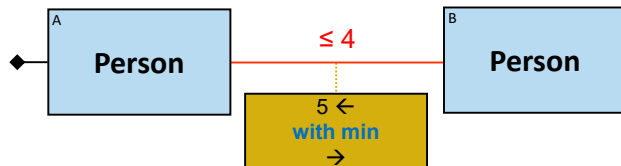

**Q196:** Any *dragon* owned by Brandon Stark, and the three dragons *it* froze that froze the largest number of dragons

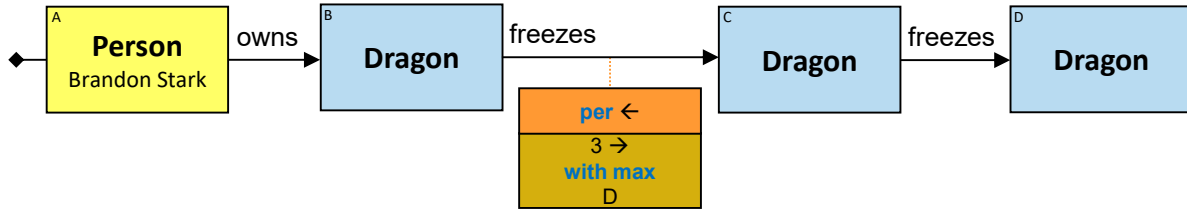

**Q197:** Any person and his three dragons that the dragons they froze - froze the largest number of distinct dragons cumulatively

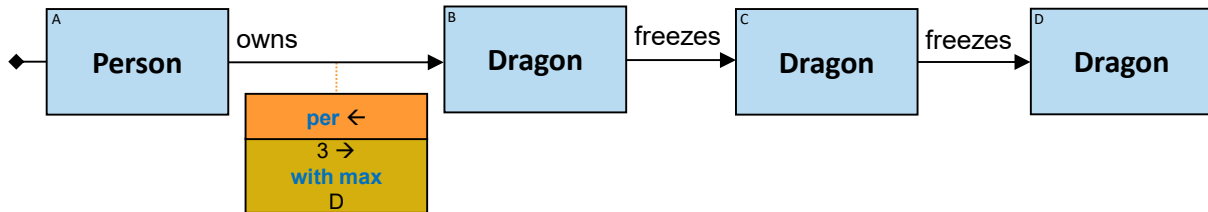

**Q234:** Any person and the three dragons whose dragons froze - that froze the largest number of dragons

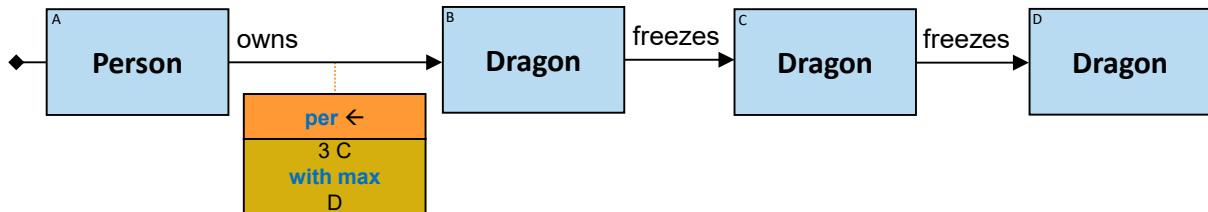

**Q236:** Any person and the three dragons whose dragons froze - that were frozen by the largest number of his dragons

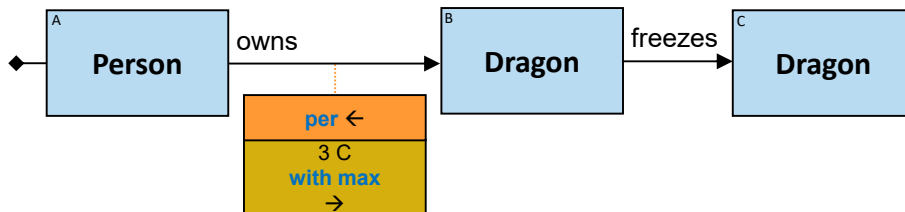



**Q227:** Any *dragon* owned by Brandon Stark, and the three dragons *it* froze or fired at - that froze the largest number of dragons

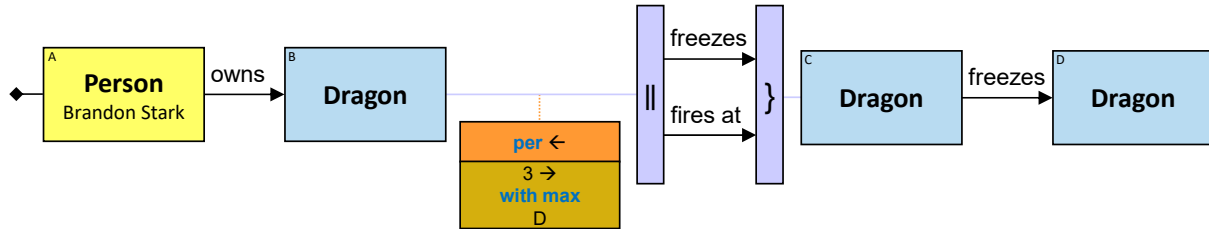

**Q238:** For any pair of people (*A*, *D*) where *A*'s dragons froze *D*'s dragons - *A*'s three dragons that froze the largest number of *D*'s dragons

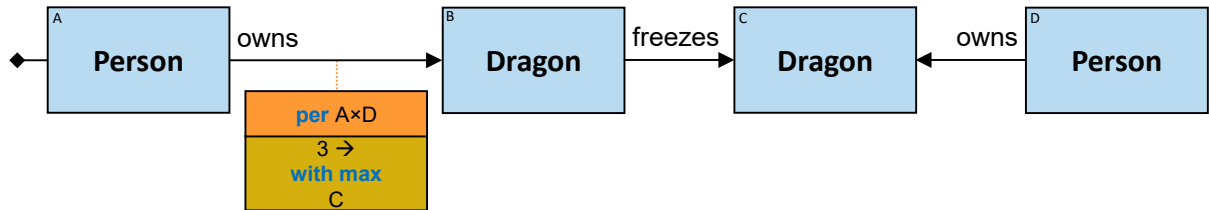

34 M2 MIN/MAX AGGREGATION

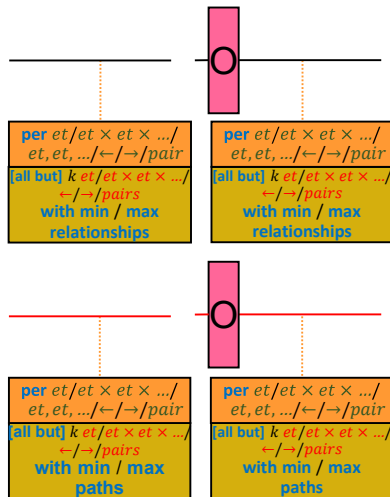

Let **B** denote an entity tag (*et*) or a Cartesian product of entity tags ( $et_1 \times et_2 \times \dots$ ).

**Bottom part:**

- $k$ : positive integer
- optional: “all but”
- One of the following formats:
  - ‘ $et$ ’:  $B = et$
  - ‘ $\leftarrow$ ’:  $B =$  entity-tag directly left of the aggregation
  - ‘ $et1 \times et2 \times \dots$ ’:  $B = et1 \times et2 \times \dots$
  - ‘ $\rightarrow$ ’:  $B =$  entity-tag directly right of the aggregation (valid only when there is a single entity-tag)
  - ‘ $pairs$ ’:  $B = et1 \times et2$ , where  $et1$  is the entity-tag directly left of the aggregation and there is a single entity-tag directly right of the aggregation -  $et2$
- One of the following:
  - min
  - max
- One of the following:
  - ‘relationships’ - when M2 appears below a relationship, or directly before a quantifier that each of its branches starts either with a relationship or with a path wrapped by an ‘X’ or a ‘ $\rightarrow$ ’
  - ‘paths’ - when M2 appears below a path, or directly before a quantifier that at least one of its branches starts with a path not wrapped by an ‘X’ nor by a ‘ $\rightarrow$ ’

M2 appears below a relationship / path / quantifier-input.

- A relationship / path with an M2 below it may be wrapped by an ‘O’.
- A quantifier-input with an M2 below it may be wrapped by an ‘O’. Any branch which does not start with an entity’s expression may be wrapped by an ‘X’, a ‘ $\rightarrow$ ’ or an ‘O’.
- When M2 appears directly before a quantifier / sequence of quantifiers - at least one branch must start with a relationship / path that is not wrapped by an ‘X’ nor by a ‘ $\rightarrow$ ’.

Let  $R$  denote a list where each element holds a pattern-relationship / a pattern-path.

When M2 appears below a relationship / path -  $R$  contains a single element:  $R[1] =$  the relationship/path M2 appears below it.

When M2 appears below a quantifier-input - each element in  $R$  is the relationship / path that follows one branch of the quantifier, excluding relationships / paths wrapped by an ‘X’ or a ‘ $\rightarrow$ ’.

Let  $BA(m,n)$  denote the set of all assignments to  $B$  in  $S(m,n)$ .  $BA(m,n)[o]$  is the  $o$ ’th assignment.

$RA(m,n,o,p)$  - the set of all assignments to  $R[p]$  in the subset of  $S(m,n)$  that contains  $BA(m,n)[o]$ .

$RC(m,n,o) = |RA(m,n,o,1) \cup RA(m,n,o,2) \cup \dots|$  - the set of unique assignments to elements in  $R$  in the subset of  $S(m,n)$  that contains  $BA(m,n)[o]$ .

For each  $(m,n)$ :

- We'll find the  $k$   $o$ 's for which  $|RC(m,n,o)|$  is minimal/maximal
- For each of these  $o$ 's:  $S(m,n)$  is reported if it contains  $BA(m,n)[o]$

**For each (m, n): from the set of assignments in  $S$  which cover  $TA[m] [n]$  - [all but] the  $k$  assignment combinations to entities  $B$  with the minimal / maximal positive number of assignment combinations of relationships / paths  $R$  are reported**

Notes:

- $T$  and  $B$  may not intersect.
- Suppose the bottom part is “5 ... with max ...” but there are only three assignment combinations - Only those three will be reported.
- Suppose the bottom part is “5 ... with max ...” but there are 10 assignment combinations with equal maximum - Still only five will be reported.

Examples:

*Q78: The four dragons that froze Balerion the largest number of times*

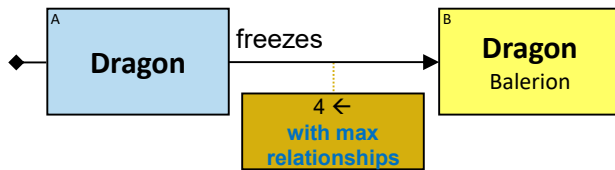

*Q171: The two dragons that were frozen the largest number of times*

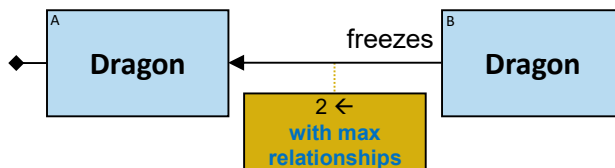

*Q172: The five people with the smallest positive number of paths with length  $\leq 4$  to some person*

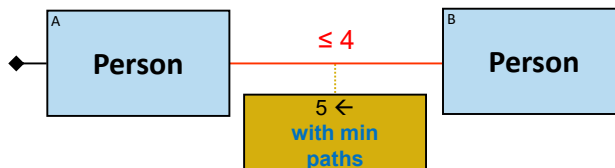

(Compare with Q324)

**Q77:** The five dragon pairs (A, B) with the largest number of times B froze A

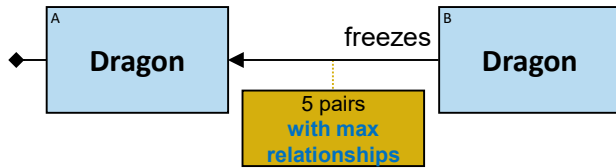

**Q80:** The three person pairs with the largest number of paths with length  $\leq 4$  between them

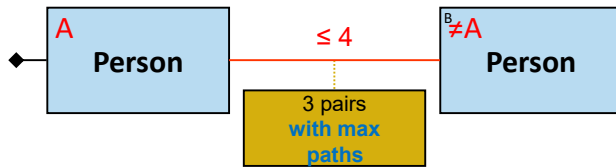

**Q195:** Any dragon owned by Brandon Stark, and the three dragons it froze the largest number of times

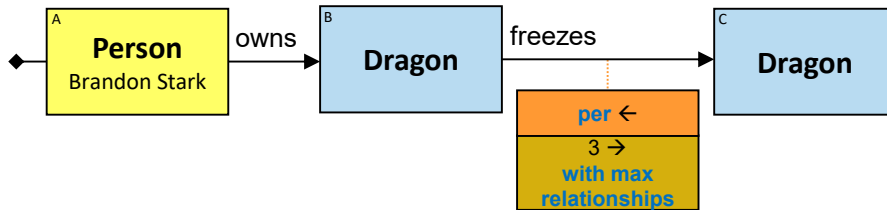

**Q231:** Any person and the three dragons (D) that were frozen by dragons that were frozen the largest number of times by his dragons

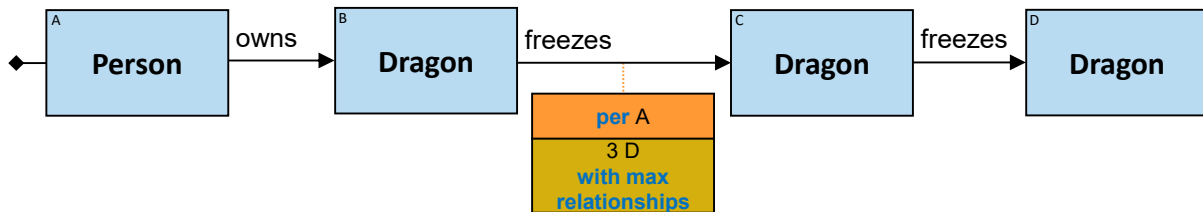

**Q228:** Any dragon owned by Brandon Stark that fired at at least two dragons, and the three dragons it fired the largest number of times

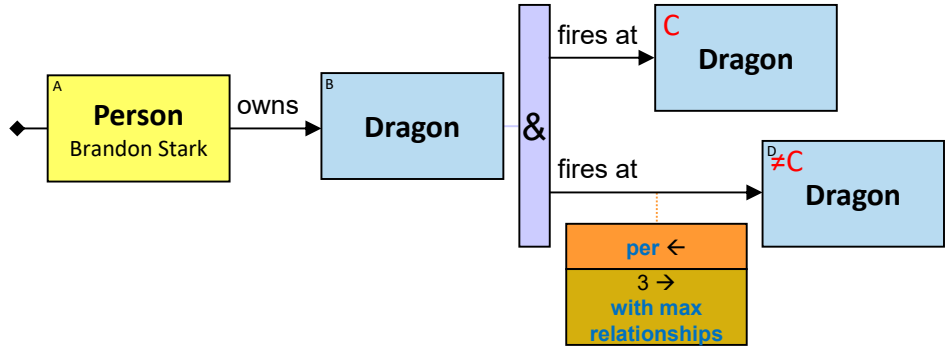

(counting the number of relationships assignments directly right of the quantifier)

**Q237:** For any pair of (A - a dragons owner, and C - a dragon that was frozen by A's dragons) - the three dragons owned by A that froze C the largest number of times

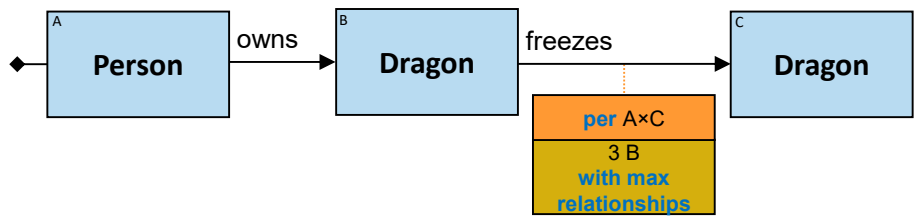

**Q239:** For any pair of people (A, D) where A's dragons froze D's dragons - the three pairs of (A's dragon B, D's dragon C) where B froze C the largest number of times

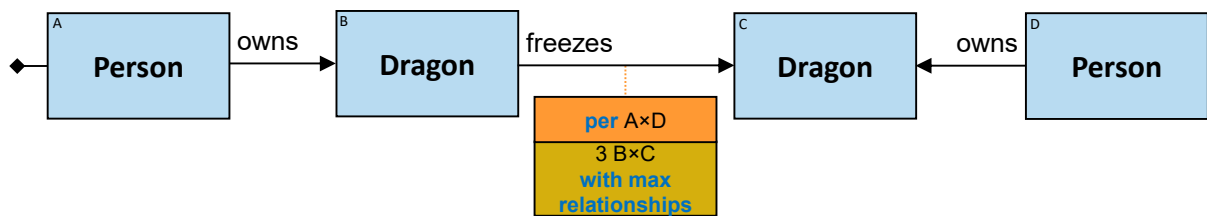

## 35 M3 MIN/MAX AGGREGATION

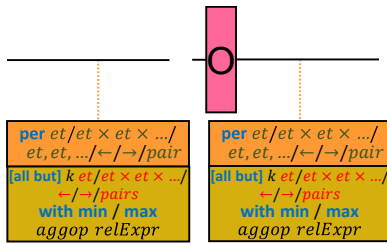

Let  $B$  denote an entity tag ( $et$ ) or a Cartesian product of entity tags ( $et1 \times et2 \times \dots$ ).

Let  $R$  denote the relationship M3 appears below it.

**Bottom part:**

- $k$ : positive integer
- optional: “all but”
- One of the following formats:
  - ‘ $et$ ’:  $B = et$
  - ‘ $\leftarrow$ ’:  $B =$  entity-tag directly left of the aggregation
  - ‘ $et1 \times et2 \times \dots$ ’:  $B = et1 \times et2 \times \dots$
  - ‘ $\rightarrow$ ’:  $B =$  entity-tag directly right of the aggregation (valid only when there is a single entity-tag)
  - ‘ $pairs$ ’:  $B = et1 \times et2$ , where  $et1$  is the entity-tag directly left of the aggregation and there is a single entity-tag directly right of the aggregation -  $et2$
- One of the following:
  - min
  - max
- $aggop$  is  $min/max/avg/sum$  - for aggregating values of an ordinal expression, or  $distinct/list/set$  - for aggregating values of any expression.  $distinct$  returns the number of distinct values;  $list$  and  $set$  return a list/set of all the values. Empty values are not aggregated.
- $relExpr$  is an expression containing at least one property of  $R$

M3 appears below a relationship. The relationship may be wrapped by an ‘O’.

Let  $BA(m,n)$  denote the set of all assignments to  $B$  in  $S(m,n)$ .  $BA(m,n)[o]$  is the  $o$ ’th assignment.

$RA(m,n,o)$  - the list of all assignments to  $R$  in the subset of  $S(m,n)$  that contains  $BA(m,n)[o]$ .

For each  $(m,n)$ :

- We’ll find the  $k$   $o$ ’s for which  $aggop(RA(m,n,o)[1].relExpr, RA(m,n,o)[2].relExpr, \dots)$  is minimal/maximal
- For each of these  $o$ ’s:  $S(m,n)$  is reported if it contains  $BA(m,n)[o]$

For each (m, n): from the set of assignments in  $S$  which cover  $TA[m] [n]$  - [all but] the  $k$  assignment combinations to entities  $B$  with the minimal / maximal value of  $aggop(relExpr)$  of the assignments to the relationship are reported

Notes:

- $T$  and  $B$  may not intersect.
- Except for an "All" quantifier - M3 cannot start a quantifier's branch.
- Suppose the bottom part is "5 ... with max ..." but there are only three assignment combinations - Only those three will be reported.
- Suppose the bottom part is "5 ... with max ..." but there are 10 assignment combinations with equal maximum - Still only five will be reported.

Examples:

**Q90:** The four dragon pairs (A, B) where A froze B for the longest cumulative duration

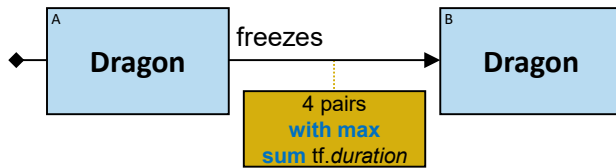

**Q182:** Any dragon owned by Brandon Stark, and the three dragons it froze for the longest cumulative duration

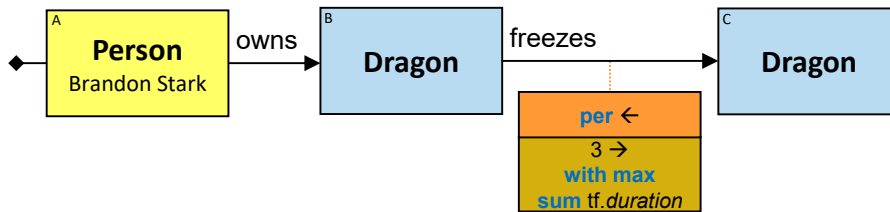

**Q233:** Any dragon A than froze dragons Bs that froze dragons Cs, and the three Cs for which A froze Bs for the longest cumulative duration

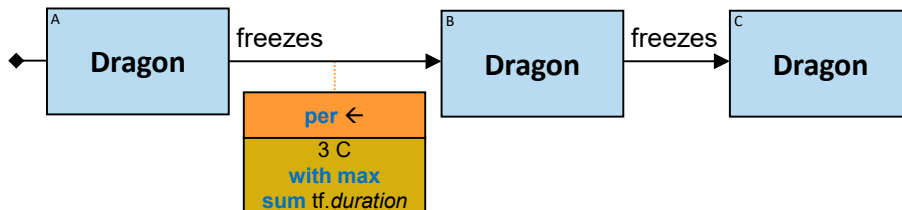

**Q201:** For each dragon that froze at least 10 dragons: the three dragons it froze for the longest cumulative duration

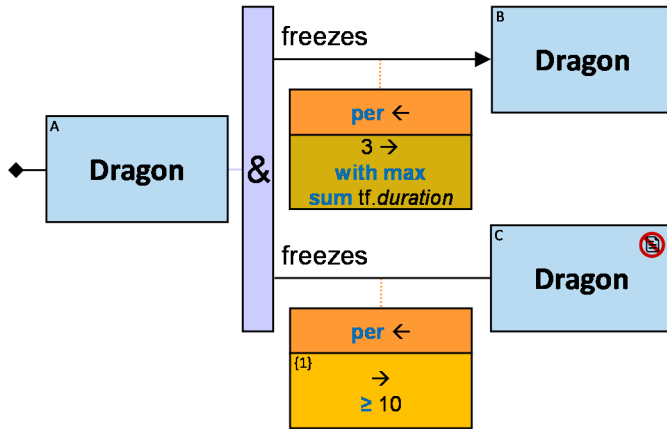

36 M4 MIN/MAX AGGREGATION

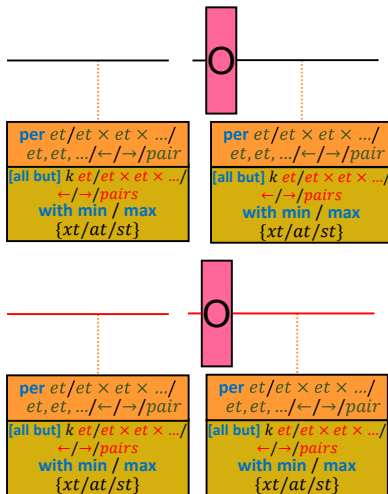

Let  $B$  denote an entity tag ( $et$ ) or a Cartesian product of entity tags ( $et1 \times et2 \times \dots$ ).

**Bottom part:**

- $k$ : positive integer
- optional: “all but”
- One of the following formats:
  - ‘ $et$ ’:  $B = et$



- ‘←’:  $B = \text{entity-tag}$  directly left of the aggregation
- ‘ $et1 \times et2 \times \dots$ ’:  $B = et1 \times et2 \times \dots$
- ‘→’:  $B = \text{entity-tag}$  directly right of the aggregation (valid only when there is a single entity-tag)
- ‘pairs’:  $B = et1 \times et2$ , where  $et1$  is the entity-tag directly left of the aggregation and there is a single entity-tag directly right of the aggregation -  $et2$
- One of the following:
  - min
  - max
- One of the following:
  - {xt} is an expression tag with an ordinal type - defined on top of the aggregation (see Q274) or right of the aggregation (see Q130)
  - {at} is an aggregation tag - defined on top of the aggregation (see Q91) or right of the aggregation (see Q128)
  - {st} is a split tag - defined on top of the aggregation (see Q306) or right of the aggregation

M4 appears below a relationship / path / quantifier-input. The relationship / path / quantifier may be wrapped by an ‘O’. M4 appears below a query-start when there is a single entity in the pattern (see Q130, Q131)

Let  $BA(m,n)$  denote the set of all assignments to  $B$  in  $S(m,n)$ .  $BA(m,n)[o]$  is the  $o$ 'th assignment.

For each  $(m,n)$ :

- We'll find the  $k$   $o$ 's for which {xt}/{at}/{st} is minimal/maximal
- For each of these  $o$ 's:  $S(m,n)$  is reported if it contains  $BA(m,n)[o]$

**For each (m, n): from the set of assignments in  $S$  which cover  $TA[m] [n]$  - [all but] the  $k$  assignment combinations to entities  $B$  with the minimal / maximal value of {xt}/{at}/{st} are reported**

Notes:

- $T$  and  $B$  may not intersect.
- If  $T$  is not empty - M4 appears directly right of the leftmost entity in  $T$ . If  $T$  is empty - M4 appears directly right of the leftmost entity in  $B$ .
- Except for an "All" quantifier - M4 aggregation cannot start a quantifier's branch.
- Suppose the bottom part is “5 ... with max ...” but there are only three assignment combinations - Only those three will be reported.
- Suppose the bottom part is “5 ... with max ...” but there are 10 assignment combinations with equal maximum - Still only five will be reported.

Examples:

*Q130: The four oldest people*

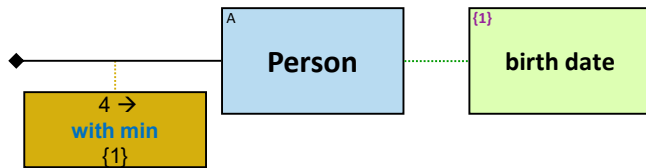

*Q131: The four oldest males*

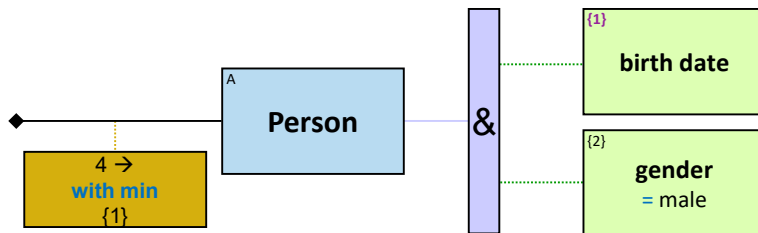

*Q118: Any person and his three oldest offspring*

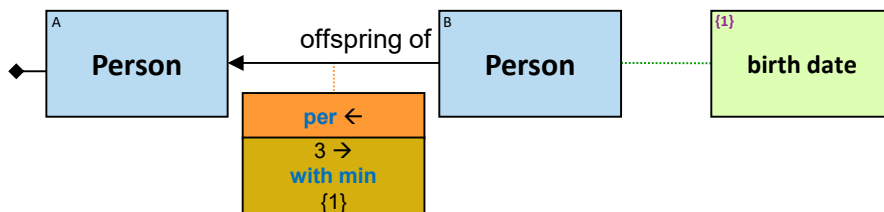

*Q119: Any person and his three youngest sons*

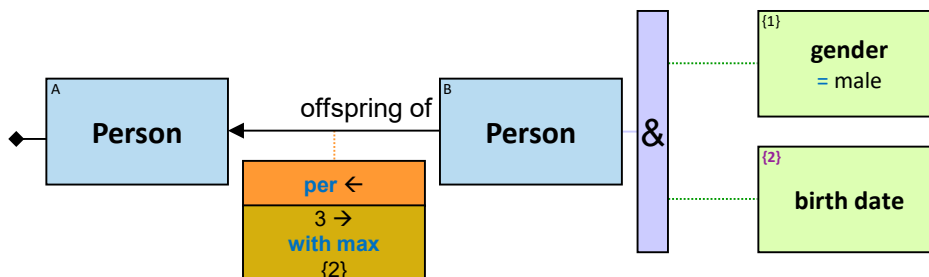

**Q230:** Any person and the three people he (knows or knows an offspring of) - that owns the heaviest horses

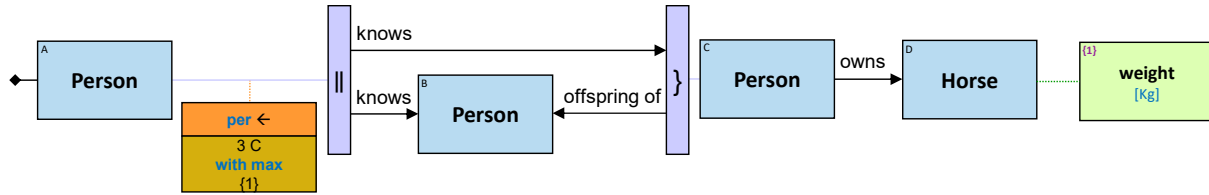

**Q232:** Any person and the three heaviest horse owned by people he (knows or knows an offspring of)

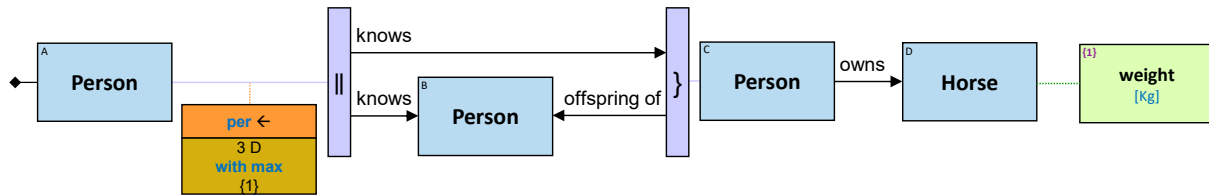

37 R1 MIN/MAX AGGREGATION

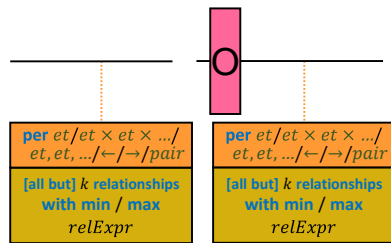

Let  $R$  denote the relationship R1 appears below it.

**Bottom part:**

- $k$ : positive integer
- optional: “all but”
- One of the following:
  - min
  - max
- $relExpr$  is an expression containing at least one property of  $R$

R1 appears below a relationship. The relationship may be wrapped by an ‘O’.

$RA(m,n)$  - the list of all assignments to  $R$  in  $S(m,n)$ .  $RA(m,n)[o]$  is the  $o$ 'th assignment.

For each  $(m,n)$ :

- We'll find the  $k$   $o$ 's for which  $RA(m,n)[o].relExpr$  is minimal/maximal
- For each of these  $o$ 's:  $S(m,n)$  is reported if it contains  $RA(m,n)[o]$

**For each  $(m, n)$ : from the set of assignments in  $S$  which cover  $TA[m] [n]$  - [all but] the  $k$  assignments to relationship  $R$  with the smallest / largest value of  $relExpr$  are reported**

Notes:

- Suppose the bottom part is "5 ... with max ..." but there are only three assignments - Only those three will be reported.
- Suppose the bottom part is "5 ... with max ..." but there are 10 assignments with equal maximum - Still only five will be reported.

Examples:

**Q241:** *The four longest freezes*

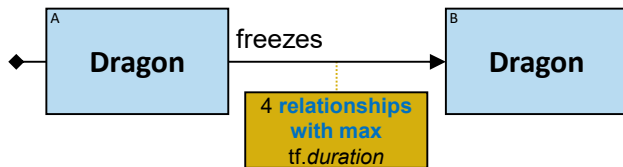

**Q161:** *For each dragon that froze at least one dragon at least once: the four longest freezes*

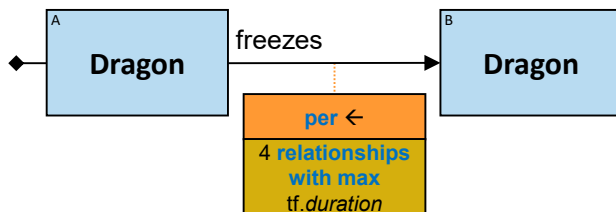

**Q160:** *For each dragon pair (A, B) where A froze B at least once: The four longest freezes*

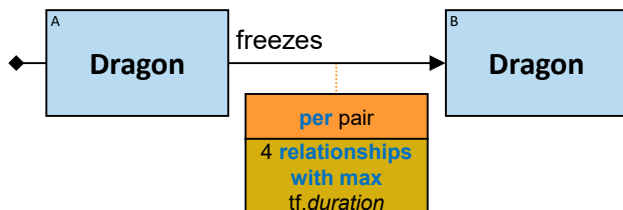

**Q240:** For any pair of people (A, D): The four longest freezes where any of A's dragons froze any of D's dragons

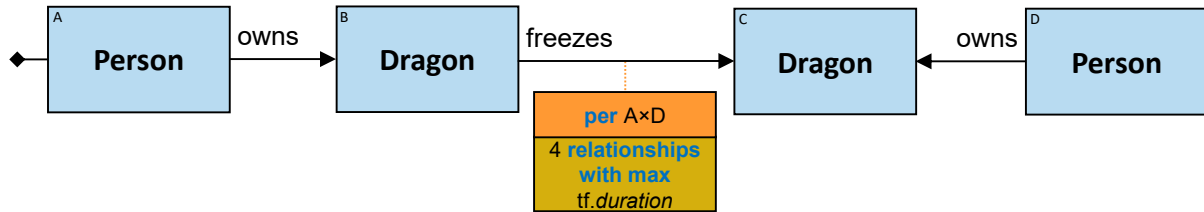

### 38 AGGREGATION CHAINS

Green rectangles and orange rectangles below a relationship can be **chained**. When chained, each green/orange rectangle serves as a filtering step. The constraints are met only if there is an assignment that passes all these filtering steps (except for zero-count constraints - see Q259, Q99v1, Q158, Q159 and Q260).

**Q96:** Any dragon that was frozen by Balerion more than 10 times - each of these times is on 1/1/1010 or later and for a duration shorter than 10 minutes

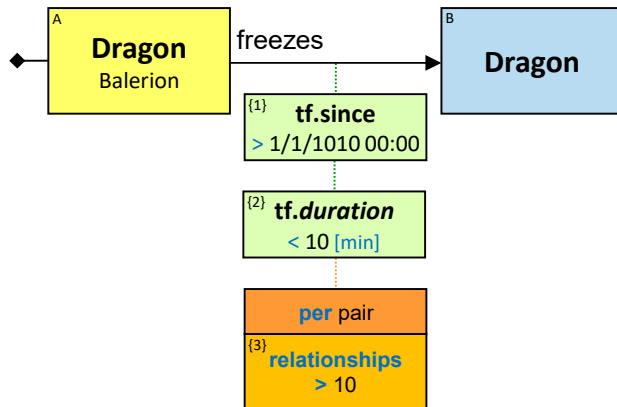

Note that the order of the constraints along the chain matters: the top two constraints filter relationships based on the value of their properties. The third constraint is on the number of relationships that passed these filters.

**Q259:** Any person who since 1011 become owner of zero to four horses

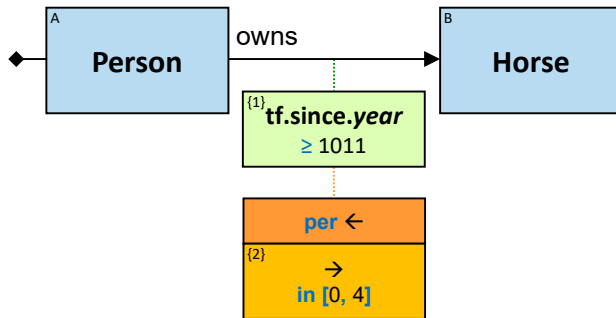

Again, the order of the constraints along the chain matters: the top constraint filters relationships based on the value of their properties. The second constraint is on the number of distinct entities that passed the first filter.

Note that the second constraint is satisfied also if no relationship satisfies the top constraint. Since the second constraint is a zero-count constraint, it would be evaluated nonetheless.

**Q302:** Any dragon A that froze at least three dragons - each at least one freeze where at least two of the following conditions are satisfied: (i) the freeze duration was longer than 10 minutes (ii) the freeze started after 1/1/980 (iii) the freeze ended before 1/2/980

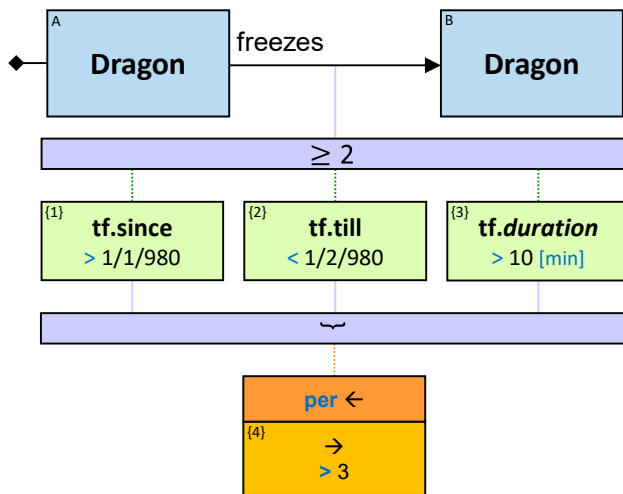

**Q303:** Any dragon pair (A, B) where A froze B at least three times - each for more than 10 minutes and either the freeze started after 1/1/980 or the freeze ended before 1/2/980

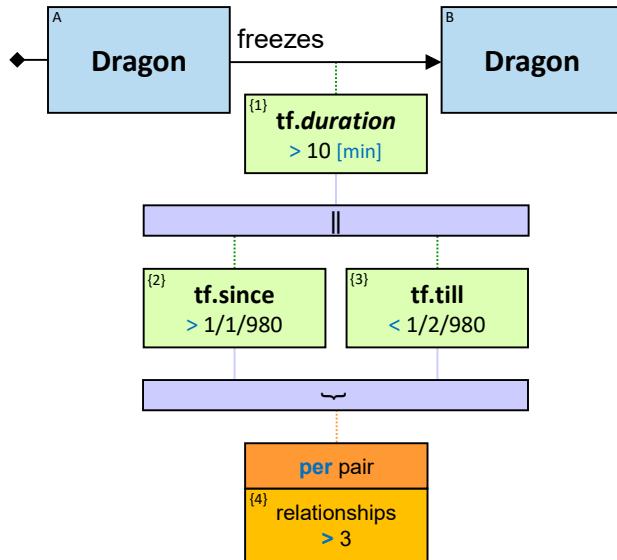

**Q115:** Any person who at a certain date became an owner of more than five horses (version 1)

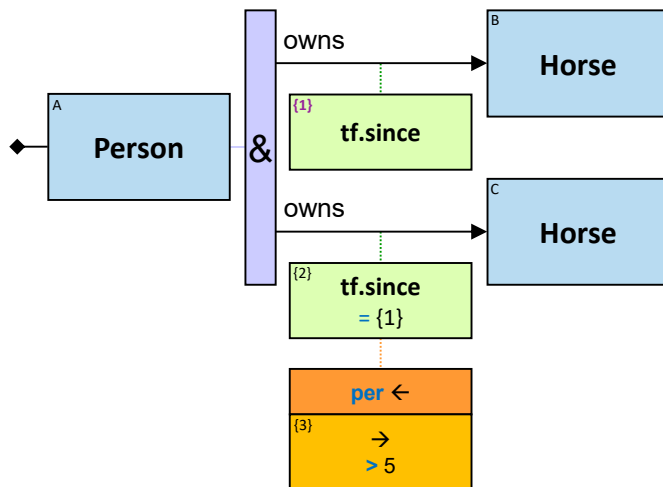

**Q289:** Any person who at a certain 3-day interval became an owner of more than five horses

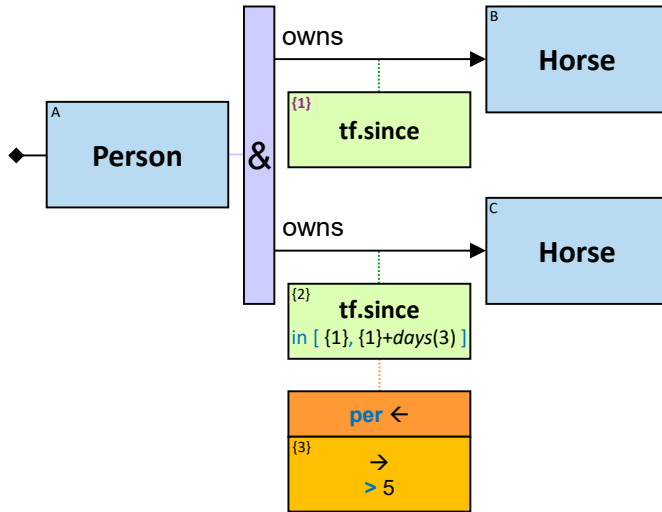

**Q283:** Any person who at a certain day owned at least five horses

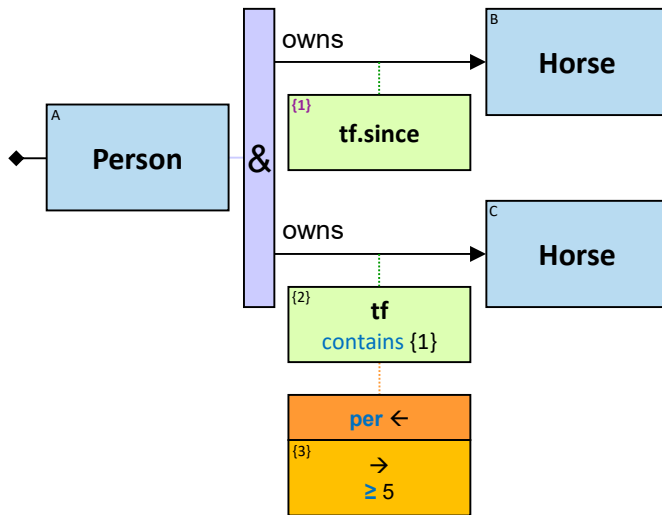

When  $n$  intervals intersect, the intersection contains the start-time of at least one interval (it also contains the end-time of at least one interval).



*Q285: Any person who at a certain day owned at least five horses and at least five dragons*

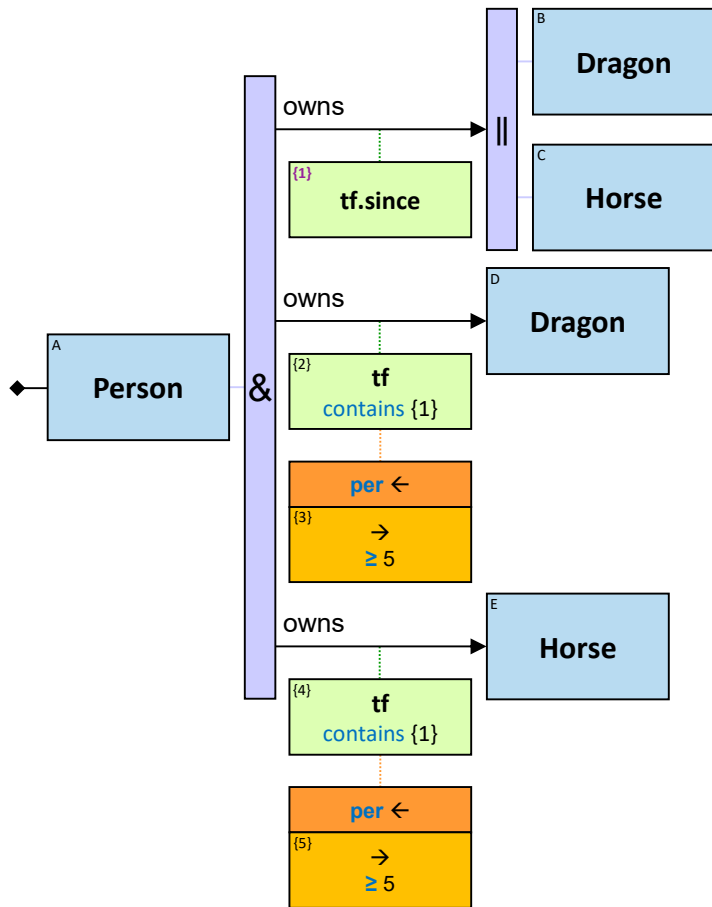

**Q284:** Any person who owned at least five horses for at least 10 consecutive days (the same horses throughout the whole period)

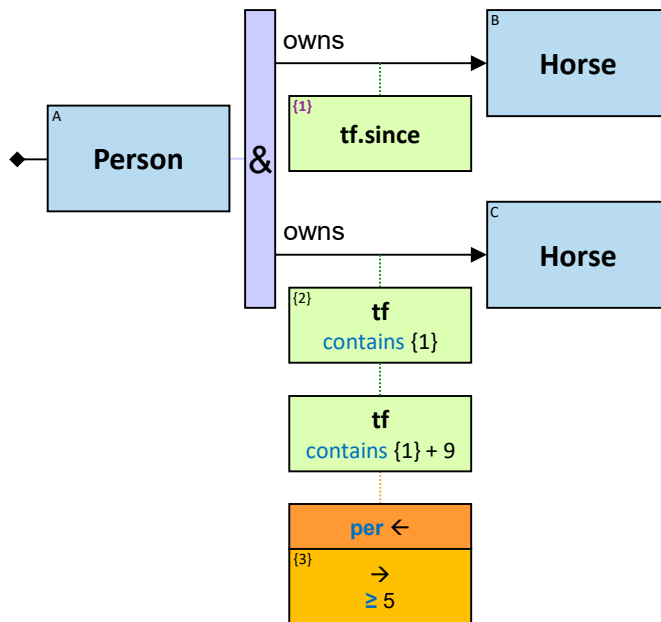

**Q93:** Any dragon A that froze more than three dragons - each at least five times for more than 10 minutes

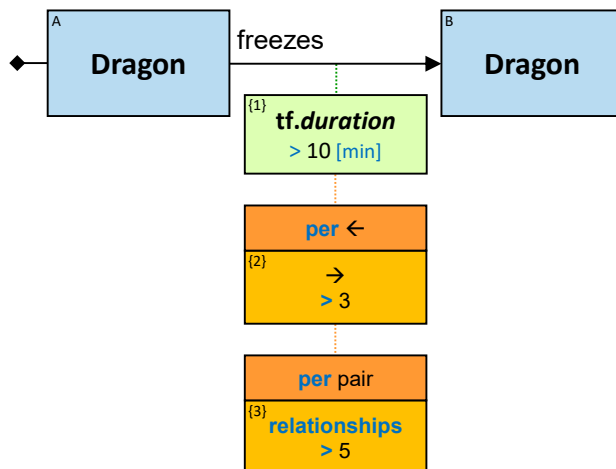

Filtering stages:

- Pass only freezes that are longer than 10 minutes
- Pass only dragons A that froze at least three dragons (for more than 10 minutes)
- Pass only dragon pairs (A, B) where A froze B (for more than 10 minutes) - at least five times

**Q94:** Any dragon that froze at least three dragons - each at least five times for more than 10 minutes

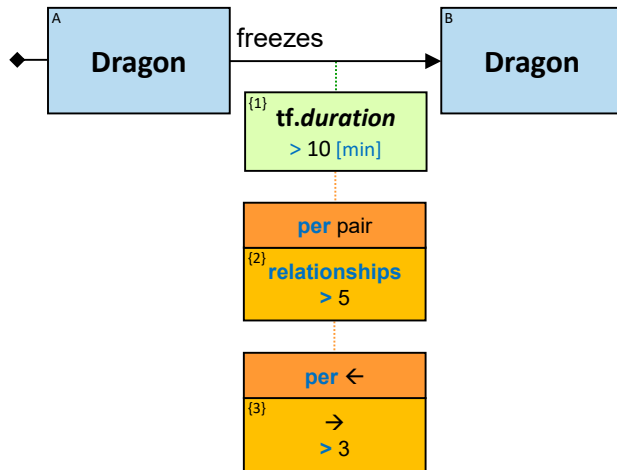

Filtering stages:

- Pass only (freezes that are longer than 10 minutes)
- Pass dragon pairs (A, B) where A froze B at least five times for more than 10 minutes
- Pass only dragons A that froze for more than 10 minutes - at least three dragons

**Q274:** The four dragons that froze some dragon - with the globally-longest freezes

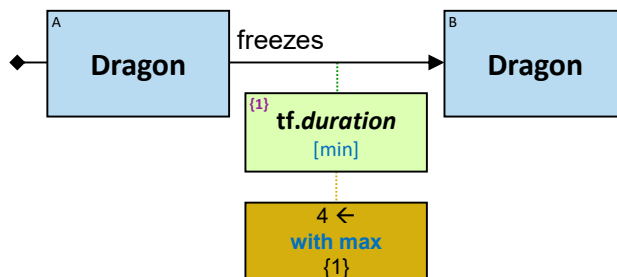

Even if one dragon is responsible for, say, the 10 globally-longest freezes, we would still get four more dragons (those with the next globally-longest freezes).

**Q91:** The four dragons with the maximal (shortest duration they were frozen for)

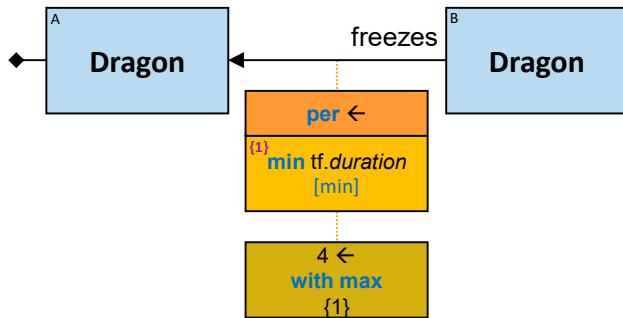

**Q92:** The four dragons with the maximal (average duration they froze dragons for)

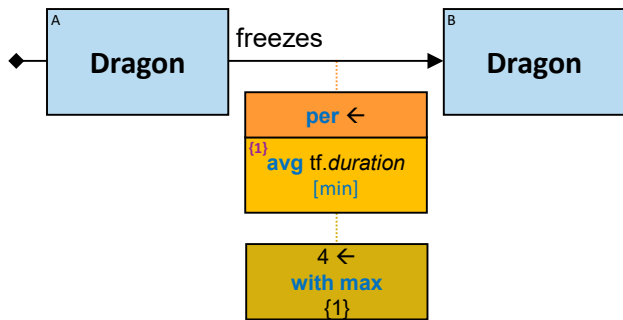

**Q328:** The three people with the maximal cumulative horse ownership days

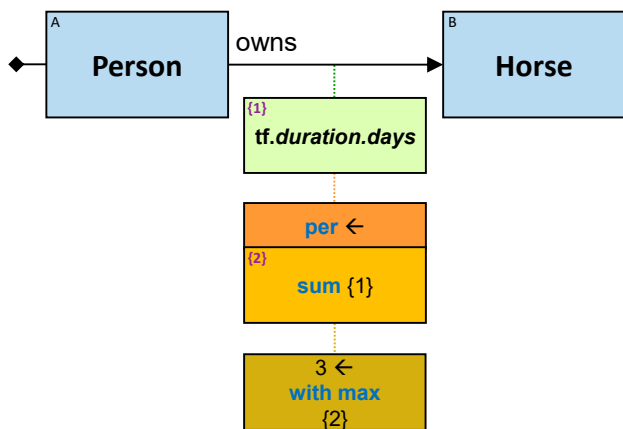

**Q133:** *The four people who the average weight of their horses is maximal*

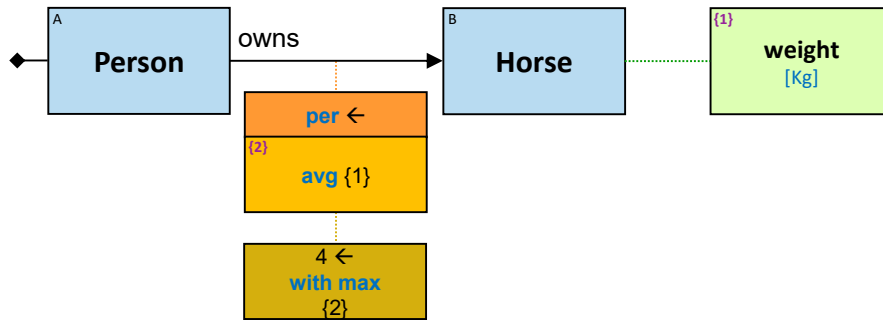

**Q132:** *The four people who own horses of the largest number of colors*

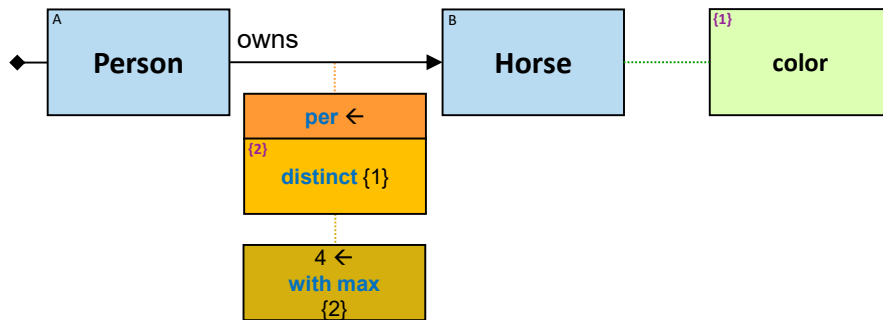

**Q138:** *The four people who the people each of them knows - cumulatively own horses of the largest number of colors*

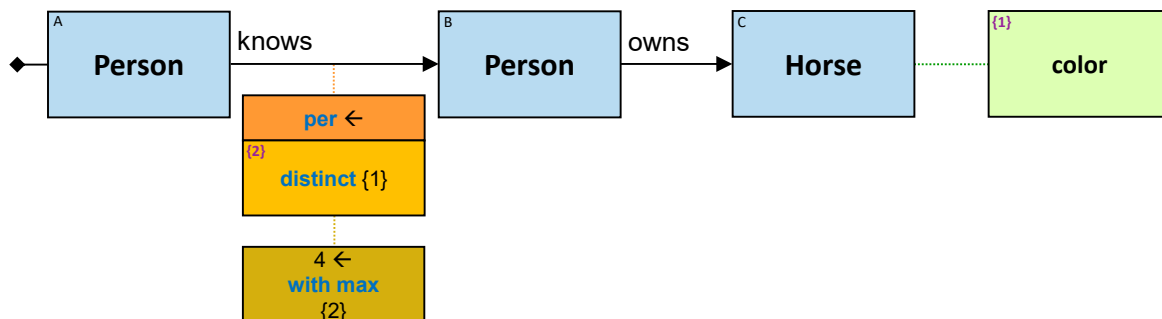

**Q183:** The three dragons that dragons owned by Brandon Stark froze for the longest cumulative duration

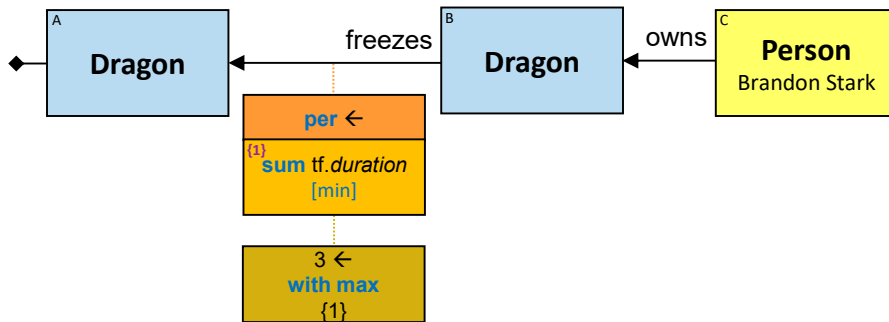

**Q168:** The three people who the number of types of entities each of them owns - is the largest

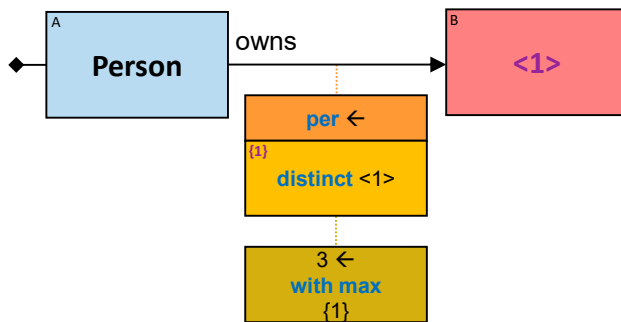

**Q163:** Any dragon that the average duration of the 10 shortest times it freezes is greater than 60 minutes

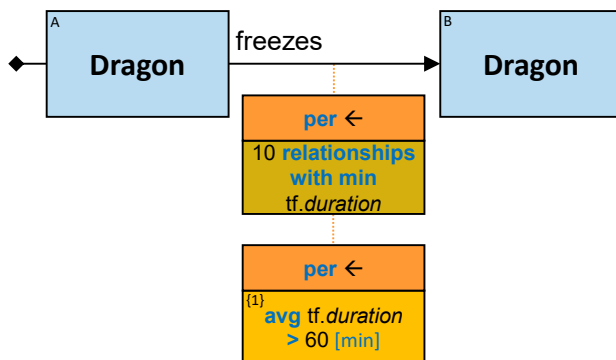

**Q162:** Any dragon pair (A, B) where the second shortest duration A froze B is longer than 60 minutes

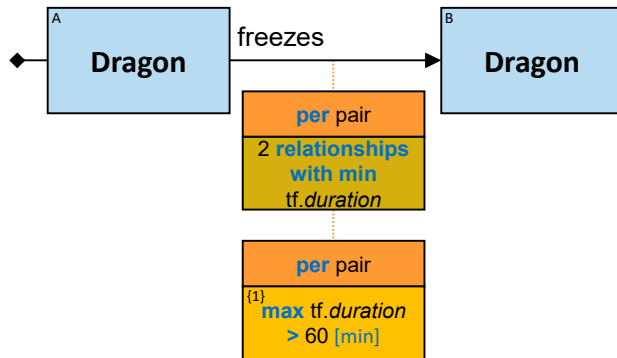

**Q268:** Any dragon pair (A, B) where the average duration of the 11th-20th longest freezes A froze B is longer than 60 minutes (two versions)

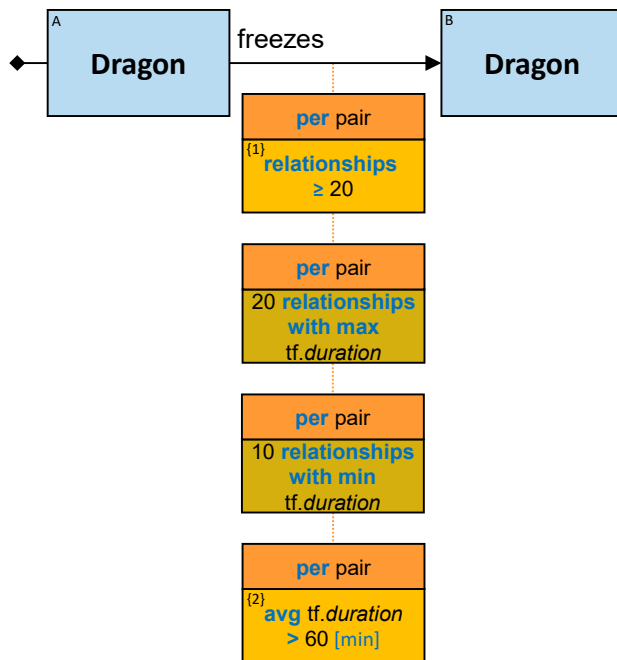

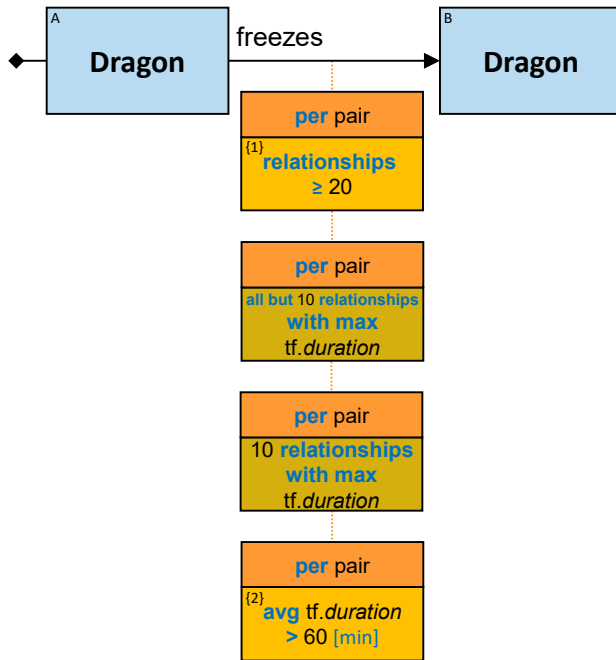

**Q272:** Any dragon pair (A, B) where the longest freeze duration is at least 10 times longer than the shortest freeze duration

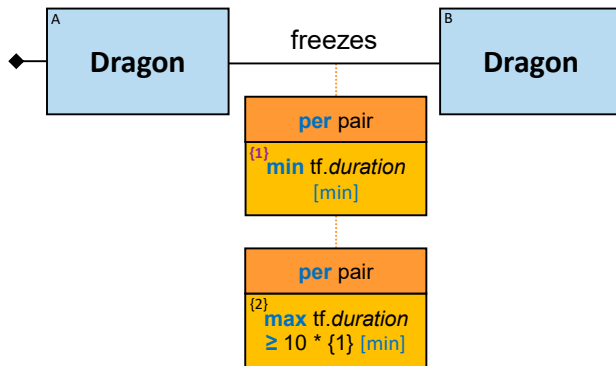



**Q324:** The five people with the smallest number (including 0) of paths with length  $\leq 4$  to some person

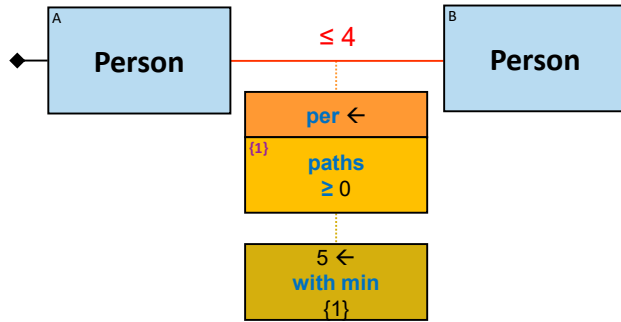

(Compare with Q172)

**Q317:** Any dragon that the time difference between the earliest time it froze / fired at some dragon and the latest time it froze / fired at some dragon - is at least one year

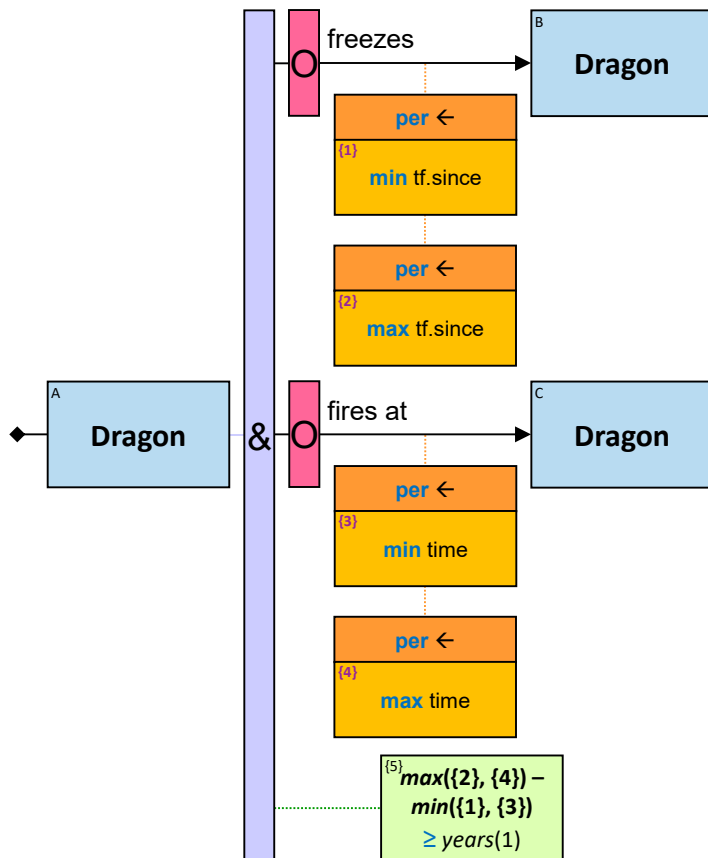

Note that {1}, {2}, {3} and {4} are defined right of an ‘O’, hence evaluated as *empty* when the optional part has no valid assignment. Since  $max(n, empty) = n$ , the pattern is valid even when dragon A froze no dragon, or alternatively, fired at no dragon.

**Q120:** Any person whose three oldest offspring’s cumulative height is lower than his own height

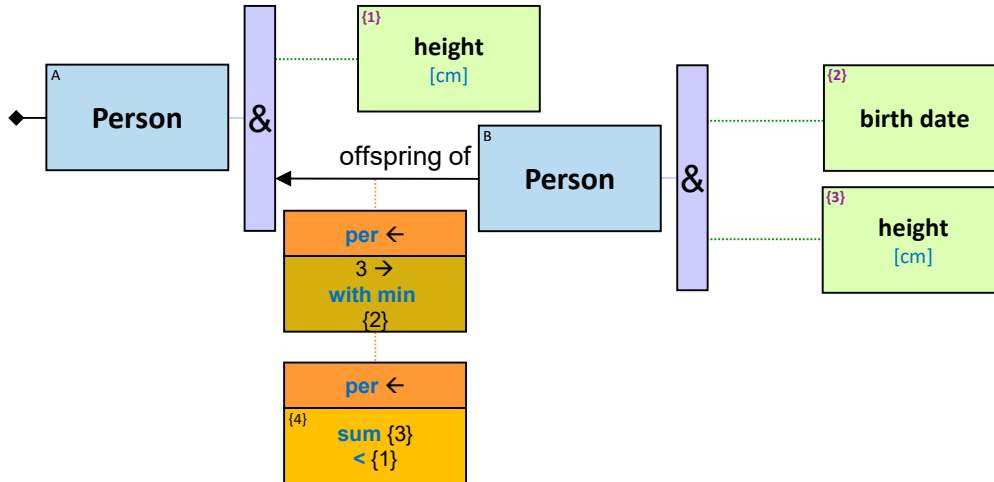

**Q202:** Any person whose three oldest offspring’s average height is lower than the average height of all his offspring

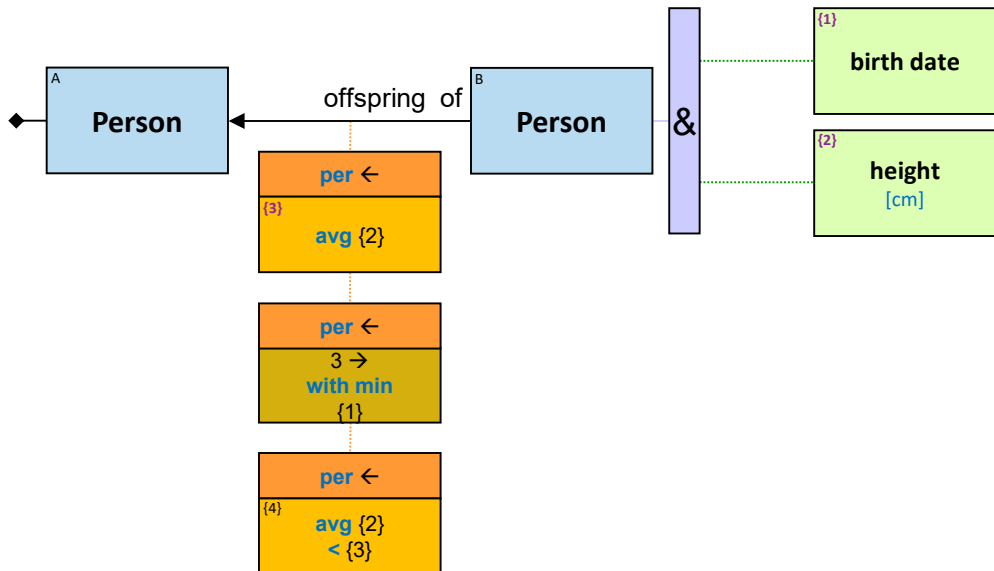

**Q140:** Any person whose three oldest sons cumulatively own horses of three colors

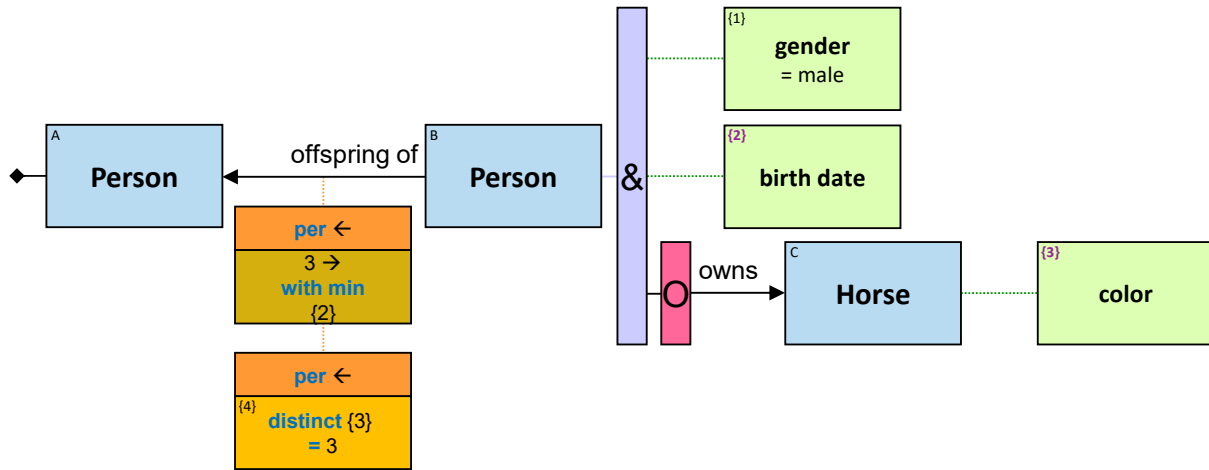

Note that {3} is defined right of an 'O' and is evaluated as *empty* when the optional part has no valid assignment. *distinct()* does not count *empty* assignments.

**Q141:** Any person whose three oldest sons cumulatively own horses of the same number of colors as of those cumulatively owned by his three youngest daughters

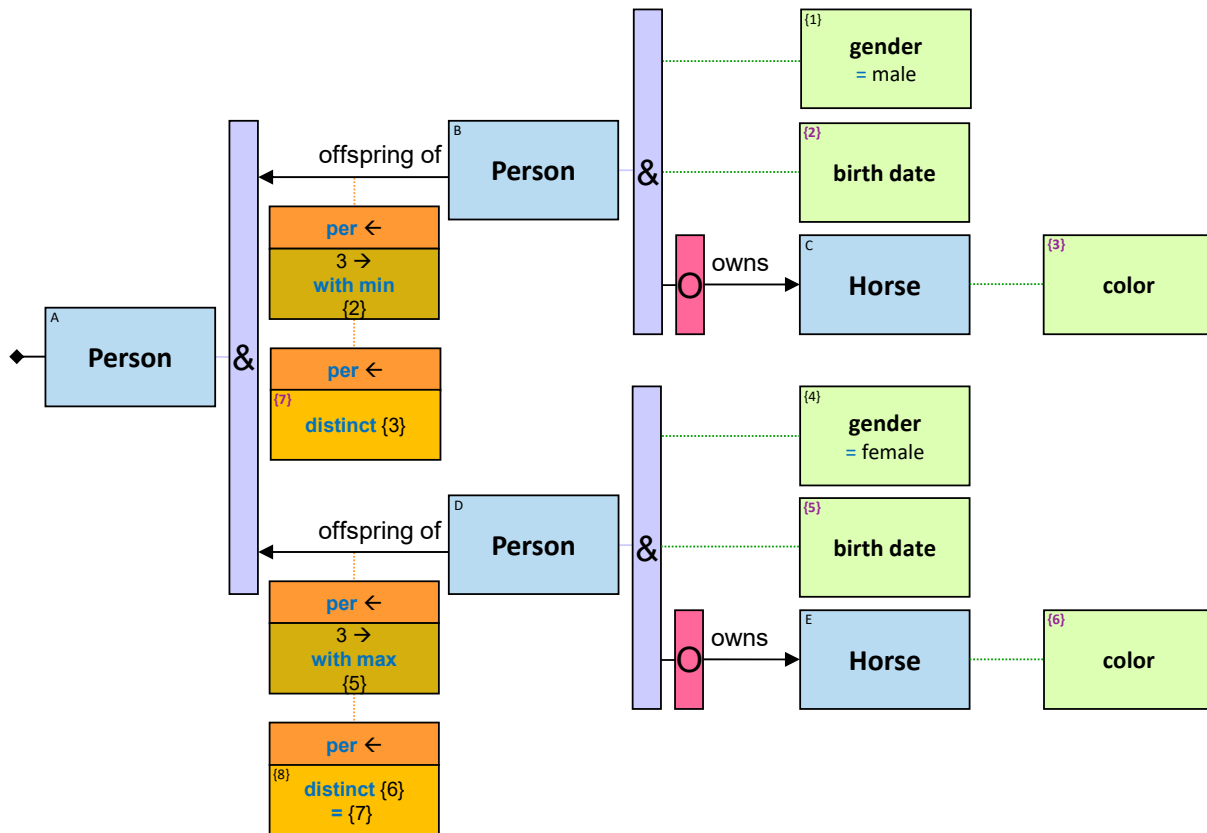

**Q95:** Any dragon that was frozen by Balerion: there were more than five freezes for more than 10 minutes, and their total duration was longer than 100 minutes (3 versions)

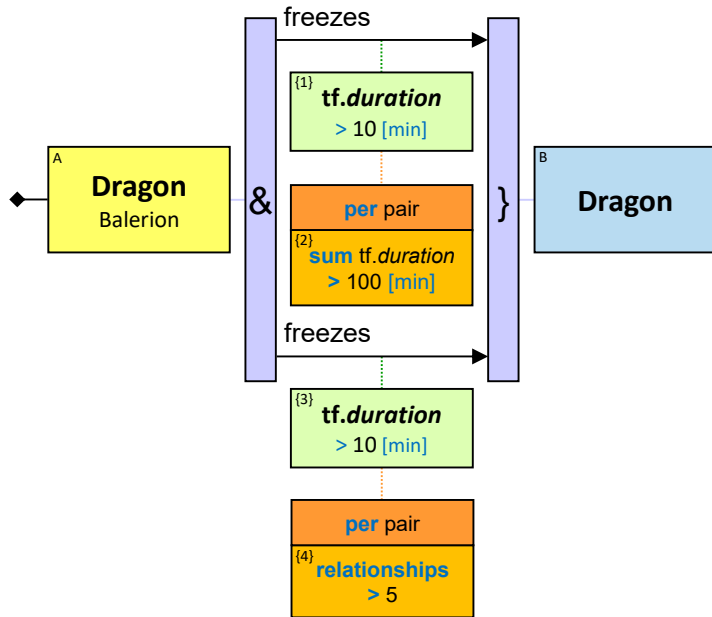

The two ‘per pair’ constraints could be chained instead. The meaning would be similar:

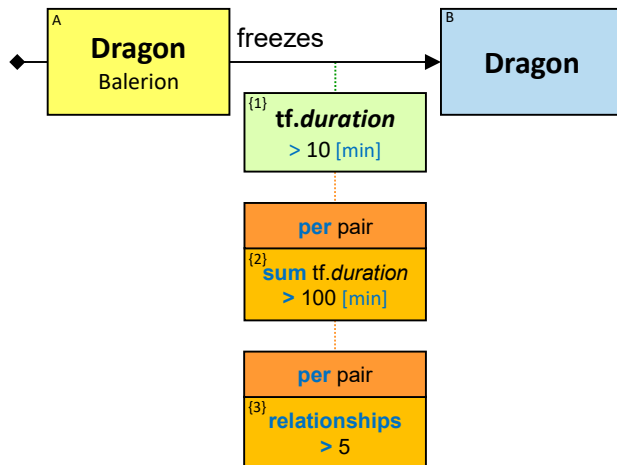

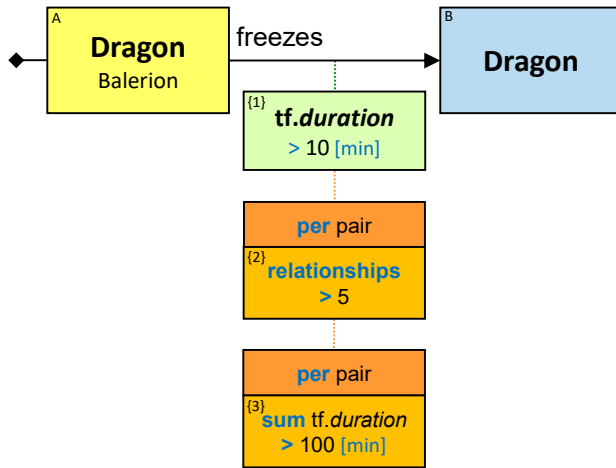

*Q186: Any dragon to that Balerion froze more than 10 times for less than 10 minutes, and at least once for 10 minutes or more*

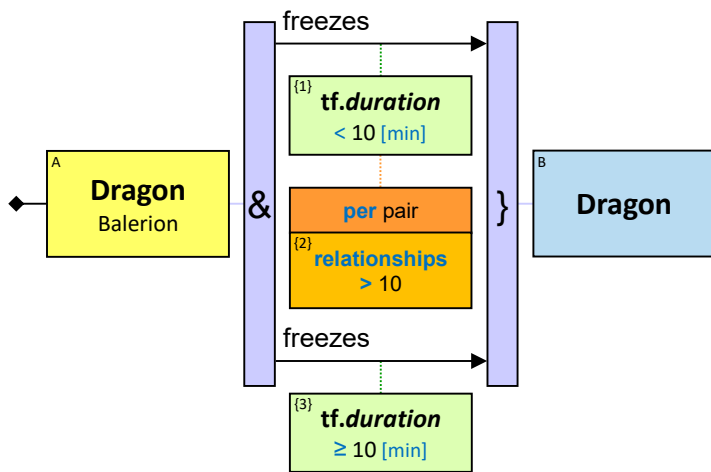

**Q99:** Any dragon to that Balerion froze more than 10 times for less than 10 minutes, and not once for 10 minutes or more (3 versions)

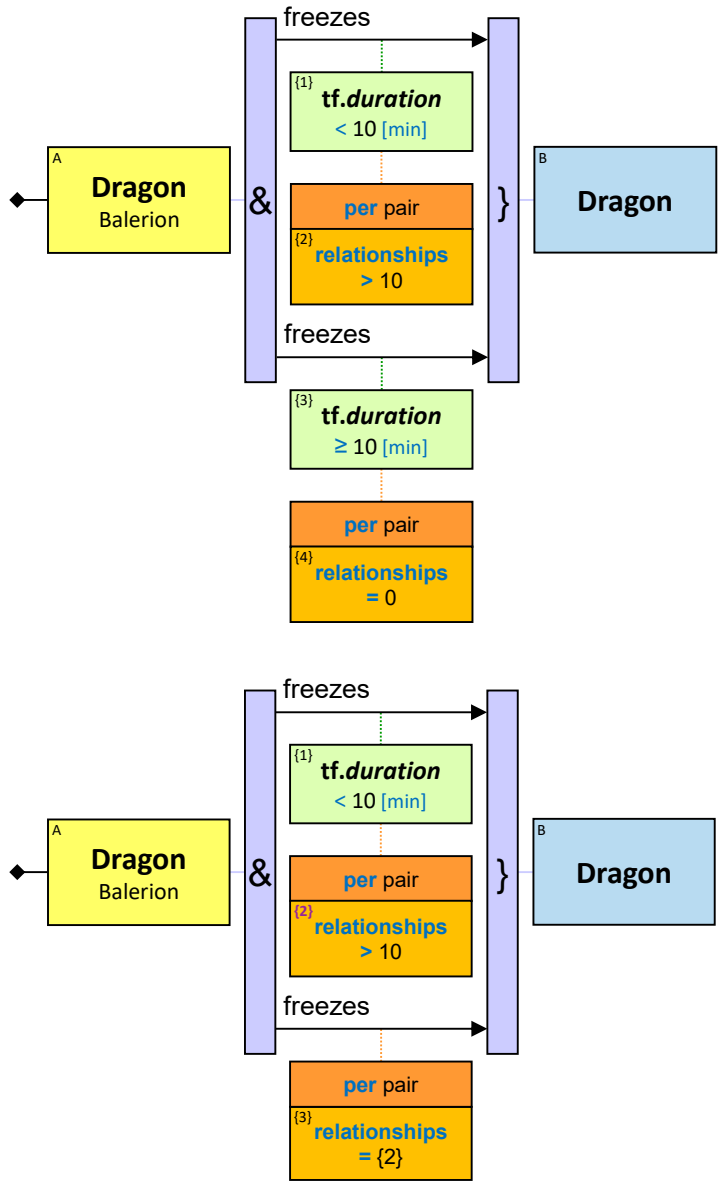

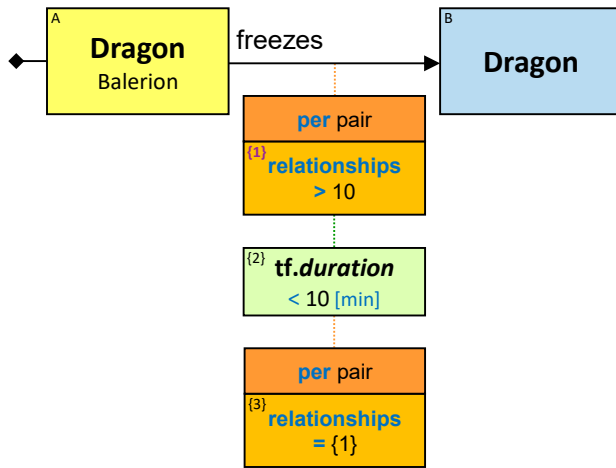

*Q199: Any dragon that (froze more than 10 times each of more than 10 dragons) and (froze more than 20 times each of less than 10 dragons)*

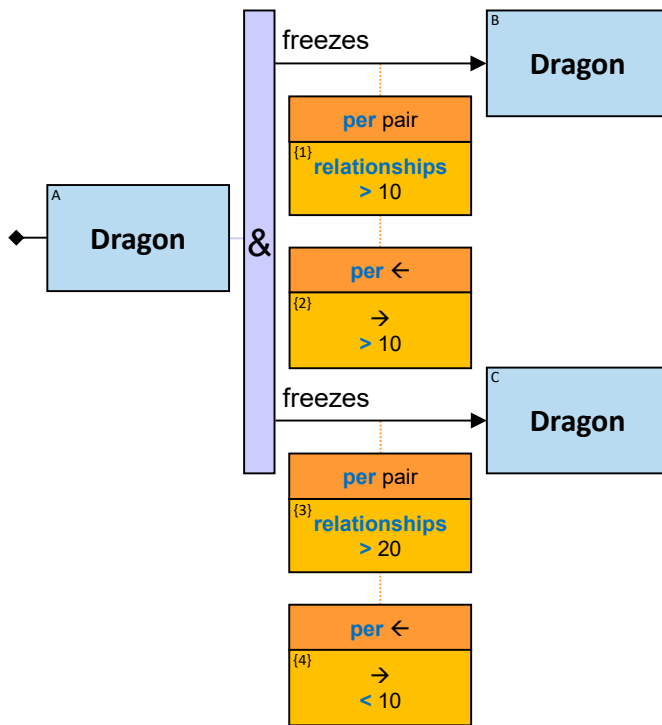



**Q200:** Any dragon that (froze more than 10 times each of more than 10 dragons. For each of these 10 dragons - the freezes had exactly two distinct durations) and (froze more than 20 times each of less than 10 dragons. The average freeze duration of all these dragons - is greater than 3 minutes)

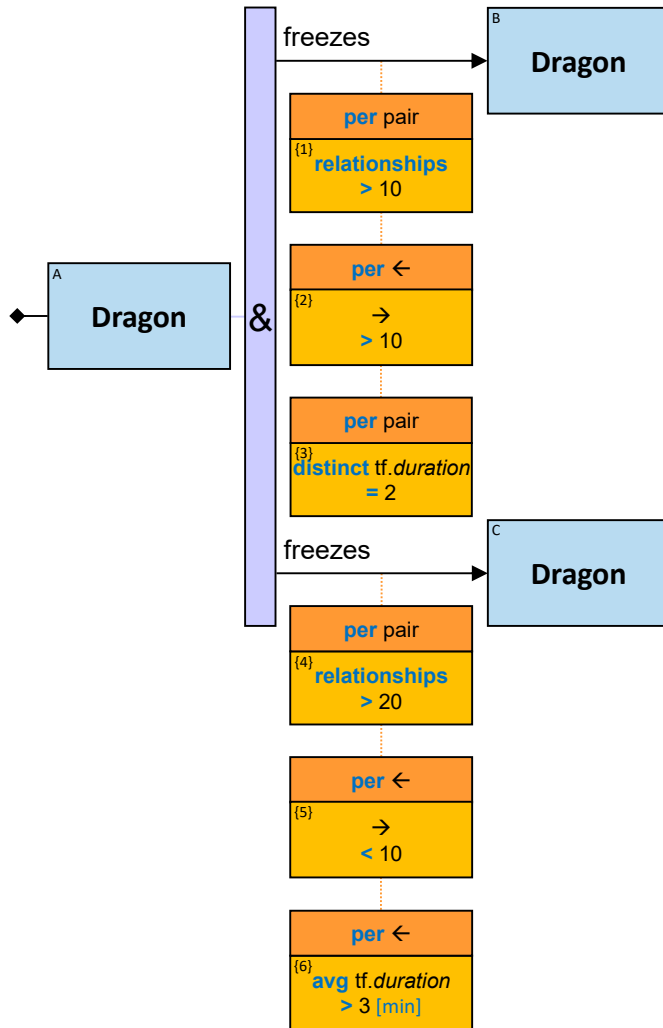

**Q277:** Any dragon that the longest (cumulative duration it froze some dragon) is more than 10 times longer than the shortest (cumulative duration it froze some dragon) (two versions)

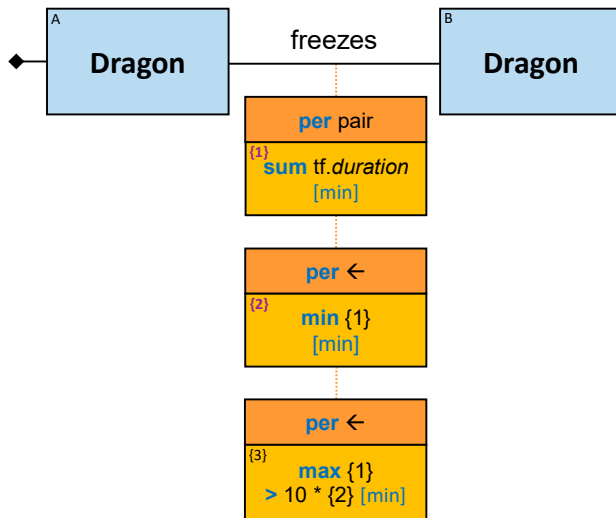
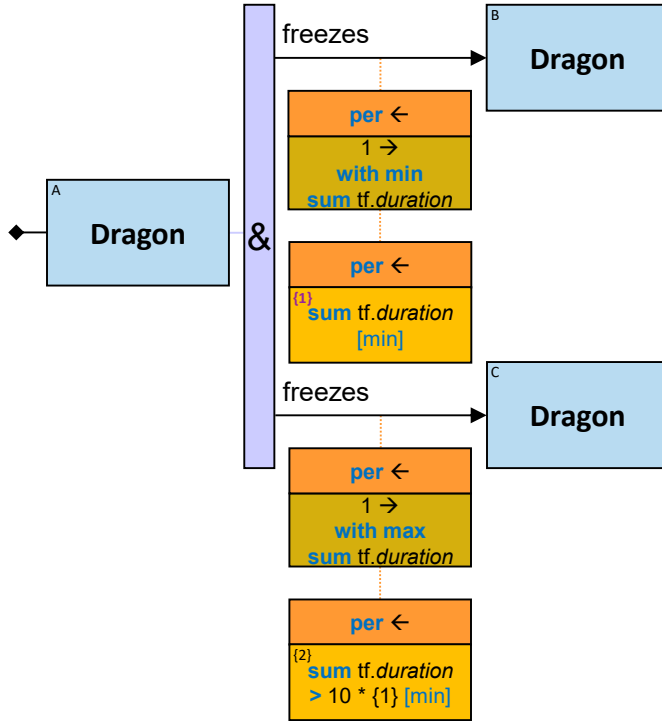

39 AGGREGATION SEQUENCES

Several aggregations may appear along a sequence. Here are some examples:

**Q128:** Any person and his three offspring that own horses of the largest number of colors

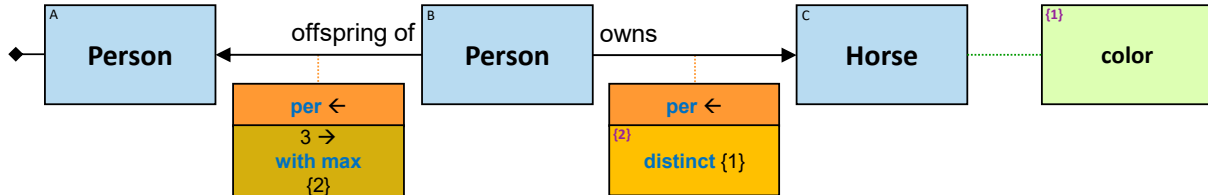

**Q198:** Any person and his three dragons that (for each of them: the four dragons it froze that froze the largest number of dragons) - froze the largest number of distinct dragons cumulatively

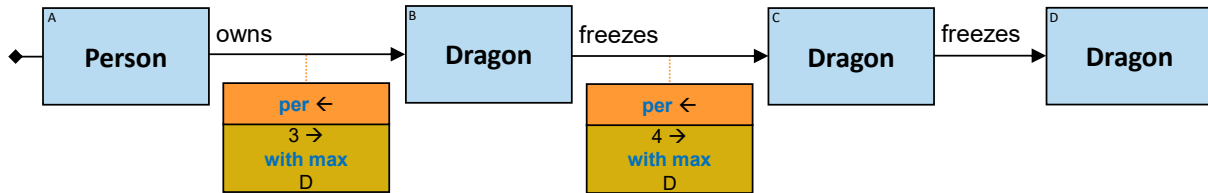

**Q103:** Any dragon A that froze at least three dragons - each was frozen by at least four dragons other than A

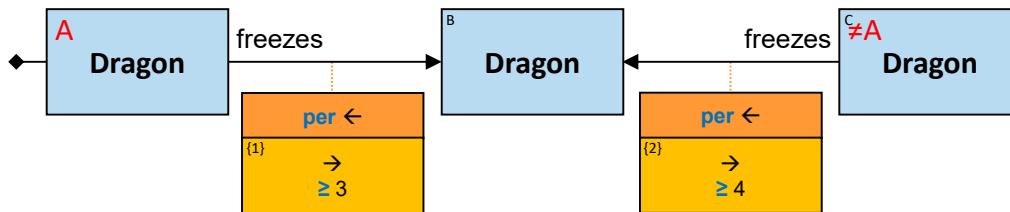

**Q106:** Any dragon A that froze dragons at least three times - each was frozen at least four times by dragons other than A

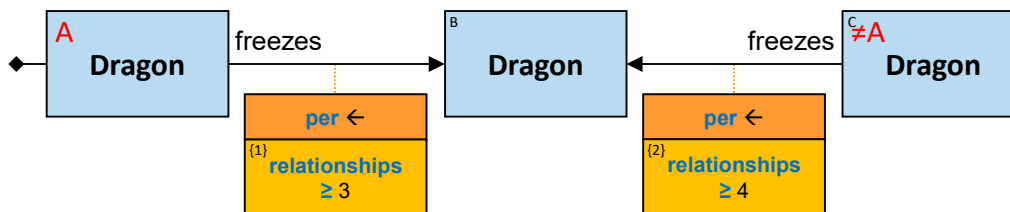

**Q107:** Any **dragon** that (the number of dragons, each owned by five people, that froze it) is 5, and that the number of times it was frozen by those dragons (cumulatively) is not 5

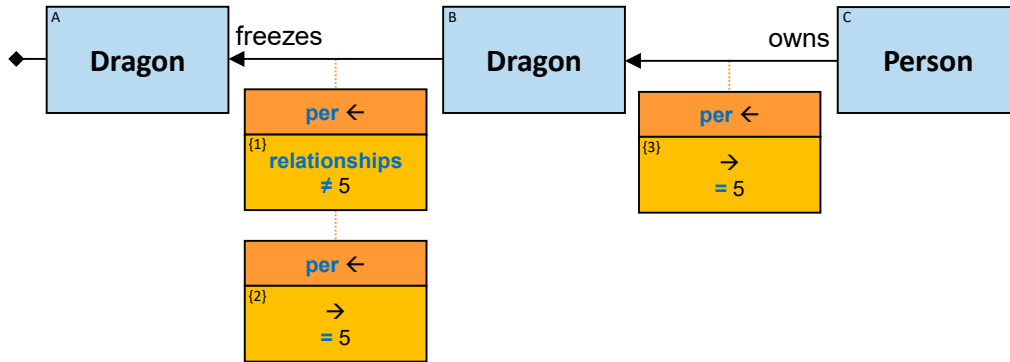

**Q169:** Any person who (has at least one offspring who owns at least three horses) and (each of his offspring who owns at least three horses - owns horses of at least three colors)

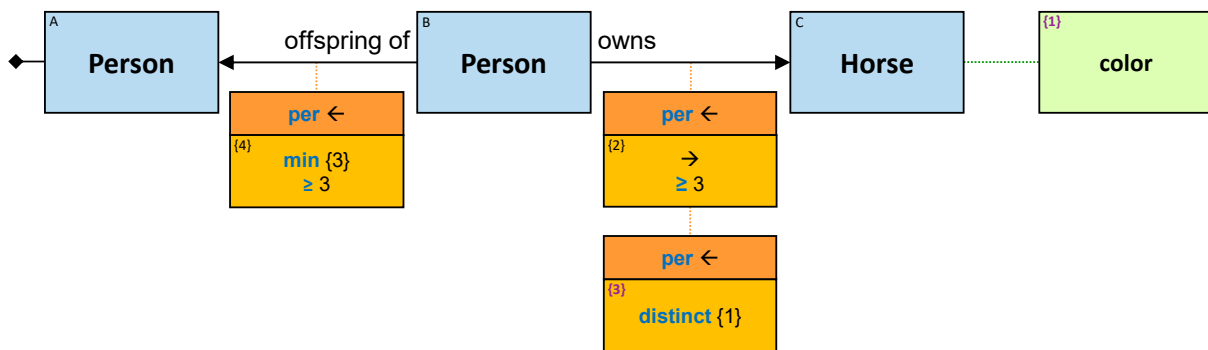

**Q129:** Any person that (each of his offspring who owns at least one horse - owns a different number of horses)

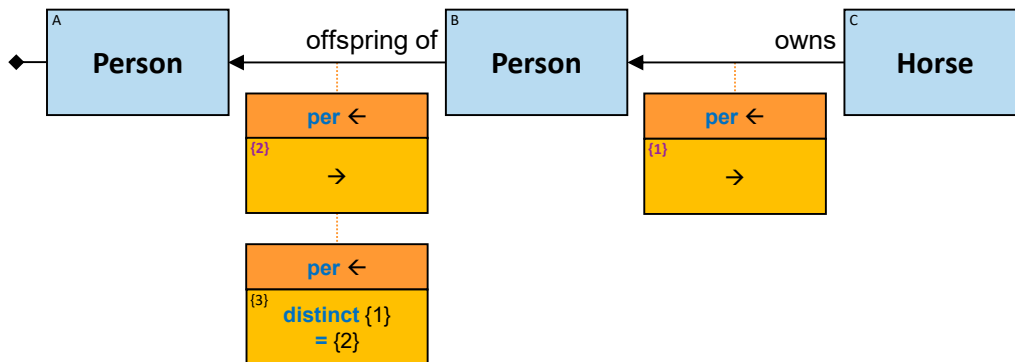

**Q181:** Any *dragon* with no intersection between the groups of dragons froze by any two dragons *it* froze

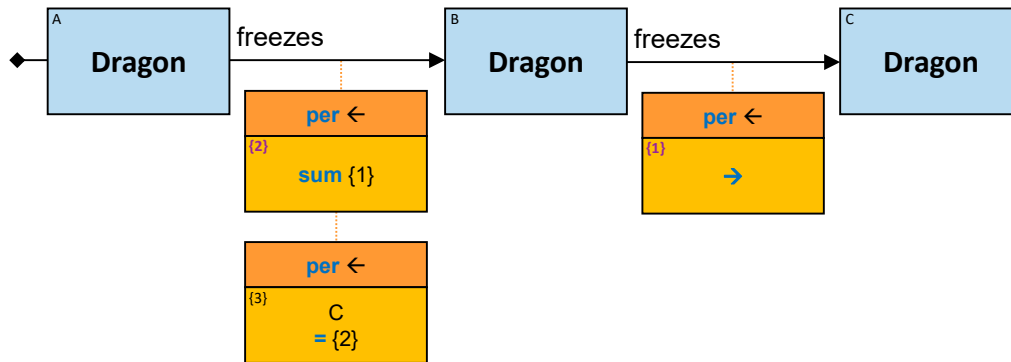

**Q164:** Any dragon that the number of times dragons it froze have frozen dragons (cumulatively) - is equal to the number of times dragons it fired at have fired at dragons (cumulatively)

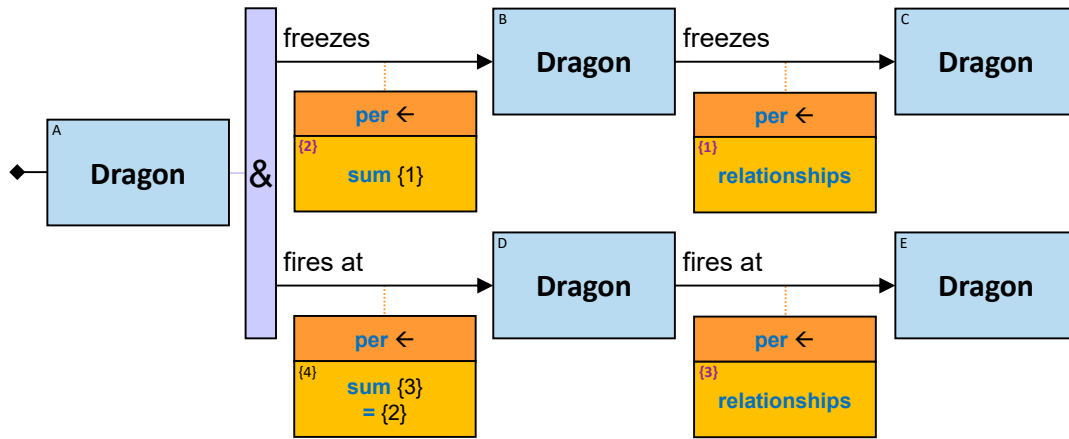

**Q179:** Any dragon pair (A, B) where A froze B for a cumulative duration longer than the cumulative duration that B froze dragons (two versions)

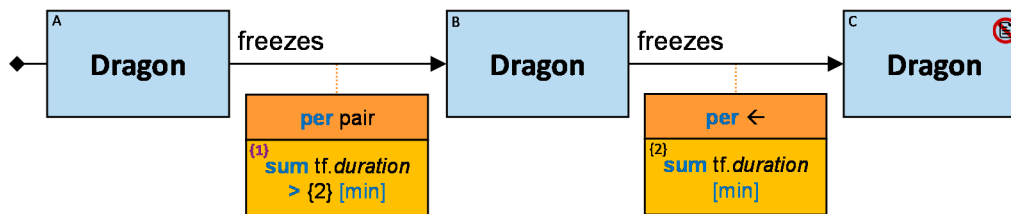

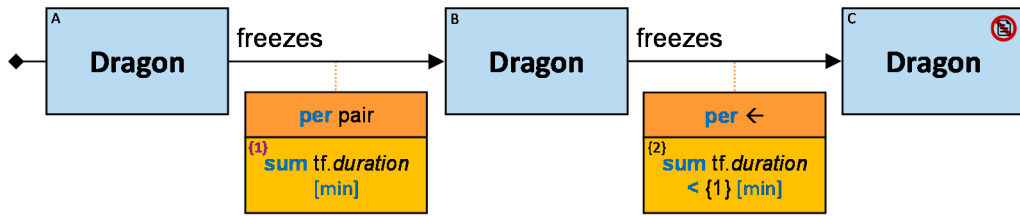

**Q213:** Out of the dragon pairs (A, B) where A froze B for a cumulative duration longer than the cumulative duration that B froze dragons - the five pairs with the largest number of times A froze B

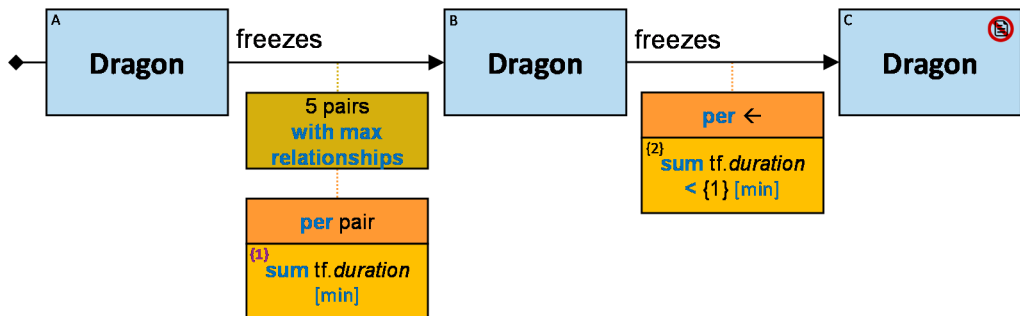

Note that the order of the filtering stages along the left chain can be switched. The semantics would remain the same.

**Q191:** Any dragon that froze dragons S and fired at dragons T.  $|S| \geq 3$ ,  $|T| \geq 3$  and  $|S \cup T| \geq 10$

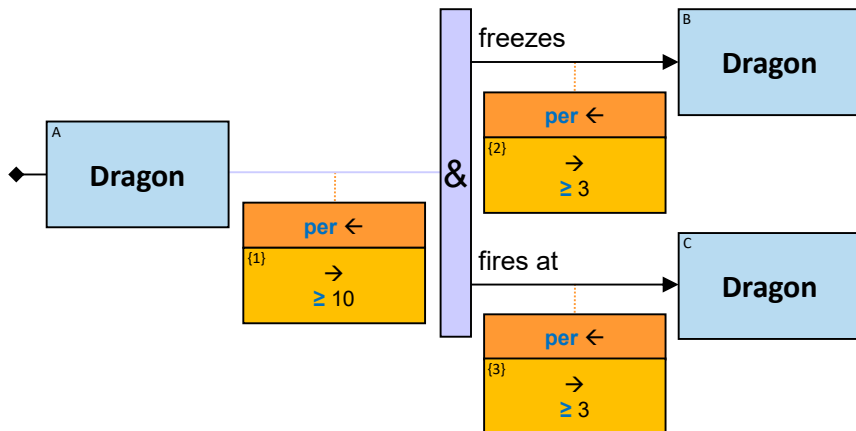

**Q192:** Any dragon that froze dragon  $m \geq 3$  times, and fired at dragons  $n \geq 3$  times.  $m+n \geq 10$

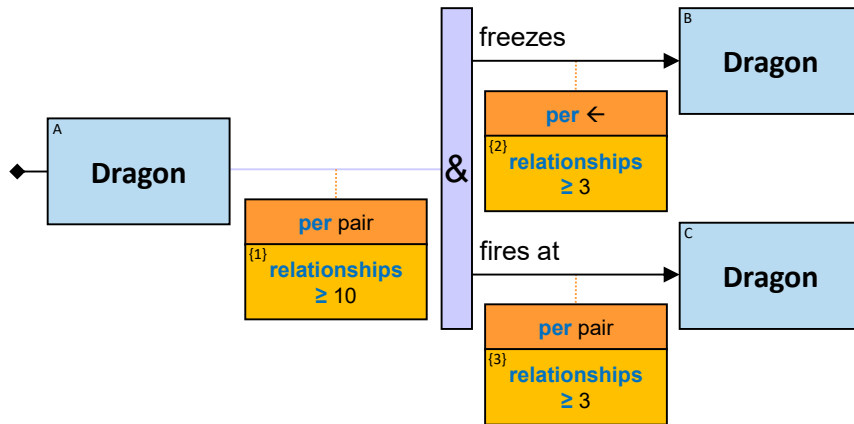

**Q193:** Any dragon that froze dragons  $S$ , fired at dragons  $T$ , and fired  $\geq 3$  times.  $|S| \geq 3$  and  $|S \cup T| \geq 10$

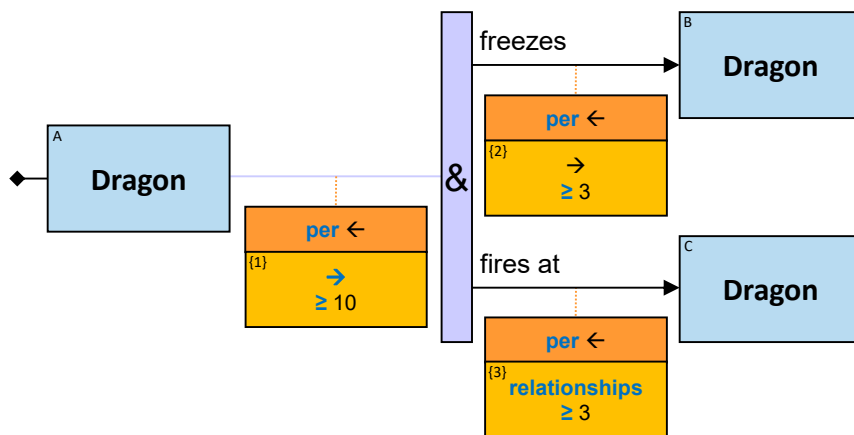

**Q194:** Any dragon that froze dragons  $m$  times, fired at dragons  $n \geq 3$  times, and froze  $\geq 3$  dragons.  $m+n \geq 10$

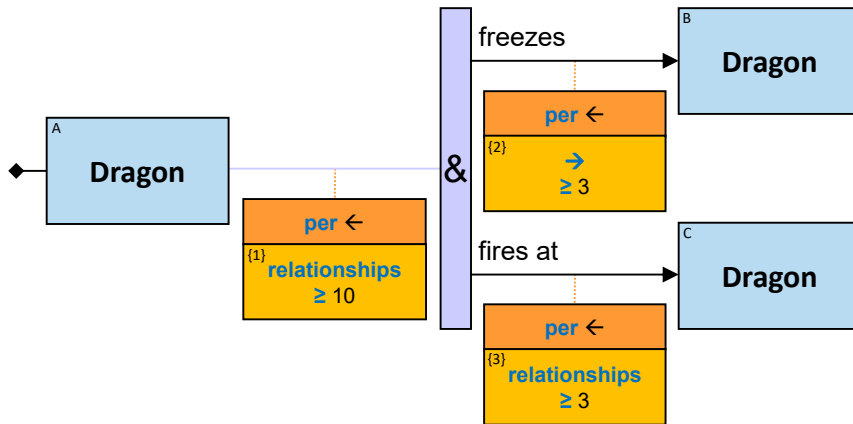

**Q97:** Any dragon that froze more than three dragons - each more than 10 times, or for a cumulative duration of more than 100 minutes

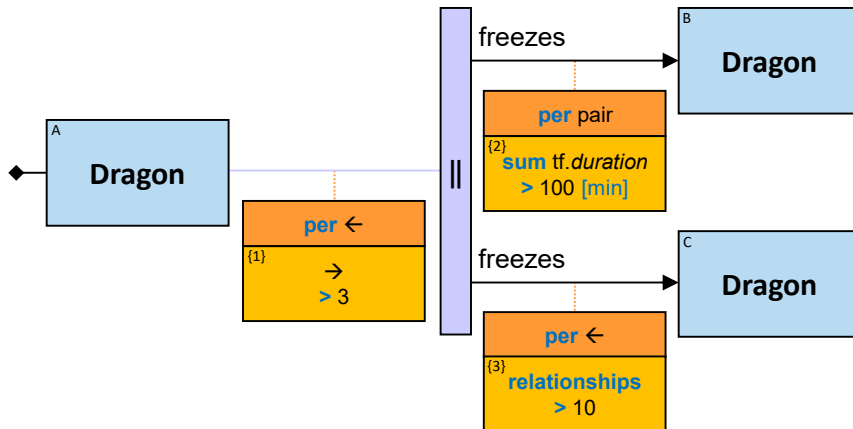

**Q180:** Any dragon pair (A, B) where the cumulative duration A and B froze each other - is greater the cumulative duration A froze other dragons, and greater than the cumulative duration B froze other dragons (two versions)



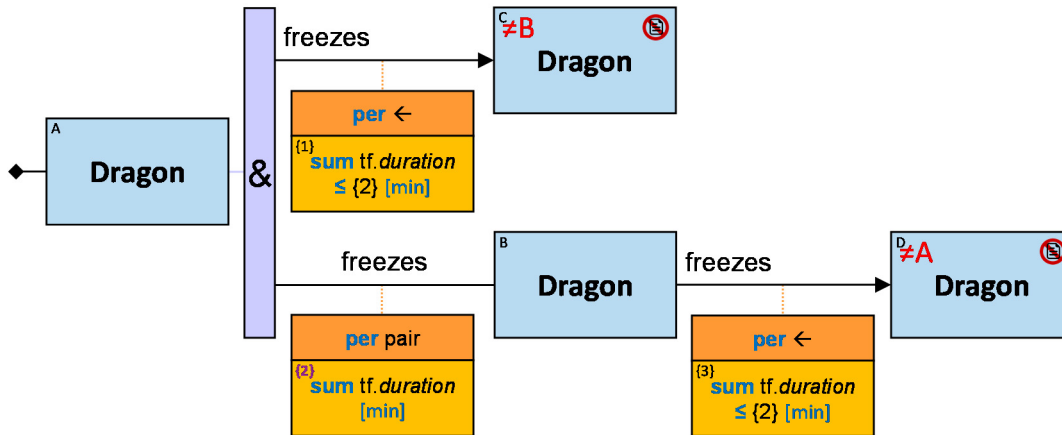

There is a slight problem with the pattern above: If A didn't freeze any other dragons, or if B didn't freeze any other dragons - we won't get the pair (A, B) as an answer. The following pattern fixes this:

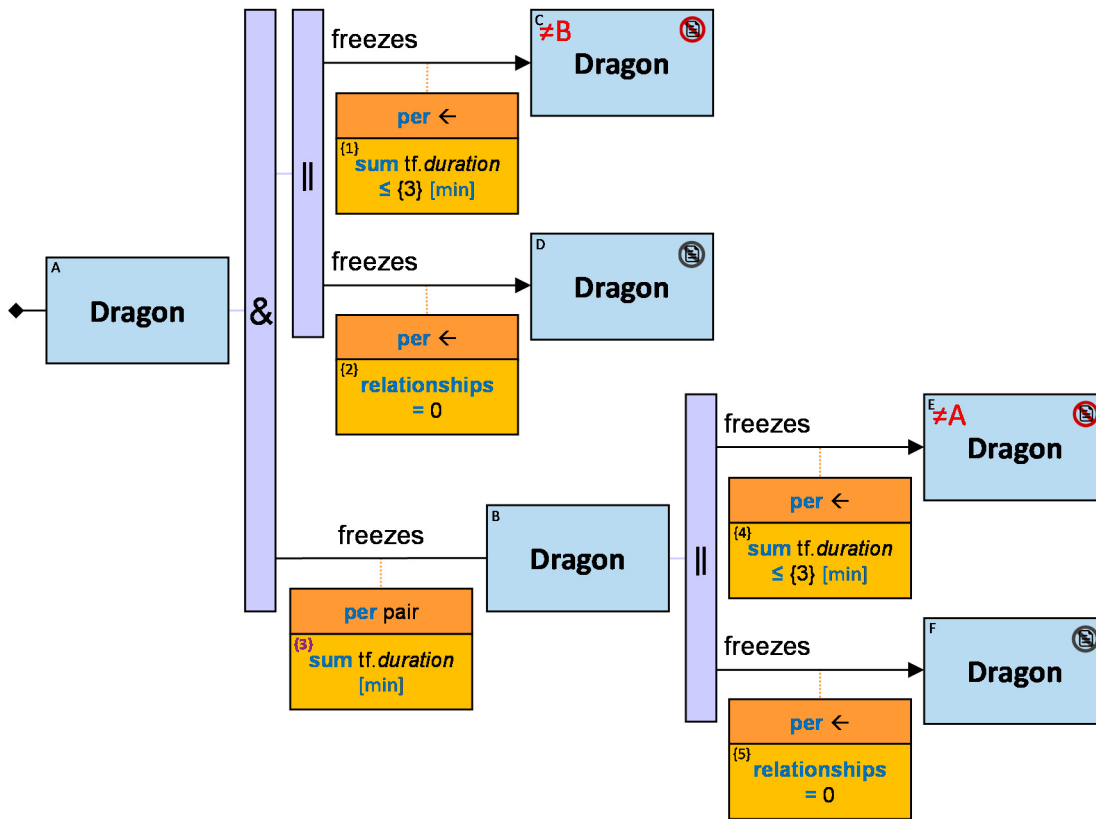

**Q100:** Any dragon which Balerion froze more than 10 times for less than 10 minutes, more than 10 times in 1/1/1010 or later, more than 15 times for less than 10 minutes or in 1/1/1010 or later, and more than 100 times altogether

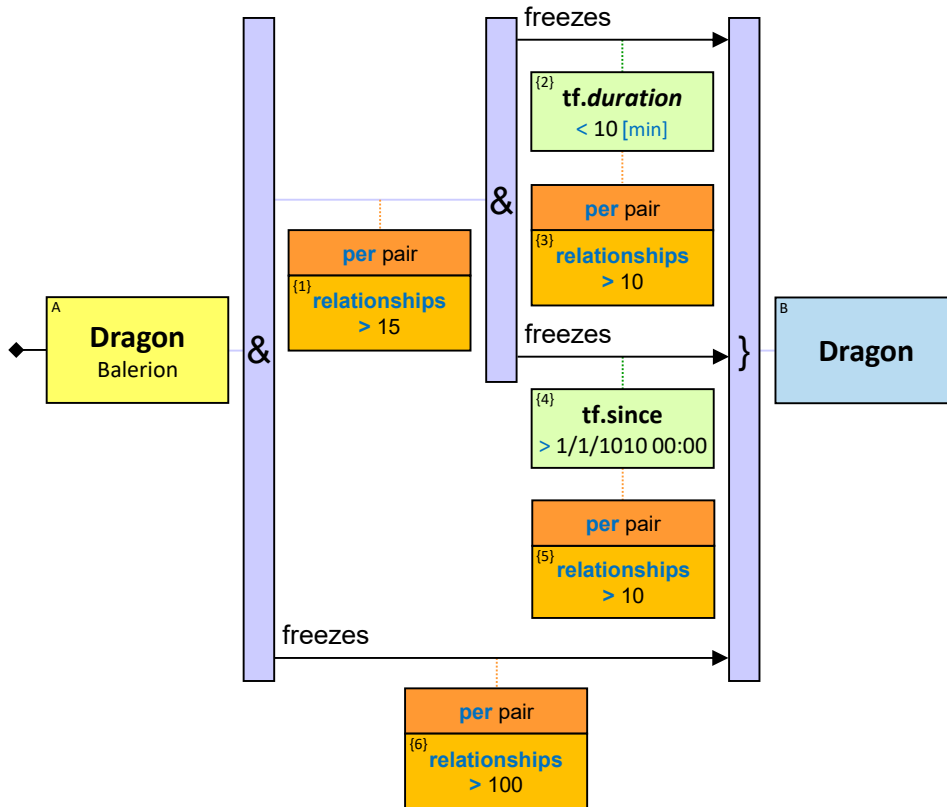

**Q158:** Any dragon that in each of at least 10 days - the number of dragons it froze is greater than the number of dragons that froze it

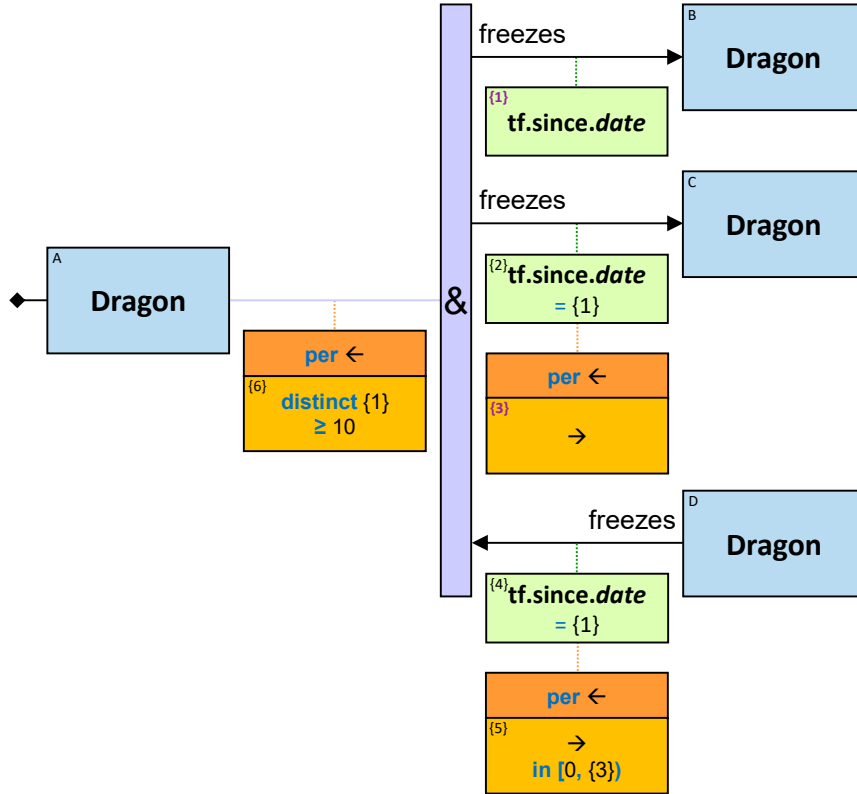

Note the location of {6}. If it was below {1} the meaning was different. As it is, {6} counts distinct assignments to {1} for which the "All" quantifier was satisfied.

**Q260:** Any dragon that in each of at least 10 days: (i) the number of dragons it froze is greater than the number of dragons that froze it, and (ii) it froze / was frozen at least five times

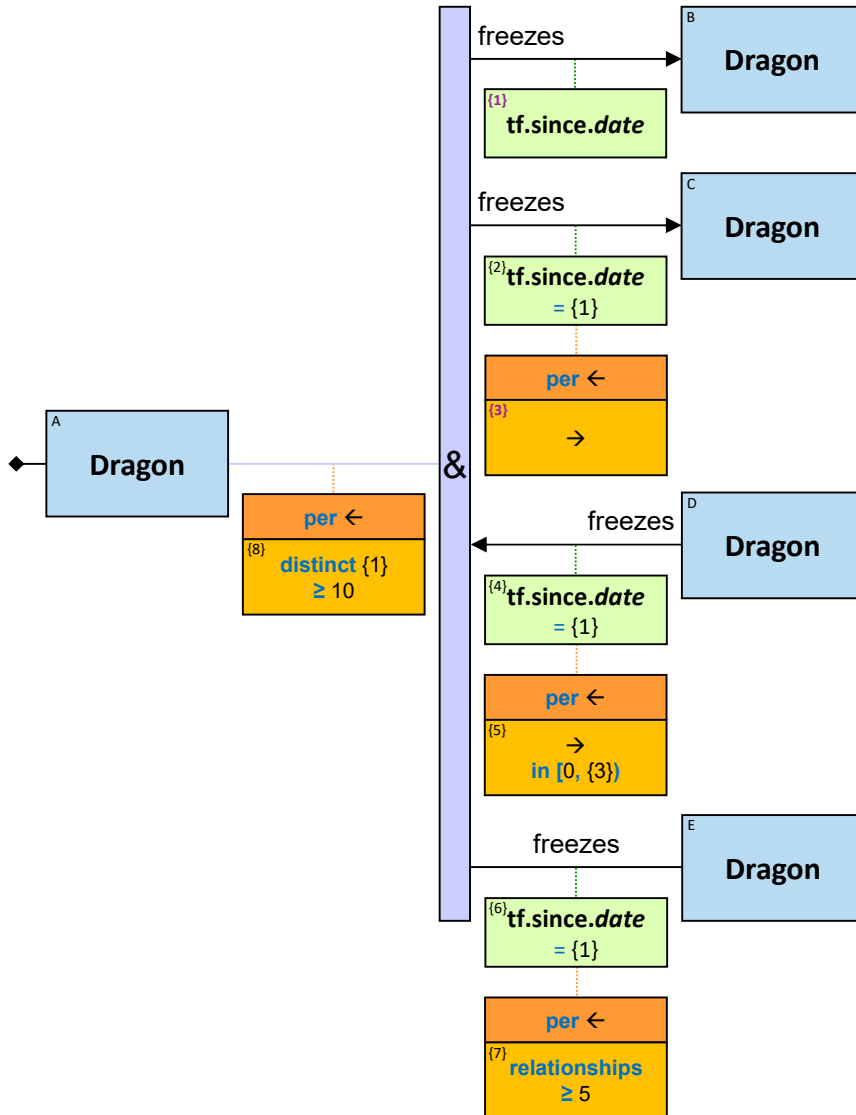

40 TAG RULES

**TR1:** For each entity tag, for each expression - only one expression tag will be assigned. When used more than once - the same expression tag will be assigned.

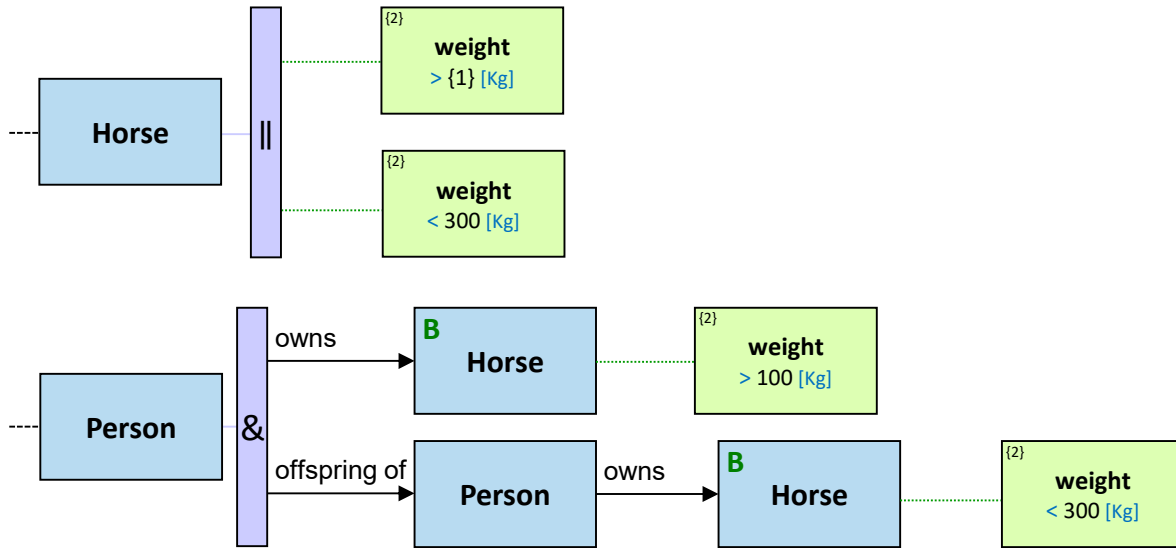

**TR2:** Self or circular tag references are invalid.

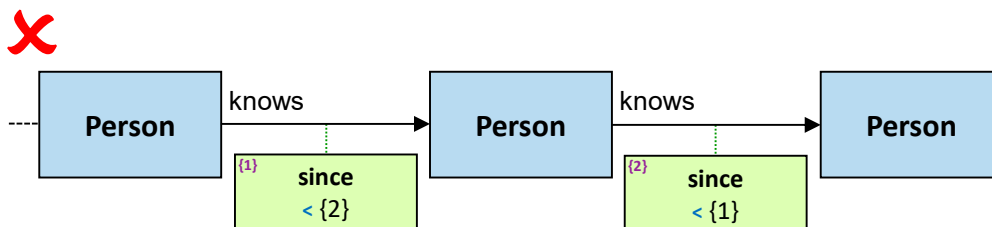
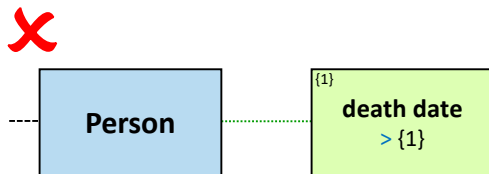

**TR3:** Several branches of an "All" quantifier may not reference tags circularly (e.g. branch 1 reference a tag defined in branch 2 and vice versa). There must be a valid order to evaluate branches.

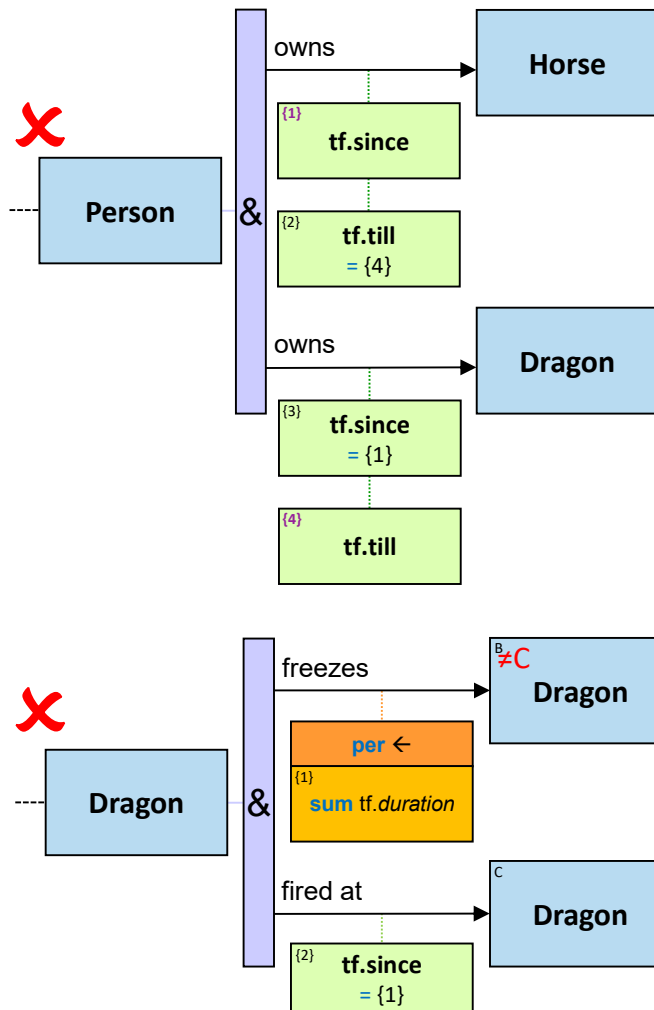

**TR4 - Tag scope:** A tag defined right of an 'X' - cannot be referenced left of its definition. Additionally - A tag defined right of an 'X' on a quantifier's branch - cannot be referenced in other branches. This include property tags of a relationship directly right of an 'X'.

Similarly, a tag defined right of a "relationships = 0", "paths = 0", or "→ = 0" aggregate constraint - cannot be referenced left of its definition, nor in other branches.

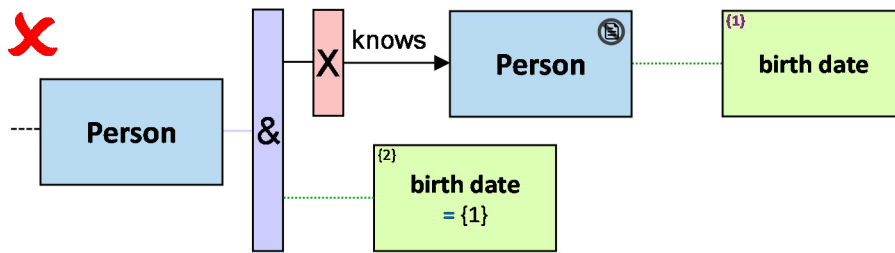

**TR5 - Tag scope:** A property tag of a relationship directly right of a ‘ $\rightarrow$ ’ - cannot be referenced left of its definition nor right of its definition. In addition, if it is defined on a quantifier’s branch, it cannot be referenced in other branches.

Note that tags of an entity defined directly right of a ‘ $\rightarrow$ ’ can be referenced.

**TR6 - Tag scope:** For each quantifier except *all* - a tag defined in a branch cannot be referenced in other branches, nor can it be referenced left of the quantifier.

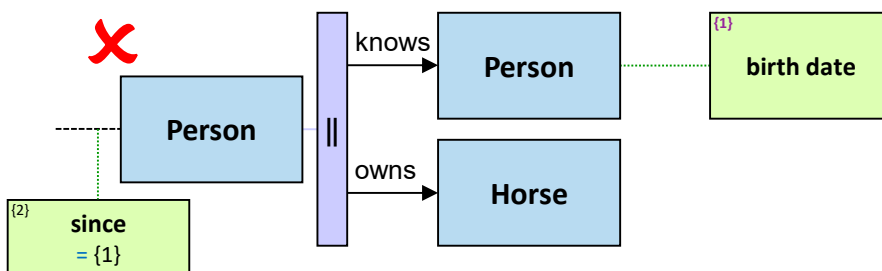
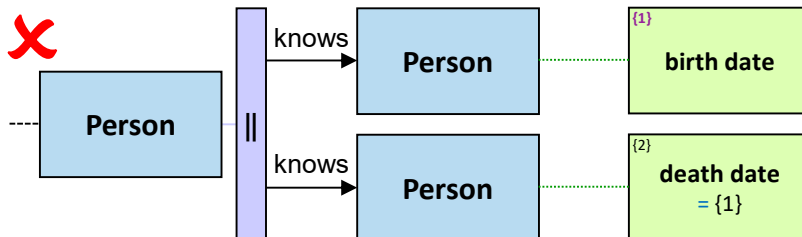

This does not include tags defined right of a combiner that combines all branches (see Q122, Q230, Q227, Q229).

**TR7 - Tag scope:** When an entity tag is used more than once - at least one instance ('the definition instance') must be within the scope of all other instances ('the reference instances').

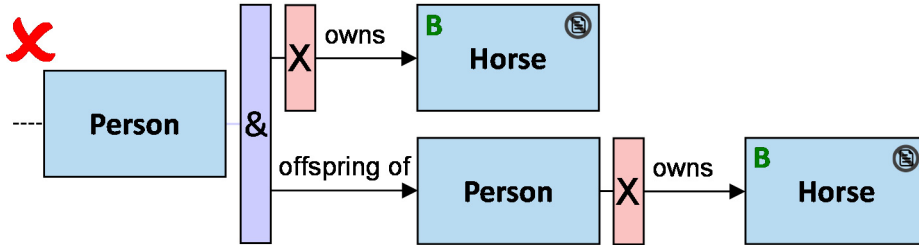

**TR8:** A tag defined right of an aggregator - cannot be referenced non-aggregately left of the aggregator / in other branches.

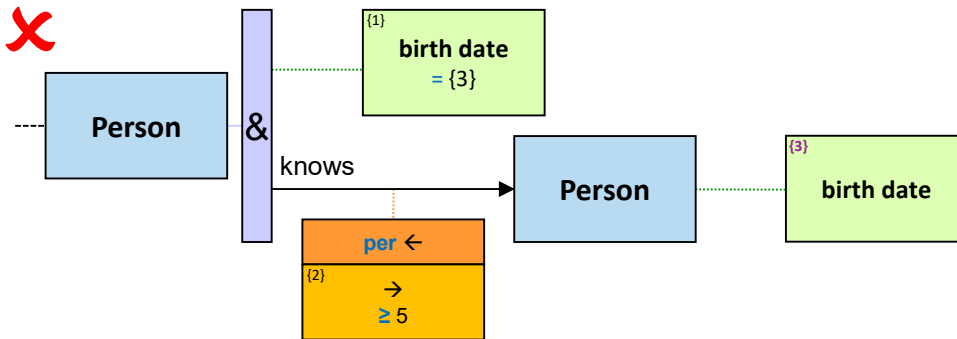



**TR9 - Tag scope:** A relationship's expression tag defined as part of an aggregation chain - cannot be used in other branches.

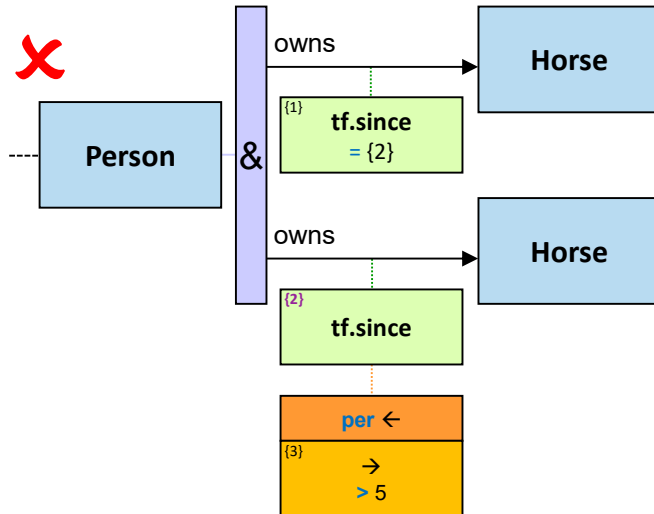

**TR10:** Identity / nonidentity constraints can't be defined for an entity tag that has an aggregative context

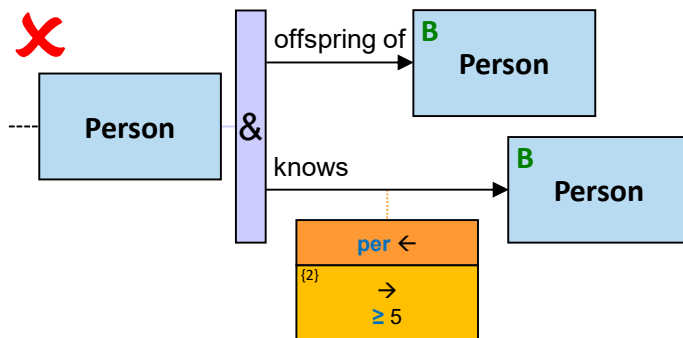

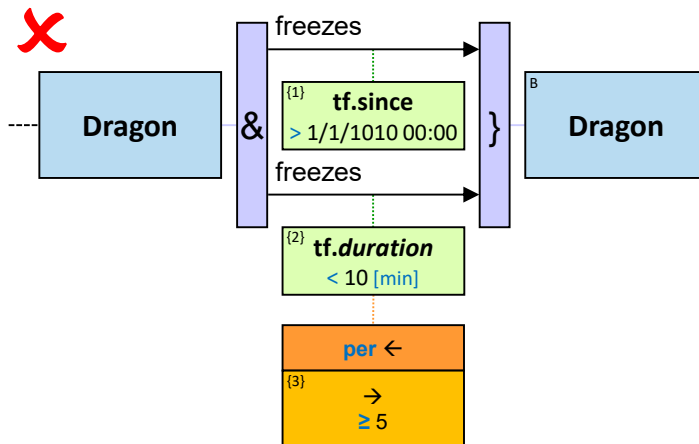
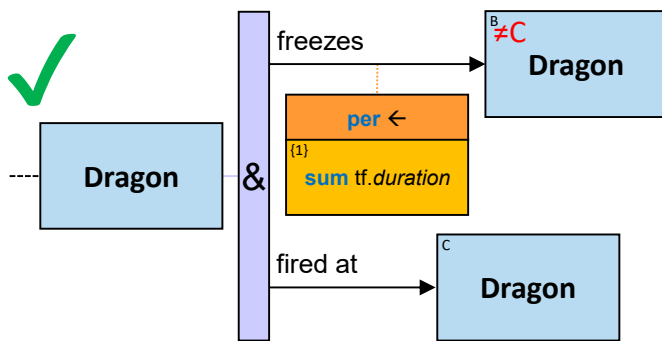
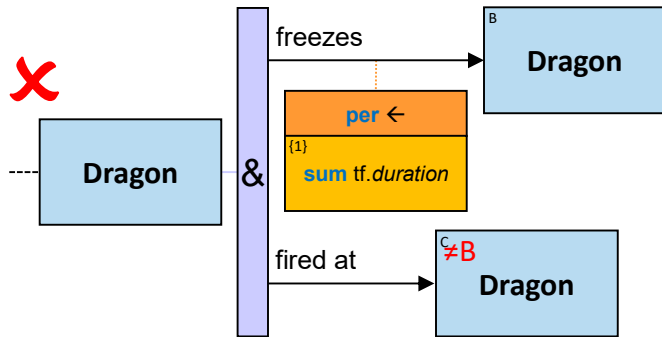

Since combiner entails identity - With relation to A: B is used both in an aggregative context and a non-aggregative context

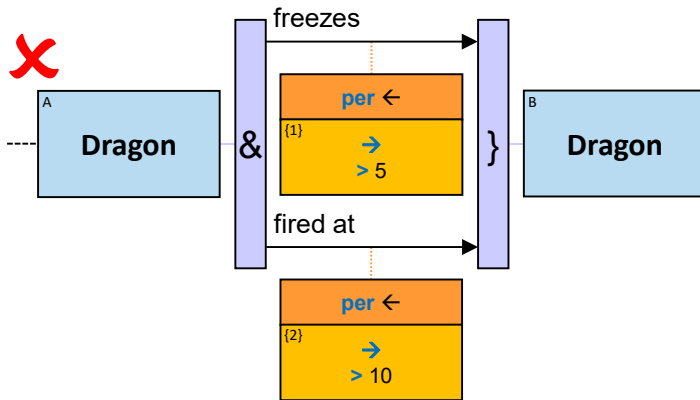

With relation to A: B is used in two different aggregative contexts

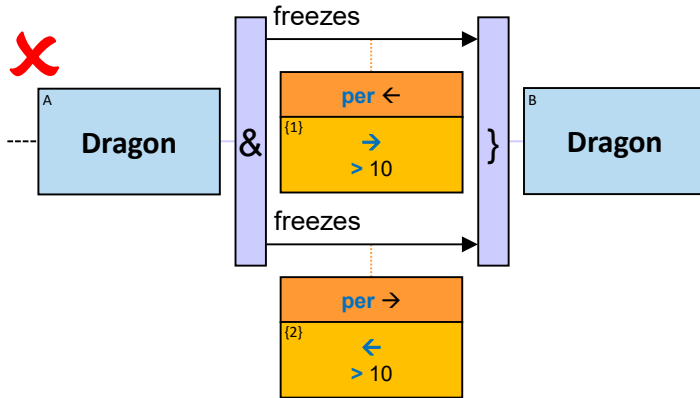

With relation to A: B is used both in an aggregative context (top branch) and a non-aggregative context (bottom branch). Similarly, with relation to B: A is used both in an aggregative context (bottom branch) and a non-aggregative context (top branch).

41 AGGREGATION RULES

**AR1:** Concrete entities / ensembles cannot be counted (L1, M1, M2, M3, M4 aggregation).

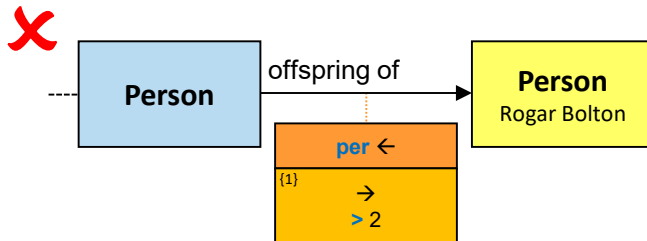

**AR2:** L1 aggregation must have a path to at least one typed/logical/untyped entity on its bottom part. The path must contain only relationships / paths / "All" quantifiers.

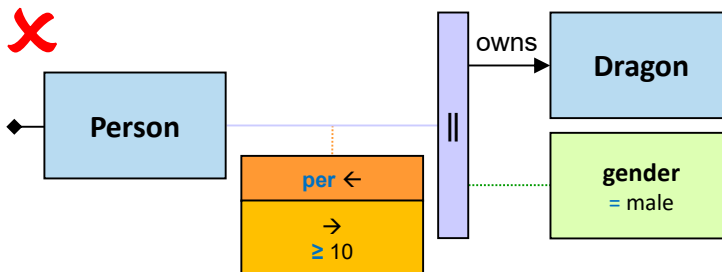
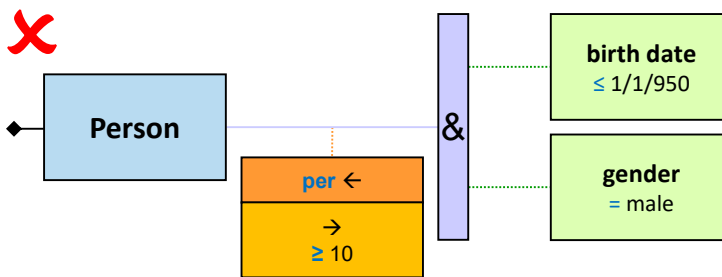

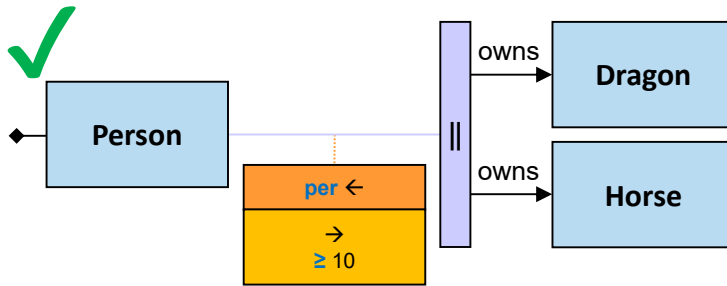

**AR3:** A tag defined right of an aggregator - cannot be used in the right-side on the aggregate constraint.

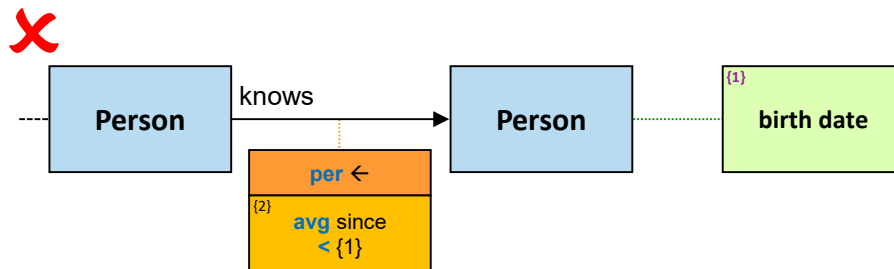

**AR4:** An aggregation tag cannot be referenced right of its definition.

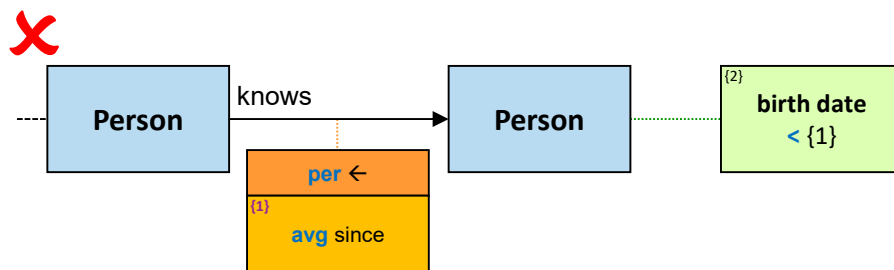

**AR5:** An expression/aggregation tag  $\{at\}$  defined *per*  $\{e = \dots\}$  cannot be aggregated (*aggop*  $\{at\}$ ) *per*  $\{e\}$  nor *per* a superset of  $\{e\}$ .

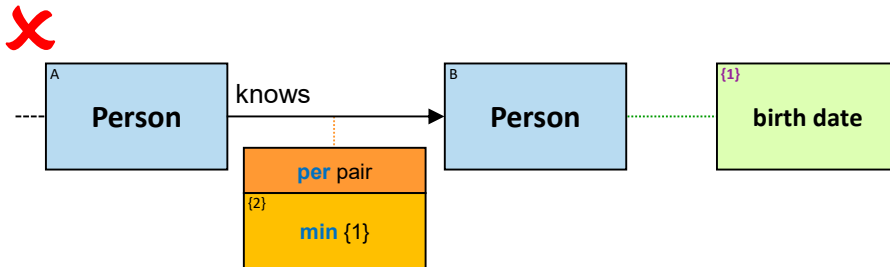

$\{1\}$  above is defined *per*  $\{B\}$  and hence can't be aggregated *per*  $\{A,B\}$

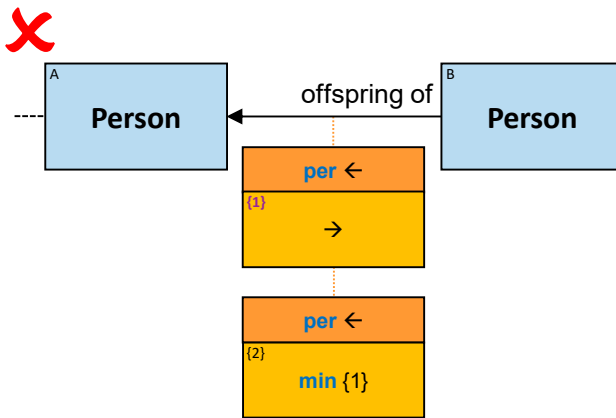

$\{1\}$  above is defined *per*  $\{A\}$  and hence can't be aggregated *per*  $\{A\}$

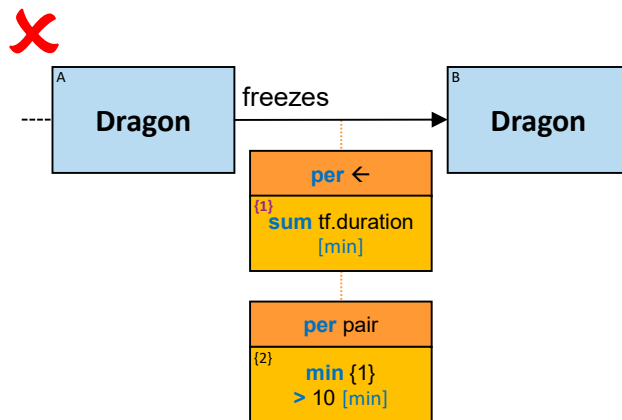

{1} above is defined *per {A}* and hence can't be aggregated *per {A, B}* (nor can it be aggregated *per {A}*).

## 42 SPLITS

Sometimes we need to split the set of all assignments to a pattern into groups ('splits') based on some split criteria, and then get:

- Only the splits for which some constraint holds (e.g. some L1/L2/L3/L4 aggregate constraint), or
- For each split: [all but] the  $k$  assignment combinations with the lowest/highest value (according to some M1/M2/M3/M4/R1 aggregation), or
- [all but] the  $k$  splits with the lowest/highest value of some aggregation result (see sections 48-51 – P1/P2/P3/P4 Min/Max Aggregation on Splits)

The split criteria can be:

- A relationship's expression, or
- An expression tag's value, or
- An aggregation tag's value, or
- A split tag's (of another split) value, or
- An entity type tag's value

Here are some examples:

- Any Dragon and the dragon it froze - on days it froze between one and five dragons (see Q217)

Here, all assignments to the pattern “*dragon froze dragon*” are first split into groups: a group per each day in which dragons were frozen. Then, for each group - the aggregate constraint “*any dragon that froze not more than five dragons*” is checked.

- For each color of dragons that Balerion froze - the three dragons it froze the largest number of times (see Q215)

Here, all assignments to the pattern “*Balerion froze dragon*” are first split into groups: a group per each color of frozen dragons. Then, for each group - the aggregate constraint “*the three dragons Balerion froze the largest number of times*” is checked.

A split appears below a query-start / relationship / path / quantifier-input. Below a split there are zero or more L1/L2/L3/L4/M1/M2/M3/M4/R1 aggregators. These aggregators are evaluated per split. S1/P1/P2/P3/P4 terminates the per-split scope in the chain. Splits may be nested (see Q154, Q327).



43 L1/L2/L3/L4 AGGREGATION PER SPLIT

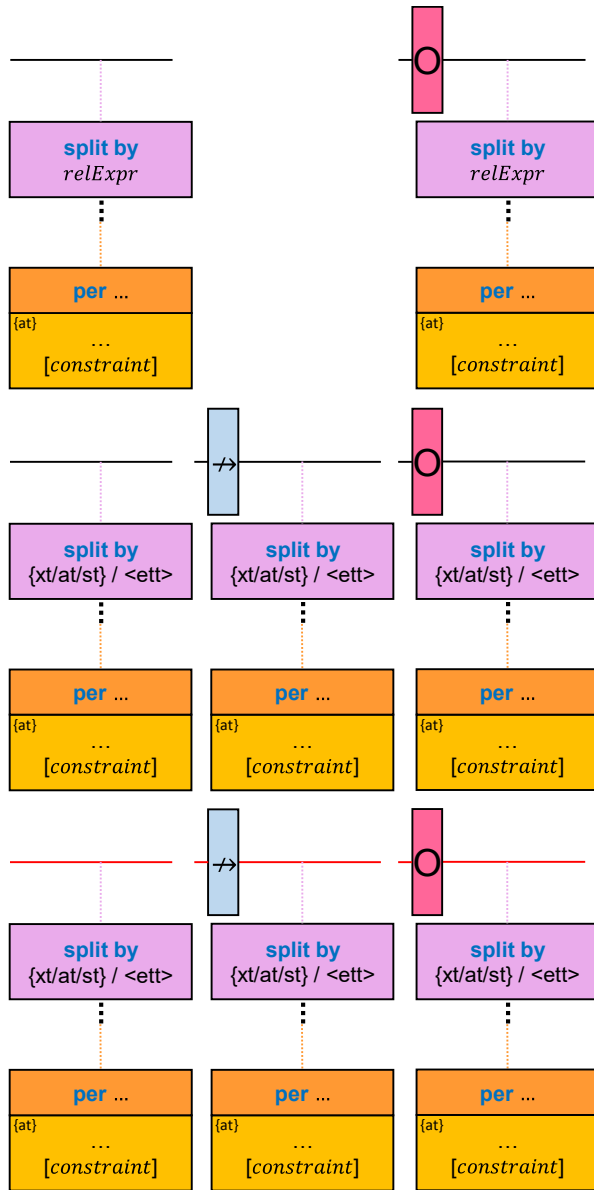

**Split by:**

- *relExpr* is an expression containing at least one property of the relationship below which the split appears.
- {xt}/{at}/{st}/<ett> is an expression tag / aggregation tag / split tag / entity type tag - defined on top of the aggregation or right of the aggregation

Any L1/L2/L3/L4 aggregation defined below a split (but not below an S1/P1/P2/P3/P4 - since they terminate the per-split scope in the chain) is calculated per split.

**Q115:** Any person who at a certain date became an owner of more than five horses (version 2)

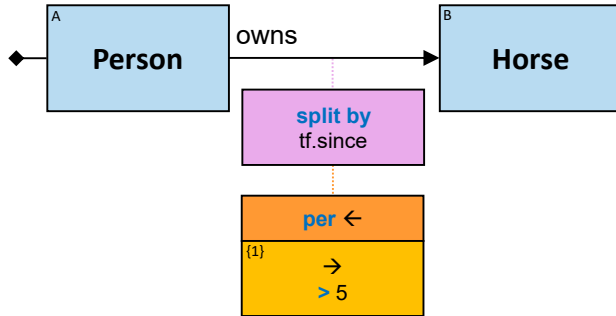

**Q217:** Any Dragon and the dragon it froze - on days it froze between one and five dragons

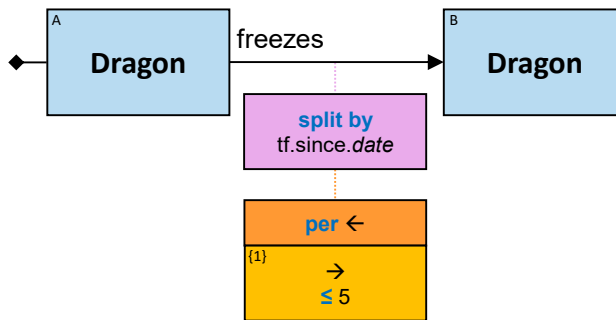

**Q218:** Any Person and the entities he owns - of types he owns at least five entities

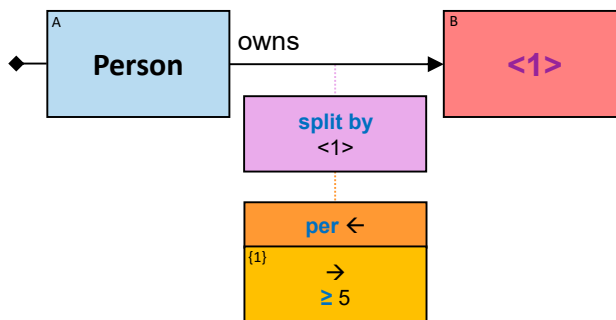

**Q219:** Any Person and all his horses - of colors he owns at least three horses

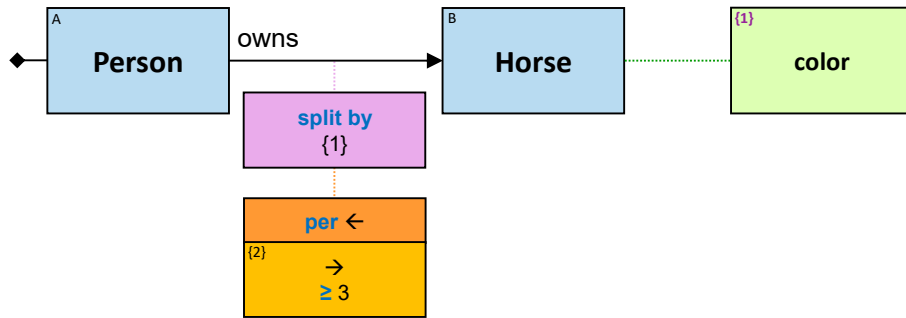

**Q28:** Any person that there are globally at least 500 horses with the same color as the color of some horse he owns

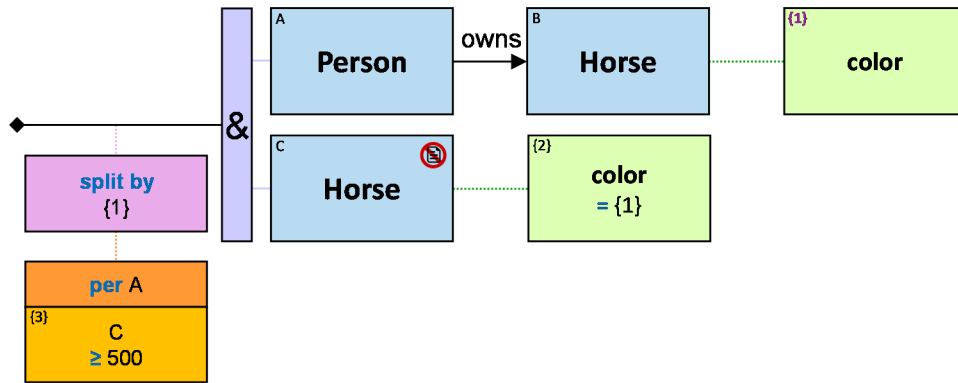

(Compare with Q27)

**Q321:** Any person that there are globally more horses than dragons with the same name length as that of a horse or a dragon he owns

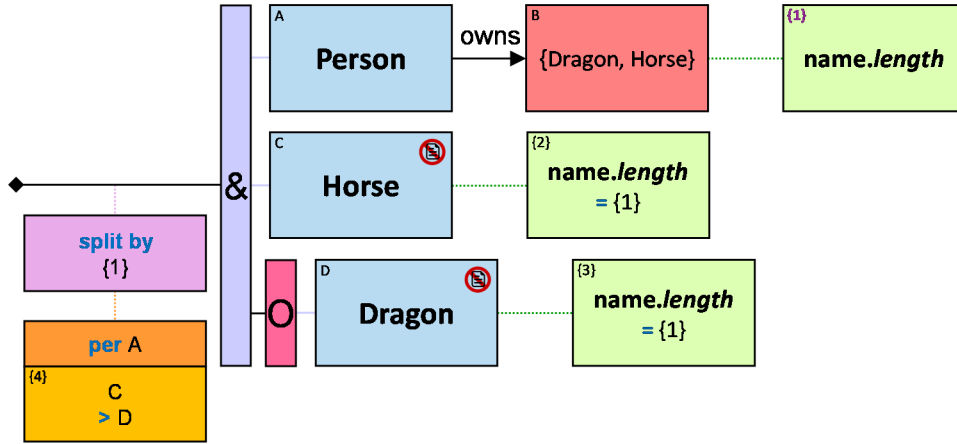

44 GLOBAL L1/L2/L3/L4 AGGREGATION PER SPLIT

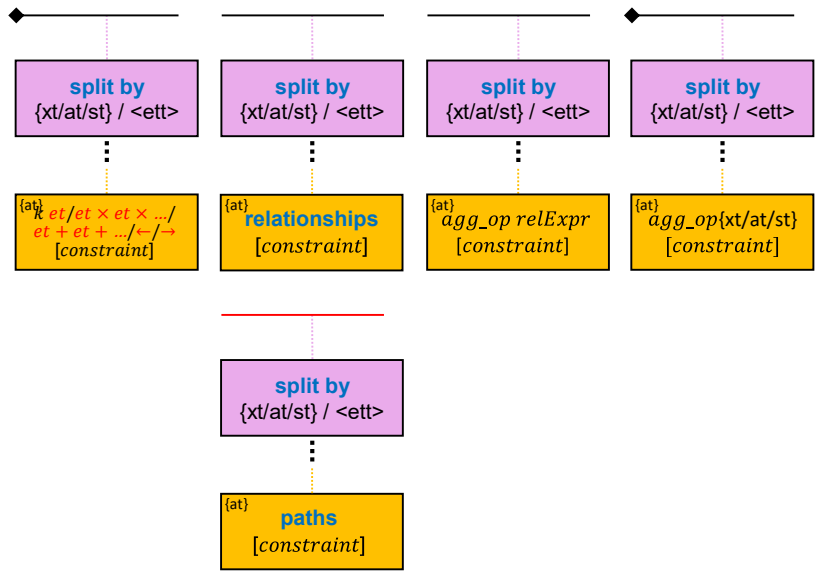

**Q261:** Any horse of any color of which there are at least 10 horses

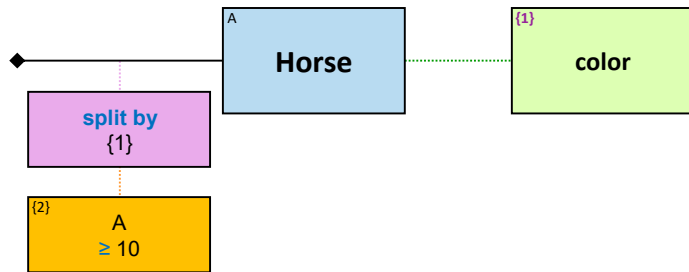

**Q270:** Any person and his horses - of the horse colors for which there are more than five horse ownerships by a person

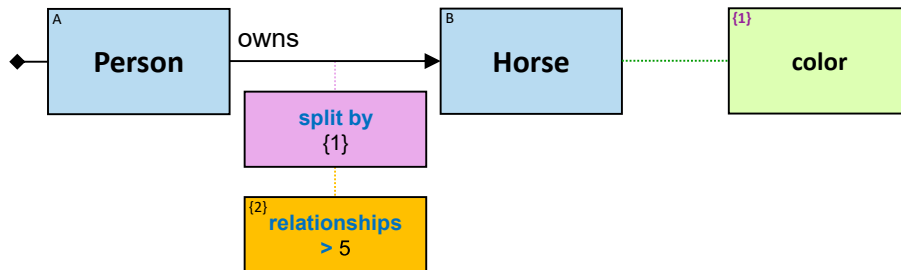

**Q271:** Any person and his horses - of the horse colors for which the average ownership start date is at least 1/1/1010

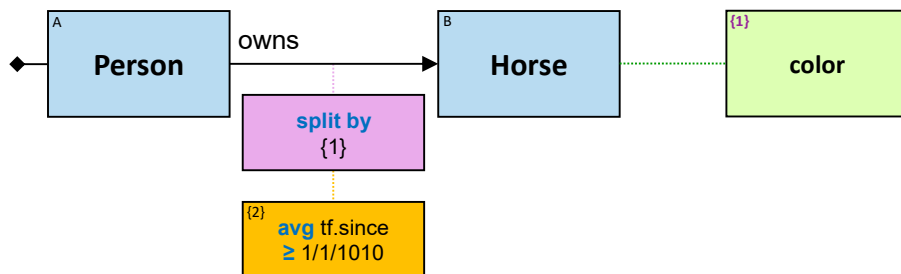

**Q263:** Any horse of each color of which the average horses' weight is greater than 450 Kg

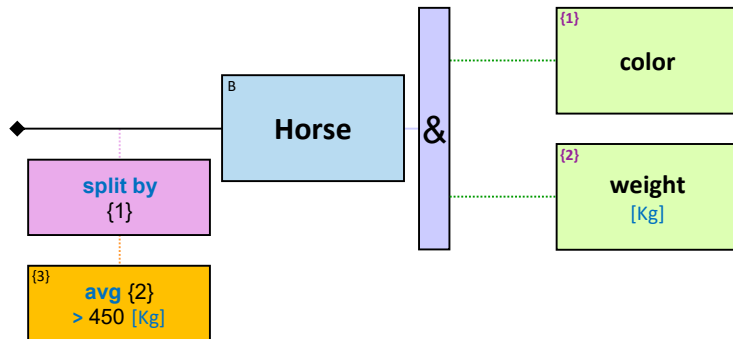

**Q265:** Any horse color of which the average horses' owners' height is at least 180 cm

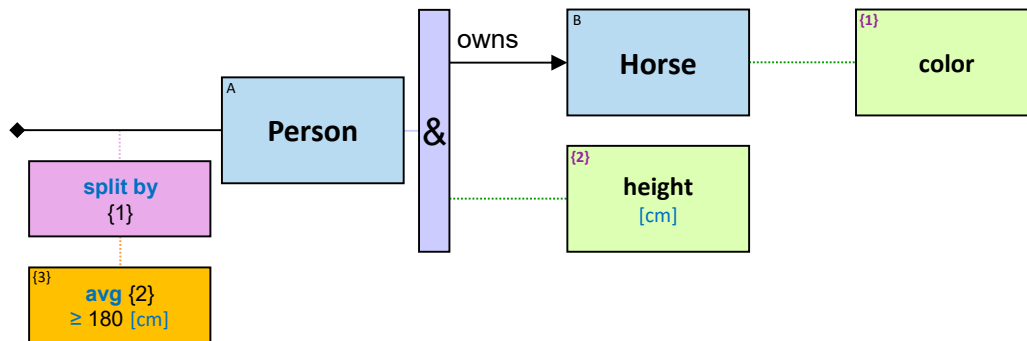

45 M1/M2/M3/M4/R1 AGGREGATION PER SPLIT

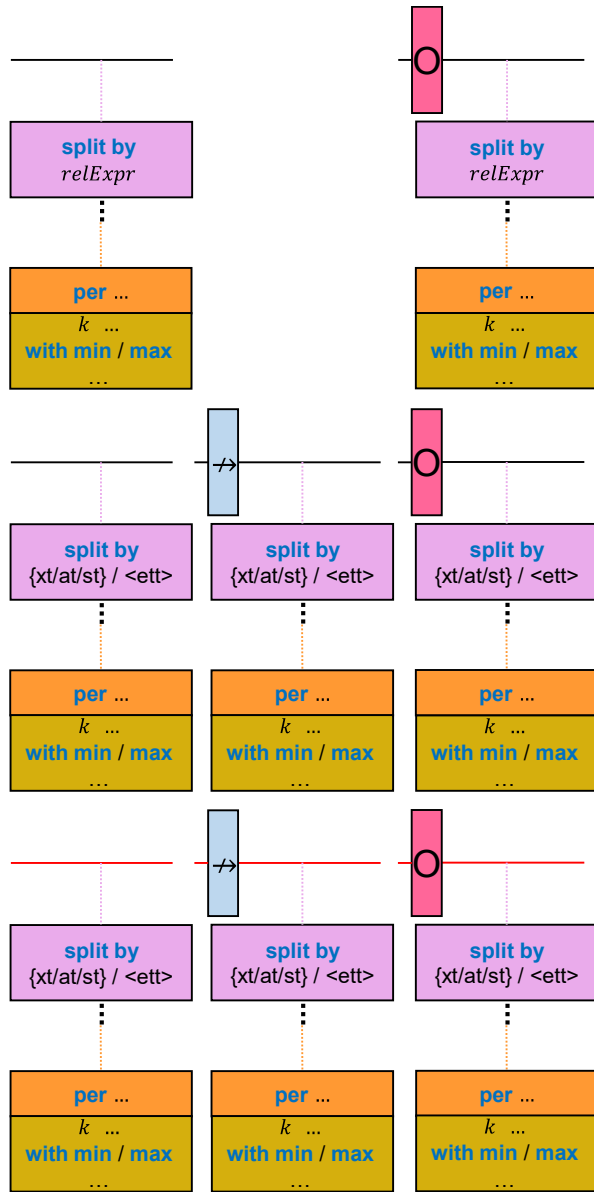

**Split by:**

- *relExpr* is an expression containing at least one property of the relationship below which the split appears.
- {xt}/{at}/{st}/<ett> is an expression tag / aggregation tag / split tag / entity type tag - defined on top of the aggregation or right of the aggregation

Any M1/M2/M3/M4/R1 aggregation defined below a split (but not below an S1/P1/P2/P3/P4 - since they terminate the per-split scope in the chain) is calculated per split.

**Q215:** For each color of dragons that Balerion froze - the three dragons it froze the largest number of times

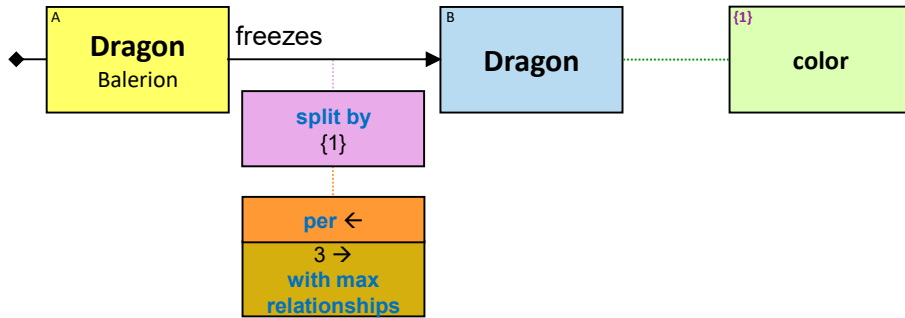

**Q253:** For each number of dragon's owners - the three dragons Balerion froze the largest number of times

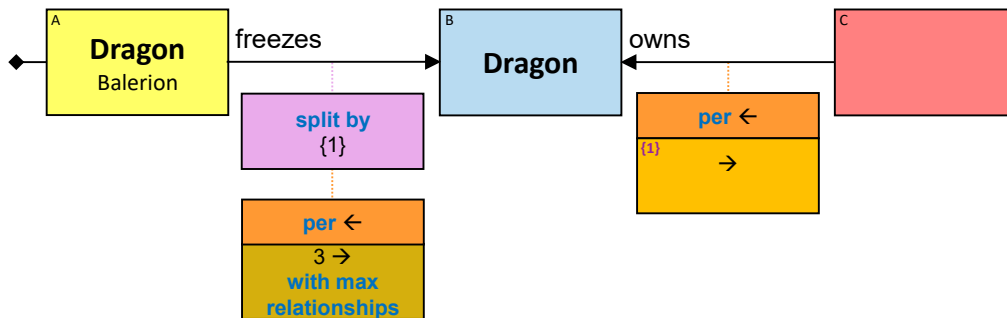

**Q273:** For each horse color - the three horse ownerships with the latest ownership start date

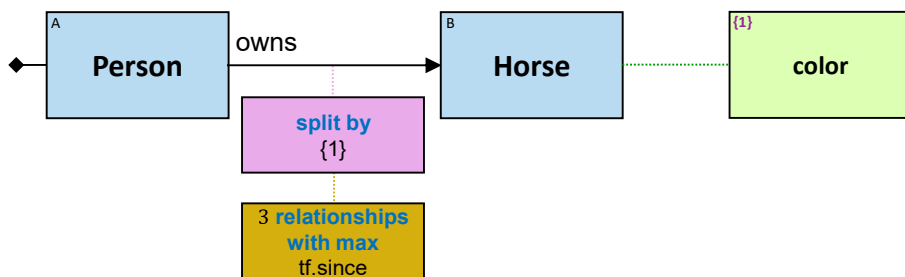



46 S1 AGGREGATION ON SPLITS

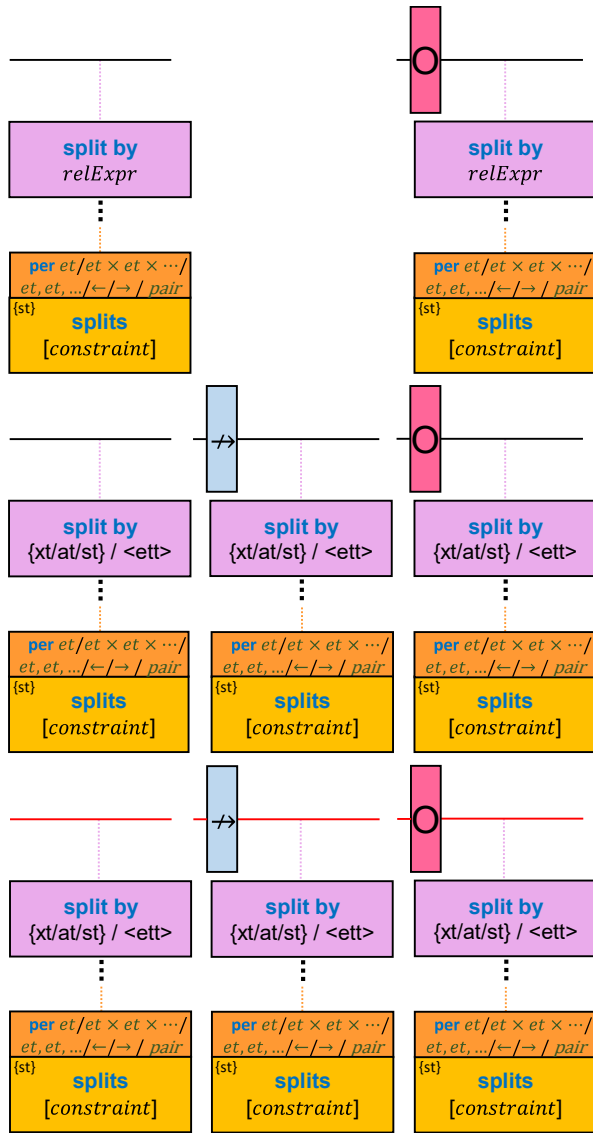

A constraint on the number of splits for which there is at least one assignment that satisfies the pattern - may appear below a split.

**Top part**

As explained for L1/L2/L3/L4 (see section 27 - Aggregation constraints and aggregation tags), with the following addition:

- The top part of S1 is optional. When not given -  $T[I]$  is empty,  $TA[I]$  is empty and  $S(I, I)$  is the set of all assignments in  $S$ .

**Bottom part:**

**Split tag** - ‘ $st$ ’ - Each ‘splits’ orange rectangle has a split tag on the top-left corner of its lower part, depicted by an index wrapped in curly brackets. The split tag’s value is calculated separately for each  $(m, n)$ . The indexing of expression tags, aggregation tags, and split tags is joint, and each tag is unique.

For each  $m$ ,  $st$  is a *calculated property* of the  $n^{\text{th}}$  unique assignment to  $T[m]$ .

Split tags may be used:

- as part of a parameter of a function applied to an expression tag
- as part of an expression tag’s constraint
- as part of a another split definition
- as part of a another split constraint (see Q159)
- as part of a min/max aggregation

If a split tag is used in any of these usages - it is depicted in bold purple. Otherwise - it is depicted in black.

- Optional: for each assignment combination to  $T$  entities: a **constraint** on  $st$  in one of these forms:
  - $= \text{expr} / \neq \text{expr} / > \text{expr} / \geq \text{expr} / < \text{expr} / \leq \text{expr}$
  - $\text{in} (\text{expr} .. \text{expr}) / \text{in} (\text{expr} .. \text{expr}] / \text{in} [\text{expr} .. \text{expr}) / \text{in} [\text{expr} .. \text{expr}]$
  - $\text{in} \{\text{expr}, \text{expr}, \dots \text{expr}\}$

‘ $\neq \text{expr}$ ’, ‘ $< \text{expr}$ ’ and ‘ $\leq \text{expr}$ ’ are satisfied only if  $st > 0$ .

If  $T$  is not given (see Q207):

***S1 is satisfied if the number of splits for which there is at least one assignment that satisfies the pattern - satisfies the constraint.***

If  $T$  is given:

***S1 filters assignment combinations to  $T$  entities - to only those combinations for which the number of splits for which there is at least one assignment that satisfies the pattern - satisfies the constraint.***

S1 may appear only in a per-split scope. S1 terminates the per-split scope in the chain (see Q306, Q154, Q156, Q235).

Notes:

- S1 may appear below a ‘split by *relExpr*’ which appears below a relationship. The relationship may be wrapped by an ‘O’
- S1 may appear below a ‘split by  $\{xt/at/st\}/<ett>$ ’ which appears below a query-start / relationship / path / quantifier-input. The relationship / path / quantifier may be wrapped by a ‘ $\rightarrow$ ’ or by an ‘O’

**Q153:** Any dragon A that in each of at least 11 days - froze between one and five dragons

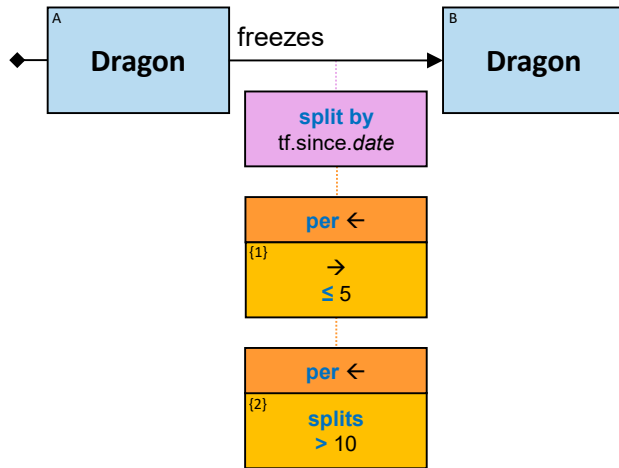

(Any A for which there are at least 10 splits - for each split there is at least one assignment that satisfies the pattern)

**Q252:** Any dragon B that in each of at least 11 days - was frozen by a dragon that on that day froze between one and five dragons

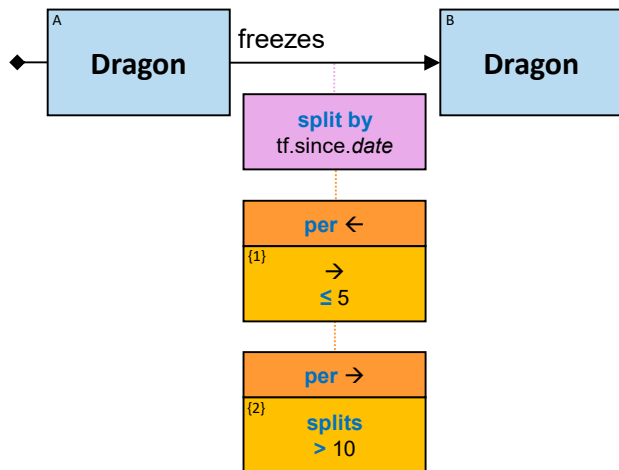

(Any B for which there are at least 10 splits - for each split there is at least one assignment that satisfies the pattern)

**Q278:** Any dragon pair (A, B) where in each of at least 11 days - A froze between one and five dragons, one of them is B

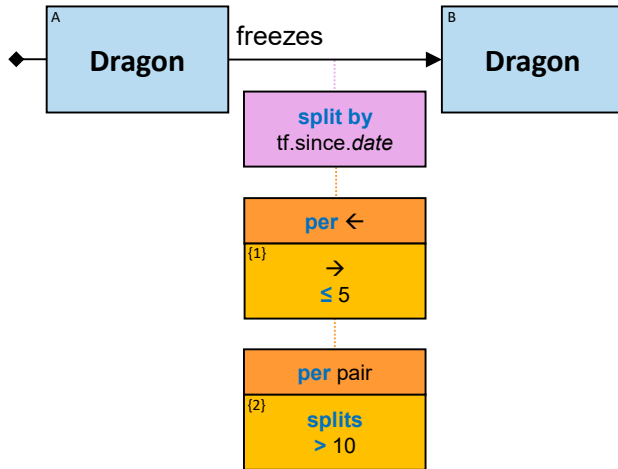

(Any pair (A, B) for which there are at least 10 splits - for each split there is at least one assignment that satisfies the pattern)

**Q306:** The three dragons that the number of days in each of which each froze at least five dragons - is maximal

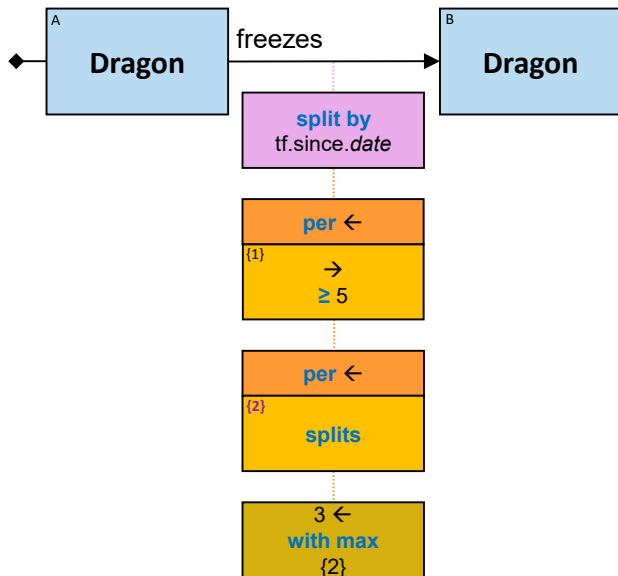

**Q214:** Any person who owns entities of at least four types. For each type - at least five entities

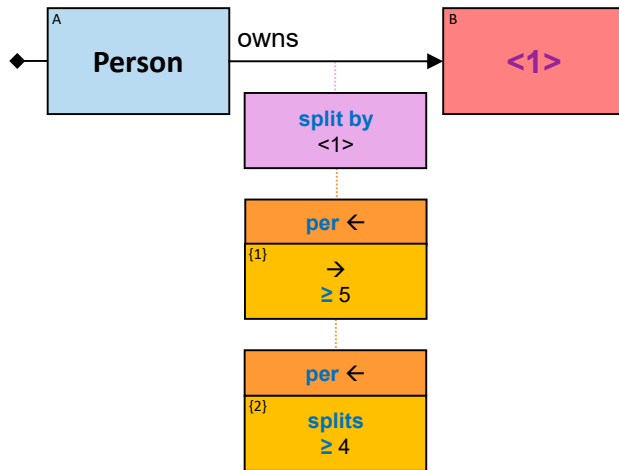

When several splits are chained, each split (each set of assignments) is split again, separately. A splits constraint terminates the innermost per-split scope in the chain.

**Q154:** Any dragon that in each of at least four years - in each of at least 11 days - froze between one and five dragons

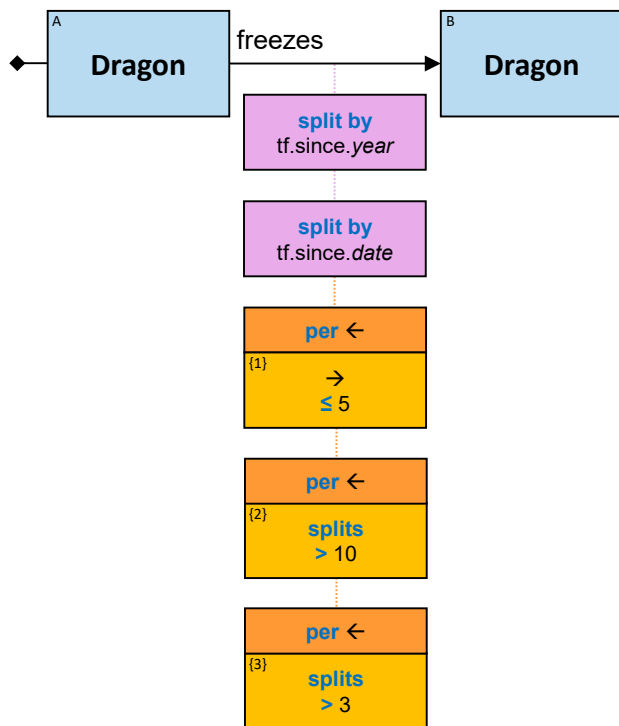

**Q155:** Any dragon that in each of at least 11 days - froze more than 100 minutes cumulatively

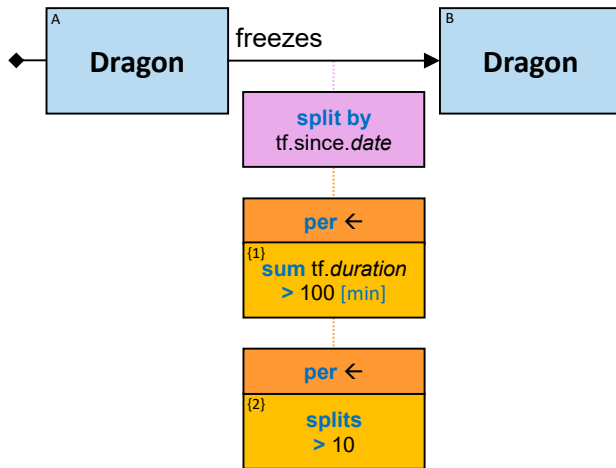

**Q157:** Any person who owns between one and three horses of the same color - for at least six colors

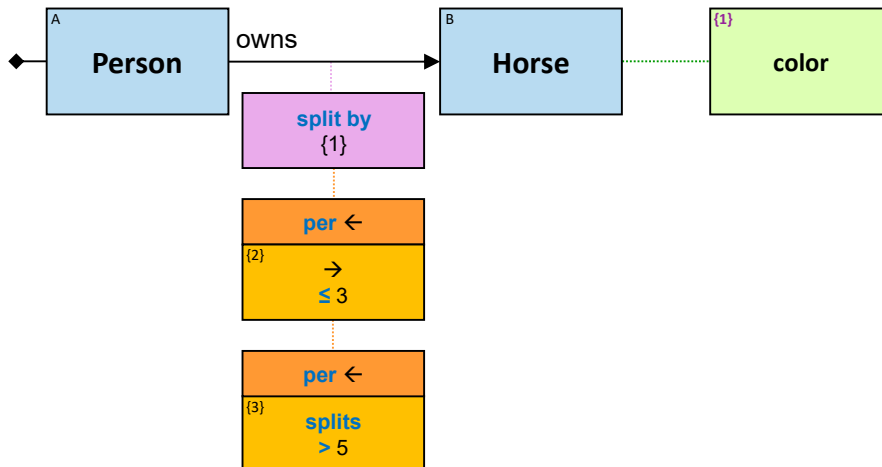

**Q156:** Any dragon that froze dragon for more than 1000 minutes cumulatively - in the days it froze dragons for more than 100 minutes

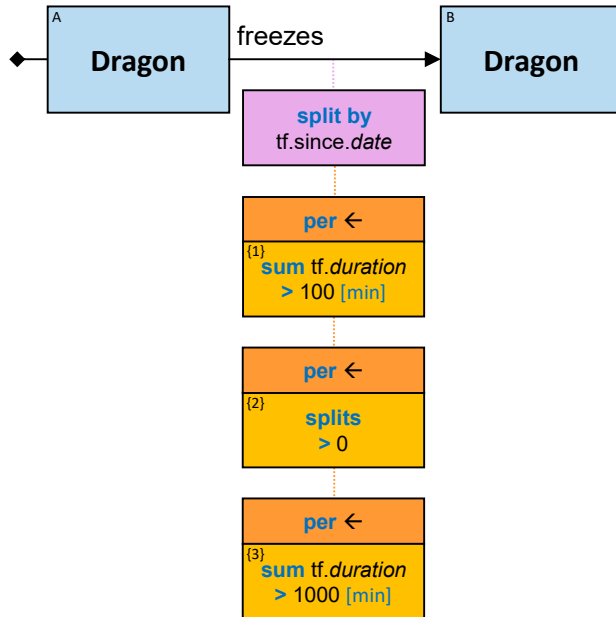

Note that {2} is used for terminating the per-split scope in the chain, and {3} is aggregated over all splits the passes the per-split constraint.

**Q235:** Any dragon that the number of dragons it froze on average - on months it froze dragons in - is at least 10

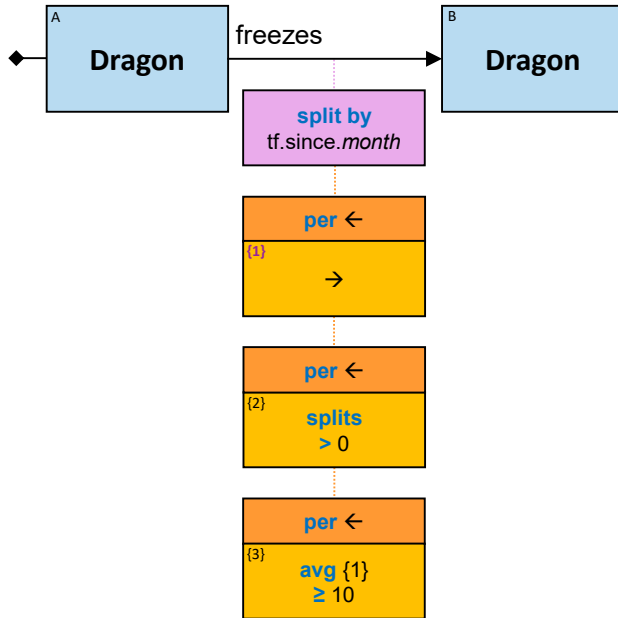

**Q254:** Any dragon that in each year it froze dragons - it froze more than three dragons

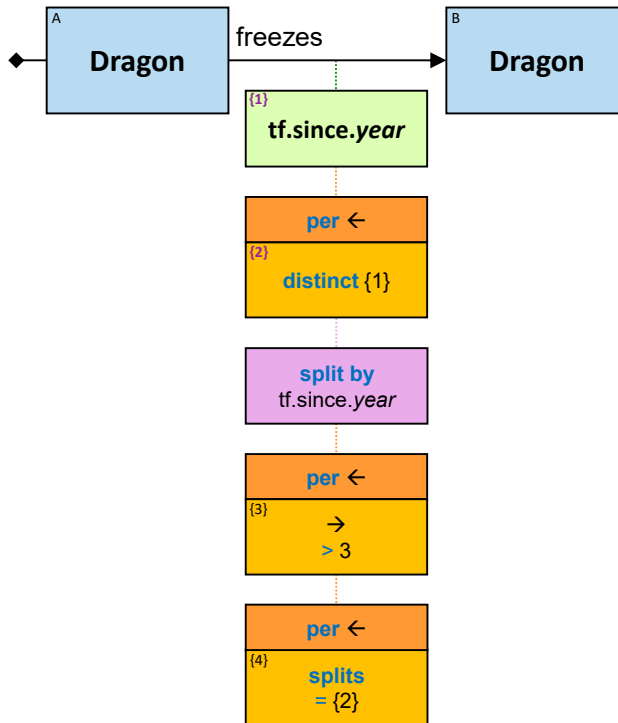



**Q255:** Any dragon that the number of days in which it froze more than 10 dragons - equals to the length of its name

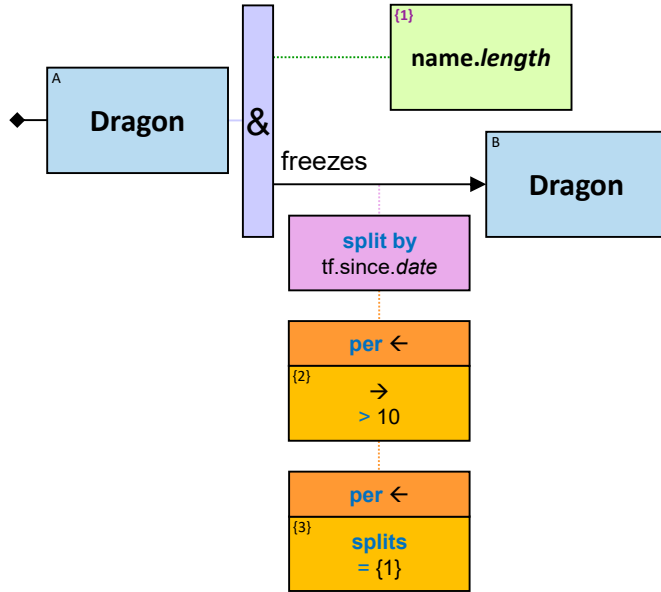

**Q159:** Any dragon for which there are more days where (it froze/was frozen at least five times, and the number of dragons it froze is greater than the number of dragons that froze it) than days where (it froze/was frozen at least five times, and the number of dragons that froze it is greater than the number of dragons it froze)

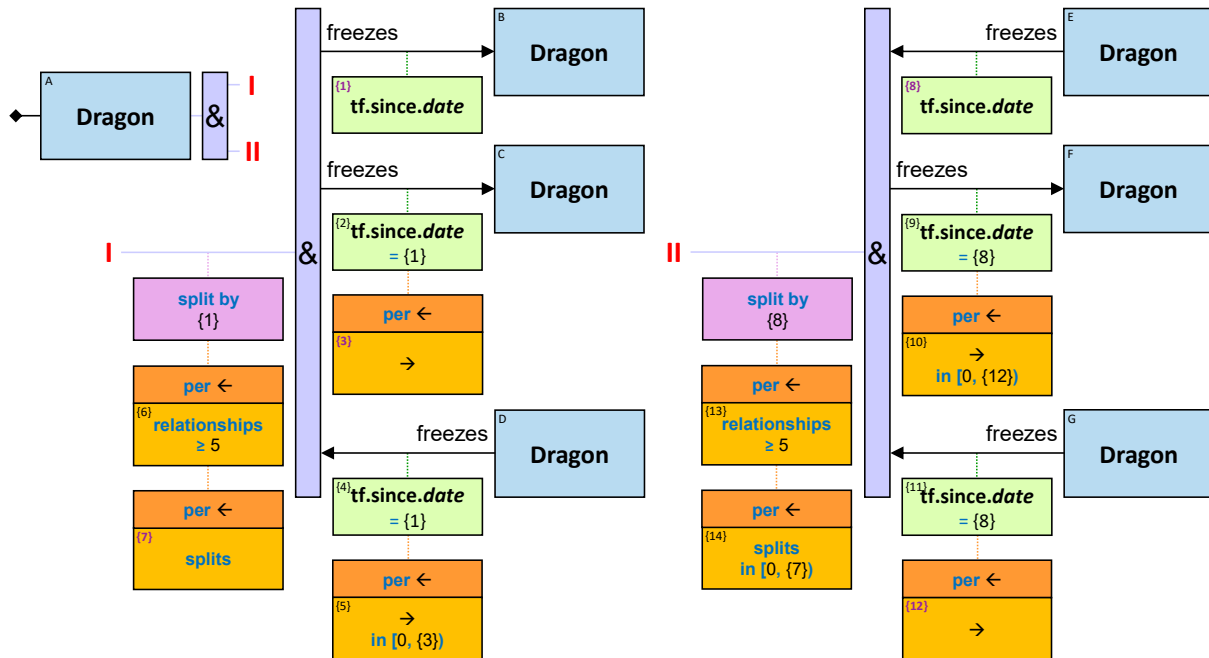

(Compare with Q260)

#### 47 MIN/MAX AGGREGATIONS ON SPLITS

Sometimes we need to limit splits, based on some value, to [all but] the  $k$  splits with the lowest/highest value. Here are some examples:

- Any horse of the three most common horse colors
- Any person and his horses - of the three horse colors with the smallest positive number of horse ownerships by a person
- Any person and his horses - of the three horse colors of which the average ownership start date is the latest
- Any person and his horses - of the three horse colors of which some person's horse ownership start date is the earliest

Min/Max aggregations on splits are used to limit the reported splits to [all but] the  $k$  splits with:

- the lowest/highest count of the number of assignment combinations to some entities, or
- the lowest/highest count of the number of assignments to a relationship / path, or
- the minimal/maximal value of some aggregation operation (e.g. min/max/sum) over the value of some property or some tag

#### **Top part**

As explained for L1/L2/L3/L4 (see section 27 - Aggregation constraints and aggregation tags), with the following addition:

- The top part of P1/P2/P3/P4 is optional. When not given -  $T[I]$  is empty,  $TA[I]$  is empty and  $S(I, I)$  is the set of all assignments in  $S$ .

P1/P2/P3/P4 may appear only in a per-split scope. P1/P2/P3/P4 terminates the per-split scope in the chain.

48 P1 MIN/MAX AGGREGATION ON SPLITS

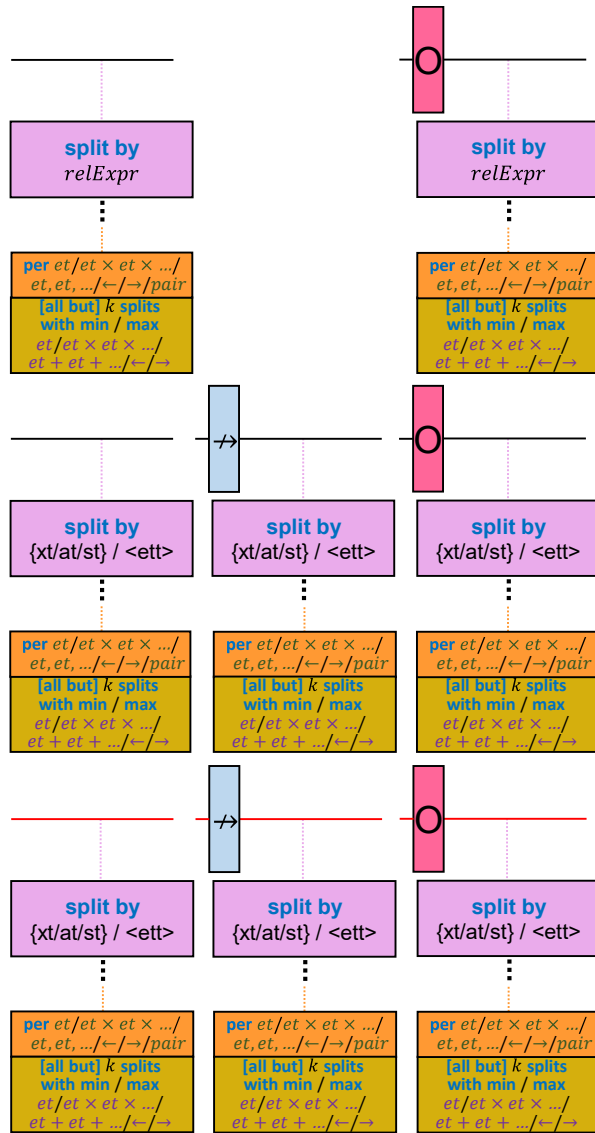

Let  $M$  denote a list where each element holds an entity tag ( $et$ ) or a Cartesian product of entity tags ( $et1 \times et2 \times \dots$ ).

**Bottom part:**

- $k$ : positive integer
- optional: “all but”
- One of the following:

- min
- max
- One of the following formats (with *min/max ...*):
  - ‘*et*’: *M* contains a single element:  $M[1] = et$
  - ‘ $\leftarrow$ ’: *M* contains a single element:  $M[1] = \text{entity-tag directly left of the aggregation}$
  - ‘ $et1 \times et2 \times \dots$ ’: *M* contains a single element:  $M[1] = et1 \times et2 \times \dots$
  - ‘ $et1 + et2 + \dots$ ’:  $M = [et1, et2, \dots]$
  - ‘ $\rightarrow$ ’: *M* contains all the entity tags directly right of the aggregation (similar to ‘ $et1 + et2 + \dots$ ’)

If *T* is not given:

**P1 limits the splits - to [all but] the *k* splits with the minimal / maximal positive number of assignment combinations of entities *B*.**

If *T* is given:

**For each assignment combination to entities *T* - P1 limits the splits - to [all but] the *k* splits with the minimal / maximal positive number of assignment combinations of entities *B*.**

Notes:

- *T* and *B* may not intersect
- P1 may appear below a ‘split by *relExpr*’ which appears below a relationship. The relationship may be wrapped by an ‘O’
- P1 may appear below a ‘split by  $\{xt/at/st\} < ett >$ ’ which appears below a query-start / relationship / path / quantifier-input. The relationship / path / quantifier may be wrapped by a ‘ $\rightarrow$ ’ or by an ‘O’
- Suppose the bottom part is “5 ... with max ...” but there are only three splits - Only those three will be reported.
- Suppose the bottom part is “5 ... with max ...” but there are 10 splits with equal maximum - Still only five will be reported.

**Q262:** Any horse of the three most common horse colors

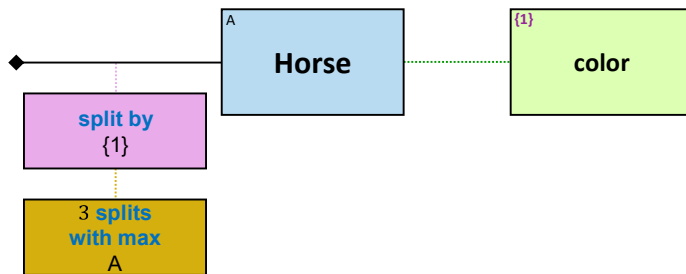

**Q224:** Any person and his horses - of the three horse colors with the smallest positive number of horse owners (two versions)

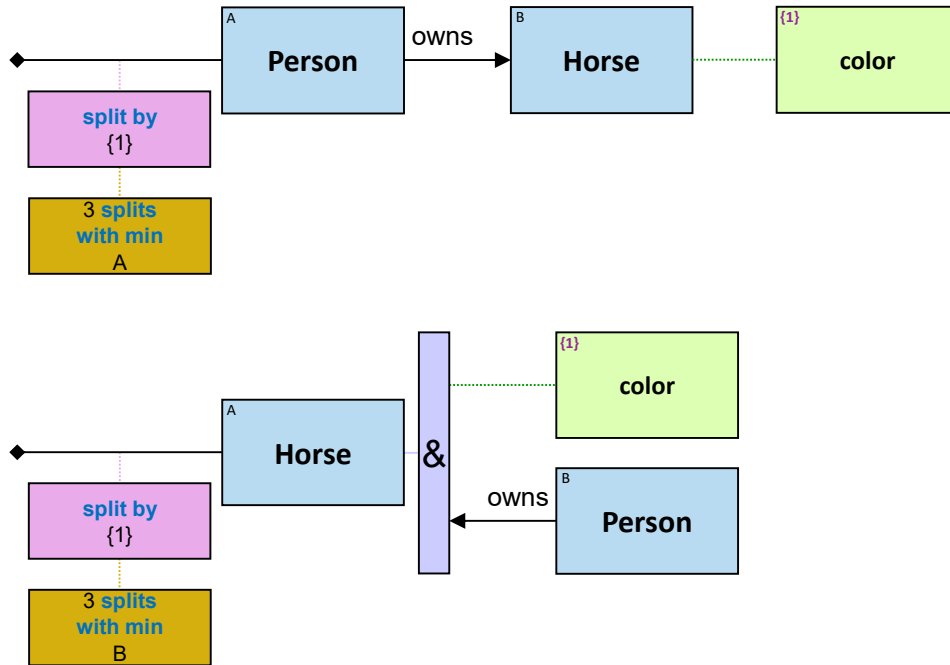

**Q325:** For each of the three most common horse colors: the three people that owns the largest number of horses of this color

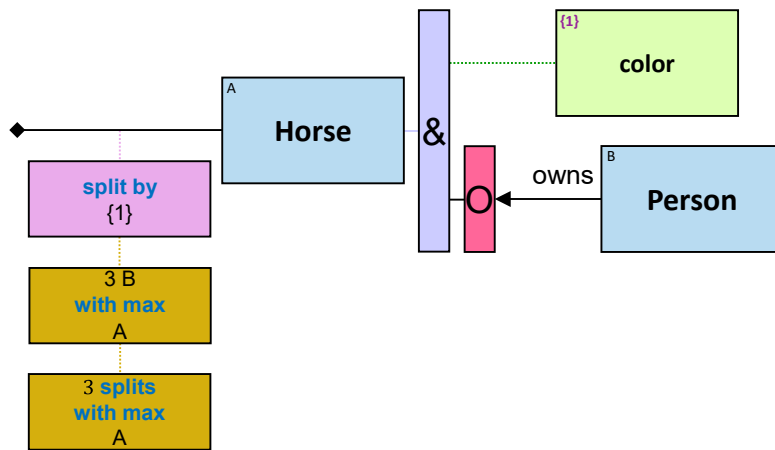

**Q326:** For the three most common horse colors (combined): the three people that owns the largest number of horses of these colors

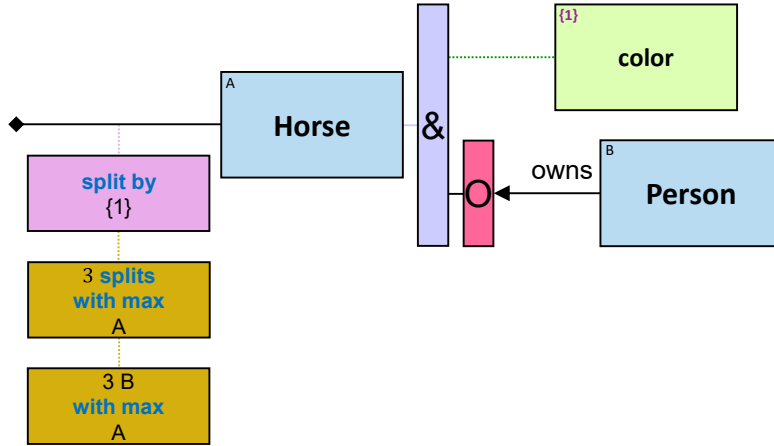

**Q220:** Any person and his horses - of the three colors he owns the largest number of horses

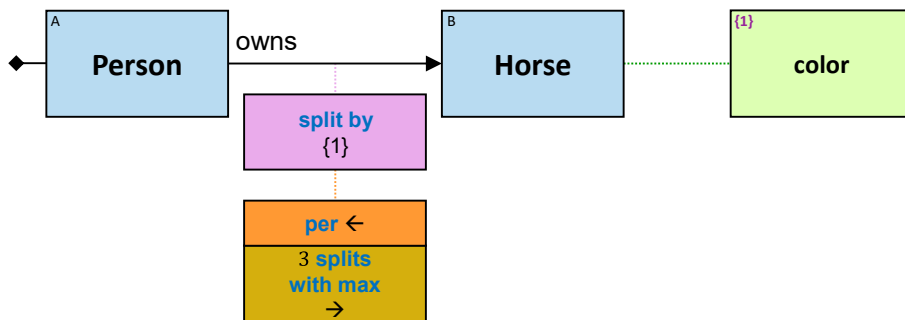

49 P2 MIN/MAX AGGREGATION ON SPLITS

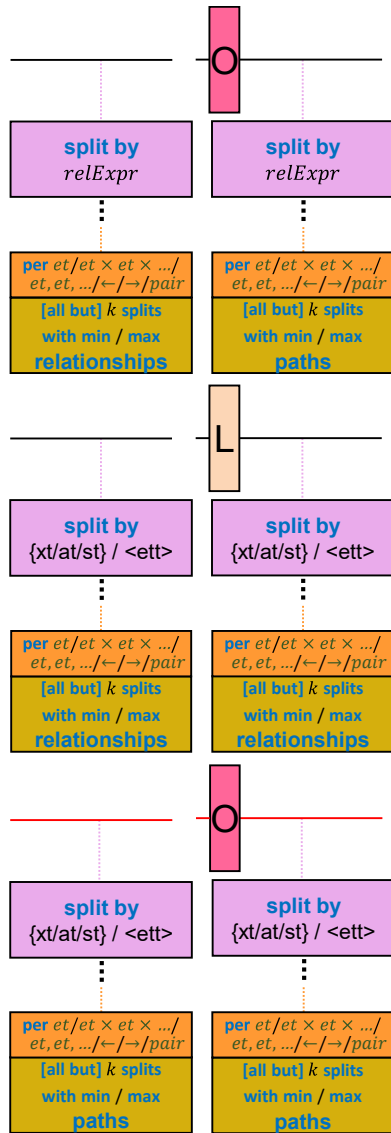

Bottom part:

- $k$ : positive integer
- optional: "all but"

If  $T$  is not given:

**P2 limits the splits - to [all but] the  $k$  splits with the minimal / maximal positive number of relationships / paths on its top.**

If  $T$  is given:

**For each assignment combination to entities  $T$  - P2 limits the splits - to [all but] the  $k$  splits with the minimal / maximal positive number of relationships / paths on its top.**

Notes:

- P2 may appear below a ‘split by  $relExpr$ ’ which appears below a relationship. The relationship may be wrapped by an ‘O’
- P2 may appear below a ‘split by  $\{xt/at/st\}/<ett>$ ’ which appears below a relationship / path / quantifier-input. The relationship / path / quantifier may be wrapped by an ‘O’
- Suppose the bottom part is “5 ... with max ...” but there are only three splits - Only those three will be reported.
- Suppose the bottom part is “5 ... with max ...” but there are 10 splits with equal maximum - Still only five will be reported.

*Q225: Any person and his horses - of the three horse colors with the smallest positive number of horse ownerships by a person*

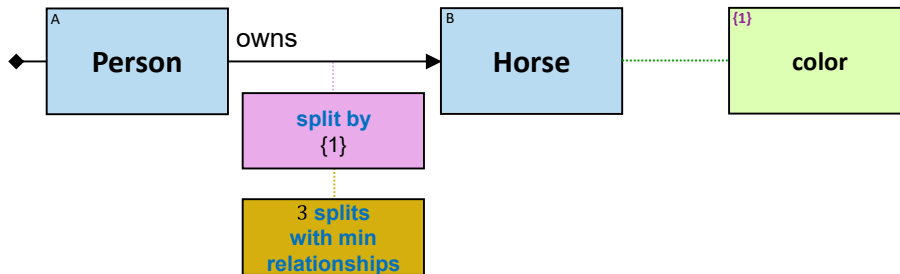

*Q281: Any dragon and the dragons it froze - of the three colors of which dragons were frozen the largest number of times*

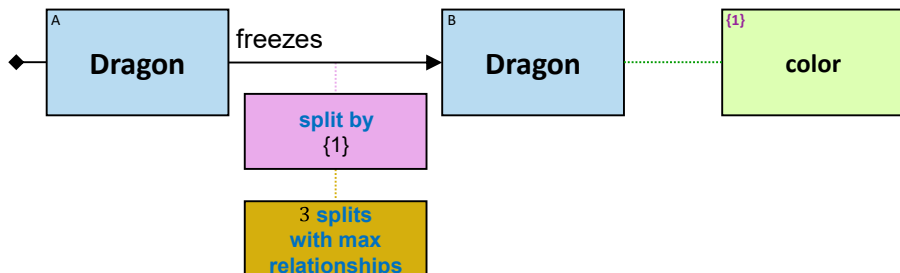



**Q319:** Any dragon and the dragons it froze - of the 4<sup>th</sup>-6<sup>th</sup> colors of which dragons were frozen the largest number of times (two versions)

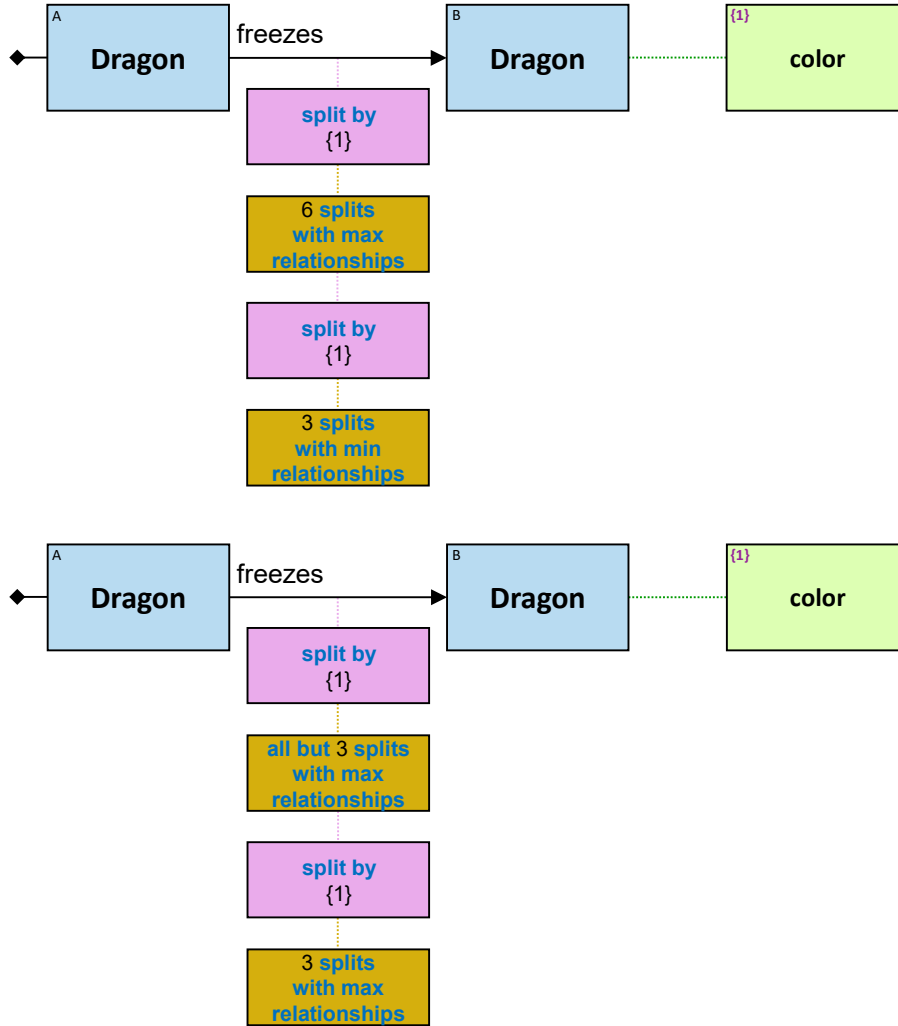

**Q282:** Balerion and the dragons it froze - of the three colors of which dragons were frozen the largest number of times

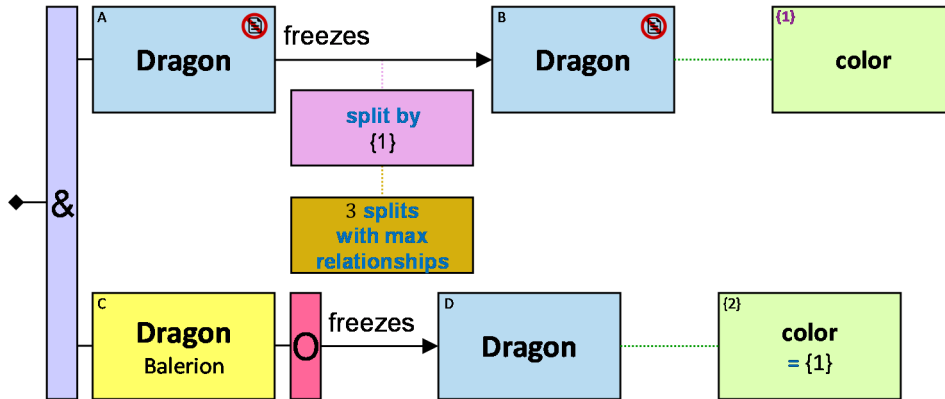

**Q221:** Balerion and the dragons it froze - of the three colors it froze dragons the largest number of times

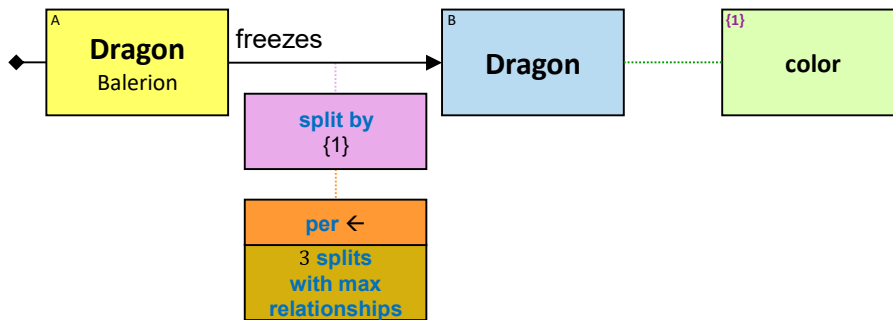

**Q280:** Any dragon and the dragons it froze - of the three colors it froze dragons the largest number of times

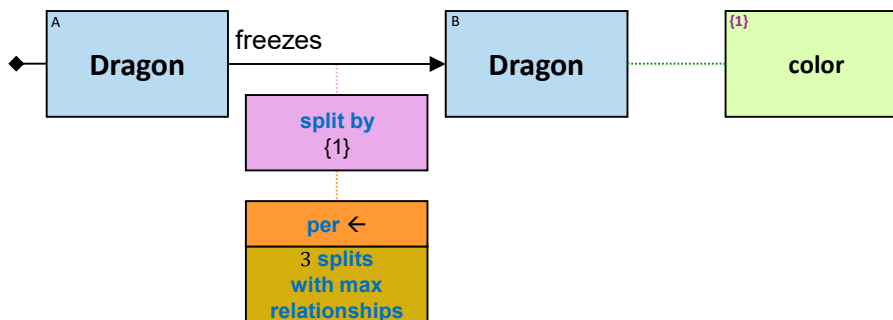

50 P3 MIN/MAX AGGREGATION ON SPLITS

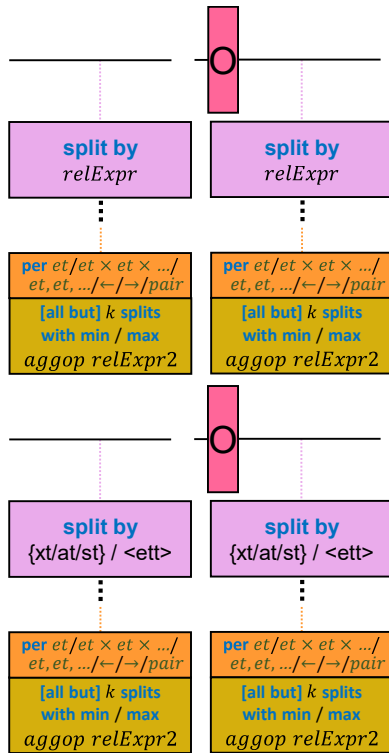

**Bottom part:**

Let  $R$  denote the relationship P3 appears below it.

- $k$ : positive integer
- optional: “all but”
- *aggop* is *min/max/avg/sum* - for aggregating values of an ordinal expression, or *distinct/list/set* - for aggregating values of any expression. *distinct* returns the number of distinct values; *list* and *set* return a list/set of all the values. Empty values are not aggregated.
- *relExpr2* is an expression containing at least one property of  $R$  (different from *relExpr*)

If  $T$  is not given:

**P3 limits the splits - to [all but] the  $k$  splits with the minimal / maximal value of *aggop(relExpr)* of the assignments to the relationship on its top.**

If  $T$  is given:

For each assignment combination to entities  $T$  - P3 limits the splits - to [all but] the  $k$  splits with the minimal / maximal value of  $aggop(relExpr)$  of the assignments to the relationship on its top.

Notes:

- P3 may appear below a 'split by  $relExpr$ ' which appears below a relationship. The relationship may be wrapped by an 'O'
- P3 may appear below a 'split by  $\{xt/at/st\}/<ett>$ ' which appears below a relationship. The relationship may be wrapped by an 'O'
- Suppose the bottom part is "5 ... with max ..." but there are only three splits - Only those three will be reported.
- Suppose the bottom part is "5 ... with max ..." but there are 10 splits with equal maximum - Still only five will be reported.

**Q269:** Any person and his horses - of the three horse colors of which the average ownership start date is the latest

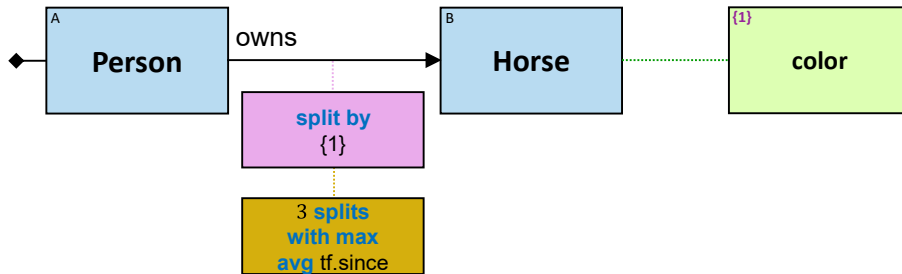

**Q222:** Any Person, and his horses - of the three colors for which his average ownership start date is the latest

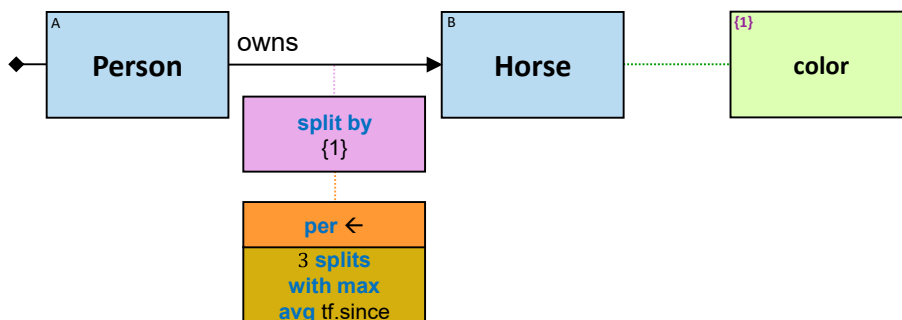

51 P4 MIN/MAX AGGREGATION ON SPLITS

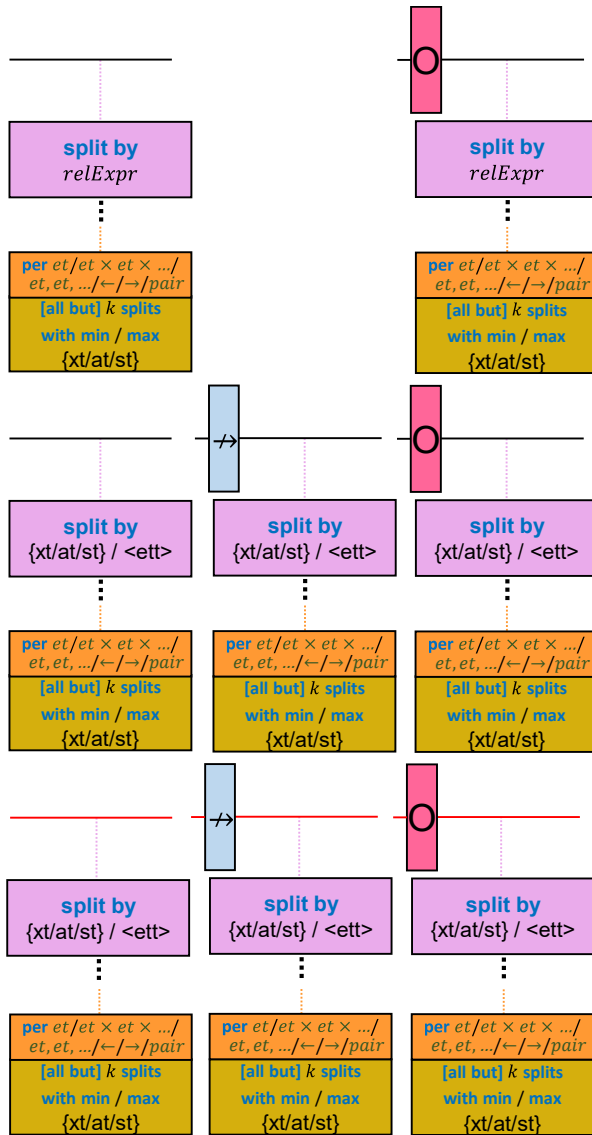

**Bottom part:**

- *k*: positive integer
- optional: "all but"
- {*xt*} is an expression tag with an ordinal type - defined on top of the aggregation (see Q276) or right of the aggregation (see Q275)
- {*at*}/{*st*} is an aggregation tag / split tag - defined on top of the aggregation (see Q264, Q226, Q223) or right of the aggregation

If  $T$  is not given:

**P4 limits the splits - to [all but] the  $k$  splits with the minimal / maximal value of  $\{xt\}/\{at\}/\{st\}$ .**

If  $T$  is given:

**For each assignment combination to entities  $T$  - P4 limits the splits - to [all but] the  $k$  splits with the minimal / maximal value of  $\{xt\}/\{at\}/\{st\}$ .**

Notes:

- P4 may appear below a ‘split by  $relExpr$ ’ which appears below a relationship. The relationship may be wrapped by an ‘O’
- P4 may appear below a ‘split by  $\{xt/at/st\}/<ett>$ ’ which appears below a query-start / relationship / path / quantifier-input. The relationship / path / quantifier may be wrapped by a ‘ $\rightarrow$ ’ or by an ‘O’
- Suppose the bottom part is “5 ... with max ...” but there are only three splits - Only those three will be reported.
- Suppose the bottom part is “5 ... with max ...” but there are 10 splits with equal maximum - Still only five will be reported.

**Q276:** Any person and his horses - of the three horse colors of which some person’s horse ownership start date is the earliest

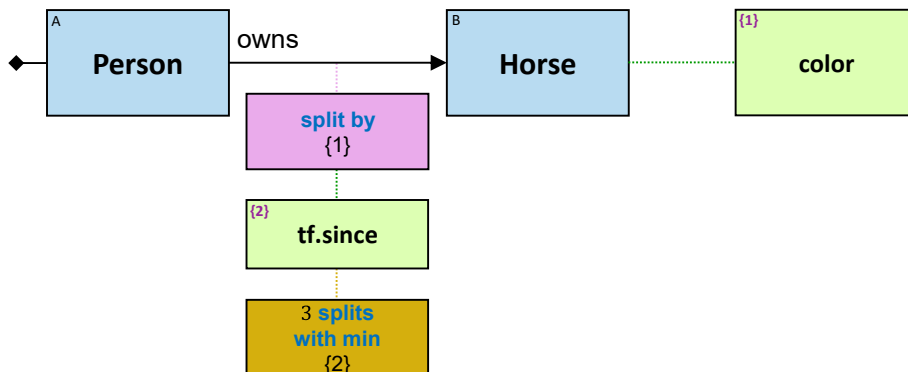

Even if the three horses with the earliest ownership start date are of the same color, we would still get all people and their horses of two more colors (of the next-earliest ownership start dates)

**Q264:** Any horse of the three colors of which the average horses' weight is maximal

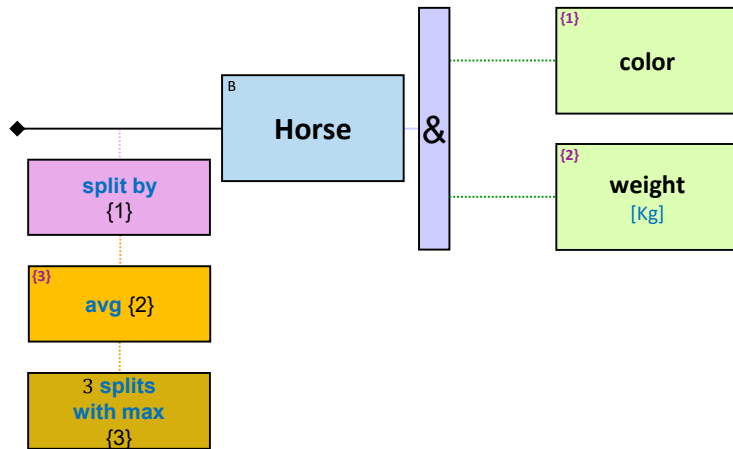

**Q226:** Any person and his horses - of the three horse colors of which the average height of the horse owners is minimal

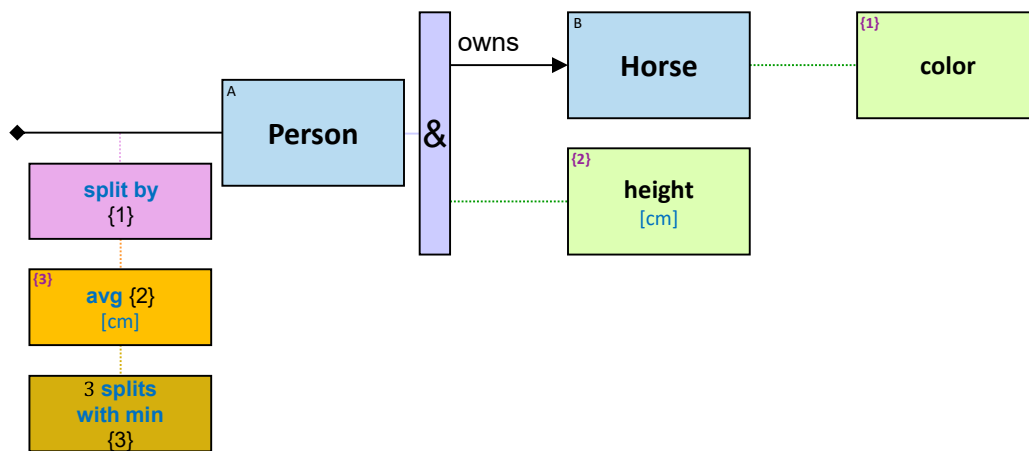

**Q216:** Any dragon that Balerion froze in the three 30-day timeframes in which it froze dragons the largest number of times

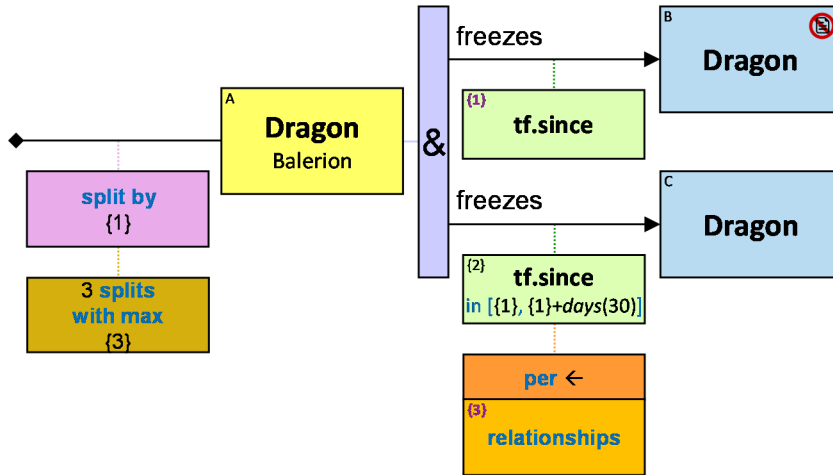

**Q275:** Any person and his horses - of the three horse colors of which he owns the heaviest horse

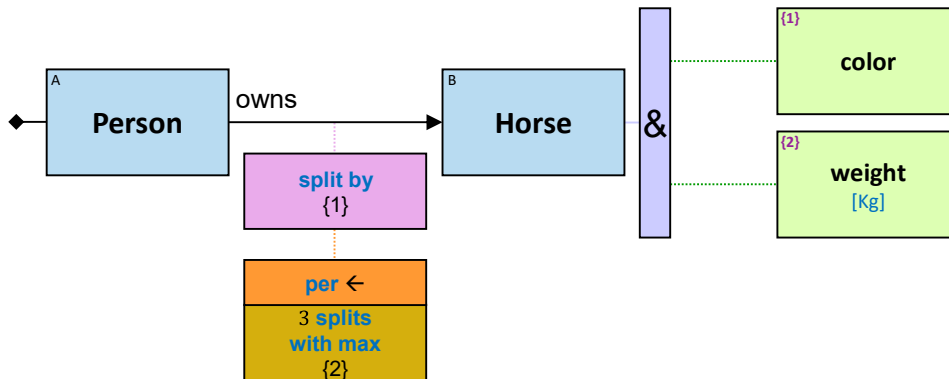

Even if a person's three heaviest horses are of the same color, we would still get all his horses for two more colors (those with the next heaviest horses)



**Q223:** Any Person, and his horses - of the three colors for which the cumulative weight of his horses in the largest

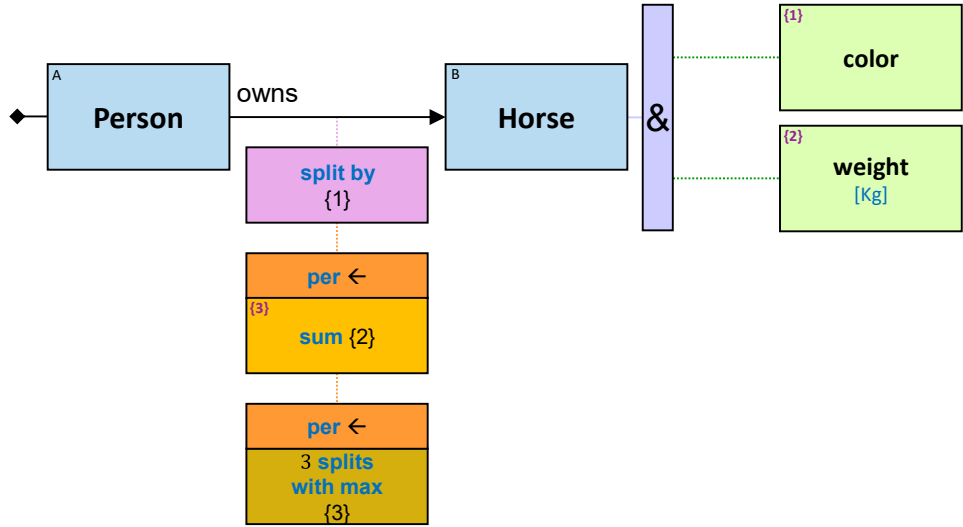

52 MULTIVALUED PROPERTIES

A single property may contain multiple (zero or more) values of the same type.

For example, a person may have multiple nicknames, each is a string. 'nicknames' property would be of data type 'set of strings', denoted as '{string}'. In general, the type {t} denotes a set of values - each of type t. the values in a set are unordered, and duplicate values are not allowed.

As another example, a polygon is composed of multiple geopoints, each has latitude and longitude sub-properties. 'polygon' property would be of a data type 'list of geopoints', denoted as '[geopoint]'. In general, the type [t] denotes a list of values - each of type t. The values in a list are ordered, and duplicate values are allowed.

Both {t} and [t] are called multivalued data types.

**Q307:** Any person that has a nickname that contains 'a'

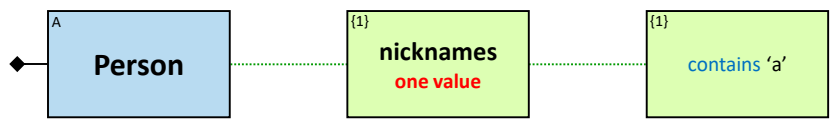

'one value' represents a single value of a multivalued property. Hence, expression tag {1} represent one nickname. A green 'one value' rectangle where the multivalued property has at least one value - is always satisfied. A green 'one value' rectangle where the multivalued property has zero values - is not satisfied.

Constraints on the value of {1} are chained right to its definition. The right green rectangle has the same expression tag, as it refers to the same nickname. Green rectangles chained to a 'one value' rectangle do not repeat the multivalued property name.

**Q308:** Any person that has a nickname that contains both 'a' and 'b'

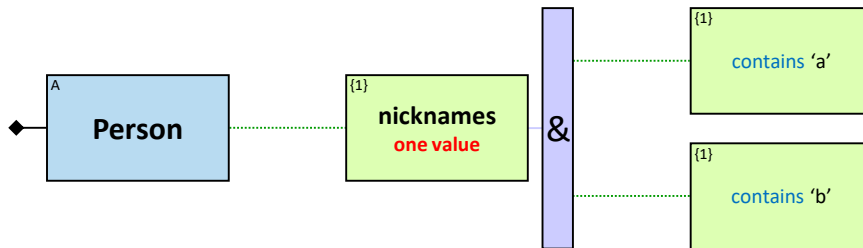

**Q309:** Any person that has at least two nicknames (two versions)



The *count* function return the number of values a multivalued property contains.

Aggregate constraints can be defined over the number of values of a multivalued property:

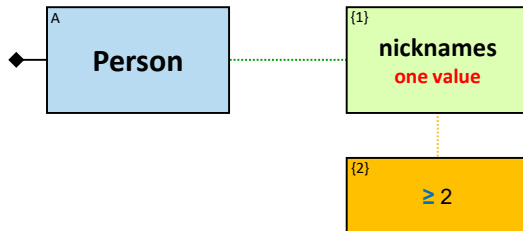

The orange rectangle does not have a top part, and its bottom part contains only a constraint.

Aggregate constraints can be defined over the number of values of a multivalued property that satisfy some constraint:

**Q310:** Any person that has at least two nicknames - each contains 'a'

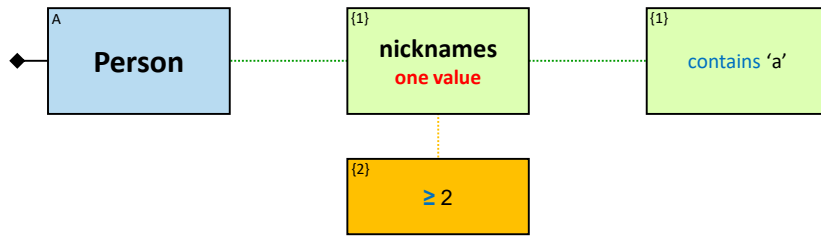

**Q311:** Any person that has at least five nicknames - each contains either 'a' or 'b'

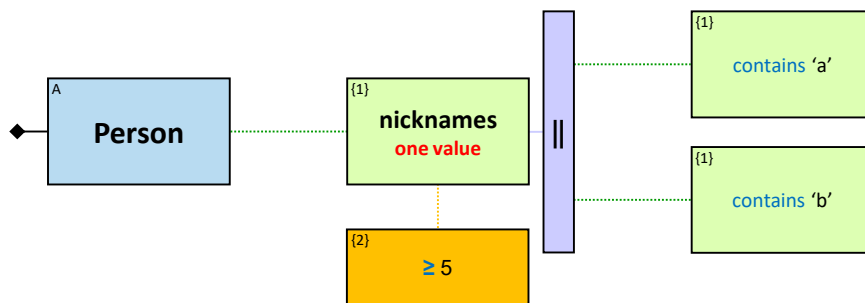

**Q312:** Any person that has more nicknames that contains 'b' or 'B' than nicknames that contains 'a' or 'A'

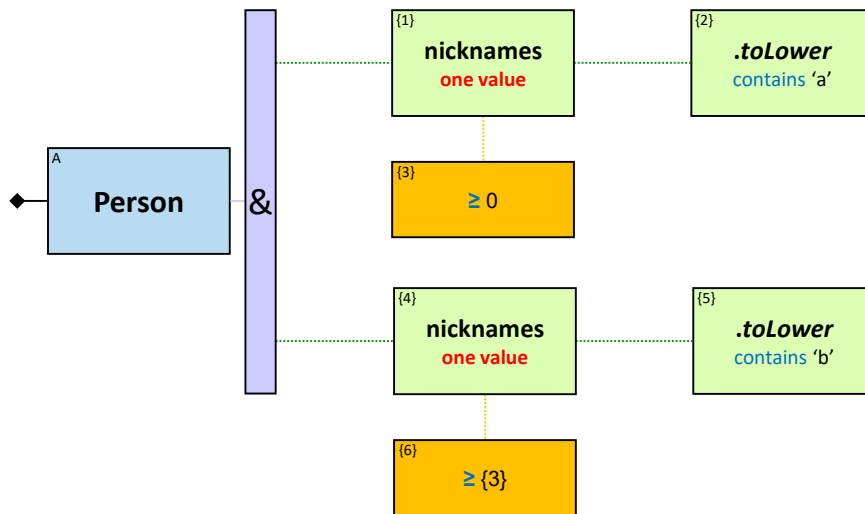

Note that if a nickname contains both 'a' and 'b' - it would be assigned to both {1} and {4}.

**Q313:** Any person that all his nicknames (if any) contain 'a'

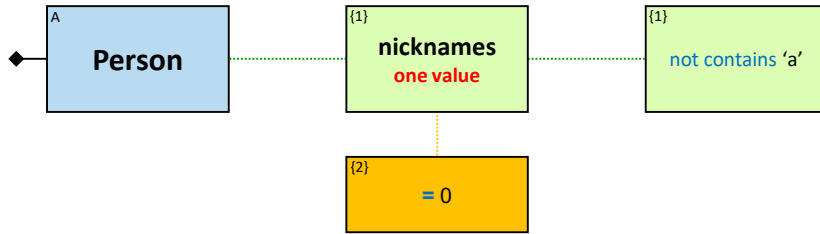

**Q314:** Any person that has no nickname that contain 'a'

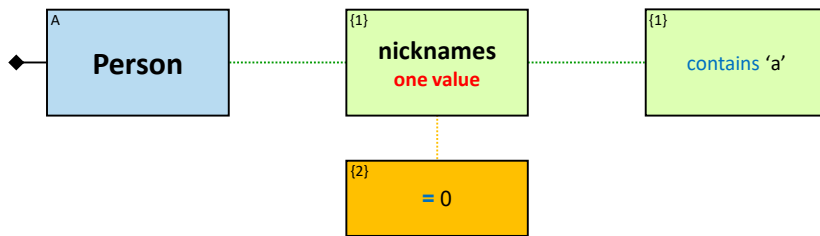

**Q315:** Any person that the average length of his three shortest nicknames is at least 3

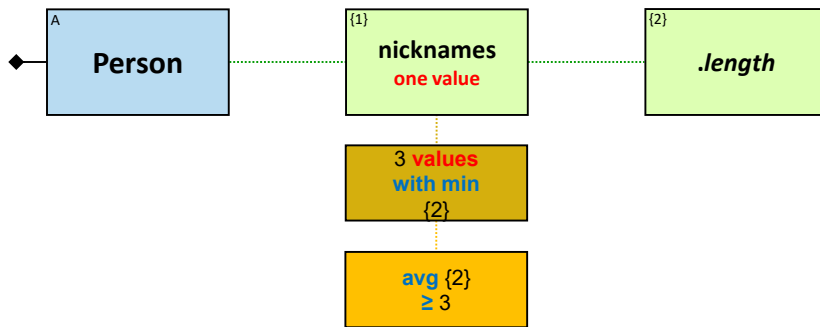

Another example:

Consider a multivalued composite property ‘{names}’, where each name has two sub-properties: (first: string, last: string).

**Q316:** Any person with a name (first: ‘John’, last: ‘Doe’)

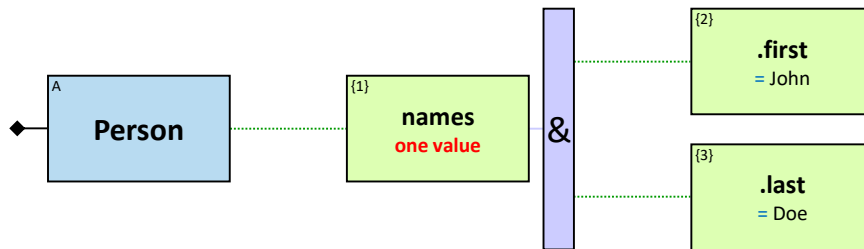

Relationships may contain multivalued properties as well.

**Q286:** Any person who at each day of at least 10 (not necessarily consecutive) days - owned at least five horses (not necessarily the same horses each day)

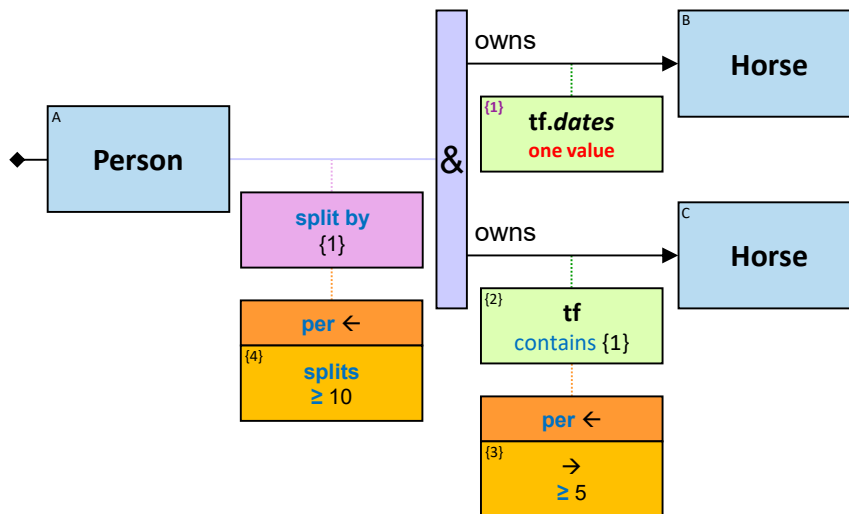

The *dates* function returns a list of all individual dates within the *tf* dataframe. *one value* represents a single element within this list (a single date). Each value is evaluated.

**Q287:** Any person who at each day of at least 10 (not necessarily consecutive) days - owned the same two horses

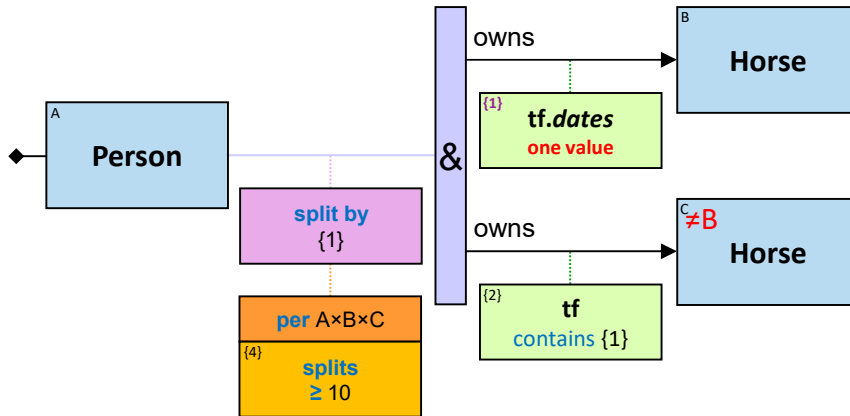

**Q327:** Any person who at each day of at least 10 consecutive days - owned at least five horses (not necessarily the same horses each day)

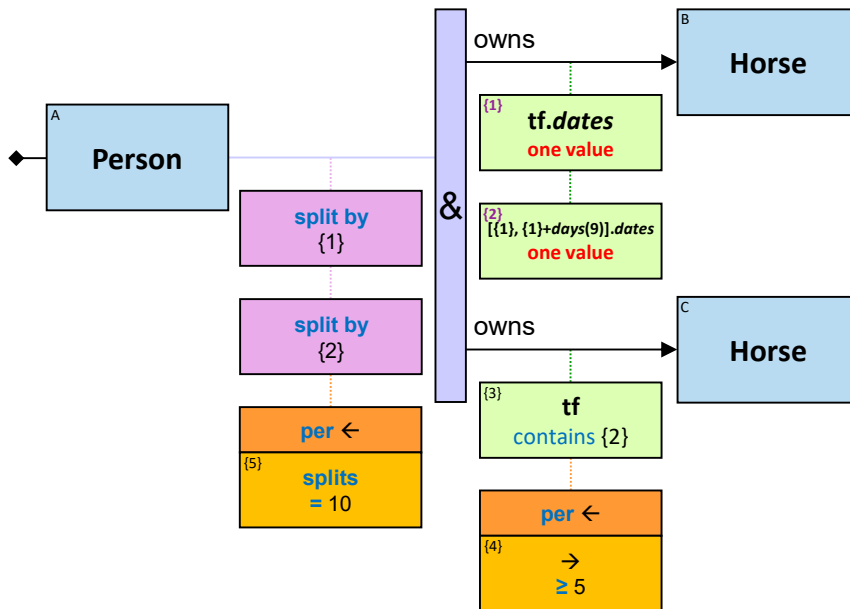

Operators over *multivalued* expressions:

- $[t] + [t] \rightarrow [t]$  - concatenation of lists
- $\{t\} \cup \{t\} \rightarrow \{t\}$  - union of sets
- $\{t\} \cap \{t\} \rightarrow \{t\}$  - intersection of sets
- $\{t\} - \{t\} \rightarrow \{t\}$  - difference of sets

- $[t] + \text{empty} = [t]$ ;  $\text{empty} + \text{empty} = []/\{\}$  (according to the operands type)
- $\{t\} \cup \text{empty} = \{t\}$ ;  $\text{empty} \cup \text{empty} = []/\{\}$  (according to the operands type)
- $\{t\} \cap \text{empty} = \{\}$ ;  $\text{empty} \cap \text{empty} = []/\{\}$  (according to the operands type)
- $\{t\} - \text{empty} = \{t\}$ ;  $\text{empty} - \text{empty} = []/\{\}$  (according to the operands type)

Functions over *multivalued* expressions:

- $[t].\text{count}, \{t\}.\text{count} \rightarrow \text{int}$
- $[t].\text{distinct} \rightarrow \text{int}$
- $[t].\text{set} \rightarrow \{t\}$  - list to set

Functions over *multivalued ordinal* expressions:

- $[t].\text{min}, \{t\}.\text{min} \rightarrow t / \text{empty}$  (*empty* when  $[t]/\{t\}$  is empty, or when it is evaluated as *empty*)
- $[t].\text{max}, \{t\}.\text{max} \rightarrow t / \text{empty}$
- $[t].\text{avg}, \{t\}.\text{avg} \rightarrow t / \text{empty}$
- $[t].\text{sum}, \{t\}.\text{sum} \rightarrow t / \text{empty}$  ( $t$  is int, real or duration; not date, time, nor datetime)
- $[t].\text{min}(n) \rightarrow [t]$ ,  $\{t\}.\text{min}(n) \rightarrow \{t\} / \text{empty}$  - (up to)  $n$  smallest values
- $[t].\text{max}(n) \rightarrow [t]$ ,  $\{t\}.\text{max}(n) \rightarrow \{t\} / \text{empty}$  - (up to)  $n$  largest values

**Q318:** Any dragon that Balerion froze/fired at in the three 30-day timeframes in which it froze/fired at dragons the largest number of times

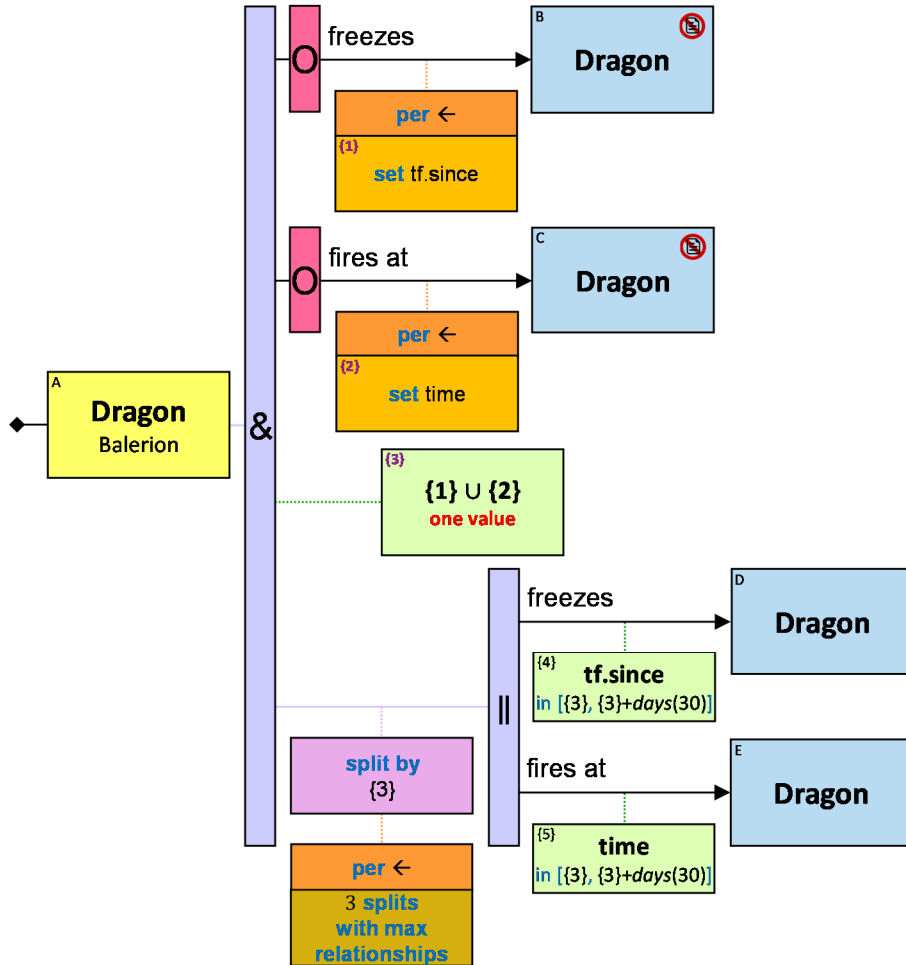

Note that {1} and {2} are defined right of an 'O', hence evaluated as *empty* when the optional part has no valid assignment. Since  $s \cup \text{empty} = s$ , the pattern is valid even if Balerion froze no dragon, or alternatively, fired at no dragon.



## 53 APPLICATION: SPATIOTEMPORALITY

Many people love dragon spotting. Dragon-spotters document the time, the location, and of course – the identity of the dragon that was spotted. The location may be a point (longitude and latitude), or a small area - when they are not sure about the exact coordinates.

Most new documents are attributed to their authors, but in many historic documents – the dragon-spotter is unknown.

To demonstrate spatiotemporality capabilities, we will extend our sample schema with the following relationship type:

- **spotted**(Person/Null, Dragon) - time: *datetime*, loc: *location*

This is a relationship between a dragon-spotter (which may be unknown) and the dragon he spotted. The properties of the relationship are the time and the location where the dragon was spotted.

*location* is an *opaque data type* which contains a geographic point (latitude and longitude) or a geographic shape (a circle, an ellipse, a polygon, etc.).

The *location* data type exposes a single function:

- `location.dist(location) → real` - the distance in [Km] between these two locations

The following comparison operators are presented:

- `location contains location` - true when the left operand contains the right operand
- `location within location` - true when the left operand is contained within the right operand

Two entity types are defined as well:

- **Landmark** - loc: *location*
- **City** - loc: *location*

Note that we chose to hold the location of stationary entities (landmark, city) as entity properties, and to hold the location of mobile entities (dragon) as relationship properties.

Here are some spatiotemporal examples:

*G1: Any dragon observed exactly at the peak of Dragonmont*

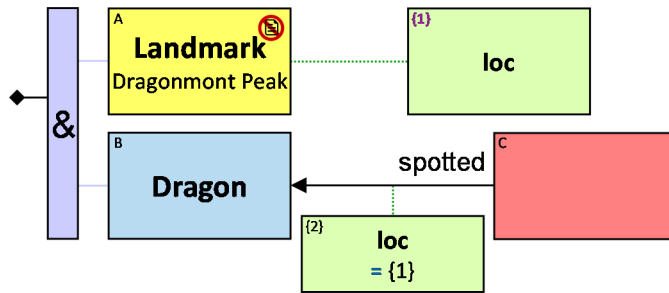

*G2: Any dragon observed within 5 Km from the peak of Dragonmont*

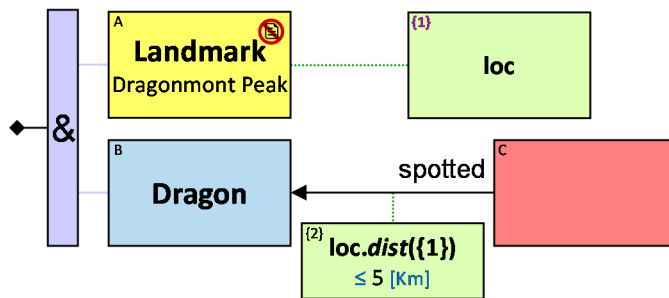

**G3:** Any dragon observed within 5 Km from the peak of Dragonmont at least five times during a 7-day period

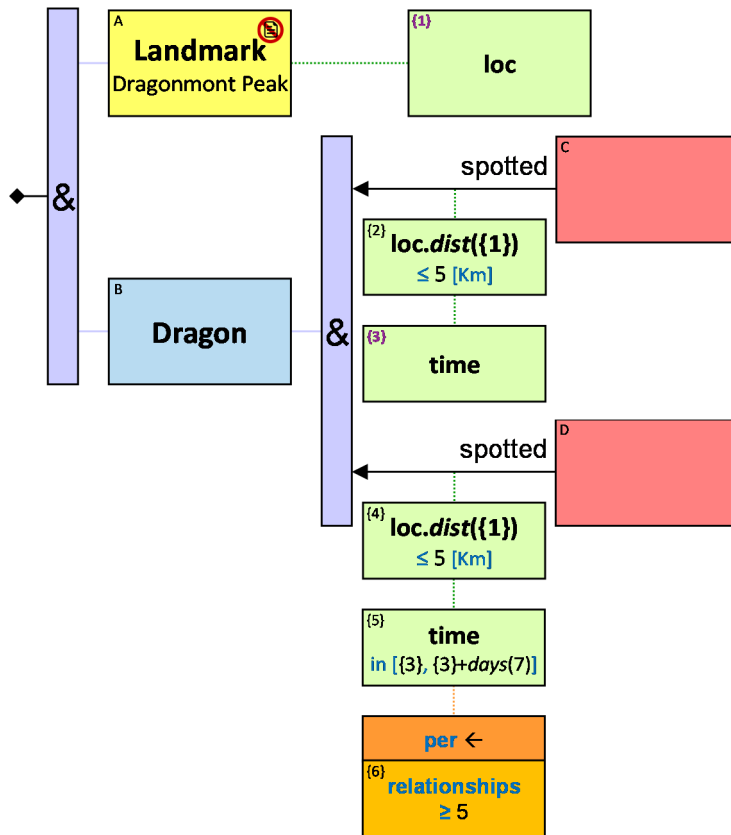

**G4:** Any dragon observed within 5 Km from the peak of Dragonmont between 4 AM and 6 AM in at least five days during a 7-day period

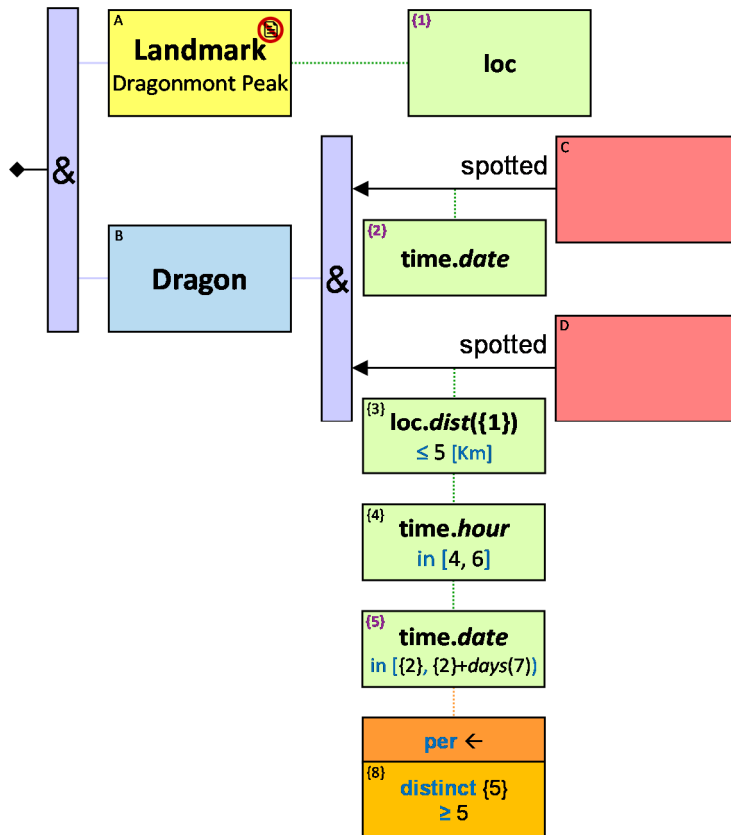

**G5:** Any dragon observed within 5 Km from the peak of Dragonmont in at least five separate weeks

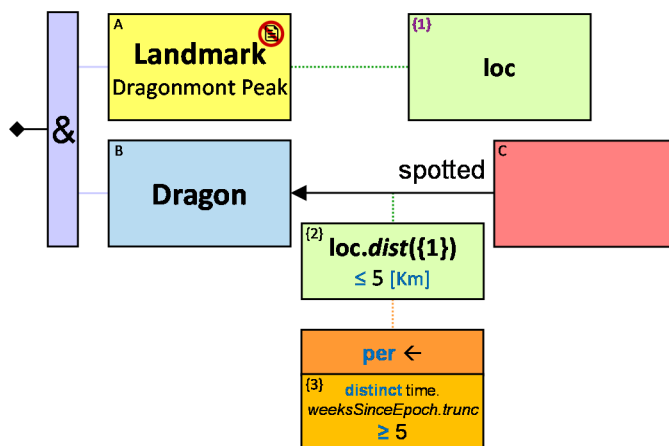

**G6:** Any week in which at least five dragons were observed within 5 Km from the peak of Dragonmont

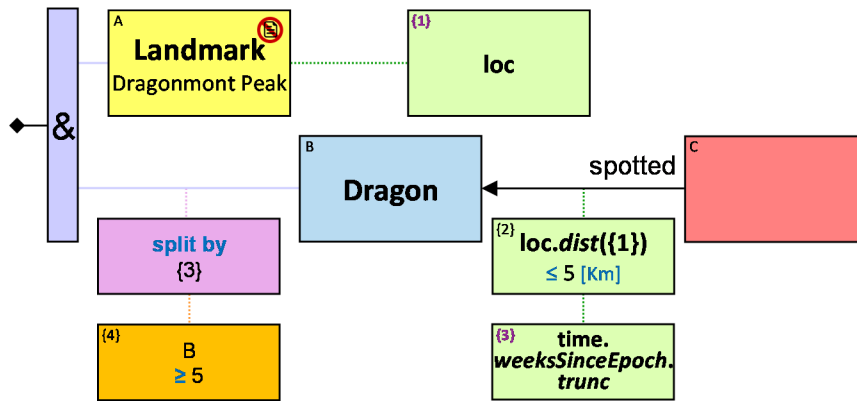

**G7:** Any dragon with conflicting observations (given that dragons can't fly faster than 300 Km/h)

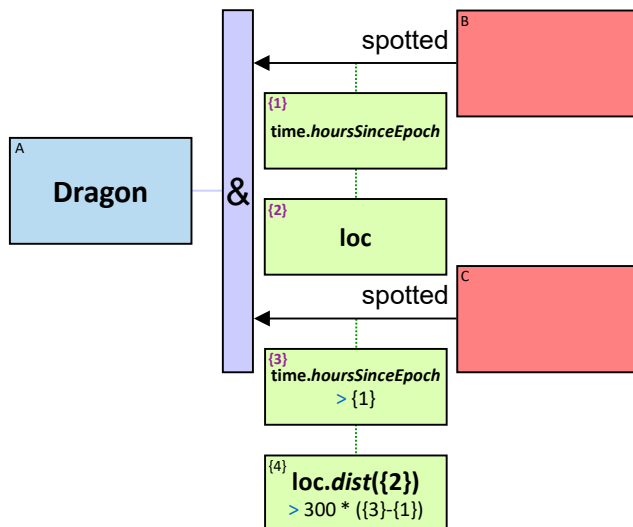

**G8:** Any Sarnorian subject who at least three of his dragons were spotted within 5 Km from the peak of Dragonmont – in a timeframe of 24 hours

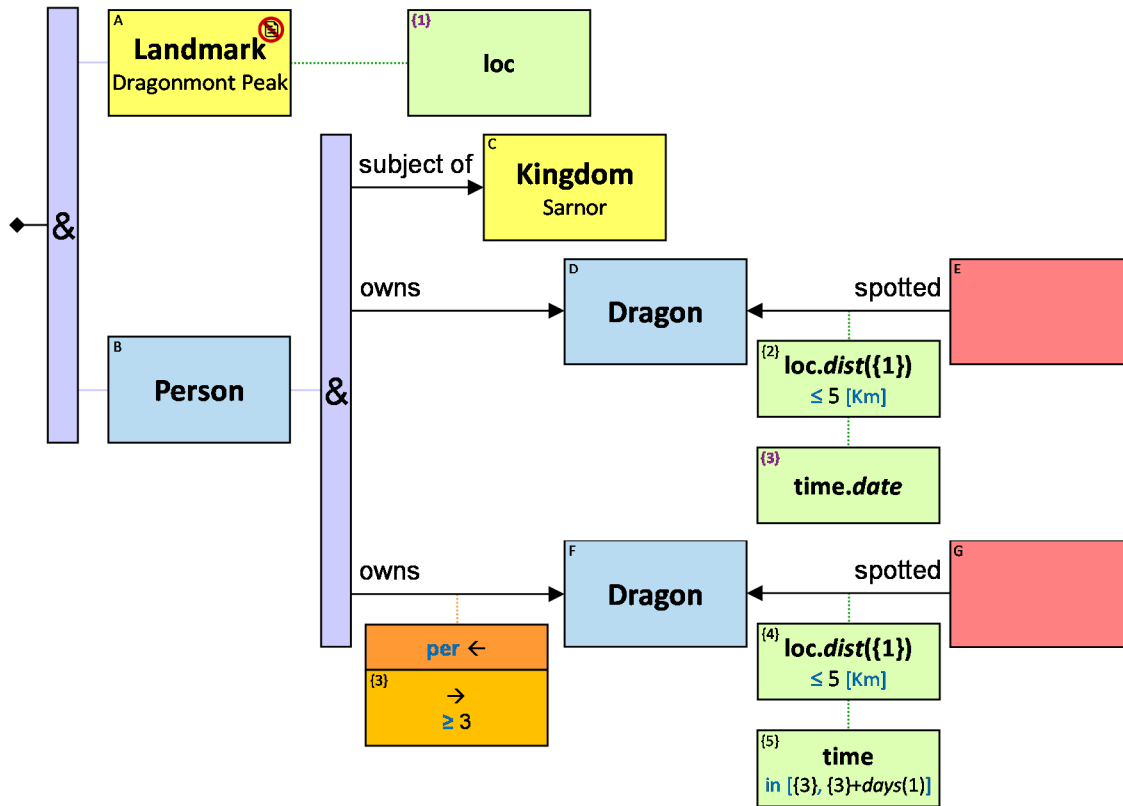

**G9:** Any dragon that stayed within 5 Km from the peak of Dragonmont for at least one week (To ensure this – the dragon should have been spotted there at least once per 6 hours, and not spotted at any other location throughout that period)

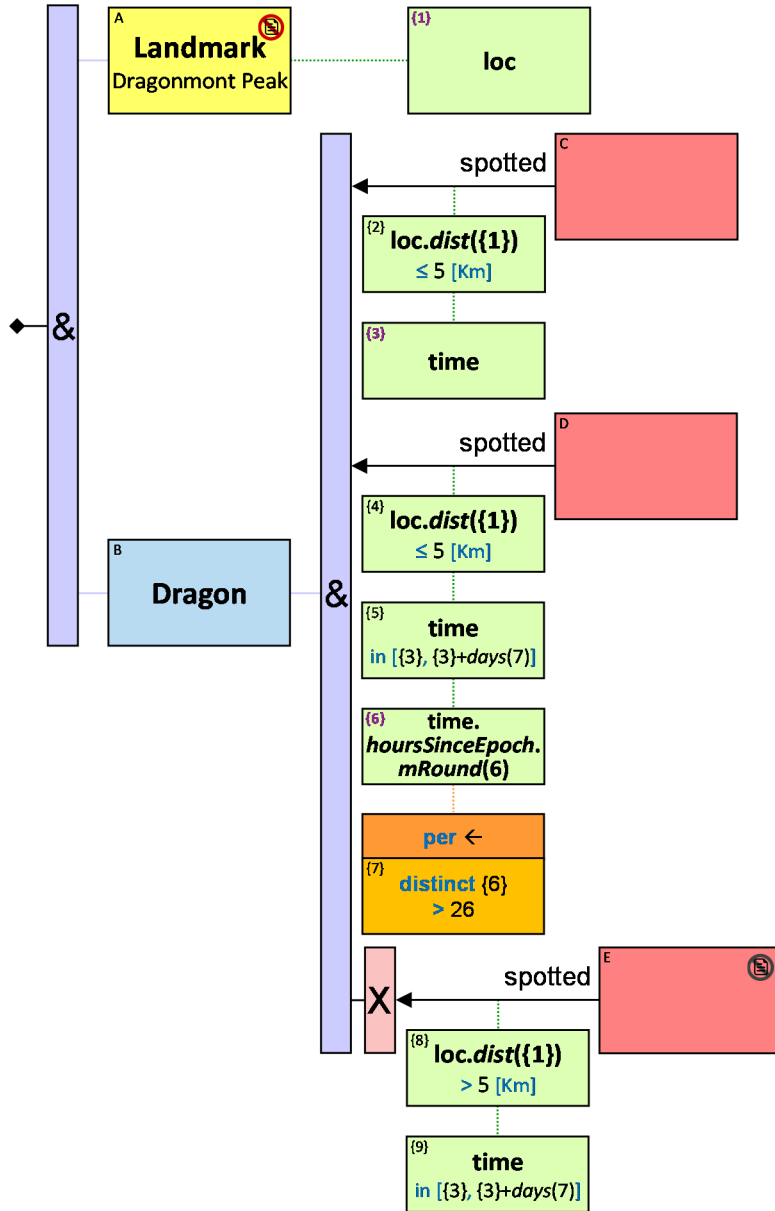

**G10:** Any pair of dragons that were spotted within 5 Km from each other at least five observation-pairs (To ensure this – paired observation should differ in up to 5 minutes; observation pairs should differ in at least 24 hours)

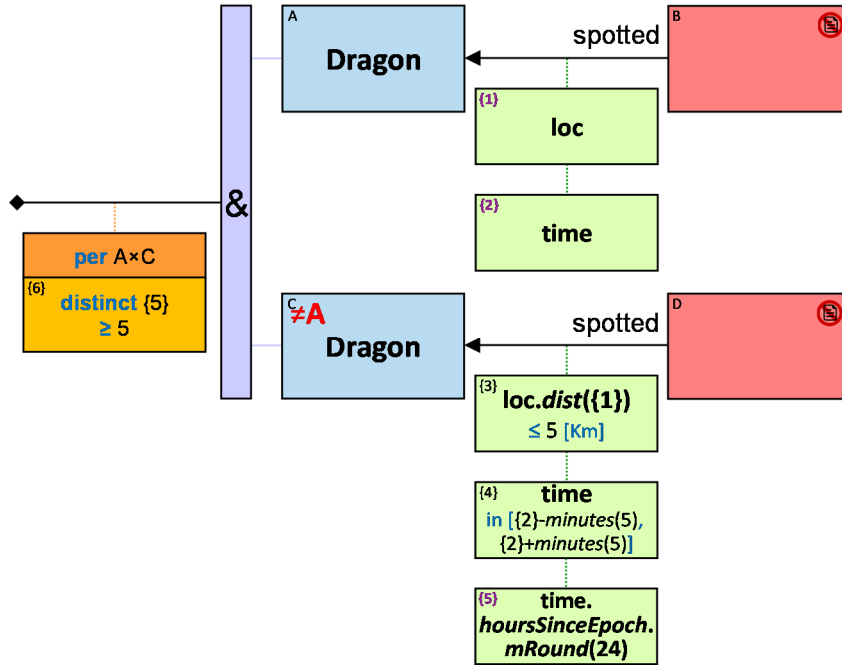

**G11:** Any pair of dragons A and B, where at least 10 times in the last 300 days A was spotted at a distance of less than 1 Km from places where B was spotted between one day and five days before

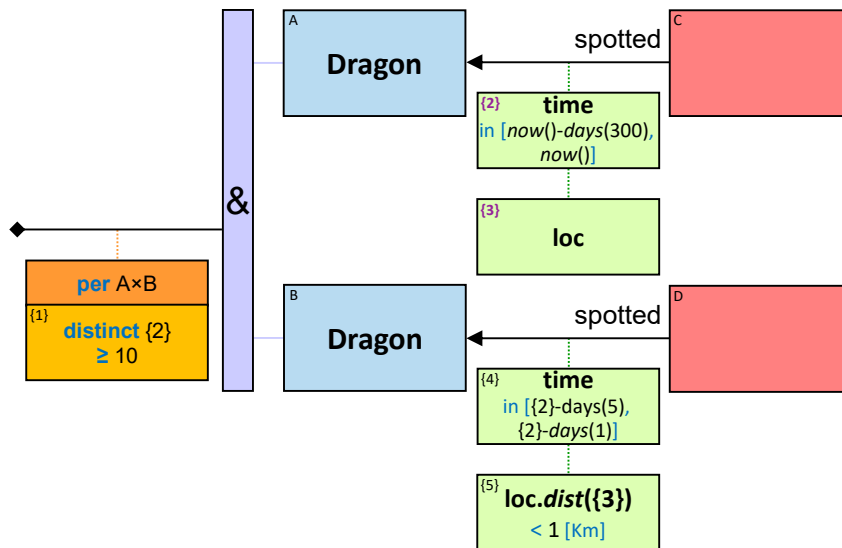



**G12:** Any pair of dragons that were spotted within 5 Km from each other at least five observation-pairs during a 30-day period (To ensure this – paired observation should differ in up to 5 minutes; observation pairs should differ in at least 24 hours)

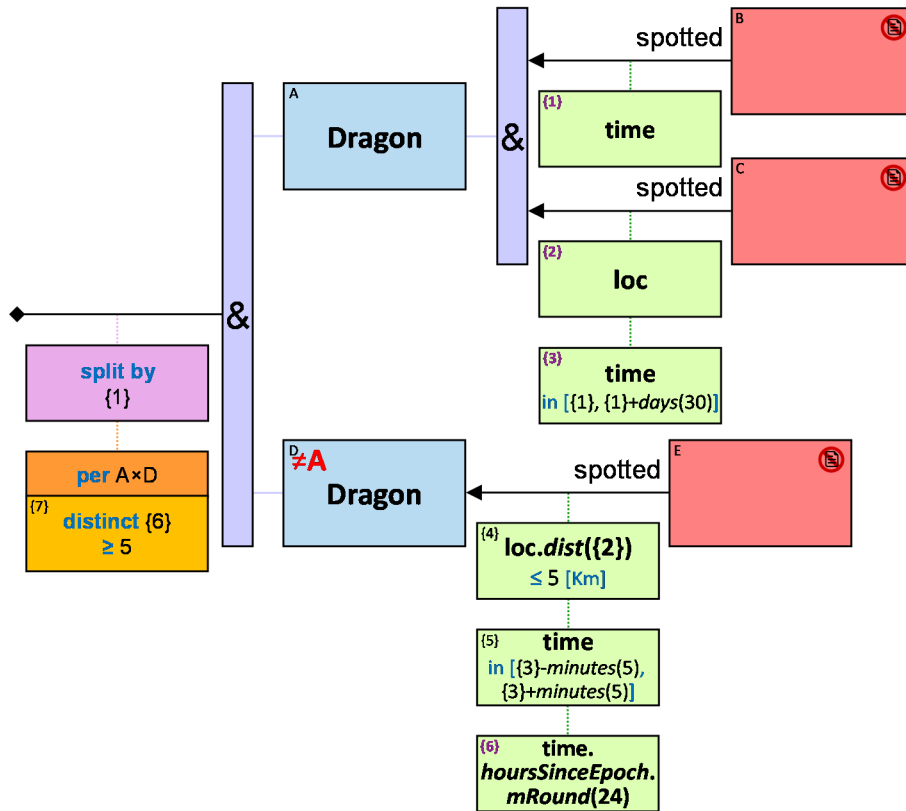

**G13:** Any Sarnorian subject whose dragons seem to "spy" on Balerion (at least one of his dragons was spotted at most 1 Km from Balerion throughout a 10-day period. Paired observation should differ in up to 5 minutes; observation pairs should differ in no more than 1 hour)

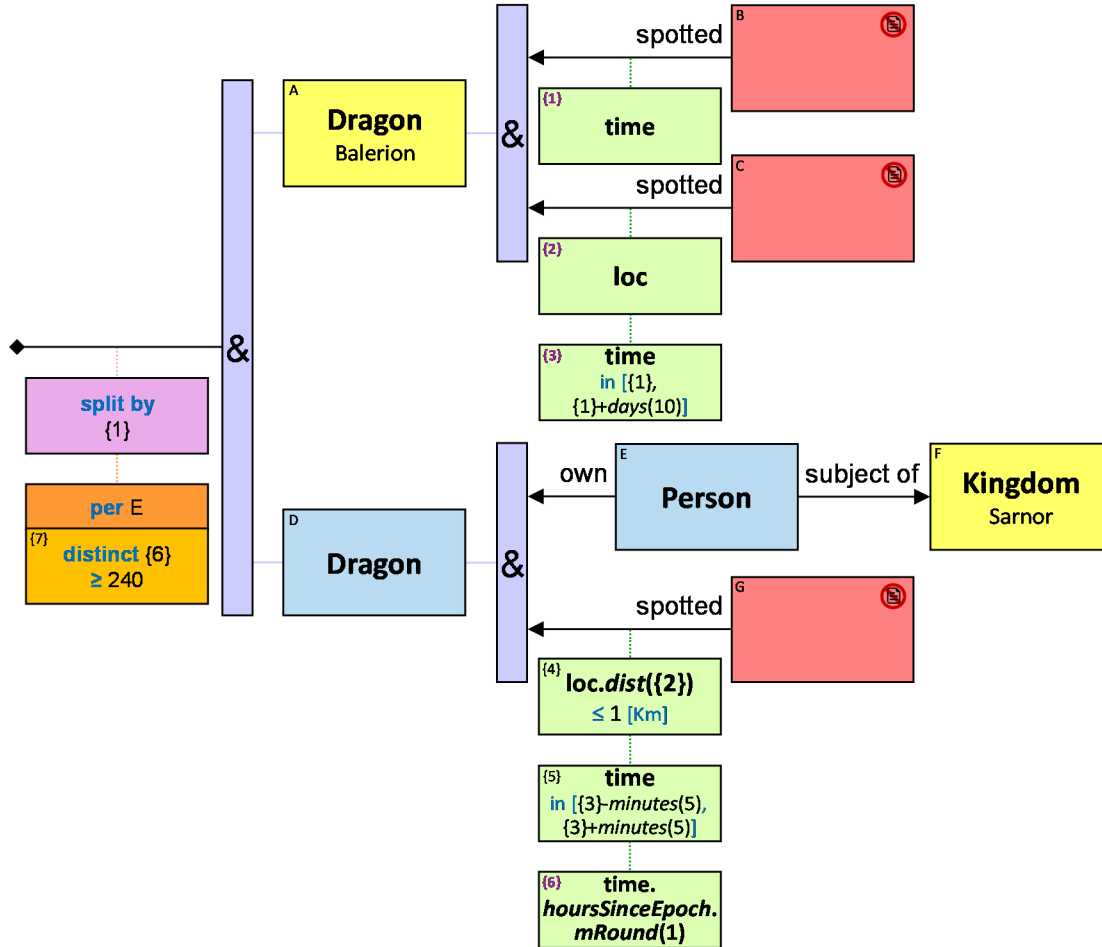

**G14:** Any pair of dragons that were spotted not less than 1000 Km from each other throughout a period of at least 1 year (To ensure this – paired observation should differ in up to 30 minutes; observation pairs should differ in no more than 24 hours)

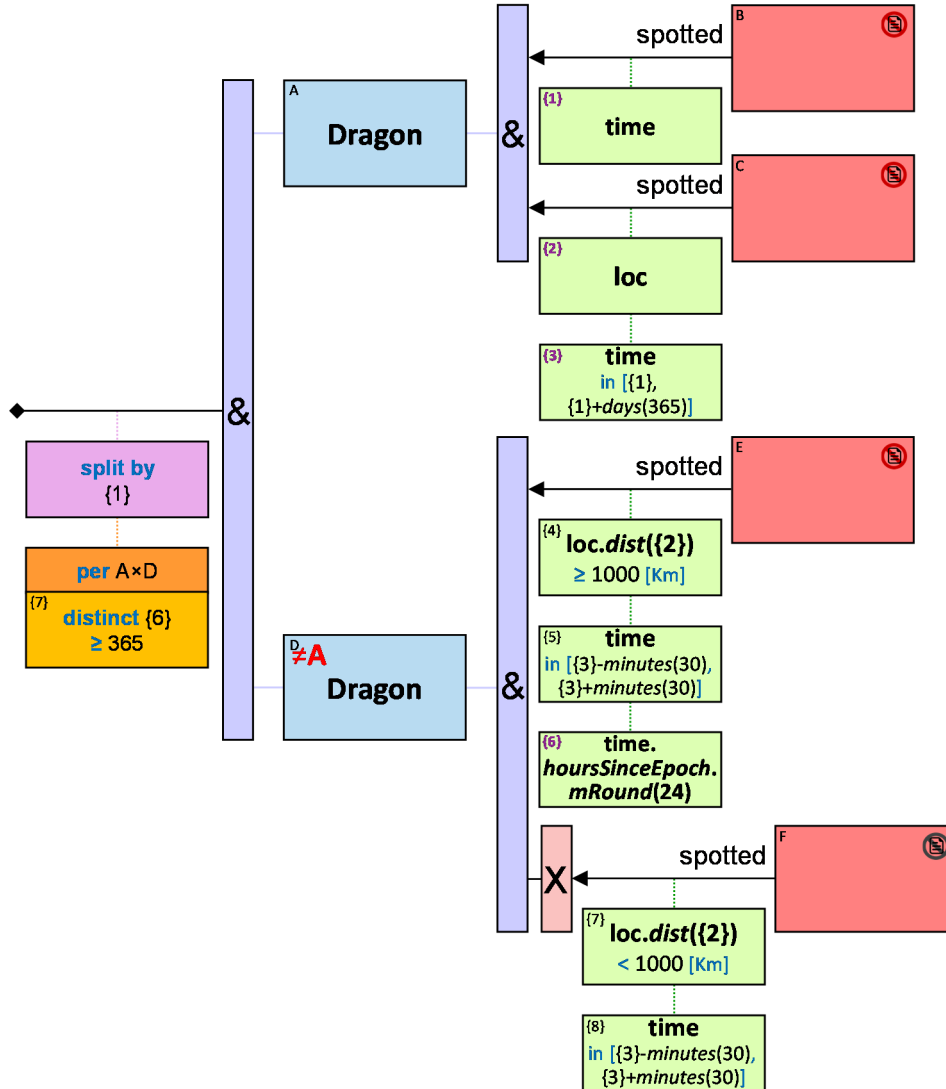

**G15:** Any landmark where at least five dragons were spotted within 5 Km from it

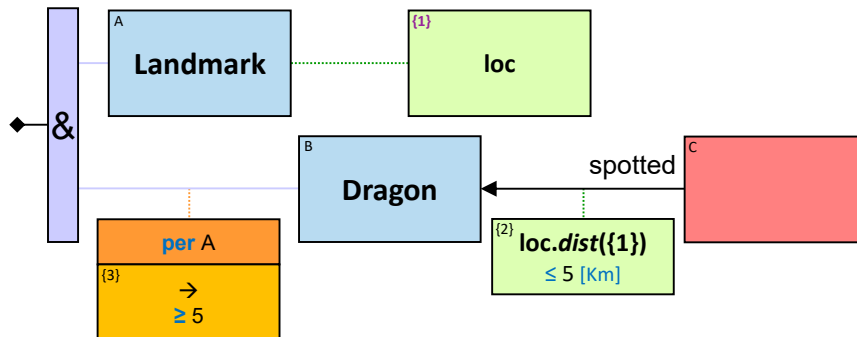

**G16:** Any landmark where at least five dragons were spotted within 5 Km from it throughout a 7-day period

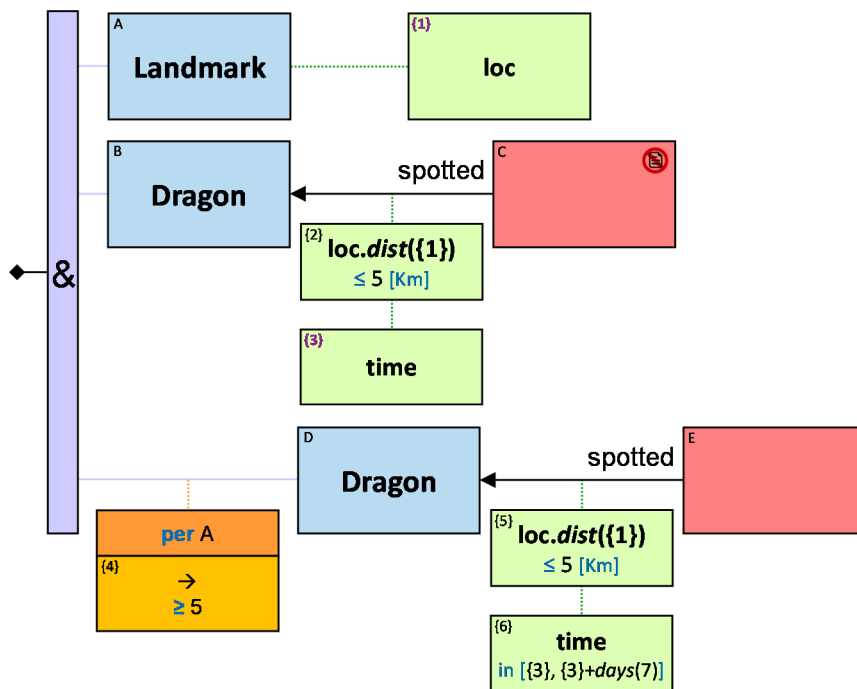

**G17:** Any city in which at least five dragons were spotted throughout a 2 minutes period

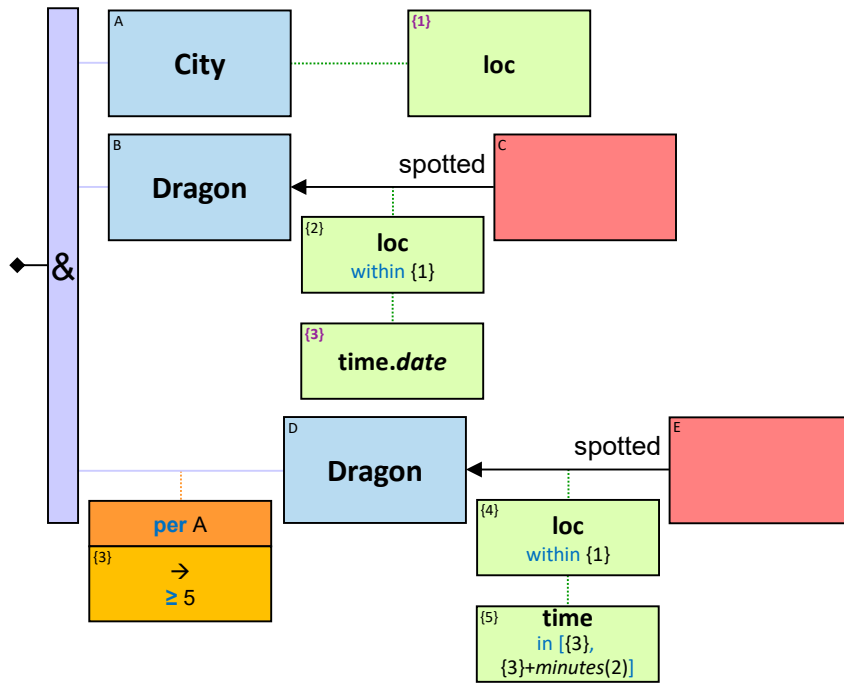

**G18:** Any dragon that was spotted in at least 10 cities

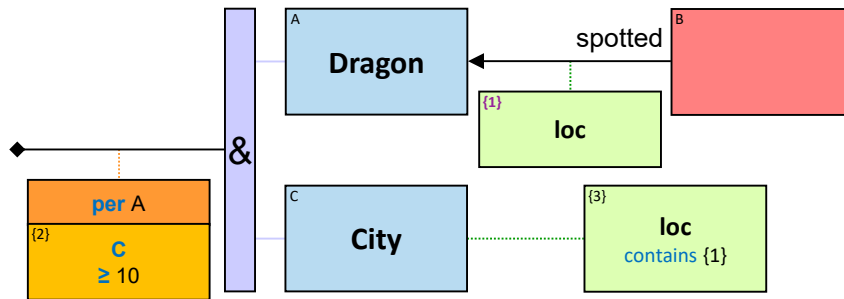

**G19:** Any dragon that was spotted in at least 10 cities throughout a 10-day period

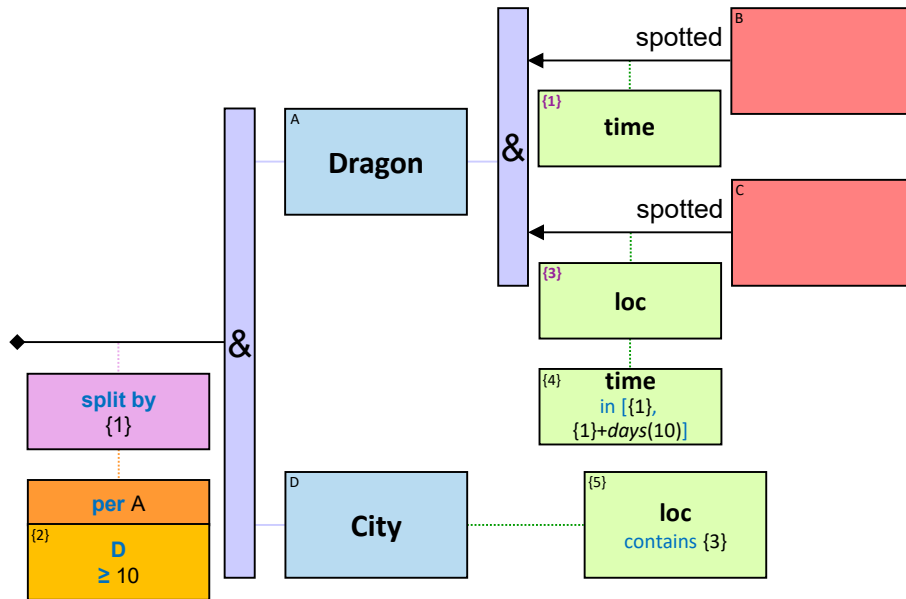

**G20:** Any dragon that traveled at least 2000 Km in 24-hours

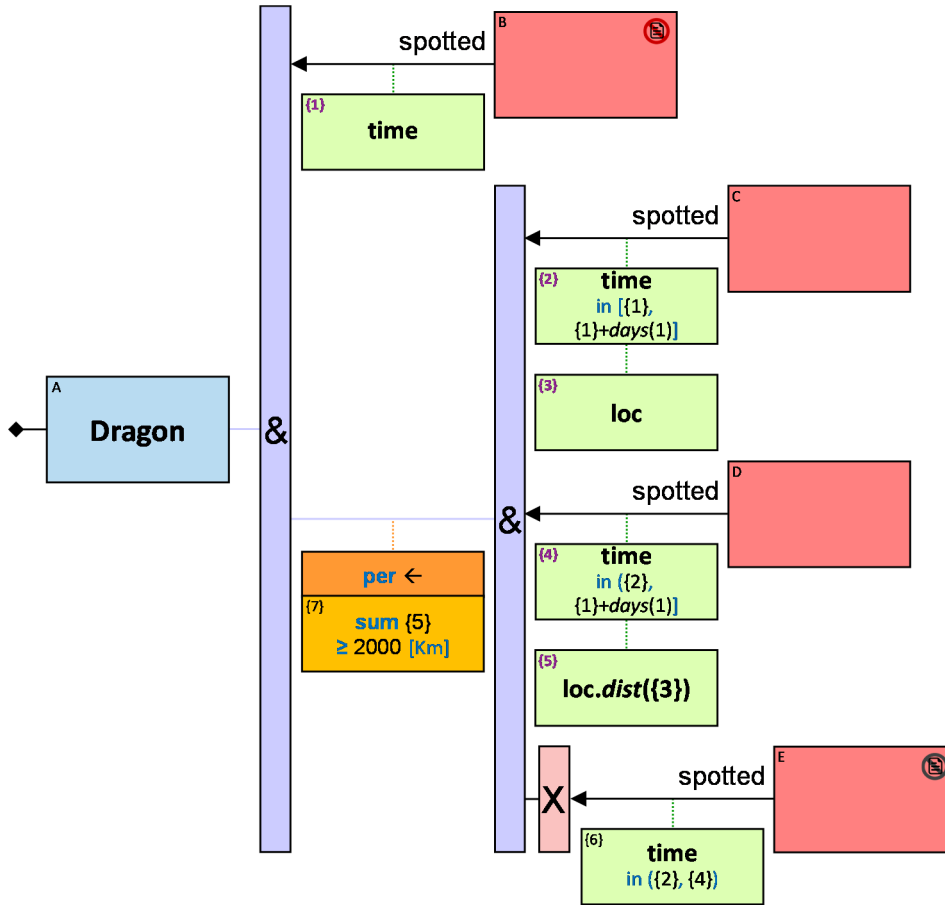

**G21:** Any dragon-spotter that spotted the same dragon at two locations – at least 1000 Km apart

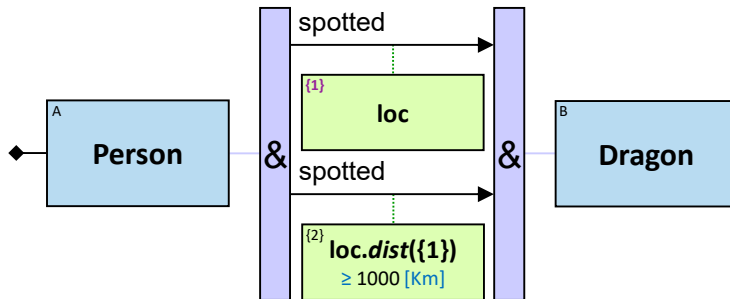

54 ENSEMBLES

An ensemble is a virtual concrete entity that encapsulates several concrete entities. It is defined by:

- The entities it encapsulates: A set of
  - Concrete entities
  - Typed entities with optional constraints
  - Untyped entities with constraints
- A entity type name assigned to the aggregation

Ensembles can be defined, and then used in queries.

Here are some definition examples:

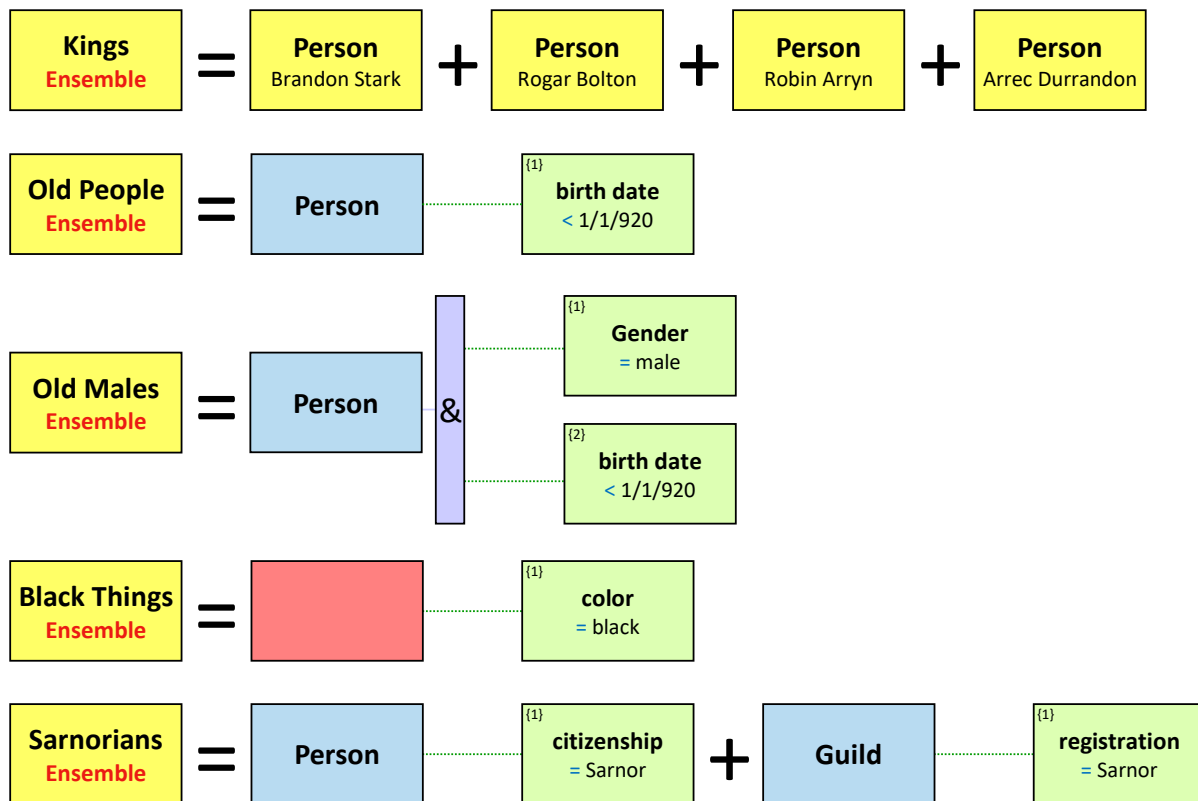

- 'Kings' is defined as an encapsulation of four concrete entities
- 'Old People' is defined as an encapsulation of all people born before 920
- 'Old males' is defined as an encapsulation of all males born before 920



- ‘Black things’ is defined as an encapsulation of all entities which have a property ‘color’ with value ‘black’
- ‘Sarnorian’ is defined as an encapsulation of all Sarnorian subjects and all guilds registered in Sarnor

An ensemble in a query will show as an ensemble in the query’s result. It won’t ‘disassemble’ into the entities it encapsulates.

Ensembles have the following auto-generated aggregate properties:

- ‘count’ - the number of encapsulated entities
- ‘e.count’ - the number of encapsulated entities of type *e* (valid for every encapsulated entity type)
- ‘e.p.distinct’ - the number of distinct values of property *p* of encapsulated entity type *e* (valid for every property of an encapsulated entity type)
- ‘e.p.min’, ‘e.p.max’, ‘e.p.avg’, ‘e.p.sum’ - the min, max, sum, and average of property *p* of entity type *e* (valid for every property with a numeric data type of an encapsulated entity type)

Using ensembles in queries:

- Ensembles are used in a similar manner to concrete entities (constraints cannot be defined, etc.)
- Adjacent relationship types should support at least one encapsulated entity type

Here are some examples:

**Q208:** Any dragon owned by an entity encapsulated within ‘Kings’ - since 1/1/1011 or since a later date

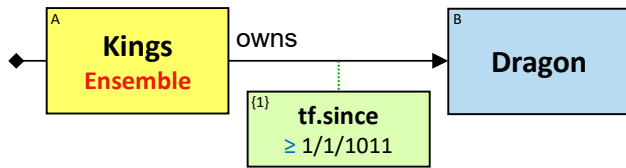

The ensemble ‘Kings’ will be part of the query’s result. It won’t be disassembled into its four members.

**Q209:** Any dragon than froze at least three dragons owned by entities encapsulated within ‘Sarnorian’

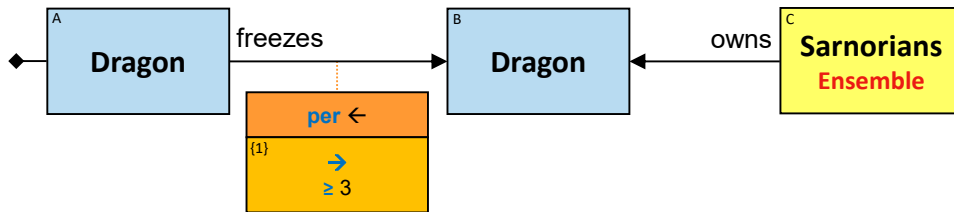

If, for example, some dragon froze two dragons owned by Stark, and one dragon owned by Bolton - it would be part of the answer. Again, ‘Kings’ will be a part of the query’s result.

**Q210:** Any person who has at least three 'owns' relationships with entities encapsulated within 'Black Things'

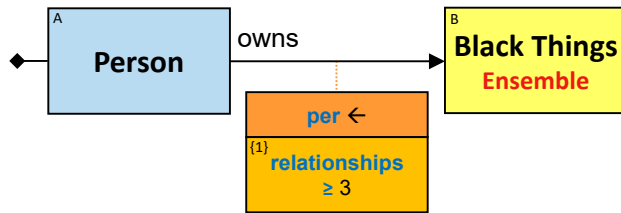

**Q211:** Any path with length  $\leq 4$  between an entity encapsulated within 'Sarnorian' and an entity encapsulated within 'Kings'

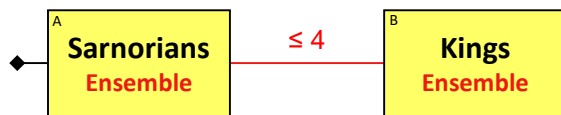

**Q212:** Are there more than 10 days in which at least 10 ownership relationships started between entities encapsulated within 'Old People' and entities encapsulated within 'Black Things'?

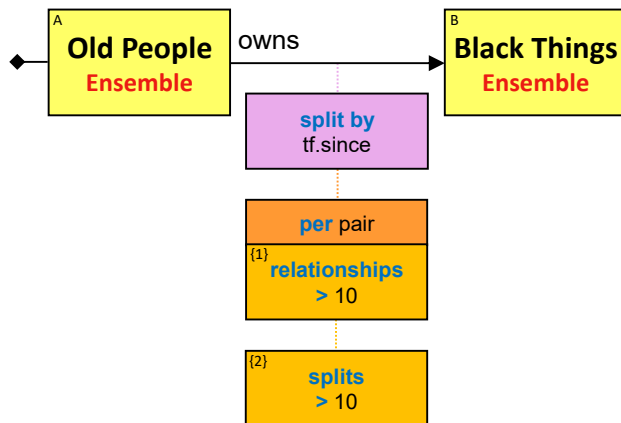

## 55 LOGICAL ENTITY TYPES

A logical entity type can be assigned to specific entities. It is defined by:

- The entities it assigns a new type name to:
  - Concrete entities
  - Ensembles
  - Typed entities with optional constraints
  - Untyped entities with constraints

- A entity type name assigned to each such entity

Logical entities types can be defined, and then used in queries.

Here are some definition examples:

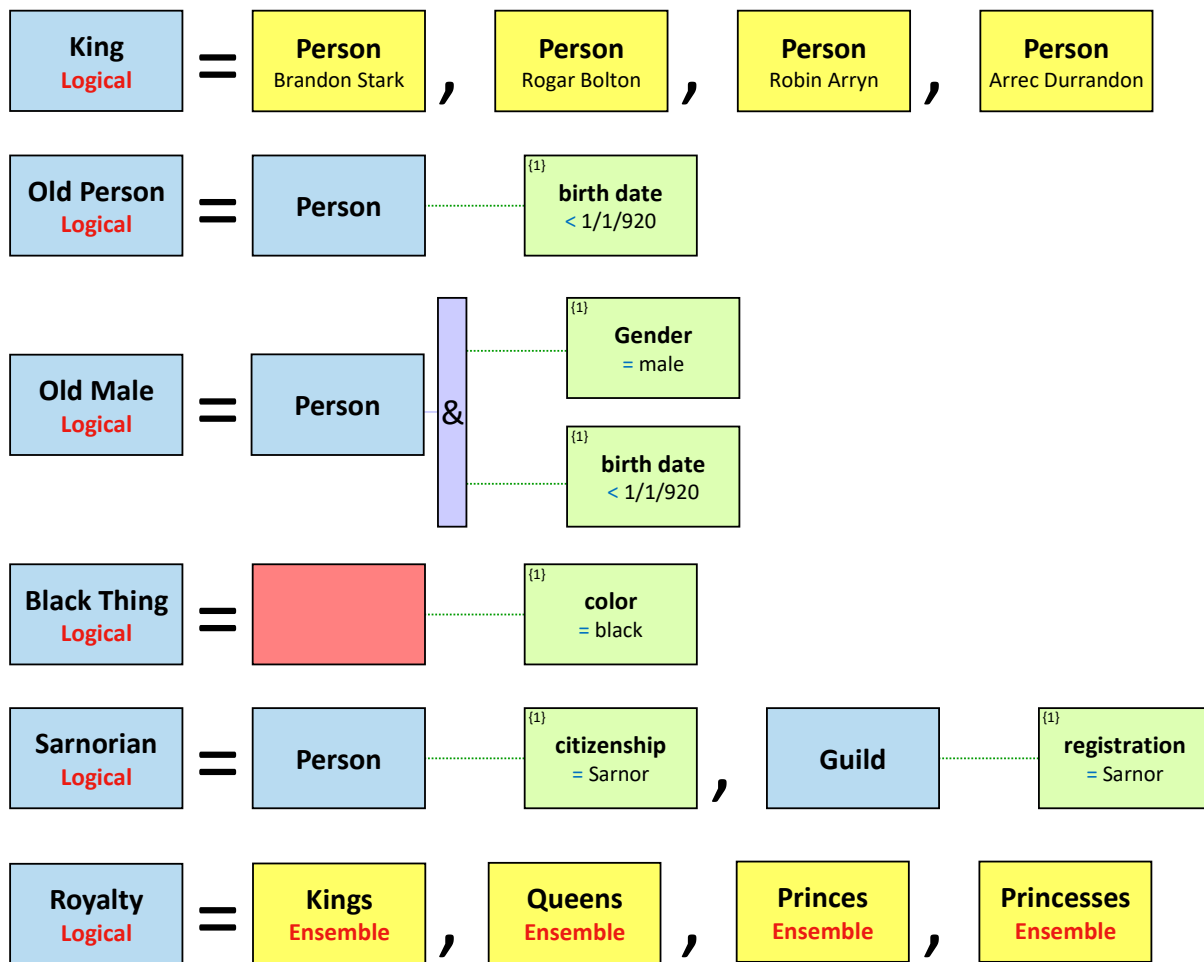

- ‘King’ is defined as one of four concrete entities
- ‘Old Person’ is defined as a person born before 920
- ‘Old male’ is defined as a male born before 920
- ‘Black thing’ is defined as a an entity that has a property ‘color’ with value ‘black’
- ‘Sarnorian’ is defined as a a Sarnorian subject, or a Sarnorian registered guild
- ‘Royalty’ is defined as one of four ensembles

In a query's result - entities of logical type are resolved to concrete entities (similar to typed and untyped entities).

Logical entity types have the following properties:

- 'et.p' - where et is an entity type used in the definition, and p is a name of a property of that entity type

Using logical entity types in queries:

- Logical entity types are used in a similar manner to typed entities
- Adjacent relationship types should support at least one entity type used in the definition

Here are examples of patterns that incorporate the logical entity types defined above:

**Q203:** Any dragon owned by a King since 1/1/1011 or since a later date

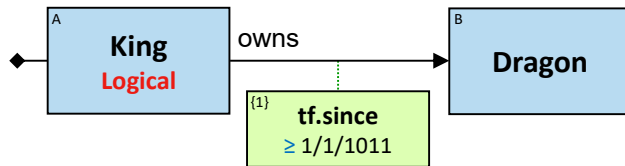

**Q204:** Any dragon than froze at least three dragons owned by Sarnorians

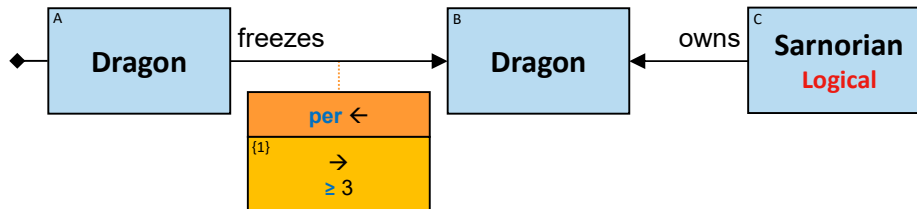

**Q205:** Any person who has at least three 'owns' relationships with 'Black Things'

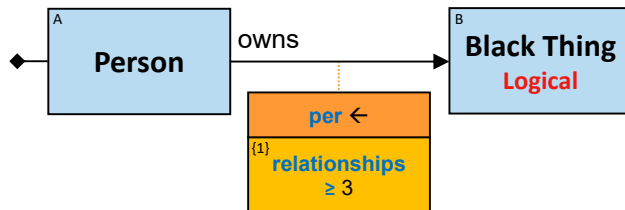

**Q206:** Any 'Sarnorian' and 'King' pair with graph distance  $\leq 4$

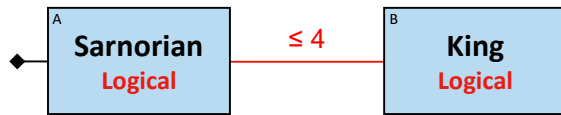

**Q207:** Are there more than 10 days in which at least 10 ownership relationships started between a certain 'Old Person' and a certain 'Black Thing'?

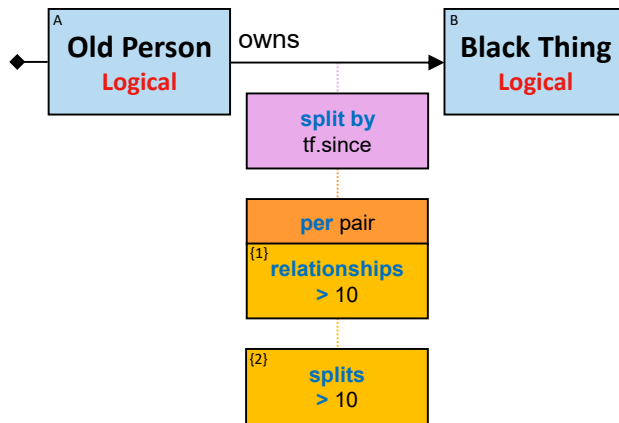

## 56 LOGICAL RELATIONSHIP TYPES

A logical relationship type is defined by:

- A pattern
- Two typed/untyped entities in the pattern
- A relationship type name assigned to each such relationship

A logical relationship type can be either directional or bidirectional.

Logical relationship types can be defined, and then used in queries.

Logical relationships in a query - appear as logical relationships in the query's result as well.

Here are some definition examples:

**LR1:** *sibling* - a bidirectional relationship. Two people are siblings if they share a parent

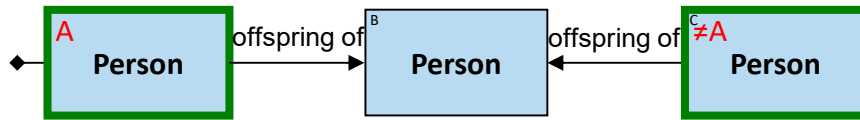

**LR2:** *cousin* - a bidirectional relationship. Two people are cousins if their parents are siblings

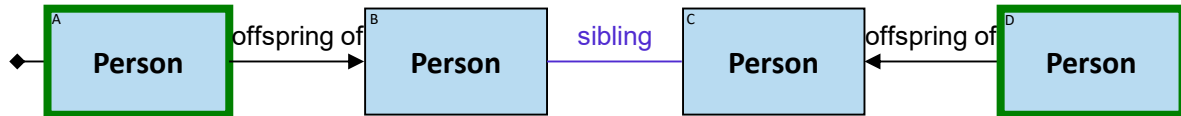

**LR3:** *prison-mate* - a bidirectional relationship. Two people are prison-mates if they were imprisoned in the same prison at intersecting timeframes

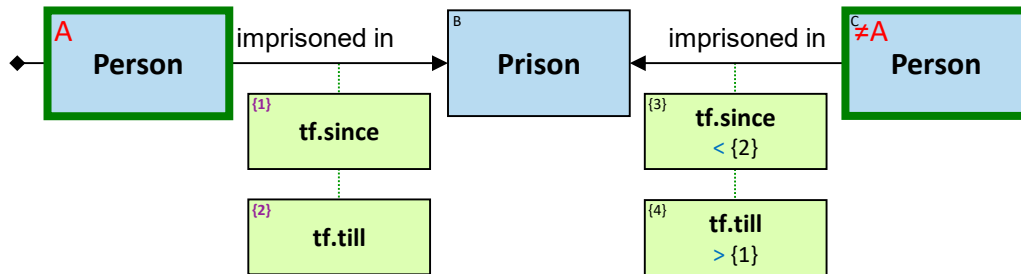

**LR4:** *first degree* - a bidirectional relationship. Two people have a 1<sup>st</sup> degree relationship if one is an offspring of the other, if they are siblings, or if they are spouses

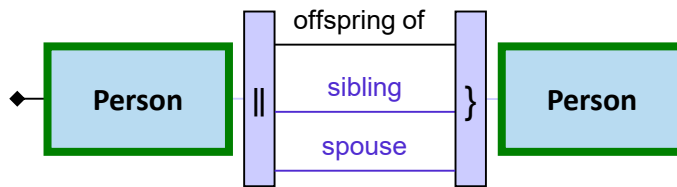

**LR5:** *second degree* - a bidirectional relationship. Two people have a 2<sup>nd</sup> degree relationship if there is a person who have 1<sup>st</sup> degree relationship with both of them

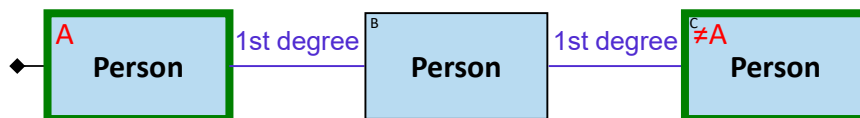

**LR6:** *family friend* - a directional relationship. A person is a family friend of person A if he is A's friend, if he is a friend of A's 1<sup>st</sup> degree, or if he is a friend of A's 2<sup>nd</sup> degree

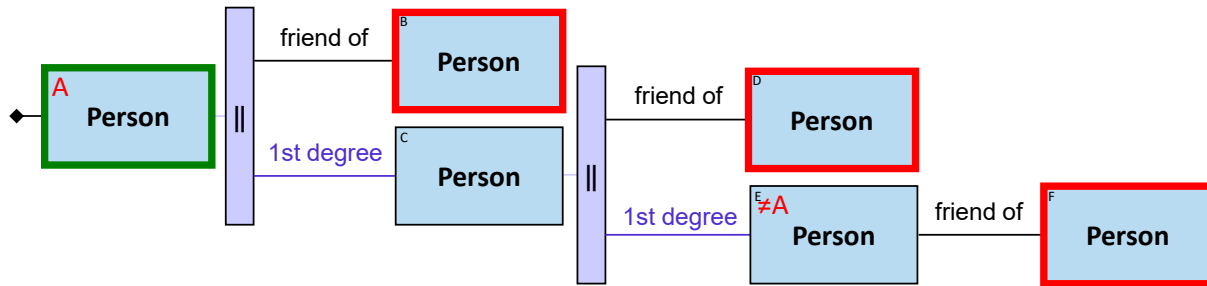

**LR7:** *tmo* - a directional relationship. Person A is a tradition maintainer offspring of person C if A is an offspring of C, and they are both members of the same guild.

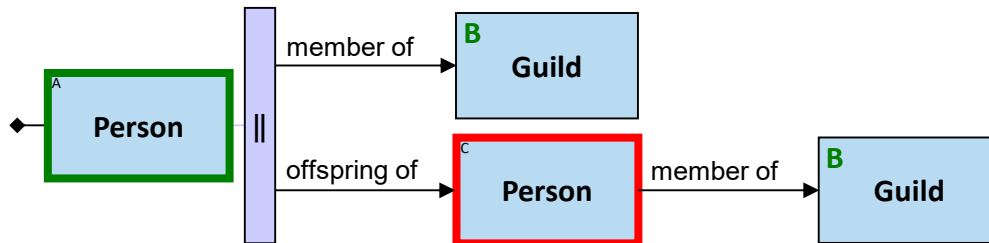

ACKNOWLEDGEMENTS

The author would like to thank Roman Margolis for fruitful discussions and helpful suggestions, and Thomas Frisendal for remarks on an early draft.

REFERENCES

- [1] George R. R. Martin. 1996-. A Song of Ice and Fire.
- [2] Marko A. Rodriguez and Peter Neubauer. 2010. Constructions from Dots and Lines. Bulletin of the American Society for Information Science and Technology 36: 35–41. DOI: 10.1002/bult.2010.1720360610
- [3] Marko A. Rodriguez and Peter Neubauer. 2010. The Graph Traversal Pattern. CoRR, abs/1004.1001.
- [4] L. Singh, M. Beard, L. Getoor and M. B. Blake. 2007. Visual Mining of Multi-Modal Social Networks at Different Abstraction Levels. Information Visualization, 2007. IV '07. 11th International Conference, Zurich, 2007, pp. 672-679. DOI: 10.1109/IV.2007.126
- [5] Gremlin (programming language). [https://en.wikipedia.org/wiki/Gremlin\\_\(programming\\_language\)](https://en.wikipedia.org/wiki/Gremlin_(programming_language))
- [6] Cypher Query Language. [https://en.wikipedia.org/wiki/Cypher\\_Query\\_Language](https://en.wikipedia.org/wiki/Cypher_Query_Language)