

A vertex and edge deletion game on graphs

Cormac O'Sullivan

Abstract

Starting with a graph, two players take turns in either deleting an edge or deleting a vertex and all incident edges. The player removing the last vertex wins. We review the known results for this game and extend the computation of nim-values to new families of graphs. A conjecture of Khandhawit and Ye on the nim-values of graphs with one odd cycle is proved. We also see that, for wheels and their subgraphs, this game exhibits a surprising amount of unexplained regularity.

1 Introduction

Let $G = (V(G), E(G))$ be a finite graph with vertices $V(G)$ and edges $E(G)$. We allow loops and multiple edges. This is the starting position for the game of *graph take-away* (or graph chomp) and its rules are as follows. Two players take turns in either deleting an edge or deleting a vertex and all incident edges. The player removing the last vertex wins. This impartial game has been studied in [FS91, DT96, CT97, KY11] and is a special case of the general games on partially ordered sets introduced by Gale and Neyman in [GN82]. See, for example, the introductions of [Byr03, FR15] for more history. The conjectures in [GN82] were recently disproved in [BC17].

For each graph G we would like to know whether the player going first or the player going second has a winning strategy. According to the Sprague-Grundy theory [Con01, Chap. 11], each of these graph games has a nim-value $g(G)$, and the second player has a winning strategy exactly when $g(G) = 0$. The nim-value of a disjoint union $H_1 \cup H_2$ of two graphs may be easily calculated from the individual nim-values of H_1 and H_2 using nim-addition as reviewed in Section 2.

The basic notation and definitions of graph theory we use are contained in [BM08], for example. If G is bipartite (two-colorable) then Fraenkel and Scheinerman showed in [FS91] that the winning strategy is to restore the number of vertices and the number of edges to even parity. Using their notation, for any integer k let $k_{(m)} := k \bmod m$ with $k_{(m)} \in \{0, 1, \dots, m-1\}$. Writing $|V(G)|$ and $|E(G)|$ for the number of vertices and edges of G , we define a parity function

$$\phi(G) := |V(G)|_{(2)} + 2(|E(G)|_{(2)})$$

so that $\phi(G)$ is 0, 1, 2 or 3.

Proposition 1.1. [FS91, Cor. 2.2] *If G is bipartite then $g(G) = \phi(G)$.*

This result was also proved in [KY11, Thm. 3]. It follows easily that a tree T has nim-value $|E(T)|_{(2)} + 1$ and a cycle graph C_n of length $n \geq 2$ has nim-value 0. A one-cycle (i.e. a vertex with a loop attached) has nim-value 2. Because of this difference, we must treat loops and longer cycles differently. Consequently, cycles in this paper refer to cycles of length at least 2.

A situation where the nim-value of a graph may be obtained from a simpler graph is described as follows. Let H_1 and H_2 be isomorphic graphs containing corresponding vertices v_1 and v_2 respectively. Let G' be

Date: Sept 4, 2017.

2010 Mathematics Subject Classification: 91A46, 05C38.

Key words and phrases: impartial games, graphs, nim-values.

Support for this project was provided by a PSC-CUNY Award, jointly funded by The Professional Staff Congress and The City University of New York.

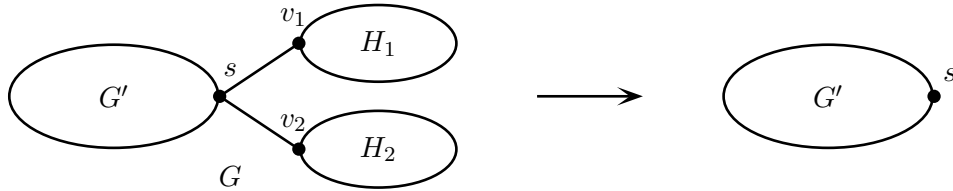

Figure 1: Cancellation when $H_1 \cong H_2$

another graph containing a vertex s . Build G from the disjoint graphs G' , H_1 and H_2 by adding the edges sv_1 and sv_2 as shown in Figure 1. In this situation we say that G has *cancellation at s* and may be replaced by G' since, as we see in Section 2, $g(G) = g(G')$. A graph is *reduced* if no cancellation is possible.

Graphs that are not bipartite must contain a loop or an odd cycle. It is reasonable to expect that some non-bipartite graphs G will also have $g(G) = \phi(G)$ if a strategy of eliminating odd cycles can be used. To determine the nim-values of graphs with exactly one odd cycle we need to introduce the next definition.

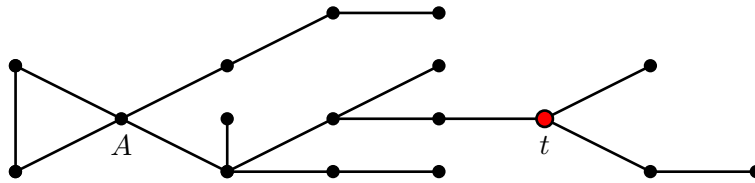

Figure 2: A telescoping vertex t

Definition 1.2. Suppose a tree T is attached to an odd cycle at vertex A . A vertex of T is *telescoping* if, when it is deleted and the resulting graph reduced, all that remains of T that is still connected to the cycle is A .

Note that when we say that a graph G_1 is *attached at v* to the graph G_2 , we mean that $G_1 \cap G_2$ is the vertex v . In the example in Figure 2, the tree attached to the 3-cycle at A has one telescoping vertex as indicated. The properties of telescoping vertices do not seem to have appeared before in the literature, that the author is aware of, and we will see that their study becomes quite intricate. The main part of this paper, in Sections 3, 4 and 5, establishes the next result.

Theorem 1.3. *Let G be a reduced graph consisting of an odd cycle attached to a tree at one vertex. Then*

$$g(G) = \begin{cases} 0 & \text{if } G \text{ is just a cycle;} \\ 4 \text{ or more} & \text{if there is a telescoping vertex of odd degree;} \\ \phi(G) & \text{otherwise.} \end{cases}$$

Theorem 1.3 allows us to characterize when a graph G with exactly one odd cycle has $g(G) = \phi(G)$. It also gives the following result which was conjectured by Khandhawit and Ye in [KY11, Conjecture 2].

Theorem 1.4. *Let G be a reduced and possibly disconnected graph containing one odd cycle and no other cycles or loops. Suppose that two or more vertices of the cycle have degree greater than 2. Then $g(G) = \phi(G)$.*

Most of the results in this paper build on those of Khandhawit and Ye in [KY11], such as for graphs with one odd cycle as already mentioned. In Sections 6 and 7 we find the nim-values of further families of graphs, some containing many odd cycles. The following two propositions show the importance of parity considerations and generalize results in [KY11, Appendix B].

Proposition 1.5. *If r odd cycles are attached at one vertex, as shown for example on the left of Figure 3, then the nim-value of this graph is 0 if r is odd and 1 if r is even.*

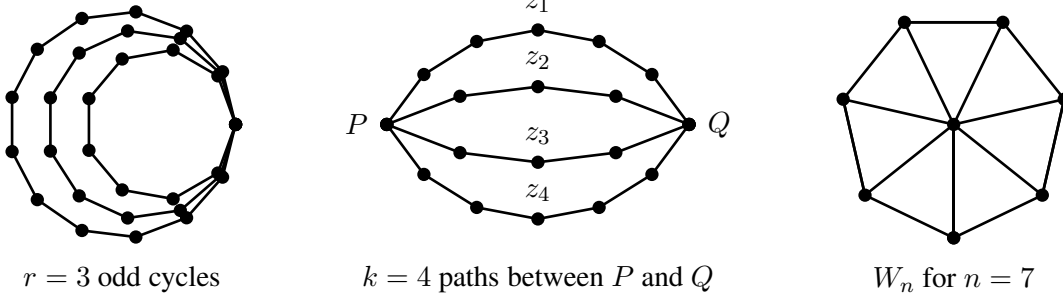

Figure 3: Some graph families

Proposition 1.6. *Let G be a graph consisting of k paths of positive lengths z_1, \dots, z_k linking vertices P and Q , as in the example in the middle of Figure 3. Set $Z := \sum_{i=1}^k z_k$. Then*

$$g(G) = \begin{cases} 0 & \text{if } k \text{ is even;} \\ 1 & \text{if } k \text{ is odd and } Z \text{ is even;} \\ 2 & \text{if } k \text{ is odd and } Z \text{ is odd.} \end{cases}$$

For $n \geq 3$ the *wheel graph* W_n is constructed by joining a central hub vertex to each vertex of the cycle graph C_n . These joining edges are called *spokes*. See Figure 3 for W_7 . In [KY11] they make an elegant conjecture about the nim-values of wheel graphs.

Conjecture 1.7. [KY11, Conjecture 3] *We have $g(W_n) = 1$ for all $n \geq 3$.*

They show with a symmetry argument that this conjecture is true for all n even and by a computation that it is true for $n = 3, 5, 7$. By combining symmetry arguments with a computer search we extend this range and prove in Theorem 8.1 that Conjecture 1.7 is true for $3 \leq n \leq 25$. We make further conjectures about the nim-values of subgraphs of W_n in Section 8.

We close this introduction by noting that there are other ways to play impartial games (i.e. with rules the same for both players) on undirected graphs, including achievement and avoidance games. We briefly mention three recent games on graphs that are similar to graph take-away, though they perhaps have less structure. In the *odd/odd vertex deletion game* players may only remove vertices of odd degree; see [NO05, Krü14]. With *graph nim*, as in for example [LC16], a player on their turn removes any positive number of edges incident to a single vertex. *Grim* is introduced in [ADE⁺16] and a player removes a vertex, all incident edges and any vertices that have become isolated. For these games, as usual, the first player unable to play loses.

2 Basic methods

We recall more of the theory of impartial games from, for example, [Con01, Chap. 11], [BCG01, Chap. 3]. The nim-value of a graph game may be calculated inductively as follows. The empty graph has value 0 and if a graph G has the subgraph options (moves) G_1, G_2, \dots, G_m for the first player then

$$g(G) = \text{mex}(\{g(G_1), g(G_2), \dots, g(G_m)\}) \quad (2.1)$$

where mex denotes the minimal non-negative integer excluded from the set.

If G is disconnected and equal to a disjoint union of n subgraphs H_1, \dots, H_n then

$$g(G) = g(H_1) \oplus \dots \oplus g(H_n) \quad (2.2)$$

where \oplus is the xor operation (binary addition without carry) and called nim-addition in this context. The general relation (2.2) follows from the $n = 2$ case of (2.2) which is straightforward to prove with (2.1). Let $N(r)$ be the set of nim-values of the possible moves of H_r with $m_r := \text{mex}(N(r))$. Set $M := m_1 \oplus \dots \oplus m_n$

and note that $M \oplus m_r$ is the same nim-sum with m_r removed. The *addition of games relation* we will need later is

$$M = \text{mex}(\{M \oplus m_r \oplus a \mid 1 \leq r \leq n, a \in N(r)\}) \quad (2.3)$$

and it is equivalent to (2.2).

In the case that G is a disjoint union of bipartite subgraphs H_1, \dots, H_n , then G is also bipartite and (2.2) becomes

$$\phi(G) = \phi(H_1) \oplus \dots \oplus \phi(H_n), \quad (2.4)$$

which is easy to verify directly.

For a non-bipartite example, we compute the nim-value of a triangle with an edge attached as shown in Figure 4. The nim-values of the possible moves are indicated. Removing the degree 3 vertex, for instance, leaves two trees and the resulting graph has nim-value $1 \oplus 2 = 3$. Moves with values 0, 1 and 2 are also possible. Hence the nim-value of this graph is 4.

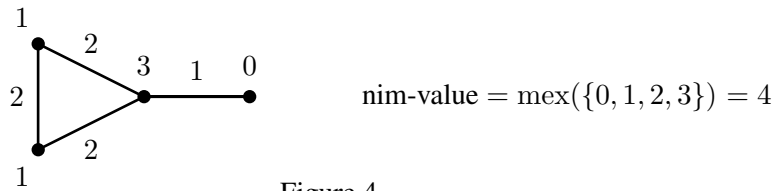

Figure 4

The symmetry argument we mentioned in the introduction is contained in the next lemma. It may be used to replace a graph game with a smaller one that has the same nim-value.

Lemma 2.1. (The symmetry lemma.) *Let $G = (V(G), E(G))$ be a graph and $\tau : G \rightarrow G$ an automorphism with the following properties:*

- (i) τ^2 is the identity,
- (ii) for all $v \in V(G)$ there is never an edge connecting v and $\tau(v)$.

Let G^τ be the subgraph of G on which τ acts as the identity. Then $g(G) = g(G^\tau)$.

Proof. Let H be a copy of G^τ and consider the game played on the disjoint union of G and H . The second player has the winning strategy of responding to any move in H with the same move in G^τ and vice versa. Any removal of vertices or edges outside of G^τ is answered by removing their image under τ . Hence $0 = g(G \cup H) = g(G) \oplus g(H)$ and the result follows. \square

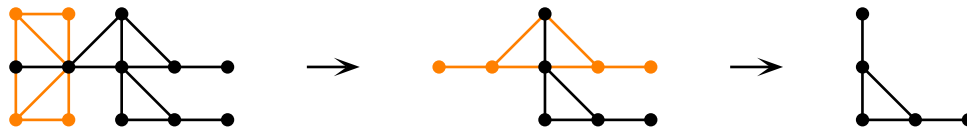

Figure 5: Using the symmetry lemma to simplify

Lemma 2.1 and its proof are based on a combination of [FS91, Lemma 3] and [KY11, Thm. 1]. This important principle of simplifying a game position using symmetry is also used in [FS91, Lemma 3] for hypergraphs, [KY11, Thm. 1] for simplicial complexes, and [FR15, Lemma 2.21], [BC17, Sect. 2.4] for posets.

An easy application of the symmetry lemma shows that a graph with two edges connecting a pair of vertices has the same nim-value when both edges are removed. So m edges between a pair of vertices (or m loops at a single vertex) simplify to a single edge if m is odd and no edge if m is even.

A second application of Lemma 2.1 leads to

$$g(K_n) = n_{(3)} \quad (2.5)$$

where K_n is the complete graph on n vertices. Removing a vertex of K_n gives K_{n-1} and removing an edge leaves K_{n-2} since we may take a τ in the symmetry lemma that switches the deleted edge's endpoints and fixes the remaining vertices. Then (2.5) follows using (2.1) and induction. A similar argument for the complete multipartite graph K_{n_1, n_2, \dots, n_r} shows

$$g(K_{n_1, n_2, \dots, n_r}) = \binom{n_1}{(2)} + \binom{n_2}{(2)} + \dots + \binom{n_r}{(2)} \binom{1}{(3)}. \quad (2.6)$$

Formula (2.5) was first proved as the main result in [GN82]. Formula (2.6) first appeared in [FS91]. We generalize (2.5) in Theorem 7.3 by adding loops to K_n .

Clearly the cancellation described in the introduction and pictured in Figure 1 is a special case of the symmetry lemma.

Definition 2.2. Recall that a graph is *reduced* if no further cancellations are possible. A graph is *simplified* if no further non-trivial applications of the symmetry lemma are possible.

As we have seen, simplified implies reduced. The next lemma shows that the reduced version of a graph is well-defined up to isomorphism.

Lemma 2.3. *Let G be a graph. Suppose G_1 and G_2 are graphs obtained by reducing G . Then G_1 and G_2 are isomorphic.*

Proof. We use induction on the number of vertices of G . The lemma is true in the base case of an empty graph. If G does not reduce then $G_1 = G_2 = G$. Otherwise, suppose G has a vertex s where cancellation is possible. Let there be a total of k isomorphic copies of H attached to s . Cancelling in pairs we obtain G' with all of the H s deleted if k is even and one copy left if k is odd. Now G_1 and G_2 must be subgraphs of G' if k is even - or else they are not simplified. If k is odd then we may say that G_1 and G_2 are isomorphic to subgraphs of G' . Replace G_1 and G_2 by these isomorphic subgraphs of G' for clarity. By induction, the lemma is true for G' and so G_1 and G_2 are isomorphic. \square

In the case of a tree, we claim that any application of the symmetry lemma must involve just cancellation. To see this, suppose a τ from that lemma maps vertex a to b for $a \neq b$. We use the notation $P(x, y)$ for the unique simple path on a tree connecting two vertices x and y . Then $\tau(P(a, b)) = P(a, b)$, since τ^2 is the identity, and $P(a, b)$ must have an even number of edges with the middle vertex r fixed by τ . In this way we see that the tree attached at r containing a cancels with the tree attached at r containing b . Any further vertices of the tree not fixed by τ will cancel in the same way. This proves the claim and shows that if a tree is reduced then it is simplified.

3 Telescoping vertices and cancellation

The graphs we study in Sections 3, 4 and 5 contain a single odd cycle and no further cycles or loops. In general, such a graph G consists of a cycle component, made up of a cycle with trees attached to its vertices, and a number of disconnected trees. It is easy to see that any application of the symmetry lemma to a graph with exactly one odd cycle must act as the identity on this cycle. It follows from this, and the discussion at the end of the last section, that G above is simplified if and only if it is reduced.

We next develop some properties of cancellation and telescoping that we will need. For a graph G containing a vertex v , let $G - v$ be the graph obtained by deleting v and all edges incident with v . Recall that cancellation occurs at a vertex s , say, when we have the situation in Figure 1.

Lemma 3.1. *Attach an odd cycle to a tree at vertex A and, from a vertex b in this tree, join another tree using the edge bv as shown in Figure 6. Let G_0 be this graph and assume it is reduced. Let G be the connected component of the cycle that remains when v is deleted. If cancellation is now possible in G at a vertex s then:*

- (i) *The vertex s is in $P(A, b) - b$.*

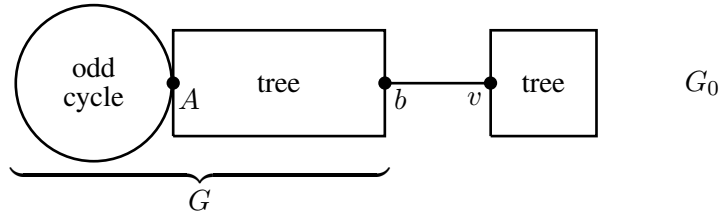

Figure 6

(ii) The vertex s is unique.

(iii) Cancellation at s can only remove vertices x which have the property that $P(A, x)$ contains s .

(iv) Suppose the cancellation at s is carried out. If another cancellation is now possible then it must occur at a unique vertex in $P(A, s) - s$.

Proof. Suppose the isomorphic subtrees H_1 and H_2 cancel in G at s , as seen in Figure 1, with G' being the graph that remains after cancellation. Note that H_1 and H_2 must each contain at least one vertex. We have $A \in G'$ since the cancellation at s corresponds to an automorphism from the symmetry lemma and A is fixed by any such automorphism. Part (iii) follows from this observation. We must have v adjacent to one of the vertices of H_1 or H_2 in G_0 since G_0 is reduced. Hence b is in H_1 or H_2 and this proves (i).

Without losing generality, assume that $b \in H_1$. Suppose G has cancellation at the vertex s' as well as s . Then $s' \in P(A, b) - b$ by part (i). We claim that s' cannot be a vertex of H_1 . Suppose $s' \in H_1$ and that $w \in H_2$ corresponds to s' under the isomorphism between H_1 and H_2 . Then cancellation at s' means that there is also cancellation at w . However this contradicts our requirement from part (i) that $w \in P(A, b) - b$ and so we have proved our claim. It follows that $s' \in G' \cap P(A, b) = P(A, s)$. Switching the roles of s and s' shows that $s \in P(A, s')$ as well. Consequently we must have $s = s'$, proving (ii).

Label G_1 the subgraph of G obtained by removing H_2 . Let $v_1 \in H_1$ be adjacent to s . Then replace G_0 by G_1 , v by v_1 , b by s and apply parts (i), (ii) to obtain (iv). \square

If an odd cycle has trees attached to a number of its vertices, then Lemma 3.1 applies to each of these trees separately. Since the odd cycle is fixed by the symmetry lemma, there can be no cancellation between trees attached at different vertices of the cycle.

Let G be a reduced graph consisting of an odd cycle attached to a tree at one point. Suppose G contains a telescoping vertex, so that deleting it gives a cycle component that may be reduced to the cycle in q cancellations. Label this vertex a_{q+1} . We next give a precise description of the structure of G .

The simplest case of $q = 0$ is displayed in Figure 7; removing a_1 disconnects the tree T_1 and only the cycle is left. For $q \geq 1$, Lemma 3.1 part (ii) implies the first cancellation after deleting a_{q+1} must

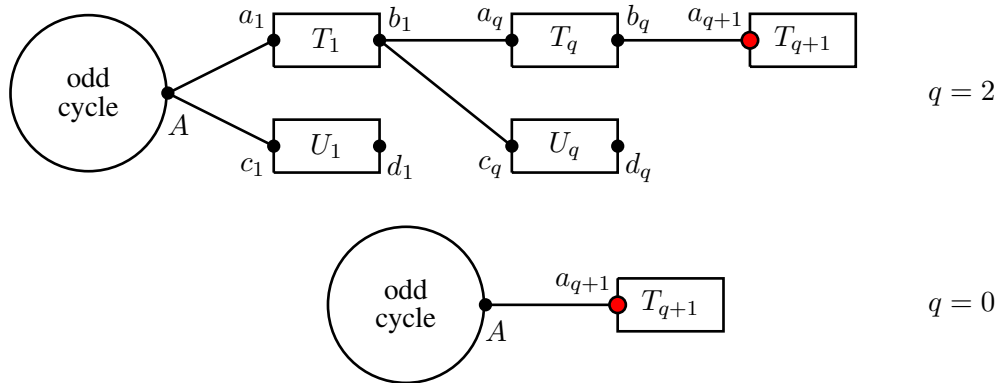

Figure 7: Graphs with telescoping vertices a_{q+1}

be at a unique vertex we label b_{q-1} with two isomorphic trees T_q and U_q cancelling as seen in Figure 7.

If further cancellation is possible then Lemma 3.1 part (iv) shows it must be at a unique vertex we label b_{q-2} . Continuing in this way we obtain the well-defined cancellation vertices $\{b_{q-1}, b_{q-2}, \dots, b_1, A\}$ and in particular the number q is well-defined.

We have shown that G must look like the graphs in Figure 7, where a_{q+1} is the telescoping vertex. For $1 \leq i \leq q$ the trees T_i and U_i are isomorphic with a_i corresponding to c_i and b_i corresponding to d_i . Note that these vertices may have large degrees. On the other hand, T_i may be a single vertex in which case a_i and b_i coincide (and then similarly for U_i). In this way we see that having a telescoping vertex can be a fairly complicated situation. It is straightforward, at least, to prove these necessary conditions.

Lemma 3.2. *Let G be a reduced graph consisting of an odd cycle attached at vertex A to a tree. Let the set of vertices of the tree a distance x from A be labelled S_x . Suppose G has a telescoping vertex $v \in S_d$ for $d \geq 1$. Then the following are true:*

- (i) *We have $\deg A \leq 4$ and $\deg A = 3$ if and only if $d = 1$.*
- (ii) *The numbers $|S_1|, |S_2|, \dots, |S_{d-1}|$ are even and $|S_d|$ is odd.*
- (iii) *The total degree of the vertices in $S_d - v$ is even.*

For G , as in Lemma 3.2, it follows from (ii) above that if there are any further telescoping vertices then they must also be in S_d . In fact we will show in the next section that telescoping vertices are unique. This requires some more definitions, notation and a couple of lemmas on subgraphs of isomorphic rooted trees.

Suppose T is a tree with root vertex r . We use the notation $T(r)$ for this rooted tree. For any vertex x of T we set $\rho_T(x)$ to be the subgraph of T induced by the set of vertices $\{v \in T : x \in P(r, v)\}$. Then $\rho_T(x)$ consists of x and everything in T on the other side of x from the root.

An isomorphism of rooted trees $\psi : T(r) \rightarrow U(s)$ is a graph isomorphism mapping T to U and r to s . For two vertices x, y in T , the distance between them is the length (number of edges) of $P(x, y)$. Clearly

$$\psi(P(x, y)) = P(\psi(x), \psi(y))$$

and so the isomorphism ψ preserves distance. We also have

$$\psi(\rho_T(x)) = \rho_U(\psi(x)).$$

Let C and T' be trees with C attached at q to T' . Recall this means that $C \cap T' = q$. Let $T = C \cup T'$ and choose a root for T . If this root is in T' then $C \subseteq \rho_T(q)$. There may be another tree C' attached at q so that $\rho_T(q) = C \cup C'$. Note that for any $v \in C - q$ we have $\rho_T(v) \subseteq C - q$.

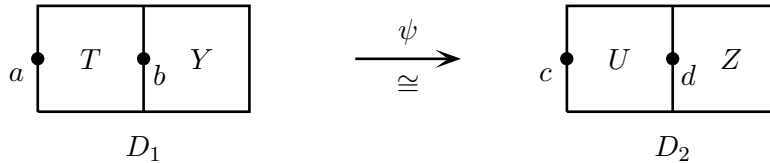

Figure 8

Lemma 3.3. *As shown in Figure 8, let T and Y be trees with $T \cap Y = b$ and set $D_1 := T \cup Y$. Let U and Z be trees with $U \cap Z = d$ and set $D_2 := U \cup Z$. Suppose $a \in T$ and $c \in U$. Let $\psi : D_1(a) \rightarrow D_2(c)$ be an isomorphism of rooted trees.*

If $|V(Z)| \geq |V(Y)|$ then there are three possibilities:

$$\psi(Y) \subseteq U - d, \quad \psi(Y) \subseteq Z - d \quad \text{or} \quad \psi(b) = d.$$

Proof. If $d \in \psi(Y - b)$ then $\psi^{-1}(d) \in Y - b$ and

$$\psi^{-1}(Z) \subseteq \psi^{-1}(\rho_{D_2}(d)) = \rho_{D_1}(\psi^{-1}(d)) \subseteq Y - b.$$

But this is not possible as $\psi^{-1}(Z)$ has too many vertices. Hence $d \notin \psi(Y - b)$. If $\psi(b) \neq d$ then $d \notin \psi(Y)$. Since $\psi(Y)$ is connected we obtain $\psi(Y) \subseteq U - d$ or $Z - d$ completing the proof. \square

Lemma 3.4. *As shown in Figure 8, let T and Y be trees with $T \cap Y = b$ and set $D_1 := T \cup Y$. Let U and Z be trees with $U \cap Z = d$ and set $D_2 := U \cup Z$. Suppose $a \in T$ and $c \in U$. Let $\psi : D_1(a) \rightarrow D_2(c)$ be an isomorphism of rooted trees.*

Let $\theta : T(a) \rightarrow U(c)$ also be an isomorphism of rooted trees, satisfying $\theta(b) = d$. Then $Y(b) \cong Z(d)$.

Proof. To make the proof clearer, relabel U as T and c, d as a, b respectively. In this way θ becomes the identity map and we have the situation in Figure 9. Note that we may have $a = b$. Since $|V(Y)| = |V(Z)|$,

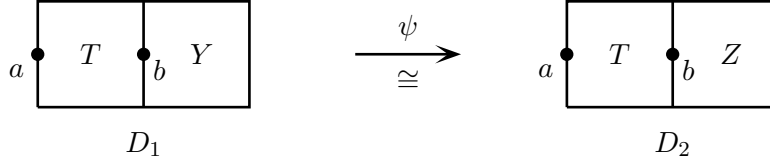

Figure 9

Lemma 3.3 implies that $\psi(Y) \subseteq T - b$, $\psi(Y) \subseteq Z - b$ or $\psi(b) = b$. It cannot be true that $\psi(Y) \subseteq Z - b$ as Y is too large. We claim that $\psi(b) = b$ implies that $Y(b) \cong Z(b)$, proving the lemma directly. To see this, let $Y' := \rho_T(b)$. Then $\rho_{D_1}(b) = Y \cup Y'$ and the claim follows from

$$\psi(Y \cup Y') = \psi(\rho_{D_1}(b)) = \rho_{D_2}(b) = Y' \cup Z.$$

This also proves the lemma when $a = b$ since this implies $\psi(b) = b$.

We may therefore assume that $Y_2 := \psi(Y) \subseteq T - b$. Let $b_2 := \psi(b)$. Considering Y_2 as a subgraph of D_1 we may apply ψ again and either $\psi(Y_2) \subseteq T - b$ or $\psi(b_2) = b$. Repeat this, with $Y_{i+1} := \psi(Y_i)$ and $b_{i+1} = \psi(b_i)$ until $b_{n+1} = b$ for some integer n . This integer n must exist since the subgraphs Y_2, \dots, Y_n are disjoint in $T - b$. (Otherwise, if $Y_i \cap Y_j \neq \{b\}$ for i, j satisfying $2 \leq i < j \leq n$ then we may apply ψ^{1-i} to get $Y \cap Y_{j-i+1} \neq \{b\}$ which is not true.) It follows that b, b_2, \dots, b_n are distinct vertices in T .

Let $Y' := \rho_T(b)$ as before so that $\rho_{D_1}(b) = Y \cup Y'$. Put $Y'_2 := \psi(Y')$ and we claim that $Y'_2 \subseteq T - b$. Since $b_2 \in Y'_2$ and we know that $b_2 \in T - b$, the claim follows if we can show that $b \notin Y'_2$. We have

$$b \in Y'_2 \implies \psi(b_n) \in \psi(Y') \implies b_n \in Y'.$$

The distance from a of every vertex in $Y' - b$ is greater than the distance from a to b which equals the distance from a to b_n . Hence $b_n \in Y'$ implies $b_n = b$, a contradiction. This proves our claim.

Repeating this argument with $Y'_{i+1} := \psi(Y'_i)$, we find $Y'_i \subseteq T - b$ for $2 \leq i \leq n$ and

$$\rho_{D_1}(b_i) = Y_i \cup Y'_i \cong Y \cup Y' \quad \text{for} \quad 2 \leq i \leq n.$$

Then

$$Y \cup Y' \cong \psi(Y_n \cup Y'_n) = \psi(\rho_{D_1}(b_n)) = \rho_{D_2}(b) = Z \cup Y'.$$

Hence $Y \cup Y' \cong Z \cup Y'$ under an isomorphism that maps b to b . This completes the proof. \square

4 Uniqueness of telescoping vertices

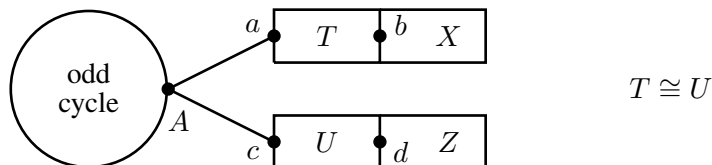

Figure 10: The graph G in Proposition 4.1

Proposition 4.1. *Suppose the tree T with root a is isomorphic to U with root c . Let the tree X be attached to T at b and the tree Z attached to U at the corresponding point d . Connect an odd cycle containing a vertex A to these trees by the edges Aa and Ac . Call this graph G , as seen in Figure 10, and assume that G is reduced. Then any telescoping vertex of G is in $X - b$ or $Z - d$.*

Proof. Recall from Lemma 3.1 that, if we remove a vertex v from the tree part of G , any cancellations that are then possible must occur at a sequence of distinct and uniquely defined vertices in $P(A, v) - v$ that each get closer to A .

Assume, without losing generality, that $|V(X)| \geq |V(Z)|$. We first claim that any $v \in U$ cannot be telescoping. Since the cancellations can only occur at points in U and at A , it is clear that a final cancellation at A will not be possible as there are too many vertices in $T \cup X$ to cancel those left from $U \cup Z$. This proves the claim.

Now we suppose that $v \in T$ is telescoping. Let e be the last vertex in T where cancellation occurs, or the remaining vertex adjacent to v if there is no cancellation in T . Then we may write $T = Y \cup W$ with $v \in Y$ and $Y \cap W = e$; see the left of Figure 11. After removing v and cancelling, we are left with W from T and, since v is telescoping, there is one further cancellation at A . Note that $P(a, b)$ must be contained in W or else there will be too few vertices to cancel with $U \cup Z$ at A . Since $U \cong T$, the following arguments become clearer if we relabel U as T and the vertices c, d as a, b respectively. The last cancellation at A requires an isomorphism θ from $D_1 := T \cup Z$ to D_2 , which is what remains of $T \cup X$, that fixes a . All of X will remain after the cancellation at e except possibly if $e = b$, so we examine this case first.

The case when $e = b$. Suppose the cancellation at b removes $Y - b$ from T as well as $Y' - b$ from X . (If $Y' = b$ then the cancellation at b does not affect X .) Write $X = Y' \cup X'$ with $Y' \cap X' = b$. So after the cancellation at b , $T \cup X$ becomes $W \cup X'$. Therefore we may write our isomorphism as $\theta : W \cup Y \cup Z \rightarrow W \cup X'$. By Lemma 3.4, $Y \cup Z$ and X' are isomorphic as trees rooted at b . This shows that there are two copies of Y attached to b in $T \cup X$ that may be cancelled. This contradicts G being reduced.

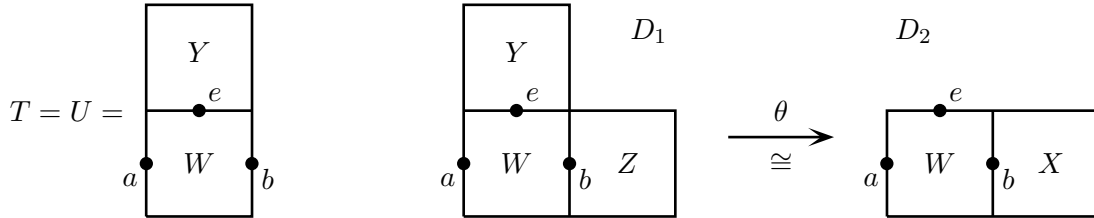

Figure 11

We may assume for the remainder that $e \neq b$. If $a = b$ then we have $\theta(b) = b$. As a consequence of this, X and Z are isomorphic as trees rooted at b which contradicts G being reduced. Hence we may also assume that $a \neq b$. It is possible that $a = e$.

The isomorphism θ from $D_1 := W \cup Y \cup Z$ to $D_2 := W \cup X$ is shown in Figure 11. Recall that $T \cup X = W \cup Y \cup X$. Roughly, our goal is to show that the existence of θ means that X contains a copy of Y , implying that $T \cup X$ has cancellation. This contradicts our assumption that G was reduced and rules out $v \in T$ being a telescoping vertex. In more detail, we seek adjacent vertices $x, r \in W$ so that $\theta(x) \neq x$ and $\theta(r) = r$. Set $T^* := \rho_{D_1}(x)$ which implies $\theta(T^*) = \rho_{D_2}(\theta(x))$. We also require

$$\rho_{D_1}(x) \subseteq Y \cup (W - b), \quad (4.1)$$

$$\rho_{D_2}(\theta(x)) \subseteq X \cup (W - e). \quad (4.2)$$

Then (4.1) and (4.2) imply that $T^* = \rho_{T \cup X}(x)$ and $\theta(T^*) = \rho_{T \cup X}(\theta(x))$. If

$$T^* \cap \theta(T^*) = \{\} \quad (4.3)$$

then it follows that we have cancellation at r in $T \cup X$, giving our desired contradiction. In fact it is easy to see that (4.3) holds since otherwise there would be more than one path between x and $\theta(x)$. If $e \in T^*$ then (4.3) implies (4.2).

By Lemma 3.3 we know that $\theta(Z) \subseteq W - b$, $\theta(Z) \subseteq X - b$ or $\theta(b) = b$. As we saw earlier, $\theta(b) = b$ may be ruled out. If $\theta(Z) \subseteq X - b$ then $\theta(b) \in X - b$ and so the distance from a to b must increase under θ which is not possible. Therefore $\theta(Z) \subseteq W - b$ and we set $b_2 := \theta(b)$. We may consider $Z_2 \subseteq W - b$ as a subgraph of D_1 and apply θ again. As in the proof of Lemma 3.4, there exists $n \geq 2$ so that we obtain $Z_i \subseteq W - b$ for $2 \leq i \leq n$ where $Z_{i+1} := \theta(Z_i)$, $b_{i+1} = \theta(b_i)$ and $b_{n+1} = b$. We have that $Z_1 := Z$, Z_2, \dots, Z_n are all disjoint as subgraphs of D_1 and $b_1 := b, b_2, \dots, b_n$ are all distinct in W .

Let $Z' = Z'_1 := \rho_{W \cup Y}(b)$ so that

$$\rho_{D_1}(b) = Z \cup Z'.$$

As in the proof of Lemma 3.4 for Y'_i , we have $Z'_i \subseteq W - b$ for $2 \leq i \leq n$ where $Z'_{i+1} := \theta(Z'_i)$. Suppose e is never a vertex of $Z_i \cup Z'_i$ for $1 \leq i \leq n$. Then

$$\rho_{D_1}(b_i) = Z_i \cup Z'_i \cong Z \cup Z' \quad \text{for } 1 \leq i \leq n.$$

This being the case, we have

$$X \cup Z' \cong \rho_{D_2}(b) = \theta(\rho_{D_1}(b_n)) \cong Z \cup Z'$$

and so $X \cong Z$ as trees rooted at b . However this contradicts G being reduced and so we must have $e \in Z_k \cup Z'_k$ for some k in the range $1 \leq k \leq n$.

The case when $e \in Z_1 \cup Z'_1$. Clearly, $e \notin Z_1$ so assume that $e \in Z'_1$. Let $R := \rho_W(b)$ so that $Z'_1 = R \cup Y$ with $R \cap Y = e$. By applying θ n times to $\rho_{D_1}(b)$ we obtain

$$R \cup Y \cup Z \cong R \cup X \tag{4.4}$$

as trees rooted at b . Then $P(b, e) \subseteq R$ and we let x be the vertex adjacent to b in $P(b, e)$. Put $R_1 := bx \cup \rho_W(x) \subseteq R$. This makes R_1 the tree in W containing e that is attached to b by a single edge. A short argument using (4.4) shows that X must contain a copy of $R_1 \cup Y$. In other words $X = R_1 \cup Y \cup X_1$ with $(R_1 \cup Y) \cap X_1 = b$. We have $\rho_{T \cup X}(b) = R \cup Y \cup X$ which means there are two copies of $R_1 \cup Y$ attached to b in $T \cup X$. So in this case we have cancellation at b in G , contradicting our assumption that G was reduced.

It remains to suppose that $e \in Z_k \cup Z'_k$ only for k in the range $2 \leq k \leq n$. We choose the minimal such k . Then

$$\rho_{D_1}(b_k) = Y \cup Z_k \cup Z'_k.$$

The distinct vertices b_1, \dots, b_n are in W and so $P(a, b_1), \dots, P(a, b_n)$ are in W with

$$\theta(P(a, b_i)) = P(a, b_{i+1}) \quad \text{for } 1 \leq i \leq n.$$

Write $P(a, b_1) \cap P(a, b_2)$ as $P(a, r)$ so that $\theta(r) = r$. Then $P(a, r) \subseteq P(a, b_i)$ for $1 \leq i \leq n$. Now let x be the vertex in $P(r, b_k)$ adjacent to r . Put $T^* := \rho_{D_1}(x)$ and we claim that $T^* \subseteq Y \cup (W - b)$. If $b \in T^*$ then there is a path from b_k to b in T^* that does not pass through r . But this is not possible as the path $P(b_k, r) \cup P(r, b)$ does pass through r . Since T^* is connected and contains a vertex b_k in $W - b$, we have proved the claim and so (4.1) holds. By construction we have $e \in T^*$, giving (4.2) by (4.3). As discussed there, these conditions prove that G has cancellation at r giving a contradiction that implies $v \in T$ cannot be a telescoping vertex. \square

Proposition 4.1 is next extended to cases with more cancellation.

Proposition 4.2. *For $i = 1, 2, \dots, q$, let the trees T_i and U_i be isomorphic with vertices $a_i, b_i \in T_i$ corresponding to $c_i, d_i \in U_i$ respectively. Include edges $b_i a_{i+1}$ and $b_i c_{i+1}$ for $i = 1, 2, \dots, q - 1$. Let an odd cycle containing the vertex A be connected with edges Aa_1 and Ac_1 . Attach the tree X at b_q and the tree Z at d_q . The left of Figure 12 shows the $q = 2$ case of this construction. Call this graph G and assume it is reduced with a telescoping vertex t .*

Then the following are true:

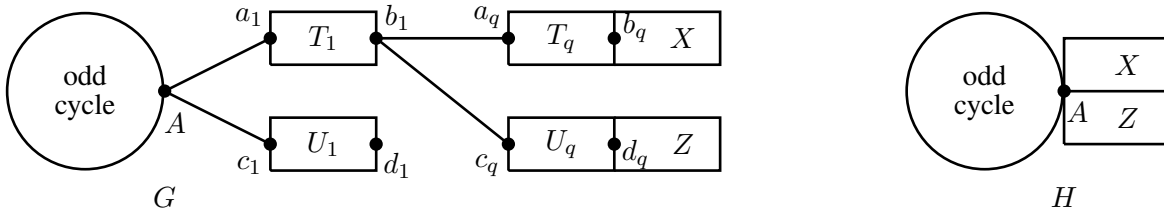

Figure 12

- (i) The vertex t is in $X - b_q$ or $Z - d_q$.
- (ii) Make a new graph H from G by removing all the trees T_i, U_i and identifying the vertices A, b_q, d_q as displayed on the right of Figure 12. Then t is a telescoping vertex for H .

Proof. We use induction on q to prove (i). The $q = 1$ case is covered by Proposition 4.1 so assume $q \geq 2$. Proposition 4.1 implies that t is not in T_1 or U_1 . Suppose that the first cancellation after t is removed happens at s_m , the next at s_{m-1} and the last at $s_0 = A$. By Lemma 3.1, we know that every s_i is in $P(A, t) - t$. The last cancellation before A is at s_1 . We cannot have s_1 in $T_1 - b_1$ as there will be too few vertices remaining to cancel with U_1 at A . If s_1 is not in T_1 then there will be too many vertices remaining to cancel with U_1 at A . Therefore $s_1 = b_1$. Let G^* be G with T_1, U_1 removed and b_1 identified with A . Induction now shows that t is in $X - b_q$ or $Z - d_q$.

We next show (ii). Repeating the above argument that $s_1 = b_1$ also shows that $s_2 = b_2, \dots, s_{q-1} = b_{q-1}$. Assume $|V(X)| \geq |V(Z)|$ and, as at the beginning of the proof of Proposition 4.1, this implies that $t \in X - b_q$ and also that the cancellation before $s_{q-1} = b_{q-1}$ (or before A if $q = 1$) occurs at vertices in $X - b_q$. Suppose the last cancellation before b_{q-1} is at the vertex $s \in X - b_q$. We may write $X = Y \cup X'$ for $Y \cap X' = s$ so that the cancellation at s removes $X' - s$. To cancel at b_{q-1} we must have $U_q \cup Z$ isomorphic to $T_q \cup Y$ as trees rooted at c_q and a_q respectively. Then Lemma 3.4 implies that Y rooted at b_q is isomorphic to Z rooted at d_q . It follows that t is a telescoping vertex for H . \square

We will need Proposition 4.2 to prove Proposition 5.3 in the next section. It also allows us to prove the goal of this section:

Corollary 4.3. *Let G be a reduced graph consisting of a tree attached to an odd cycle at one vertex. Then G has at most one telescoping vertex.*

Proof. Suppose G has at least one telescoping vertex. We may describe G as in Figure 7 and its related discussion, with telescoping vertex a_{q+1} . By Proposition 4.2 part (i), applied with $X = b_q a_{q+1} \cup T_{q+1}$ and $Z = d_q$, any telescoping vertex t of G must be in T_{q+1} . Lemma 3.2 part (ii) implies that t must be the same distance from A as a_{q+1} . Hence $t = a_{q+1}$. \square

5 Nim-values of graphs with one odd cycle

The following result is Theorem 4 of [KY11]. We reproduce their proof in a slightly shorter form.

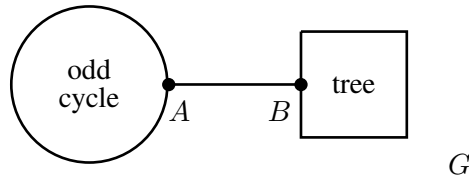

Figure 13

Theorem 5.1. *Let G be an odd cycle connected to a tree by an edge AB as shown in Figure 13. Then*

$$g(G) = \begin{cases} 4 \text{ or more} & \text{if } B \text{ has odd degree;} \\ \phi(G) & \text{otherwise.} \end{cases}$$

Proof. Let n be the number of vertices and edges of G outside the cycle. The proof uses induction on n and the base case with $n = 2$ may be easily verified. The following cases establish our argument.

Case (i). Suppose the degree of B is odd. Removing a degree 2 vertex or an edge from the cycle gives trees with nim-values 1 and 2. Removing vertices A and B gives nim-values 0 and 3. It follows that the nim-value of G is greater than 3.

Case (ii). Suppose the degree of B is even. We have $\phi(G) = 0$ or 3 and want to show that this equals the nim-value of G . Removing a degree 2 vertex or an edge from the cycle gives trees with nim-values 1 and 2. Removing B or the edge AB also yields nim-values 1 or 2. Deleting A gives nim-value 3 if $\phi(G) = 0$ and nim-value 0 if $\phi(G) = 3$. To complete the proof it remains to show that no other move H gives nim-value $\phi(G)$. By the induction hypothesis $g(H) \geq 4$ or $g(H) = \phi(H)$ and clearly $\phi(H) \neq \phi(G)$. \square

Theorem 1.3 will generalize Theorem 5.1. It requires the next definition and proposition.

Definition 5.2. For trees X and Z , we call the tree constructed in the statement of Proposition 4.2 an (X, Z) tree of level $q \geq 1$. If X or Z is just a single vertex then we may replace them by \bullet in the notation.

Proposition 5.3. Let G be a reduced graph consisting of an odd cycle connected at vertex A to a tree. Suppose A has even degree at least 4. Then there exists an odd degree vertex of the tree that is not telescoping and so that removing it and reducing produces a subgraph with no telescoping vertices of odd degree.

Proof. As in Lemma 3.2, label the set of vertices of the tree a distance x from A as S_x . Let ℓ be the largest x for which $|S_x| > 0$. In other words, ℓ is the height of the tree rooted at A . We use induction on ℓ . Since G is reduced, the base case has $\ell = 2$ with the tree in G consisting of paths of length 1 and 2 attached to A . The proposition is clearly true in this case. Now assume $\ell \geq 3$.

For some d with $2 \leq d \leq \ell$, suppose that the numbers $|S_1|, |S_2|, \dots, |S_{d-1}|$ are even and $|S_d|$ is odd. Then the total degree of the vertices in S_{d-1} is odd and hence there exists a vertex $t \in S_{d-1}$ of odd degree. Remove vertex t and reduce. Note that $t \notin S_d$ and so cannot be telescoping by Lemma 3.2 part (ii). Also from Lemma 3.2 part (ii), if the resulting graph has a telescoping vertex v then it must be one of the remaining vertices in $S_{d-1} - t$. But it cannot be a telescoping vertex of odd degree since that would contradict Lemma 3.2 part (iii) which says that the total degree of $(S_{d-1} - t) - v$ is even. Therefore, t is the desired vertex.

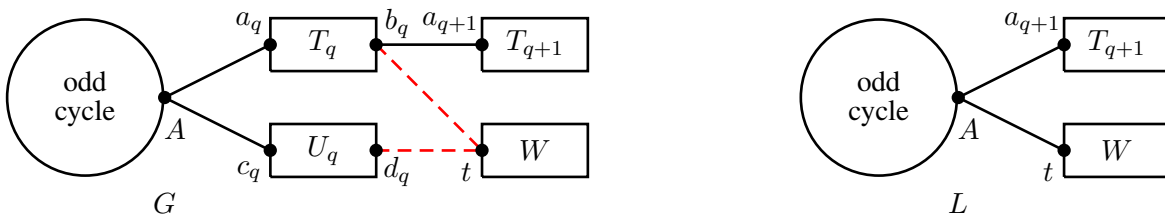

Figure 14

Otherwise, $|S_1|, |S_2|, \dots, |S_\ell|$ are all even, as we now assume. Remove an odd degree vertex t in S_m for some m with $3 \leq m \leq \ell$. For example t could be a leaf. After removing t suppose there are $p \geq 0$ cancellations to obtain the reduced graph H . In general t is contained in the subgraph $W := \rho_G(t)$ so that $W - t$ becomes disconnected from the cycle component H . Note that t cannot be telescoping by Lemma 3.2 part (ii). If H has no telescoping vertices of odd degree then we are done. Otherwise, the telescoping vertex is in S_m by Lemma 3.2 part (ii). We see that H must take the form shown in Figure 7 with $q \geq 1$ since $m > 1$. The telescoping vertex is labelled as a_{q+1} with odd degree.

The degrees of vertices b_q and d_q in that figure must have opposite parity in H . They will have opposite parity in G as well unless $p = 0$ and t is connected by an edge to one of b_q or d_q . This is illustrated on the left of Figure 14, in the case of $q = 1$, with dashes denoting the possible edges. We need to examine this situation in detail.

The case when t is attached to b_q or d_q . We find a vertex r satisfying the proposition in this case. Consider the graph L on the right of Figure 14. It is obtained from G by removing T_i, U_i for $1 \leq i \leq q$ and adding the edges Aa_{q+1} and At . Then L is reduced since G is. By induction, L has an odd degree vertex r of the tree that is not telescoping, and so that removing it and reducing produces a subgraph L' with no telescoping vertices of odd degree. Let X be what remains of $Aa_{q+1} \cup T_{q+1}$ after this reduction and Z be what remains of $At \cup W$. Then $L' = X \cup Z$. If $r \in T_{q+1}$ then all the cancellation is in T_{q+1} and $Z = At \cup W$. Similarly, if $r \in W$ then all the cancellation is in W and $X = Aa_{q+1} \cup T_{q+1}$.

Now we remove the same vertex r from G . The initial cancellations in G after removing r will be the same as those that produced L' and we carry them out in G to obtain G' . Depending on where t is connected, the tree part of G' is an $(X \cup Z, \bullet)$ graph or an (X, Z) graph. If G' is a reduced graph then it follows from Proposition 4.2 part (ii) that if G' has a telescoping vertex then so does L' and it must be the same vertex. Therefore L' having no telescoping vertices of odd degree implies that G' does not have them either and so r is the desired vertex in this case.

However, it may be the case that further cancellation is possible in G' . This cancellation must be at vertices in $P(A, r)$, though not at the vertex A since r is not telescoping by Proposition 4.2 part (ii). Assume, without losing generality, that $r \in T_{q+1}$ so that any cancellation happens in T_1, \dots, T_q . Suppose that after cancellation in T_{q+1} the next cancellation is at $s \in T_m$. If $s \neq b_m$, then as shown

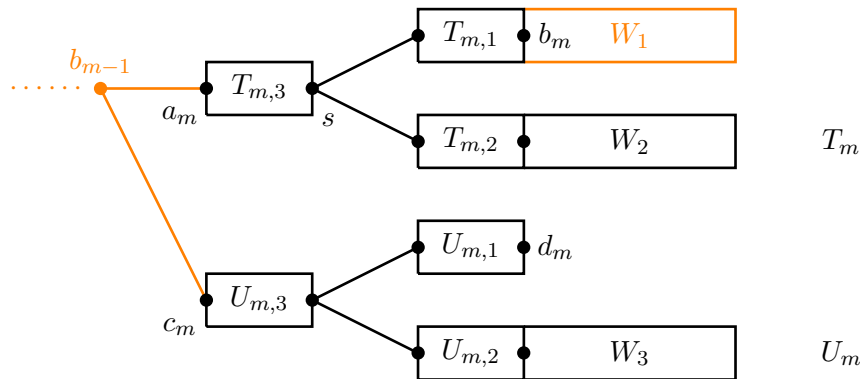

Figure 15

in Figure 15, T_m contains the parts $T_{m,1}$ and $T_{m,2}$, which will cancel, and $T_{m,3}$ which contains s . Suppose that $b_m \in T_{m,1}$. Let W_1 be the part of G' attached to b_m containing $T_{m+1}, U_{m+1}, \dots, X, Z$. Then W_1 is an $(X \cup Z, \bullet)$ graph or an (X, Z) graph. For cancellation at s , T_m must also contain W_2 which is isomorphic to W_1 and attached to $T_{m,2}$ in the same way. Now $U_m \cong T_m$ and so has the same components $U_{m,1}, U_{m,2}, U_{m,3}$ and W_3 with $d_m \in U_{m,1}$ and $W_3 \cong W_1$ attached to $U_{m,2}$. Therefore we see that after cancellation at s we obtain a graph whose tree part is still an $(X \cup Z, \bullet)$ graph or an (X, Z) graph. Similar reasoning gives the same conclusion when $s = b_m$.

Repeating this argument shows that the reduced version, G^* , of G' is still an $(X \cup Z, \bullet)$ graph or an (X, Z) graph. By Proposition 4.2, any telescoping vertex of G^* must be in X or Z and a telescoping vertex for L' . Therefore L' having no telescoping vertices of odd degree implies that G^* does not have them either and so r is the desired vertex as before.

Returning to our main argument, we are left with the situation that one of b_q and d_q has odd degree in G . We have proved that there are three alternatives: the original odd degree vertex $t \in S_m$ we chose satisfies the proposition, the vertex r does, or else there exists a new odd degree vertex in S_{m-1} , one unit closer to A .

Repeating this reasoning, we eventually find a vertex satisfying the proposition or else we find an odd degree vertex t in S_2 so that removing t and reducing (with p cancellations) produces a graph H with an odd degree telescoping vertex $a_2 \in S_2$ (the number of cancellations in H is necessarily $q = 1$ and in our notation we have $a_1 = b_1$ and $c_1 = d_1$). Since $t \in S_2$, the only options for p are 0 and 1. If $p = 1$ then we have the situation in Figure 16 with $\deg A = 6$. Then S_1 contains four vertices and two have odd degree. Deleting

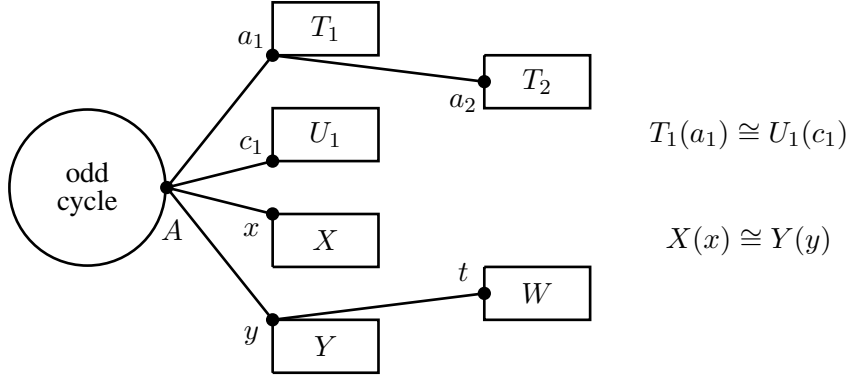

Figure 16

one of these odd degree vertices leaves a reduced graph where $\deg A = 5$. It follows from part (i) of Lemma 3.2 that this graph does not have a telescoping vertex. This completes the $p = 1$ case.

Lastly, when $p = 0$ we necessarily have t adjacent to b_1 or d_1 . This is the highlighted case we covered earlier in the proof, and the argument there shows that the desired vertex r may be found by induction. \square

Proof of Theorem 1.3. Let n be the number of vertices and edges of G outside the cycle. The proof uses induction on n and the base case with $n = 0$ is clearly true. Assume $n \geq 1$ and let A be the vertex on the cycle with degree greater than 2. If $\deg A = 3$ then denote by B its adjacent vertex in the tree. Clearly B is a telescoping vertex for G and, with Lemma 3.2 part (ii) or Corollary 4.3, it is the only one. The result then follows from Theorem 5.1. Hence we may assume that A has degree at least 4.

Case (i). Suppose G contains a telescoping vertex of odd degree. Removing a degree 2 vertex or an edge from the cycle gives trees with nim-values 1 and 2. Removing the telescoping vertex leaves a graph H , consisting of a cycle component and a disconnected forest, and with $\phi(H) = 3 \oplus \phi(G)$ because we removed a vertex of odd degree. Since the cycle component has $\phi = 3$ and $g = 0$ it follows that $g(H) = \phi(G)$ which is 0 or 3. Next we note that $\deg A = 4$ by Lemma 3.2 part (i). Proposition 5.3 then implies there exists an odd degree vertex in the tree part of G so that deleting it and reducing gives a graph H' that does not contain a telescoping vertex of odd degree and in which $\deg A \geq 3$. By induction $g(H') = \phi(H')$ and so this move gives the fourth element of the set $\{0, 1, 2, 3\}$. Therefore the nim-value of G is at least 4.

Case (ii). Suppose G does not contain a telescoping vertex of odd degree. We have $\phi(G) = 0$ or 3 and want to show that this equals the nim-value of G . Removing a degree 2 vertex or an edge from the cycle gives trees with nim-values 1 and 2. Deleting any vertex or edge from the tree part of G and reducing gives a graph H in which $\deg A \geq 3$ and that by induction has nim-value $\phi(H)$ or at least 4. If $\phi(G) = 0$ then it follows that all moves have nim-value $\neq 0$ and so $g(G) = 0$. If $\phi(G) = 3$ then it follows that all moves have nim-value $\neq 3$. To show that $g(G) = 3$ it remains to find a move with nim-value 0. If A has odd degree then removing it is such a move. If A is even then Proposition 5.3 implies there exists an odd degree vertex in the tree part of G so that deleting it and reducing gives a graph H' that does not contain a telescoping vertex of odd degree and in which $\deg A \geq 3$. By induction $g(H') = \phi(H')$ and so we have located the required nim-value 0 move. \square

We may now prove Theorem 1.4, as conjectured in [KY11].

Proof of Theorem 1.4. In general, the graph G consists of trees attached to an odd cycle and possibly a number of other disjoint trees. Let n be the number of vertices and edges of G that are not on the cycle. The proof uses induction on n and the base case with $n = 4$ is easy to verify. If $g(G) = \phi(G)$ then, with Proposition 1.1 and (2.4), we obtain the same relation if we add disjoint trees to G . Hence we may assume that G is connected. Then $\phi(G) = 0$ or 3 and want to show that this equals the nim-value of G . The following cases establish the argument.

Case (i). Suppose $\phi(G) = 0$. This corresponds to n being odd. Removing a vertex or edge from the cycle leaves a non-zero nim-value by Proposition 1.1. Removing a vertex or edge not on the cycle and reducing leaves a graph H where m vertices of the cycle have degree greater than 2 for $m \geq 1$. (There cannot be any cancellation between trees attached to different vertices of the cycle; see the discussion after Lemma 3.1.) If $m \geq 2$ then $g(H) = \phi(H)$ by induction. If $m = 1$ then $g(H) = \phi(H)$ or $g(H) \geq 4$ by Theorem 1.3. In either case $g(H) \neq 0$ and so $g(G) = 0$.

Case (ii). Suppose $\phi(G) = 3$. This corresponds to n being even. Similar arguments to Case (i) show that all moves of G have nim-value $\neq 3$. It remains to show that moves with nim-values 0, 1 and 2 exist. Removing an edge of the cycle gives nim-value 1. Deleting an odd degree vertex on the cycle gives nim-value 0 and deleting an even degree vertex on the cycle gives nim-value 2. If all the cycle vertices have odd degree then there must exist an even degree vertex in the rest of G (since G has an odd number of vertices) and removing it gives nim-value 2 by induction. In the last case to consider, all the cycle vertices have even degree and we need to locate a move with nim-value 0. Choose a cycle vertex A with even degree at least 4. Proposition 5.3 implies there exists an odd degree vertex in the tree attached to A so that deleting it and reducing gives a graph H' in which $\deg A \geq 3$. By induction $g(H') = \phi(H')$ and this provides the nim-value 0 move we wanted. \square

Corollary 5.4. *Let G be a reduced, possibly disconnected graph containing one odd cycle and no other cycles or loops. Then $g(G) \neq \phi(G)$ if and only if one of these conditions is true:*

- (i) *all of the cycle vertices have degree 2 or*
- (ii) *exactly one of the cycle vertices has degree greater than 2 and there exists a telescoping vertex of odd degree.*

The results we have proved in this section are for graphs with exactly one odd cycle and no even cycles or loops. It is natural to also ask what happens when we allow even cycles or if we replace the odd cycle with a loop.

6 Unbounded nim-values

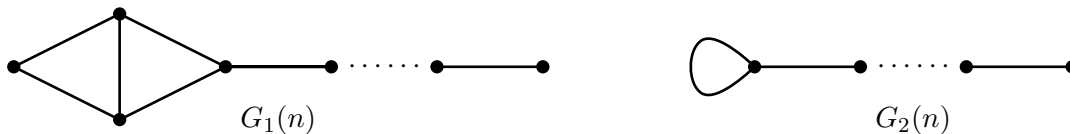

Figure 17

All the graphs we have encountered so far have had quite small nim-values. In [FS91] the authors conjectured that the nim-values of graph games are unbounded. This was demonstrated in [DT96] with the family of graphs $G_1(n)$ on n vertices in Figure 17. Let

$$\lambda(k) := \begin{cases} 2m, & \text{if } k = 3m + 0; \\ 2m + 1, & \text{if } k = 3m + 1; \\ 2m, & \text{if } k = 3m + 2. \end{cases}$$

So the first few values of λ , starting with $\lambda(0)$, are 0, 1, 0, 2, 3, 2, 4, 5, 4, \dots . Then an induction argument shows that

$$g(G_1(n)) = 2 \cdot \lambda(n - 3) \quad \text{for } n \geq 4.$$

The family $G_2(n)$ on n vertices in Figure 17 is just a path with a loop at the end. A similar proof shows

$$g(G_2(n)) = 2 \cdot \lambda(n) \quad \text{for } n \geq 0.$$

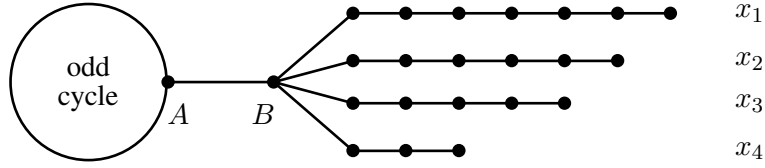

Figure 18: An example of R_{x_1, x_2, \dots, x_n} with $n = 4$

The next result generalizes Theorem 5 of [KY11] and demonstrates that the nim-values of “4 or more” from the statements of Theorems 1.3 and 5.1 may become arbitrarily large.

Define the family of graphs R_{x_1, x_2, \dots, x_n} for positive integers x_1, \dots, x_n as follows. They consist of an edge AB with an odd cycle attached to A and n paths of lengths x_1, \dots, x_n attached to B as in Figure 18.

Set $\ell(x) := 2 \cdot \lambda(x - 1)$. The first few values of ℓ , starting with $\ell(1)$, are 0, 2, 0, 4, 6, 4, 8, 10, 8, \dots

Theorem 6.1. *We have*

$$g(R_{x_1, x_2, \dots, x_n}) = \begin{cases} \phi(R_{x_1, x_2, \dots, x_n}) & \text{if } n \text{ is odd;} \\ \ell(x_1) \oplus \dots \oplus \ell(x_n) + 4 & \text{if } n \text{ is even.} \end{cases}$$

Proof. Set $L := \ell(x_1) \oplus \dots \oplus \ell(x_n)$ and the same nim sum with $\ell(x_r)$ removed is $L \oplus \ell(x_r)$. Let $X := x_1 + \dots + x_n$. For $n = X = 0$ we understand the empty nim-sum L is 0. To compute $g(R_{x_1, x_2, \dots, x_n})$ we look at all possible moves and use induction on X . The base case with $n = X = 0$ has nim-value 4 by Theorem 5.1. When n is odd the result also follows from Theorem 5.1, so we may assume n is even.

From the cycle and vertices A and B we obtain moves with nim-values 0, 1, 2 and 3. The only possible nim-values outside of these come from removing vertices and edges from the n paths giving:

$$\begin{aligned} & L \oplus \ell(x_r) \oplus \ell(x_r - 1) + 4, \\ & (L \oplus \ell(x_r) \oplus \ell(x_r - 1) + 4) \oplus 1, \\ & (L \oplus \ell(x_r) \oplus \ell(i) + 4) \oplus 1, \\ & (L \oplus \ell(x_r) \oplus \ell(i) + 4) \oplus 2 \end{aligned}$$

for all r, i satisfying $1 \leq r \leq n$ and $1 \leq i \leq x_r - 2$. Noting that $(a + 4) \oplus b = (a \oplus b) + 4$ for $b = 1, 2$ we obtain

$$g(R_{x_1, x_2, \dots, x_n}) = 4 + \text{mex} \left(\left\{ L \oplus \ell(x_r) \oplus \ell(x_r - 1) \oplus (b - 1), L \oplus \ell(x_r) \oplus \ell(i) \oplus b \right\} \right) \quad (6.1)$$

where $1 \leq r \leq n$, $1 \leq i \leq x_r - 2$ and $b = 1, 2$. To compute this, let

$$E(k) := \left\{ \ell(k - 1), \ell(k - 1) \oplus 1 \right\} \cup \left\{ \ell(i) \oplus 1, \ell(i) \oplus 2 \mid 1 \leq i \leq k - 2 \right\}.$$

It is straightforward to prove that, for all positive integers k ,

$$\ell(k) = \text{mex}(E(k)). \quad (6.2)$$

We may rewrite (6.1) as

$$g(R_{x_1, x_2, \dots, x_n}) = 4 + \text{mex} \left(\left\{ L \oplus \ell(x_r) \oplus a \right\} \right) \quad (6.3)$$

where $1 \leq r \leq n$ and $a \in E(x_r)$. It follows from (6.2), (6.3) and the addition of games relation (2.3) that $g(R_{x_1, x_2, \dots, x_n}) = 4 + L$ as desired. \square

Suppose we fix each x_i in R_{x_1, x_2, \dots, x_n} except for x_1 say, and let $k = x_1$ increase. By Theorem 6.1, the sequence of nim-values $g_k := g(R_{k, x_2, \dots, x_n})$ will be 0, 3, 0, 3, 0, 3, 0, 3, \dots if n is odd and $\ell(k) \oplus r + 4$, for some even number $r \geq 0$, if n is even (since the image of ℓ is the set of all even numbers). Khandhawit and Ye investigated what happens in general when a path of length k , a tree and an odd cycle are attached together as in Figure 19. They found two types of behavior for the sequence of nim-values g_k for large k ; see Table 6 of [KY11]. We see there is also a third type of behavior (which invalidates their [KY11, Conjecture 1]) given in (iii) next. In the examples we have computed, the sequence g_1, g_2, g_3, \dots eventually matches one of the following three sequences:

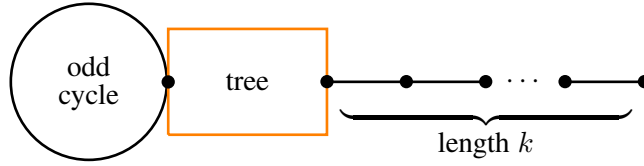

Figure 19

- (i) $\ell(1) \oplus r + 4, \ell(2) \oplus r + 4, \ell(3) \oplus r + 4, \dots$ for some fixed $r \geq 0$,
- (ii) the period 2 sequence $4m, 4m + 3, 4m, 4m + 3, \dots$ for some fixed m
- (iii) or the period 2 sequence $4m + 1, 4m + 2, 4m + 1, 4m + 2, \dots$ for some fixed m .

An instance of (iii) is shown for the family $H_{1,k}$ in Figure 20. The family $H_{2,k}$ in that figure shows that r in (i) may be odd as the sequence is $g_k = \ell(k) \oplus 3 + 4$ for $k \geq 13$. The examples in Figure 20 also confirm Theorem 1.3; we see the highlighted vertices in $H_{1,k}$ and $H_{2,k}$ are odd degree telescoping vertices and the nim-values of these graphs are 4 or more. By comparison, $H_{3,k}$ is similar to $H_{2,k}$ but does not have a telescoping vertex and its nim-values are $\phi(H_{3,k})$.

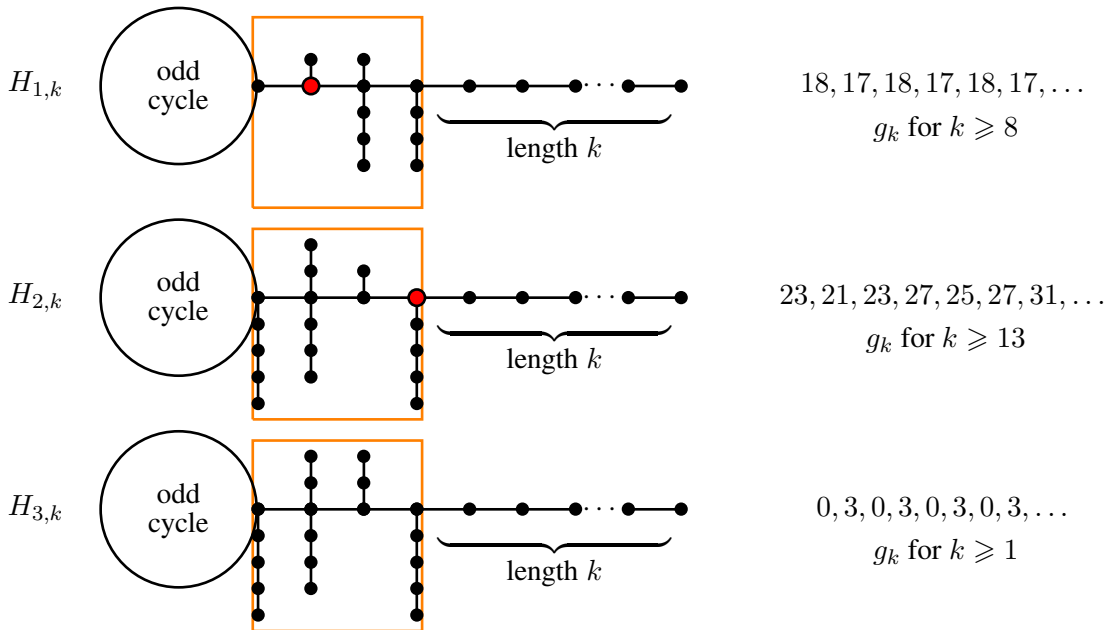

Figure 20: Examples of nim-value sequences

Are any further types of sequences possible? In general we may ask what kinds of nim-value sequences arise when a path of length k is attached to any graph.

7 Nim-values of some graphs with many odd cycles or loops

Let G be a connected graph without loops. If every vertex of G has degree at most two then it is just a path or a cycle. If we allow one vertex P to have higher degree, then G must consist of a number of cycles and paths attached to P . Attaching an even cycle to a vertex in a graph is the same as adding a disjoint vertex, by Lemma 2.1, and the nim-value simply changes by $\oplus 1$. So we may assume that the r cycles attached to P are all odd. Let the m paths attached to P have lengths $x_1 \geq x_2 \geq \dots \geq x_m \geq 0$ and it is convenient to set

$$X := \sum_{i=1}^m x_i, \quad \hat{X} := \sum_{i=1}^m (-1)^{i+1} x_i. \quad (7.1)$$

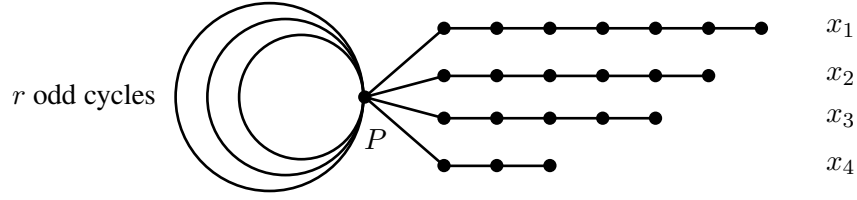

Figure 21: A graph from Theorem 7.1

See for example Figure 21. We have $\hat{X} = 0$ if and only if the paths cancel in pairs and G reduces to just the r cycles. Similarly, $\hat{X} = 1$ if and only if G reduces to the r cycles with two paths of lengths differing by 1 (or one path of length 1) attached at P .

Theorem 7.1. *Let G consist of a vertex P to which r odd cycles and m paths are attached. Then with the above notation we have*

$$g(G) = \begin{cases} 0 & \text{for } r \text{ odd and } \hat{X} = 0; \\ 4 & \text{for } r \text{ odd and } \hat{X} = 1; \\ \phi(G) & \text{otherwise.} \end{cases}$$

Proof. We use induction on (r, X) ordered lexicographically. In other words, $(r, X) > (r', X')$ exactly when $r > r'$ or when $r = r'$ and $X > X'$. Any move of G gives a graph with smaller (r, X) (and removing P gives a bipartite graph). The base case of the induction is true since $r = X = 0$ means G is a single vertex.

Note that

$$\phi(G) = (X + 1)_{(2)} + 2((X + r)_{(2)}).$$

The following cases establish the argument.

Case (i). Suppose r is odd and $\hat{X} = 0$. Then $\deg P$ is even, X is even and $\phi(G) = 3$. We want to show that $g(G) = 0$ and this follows if all moves H have $g(H) \neq 0$. Removing P or removing an edge or vertex on a cycle gives H with $g(H) = \phi(H)$. But for these moves $\phi(H) \neq 0$ since we may only get 0 by removing an odd degree vertex. If H is a move that deletes a vertex or edge from one of the paths of G then clearly $g(H) \neq 0$ if $\hat{X} \rightarrow 1$. The last option is that H makes \hat{X} greater than 1 so that $g(H) = \phi(H)$. If $\phi(H) = 0$ then H removes a vertex of odd degree. However, the only path move that does this removes a leaf vertex and has $\hat{X} \rightarrow 1$. Hence $g(H) \neq 0$ in this option.

Case (ii). Suppose r is odd and $\hat{X} = 1$. Then X is odd, $\phi(G) = 0$ and we want to show that $g(G) = 4$. First we prove that moves with nim-values 0, 1, 2 and 3 exist. Deleting a vertex or edge on the cycle gives nim-values 1 and 2. Since $\hat{X} = 1$, there exists r such that $x_r = 1 + x_{r+1}$ (with x_{r+1} possibly 0). Removing the vertex at the end of the path of length x_r makes $\hat{X} \rightarrow 0$, giving nim-value 0. If $\deg P$ is odd then removing P is a move with nim-value 3. Otherwise $\deg P$ is even implying there exists r such that $x_r = 1 + x_{r+1}$ and $x_{r+1} \geq 1$. Removing the vertex at the end of the path of length x_{r+1} makes $\hat{X} \rightarrow 2$ and this move has nim-value 3.

Next we show that all moves H have $g(H) \neq 4$. The only possible moves with nim-value ≥ 4 have \hat{X} remaining as 1. If $x_r = 1 + x_{r+1}$ then the only move that does this has $x_r \rightarrow x_r - 2$ by removing a degree 2 vertex. But this move has nim-value $4 \oplus 1 = 5$.

Case (iii). Suppose r is even and X is even. Then $\phi(G) = 1$ and we want to show that $g(G) = 1$. To find a move with nim-value 0 we may remove a degree 2 vertex on one of the paths of G . We cannot do this if $x_1 \leq 1$. Since X is even, it follows that the degree of P must be even if $x_1 \leq 1$. Removing P then gives the move with nim-value 0. If H is any move then $g(H) = 0, 4$ or $\phi(H)$ and not equal to 1.

Case (iv). Suppose r is even and X is odd. Then $\phi(G) = 2$ and we want to show that $g(G) = 2$. We have $x_1 \geq 1$ and removing the end edge and vertex on this path gives nim-values 0 and 1 respectively. If H is any move then $g(H)$ is 0, 4 or $\phi(H)$ and not equal to 2.

Case (v). Suppose r is odd, X is even and $\hat{X} \geq 2$. Then $\phi(G) = 3$ and we want to show that $g(G) = 3$. Removing a cycle edge and vertex gives nim-values 1 and 2 respectively. If $\deg P$ is odd the removing it gives nim-value 0. Otherwise, the largest r for which x_r is positive is even. Removing the vertex at the end of this path increases \hat{X} and therefore this move has nim-value 0. We have shown that moves with nim-values 0, 1 and 2 exist.

It remains to show that all moves H have $g(H) \neq 3$. By induction we have $g(H) = 0 \oplus t$ or $4 \oplus t$ or $\phi(H)$ for $t = 0, 1$ or 2 , the nim-value of the disconnected path. It follows that $g(H) \neq 3$.

Case (vi). Suppose r is odd, X is odd and $\hat{X} \geq 2$. Then $\phi(G) = 0$ and we want to show that $g(G) = 0$. This is true if all moves H have $g(H) \neq 0$. As in the previous case, $g(H) = 0 \oplus t$ or $4 \oplus t$ or $\phi(H)$ for $t = 0, 1$ or 2 . The only way to obtain $g(H) = 0$ is if a vertex or edge is removed so that $\hat{X} \rightarrow 0$ and the disconnected path has nim-value $t = 0$. This is not possible for $\hat{X} \geq 2$. \square

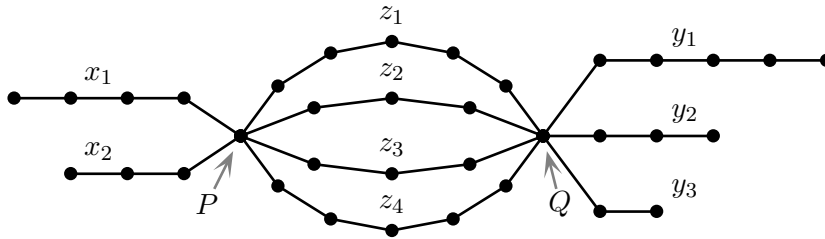

Figure 22: A graph from Theorem 7.2

We next consider a family of graphs where two vertices P and Q may have high degree and the remaining vertices have degree ≤ 2 . Suppose there are k paths of lengths $z_1, \dots, z_k \geq 1$ linking P and Q . We also have m paths from P of lengths $x_1 \geq x_2 \geq \dots \geq x_m \geq 0$ and n paths from Q of lengths $y_1 \geq y_2 \geq \dots \geq y_n \geq 0$ as shown in Figure 22. Similarly to (7.1), put

$$X := \sum_{i=1}^m x_i, \quad \hat{X} := \sum_{i=1}^m (-1)^{i+1} x_i, \quad Y := \sum_{i=1}^n y_i, \quad \hat{Y} := \sum_{i=1}^n (-1)^{i+1} y_i, \quad Z := \sum_{i=1}^k z_i.$$

Theorem 7.2. *Let G be a member of the above family of graphs involving paths linking to P and Q . With the defined notation we have*

$$g(G) = \begin{cases} 0 & \text{for } k \text{ even, } Z \text{ odd and } \hat{X} + \hat{Y} = 0; \\ 4 & \text{for } k \text{ even, } Z \text{ odd and } \hat{X} + \hat{Y} = 1; \\ \phi(G) & \text{otherwise.} \end{cases}$$

Proof. We argue similarly to the proof of Theorem 7.1 and use induction on $(k, X + Y)$ ordered lexicographically. The result is true in the base cases of $k = 0$ (so that $Z = 0$) and $k = 1$ since G is then bipartite. Hence we assume $k \geq 2$. If $z_1 = \dots = z_k = 1$ then we have a multiple edge which simplifies to a single edge or no edge as discussed after Lemma 2.1. Therefore we may assume there exists a z_i with $z_i \geq 2$. Also note that

$$\phi(G) = (X + Y + Z + k)_{(2)} + 2((X + Y + Z)_{(2)}).$$

The following cases establish the argument.

Case (i). Suppose k is even, Z is odd and $\hat{X} + \hat{Y} = 0$. Then $X, Y, \deg P$ and $\deg Q$ are all even and $\phi(G) = 3$. To show that $g(G) = 0$ we need to prove that all moves H have $g(H) \neq 0$. Removing P, Q or an edge or vertex between P and Q gives H with $g(H) = \phi(H)$. But for these moves $\phi(H) \neq 0$ since we may only get 0 by removing an odd degree vertex. If H is a move that deletes a vertex or edge from a path of G not between P and Q then clearly $g(H) \neq 0$ if $\hat{X} + \hat{Y} \rightarrow 1$. The last option is that H makes $\hat{X} + \hat{Y}$ greater than 1 so that $g(H) = \phi(H)$. If $\phi(H) = 0$ then H removes a vertex of odd degree. However, the only path move that does this removes a leaf vertex and has $\hat{X} + \hat{Y} \rightarrow 1$. Hence $g(H) \neq 0$ in this option.

Case (ii). Suppose k is even, Z is odd and $\hat{X} + \hat{Y} = 1$. Then $X + Y$ is odd, $\phi(G) = 0$ and we want to show that $g(G) = 4$. First we prove that moves with nim-values 0, 1, 2 and 3 exist. Deleting a vertex or edge between P and Q gives nim-values 1 and 2. With $\hat{X} + \hat{Y} = 1$ we must have $\hat{X} = 1$ or $\hat{Y} = 1$. If $\hat{X} = 1$, there exists r such that $x_r = 1 + x_{r+1}$ (with x_{r+1} possibly 0). Removing the vertex at the end of the path of length x_r makes $\hat{X} \rightarrow 0$, giving nim-value 0. If $\deg P$ is odd then removing P is a move with nim-value 3. Otherwise $\deg P$ is even implying there exists r such that $x_r = 1 + x_{r+1}$ and $x_{r+1} \geq 1$. Removing the vertex at the end of the path of length x_{r+1} makes $\hat{X} \rightarrow 2$ and this move has nim-value 3. The same argument works if $\hat{Y} = 1$.

Next we show that all moves H have $g(H) \neq 4$. The only possible moves with nim-value ≥ 4 have $\hat{X} + \hat{Y}$ remaining as 1. If $\hat{X} = 1$ and $x_r = 1 + x_{r+1}$ then the only move that does this has $x_r \rightarrow x_r - 2$ by removing a degree 2 vertex. But this move has nim-value $4 \oplus 1 = 5$. We have the same argument when $\hat{Y} = 1$.

Case (iii). Suppose k is odd and $X + Y + Z$ is even. Then $\phi(G) = 1$ and we want to show that $g(G) = 1$. To find a move with nim-value 0 we may remove a degree 2 vertex between P and Q if Z is even. Now assume Z is odd. Removing a degree 2 vertex on one of the paths not between P and Q gives nim-value 0. We cannot do this if all x_i, y_i are ≤ 1 . Since one of X or Y is odd, it follows that the degree of P or Q must be even if x_i, y_i are ≤ 1 . Removing this even degree vertex then gives the move with nim-value 0. If H is any move then $g(H) = 0, 4$ or $\phi(H)$ and not equal to 1.

Case (iv). Suppose k is odd and $X + Y + Z$ is odd. Then $\phi(G) = 2$ and we want to show that $g(G) = 2$. If any of x_i, y_i are ≥ 1 then removing the end edge and vertex on this path gives nim-values 0 and 1 respectively. Otherwise, $X = Y = 0$ and $Z, \deg P$ are odd. Removing P gives nim-value 1 and removing a central edge from a path with z_i odd gives nim-value 0. If H is any move then $g(H)$ is 0, 4 or $\phi(H)$ and not equal to 2.

Case (v). Suppose k is even, $X + Y + Z$ is odd and $\hat{X} + \hat{Y} \geq 2$. Then $\phi(G) = 3$ and we want to show that $g(G) = 3$. Removing a cycle edge and vertex gives nim-values 1 and 2 respectively. If $\deg P$ is odd the removing it gives nim-value 0. Otherwise, the largest r for which x_r is positive is even. Removing the vertex at the end of this path increases \hat{X} and therefore this move has nim-value 0. We have shown that moves with nim-values 0, 1 and 2 exist.

It remains to show that all moves H have $g(H) \neq 3$. By induction we have $g(H) = 0 \oplus t$ or $4 \oplus t$ or $\phi(H)$ for $t = 0, 1$ or 2 , the nim-value of the disconnected path. It follows that $g(H) \neq 3$.

Case (vi). Suppose k is even, $X + Y + Z$ is even and $\hat{X} + \hat{Y} \geq 2$. Then $\phi(G) = 0$ and we want to show that $g(G) = 0$. This is true if all moves H have $g(H) \neq 0$. As in the previous case, $g(H) = 0 \oplus t$ or $4 \oplus t$ or $\phi(H)$ for $t = 0, 1$ or 2 . The only way to obtain $g(H) = 0$ is if a vertex or edge is removed so that $\hat{X} + \hat{Y} \rightarrow 0$ and the disconnected path has nim-value $t = 0$. This is not possible for $\hat{X} + \hat{Y} \geq 2$. \square

Propositions 1.5 and 1.6 follow as special cases of Theorems 7.1 and 7.2 respectively. Note that $\hat{X} = 1$ in Theorem 7.1 and $\hat{X} + \hat{Y} = 1$ in Theorem 7.2 exactly when there is a single telescoping vertex of odd degree. So these theorems fit a similar pattern to the results in Section 5 and could be part of a larger encompassing theory.

We consider one more family of graphs in this section.

Theorem 7.3. *Let $K_n(m)$ be the complete graph K_n with a loop attached to m different vertices. Then*

$$g(K_n(m)) = (m + n)_{(3)}.$$

Proof. We use induction on n with the $n = 0, 1$ cases easily verified. Assume $n \geq 2$. If $m = 0$ then we just have the complete graph and the theorem follows by (2.5). If $0 < m < n$ then $K_n(m)$ contains two vertices v and v' connected by an edge such that exactly one of them has a single loop attached.

To proceed we need the following extension of the symmetry lemma. Suppose that $\tau : G \rightarrow G$ satisfies the conditions of Lemma 2.1 with $u \neq \tau(u)$ for vertex u . Let G^* be G with an edge e added between u and

$\tau(u)$ and a loop l added to either vertex. The proof of Lemma 2.1 goes through if we respond to e with l and vice versa. This proves $g(G^*) = g(G^\tau)$.

Applying the above argument, where τ maps $v \rightarrow v'$ and fixes the remaining vertices, shows that

$$g(K_n(m)) = g(K_{n-2}(m-1)) = (m+n-3)_{(3)} = (m+n)_{(3)}$$

by induction. In the final case, $m = n$ and all vertices of $K_n(n)$ have a loop attached. The three possible moves from this position are to:

- (i) remove a loop and get a graph with nim-value equal to $g(K_{n-2}(n-2))$ by the above extension to the symmetry lemma,
- (ii) remove an edge and get a graph with nim-value equal to $g(K_{n-2}(n-2))$ by the symmetry lemma,
- (iii) remove a vertex and get $K_{n-1}(n-1)$.

Therefore

$$\begin{aligned} g(K_n(n)) &= \text{mex}(\{g(K_{n-2}(n-2)), g(K_{n-1}(n-1))\}) \\ &= \text{mex}(\{(2n-4)_{(3)}, (2n-2)_{(3)}\}) \\ &= \text{mex}(\{(2n+1)_{(3)}, (2n+2)_{(3)}\}) = (2n)_{(3)}. \end{aligned} \quad \square$$

8 Wheel graphs and subgraphs

As we saw in the introduction, the wheel graph W_n is constructed by joining a central hub vertex to each vertex of the cycle graph C_n . We will later need the *fan graph* F_n and also F_n^* which we may call a *fan with a handle*. Construct F_n by removing a rim edge of W_n and construct F_n^* by removing two adjacent rim edges of W_n . Examples are shown in Figure 23.

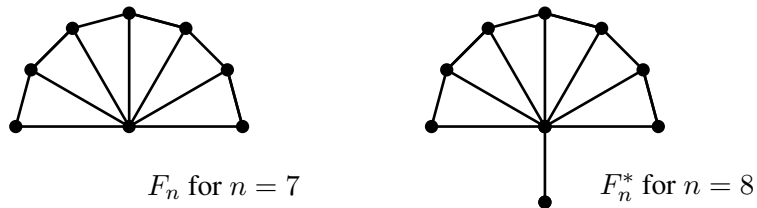

Figure 23: Some wheel subgraphs – fans denoted F_n and fans with a handle denoted F_n^*

The wheel graph W_n for n even is easily seen, with the symmetry lemma, to have nim-value 1. This follows by letting τ fix a diameter and reflecting the graph from one side of the diameter to the other. The fixed diameter is a path of length 2 with nim-value 1. Alternatively, τ could fix the central hub of W_n and send each vertex and edge to the opposite side. The nim-value of a single vertex is again 1. These techniques do not work for W_n with n odd since a short argument shows that any τ satisfying the conditions of Lemma 2.1 must be the identity on W_n .

In a computer calculation we have found the nim-values of W_n and all its subgraphs for $n \leq 14$. This proves directly that $g(W_n) = 1$ for $3 \leq n \leq 14$. It also reveals interesting patterns that we describe throughout this section.

To prove $g(W_n) = 1$ for $n > 14$, we consider the graph made up of W_n and an isolated vertex and want to show that the second player has a winning strategy. Clearly, removing the central hub vertex of W_n has the reply of removing the isolated vertex and vice versa. Also deleting a vertex on the rim of the wheel has the response of deleting the opposite edge and vice versa; the remaining graph is equivalent to two isolated vertices by symmetry.

If the first player removes a spoke then the winning responses in $K_1 \cup W_n$, with $n = 9$ for example, are highlighted on the left in Figure 24: six spokes and two vertices. This same pattern appears for all odd

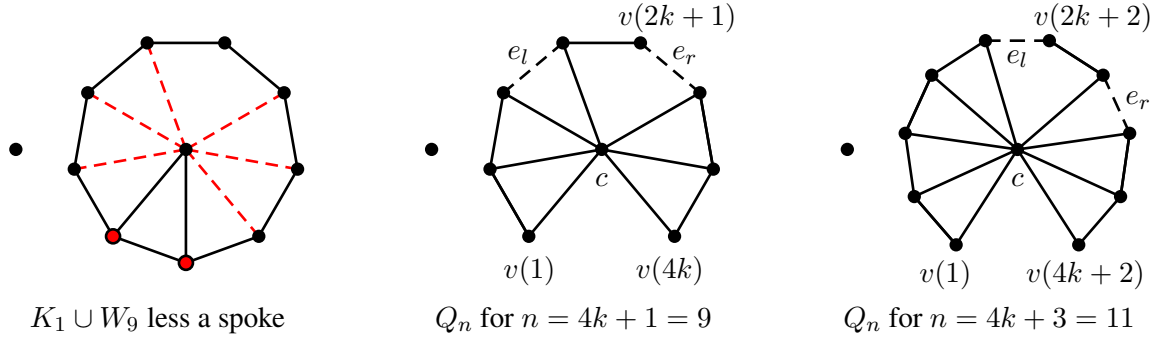

Figure 24

$n \leq 13$. Removing one of the indicated vertices leaves the graph labelled Q_9 in the middle of Figure 24. In general we let Q_n be the graph consisting of K_1 and W_n with one spoke and one of the two opposite vertices deleted. Label the vertices of Q_n as shown in Figure 24, $v(1), \dots, v(n-1)$ with central hub vertex c . The missing spoke is between c and $v((n+1)/2)$.

Theorem 8.1. *We have $g(W_n) = 1$ for all n in the range $3 \leq n \leq 25$.*

Proof. We already saw that $g(W_n) = 1$ for n even and that $g(W_n) = 1$ for $3 \leq n \leq 14$. This computation also shows that $g(Q_n) = 0$ for n odd in the range $3 \leq n \leq 13$. We prove the theorem by demonstrating that $g(Q_n) = 0$ for all odd n in the range $15 \leq n \leq 25$.

Suppose that $g(Q_m) = 0$ for all odd m in the range $3 \leq m \leq n-2$ and consider Q_n . We first look at the case $n = 4k + 1$ as shown in the middle of Figure 24. Let e_l be the edge between $v(2k-1)$ and $v(2k)$. Let e_r be the edge between $v(2k+1)$ and $v(2k+2)$. To show that $g(Q_n) = 0$ we look for winning responses to any moves of the first player. If K_1 is removed then the winning response is $v(1)$ since an application of the symmetry lemma shows the remaining graph has the same nim-value as two isolated vertices. Also deleting $v(1)$ is a winning response to deleting K_1 . We may write this move/response pair as $K_1 \leftrightarrow v(1)$. Exercises with the symmetry lemma give the following pairs: $c \leftrightarrow v(1)$, $v(2k) \leftrightarrow v(2k+1)$ and, since $g(Q_m) = 0$ for smaller m , $v(i) \leftrightarrow v(n-i)$ for $1 \leq i \leq n-1$. For edge moves we have $(v(2k), v(2k+1)) \leftrightarrow (c, v(1))$ and also $(v(i), v(i+1)) \leftrightarrow (v(n-i-1), v(n-i))$ for $1 \leq i \leq 2k-1$.

It remains to find winning replies to the first player removing a spoke. We choose the response of removing e_l when any of the spokes on the left are removed: $(v(i), c)$ with $1 \leq i \leq 2k$. The resulting graph simplifies to F_{2k+2}^* with two spokes missing (the edge connected to the degree one vertex must remain). We choose the response of removing e_r when any of the spokes on the right are removed: $(v(i), c)$ with $2k+2 \leq i \leq 4k$. The resulting graph also simplifies to F_{2k+2}^* with two spokes missing.

For the case $n = 4k + 3$ we argue similarly, with the initial moves and responses using the same symmetries. The spoke move responses are defined slightly differently with e_l the edge between $v(2k+1)$ and $v(2k+2)$, and e_r the edge between $v(2k+3)$ and $v(2k+4)$. We choose the response of removing e_l when any of the spokes on the left are removed: $(v(i), c)$ with $1 \leq i \leq 2k+1$. The resulting graph simplifies to F_{2k+2}^* with two spokes missing. We choose the response of removing e_r when any of the spokes on the right are removed: $(v(i), c)$ with $2k+3 \leq i \leq 4k+2$. The resulting graph simplifies to F_{2k+4}^* with two spokes missing.

Let F_m^{**} be F_m^* with any two spokes missing. Since F_m^{**} is a subgraph of W_m , our computation verifies that $g(F_m^{**} \cup K_1) = 0$ (i.e. $g(F_m^{**}) = 1$) for all even $m \leq 14$. This shows that $g(W_n) = 1$ for all odd n up to $n = 23$ (requiring F_{12}^{**} and F_{14}^{**}) and $n = 25$ (requiring F_{14}^{**}). \square

From the proof of Theorem 8.1 we see that the following conjecture implies Conjecture 1.7, i.e. that $g(W_n) = 1$ for all n .

Conjecture 8.2. (Even fans with handles and two spokes removed.) *Let the spokes of F_n^* be all edges connected to the hub except the edge connected to the degree 1 vertex. For all even $n \geq 4$ the nim-value of F_n^* with any two spokes removed is 1.*

Exploring the nim-values of the move options for the fans F_n and the fans with handles F_n^* reveals the following patterns for the given n values up to 14 and we conjecture they hold for all n .

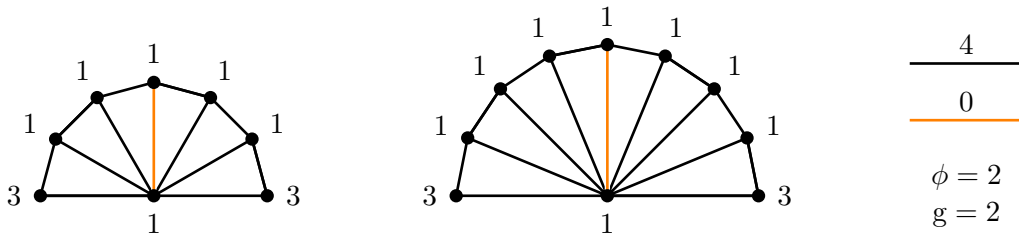

Figure 25: Nim-values for the move options of F_7 and F_9

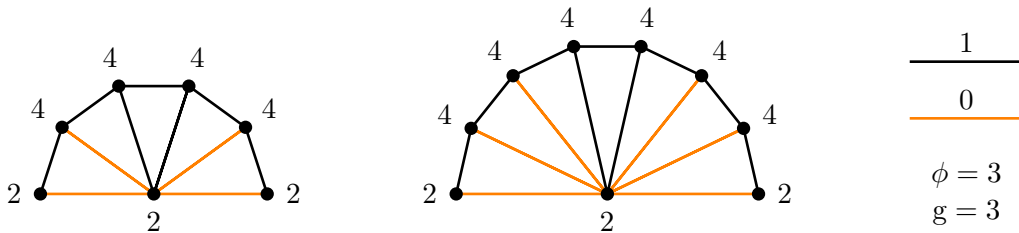

Figure 26: Nim-values for the move options of F_6 and F_8

Conjecture 8.3. (Fan options.)

- (i) For all odd $n \geq 7$ the nim-values of the options in the fan F_n are as follows. All vertices have value 1 except the degree 2 vertices which have value 3. All edges have value 4 except the edge on the axis of symmetry with value 0. See the examples in Figure 25.
- (ii) For all even $n \geq 4$ the nim-values of the options in the fan F_n are as follows. All vertices have value 4 except the degree 2 vertices and the central vertex which have value 2. All edges on the rim along with the two spokes on each side of the axis of symmetry have value 1. The remaining spokes have value 0. Hence $g(F_n) = 3$ for n even. See the examples in Figure 26.

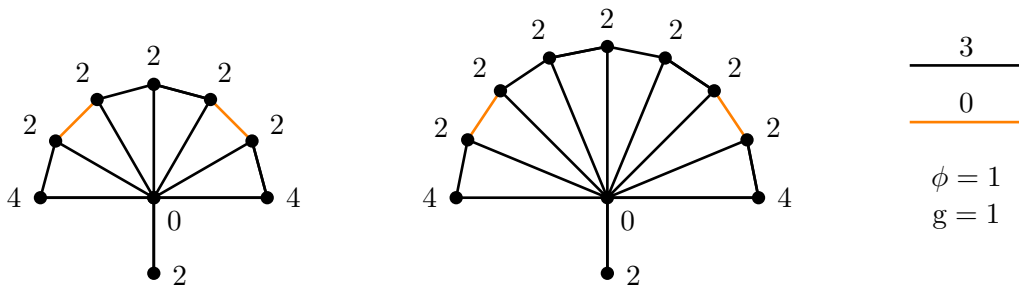

Figure 27: Nim-values for the move options of F_8^* and F_{10}^*

Conjecture 8.4. (Fan with a handle options.)

- (i) For all even $n \geq 6$ the nim-values of the options in the fan F_n^* are as follows. All vertices have value 2 except the degree 2 vertices which have value 4 and the central vertex with value 0. All edges have value 3 except two on the rim a distance 1 from the degree 2 vertices. They have value 0. See the examples in Figure 27.

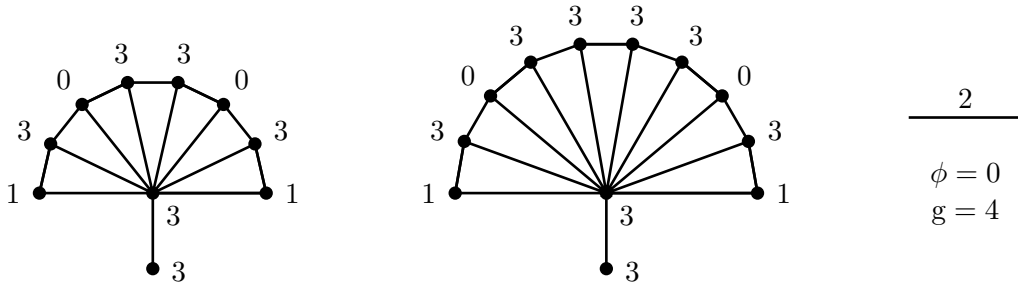

Figure 28: Nim-values for the move options of F_9^* and F_{11}^*

(ii) For all odd $n \geq 7$ the nim-values of the options in the fan F_n^* are as follows. Almost all vertices have value 3. The exceptions are the degree 2 vertices with value 1 and the two vertices on the rim a distance 2 from these with value 0. All edges have value 2. Hence $g(F_n^*) = 4$ for n odd. See the examples in Figure 28.

It is clear by the symmetry lemma that $g(F_n) = 2$ for n odd and that deleting the edge on the axis of symmetry gives nim-value 0. Similarly we may show that $g(F_n^*) = 1$ for n even and the highlighted edges in Figure 27 give nim-value 0 when removed because the graph simplifies to a cycle. It is remarkable that, except for those just mentioned, all other edges in each F_n^* seem to have the same nim-value: 3 for n even and 2 for n odd. Perhaps proving the patterns in these conjectures requires characterizing when $g(H) = \phi(H)$ for subgraphs of W_n , similarly to Theorem 1.3.

Computer calculations indicate that a subgraph H of W_n with $\phi(H) = 2$ never has nim-value 0. This leads us to the following conjecture.

Conjecture 8.5. Let H be any subgraph of W_n for $n \geq 3$. Suppose $\phi(H) = 2$ (i.e. H has an even number of vertices and an odd number of edges). Then there exists an edge of H so that removing it gives a graph with nim-value 0.

This conjecture is true for all subgraphs with $\phi = 2$ of W_n for $3 \leq n \leq 14$. For example, the graphs shown in Figure 25 have $\phi = 2$ and contain a single edge move with nim-value 0. The conjecture is also true for bipartite graphs but not for general graphs and fails for instance for the three graphs shown in Figure 29. These graphs have $\phi = 2$ but no edge moves give nim-value 0 and a computer search shows they are the only

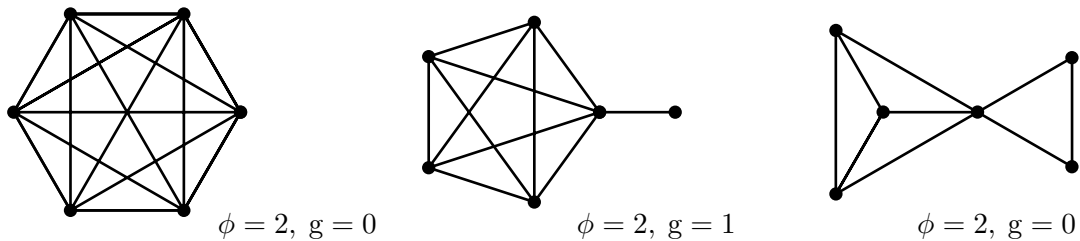

Figure 29: Three examples with $\phi = 2$ but no winning edge moves

graphs on 6 or fewer vertices with this property. Interestingly, they are of the form $K_i \cup K_j$ for $i + j = 7$ with a vertex of K_i and K_j identified.

We list five straightforward consequences of Conjecture 8.5 with H any subgraph of a wheel:

- (i) If H has an odd number of edges then there exists an edge of H so that removing it gives a nim-value of $\phi(H) \oplus 2$.
- (ii) If H has an even number of edges then $g(H) = \phi(H)$ or there exists an edge of H so that removing it gives a nim-value of $\phi(H) \oplus 2$ (or both).
- (iii) If H has an even number of vertices then $g(H) = 0$ implies $\phi(H) = 0$.

- (iv) If $\phi(H) = 0$ then any winning move must remove a vertex.
- (v) Lastly we note that Conjecture 8.5 implies Conjecture 1.7, i.e. that $g(W_n)$ always equals 1. To see this implication, recall from the proof of Theorem 8.1 that $g(W_n) = 1$ for n odd follows if we can show that there is a winning response to Q_n with a spoke removed. Since Q_n with a spoke removed has $\phi = 2$, Conjecture 8.5 implies there is a winning edge response.

References

- [ADE⁺16] Richard Adams, Janae Dixon, Jennifer Elder, Jamie Peabody, Oscar Vega, and Karen Willis. Combinatorial analysis of a subtraction game on graphs. *Int. J. Comb.*, pages Art. ID 1476359, 8, 2016.
- [BC17] Andries E. Brouwer and J. Daniel Christensen. Counterexamples to conjectures about Subset Takeaway and counting linear extensions of a Boolean lattice. *arXiv:1702.03018*, 2017.
- [BCG01] Elwyn R. Berlekamp, John H. Conway, and Richard K. Guy. *Winning ways for your mathematical plays. Vol. 1*. A K Peters, Ltd., Natick, MA, second edition, 2001.
- [BM08] J. A. Bondy and U. S. R. Murty. *Graph theory*, volume 244 of *Graduate Texts in Mathematics*. Springer, New York, 2008.
- [Byr03] Steven Byrnes. Poset game periodicity. *Integers*, 3:G3, 16, 2003.
- [Con01] J. H. Conway. *On numbers and games*. A K Peters, Ltd., Natick, MA, second edition, 2001.
- [CT97] J. Daniel Christensen and Mark Tilford. Unsolved Problems: David Gale’s Subset Take-Away Game. *Amer. Math. Monthly*, 104(8):762–766, 1997.
- [DT96] Walter Deuber and Stéphan Thomassé. Grundy sets of partial orders. 1996. Technical Report No. 96-123, Diskrete Strukturen in der Mathematik, Universität Bielefeld.
- [FR15] Stephen A. Fenner and John Rogers. Combinatorial game complexity: an introduction with poset games. *Bull. Eur. Assoc. Theor. Comput. Sci. EATCS*, (116):42–75, 2015.
- [FS91] Aviezri S. Fraenkel and Edward R. Scheinerman. A deletion game on hypergraphs. *Discrete Appl. Math.*, 30(2-3):155–162, 1991. ARIDAM III (New Brunswick, NJ, 1988).
- [GN82] D. Gale and A. Neyman. Nim-type games. *Internat. J. Game Theory*, 11(1):17–20, 1982.
- [Krü14] Oliver Krüger. Note on Odd Odd vertex removal games on bipartite graphs. *Integers*, 14:Paper No. G07, 4, 2014.
- [KY11] Tirasan Khandhawit and Lynnelle Ye. Chomp on graphs and subsets. *arXiv:1101.2718v1*, 2011.
- [LC16] Richard M. Low and W. H. Chan. Notes on the combinatorial game: graph Nim. *Electron. J. Graph Theory Appl. (EJGTA)*, 4(2):190–205, 2016.
- [NO05] Richard J. Nowakowski and Paul Ottaway. Vertex deletion games with parity rules. *Integers*, 5(2):A15, 16, 2005.

DEPT. OF MATH, THE CUNY GRADUATE CENTER, 365 FIFTH AVENUE, NEW YORK, NY 10016-4309, U.S.A.
E-mail address: cosullivan@gc.cuny.edu