

Discovering Sequential Patterns in Event-Based Spatio-Temporal Data by Means of Microclustering - Extended Report

Piotr S. Maciąg

Institute of Computer Science, Warsaw University of Technology,
Nowowiejska 15/19,
00-665, Warsaw, Poland
pmaciag@ii.pw.edu.pl

Abstract. In the paper, we consider the problem of discovering sequential patterns from event-based spatio-temporal data. The problem is defined as follows: for a set of event types F and for a dataset of events instances D (where each instance in D denotes an occurrence of a particular event type in considered spatio-temporal space), discover all sequential patterns defining the following relation between any event types participating in a particular pattern. The following relation \rightarrow between any two event types, denotes the fact that instances of the first event type attract in their spatial proximity and in considered temporal window afterwards occurrences of instances of the second event type. In the article, the notion of sequential pattern in event-based spatio-temporal data has been defined and the already proposed approach to discovering sequential pattern has been reformulated. We show, it is possible to efficiently and effectively discover sequential patterns in event-based spatio-temporal data.

1 Introduction

Discovering knowledge from spatio-temporal data is gaining attention of researchers nowadays. Based on literature we can distinguish two basic types of spatio-temporal data: event-based and trajectory-based [18]. The latter refers to the situation where for a set of objects and their movements (trajectories), we would like to find several types of patterns: clustering trajectories [20], discovering representative trajectory [17], finding frequently visited areas [19]. We do not consider this type of data in our paper. The appropriate review of frequent patterns mining methods for this type of data may be found in [18].

On the other hand, event-based spatio-temporal data is described by a set of event types $F = \{f_1, f_2, \dots, f_n\}$ and a set of instances D . Each instance $e \in D$ denotes an occurrence of a particular event type from F and is associated with instance identifier, location in spatial dimension and occurrence time. In a more complex scenario, it is possible that an instance is also associated with a particular numerical value. For example, for an event type *temperature*, an instance

of this event type may contain a value $20^{\circ}C$. However, we do not consider this situation in our paper. Table 1 provides possible sets D and F . The dataset given in Table 1 is depicted in Fig. 1. Event-based spatio-temporal data and the problem of discovering frequent sequential patterns in this type of data have been introduced in [13].

Table 1. An example of a spatio-temporal event-based dataset.

Instance identifier	Event type	Spatial location	Occurrence time
a1	A	19	1
a2	A	83	1
⋮	⋮	⋮	⋮
b1	B	25	3
b2	B	1	3
⋮	⋮	⋮	⋮
c1	C	25	7
c2	C	15	7
⋮	⋮	⋮	⋮
d1	D	21	11
d2	D	13	12
⋮	⋮	⋮	⋮

Spatio-temporal data occurs frequently in real world. Possible applications considered in literature are as follows. [23] considers the problem of discovering ozone polluted areas. For a set of measurements containing informations about ozone pollution in Houston city, the task is to find polygons denoting areas with similar ozone pollution. Additionally, each measurement contains occurrence time, so the applied algorithm may focus on analyzing changes in ozone pollutions. The similar task is considered in [24] and [14].

Discovering knowledge from spatial data is a widely known topic in the literature. Among the most important problems in that area is discovering spatial collocation or association rules. According to [12], for a set of predefined event types a spatial collocation is defined as an occurrence of instances of particular event types in spatial proximity. The effective algorithms for discovering spatial collocations are provided in [6] and [8]. Clustering problem in spatial data is widely considered in literature [9], [25]. The worth mentioning problem is clustering complex spatial data (for example polygons or areas). The problem has been introduced in [21], where the authors proposes heuristics for measuring distance between polygons and provide appropriate clustering algorithm - CLARANS. The problem of developing appropriate distance measures and clustering algorithms for complex spatial object should be addressed in future publications.

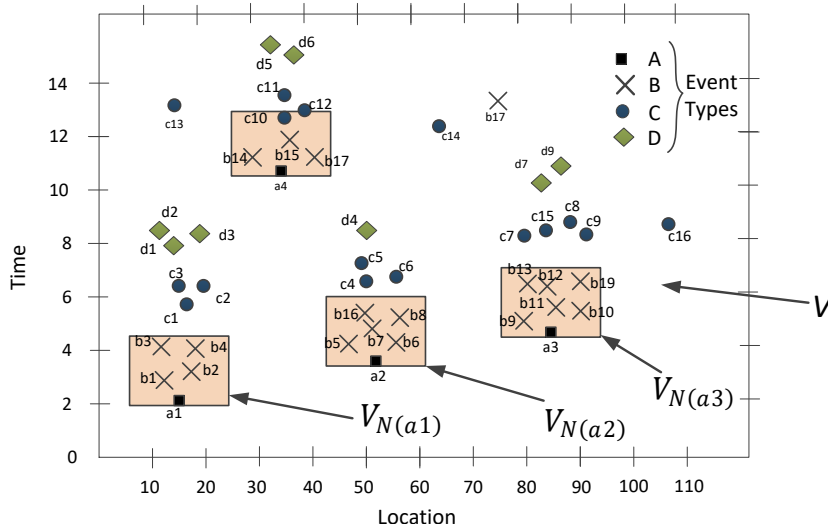

Fig. 1. Visualization of the dataset from Table 1.

The task of mining spatio-temporal sequential patterns in given datasets F and D may be defined as follows. We assume that the *following* relation (or attraction relation) $f_{i_1} \rightarrow f_{i_2}$ between any two event types denotes the fact, that instances of type f_{i_1} attract in their spatial and temporal neighborhoods occurrences of instances of type f_{i_2} . The strength of the following relation $f_{i_1} \rightarrow f_{i_2}$ is investigated by comparing the density of instances of type f_{i_2} in spatio-temporal neighborhoods of instances of type f_{i_1} and the density of instances of type f_{i_2} in the whole dataset D and spatio-temporal embedding space V . We provide the strict definition of density in Section 3. The problem is to discover all significant sequential patterns defined in the form $f_{i_1} \rightarrow f_{i_2} \rightarrow \dots \rightarrow f_{i_k}$. We assume that in a given pattern the following relation $f_{i_1} \rightarrow f_{i_2}$ is preserved between any consecutive event types participating in that pattern.

The layout of the article is as follows. In Section 2 we provide recall some articles important in the field of discovering patterns in transaction databases. In Section 3 we define elementary notions. We provide our modifications and the Micro-ST-Miner algorithm in Section 4. The results of our experiments are given in Section 5.

2 Related Works

In this section, we provide a review of topics related to the problem considered in our publication. In particular, we consider the problem of discovering frequent

patterns as a data mining task. The problem considered in the publication is related to the frequent patterns discovery problem. There exist a broad literature considering topic of discovering frequent patterns in transaction databases (that is, databases containing transaction of purchased items). The problem has been originally formulated in [3].

The most famous algorithms in the considered field are Apriori for generating frequent itemsets and Apriori-Gen for generating association rules [4]. Apriori generates a set of frequent patterns using two phases: first, based on the set of frequent k -length patterns (that is, patterns containing k items), the set of $k + 1$ -length candidate patterns is generated. In the second phase, the frequency (that is, the number of occurrences in a dataset) of each candidate is verified and non-frequent candidates are pruned (that is, candidate patterns with frequency below given threshold). Additionally, the candidates are pruned by means of the fact, that any candidate containing a non-frequent subpattern cannot be among frequent patterns (this property is obtained from the problem formulation and in literature is known as anti-monotone *apriori prune rule*). Based on the set of already discovered frequent patterns, the algorithm may proceed with generating $k + 2$ -length patterns and so forth. The algorithm stops, when the candidate set is empty.

The authors of [10] proposes an algorithm for discovering frequent patterns by means of the structure FrequentPattern-tree (FP-tree). The basic idea of the algorithm presented in [10] is to efficiently generate frequent patterns omitting the phase of candidate generation (the phase used in Apriori algorithm). The FP-tree is created as follows: in the first phase, a scan of a database of transactions is performed and all frequent single items are found. In the second step, the database is scanned again, a sequence of frequent single items is identified in each transaction and, if the sequence is not empty, the corresponding path (starting from the root of the tree) is inserted or updated in the already created FP-tree. The nodes in the created or updated path correspond to single items occurring in the sequence.

The problem of discovering sequential patterns in transaction databases has been formulated in [2]. In this context, a sequential pattern is defined as follows. For a set of customers and having a list of transactions for each customer, assume that each transaction contains a set of items. A sequential pattern is a list of sets of items. Each set of items in the list has to be contained in a particular transaction of a customer in the following manner: transaction containing the second set should occur after the transaction containing the first set, transaction containing the third set should occur after the transaction containing the second set and so forth. The number of customers to which the pattern may be matched is defined as the support of the pattern. In [2], the authors provide the following example of a sequential pattern: "5% of customers bought 'Foundation' and 'Ringworld' books in one transaction, followed by 'Second Foundation' book in a later transaction", for a database containing customers and books purchased in transactions. This problem has been extended in [22], where the authors introduced the notion of generalized sequential pattern and provided an algorithm

GSP for discovering patterns of that type. The notion of sequential pattern is extended to the notion of generalized sequential pattern by introducing temporal constraints for sets of items (e.g. time between the first and the last sets of items in a given pattern must not exceed given interval).

3 Basic Notions

Let us consider the spatiotemporal event-based dataset given in Fig. 1. The dataset contains $F = \{A, B, C, D\}$ event types and $D = \{a1, a2, \dots, a9\}$ events instances. The dataset is embedded in a spatiotemporal space V , by $|V|$ we denote the volume of that space, calculated as the product of spatial area and size of time dimension. Spatial and temporal sizes of spatiotemporal space are usually specified by the domain of considered task (e.g. for a weather dataset which may be used for discovering patterns between climate event types, the spatial area is specified by geographical coordinates of registered instances and size of time dimension is given by times of occurrences of instances). On the other hand, by $V_{N(e)}$ we denote the spatiotemporal neighborhood space of instance e (the formal statement of $V_{N(e)}$ is given in Definition 1). Sizes and shape of $V_{N(e)}$ are usually given by an expert.

Definition 1. (*Neighborhood space*) By $V_{N(e)}$ we denote the neighborhood space of instance e . \mathcal{R} denotes spatial radius and \mathcal{T} temporal interval of that space (and, due to that, $V_{N(e)}$ has a cylindrical shape).

Let us comment Definition 1 and let consider Fig. 2 where we denote possible shapes of neighborhood spaces. It is possible to select other type of neighborhood space than provided in Definition 1. For example, it may be appropriate to select conical neighborhood space for some applications.

Definition 2. (*Neighborhood definition [13]*) For a given occurrence of event instance e , the neighborhood of e is defined as follows:

$$N(e) = \{p | p \in D \wedge \text{distance}(e.\text{location}, p.\text{location}) \leq \mathcal{R} \wedge (p.\text{time} - e.\text{time}) \leq \mathcal{T} \wedge p.\text{type} = e.\text{type}\} \quad (1)$$

where \mathcal{R} denotes spatial radius and \mathcal{T} temporal interval of the neighborhood space $V_{N(e)}$.

The neighborhood $N(e)$ of instance e is the set of instances of the same type as e contained inside the neighborhood space $V_{N(e)}$.

Definition 3. (*Density [13]*) For a given spatiotemporal space V , event type f and its events instances in D , density is defined as follows:

$$\text{Density}(f, V) = \frac{|\{e | e.\text{type} = f \wedge e \text{ is inside } V\}|}{|V|} \quad (2)$$

density is the number of instances of type f occurring inside some space V divided by the volume of space V .

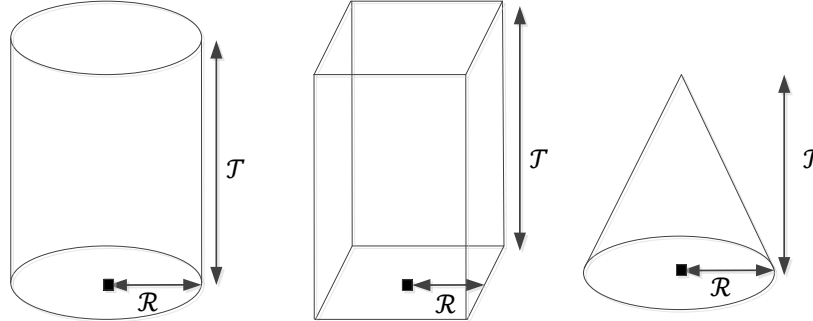

Fig. 2. Examples of types of neighborhood spaces $V_{N(e)}$ (figure adapted from [13])

Definition 4. (*Density ratio [13]*) Density ratio for two event types f_{i_1}, f_{i_2} is defined as follows:

$$\text{DensityRatio}(f_{i_1} \rightarrow f_{i_2}) = \frac{\text{avg}_{(e.type=f_{i_1})}(\text{Density}(f_{i_2}, V_{N(e)}))}{\text{Density}(f_{i_2}, V)} \quad (3)$$

$\text{avg}_{(e.type=f_{i_1})}(\text{Density}(f_{i_2}, V_{N(e)}))$ specifies the average density of instances of type f_{i_2} occurring inside the neighborhood spaces $V_{N(e)}$ defined for instances, whose type is f_{i_1} . V denotes the whole considered spatiotemporal space and $\text{Density}(f_{i_2}, V)$ specifies density of instances of type f_{i_2} in space V .

Density ratio for the pattern $f_{i_1} \rightarrow f_{i_2}$ is defined as the ratio of the average density of instances of type f_{i_2} inside the neighborhood spaces $V_{N(e)}$ defined for each instance $e \in f_{i_1}$ and the overall density of instances of type f_{i_2} in the whole spatiotemporal space V .

Density ratio expresses the strength of the attraction relation $f_{i_1} \rightarrow f_{i_2}$ between any two event types. If its value is greater than one, then occurrences of instances of type f_{i_1} attract in their spatiotemporal neighborhood spaces occurrences of instances of type f_{i_2} . If its value is equal to one, then there is no correlation between these two event types. The value below one indicates negative relation (instances of type f_{i_1} repel in their spatiotemporal neighborhood spaces occurrences of instances of type f_{i_2}). However, it may be very difficult to provide its appropriate value taking into account usually arbitrarily chosen V and $V_{N(e)}$. Careful study of experimental results provided in [13] show some deficiencies in that subject.

Definition 5. (*Sequence \vec{s} and tailEventSet(\vec{s}) [13]*) \vec{s} denotes a k -length sequence of event types: $s[1] \rightarrow s[2] \rightarrow \dots \rightarrow s[k-1] \rightarrow s[k]$, where $s[i] \in F$.

$tailEventSet(\vec{s})$ is the set of instances of type $\vec{s}[k]$ participating in the sequence \vec{s} .

If a k -length sequence \vec{s} is considered to be expanded, then the neighborhood spaces $V_{N(e)}$ and neighborhoods $N(e)$ are calculated for each $e \in tailEventSet(\vec{s})$.

Definition 6. (Sequence index [13]) For a given k -length sequence \vec{s} , sequence index is denoted as follows:

1. If $k = 2$ then:

$$SeqIndex(\vec{s}) = DensityRatio(\vec{s}[1] \rightarrow \vec{s}[2]) \quad (4)$$

2. If $k > 2$ then:

$$SeqIndex(\vec{s}) = \min \left\{ \begin{array}{l} SeqIndex(\vec{s}[1 : k - 1]), \\ DensityRatio(\vec{s}[k - 1] \rightarrow \vec{s}[k]) \end{array} \right. \quad (5)$$

Definition 7. Sequence (sequential pattern) \vec{s} is significant, if $SeqIndex(\vec{s}) \geq \theta$, where θ is significance threshold given by the user.

The value of $SeqIndex(\vec{s})$ for a k -length sequence \vec{s} denotes the minimal strength of the \rightarrow relation between any two consecutive event types participating in \vec{s} . In overall, sequence index provides means for discovering sequences for which its value is greater than the threshold given by the user. Possible significant sequences for the dataset shown in Fig. 1 are: $\vec{s}_1 = (A \rightarrow B \rightarrow C \rightarrow D)$, $\vec{s}_2 = (B \rightarrow C \rightarrow D)$ and $\vec{s}_3 = (C \rightarrow D)$.

To illustrate the above presented notions and give an outline of the algorithm discovering sequential patterns, please consider the sequence $\vec{s}_1 = A \rightarrow B \rightarrow C \rightarrow D$. Initially, the strength of the following relation $A \rightarrow B$ will be considered. The number of instances of type B is significantly greater in the neighborhood spaces created for instances of type A than the number of instances of type B in the whole space V . So we assume significant value of density ratio for the relation $A \rightarrow B$ and create a sequence $\vec{s} = A \rightarrow B$. The tail event set of \vec{s} will be $tailEventSet(\vec{s}) = \{b1, b2, \dots, b18\}$. The sequence \vec{s} may be then expanded with event type C , because the average density of instances of type C is significantly high in the neighborhood spaces defined for the instances of type B contained in $tailEventSet(\vec{s})$. Similarly to the above, \vec{s} will be expanded with event type D to create \vec{s}_1 .

Discovering all significant sequences is the aim of the algorithm ST-Miner [13]. The algorithm expands all significant sequences starting with 1-length sequences (singular event types). Each sequence is expanded in a dept-first manner by possible appending other event types. If the actual value of the sequence index is below a predefined threshold, then the sequence is not expanded any more. The crucial step in the expanding process is to compute $N(e)$ and density for each instance e in the tail event set of the processed sequence. Computing $N(e)$ may be seen as performing spatial join and for this purpose we use the *plane sweep algorithm* proposed in [5]. The complexity of the algorithm is $O(\mathcal{N}\sqrt{(\mathcal{N})})$ where \mathcal{N} is the number of instances in D .

4 Discovering of Sequential Patterns by Means of Microclustering Approach

Searching for the neighborhoods $N(e)$ by means of the plane sweep algorithm is a costly operation. Initially, for each event type and its instances e in D , a neighborhood $N(e)$ has to be computed. In the next steps, the number of computed neighborhoods will depend on the cardinalities of tail events sets of already discovered sequences. To resolve the mentioned problem we propose to use a *microclustering* approach. The aim of the approach is to reduce the number of instances of different types by grouping neighboring instances of the same type into one microcluster. Sequential patterns discovery may then proceed using the modified dataset. In Fig. 3 we show a conception of microclustering.

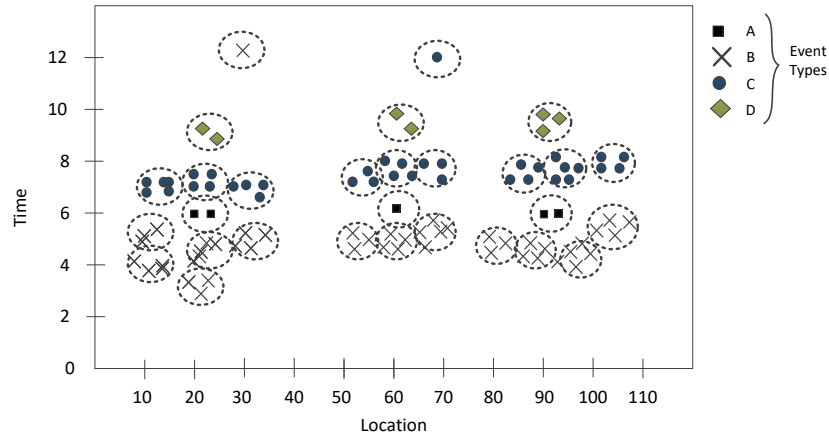

Fig. 3. A microclustering approach applied to the problem of reducing the size of a dataset

Microcluster e_c is a quintuple consisting of *microcluster identifier (CID)*, *event type* of contained instances, *a set of instances* contained in the microcluster, *number of instances contained in the microcluster* and *representative location* (for spatial and temporal) aspects. Representative location in both spatial and temporal dimensions is computed as a mean from respectively spatial coordinates and timestamps of instances contained in the microcluster.

Microclustering index MC_D created for dataset D , is a structure containing set of created microclusters and it may be used for appropriate computation of density ratios and sequence indexes on the reduced dataset. According to the proposed method, tail event sets of sequences contain microclusters rather than the original events instances.

Now we will propose our algorithm which will be based on the above introduced concept of microclustering. We need to appropriately modify definitions of density ratio and define facilitating indexing structures. We provide our modifications of the ST-Miner algorithm.

Table 2. An example of the microclustering index created by means of Algorithm 1 applied for the dataset shown in Fig. 1

CID	Event type	Contained instances	Num. of instances	Location (spatial, temporal)
1	A	{a1}	1	(15, 2)
2	A	{a2}	1	(51, 4)
⋮	⋮	⋮	⋮	⋮
5	B	{b1, b2, b3, b4}	4	(15, 3)
6	B	{b5, b6, b7, b8, b16}	5	(51, 5)
⋮	⋮	⋮	⋮	⋮
10	C	{c1, c2, c3}	3	(16, 6)
11	C	{c4, c5, c6}	3	(55, 6)
⋮	⋮	⋮	⋮	⋮
17	D	{d1, d2, d3}	3	(15, 8)
18	D	{d4}	1	(51, 8)
⋮	⋮	⋮	⋮	⋮

Let us consider the dataset given in Fig. 1. The corresponding microclustering index is shown in Table 2. For the microclustering step one may apply similar approach as proposed in [25]. The size of a microcluster may be limited by specifying its diameter threshold. In particular, for a given microcluster e_c and its contained instances $\{e_1, e_2, \dots, e_n\}$, as the size of a microcluster we propose to use its diameter defined according to Formula (6). By \vec{e}_i we denote a vector containing location in spatial and temporal dimensions of a particular instance e_i . The proposed microclustering approach is presented in Algorithm 1. Algorithm 1 has been inspired by the phase of building CF tree proposed in [25].

$$\mathcal{D}(e_c) = \sqrt{\frac{\sum_{i=1}^m \sum_{j=1}^m (\text{distance}(e_i - e_j))^2}{m * (m - 1)}} \quad (6)$$

where $\text{distance}(e_i - e_j)$ is the Euclidean distance between any two instances e_i and e_j , $i, j = 1 \dots m$ and m is the actual number of instances contained in e_c . If needed, the spatial and temporal dimensions may be normalized for the microclustering step. In such a case, user may provide two diameter components d_s for spatial dimension and d_t for temporal dimension. The overall diameter threshold (d) may be calculated as a normalized combination of these two values.

Algorithm 1 Algorithm for microclustering dataset D using Eq. 6

Require: d - diameter threshold, D - dataset of instances.

Ensure: MC_D - microclustering index for D .

```

1: for each event type  $f \in F$  do
2:   Take first instance  $e$  from  $D$ .
3:   Initialize first microcluster by inserting instance  $e$ .
4:   while There are instances in dataset  $D$  do
5:     Take next  $e$  from dataset  $D$  and insert it to the nearest  $e_c$ .
6:     if  $\mathcal{D}(e_c) > d$  then
7:       Split( $e_c$ ) ▷ Refer to Algorithm 2.
8:     end if
9:   end while
10: end for

```

Algorithm 2 Procedure for splitting microcluster Split(e_c)

Require: e_c - microcluster to be split.

Ensure: Two microclusters $e_c^{(i)}$ and $e_c^{(j)}$ obtained after splitting e_c .

```

1: Find a pair of farthest instances in  $e_c$ .
2: Mark the pair as seeds of two new microclusters  $e_c^{(i)}$  and  $e_c^{(j)}$ .
3: The rest of instances in  $e_c$  assign to the nearest from  $e_c^{(i)}$  and  $e_c^{(j)}$ .

```

For each event type and for the first instance of particular event type initialize a microcluster. For each of next instances find the nearest microcluster and insert instance to that microcluster. If diameter of that microcluster is greater than given threshold, split microcluster according to Algorithm 2. The split process proceeds as follows: find a pair of farthest instances in a microcluster considered to be split and mark the pair as seeds for two new microclusters. Redistribute the rest of instances from the original microcluster by assigning them to the nearest from two new microclusters.

Algorithms 1 and 2 are illustrated in Fig. 4. Definitions introduced in Section 3 should be appropriately modified according to the above proposed concept of microclustering. By MC_D we denote a microclustering index created for a dataset D . For any entry $e_c \in MC_D$ we propose two definitions of neighborhoods $n(e_c)$ and $N(e_c)$.

Definition 8. For a microcluster $e'_c \in MC_D$, the neighborhood $n(e'_c)$ of e'_c is defined as follows:

$$\begin{aligned}
 n(e'_c) = & \{e_c | e_c \in MC_D \wedge \text{distance}(e'_c.\text{location}, e_c.\text{location}) \leq \mathcal{R} \\
 & \wedge (e'_c.\text{time} - e_c.\text{time}) \leq \mathcal{T} \wedge e'_c.\text{type} = e_c.\text{type}\}
 \end{aligned} \tag{7}$$

that is, the neighborhood $n(e'_c)$ of a given microcluster e'_c is defined as the set of those microclusters, whose centers are contained inside space $V_{N(e'_c)}$ specified with respect to parameters \mathcal{R} and \mathcal{T} . $e'_c.\text{location}$ and $e_c.\text{location}$ refer respective to representative spatial locations of e'_c and e_c .

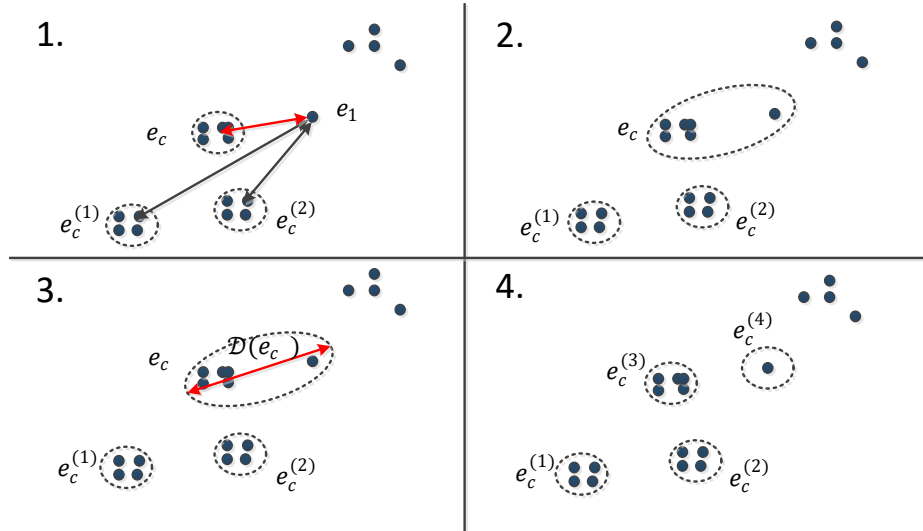

Fig. 4. The four phases of Algorithm 1

Definition 9. For a microcluster e'_c and for its neighborhood $n(e'_c)$, the set of instances covered by entries from $n(e'_c)$ is defined as follows:

$$N(e'_c) = \{p | p \in D \wedge p \text{ is inside } e_c \wedge e_c \in n(e'_c) \wedge e'_c.type = e_c.type\} \quad (8)$$

that is, as the neighborhood $N(e'_c)$ of a given microcluster e'_c we define a set of those instances from D , that each of which is contained in the microclusters from $n(e'_c)$.

The above introduced definitions $n(e_c)$ and $N(e_c)$ are useful in reformulating definitions of density and density ratio introduced in Section 3. By $MC_D(f)$ we define a set of entries in MC_D of event type f .

In Definitions 8 and 9 we do not refer to any particular event type, which microclusters or instances occur respectively in $n(e_c)$ or $N(e_c)$. However, it may be noticed from already provided notions, that density ratio considered for any two event types always take into account only neighborhoods of those particular event types. For example, considering the pattern $f_{i_1} \rightarrow f_{i_2}$, for any $e_c \in MC_D(f_{i_1})$, $n(e_c)$ and $N(e_c)$ contain respectively only microclusters and instances of type f_{i_2} .

Remark 1. For a microcluster $e_c \in MC_D$, the number of instances contained in this microcluster is denoted by $|e_c|$. For example, the number of instances contained in microcluster $e_c^{(5)}$ from Table 2 is $|e_c^{(5)}| = 4$.

Definition 10. *Modified density.* For a given spatiotemporal space V , event type f and its set of microclusters $MC_D(f) = \{e_c^{(1)}, e_c^{(2)}, \dots, e_c^{(n)}\}$ contained inside

V , the modified density is defined as follows:

$$\text{density}_{MC_D}(f, V) = \frac{|e_c^{(1)}| + |e_c^{(2)}| + \dots + |e_c^{(n)}|}{|V|}, \quad (9)$$

where $\{e_c^{(1)}, e_c^{(2)}, \dots, e_c^{(n)}\}$ inside V

that is, we define modified density as the quotient of the number of instances contained in $e_c^{(i)} \in MC_D(f)$ and the volume of space V . We say that a microcluster e_c is inside space V , if its representative location is inside V .

Definition 11. *Modified density ratio.* For two event types f_{i_1}, f_{i_2} and their entries in microclustering index MC_D , the modified density ratio is defined as follows:

$$\text{DensityRatio}_{MC_D}(f_{i_1} \rightarrow f_{i_2}) = \frac{\sum_{e_c.type=f_{i_1}} (|e_c| * \text{density}_{MC_D}(f_{i_2}, V_{N(e_c)}))}{(\sum_{e_c.type=f_{i_1}} |e_c|) * \text{density}_{MC_D}(f_{i_2}, V)} \quad (10)$$

comparing to Definition 4, the above definition takes into account proposed microclustering index and its entries.

The idea of Definition 11 is to calculate density ratio for the relation $f_{i_1} \rightarrow f_{i_2}$ using entries in microclustering index MC_D . Taking a microcluster $e_c \in MC_D(f_{i_1})$ and its neighborhood space $V_{N(e_c)}$, $\text{density}_{MC_D}(f_{i_2}, V_{N(e_c)})$ is weighted by the number $|e_c|$, that is by the number of instances contained in e_c . That is, the term:

$$\frac{\sum_{e_c.type=f_{i_1}} (|e_c| * \text{density}_{MC_D}(f_{i_2}, V_{N(e_c)}))}{(\sum_{e_c.type=f_{i_1}} |e_c|)}$$

specifies the weighted average density of instances of type f_{i_2} occurring in the neighborhood spaces $V_{N(e_c)}$ defined for microclusters $e_c \in MC_D(f_{i_1})$ with weights $|e_c|$. Before we proceed with an algorithm description we need to introduce one more definition.

Definition 12. For a sequence $\vec{s} \rightarrow f$ of length $k + 1$, that f follows event type $\vec{s}[k]$. $\text{tailEventSet}(\vec{s} \rightarrow f)$ is equal to the the set of microclusters of type f in MC_D following the sequence \vec{s} . This fact is denoted by the formula: $\text{tailEventSet}(\vec{s} \rightarrow f) = \{n(e_c^{(1)}) \cup n(e_c^{(2)}) \cup \dots \cup n(e_c^{(n)})\}$ where $\text{tailEventSet}(\vec{s}) = \{e_c^{(1)}, e_c^{(2)}, \dots, e_c^{(n)}\}$.

To illustrate above notions, please consider Fig. 5 and assume that we investigate the relation $A \rightarrow B$. Assume that at the beginning $\vec{s} = A$ and \vec{s} should be expanded with B , that is consider $\vec{s} \rightarrow B$. $\text{tailEventSet}(\vec{s}) = \{e_c^{(1)}, e_c^{(2)}\}$ and $\text{tailEventSet}(\vec{s} \rightarrow B) = n(e_c^{(1)}) \cup n(e_c^{(2)}) = \{e_c^{(3)}, e_c^{(4)}, e_c^{(5)}, e_c^{(6)}\}$. Additionally: $n(e_c^{(1)}) = \{e_c^{(3)}, e_c^{(4)}\}$ and $N(e_c^{(1)}) = \{e_1, e_2, e_3, e_4\}$.

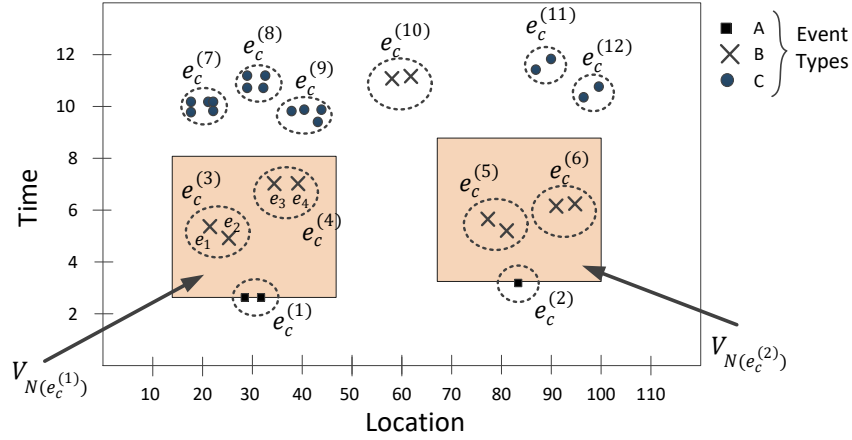

Fig. 5. An example of the dataset containing microclusters and their neighborhoods

Now we proceed with the description of the proposed Micro-ST-Miner algorithm. For a given dataset D containing events instances and their types, Algorithm 3 starts with computing microclustering index MC_D . Then, for any event type f , the algorithm creates 1-length sequence \vec{s} and expands it using the *ExpandSequence* procedure (our modification of the procedure already proposed in [13]).

Algorithm 3 Micro-ST-Miner - algorithm for discovering sequential patterns from event-based spatiotemporal data using microclustering index

Require: D - a dataset containing events instances, θ - significance threshold for sequence index.

Ensure: A set of significant sequential patterns.

- 1: Perform microclustering on the dataset D resulting in a microclustering index MC_D .
 - 2: **for** each event type f and its entries in $MC_D(f)$ **do**
 - 3: Create 1-length sequence \vec{s} from f .
 - 4: $\text{tailEventSet}(\vec{s}) := MC_D(f)$.
 - 5: $\text{ExpandSequence}(\vec{s}, MC_D, \theta)$.
 - 6: **end for**
-

In the next sections, we consider the problem of more efficient performing microclustering step presented in Algorithm 1. In particular, we propose to perform microclustering by means of triangle inequality, limit a number of instances

Algorithm 4 ExpandSequence(\vec{s} , MC_D , θ) procedure

Require: \vec{s} - a sequence of event types, MC_D - microclustering index created for D , θ - threshold for sequence index.

- 1: **for** each event type f and its entries in MC_D **do**
 - 2: Calculate SequenceIndex($\vec{s} \rightarrow f$).
 - 3: **if** value of the sequence index $\geq \theta$ **then**
 - 4: Remember $\vec{s} \rightarrow f$ as significant.
 - 5: tailEventSet($\vec{s} \rightarrow f$) := $\{n(e_c^{(1)}) \cup n(e_c^{(2)}) \cup \dots \cup n(e_c^{(n)})\}$
 where tailEventSet(\vec{s}) = $\{e_c^{(1)}, e_c^{(2)}, \dots, e_c^{(n)}\}$.
 - 6: ExpandSequence($(\vec{s} \rightarrow f)$, MC_D , θ).
 - 7: **end if**
 - 8: **end for**
-

Algorithm 5 Calculate SequenceIndex($\vec{s} \rightarrow f$) procedure

Require: $\vec{s} \rightarrow f$ - a sequence of event types; $k+1$ - the length of the sequence $\vec{s} \rightarrow f$

- 1: return min(SequenceIndex(\vec{s}), DensityRatio($\vec{s}[k] \rightarrow f$)).
-

contained in a microcluster or discuss other approaches to perform microclustering.

4.1 Other Extensions to the Microclustering Approach

In experimental results, we verify the usefulness of the approach where the size of each microgroup is limited by the number of contained instances. Algorithm 6 presents the modification, assuming that the maximal number of instances contained in a microcluster is denoted by K .

This approach is motivated by the fact, that some datasets may contain instances with very similar values of spatial coordinates. Consider for example a dataset where occurrences of event types are fixed (in spatial aspect) on some coordinates of a grid. This is often case for datasets containing weather or climate data. In such a case, despite small value of diameter threshold, it may be possible that a microcluster contains a significant number of instances. Due to quadratic complexity of Eq. 6 such situation may be undesirable when calculating diameter of the microcluster. The aim of Algorithm 6 is to tackle such situation.

Algorithm 6 proceeds similarly to Algorithm 1. Split operation is the same as shown in Algorithm 2. When an instance is inserted to the nearest microcluster, Algorithm 1 checks if the number of instances in the microcluster is greater than the user given parameter K . If this is true, the microcluster is split into two new microclusters. Diameters of these two microclusters are verified and, if this is needed, microclusters are split.

In future studies, it may be appropriate to adapt triangle inequality to more efficiently perform microclustering process [16,15].

Algorithm 6 Algorithm for microclustering dataset D using Eq. 6

Require: d - diameter threshold, D - dataset of instances, K - maximal number of instances in a microcluster.**Ensure:** MC_D - microclustering index for D .

```

1: for each event type  $f \in F$  do
2:   Take first instance  $e$  from  $D$ .
3:   Initialize first microcluster by inserting instance  $e$ .
4:   while There are instances in dataset  $D$  do
5:     Take next  $e$  from dataset  $D$  and insert it to the nearest  $e_c$ .
6:     if  $|e_c| > K$  then
7:       Split( $e_c$ ). ▷ Refer to Algorithm 2.
8:       if  $\mathcal{D}(e_c^{(i)}) > d$  then
9:         Split( $e_c^{(i)}$ ).
10:      end if
11:      if  $\mathcal{D}(e_c^{(j)}) > d$  then
12:        Split( $e_c^{(j)}$ ).
13:      end if
14:      else if  $\mathcal{D}(e_c^{(j)}) > d$  then
15:        Split( $e_c$ ).
16:      end if
17:    end while
18: end for

```

5 Experimental Results

In Table 3, we explain the main parameters of data generator. Our data generator is similar to proposed in [13,4]. Data generation method is as follows. For a spatio-temporal space V defined by parameters $DSize$ and $TSize$, the actual number of maximal patterns in a dataset is given by Pn , the maximal length of generated patterns is given by Ps . First, for each pattern we generate event types participating in this pattern. Event types are uniformly selected from the set of size Nf .

Patterns are generated as follows. For each event type in a pattern we generate Ni instances. Instances of the first event type are uniformly distributed in spatio-temporal space V of size $DSize * DSize * Tsize$. For each instance of the next event type, we randomly select instance of the previous event type and put it into spatio-temporal neighborhood space of that instance. This means, that the number of instances participating in a pattern is given by $Ps * Ni$. Additionally, we generate the same number of noise instances and distribute them uniformly in the embedding spatio-temporal space V . In the result, each dataset contains total number of instances $Ti = Ni * Ps * Pn * 2$.

Please note, that the word *maximal* means that generated pattern (sequence) contains also some subsequences that have to be discovered in a given dataset.

Table 3. Description of data generator parameters

Parameter name	Description
Ps	Length of a maximal generated sequence
Pn	Number of maximal sequences in generated data
$DSize$	Size of spatial dimension of embedding space V
$TSize$	Size of temporal dimension of embedding space V
Nf	Total number of event types available in data generator
Ni	Starting number of instances of the first event type participating in a pattern
\mathcal{R}	Size of spatial dimension of neighborhood space $V_{N(e)}$
\mathcal{T}	Size of temporal dimension of neighborhood space $V_{N(e)}$

5.1 Microclustering Step

Algorithm 1 has been applied to different datasets. We perform microclustering for datasets varying with number of event sequences, patterns length and patterns number. In our experiments, we generated datasets similar to [13]. In Table 4, we show microclustering index size and compression ratio for datasets with different number of event sequences. Compression ratio is calculated as the ratio of average dataset size divided by the microclustering index size. In Table 5.1, we show how compression ratio and microclustering index size is dependent on the number of patterns in a dataset. In Table 5.1, we provide microclustering index size and compression ratio for datasets with varying maximal pattern length.

Figures 6, 7 and 8 contain microclustering time (in milliseconds) for these three types of datasets. We perform experiments using four diameter threshold values: 40, 60, 80, 100. Results presented in Tables 4, 5.1, 5.1 and Figures 6, 7, 8 are obtained using Algorithm 1. We apply Algorithm 6 to real dataset.

5.2 Results for the Micro-ST-Miner Algorithm

We present here the results obtained for the Micro-ST-Miner algorithm and datasets described in Section 5. We set the sequence index threshold to constant 1. In Fig. 9, 10, 11 numbers 40, 60, 80, 100 are diameter thresholds for our Micro-ST-Miner algorithm. Additionally, ST-Miner algorithm was not able to obtain any results for generated datasets and sequence index threshold 1 in reasonable time.

Results presented in Fig. 9,10,11 show improvements of our Micro-ST-Miner algorithm over ST-Miner algorithm presented in [13]. The execution times obtained by our approach are much better than obtained by ST-Miner for the same types of datasets.

5.3 Results on Real Data

In our experiments, we used weather data provided by ECAD project [7,11]. The dataset contains the following event types: Temperature, Pressure and Percipi-

Table 4. Average dataset size, averages of reduced dataset size and Compression Ratio after applying microclustering algorithm to datasets with different event sequences values

Ps = 5, Pn = 10, Nf = 20, R = 10, T = 10, DSize = 1000, TSize = 1200						
Ni	Dataset size		Microcluster's diameter threshold			
			40	60	80	100
100	10000	Microclustering index size	7246	6502	5489	4451
		Compression Ratio	1.38007	1.53799	1.82183	2.24669
110	11000	Microclustering index size	7916	7045	5862	4695
		Compression Ratio	1.38959	1.56139	1.87649	2.34292
120	12000	Microclustering index size	8583	7564	6243	4947
		Compression Ratio	1.39811	1.58646	1.92215	2.42571
130	13000	Microclustering index size	9321	8129	6623	5184
		Compression Ratio	1.3947	1.59921	1.96286	2.50772
140	14000	Microclustering index size	9959	8619	6942	5399
		Compression Ratio	1.40576	1.62432	2.01671	2.59307
150	15000	Microclustering index size	10577	9101	7283	5601
		Compression Ratio	1.41817	1.64817	2.05959	2.67809
160	16000	Microclustering index size	11214	9560	7573	5787
		Compression Ratio	1.4267	1.67364	2.11277	2.76482

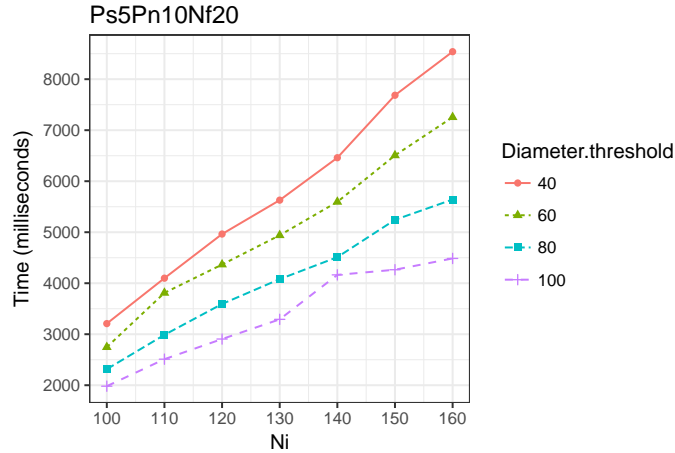

Fig. 6. Microclustering time for dataset varying in number of event sequences

tation provided in the gridded form. The resolution of each grid is 0.5 deg. and contains daily observations for years 1950-2016. The example of visualization may be found on the web page [1].

From the original dataset we extract abnormal events by taking for each event type observations from 0.01 quantile and with values greater than 0.99

Table 5. Average dataset size, averages of reduced dataset size and Compression Ratio after applying microclustering algorithm to datasets with different patterns number

Ps = 5, Ni = 100, Nf = 20, $\mathcal{R} = 10$, $\mathcal{T} = 10$, $DSize = 1000$, $TSize = 1200$						
Pn Dataset size		Microcluster's diameter threshold				
		40	60	80	100	
2	2000	Microclustering index size	1512	1469	1396	1303
		Compression Ratio	1.32275	1.36147	1.43266	1.53492
4	4000	Microclustering index size	2977	2837	2599	2311
		Compression Ratio	1.34363	1.40994	1.53905	1.73085
6	6000	Microclustering index size	4376	4085	3631	3126
		Compression Ratio	1.37112	1.46879	1.65244	1.91939
8	8000	Microclustering index size	5852	5349	4638	3855
		Compression Ratio	1.36705	1.49561	1.72488	2.07523
10	10000	Microclustering index size	7209	6461	5452	4421
		Compression Ratio	1.38715	1.54775	1.83419	2.26193
12	12000	Microclustering index size	8580	7562	6238	4933
		Compression Ratio	1.3986	1.58688	1.92369	2.4326
14	14000	Microclustering index size	9937	8611	6944	5379
		Compression Ratio	1.40888	1.62583	2.01613	2.60271
16	16000	Microclustering index size	11260	9589	7574	5785
		Compression Ratio	1.4209	1.66858	2.11249	2.76577
18	18000	Microclustering index size	12516	10506	8180	6147
		Compression Ratio	1.43816	1.71331	2.20049	2.92826
20	20000	Microclustering index size	13867	11470	8766	6508
		Compression Ratio	1.44221	1.74368	2.28154	3.07314

**Fig. 7.** Microclustering time for dataset varying in patterns number

Table 6. Average dataset size, averages of reduced dataset size and Compression Ratio after applying microclustering algorithm to datasets with different patterns length

Pn = 10, Ni = 100, Nf = 20, $\mathcal{R} = 10$, $\mathcal{T} = 10$, DSize = 1000, TSize = 1200						
Ps Dataset size			Microcluster's diameter threshold			
			40	60	80	100
2	4000	Microclustering index size	3505	3305	2998	2630
		Compression Ratio	1.14123	1.21029	1.33422	1.52091
3	6000	Microclustering index size	4883	4527	4000	3403
		Compression Ratio	1.22875	1.32538	1.5	1.76315
4	8000	Microclustering index size	6142	5600	4838	3986
		Compression Ratio	1.30251	1.42857	1.65358	2.00702
5	10000	Microclustering index size	7227	6505	5501	4451
		Compression Ratio	1.3837	1.53728	1.81785	2.24669
6	12000	Microclustering index size	8302	7327	6068	4822
		Compression Ratio	1.44543	1.63778	1.97759	2.48859
7	14000	Microclustering index size	9320	8099	6597	5141
		Compression Ratio	1.50215	1.72861	2.12218	2.72321
8	16000	Microclustering index size	10372	8903	7126	5484
		Compression Ratio	1.54261	1.79715	2.2453	2.91758
9	18000	Microclustering index size	11373	9630	7586	5755
		Compression Ratio	1.5827	1.86916	2.37279	3.12772
10	20000	Microclustering index size	12258	10272	7993	6003
		Compression Ratio	1.63159	1.94704	2.50219	3.33167

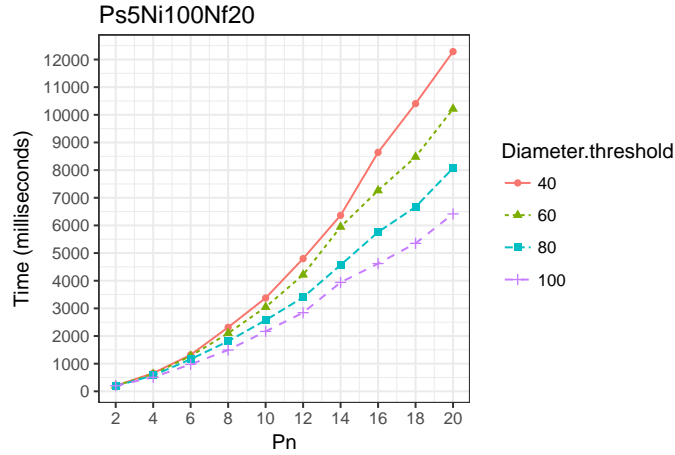
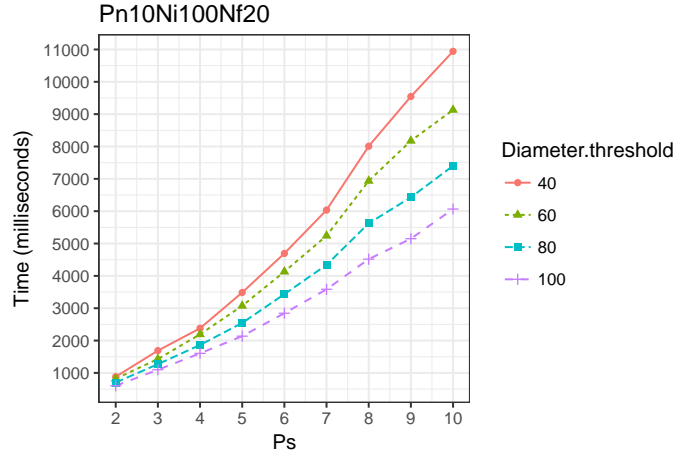

Fig. 8. Microclustering time for dataset varying in patterns length

quantile. This results in the following event types: *High Temperature, Low Temperature, High Pressure, Low Pressure, High Percipitation* (in our experiments

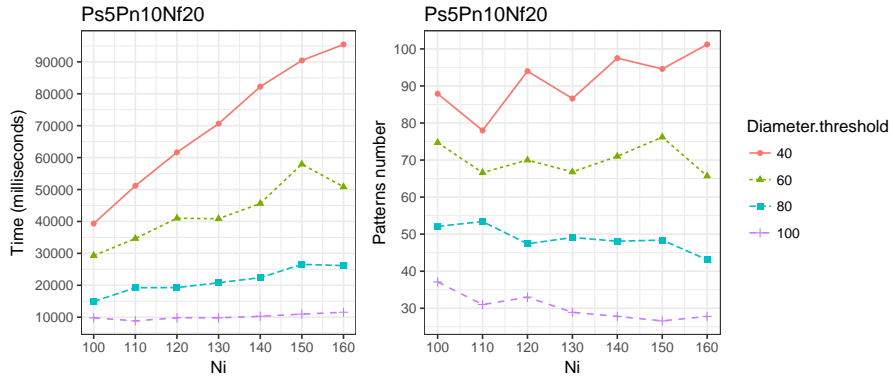

Fig. 9. Performance and number of discovered patterns with respect to number of event sequences

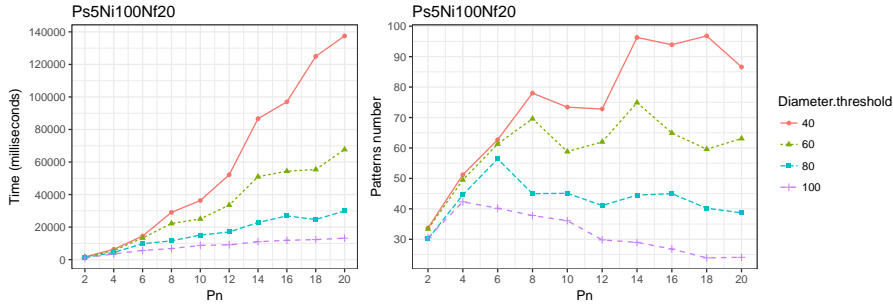

Fig. 10. Performance and number of discovered patterns with respect to number of maximal patterns in dataset

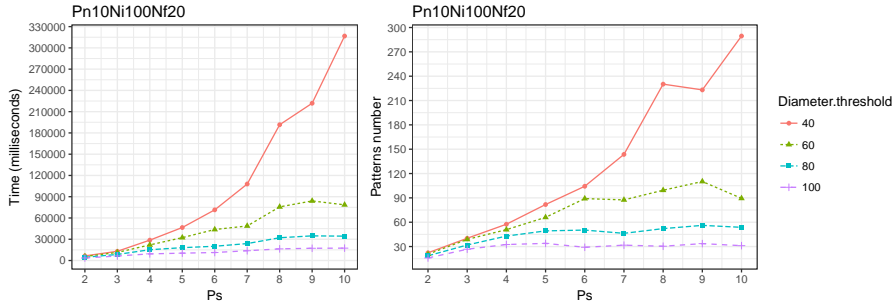

Fig. 11. Performance and number of discovered patterns with respect to maximal patterns length

we omit *Low Precipitation* event type). The resulting dataset contains 70922 instances. For the microclustering step we apply Algorithm 6 with K values

equal to: 20, 40, 60, 80, 100. Spatial and temporal diameters of microclusters are normalized and integrated into one diameter threshold as it was mentioned in Section 4. We set spatial diameter threshold to 2.5 deg. and temporal diameter threshold 30 days.

Table 7. Calculation time (in milliseconds), microclustering index size and compression ratio after applying microclustering algorithm for real dataset with number of instances equal to 70922

	K				
	20	40	60	80	100
Microclustering index size	5236	2618	1759	1334	1081
Compression ratio	13.5451	27.0901	40.3195	53.1649	65.6078
Microclustering time	55657	42106	45245	40015	38898

The set of possible patterns is as follows: *High Percipitation* \rightarrow *High Temperature*, *Low Pressure* \rightarrow *High Percipitation*, *Low Temperature* \rightarrow *Low Pressure* \rightarrow *High Percipitation*. All patterns have been discovered using our Micro-ST-Miner algorithm with sequence index threshold set to 1.

6 Conclusions

In the paper, we proposed modification of recently proposed notions and algorithms for the problem of discovering sequential patterns from event-based spatiotemporal data. The proposed method starts with computing microclustering index for a given dataset and appropriately redefining notions of neighborhood, density and density ratio. We offered our algorithm for the microclustering step and algorithms for computing significant sequential patterns using the reduced dataset. In summary, we have the following most important conclusions:

1. Results obtained for real dataset show the usefulness of proposed approach. However, future studies should focus on the more broad study of proposed approach using real datasets.
2. Presented experiments show the usefulness of the proposed algorithm for generated datasets. For generated datasets, ST-Miner was not able to obtain results in any reasonable time. Proposed Micro-ST-Miner algorithm allows to eliminate redundant and noise patterns from the dataset.

Further research problems in the described subject may focus on proposing methods for estimating or simulating appropriate value of the threshold of a pattern significance. Additionally, it may be shown that the above introduced definitions of density and space $V_{N(\epsilon)}$ are inappropriate for some datasets. In particular, for scenarios where occurrences of instances of one type attract with

significant delay occurrences of other events, definition of density is ineffective. Other possible research may propose alternative methods for discovering sequential patterns in spatiotemporal data adopting algorithms developed for mining association rules or considering the problem of efficient mining the K most important patterns.

Acknowledgements. We acknowledge the E-OBS dataset from the EU-FP6 project ENSEMBLES (<http://ensembles-eu.metoffice.com>) and the data providers in the ECA&D project (<http://www.ecad.eu>) "Haylock, M.R., N. Hofstra, A.M.G. Klein Tank, E.J. Klok, P.D. Jones, M. New. 2008: A European daily high-resolution gridded dataset of surface temperature and precipitation. *J. Geophys. Res (Atmospheres)*, 113, D20119, doi:10.1029/2008JD10201 [11]

We acknowledge the E-OBS dataset from the EU-FP6 project ENSEMBLES (<http://ensembles-eu.metoffice.com>) and the data providers in the ECA&D project (<http://www.ecad.eu>) "van den Besselaar, E.J.M., M.R. Haylock, G. van der Schrier and A.M.G. Klein Tank. 2011: A European Daily High-resolution Observational Gridded Data set of Sea Level Pressure. *J. Geophys. Res.*, 116, D11110, doi:10.1029/2010JD015468 [7]

We would like to kindly thank Professor Marzena Kryszkiewicz for her helpful comments and discussion during preparing the article.

References

1. Example of using e-obs data, http://eca.knmi.nl/maxtemp_EOBS.php
2. Agrawal, R., Srikant, R.: Mining sequential patterns. In: Proceedings of the Eleventh International Conference on Data Engineering. pp. 3–14 (Mar 1995)
3. Agrawal, R., Imieliński, T., Swami, A.: Mining association rules between sets of items in large databases. In: Proceedings of the 1993 ACM SIGMOD International Conference on Management of Data. pp. 207–216. SIGMOD '93, ACM, New York, NY, USA (1993), <http://doi.acm.org/10.1145/170035.170072>
4. Agrawal, R., Srikant, R.: Fast algorithms for mining association rules in large databases. In: Proceedings of the 20th International Conference on Very Large Data Bases. pp. 487–499. VLDB '94, Morgan Kaufmann Publishers Inc., San Francisco, CA, USA (1994), <http://dl.acm.org/citation.cfm?id=645920.672836>
5. Arge, L., Procopiuc, O., Ramaswamy, S., Suel, T., Vitter, J.S.: Scalable sweeping-based spatial join. In: Proceedings of the 24th International Conference on Very Large Data Bases. pp. 570–581. VLDB '98, Morgan Kaufmann Publishers Inc., San Francisco, CA, USA (1998), <http://dl.acm.org/citation.cfm?id=645924.671340>
6. Bembenik, R., Rybiński, H.: Farics: a method of mining spatial association rules and collocations using clustering and delaunay diagrams. *Journal of Intelligent Information Systems* 33(1), 41–64 (2009)
7. van den Besselaar, E.J.M., Haylock, M.R., van der Schrier, G., Klein Tank, A.M.G.: A european daily high-resolution observational gridded data set of sea level pressure. *Journal of Geophysical Research: Atmospheres* 116(D11), n/a–n/a (2011), <http://dx.doi.org/10.1029/2010JD015468>, d11110
8. Boinski, P., Zakrzewicz, M.: Algorithms for spatial collocation pattern mining in a limited memory environment: a summary of results. *Journal of Intelligent Information Systems* 43(1), 147–182 (2014)

9. Ester, M., Kriegel, H.P., Sander, J., Xu, X.: A density-based algorithm for discovering clusters in large spatial databases with noise. In: Second International Conference on Knowledge Discovery and Data Mining. pp. 226–231. AAAI Press (1996)
10. Han, J., Pei, J., Yin, Y., Mao, R.: Mining frequent patterns without candidate generation: A frequent-pattern tree approach. *Data Mining and Knowledge Discovery* 8(1), 53–87 (Jan 2004), <http://dx.doi.org/10.1023/B:DAMI.0000005258.31418.83>
11. Haylock, M.R., Hofstra, N., Klein Tank, A.M.G., Klok, E.J., Jones, P.D., New, M.: A european daily high-resolution gridded data set of surface temperature and precipitation for 1950–2006. *Journal of Geophysical Research: Atmospheres* 113(D20), n/a–n/a (2008), <http://dx.doi.org/10.1029/2008JD010201>, d20119
12. Huang, Y., Shekhar, S., Xiong, H.: Discovering colocation patterns from spatial data sets: a general approach. *IEEE Transactions on Knowledge and Data Engineering* 16(12), 1472–1485 (Dec 2004)
13. Huang, Y., Zhang, L., Zhang, P.: A framework for mining sequential patterns from spatio-temporal event data sets. *IEEE Transactions on Knowledge and Data Engineering* 20(4), 433–448 (April 2008)
14. Iyengar, V.S.: On detecting space-time clusters. In: Proceedings of the tenth ACM SIGKDD international conference on Knowledge discovery and data mining. pp. 587–592. ACM (2004)
15. Kryszkiewicz, M., Lasek, P.: A neighborhood-based clustering by means of the triangle inequality. In: International Conference on Intelligent Data Engineering and Automated Learning. pp. 284–291. Springer, Berlin, Heidelberg (2010)
16. Kryszkiewicz, M., Lasek, P.: Ti-dbscan: Clustering with dbscan by means of the triangle inequality. In: Rough sets and current trends in computing. pp. 60–69. Springer Berlin/Heidelberg (2010)
17. Lee, J.G., Han, J., Whang, K.Y.: Trajectory clustering: A partition-and-group framework. In: Proceedings of the 2007 ACM SIGMOD International Conference on Management of Data. pp. 593–604. SIGMOD '07, ACM, New York, NY, USA (2007), <http://doi.acm.org/10.1145/1247480.1247546>
18. Li, Z.: Spatiotemporal Pattern Mining: Algorithms and Applications, pp. 283–306. Springer International Publishing, Cham (2014)
19. Mamoulis, N., Cao, H., Kollios, G., Hadjieleftheriou, M., Tao, Y., Cheung, D.W.: Mining, indexing, and querying historical spatiotemporal data. In: Proceedings of the Tenth ACM SIGKDD International Conference on Knowledge Discovery and Data Mining. pp. 236–245. KDD '04, ACM, New York, NY, USA (2004), <http://doi.acm.org/10.1145/1014052.1014080>
20. Nanni, M., Pedreschi, D.: Time-focused clustering of trajectories of moving objects. *Journal of Intelligent Information Systems* 27(3), 267–289 (2006)
21. Ng, R.T., Han, J.: Clarans: A method for clustering objects for spatial data mining. *IEEE Trans. on Knowl. and Data Eng.* 14(5), 1003–1016 (Sep 2002)
22. Srikant, R., Agrawal, R.: Mining sequential patterns: Generalizations and performance improvements, pp. 1–17. Springer Berlin Heidelberg, Berlin, Heidelberg (1996), <http://dx.doi.org/10.1007/BFb0014140>
23. Wang, S., Cai, T., Eick, C.F.: New spatiotemporal clustering algorithms and their applications to ozone pollution. In: Proceedings of the 2013 IEEE 13th International Conference on Data Mining Workshops. pp. 1061–1068. ICDMW '13, IEEE Computer Society, Washington, DC, USA (2013)
24. Wang, S., Eick, C.F.: A polygon-based clustering and analysis framework for mining spatial datasets. *GeoInformatica* 18(3), 569–594 (2014)

25. Zhang, T., Ramakrishnan, R., Livny, M.: Birch: An efficient data clustering method for very large databases. In: Proceedings of the 1996 ACM SIGMOD International Conference on Management of Data. pp. 103–114. SIGMOD '96, ACM, New York, NY, USA (1996), <http://doi.acm.org/10.1145/233269.233324>