

# UNION OF 3-PUNCTURED SPHERES IN HYPERBOLIC 3-MANIFOLDS

KEN'ICHI YOSHIDA

## Abstract

We classify the topological types for the union of the totally geodesic 3-punctured spheres in orientable hyperbolic 3-manifolds. General types of the union appear in various hyperbolic 3-manifolds. Each of special types of the union appears only in a single hyperbolic 3-manifold or Dehn fillings of a single hyperbolic 3-manifold. Furthermore, we investigate bounds of the moduli of adjacent cusps for the union of linearly placed 3-punctured spheres.

## 1 Introduction

In this paper, we consider totally geodesic 3-punctured spheres in orientable hyperbolic 3-manifolds. We regard a hyperbolic 3-manifold as a 3-manifold with toroidal boundary whose interior admits a complete hyperbolic metric. Thus an orientable hyperbolic 3-manifold of finite volume is a compact 3-manifold with (possibly empty) boundary consisting of tori. Such toroidal boundary components of a hyperbolic 3-manifold are called cusps. The upper half-space model gives the identifications of the ideal boundary  $\partial\mathbb{H}^3 \cong \widehat{\mathbb{C}} = \mathbb{C} \cup \{\infty\}$  and the group of the orientation-preserving isometries  $\text{Isom}^+(\mathbb{H}^3) \cong \text{PSL}(2, \mathbb{C})$ . A neighborhood of a torus cusp is isometric to a neighborhood of the image of  $\infty$  in  $\mathbb{H}^3/G$ , where  $G \cong \mathbb{Z}^2$  is a group that consists of parabolic elements fixing  $\infty$ . Thus a cusp admits the natural Euclidean structure up to scaling.

A compact orientable surface of genus zero with three boundary components is called a 3-punctured sphere. We always assume that the boundary of a 3-punctured sphere in a hyperbolic 3-manifold is contained in the cusps. Adams [1] showed that an essential 3-punctured sphere in an orientable hyperbolic 3-manifold is isotopic to a totally geodesic one. A totally geodesic 3-punctured sphere is isometric to the double of an ideal triangle in the hyperbolic plane  $\mathbb{H}^2$ . Moreover, the hyperbolic structure of a 3-punctured sphere is unique up to isometry. After we cut a hyperbolic 3-manifold along a totally geodesic 3-punctured sphere, we can glue it again by an isometry along the new boundary. Since there are six orientation-preserving isometries of a totally geodesic 3-punctured sphere, we can construct hyperbolic 3-manifolds with a common volume.

We remark on an immersed 3-punctured sphere. The existence of a non-embedded immersed 3-punctured sphere almost determines the ambient hyperbolic 3-manifold.

**Theorem 1.1** (Agol [3]). *Let  $\Sigma$  be an immersed 3-punctured sphere in an orientable hyperbolic 3-manifold  $M$ . Suppose that  $\Sigma$  is not homotopic to an embedded one. Then  $M$  is obtained by a (possibly empty) Dehn filling on a cusp of the Whitehead link complement. Furthermore,  $\Sigma$  is homotopic to a totally geodesic 3-punctured sphere immersed in  $M$  as shown in Figure 1.*

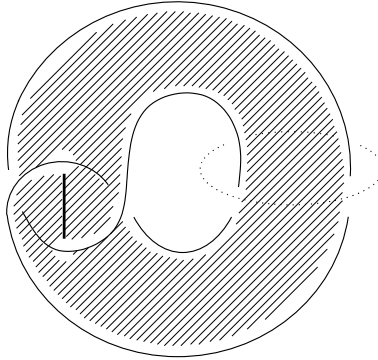

Figure 1: Non-embedded 3-punctured sphere

From now on, we consider embedded totally geodesic 3-punctured spheres. If all the 3-punctured spheres in a hyperbolic 3-manifold are disjoint, we can standardly decompose the 3-manifold along the 3-punctured spheres. However, 3-punctured spheres may intersect. Thus we consider all the 3-punctured spheres. Although the unions of 3-punctured spheres may be complicated, we can classify them. The JSJ decomposition of an irreducible orientable 3-manifold gives atoroidal pieces and Seifert pieces, and then every essential torus in the 3-manifold can be isotoped into a Seifert piece. Theorem 1.2 can be regarded as an analog of the classification of the Seifert 3-manifolds.

**Theorem 1.2.** *Let  $M$  be an orientable hyperbolic 3-manifold with finitely many cusps. Suppose that  $X$  is a connected component of the union of all the (embedded) totally geodesic 3-punctured spheres in  $M$ . Then  $X$  is one of the following types:*

- (general types)  
 $A_n(n \geq 1), B_{2n}(n \geq 1), T_3, T_4.$
- (types determining the manifolds)  
 $Whi_{2n}(n \geq 2), Whi'_{4n}(n \geq 2), Bor_6, Mag_4, Tet_8, Pen_{10}, Oct_8.$
- (types almost determining the manifolds)  
 $\widehat{Whi}_n(n \geq 2), \widehat{Whi}'_{2n}(n \geq 1), \widehat{Tet}_2, \widehat{Pen}_4, \widehat{Oct}_4.$

Here we classify the topological type of a pair  $(N(X), X)$ , where  $N(X)$  is a regular neighborhood of  $X$ . The indices indicate the numbers of 3-punctured spheres.

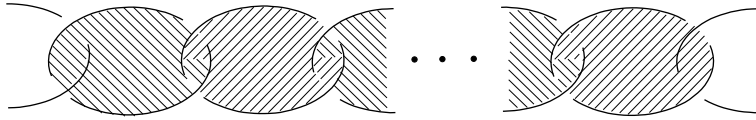

Figure 2:  $A_n$

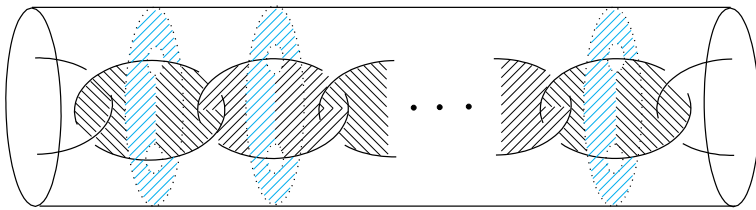

Figure 3:  $B_{2n}$

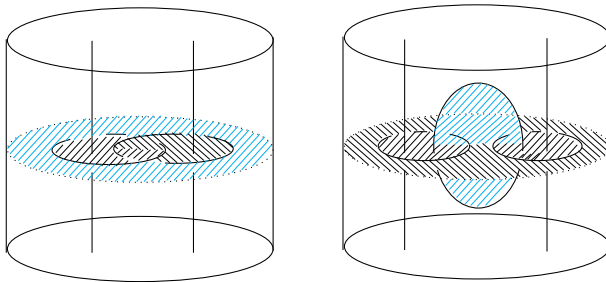

Figure 4:  $T_3$  and  $T_4$

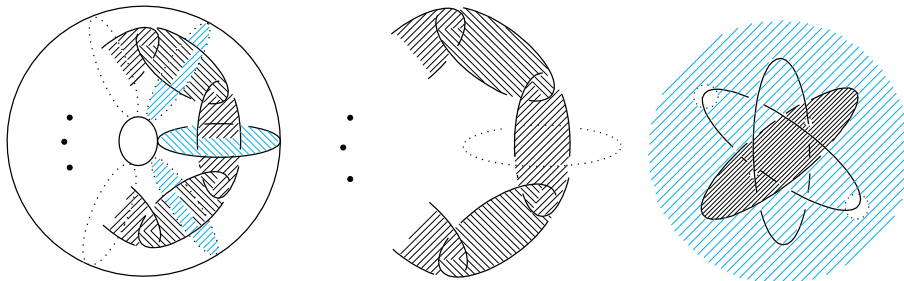

Figure 5:  $Whi^{(l)}_{2n}$ ,  $\widehat{Whi^{(l)}}_n$ , and  $Bor_6$

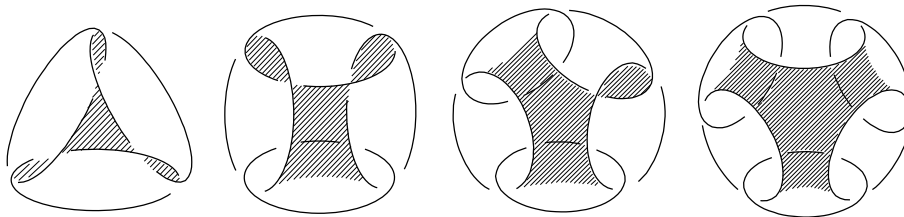

Figure 6:  $Mag_4$ ,  $Tet_8$ ,  $Pen_{10}$ , and  $Oct_8$

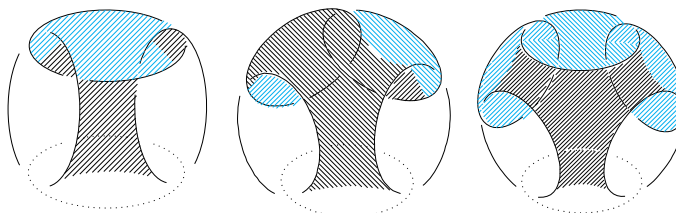

Figure 7:  $\widehat{Tet}_2$ ,  $\widehat{Pen}_4$ , and  $\widehat{Oct}_4$

The general types appear in various manifolds. For any finite multiset of general types, there are infinitely many hyperbolic 3-manifolds containing 3-punctured spheres of such types. When the type  $B_{2n}$ ,  $T_3$ , or  $T_4$  appears, there are additional isolated 3-punctured spheres near it. Contrastingly, each of the determining types appears only in a certain special manifold. The almost determining types appear only in manifolds obtained by Dehn fillings of such special manifolds. For each  $n \geq 2$ , the types  $Whi_{4n}$  and  $Whi'_{4n}$  have the common topology of the union, but they are distinguished by their neighborhoods. The same argument holds for  $\widehat{Whi}_{2n}$  and  $\widehat{Whi}'_{2n}$ .

For  $3 \leq n \leq 6$ , let  $\mathbb{M}_n$  denote the minimally twisted hyperbolic  $n$ -chain link complement as shown in Figure 6. The 3-punctured spheres of the types  $Mag_4$ ,  $Tet_8$ ,  $Pen_{10}$ , and  $Oct_8$  are respectively contained only in the manifolds  $\mathbb{M}_3$ ,  $\mathbb{M}_4$ ,  $\mathbb{M}_5$ , and  $\mathbb{M}_6$ . These manifolds are quite special for several reasons. Agol [4] conjectured that they have the smallest volume of the  $n$ -cusped orientable hyperbolic 3-manifolds. This conjecture was proven for  $\mathbb{M}_4$  by the author [31].

The manifold  $\mathbb{M}_3$  is called the magic manifold by Gordon and Wu [14]. It is known that many interesting examples are obtained by Dehn fillings of  $\mathbb{M}_3$ . For example, Kin and Takasawa [20] showed that some mapping tori of punctured disk fibers with small entropy appear as Dehn fillings of  $\mathbb{M}_3$ . The manifold  $\mathbb{M}_5$  is known to give most of the census manifolds [9] by Dehn fillings. Martelli, Petronio, and Roukema [24] classified the non-hyperbolic manifolds obtained by Dehn fillings of  $\mathbb{M}_5$ . Kolpakov and Martelli [21] constructed the first examples of finite volume hyperbolic 4-manifolds with exactly one cusp by using  $\mathbb{M}_6$ . Baker [5] showed that every link in  $S^3$  is a sublink of a link whose complement

is a covering of  $\mathbb{M}_6$ . He then used the link in Figure 8. We can show that the complement of this link is homeomorphic to  $\mathbb{M}_6$  by finding eight 3-punctured spheres of the type  $Oct_8$  (see also [19, Lemma 5.9]).

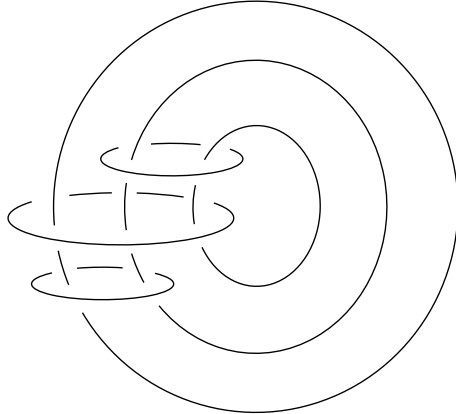

Figure 8: A link whose complement is  $\mathbb{M}_6$

Moreover, the manifolds  $\mathbb{M}_3, \mathbb{M}_4, \mathbb{M}_5$ , and  $\mathbb{M}_6$  are arithmetic hyperbolic 3-manifolds. A cusped finite volume hyperbolic 3-manifold is arithmetic if and only if its fundamental group is commensurable to a Bianchi group  $\mathrm{PSL}(2, \mathcal{O}_d)$ , where  $\mathcal{O}_d$  is the ring of integers of the imaginary quadratic field  $\mathbb{Q}(\sqrt{-d})$  (see [22, Ch. 8] for more details). Thurston [29, Ch. 6] gave an explicit representation of  $\pi_1(\mathbb{M}_3)$  as a subgroup of  $\mathrm{PSL}(2, \mathcal{O}_7)$ . Baker [5] gave an explicit representation of  $\pi_1(\mathbb{M}_4)$  as a subgroup of  $\mathrm{PSL}(2, \mathcal{O}_1)$ , and showed that  $\mathbb{M}_6$  is a double covering of  $\mathbb{M}_4$ . The fundamental group of the Whitehead link complement is also commensurable to  $\mathrm{PSL}(2, \mathcal{O}_1)$ . Hatcher [15] showed that the fundamental group of a hyperbolic 3-manifold obtained from regular ideal tetrahedra (resp. regular ideal octahedra) is commensurable to  $\mathrm{PSL}(2, \mathcal{O}_3)$  (resp.  $\mathrm{PSL}(2, \mathcal{O}_1)$ ). As we will describe in Section 2, the manifold  $\mathbb{M}_5$  can be decomposed into ten regular ideal tetrahedra. Hence  $\pi_1(\mathbb{M}_5)$  is commensurable to  $\mathrm{PSL}(2, \mathcal{O}_3)$ . In addition, Kin and Rolfsen [19] studied bi-orderability of their fundamental groups.

## 2 Description of the types of the unions of 3-punctured spheres

In this section we describe the types of the unions of 3-punctured spheres in Theorem 1.2. This section concerns the existence of the 3-punctured spheres. In Section 3 we will show that each special manifold has no other 3-punctured spheres than the described ones.

We first introduce the manifolds containing the 3-punctured spheres of special types. Let  $\mathbb{W}_n$  denote the manifold as shown in the left of Figure 5 that

is an  $n$ -sheeted cyclic cover of the Whitehead link complement. Let  $\mathbb{W}'_n$  denote the manifold obtained by a half twist along a blue 3-punctured sphere of  $\mathbb{W}_n$ , which can be also shown in the left of Figure 5. The manifolds  $\mathbb{W}_n$  and  $\mathbb{W}'_n$  are homeomorphic to certain link complements. For odd  $n$ , the manifold  $\mathbb{W}'_n$  is homeomorphic to  $\mathbb{W}_n$  by reversing orientation. Kaiser, Purcell and Rollins [18] described more details on these manifolds. Note that our notations are different from theirs. The manifolds  $\mathbb{W}_{2n-1}, \mathbb{W}_{4n-2}, \mathbb{W}_{4n}, \mathbb{W}'_{4n-2}$ , and  $\mathbb{W}'_{4n}$  are respectively homeomorphic to  $\widehat{W}_{2n-1}, \overline{W}_{4n-2}, \widehat{W}_{4n}, \widehat{W}_{4n-2}$ , and  $\overline{W}_{4n}$  in [18].

It is well known that the Whitehead link complement  $\mathbb{W}_1$  can be decomposed into a regular ideal octahedron. Hence  $\text{vol}(\mathbb{W}_n) = \text{vol}(\mathbb{W}'_n) = nV_{oct}$ , where  $V_{oct} = 3.6638\dots$  is the volume of a regular ideal octahedron. At present, this is the smallest known volume of the  $(n+1)$ -cusped orientable hyperbolic 3-manifolds for  $n \geq 10$ . The manifold  $\mathbb{W}'_2$  is the Borromean rings complement. We recall that the manifolds  $\mathbb{M}_3, \dots, \mathbb{M}_6$  are the minimally twisted hyperbolic  $n$ -chain link complements for  $n = 3, \dots, 6$  as shown in Figure 6.

The 3-punctured spheres of the types  $Whi_{2n}, Whi'_{4n}, Bor_6, Mag_4, Tet_8, Pen_{10}$ , and  $Oct_8$  are respectively contained only in the manifolds  $\mathbb{W}_n, \mathbb{W}'_{2n}, \mathbb{W}'_2, \mathbb{M}_3, \mathbb{M}_4, \mathbb{M}_5$ , and  $\mathbb{M}_6$ . Let  $X$  be the union of the 3-punctured spheres of such a special type. The union of  $X$  with the adjacent cusps has a regular neighborhood whose boundary consists of spheres. The ambient hyperbolic 3-manifold is determined since it is irreducible.

The Borromean rings complement  $\mathbb{W}'_2$  contains six 3-punctured spheres of the type  $Bor_6$  instead of  $Whi'_4$ . In order to display them, we put the Borromean rings so that each component is contained in a plane in  $\mathbb{R}^3$ . Then there are two 3-punctured spheres in the union of each plane with the infinite point as shown in the right of Figure 5.

The 3-punctured spheres of the type  $A_n$  are placed linearly, and can be regarded as the most general types. We consider an isolated 3-punctured sphere as the type  $A_1$ . For example, an appropriate Dehn filling of  $\mathbb{W}_{n+3}$  gives a manifold with 3-punctured spheres of the type  $A_n$ . If 3-punctured spheres are placed cyclically, their union is the type  $\widehat{Whi}_n$  or  $\widehat{Whi}'_{2n}$ . The union of 3-punctured spheres of the type  $\widehat{Whi}_n$  or  $\widehat{Whi}'_{2n}$  with the adjacent cusps has a regular neighborhood homeomorphic to  $\mathbb{W}_n$  or  $\mathbb{W}'_{2n}$ . Hence if a hyperbolic 3-manifold contains such 3-punctured spheres, it is obtained by a Dehn filling on a cusp of  $\mathbb{W}_n$  or  $\mathbb{W}'_{2n}$ . In fact, such a surgered hyperbolic 3-manifold except  $\mathbb{M}_3, \dots, \mathbb{M}_6$  contains no more 3-punctured spheres. The manifolds  $\mathbb{M}_3, \dots, \mathbb{M}_6$  contain more 3-punctured spheres as shown in Figure 6. Rotational symmetry gives the remaining 3-punctured spheres. We remark that the Whitehead link complement  $\mathbb{W}_1$  has two 3-punctured spheres of the type  $\widehat{Whi}'_2$ .

The types  $\widehat{Tet}_2, \widehat{Pen}_4$ , and  $\widehat{Oct}_4$  respectively appear only in the hyperbolic manifolds obtained by Dehn fillings on a cusp of  $\mathbb{M}_4, \mathbb{M}_5$ , and  $\mathbb{M}_6$ . Such a surgered hyperbolic 3-manifold except  $\mathbb{M}_3, \mathbb{M}_4$ , and  $\mathbb{M}_5$  contains no more 3-punctured spheres. The 3-punctured spheres of the types  $\widehat{Tet}_2, \widehat{Pen}_4$ , and  $\widehat{Oct}_4$  come from the ones of the types  $Tet_8, Pen_{10}$ , and  $Oct_8$  that are disjoint from the filled cusps.

We describe the remaining general types. For  $n \geq 1$ , let  $\mathbb{B}_n$  denote the hyperbolic 3-manifold with totally geodesic boundary obtained by cutting  $\mathbb{W}_n$  along a blue 3-punctured sphere shown in the right of Figure 5. The manifold  $\mathbb{B}_1$  can be decomposed into a regular ideal octahedron as shown in Figure 9, where faces  $X$  and  $X'$  are glued so that the orientations of edges match. We will use this decomposition in Section 5. Similarly, let  $\mathbb{T}_3$  and  $\mathbb{T}_4$  denote the hyperbolic 3-manifolds with totally geodesic boundary respectively obtained by cutting  $\mathbb{M}_5$  and  $\mathbb{M}_6$  along a 3-punctured sphere.

The manifolds  $\mathbb{B}_{n+1}$ ,  $\mathbb{T}_3$ , and  $\mathbb{T}_4$  respectively contain the 3-punctured spheres of the types  $B_{2n}$ ,  $T_3$ , and  $T_4$ . If there are the 3-punctured spheres of the type  $B_{2n}$ ,  $T_3$ , or  $T_4$ , there are two (possibly identical) isolated 3-punctured spheres that correspond to the boundary of  $\mathbb{T}_3$ ,  $\mathbb{T}_4$ , or  $\mathbb{B}_{n+1}$ .

The 3-punctured spheres of the type  $T_3$  intersect at a common geodesic. The type  $T_3$  is symmetric. Namely, for any pair of 3-punctured spheres in  $\mathbb{T}_3$ , there is an isometry of  $\mathbb{T}_3$  that maps one of the pair to the other. A 3-punctured sphere of the type  $T_4$  intersects the three other 3-punctured spheres. The latter three 3-punctured spheres are symmetric.

While neighborhoods of 3-punctured spheres of the types  $B_{2n}$ ,  $T_3$ , and  $T_4$  are isometrically determined, a neighborhood of 3-punctured spheres of the type  $A_n$  for  $n \geq 2$  depends on the modulus of an adjacent cusp. We will consider this modulus in Section 5.

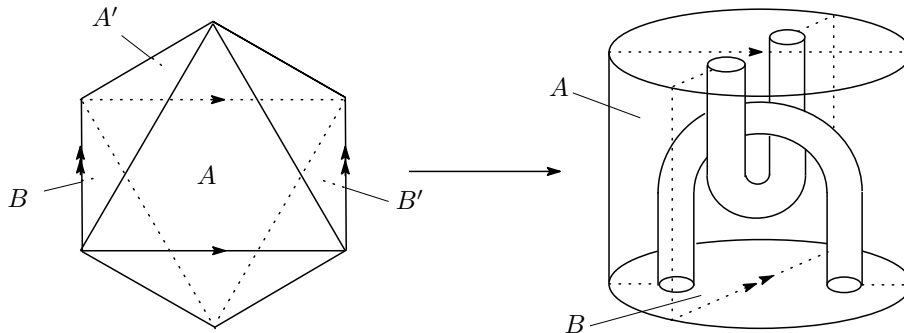

Figure 9: Gluing of a regular ideal octahedron for  $\mathbb{B}_1$

The central 3-punctured sphere of  $\mathbb{M}_3$  in Figure 6 is special in the sense that this is the unique 3-punctured sphere intersecting any other one at two geodesics. Contrastingly, for any pair of the 3-punctured spheres in  $\mathbb{M}_4$ ,  $\mathbb{M}_5$ , or  $\mathbb{M}_6$ , the manifold has an isometry that maps one of the pair to the other.

Following Dunfield and Thurston [10], we describe the manifolds  $\mathbb{M}_4$ ,  $\mathbb{M}_5$ , and  $\mathbb{M}_6$  with respect to their intrinsic symmetry. Each of  $\mathbb{M}_4$ ,  $\mathbb{M}_5$ , and  $\mathbb{M}_6$  has an involutorial isometry that rotates about the blue circle in Figure 10. The quotients by these involutions are naturally decomposed into ideal polyhedra. Then the original manifolds are recovered by the double branched coverings. The quotient of  $\mathbb{M}_5$  is the boundary of a 4-dimensional simplex (a.k.a. pentachoron)

made of five regular ideal tetrahedra. The quotient of  $\mathbb{M}_6$  is the double of a regular ideal octahedron. The quotient of  $\mathbb{M}_4$  is decomposed into four ideal tetrahedra whose dihedral angles are  $\pi/4, \pi/4$ , and  $\pi/2$ . Each 3-punctured sphere in  $\mathbb{M}_4, \mathbb{M}_5$ , and  $\mathbb{M}_6$  is the preimage of a face of these ideal polyhedra by the double branched covering. In particular, the manifolds  $\mathbb{M}_4, \mathbb{M}_5$ , and  $\mathbb{M}_6$  have isometries that can map a 3-punctured sphere to any other one.

If we cut the manifolds  $\mathbb{M}_3, \mathbb{M}_4, \mathbb{M}_5$ , and  $\mathbb{M}_6$  along all the 3-punctured spheres, we respectively obtain two ideal triangular prisms, eight ideal tetrahedra each of which is a quarter of a regular ideal octahedron, ten regular ideal tetrahedra, and four regular ideal octahedra. By Sakuma and Weeks [27], these are the canonical decompositions in the sense of Epstein and Penner [11].

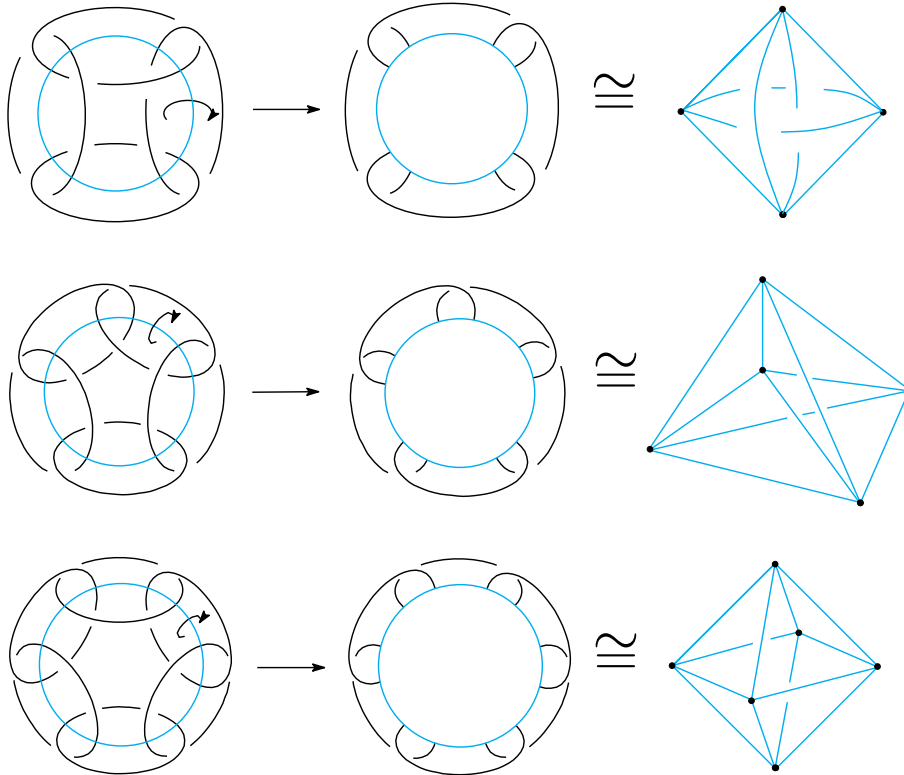

Figure 10: Quotient of  $\mathbb{M}_4, \mathbb{M}_5$ , and  $\mathbb{M}_6$

In Figure 11, we give graphs that indicate how the 3-punctured spheres intersect. The vertices of a graph correspond to the 3-punctured spheres. Two vertices are connected by an edge if the corresponding 3-punctured spheres intersect. Two vertices are connected by two edges if the corresponding 3-punctured spheres intersect at two geodesics. An edge is oriented if the 3-punctured spheres corresponding to the endpoints intersect as the type (ii) in



Lemma 3.1. Our notation  $T_3$  and  $T_4$  come from the triangle and tripod of the graphs.

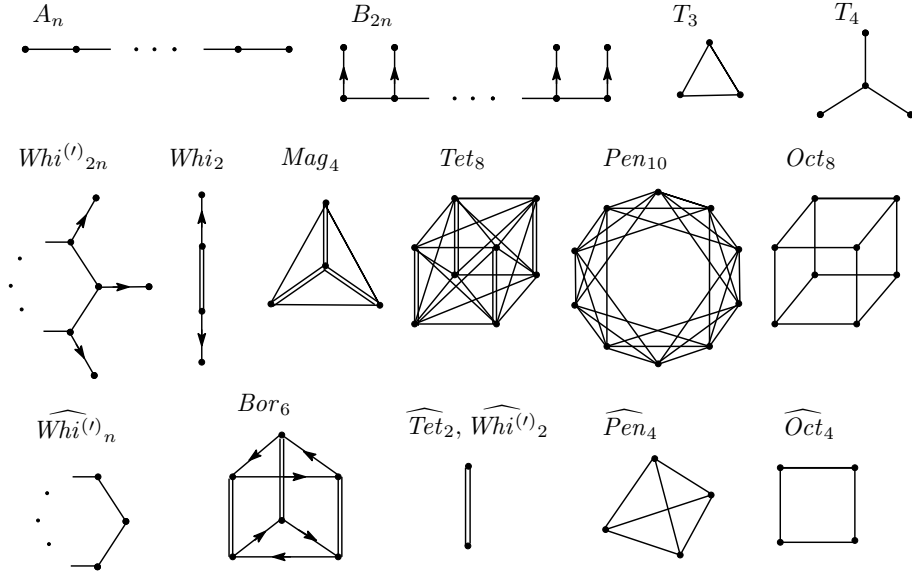

Figure 11: Graphs indicating intersection of 3-punctured spheres

We remark that the assumption of orientability is necessary. For instance, we can obtain a non-orientable hyperbolic 3-manifold  $\mathbb{N}_3$  by gluing one regular ideal octahedron as shown in Figure 12. The manifold  $\mathbb{N}_3$  was given by Adams and Sherman [2] as the 3-cusped hyperbolic 3-manifold of minimal complexity. We remark that the manifold  $\mathbb{M}_5$  is the 5-cusped hyperbolic 3-manifold of minimal complexity. The pairs of faces  $A \cup B$  and  $C \cup D$  are mapped to two 3-punctured spheres in  $\mathbb{N}_3$ . These 3-punctured spheres intersect at three geodesics. Such intersection does not appear in an orientable hyperbolic 3-manifold as we will show in Lemma 3.2.

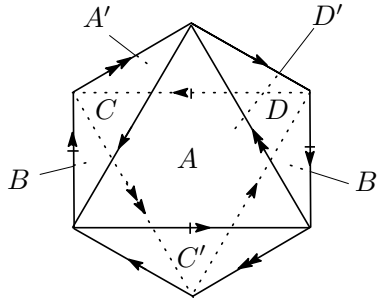

Figure 12: Gluing of a regular ideal octahedron for  $\mathbb{N}_3$

### 3 Proof of the classification

We begin to prove Theorem 1.2. We consider totally geodesic 3-punctured spheres in an orientable hyperbolic 3-manifold with finitely many cusps. For simplicity, we assume that every 3-punctured sphere is totally geodesic. There are six simple geodesics in a 3-punctured sphere. Three of them are non-separating, and the other three are separating as shown in Figure 13. We first consider the intersection of two 3-punctured spheres.

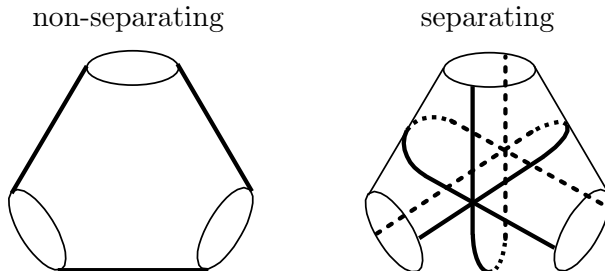

Figure 13: The simple geodesics in a 3-punctured sphere

**Lemma 3.1.** *The intersection of two 3-punctured spheres in an orientable hyperbolic 3-manifold is one of the following types:*

- (o) *The intersection is empty, i.e. the two 3-punctured spheres are disjoint.*
- (i) *The intersection consists of one simple geodesic that is non-separating in both 3-punctured spheres.*
- (ii) *The intersection consists of one simple geodesic that is non-separating in a 3-punctured sphere and separating in the other 3-punctured sphere.*
- (iii) *The intersection consists of two simple geodesics that are non-separating in both 3-punctured spheres.*

*Proof.* We show that the other types of intersection are impossible. The intersection of two 3-punctured spheres consists of disjoint simple geodesics. There are at most three disjoint simple geodesics in a 3-punctured sphere. We first show that the intersection of two 3-punctured spheres does not consist of three geodesics.

**Lemma 3.2.** *Let  $M$  be a possibly non-orientable hyperbolic 3-manifold. Suppose that  $M$  contains 3-punctured spheres  $\Sigma_0$  and  $\Sigma_1$  that intersect at three geodesics. Then  $M$  is decomposed into a regular ideal octahedron along  $\Sigma_0$  and  $\Sigma_1$ . Furthermore,  $M$  is non-orientable.*

*Proof.* We regard the hyperbolic 3-space  $\mathbb{H}^3$  as the universal covering of  $M$ , and use the upper-half space model of  $\mathbb{H}^3$ . We denote by  $\overline{(a,b)}$  the geodesic in  $\mathbb{H}^3$  whose endpoints are  $a, b \in \widehat{\mathbb{C}} = \partial\mathbb{H}^3$ . Let  $\widetilde{\Sigma}_i \subset \mathbb{H}^3$  denote the preimage of  $\Sigma_i$

for  $i = 0, 1$ . Let  $\tilde{\Sigma}_0^0$  be a component of  $\tilde{\Sigma}_0$ . The plane  $\tilde{\Sigma}_0^0$  contains an ideal triangle  $\Delta$  whose edges are lifts of the intersection  $\Sigma_0 \cap \Sigma_1$ . We may assume that the vertices of  $\Delta$  are  $0, 1, \infty \in \hat{\mathbb{C}} = \partial\mathbb{H}^3$ . Hence there are components  $\tilde{\Sigma}_1^k$  of  $\tilde{\Sigma}_1$  for  $k = 0, 1, 2$  such that  $\tilde{\Sigma}_0^0 \cap \tilde{\Sigma}_1^0 = \overline{(0, \infty)}$ ,  $\tilde{\Sigma}_0^0 \cap \tilde{\Sigma}_1^1 = \overline{(1, \infty)}$ , and  $\tilde{\Sigma}_0^0 \cap \tilde{\Sigma}_1^2 = \overline{(0, 1)}$ . Since  $\Sigma_1$  is embedded in  $M$ , the three planes  $\tilde{\Sigma}_1^0, \tilde{\Sigma}_1^1$ , and  $\tilde{\Sigma}_1^2$  are mutually disjoint. Therefore  $\tilde{\Sigma}_1^0, \tilde{\Sigma}_1^1$ , and  $\tilde{\Sigma}_1^2$  orthogonally intersect  $\tilde{\Sigma}_0^0$ .

In the same manner, there are components  $\tilde{\Sigma}_0^1$  and  $\tilde{\Sigma}_0^2$  of  $\tilde{\Sigma}_0$  such that  $\tilde{\Sigma}_0^1 \cap \tilde{\Sigma}_1^0 = \overline{(ai, \infty)}$  and  $\tilde{\Sigma}_0^2 \cap \tilde{\Sigma}_1^0 = \overline{(0, ai)}$  for  $a > 0$ . The planes  $\tilde{\Sigma}_0^1$  and  $\tilde{\Sigma}_0^2$  orthogonally intersect  $\tilde{\Sigma}_1^0$ .

We continue the same argument. Since each of the preimages of  $\Sigma_0$  and  $\Sigma_1$  consists of disjoint planes, we have  $a = 1$ . There are components  $\tilde{\Sigma}_j^k$  of  $\tilde{\Sigma}_j$  such that  $\tilde{\Sigma}_0^3 \cap \tilde{\Sigma}_1^1 = \overline{(1, 1+i)}$  and  $\tilde{\Sigma}_0^1 \cap \tilde{\Sigma}_1^3 = \overline{(i, 1+i)}$ . Figure 14 shows the boundary of these planes in  $\hat{\mathbb{C}}$ . The planes  $\tilde{\Sigma}_j^k$  for  $j = 0, 1$  and  $k = 0, 1, 2, 3$  bound a regular ideal octahedron. The other components of  $\tilde{\Sigma}_0$  and  $\tilde{\Sigma}_1$  are disjoint from this regular ideal octahedron. An isometry of a regular ideal octahedron has a fixed point in the interior. Consequently, if  $M$  is decomposed along  $\Sigma_0$  and  $\Sigma_1$ , one of the components after the decomposition is a regular ideal octahedron. Now the surface area of a regular ideal octahedron is equal to  $8\pi$ , and the area of a 3-punctured sphere is equal to  $2\pi$ . Therefore there are no other components after the decomposition.

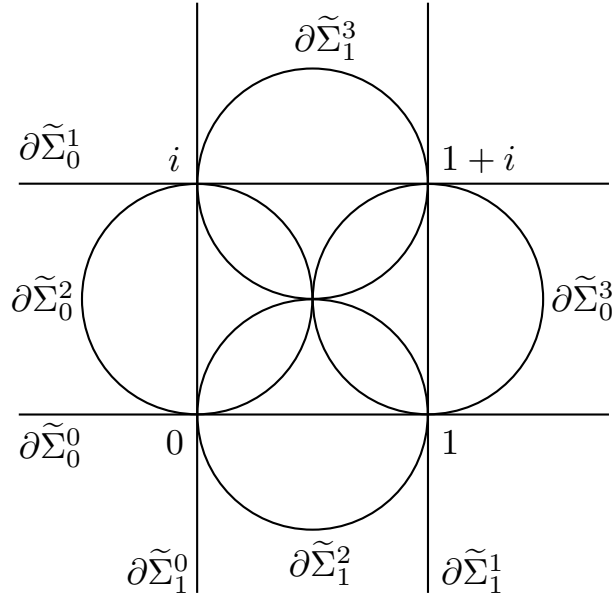

Figure 14: Boundary of components of  $\tilde{\Sigma}_0$  and  $\tilde{\Sigma}_1$

According to the cusped octahedral census by Goerner [13, Table 2], there are two orientable hyperbolic 3-manifolds and six non-orientable hyperbolic 3-

manifolds obtained from one regular ideal octahedron. Agol [4] showed that the Whitehead link complement and the  $(-2, 3, 8)$ -pretzel link complement have the smallest volume  $V_{oct}$  of the orientable hyperbolic 3-manifold with two cusps, and described the gluing ways of a regular ideal octahedron into the two manifolds. Assume that  $M$  is orientable. Then  $M$  is one of the above two manifolds. The 3-punctured spheres  $\Sigma_0$  and  $\Sigma_1$  are the images of the faces of a regular ideal octahedron. The gluing ways, however, do not give two 3-punctured spheres from the faces of a regular ideal octahedron.  $\square$

Therefore the intersection of two 3-punctured spheres in an orientable hyperbolic 3-manifold cannot consist of three geodesics. We orient the hyperbolic 3-manifold and the 3-punctured spheres. We can easily show the following proposition by considering the orientation of a neighborhood of the arc.

**Proposition 3.3.** *Let  $S$  and  $T$  be properly embedded oriented surfaces in an oriented 3-manifold with boundary. Suppose that  $S$  and  $T$  intersect transversally. Let an arc  $g$  be a component of  $S \cap T$ . Let  $x_0$  and  $x_1$  denote the endpoints of  $g$ . For  $i = 0$  and  $1$ , let  $s_i$  denote the boundary components of  $S$  containing  $x_i$ , which possibly coincide. In the same manner, let  $t_i$  denote the boundary components of  $T$  containing  $x_i$ . Then the intersections of  $s_i$  and  $t_i$  at  $x_i$  have opposite signs with respect to the induced orientation.*

We return the cases of two 3-punctured spheres in an oriented hyperbolic 3-manifold. Note that the boundary components of a 3-punctured sphere are closed geodesics in a cusp with respect to its Euclidean metric.

**Claim 3.4.** *A geodesic in the intersection of two 3-punctured spheres is non-separating in at least one 3-punctured sphere.*

*Proof.* Assume that a geodesic  $g$  in the intersection is separating in both 3-punctured spheres. Note that there might be another component of the intersection. We consider a cusp containing the endpoints of  $g$ . Let  $s$  and  $t$  denote the boundary components of the two 3-punctured spheres that intersect  $g$ . Then the intersection of the loops  $s$  and  $t$  contains at least the endpoints of  $g$ . Since the loops  $s$  and  $t$  are contained in a common cusp, the signs of the intersection at these endpoints coincide. This is impossible by Proposition 3.3.  $\square$

Therefore, there are two types for the components of the intersection of two 3-punctured spheres. We say that an  $\alpha$ -intersection is a component of the intersection that is non-separating in both 3-punctured spheres, and a  $\beta$ -intersection is a component of the intersection that is non-separating in a 3-punctured sphere and separating in the other 3-punctured sphere. The unions of the types  $A_2$  and  $B_2$  respectively contain an  $\alpha$ -intersection and a  $\beta$ -intersection.

We suppose that the intersection of two 3-punctured spheres consists of two geodesics.

**Claim 3.5.** *The intersection of two 3-punctured spheres does not consist of one  $\alpha$ -intersection and one  $\beta$ -intersection.*

*Proof.* Assume that two 3-punctured spheres intersect at one  $\alpha$ -intersection and one  $\beta$ -intersection. There are two possibilities of the intersection as shown in the left of Figure 15.

In the left case, a cusp contains three loops  $s, u,$  and  $v$  of boundary components of the 3-punctured spheres. The loops  $u$  and  $v$  are disjoint. The loops  $s$  and  $u$  intersect at two points, but the loops  $s$  and  $v$  intersect at one point. This is impossible.

In the central case, a cusp contains five loops  $s, t, u, v,$  and  $w$  of boundary components of the 3-punctured spheres. The two loops  $s$  and  $t$  are disjoint, and the three loops  $u, v,$  and  $w$  are mutually disjoint, Hence the number of intersection of these five loops is a multiple of six. This contradicts the fact that the intersection consists of the four endpoints of the two geodesics  $g_1$  and  $g_2$ .  $\square$

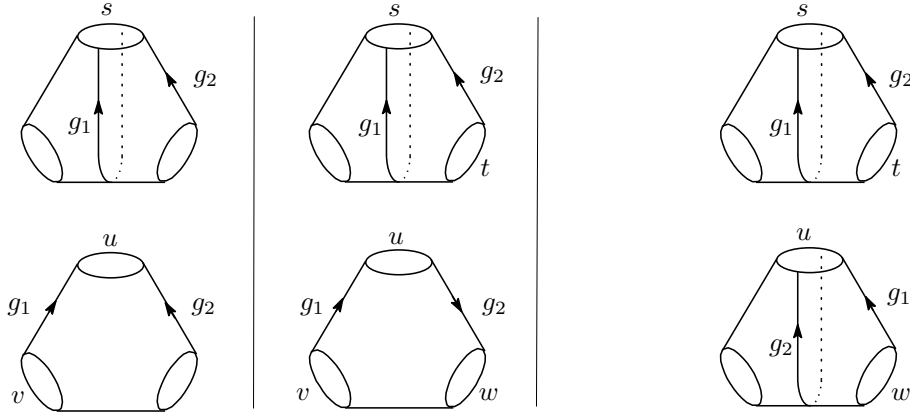

Figure 15: Orientations of two geodesics containing a  $\beta$ -intersection

**Claim 3.6.** *The intersection of two 3-punctured spheres does not consist of two  $\beta$ -intersections.*

*Proof.* Assume that two 3-punctured spheres intersect at two  $\beta$ -intersections. It is sufficient to consider the intersection as shown in the right of Figure 15.

In the case, a cusp contains four loops  $s, t, u$  and  $w$  of the boundary components of the 3-punctured spheres. Then  $s \cap t = \emptyset, u \cap w = \emptyset, t \cap w = \emptyset,$  and  $s \cap u \neq \emptyset$ . This is impossible.  $\square$

Therefore we have excluded the cases other than the cases in Lemma 3.1.  $\square$

We need Theorem 3.7 and Lemma 3.8 to prove that there are no other 3-punctured spheres than the described ones in some manifolds.

**Theorem 3.7** (Miyamoto [26]). *Let  $N$  be a hyperbolic 3-manifold with totally geodesic boundary. Then*

$$\text{vol}(N) \geq \frac{1}{2} |\chi(\partial N)| V_{\text{oct}},$$

where  $\chi$  indicates the Euler characteristic, and  $V_{\text{oct}} = 3.6638\dots$  is the volume of a regular ideal octahedron.

By cutting along totally geodesic surfaces, we can show that a hyperbolic 3-manifold  $M$  contains at most  $\lfloor \text{vol}(M)/V_{\text{oct}} \rfloor$  disjoint 3-punctured spheres.

**Lemma 3.8.** *Let  $M$  be an orientable hyperbolic 3-manifold. Suppose that two 3-punctured spheres  $\Sigma$  and  $\Sigma'$  in  $M$  represent a common homology class in  $H_2(M, \partial M; \mathbb{Z})$ . Then  $\Sigma$  and  $\Sigma'$  are disjoint.*

*Proof.* It is sufficient to show that  $\partial\Sigma \cap \partial\Sigma' = \emptyset$ . For  $i = 0, 1, 2$ , let  $s_i$  and  $s'_i$  denote the components of  $\partial\Sigma$  and  $\partial\Sigma'$ . The unions of loops  $\partial\Sigma = s_0 \cup s_1 \cup s_2$  and  $\partial\Sigma' = s'_0 \cup s'_1 \cup s'_2$  represent a common homology class in the homology of the cusps. Even if the homology classes of two loops of  $s_0, s_1$ , and  $s_2$  cancel, Lemma 3.1 implies that two parallel loops of  $s_0, s_1$ , and  $s_2$  cannot intersect two parallel loops of  $s'_0, s'_1$ , and  $s'_2$ .  $\square$

We first classify the unions of 3-punctured spheres that contain intersection of the type (iii) in Lemma 3.1.

**Lemma 3.9.** *If two 3-punctured spheres intersect as the type (iii), the ambient hyperbolic 3-manifold is obtained by a (possibly empty) Dehn filling from one of the following manifolds (Figure 16):*

- the manifold  $\mathbb{W}_2$ , which is a double covering of the Whitehead link complement,
- the Borromean rings complement  $\mathbb{W}'_2$ , or
- the minimally twisted hyperbolic 4-chain link complement  $\mathbb{M}_4$ .

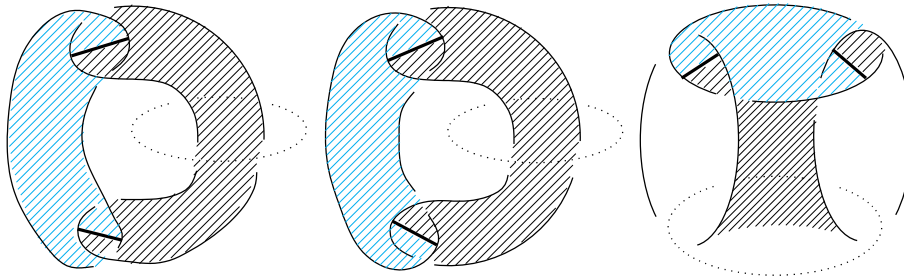

Figure 16: Two 3-punctured spheres intersecting at two geodesics

*Proof.* There are three possibilities depending on the orientations of geodesics in the intersection as shown in Figure 17.

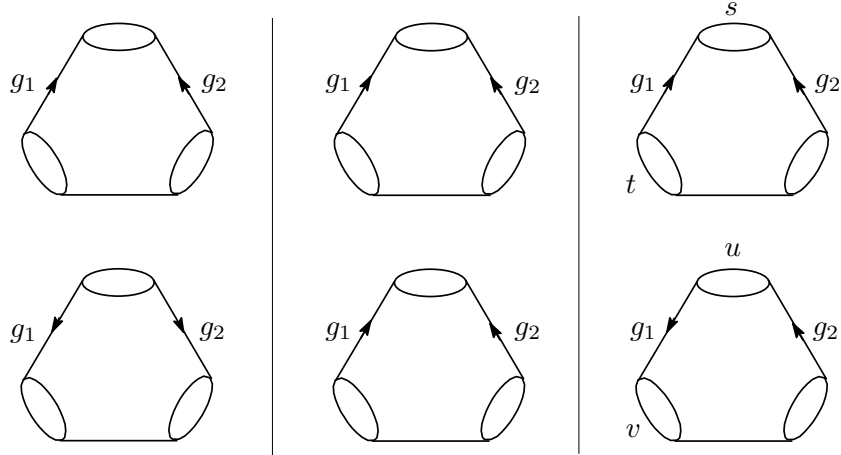

Figure 17: Orientations of two  $\alpha$ -intersections

The left case gives the union of two 3-punctured spheres of the type  $\widehat{Whi}_2$  and  $\widehat{Whi}'_2$  depending on the signs of the intersections. The union of the two 3-punctured spheres with the adjacent cusps has a regular neighbourhood whose boundary is a torus. Hence the ambient 3-manifold is almost determined.

The central case also gives two types of the union. One of these is the type  $\widehat{Tet}_2$ . Then the ambient 3-manifold is almost determined in the same manner as above. The other type occurs in a manifold obtained by a (possibly empty) Dehn filling from the non-hyperbolic minimally twisted 4-chain link complement  $M'_4$  as shown in Figure 18. The manifold  $M'_4$  can be decomposed along a torus into two copies of  $\Sigma \times S^1$ , where  $\Sigma$  is a 3-punctured sphere. Hence the ambient 3-manifold is a graph manifold, which is not hyperbolic.

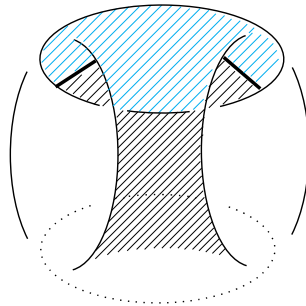

Figure 18: The non-hyperbolic minimally twisted 4-chain link

The right case does not occur. Assume that it occurs. Then a cusp contains

four boundary components  $s, t, u$ , and  $v$  of the 3-punctured spheres. We have  $s \cap t = \emptyset$  and  $u \cap v = \emptyset$ , but the intersection in  $s, t, u$ , and  $v$  consists of three points. This is impossible.  $\square$

In the next five lemmas, we will show that if two 3-punctured spheres intersect as the type (iii) in Lemma 3.1, the union of all the 3-punctured spheres is  $Whi_4, \widehat{Whi}_2, Bor_6, \widehat{Whi}'_2, Tet_8, \widehat{Tet}_2$ , or  $Mag_4$ .

In order to show that there are no other 3-punctured spheres than the described ones, we use the Thurston norm. For a surface  $S = \bigsqcup_i S_i$  (each  $S_i$  is a connected component), we define  $\chi_-(S) = \sum_i \min\{0, -\chi(S_i)\}$ . For an orientable compact 3-manifold  $M$ , the Thurston norm of a class  $\sigma \in H_2(M, \partial M; \mathbb{Z})$  is defined to be  $\|\sigma\| = \min \chi_-(S)$ , where the minimum is taken over the (possibly disconnected) embedded surfaces  $S$  that represent the class  $\sigma$ . Thurston [30] showed that  $\|\cdot\|$  is extended to a norm on  $H_2(M, \partial M; \mathbb{R})$  for a hyperbolic 3-manifold, and the unit norm ball  $\{\sigma \in H_2(M, \partial M; \mathbb{R}) \mid \|\sigma\| \leq 1\}$  is convex. Note that the norm  $\|\sigma\|$  of an integer class  $\sigma$  is odd if and only if  $\sigma$  can be represented by an essential surface  $S$  such that the number of the components of  $\partial S$  is odd.

**Lemma 3.10.** *The Borromean rings complement  $\mathbb{W}'_2$  has exactly the six 3-punctured spheres of the type  $Bor_6$ .*

*Proof.* Thurston [30] described the unit Thurston norm ball for  $\mathbb{W}'_2$  as follows. We may assume that linearly independent classes  $x, y, z \in H_2(\mathbb{W}'_2, \partial\mathbb{W}'_2; \mathbb{R})$  are represented by three of the 3-punctured spheres of the type  $Bor_6$  as described in Section 2. The classes  $x, y$  and  $z$  form a basis of  $H_2(\mathbb{W}'_2, \partial\mathbb{W}'_2; \mathbb{R}) \cong \mathbb{R}^3$ . Moreover,  $\|x\| = \|y\| = \|z\| = 1$ . The eight classes  $\pm x \pm y \pm z$  are fibered class, i.e. they are represented by a fiber of a mapping torus. Hence each of the classes  $\pm x \pm y \pm z$  is not represented by a 3-punctured sphere. Moreover, each of the classes  $\pm x \pm y \pm z$  is represented by a surface with at least three boundary components. Hence  $\|\pm x \pm y \pm z\| \neq 1$ . Therefore we have  $\|\pm x \pm y \pm z\| = 3$ . The 14 classes  $\pm x, \pm y, \pm z$ , and  $(\pm x \pm y \pm z)/3$  are contained in the boundary of the unit Thurston norm ball. This fact and the convexity imply that the unit Thurston norm ball is the octahedron whose vertices are  $\pm x, \pm y$ , and  $\pm z$ .

We know that  $\pm x, \pm y$ , and  $\pm z$  are exactly the integer classes in the boundary of the unit Thurston norm ball. Hence any 3-punctured sphere in  $\mathbb{W}'_2$  represents  $\pm x, \pm y$ , or  $\pm z$ . By ignoring the orientation, we may state that there are two 3-punctured spheres for each of  $x, y$ , and  $z$  such that the class is represented by each one of the two 3-punctured spheres. Therefore it is sufficient to show that  $x, y$  and  $z$  cannot be represented by any other 3-punctured sphere. Assume that  $\mathbb{W}'_2$  has another 3-punctured sphere  $\Sigma$ . Then Lemma 3.8 implies that  $\Sigma$  is disjoint from the two 3-punctured spheres representing the same class. This contradicts Theorem 3.7 and the fact that  $\text{vol}(\mathbb{W}'_2) = 2V_{oct}$ . Therefore  $\mathbb{W}'_2$  has no other 3-punctured spheres than the described ones of  $Bor_6$ .  $\square$

**Lemma 3.11.** *The manifold  $\mathbb{W}_2$  has exactly the four 3-punctured spheres of the type  $Whi_4$ .*



*Proof.* Since  $\text{vol}(\mathbb{W}_2) = 2V_{\text{oct}}$ , the manifold  $\mathbb{W}_2$  contains at most two disjoint 3-punctured spheres. Let  $\Sigma_1, \dots, \Sigma_4$  be the 3-punctured spheres of  $Whi_4$  as shown in Figure 19. In order to show that there are no other 3-punctured spheres, we describe the unit Thurston norm ball for  $\mathbb{W}_2$ . Let  $x \in H_2(\mathbb{W}_2, \partial\mathbb{W}; \mathbb{R})$  denote the class represented by each of  $\Sigma_1$  and  $\Sigma_2$ , and let  $y, z \in H_2(\mathbb{W}_2, \partial\mathbb{W}; \mathbb{R})$  denote the classes respectively represented by  $\Sigma_3$  and  $\Sigma_4$ . The classes  $x, y$ , and  $z$  form a basis of  $H_2(\mathbb{W}_2, \partial\mathbb{W}; \mathbb{R}) \cong \mathbb{R}^3$ . Moreover,  $\|x\| = \|y\| = \|z\| = 1$ . Consider the class  $x + y + z$ . A surface representing  $x + y + z$  intersect the three cusps. If we show that  $x + y + z$  cannot be represented by a 3-punctured sphere, we have  $\|x + y + z\| = 3$ .

Assume that  $x + y + z$  is represented by a 3-punctured sphere  $\Sigma$ . The boundary slopes of  $\Sigma$  are determined, and each cusp contains one of these slopes. The intersection  $\Sigma \cap \Sigma_1$  is disjoint from the cusp  $C_1$ . Since each cusp contains exactly one boundary component of  $\Sigma$ , the intersection  $\Sigma \cap \Sigma_i$  for  $i = 1, 3$  is not a separating geodesic in  $\Sigma_i$ . Hence  $\Sigma$  and  $\Sigma_1$  are disjoint. Similarly,  $\Sigma$  and  $\Sigma_2$  are also disjoint. This contradicts the fact that  $\mathbb{W}_2$  contains at most two disjoint 3-punctured spheres.

In the same manner, we have  $\|\pm x \pm y \pm z\| = 3$ . Hence the unit Thurston norm ball for  $\mathbb{W}_2$  is the octahedron whose vertices are  $\pm x, \pm y$ , and  $\pm z$  similarly to  $\mathbb{W}'_2$ . Therefore any 3-punctured sphere in  $\mathbb{W}_2$  represents  $\pm x, \pm y$ , or  $\pm z$ .

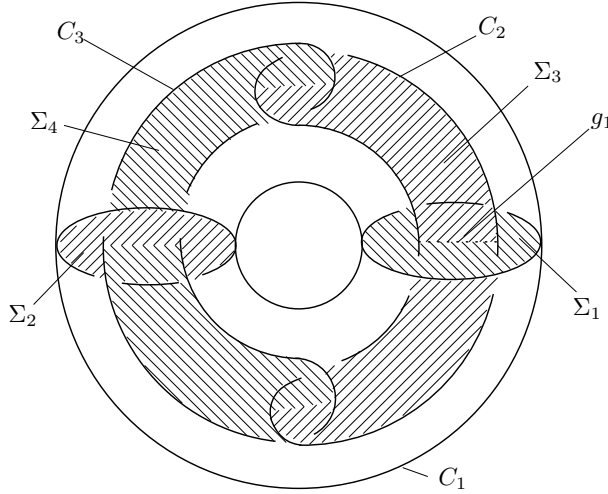

Figure 19: The 3-punctured spheres of the type  $Whi_4$

Now the class  $x$  is represented only by  $\Sigma_1$  and  $\Sigma_2$ . Assume that  $\mathbb{W}_2$  has another 3-punctured sphere  $\Sigma$  representing  $y$  than  $\Sigma_3$ . Then  $\Sigma \cap \Sigma_3 = \emptyset$ . Since the homology classes represented by the components of  $\partial\Sigma_3$  do not cancel, the boundary  $\partial\Sigma$  consists of a loop in the cusp  $C_2$  and two loops in the cusp  $C_3$ . Hence  $\Sigma$  intersect  $\Sigma_1$  at the geodesic  $g_1 = \Sigma_1 \cap \Sigma_3$ . This contradicts the fact that  $\Sigma \cap \Sigma_3 = \emptyset$ . Hence there are no other 3-punctured spheres representing  $y$  than

$\Sigma_3$ . The same argument holds for  $z$ . Therefore  $\mathbb{W}_2$  has no other 3-punctured spheres than  $\Sigma_1, \dots, \Sigma_4$ .  $\square$

**Lemma 3.12.** *The manifold  $\mathbb{M}_4$  has exactly the eight 3-punctured spheres of the type  $Tet_8$ .*

*Proof.* We first describe the unit Thurston norm ball for  $\mathbb{M}_4$ . Let  $\Sigma_1, \dots, \Sigma_4$  be the 3-punctured spheres as shown in Figure 20, which respectively represent  $x, y, z, w \in H_2(\mathbb{M}_4, \partial\mathbb{M}_4; \mathbb{R})$ . Here the orientations of these 3-punctured spheres are induced by the projection to the diagram. Let  $\Sigma_5, \dots, \Sigma_8$  denote the 3-punctured spheres that respectively represent  $y + z + w, -x + z + w, x + y - w$ , and  $x + y + z$ . These eight 3-punctured spheres are the ones described in Section 2.

Let  $u_1 = (x + y)/2, u_2 = (y + z)/2, u_3 = (z + w)/2$ , and  $u_4 = (x - w)/2$ . The classes  $u_1, \dots, u_4$  form a basis of  $H_2(\mathbb{M}_4, \partial\mathbb{M}_4; \mathbb{R}) \cong \mathbb{R}^4$ . With respect to this basis, we can present classes as

$$\begin{aligned} x &= (1, -1, 1, 1), & y &= (1, 1, -1, -1), & z &= (-1, 1, 1, 1), & w &= (1, -1, 1, -1), \\ y + z + w &= (1, 1, 1, -1), & -x + z + w &= (-1, 1, 1, -1), \\ x + y - w &= (1, 1, -1, 1), & x + y + z &= (1, 1, 1, 1). \end{aligned}$$

Since the norms of  $u_1, \dots, u_4, x, y, z, w, y + z + w, -x + z + w, x + y - w$ , and  $x + y + z$  are equal to one, the convexity implies that the unit Thurston norm ball for  $\mathbb{M}_4$  is the 4-dimensional cube whose vertices are  $\pm x, \pm y, \pm z, \pm w, \pm(y + z + w), \pm(-x + z + w), \pm(x + y - w)$ , and  $\pm(x + y + z)$ . Therefore any 3-punctured sphere in  $\mathbb{M}_4$  represents one of these classes.

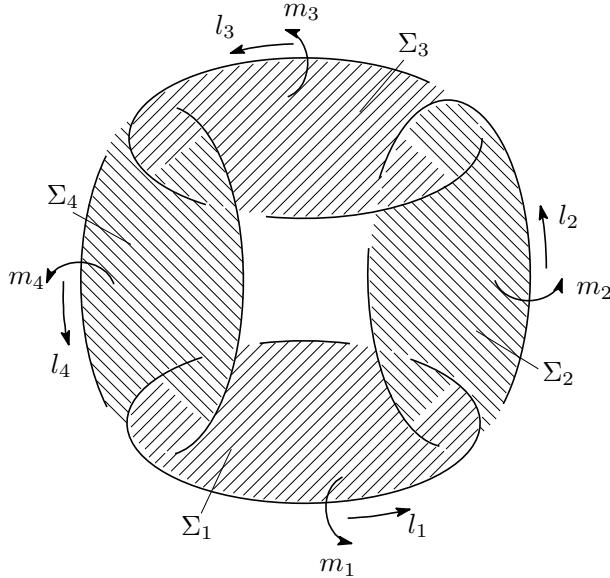

Figure 20: Four 3-punctured spheres in  $\mathbb{M}_4$

As we showed in Section 2, for any pair of  $\Sigma_1, \dots, \Sigma_8$ , there is an isometry of  $\mathbb{M}_4$  that maps one of the pair to the other. Hence it is sufficient to show that  $\Sigma_1$  is the unique 3-punctured sphere representing  $x$ .

Since  $\text{vol}(\mathbb{M}_4) = 2V_{oct}$ , the manifold  $\mathbb{M}_4$  contains at most two disjoint 3-punctured spheres. Assume that  $\mathbb{M}_4$  has another 3-punctured sphere  $\Sigma$  representing  $x$  than  $\Sigma_1$ . Lemma 3.8 implies that  $\Sigma \cap \Sigma_1 = \emptyset$ . Since the components of  $\partial\Sigma$  are contained in distinct cusps, their three slopes are the same as the slopes of  $\partial\Sigma_1$ . Hence  $\Sigma \cap \Sigma_3 = \emptyset$ . This contradicts the fact that  $\mathbb{M}_4$  contains at most two disjoint 3-punctured spheres.  $\square$

**Lemma 3.13.** *Let  $M$  be a hyperbolic 3-manifold obtained by a (non-empty) Dehn filling on the cusp of  $\mathbb{W}_2$  or  $\mathbb{W}'_2$  as in Lemma 3.9. Then  $M$  has exactly the two 3-punctured spheres of the type  $\widehat{Whi}_2$  or  $\widehat{Whi}'_2$  respectively.*

*Proof.* The Mayer-Vietoris sequence and the Poincaré duality imply that  $H_2(M, \partial M; \mathbb{R}) \cong \mathbb{R}^2$ . The manifold  $M$  contains at least two 3-punctured spheres of the type  $\widehat{Whi}_2$  or  $\widehat{Whi}'_2$ . They represent classes  $x$  and  $y$  that form a basis of  $H_2(M, \partial M; \mathbb{R})$ . Since  $\|x\| = \|y\| = 1$  and  $\|x + y\| = \|x - y\| = 2$ , the unit Thurston norm ball for  $M$  is the square whose vertices are  $\pm x$  and  $\pm y$ . Hence any 3-punctured sphere in  $M$  represents  $\pm x$  or  $\pm y$ . Since a hyperbolic Dehn surgery decreases the volume [29, Theorem 6.5.6], we have  $\text{vol}(M) < 2V_{oct}$ . Hence the manifold  $M$  does not contain two disjoint 3-punctured spheres. Therefore  $M$  has no other 3-punctured spheres.  $\square$

**Lemma 3.14.** *Let  $M$  be a hyperbolic 3-manifold obtained by a (non-empty) Dehn filling on a cusp of  $\mathbb{M}_4$ . If  $M = \mathbb{M}_3$ , it has exactly the four 3-punctured spheres of the type  $Mag_4$ . Otherwise  $M$  has exactly the two 3-punctured spheres of the type  $\widehat{Tet}_2$ .*

*Proof.* Thurston [30] described the unit Thurston norm ball for  $\mathbb{M}_3$  as follows. We may assume that the four known 3-punctured spheres represent  $x, y, z, x + y + z \in H_2(\mathbb{M}_3, \partial\mathbb{M}_3; \mathbb{R})$ . Then the unit Thurston norm ball is the parallelepiped whose vertices are  $\pm x, \pm y, \pm z$ , and  $\pm(x + y + z)$ . Since  $\text{vol}(\mathbb{M}_3) < 2V_{oct}$ , the manifold  $\mathbb{M}_3$  has no other 3-punctured spheres.

We orient the meridians  $m_i$  and the longitudes  $l_i$  of the cusps of  $\mathbb{M}_4$  as shown in Figure 20. For coprime integers  $p \geq 0$  and  $q$ , let  $M$  be a hyperbolic 3-manifold obtained by the  $(p, q)$ -Dehn filling on the first cusp of  $\mathbb{M}_4$ . Namely,  $M$  is obtained by gluing a solid torus to  $\mathbb{M}_4$  along the slope  $pm_1 + ql_1$  as meridian. If  $(p, q) = (0, 1), (1, 0), (1, 1)$ , or  $(2, 1)$ , then  $M$  is not hyperbolic. If  $(p, q) = (1, -1), (1, 2), (3, 1)$ , or  $(3, 2)$ , then  $M = \mathbb{M}_3$ . We exclude these cases. Note that in general four Dehn fillings give a common 3-manifold by the symmetry of  $\mathbb{M}_4$ .

Following the notation in Lemma 3.12, the two 3-punctured spheres  $\Sigma_3$  and  $\Sigma_5$  in  $\mathbb{M}_4$  are disjoint from the filled cusp. Their union is  $\widehat{Tet}_2$ . Assume that  $M$  contains another 3-punctured sphere  $\Sigma$  than  $\Sigma_3$  or  $\Sigma_5$ . We may assume that  $\Sigma$  is the union of an  $n$ -punctured sphere  $\Sigma'$  in  $\mathbb{M}_4$  and  $(n - 3)$  essential disks in the filled solid torus. Suppose that  $\Sigma'$  represents  $ax + by + cz + dw \in H_2(\mathbb{M}_4, \partial\mathbb{M}_4; \mathbb{R})$

for  $a, b, c, d \in \mathbb{Z}$ . Note that  $n$  is odd if and only if  $a + b + c + d$  is odd. Then the homology classes of the boundaries are

$$\begin{aligned} [\partial\Sigma'] &= ((b-d)m_1 + al_1) + ((a+c)m_2 + bl_2) \\ &\quad + ((b+d)m_3 + cl_3) + ((-a+c)m_4 + dl_4), \\ [\partial\Sigma_3] &= m_2 + l_3 + m_4, \\ [\partial\Sigma_5] &= (m_2 + l_2) + (2m_3 + l_3) + (m_4 + l_4). \end{aligned}$$

There are at most two points in the intersection of two components of  $\partial\Sigma$  and  $\partial\Sigma_i$  for  $i = 3, 5$  by Lemma 3.1. Hence we have

$$\begin{aligned} \left| \det \begin{pmatrix} a+c & 1 \\ b & 0 \end{pmatrix} \right| &= |b| \leq 2, \quad \left| \det \begin{pmatrix} a+c & 1 \\ b & 1 \end{pmatrix} \right| = |a-b+c| \leq 2, \\ \left| \det \begin{pmatrix} b+d & 0 \\ c & 1 \end{pmatrix} \right| &= |b+d| \leq 2, \quad \left| \det \begin{pmatrix} b+d & 2 \\ c & 1 \end{pmatrix} \right| = |b-2c+d| \leq 2, \\ \left| \det \begin{pmatrix} -a+c & 1 \\ d & 0 \end{pmatrix} \right| &= |d| \leq 2, \quad \left| \det \begin{pmatrix} -a+c & 1 \\ d & 1 \end{pmatrix} \right| = |a-c+d| \leq 2. \end{aligned}$$

Suppose that  $(b-d, a) = (0, 0)$ . Then  $|b| \leq 1, |b-c| \leq 1$ , and  $n$  is odd. Since  $c$  is odd, we have  $(b, c) = \pm(0, 1)$  or  $\pm(1, 1)$ . If  $(a, b, c, d) = \pm(0, 0, 1, 0)$ , then  $\Sigma$  is disjoint from  $\Sigma_3$ . If  $(a, b, c, d) = \pm(0, 1, 1, 1)$ , then  $\Sigma$  is disjoint from  $\Sigma_5$ . Since  $\text{vol}(M) < 2V_{oct}$ , these are impossible.

Suppose that  $(b-d, a) \neq (0, 0)$ . Then  $p/q = (b-d)/a$ . By reversing the orientation if necessary, we may assume that  $b-d \geq 0$ . Then  $(b-d)/p$  is odd if and only if  $n$  is even. Therefore it is sufficient to consider the cases

$$\begin{aligned} (a, b, c, d) &= (-1, 0, -1, -2), (-1, 2, 1, 0), (1, 2, \pm 1, -2), \\ &\quad (3, 0, -1, -2), (3, 2, 1, 0), (3, 2, \pm 1, -2). \end{aligned}$$

Suppose that  $(a, b, c, d) = (-1, 0, -1, -2)$ . Then  $(a+c, b) = (-2, 0), (b+d, c) = (-2, -1)$ , and  $(-a+c, d) = (0, -2)$ . Hence  $\partial\Sigma'$  has at least five components disjoint from the filled cusp. This is impossible. The other cases are also impossible similarly.  $\square$

We next classify the unions of 3-punctured spheres that contain intersection of the type (ii) in Lemma 3.1.

**Lemma 3.15.** *Suppose that two 3-punctured spheres  $\Sigma_1$  and  $\Sigma_2$  in a hyperbolic 3-manifold  $M$  intersect at a  $\beta$ -intersection. Then the component of the union of the 3-punctured spheres in  $M$  that contains  $\Sigma_1$  and  $\Sigma_2$  is a type  $B_{2n}, \text{Whi}_{2n}, \text{Whi}'_{4n}$ , or  $\text{Bor}_6$ .*

*Proof.* We consider the two 3-punctured spheres  $\Sigma_1$  and  $\Sigma_2$  as shown in Figure 21. Suppose that another 3-punctured sphere  $\Sigma$  intersects  $\Sigma_2$ . Consider the intersection of  $\Sigma$  and the cusp  $C$ . Lemma 3.1 implies that  $\Sigma \cap \Sigma_2 \cap C$  consists of at most two points. If  $\Sigma \cap \Sigma_2 \cap C = \emptyset$ , then  $\Sigma \cap \Sigma_2 = g_2, \Sigma \cap \Sigma_1 = g_3$ , and

$\Sigma \cap C = \emptyset$ . Otherwise  $\Sigma \cap \Sigma_2 = g_4 \cup g_5$  and  $\Sigma \cap \Sigma_1 = \emptyset$ . In both cases, the ambient 3-manifold  $M$  is the Borromean rings complement  $\mathbb{W}'_2$ . Then the union is  $Bor_6$  by Lemma 3.10.

Suppose that  $\Sigma_2$  is disjoint from any other 3-punctured sphere than  $\Sigma_1$ . If  $\Sigma_1$  is also disjoint from any other 3-punctured sphere than  $\Sigma_2$ , the union is  $B_2$ . If  $\Sigma_1$  intersects another 3-punctured sphere  $\Sigma_3$ , there is another 3-punctured sphere  $\Sigma_4$  that is homologous to  $\Sigma_2$  and intersects only  $\Sigma_3$ . We can continue this argument. If 3-punctured spheres lies cyclically, the union is  $Whi_{2n}$  or  $Whi'_{4n}$ . Otherwise the union is  $B_{2n}$ .  $\square$

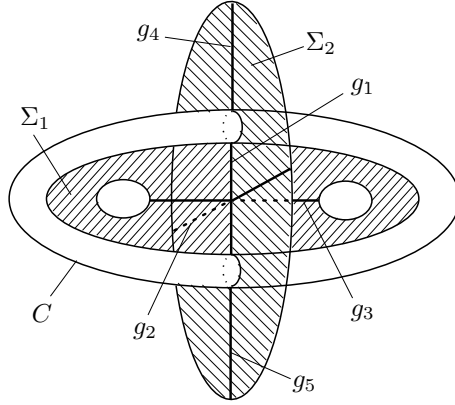

Figure 21: 3-punctured spheres of the type  $B_2$

From now on, we consider a component  $X$  of the union of 3-punctured spheres without intersection of the type (ii) or (iii). Let us consider the intersection  $L = X \cap C$ , where  $C$  is a cusp. Then  $L$  is the union of geodesic loops in the cusp  $C$  with respect to the Euclidean metric. Since the intersection of two loops in  $L$  consists of at most one point, we may assume that the slope of a loop in  $L$  is 0, 1, or  $\infty$  with respect to a choice of meridian and longitude. Moreover, there are at most two intersectional points in each loop in  $L$ , since each boundary component of a 3-punctured sphere meets exactly two non-separating simple geodesics.

We now consider three special types of  $L$ . (Figure 22 shows fundamental domains of the cusp  $C$ .) We obtain the following containments by manually combining 3-punctured spheres.

- If  $L$  contains three loops of slopes 0, 1, and  $\infty$  with common intersection, then  $X$  contains  $T_3$ .
- If  $L$  contains three loops of slopes 0, 1, and  $\infty$  without common intersection, then  $X$  contains  $\widehat{Pen}_4$ .
- If  $L$  contains two pairs of loops of slopes 0 and  $\infty$ , then  $X$  contains  $\widehat{Oct}_4$ .

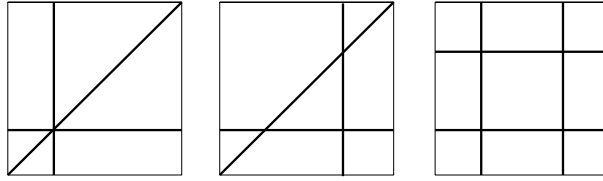

Figure 22: Special types of  $L$

In the second case, the union of the three 3-punctured spheres with  $C$  has a regular neighborhood that contains another 3-puncture. Moreover, the union of these four 3-punctured spheres is  $\widehat{Pen}_4$ . In the last case, we need the following lemma.

**Lemma 3.16.** *Suppose that  $L$  contains two pairs of loops of slopes  $0$  and  $\infty$ . Let  $\Sigma_1, \dots, \Sigma_4$  be 3-punctured spheres in  $X$  such that  $\Sigma_1 \cap C$  and  $\Sigma_3 \cap C$  are of slope  $0$ , and  $\Sigma_2 \cap C$  and  $\Sigma_4 \cap C$  are of slope  $\infty$ . Then  $\Sigma_1 \cap \Sigma_3 = \emptyset$  and  $\Sigma_2 \cap \Sigma_4 = \emptyset$ .*

*Proof.* Assume that two 3-punctured spheres  $\Sigma_1$  and  $\Sigma_3$  meeting the cusp  $C$  at loops of slope  $0$  intersect at a geodesic  $g_5$ . There are two cases depending on orientations of geodesics at the intersection as shown in Figure 23.

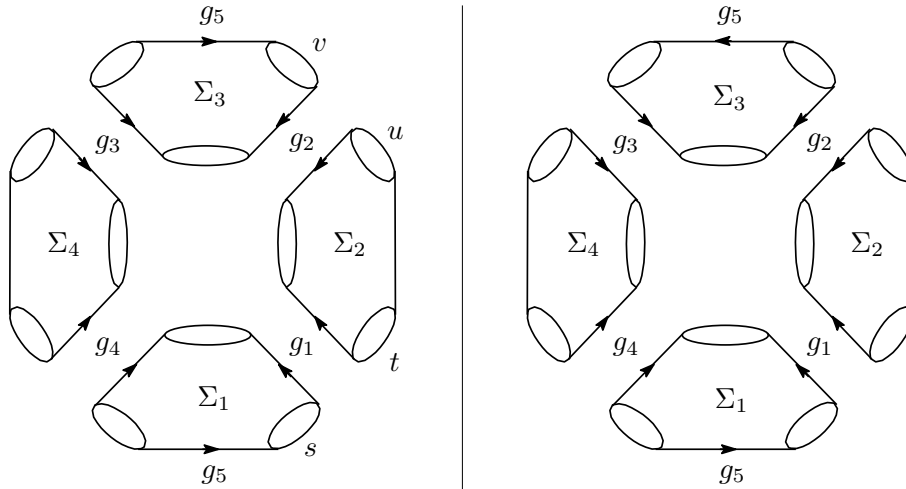

Figure 23: Orientations of geodesics in four 3-punctured spheres

In the left case, four loops  $s, t, u,$  and  $v$  are contained in a common cusp. Then  $s \cap t \neq \emptyset$  while  $s \cap u = \emptyset$  and  $t \cap u = \emptyset$ . This is impossible.

In the right case, the union of  $\Sigma_1, \Sigma_2,$  and  $\Sigma_3$  is  $\widehat{Whi}_3$ . Hence the ambient 3-manifold  $M$  is obtained by a Dehn filling on a cusp of  $\mathbb{W}_3$ . Then the proof is completed by the following lemma.  $\square$

**Lemma 3.17.** *Let  $M$  be a hyperbolic 3-manifold obtained by a (non-empty) Dehn filling on the cusp  $C_1$  of  $\mathbb{W}_3$ . Suppose that  $M \neq \mathbb{M}_3$ . Then  $M$  has exactly the three 3-punctured spheres of the type  $\widehat{Whi}_3$ .*

*Proof.* We orient the meridians  $m_i$  and the longitudes  $l_i$  of the cusps of  $\mathbb{W}_3$  as shown in Figure 24. The 3-punctured spheres  $\Sigma_1, \Sigma_2, \Sigma_3$ , and  $\Sigma_4$  respectively represent classes  $x, y, z$ , and  $w$  that form a basis of  $H_2(\mathbb{W}_3, \partial\mathbb{W}_3; \mathbb{R}) \cong \mathbb{R}^4$ . Assume that  $M$  has another 3-punctured sphere  $\Sigma$  than  $\Sigma_2, \Sigma_3$ , or  $\Sigma_4$ . Then we may assume that  $\Sigma$  is the union of an  $n$ -punctured sphere  $\Sigma'$  in  $\mathbb{W}_3$  and  $(n - 3)$  essential disks in the filled solid torus. Suppose that  $\Sigma'$  represents  $ax + by + cz + dw \in H_2(\mathbb{W}_3, \partial\mathbb{W}_3; \mathbb{R})$  for  $a, b, c, d \in \mathbb{Z}$ . Then

$$[\partial\Sigma'] = al_1 + ((-c - d)m_2 + bl_2) + ((-b - d)m_3 + cl_3) + ((-b - c)m_4 + dl_4).$$

If  $a \neq 0$ , then  $M$  is obtained by the  $(0, 1)$ -Dehn filling, which is not hyperbolic. Hence we have  $a = 0$ , and  $b + c + d$  is odd. Since we exclude  $\mathbb{M}_3$ , two components of  $\partial\Sigma$  and  $\partial\Sigma_i$  for  $i = 2, 3, 4$  intersect at most one point. Hence we have

$$|b| \leq 1, |c| \leq 1, |d| \leq 1, |c + d| \leq 1, |b + d| \leq 1, |b + c| \leq 1.$$

These inequalities imply that  $(b, c, d) = (\pm 1, 0, 0), (0, \pm 1, 0)$ , or  $(0, 0, \pm 1)$ .

Therefore we may assume that  $\Sigma$  is homologous to  $\Sigma_2$  in  $M$ . Lemma 3.8 implies that  $\Sigma \cap \Sigma_2 = \emptyset$ , but we have  $\Sigma \cap \Sigma_3 = \Sigma_2 \cap \Sigma_3$  and  $\Sigma \cap \Sigma_4 = \Sigma_2 \cap \Sigma_4$ . This is impossible.  $\square$

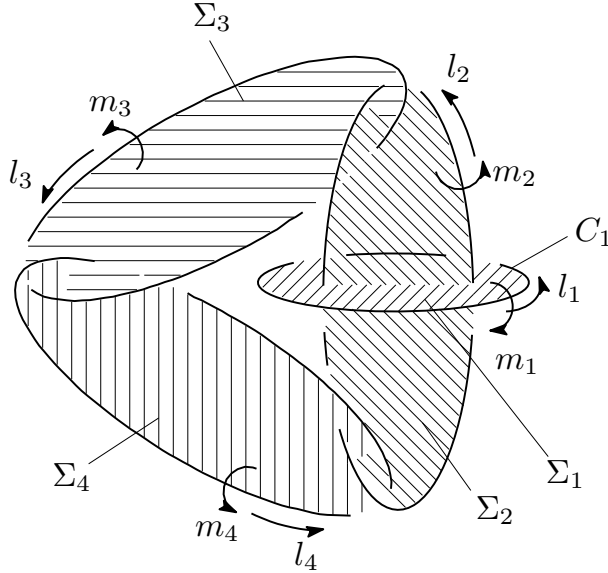

Figure 24: Four 3-punctured spheres in  $\mathbb{W}_3$

We classify the unions  $X$  that contain special types of  $L$ . We recall that two 3-punctured spheres of  $X$  intersect at most one geodesic.

**Lemma 3.18.** *Let  $X$  be a component of the union of the 3-punctured spheres without intersection of the type (ii) or (iii) in Lemma 3.1.*

- *If  $X$  contains  $T_3$ , then  $X$  is  $T_3$  or  $Pen_{10}$ .*
- *If  $X$  contains  $\widehat{Pen}_4$ , then  $X$  is  $\widehat{Pen}_4$  or  $Pen_{10}$ .*
- *If  $X$  contains  $\widehat{Oct}_4$ , then  $X$  is  $\widehat{Oct}_4$ ,  $Oct_8$ , or  $Pen_{10}$ .*

*Proof.* We first show that the manifold  $\mathbb{M}_5$  has exactly the ten 3-punctured spheres of  $Pen_{10}$ . The intersection of the 3-punctured spheres of  $Pen_{10}$  and each cusp consists of six loops of slopes 0, 1, and  $\infty$ . Hence Lemma 3.1 implies that  $\mathbb{M}_5$  has no other 3-punctured spheres.

Suppose that  $X$  contains  $T_3$  and another 3-punctured sphere. Then the intersection  $L$  contains three loops of slopes 0, 1 and  $\infty$  without common intersection. Hence  $X$  contains  $\widehat{Pen}_4$ . The ambient 3-manifold is obtained by a possibly empty Dehn filling on a cusp of  $\mathbb{M}_5$ . Since the ambient 3-manifold contains 3-punctured spheres of  $T_3$ , its volume is at least  $\text{vol}(\mathbb{T}_3) = \text{vol}(\mathbb{M}_5)$ . Therefore the ambient 3-manifold is  $\mathbb{M}_5$ , and the union  $X$  is  $Pen_{10}$ .

If  $X$  contains  $\widehat{Pen}_4$  and another 3-punctured sphere,  $X$  also contains  $T_3$ . Then  $X$  is  $Pen_{10}$ .

Suppose that  $X$  contains  $\widehat{Oct}_4$ . The ambient 3-manifold is obtained by a possibly empty Dehn filling on a cusp of  $\mathbb{M}_6$ . The manifold  $\mathbb{M}_6$  has exactly the eight 3-punctured spheres of the type  $Oct_8$ , for otherwise  $X$  contains  $T_3$  and  $\widehat{Pen}_4$ .

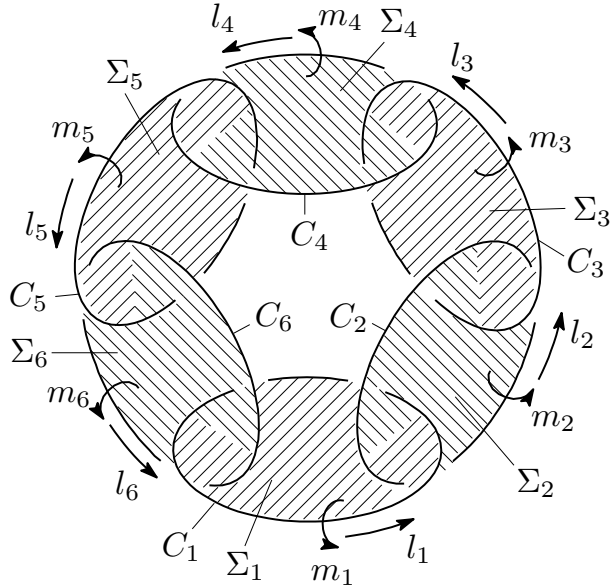

Figure 25: Six 3-punctured spheres in  $\mathbb{M}_6$



Let  $M$  be a hyperbolic 3-manifold obtained by a Dehn filling on the cusp  $C_1$  of  $\mathbb{M}_6$ . Assume that  $M$  is not  $\mathbb{M}_5$ , and has another 3-punctured sphere  $\Sigma$  than the ones of  $\widehat{Oct}_4$ . We orient the meridians  $m_i$  and the longitudes  $l_i$  of the cusps of  $\mathbb{M}_6$  as shown in Figure 25. The 3-punctured spheres  $\Sigma_1, \dots, \Sigma_6$  respectively represent classes  $x_1, \dots, x_6$  that form a basis of  $H_2(\mathbb{M}_6, \partial\mathbb{M}_6; \mathbb{R}) \cong \mathbb{R}^6$ . We may assume that  $\Sigma$  is the union of an  $n$ -punctured sphere  $\Sigma'$  in  $\mathbb{M}_6$  and  $(n-3)$  essential disks in the filled solid torus. Suppose that  $\Sigma'$  represents  $a_1x_1 + \dots + a_6x_6 \in H_2(\mathbb{M}_6, \partial\mathbb{M}_6; \mathbb{R})$  for  $a_1, \dots, a_6 \in \mathbb{Z}$ . Then

$$[\partial\Sigma'] = ((-a_6 + a_2)m_1 + a_1l_1) + ((a_1 - a_3)m_2 + a_2l_2) + ((-a_2 + a_4)m_3 + a_3l_3) \\ + ((a_3 - a_5)m_4 + a_4l_4) + ((-a_4 + a_6)m_5 + a_5l_5) + ((a_5 - a_1)m_6 + a_6l_6).$$

The 3-punctured sphere  $\Sigma$  is disjoint from the cusp  $C_4$ , for otherwise  $X$  is  $Pen_{10}$ . By the same reason, each  $\Sigma \cap C_i$  for  $i = 2, 3, 5, 6$  is a multiple of  $m_i$  or  $l_i$ . Since  $\Sigma$  is a 3-punctured sphere, we have

$$|a_1 - a_3| + |a_2| + |-a_2 + a_4| + |a_3| + |-a_4 + a_6| + |a_5| + |a_5 - a_1| + |a_6| = 1 \text{ or } 3.$$

However,

$$(a_1 - a_3) + a_2 + (-a_2 + a_4) + a_3 + (-a_4 + a_6) + a_5 + (a_5 - a_1) + a_6 = 2(a_5 + a_6)$$

is even. This is impossible.  $\square$

In the remaining case, the intersection  $L$  of  $X$  and a cusp is one of the followings (Figure 26):

- disjoint simple loops,
- two loops with one common point, or
- three loops with two common points, two of which are parallel.

In the last case, the two parallel loops in  $L$  are contained in distinct 3-punctured spheres.

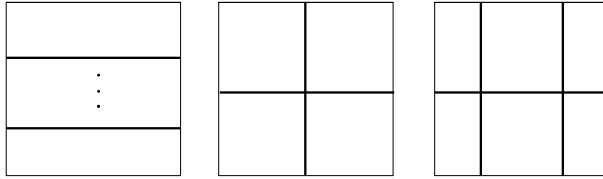

Figure 26: General types of  $L$

**Lemma 3.19.** *Suppose that the intersection of  $X$  and any cusp is one of the above three types. If  $X$  contains 3-punctured sphere  $\Sigma$  that intersects three other 3-punctured spheres, then  $X$  is  $T_4$ .*

*Proof.* Clearly  $X$  contains  $T_4$ . Let  $C_1, C_2$ , and  $C_3$  denote the cusps meeting the 3-punctured sphere  $\Sigma$ . Assume that there is another 3-punctured sphere  $\Sigma$  than the ones of  $T_4$ . Then  $\Sigma$  intersects at least one of the three cusps  $C_1, C_2$ , and  $C_3$ . This contradicts the assumption for the intersection of  $X$  and a cusp.  $\square$

In the last remaining case, the 3-punctured spheres in  $X$  are placed linearly or cyclically. If the 3-punctured spheres in  $X$  are placed linearly, then  $X$  is  $A_n$ . If the 3-punctured spheres in  $X$  are placed cyclically, then  $X$  is  $\widehat{Whi}_n$  or  $\widehat{Whi}'_{2n}$ .

Thus we complete the proof of Theorem 1.2.

## 4 Volume and number of 3-punctured spheres

As an application of Theorem 1.2, we estimate the number of 3-punctured spheres in a hyperbolic 3-manifold by its volume. We recall that if a hyperbolic 3-manifold  $M$  contains  $n$  disjoint 3-punctured spheres, then  $\text{vol}(M) \geq nV_{oct}$  by Theorem 3.7.

**Theorem 4.1.** *Suppose that an orientable hyperbolic 3-manifold  $M$  has  $k$  3-punctured spheres. Then  $k \leq 4\text{vol}(M)/V_{oct}$ . The equality holds if and only if  $M$  is the manifold  $\mathbb{M}_4$ .*

*Proof.* We first consider the special cases. Let  $V_{oct} = 3.6638\dots$  be the volume of a regular ideal octahedron, and let  $V_3 = 1.0149\dots$  be the volume of a regular ideal tetrahedron. The assertion for the special manifolds is obtained from the following inequalities:

- $\text{vol}(\mathbb{W}_n) = \text{vol}(\mathbb{W}'_n) = nV_{oct} > \frac{n}{2}V_{oct}$  for  $Whi_{2n}$  and  $Whi'_{4n}$ ,
- $\text{vol}(\mathbb{W}'_2) = 2V_{oct} > \frac{3}{2}V_{oct}$  for  $Bor_6$ ,
- $\text{vol}(\mathbb{M}_3) = 5.3334\dots > V_{oct}$  for  $Mag_4$ ,
- $\text{vol}(\mathbb{M}_4) = 2V_{oct}$  for  $Tet_8$ ,
- $\text{vol}(\mathbb{M}_5) = 10V_3 > \frac{5}{2}V_{oct}$  for  $Pen_{10}$ ,
- $\text{vol}(\mathbb{M}_6) = 4V_{oct} > 2V_{oct}$  for  $Oct_8$ .

Since a hyperbolic 3-manifold with 3-punctured spheres of the type  $\widehat{Whi}_n$  contains  $\lfloor n/2 \rfloor$  disjoint 3-punctured spheres, its volume is at least  $\lfloor n/2 \rfloor V_{oct}$ . The same argument holds for  $\widehat{Whi}'_{2n}$ . For  $\widehat{Tet}_2$ , the volume of a hyperbolic 3-manifold obtained by a Dehn filling on a cusp of  $\mathbb{M}_4$  is at least  $V_{oct}$ , since the manifold contains a 3-punctured sphere. For  $\widehat{Pen}_4$  and  $\widehat{Oct}_4$ , the volume of a hyperbolic 3-manifold obtained by a Dehn filling on a cusp of  $\mathbb{M}_5$  or  $\mathbb{M}_6$  is at least  $2V_{oct}$ . Indeed, such a manifold has at least 4 cusps, and  $\mathbb{M}_4$  has the smallest volume of the orientable hyperbolic 3-manifolds with at least 4 cusps [31]. Thus we have shown the assertion for the special cases.

We consider the general cases. Suppose that the union of the 3-punctured spheres of an orientable hyperbolic 3-manifold  $M$  consists of the types  $A_n, B_{2n}, T_3$ , and  $T_4$ . Let  $a_n, b_{2n}, t_3$ , and  $t_4$  denote the number of the corresponding components. At least one of  $a_n, b_{2n}, t_3$ , and  $t_4$  is positive. Then  $M$  contains  $\sum_n (\lfloor (n+1)/2 \rfloor a_n + nb_{2n}) + t_3 + 3t_4$  disjoint 3-punctured spheres. Hence  $\text{vol}(M) \geq (\sum_n (\lfloor (n+1)/2 \rfloor a_n + nb_{2n}) + t_3 + 3t_4) V_{oct}$ . The assertion follows from the inequality

$$\frac{\sum_n (\lfloor (n+1)/2 \rfloor a_n + nb_{2n}) + t_3 + 3t_4}{\sum_n (na_n + 2nb_{2n}) + 3t_3 + 4t_4} > \frac{1}{4}.$$

□

## 5 Bound of modulus for $A_n$

Neighborhoods of 3-punctured spheres of the types  $B_{2n}, T_3$ , and  $T_4$  are isometrically determined as the manifolds  $\mathbb{B}_{n+1}, \mathbb{T}_3$ , and  $\mathbb{T}_4$ . The metric of a neighborhood of 3-punctured spheres of the type  $A_n$  for  $n \geq 2$ , however, depends on the ambient hyperbolic 3-manifold. Let us consider 3-punctured spheres  $\Sigma_1, \dots, \Sigma_n$  of the type  $A_n$ . There are  $n$  cusps each of which intersects two or three of  $\Sigma_1, \dots, \Sigma_n$  at loops of two slopes. We will call them the adjacent torus cusps for  $\Sigma_1, \dots, \Sigma_n$ . We define the meridians and longitudes of the adjacent torus cusps as the intersection of the cusps and the 3-punctured spheres, so that each 3-punctured sphere meets exactly one longitude. Then the meridians and the longitudes are uniquely determined if  $n \geq 3$ . For  $A_2$ , however, there is ambiguity to permute the meridian and longitude. In this case we take them arbitrarily.

The Euclidean structure of such an adjacent cusp determines its modulus  $\tau$  with respect to the meridian and longitude. Then the cusp is isometric to the quotient of  $\mathbb{C}$  under the additive action of  $\{m + n\tau \in \mathbb{C} | m, n \in \mathbb{Z}\}$ , where 1 and  $\tau$  respectively correspond to the meridian and longitude. We may assume that  $\text{Im}(\tau) > 0$  by taking an appropriate orientation. We first show that the moduli of such adjacent cusps coincide.

**Proposition 5.1.** *Suppose that an orientable hyperbolic 3-manifold  $M$  contains two 3-punctured spheres  $\Sigma_1$  and  $\Sigma_2$  of the type  $A_2$ . Let  $\tau$  and  $\tau'$  denote the moduli of the two adjacent cusps  $C_1$  and  $C_2$ . Then  $\tau = \tau'$ .*

*Proof.* Let  $x, y, z, w \in \pi_1(M)$  be represented by the loops shown in Figure 27. The base point is taken in  $\Sigma_1 \cap \Sigma_2$ . The meridians correspond to  $y$  and  $z$ , and the longitudes correspond to  $x$  and  $w$ . Regard  $\pi_1(M)$  as a subgroup of  $\text{PSL}(2, \mathbb{C}) \cong \text{Isom}^+(\mathbb{H}^3)$ . Since  $x$  and  $y$  are parabolic elements with distinct fixed points in  $\partial\mathbb{H}^3$ , we may assume that

$$x = \begin{pmatrix} 1 & 2 \\ 0 & 1 \end{pmatrix} \quad \text{and} \quad y = \begin{pmatrix} 1 & 0 \\ c & 1 \end{pmatrix}$$

by taking conjugates. Then  $xy^{-1} = \begin{pmatrix} 1-2c & 2 \\ -c & 1 \end{pmatrix}$  is also parabolic. Hence  $|\text{tr}(xy^{-1})| = |2-2c| = 2$ . Since  $y$  is not the identity, we have  $c = 2$ .

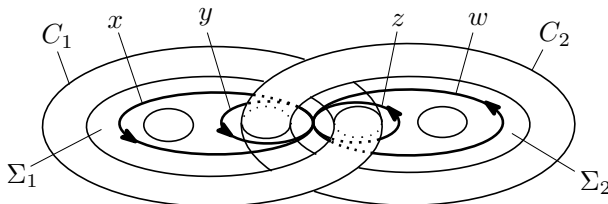

Figure 27: Generators of  $\pi_1(\Sigma_1)$  and  $\pi_1(\Sigma_2)$

The moduli  $\tau$  and  $\tau'$  give the representations

$$z = \begin{pmatrix} 1 & 2/\tau \\ 0 & 1 \end{pmatrix} \quad \text{and} \quad w = \begin{pmatrix} 1 & 0 \\ 2\tau' & 1 \end{pmatrix}.$$

Then  $zw^{-1} = \begin{pmatrix} 1-4(\tau'/\tau) & 2/\tau \\ -2\tau' & 1 \end{pmatrix}$  is also parabolic. Hence  $|\text{tr}(zw^{-1})| = |2-4(\tau'/\tau)| = 2$ . Since  $\tau' \neq 0$ , we have  $\tau = \tau'$ .  $\square$

Therefore the metric of a neighbourhood of 3-puncture spheres of the type  $A_n$  ( $n \geq 2$ ) is determined by the single modulus  $\tau$ . In particular, the angle at the intersection is equal to  $\arg \tau$ .

Let  $\mathcal{C}_n$  denote the set of the moduli for 3-punctured spheres of the type  $A_n$  contained in (possibly infinite volume) hyperbolic 3-manifolds. We first give a bound for  $\mathcal{C}_n$  by using the Shimizu-Leutbecher lemma.

**Lemma 5.2** (the Shimizu-Leutbecher lemma [28]). *Suppose that a group generated by two elements*

$$\begin{pmatrix} 1 & 1 \\ 0 & 1 \end{pmatrix}, \begin{pmatrix} a & b \\ c & d \end{pmatrix} \in \text{PSL}(2, \mathbb{C})$$

*is discrete. Then  $c = 0$  or  $|c| \geq 1$ .*

**Proposition 5.3.** *Let  $\tau \in \mathcal{C}_2$ . Then*

$$|m\tau + n| \geq \frac{1}{4} \quad \text{and} \quad \left| \frac{m}{\tau} + n \right| \geq \frac{1}{4}$$

*for any  $(m, n) \in \mathbb{Z} \times \mathbb{Z} \setminus \{(0, 0)\}$ .*

*In particular,*

$$\frac{1}{4} \leq |\tau| \leq 4 \quad \text{and} \quad 0.079 < \arg \tau < \pi - 0.079.$$

*Proof.* Let  $x, y, z, w \in \pi_1(M)$  be as in the proof of Proposition 5.1. By taking conjugates for the Shimizu-Leutbecher lemma, we have if  $x = \begin{pmatrix} 1 & 2 \\ 0 & 1 \end{pmatrix}$  and  $\begin{pmatrix} a & b \\ c & d \end{pmatrix}$  generate a discrete subgroup of  $\mathrm{PSL}(2, \mathbb{C})$ , then  $c = 0$  or  $|c| \geq 1/2$ . Now considering  $y^n w^m = \begin{pmatrix} 1 & 0 \\ 2m\tau + 2n & 1 \end{pmatrix}$ , we obtain  $|m\tau + n| \geq 1/4$ . Similarly, since  $y = \begin{pmatrix} 1 & 0 \\ 2 & 1 \end{pmatrix}$  and  $x^n z^m = \begin{pmatrix} 1 & 2(m/\tau) + 2n \\ 0 & 1 \end{pmatrix}$  generate a discrete subgroup, we have  $|(m/\tau) + n| \geq 1/4$ .

In fact, these condition is equivalent to the inequalities for

$$(m, n) = (1, 0), (4, \pm 1), (3, \pm 1), (2, \pm 1), (3, \pm 2), (4, \pm 3), (1, \pm 1).$$

Indeed, for large  $(m, n)$ , the equalities  $|m\tau + n| = 1/4$  and  $|(m/\tau) + n| = 1/4$  give small circles in  $\mathbb{C}$ . The above inequalities define the region bounded by 26 arcs as shown in Figure 28. This region is symmetric about the imaginary axis and invariant under the inversion with respect to the unit circle. We recall that  $\mathrm{Im}(\tau) > 0$ . The inequalities for  $(m, n) = (1, 0)$  imply that  $\frac{1}{4} \leq |\tau| \leq 4$ . A point of minimal slope of  $\tau$  in the first quadrant satisfying these inequalities is  $(93 + \sqrt{55}i)/128$ , which is contained in the intersection of two circles given by  $|3\tau - 2| = 1/4$  and  $|4\tau - 3| = 1/4$ . Therefore  $\arg \tau \geq \arctan(\sqrt{55}/93) > 0.079$ .  $\square$

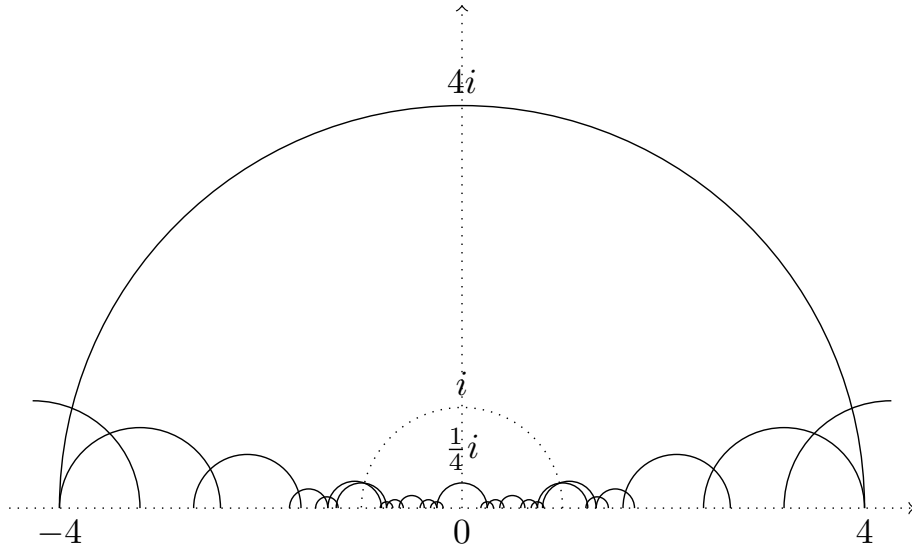

Figure 28: A bound for the modulus  $\tau$

For the 3-punctured spheres  $\Sigma_1, \dots, \Sigma_n$  of the type  $A_n$ , let  $M_n$  be a regular neighborhood of the union of  $\Sigma_1 \cup \dots \cup \Sigma_n$  with the  $n$  adjacent torus cusps.

The frontier  $\partial_0 M_n$  is a 4-punctured sphere. For  $\tau \in \mathbb{C} \setminus \{0\}$ , we define a representation  $\rho_\tau: \pi_1(M_n) \rightarrow \mathrm{PSL}(2, \mathbb{C})$  whose restriction to  $\pi_1(\Sigma_i \cup \Sigma_{i+1})$  for each  $1 \leq i \leq n-1$  is conjugate to the one in the proof of Proposition 5.1. The parameter space  $\mathbb{C} \setminus \{0\}$  can be regarded as the character variety for  $M_n$ . We regard  $\mathcal{C}_n$  as a subspace of  $\mathbb{C} \setminus \{0\}$ . If  $\tau \in \mathcal{C}_n$ , then  $\rho_\tau$  is the holonomy representation for  $M_n$  with the cusp modulus  $\tau$ . The image of  $\rho_\tau$  is discrete if and only if  $\tau$  or  $\bar{\tau} \in \mathcal{C}_n$ .

Jørgensen's inequality [17] implies that if representations of a group to  $\mathrm{PSL}(2, \mathbb{C})$  have discrete images, their algebraic limits is elementary or has a discrete image. Hence  $\mathcal{C}_n$  is closed in  $\mathbb{C} \setminus \{0\}$ . We divide  $\mathcal{C}_n$  into two subsets  $\mathcal{C}_n^{\mathrm{incomp}} = \{\tau \in \mathcal{C}_n | \rho_\tau \text{ is injective}\}$  and  $\mathcal{C}_n^{\mathrm{comp}} = \{\tau \in \mathcal{C}_n | \rho_\tau \text{ is not injective}\}$ .

**Theorem 5.4.** *The set  $\mathcal{C}_n^{\mathrm{incomp}}$  is homeomorphic to a closed disk.*

Theorem 5.4 is due to Minsky [25]. Although in that paper he mainly considered once-punctured torus groups, he noted that the same argument holds for hyperbolic 3-manifolds with boundary consisting of 4-punctured spheres. This homeomorphism is described as follows. Let  $\mathcal{T}_{0,4}$  denote the Teichmüller space of a 4-punctured sphere. Its Thurston compactification  $\overline{\mathcal{T}_{0,4}}$  is homeomorphic to a closed disk. The set  $\mathcal{C}_n^{\mathrm{incomp}}$  is the image of a continuous map  $\iota: \overline{\mathcal{T}_{0,4}} \rightarrow \mathbb{C} \setminus \{0\}$ . The Thurston boundary  $\partial\mathcal{T}_{0,4} = \overline{\mathcal{T}_{0,4}} - \mathcal{T}_{0,4}$  can be identified with  $\mathbb{R} \cup \{\infty\}$ . A rational point of  $\partial\mathcal{T}_{0,4}$  corresponds to the homotopy class of an essential simple closed curve on the 4-punctured sphere. Here we conventionally regard  $\infty$  as a rational point. A parameter  $\tau \in \mathcal{C}_n^{\mathrm{incomp}}$  determines a hyperbolic structure of  $M_n$  as  $\mathbb{H}^3/\rho_\tau(\pi_1(M_n))$ . If  $\tau \in \mathrm{int}\mathcal{C}_n^{\mathrm{incomp}}$ , then the hyperbolic structure is geometrically finite, and the conformal structure on the infinite end  $\partial_0 M_n$  is given by  $\iota^{-1}(\tau) \in \mathcal{T}_{0,4}$ . If  $\iota^{-1}(\tau)$  is a rational point of  $\partial\mathcal{T}_{0,4}$ , there is an annular cusp of the corresponding slope on  $\partial_0 M_n$ . On the other hand, if  $\iota^{-1}(\tau)$  is an irrational point of  $\partial\mathcal{T}_{0,4}$ , then  $\mathbb{H}^3/\rho_\tau(\pi_1(M_n))$  is geometrically infinite.

**Theorem 5.5.** *The set  $\mathcal{C}_n^{\mathrm{comp}}$  is a countably infinite set.*

If  $\tau \in \mathcal{C}_n^{\mathrm{comp}}$ , the manifold  $\mathbb{H}^3/\rho_\tau(\pi_1(M_n))$  is the complement of a Montesinos link. We prepare the notion of Montesinos links.

Let  $B^3 = \{(x, y, z) \in \mathbb{R}^3 | x^2 + y^2 + z^2 \leq 1\}$ . Consider the natural projection of  $B^3$  into the  $xy$ -plane. A 2-tangle is two arcs properly embedded in  $B^3$  whose endpoints are  $\{(\pm 1/\sqrt{2}, \pm 1/\sqrt{2}, 0)\}$ . The equivalence of 2-tangles is given by isotopy fixing the endpoints of the arcs. A trivial tangle is a 2-tangle that is injected by the projection. The homotopy class of a (non-oriented) essential closed curve in the 4-punctured sphere  $\partial_0 B^3 = \partial B^3 - \{(\pm 1/\sqrt{2}, \pm 1/\sqrt{2}, 0)\}$  is determined by a slope  $r \in \mathbb{Q} \cup \{\infty\}$ . Here the slope  $r = p/q$  for coprime integers  $p$  and  $q$  is defined so that the homology class of the loop is  $\pm(pm + ql)$ , where  $m, l \in H_1(\partial_0 B^3, \mathbb{Z})$  are respectively represented by the loops  $\theta \in [0, 2\pi] \mapsto (\sin \theta, 0, \cos \theta), (0, \sin \theta, \cos \theta)$ . A 2-tangle homeomorphic to a trivial tangle is determined up to isotopy by  $r \in \mathbb{Q} \cup \{\infty\}$ , where the compressing disk for  $\partial_0 B^3$  in the complement has the boundary of slope  $r$ . This tangle is called a rational tangle of slope  $r$ .

For  $r_1, \dots, r_n \in \mathbb{Q} \cup \{\infty\}$ , the Montesinos link  $L(r_1, \dots, r_n)$  is defined by composing rational tangles of slopes  $r_1, \dots, r_n$  as shown in Figure 29. We consider that the diagram is drawn in the  $xy$ -plane, which determines the slopes of tangles.

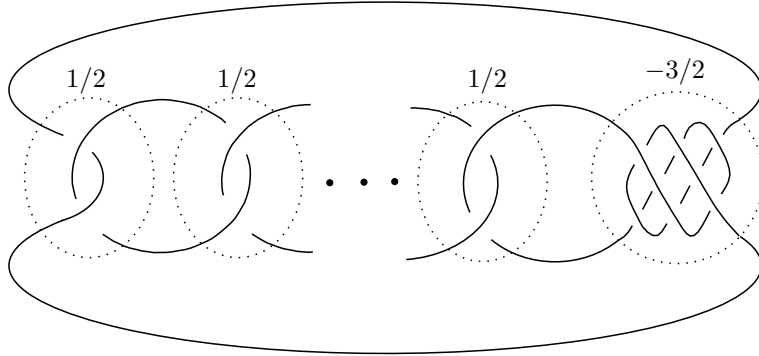

Figure 29: The Montesinos link  $L(1/2, 1/2, \dots, 1/2, -3/2)$

*Proof of Theorem 5.5.* Let  $\tau \in \mathcal{C}_n^{\text{comp}}$ . Equip  $M_n$  with the metric for the cusp modulus  $\tau$ . Then  $\partial_0 M_n$  is compressible. By taking a regular neighborhood of the union of  $M_n$  with the compressing disk, we obtain that the ambient hyperbolic 3-manifold  $\mathbb{H}^3/\rho_\tau(\pi_1(M_n))$  is the union of  $M_n$  with the complement of a trivial tangle. Hence the manifold  $\mathbb{H}^3/\rho_\tau(\pi_1(M_n))$  is the complement of a Montesinos link  $L(1/2, \dots, 1/2, r)$ , where the number of tangles of slope  $1/2$  is  $n + 1$ . The set  $\mathcal{C}_n^{\text{comp}}$  corresponds to the set of slopes  $r$  such that  $L(1/2, \dots, 1/2, r)$  are hyperbolic links.

The classification of Montesinos links by Bonahon and Siebenmann [6] implies that all these links but the following exceptions are hyperbolic (see also [12, Section 3.3]).

- For  $n = 2$ , the four slopes  $r = -2, -3/2, -1, \infty$  are excluded.
- For  $n = 3$ , the two slopes  $r = -2, \infty$  are excluded.
- For  $n \geq 4$ , the slope  $r = \infty$  is excluded.

□

*Remark 5.6.* If an annular cusp of an excluded slope is added to  $M_n$ , we obtain one of the manifolds  $\mathbb{B}_{n+1}, \mathbb{T}_3$ , and  $\mathbb{T}_4$ . If the union of a 3-punctured sphere with the compressing disk is an annulus, the filled manifold is not hyperbolic.

Let us consider the subset  $\mathcal{C}_n^{\text{fin}}$  of  $\mathcal{C}_n$  consisting of the moduli that appears in a finite volume hyperbolic 3-manifold. Note that  $\mathcal{C}_n^{\text{comp}} \subset \mathcal{C}_n^{\text{fin}}$ . By Theorem 5.7, the restriction about finite volume does not give serious difference on bounds.

**Theorem 5.7** (Brooks [8]). *Let  $\Gamma < \mathrm{PSL}(2, \mathbb{C})$  be a geometrically finite Kleinian group. Then there exist arbitrarily small quasi-conformal deformations  $\Gamma_\epsilon$  of  $\Gamma$ , such that  $\Gamma_\epsilon$  is contained in the fundamental group of a finite volume hyperbolic 3-manifold.*

We apply Theorem 5.7 to  $\Gamma = \rho_\tau(\pi_1(M_n))$ .

**Corollary 5.8.** *The set  $\mathcal{C}_n^{\mathrm{fin}}$  is dense in  $\mathcal{C}_n$ .*

If 3-punctured spheres of the type  $A_n$  are contained in the ones of the type  $B_{2n}$ , the adjacent cusp modulus  $\tau$  is equal to  $2i$ . This is obtained from the decomposition of  $\mathbb{B}_1$  into a regular ideal octahedron shown in Figure 9. Hence  $2i \in \partial\mathcal{C}_n^{\mathrm{incomp}}$  for any  $n \geq 2$ . Note that  $\mathcal{C}_{n+1} \subset \mathcal{C}_n$ ,  $\mathcal{C}_{n+1}^{\mathrm{incomp}} \subset \mathcal{C}_n^{\mathrm{incomp}}$ , and  $\mathcal{C}_{n+2} \subset \mathcal{C}_n^{\mathrm{incomp}}$ . Finally we show that  $\mathcal{C}_n$  become arbitrarily smaller as  $n$  increases.

**Theorem 5.9.** *For  $n \geq 2$ , let  $\tau_n \in \mathcal{C}_n$ . Then  $\lim_{n \rightarrow \infty} \tau_n = 2i$ .*

By Corollary 5.8, we may assume that  $\tau_n \in \mathcal{C}_n^{\mathrm{fin}}$ . Theorem 5.9 follows from Theorem 5.10 and Lemma 5.11. Theorem 5.10 states that a Dehn filling along a long slope gives a manifold with metric uniformly close to the original one in their thick parts. Here we consider the normalized length of a slope, i.e. it is measured after rescaling the metric on the cusp torus to have unit area. The  $\epsilon$ -thick part of a hyperbolic 3-manifold  $M$  is its submanifold  $M_{[\epsilon, \infty)}$  such that the open ball of radius  $\epsilon$  centered at any  $x \in M_{[\epsilon, \infty)}$  is embedded in  $M$ . We call it simply the thick part after fixing  $\epsilon$  to be at most the Margulis constant for  $\mathbb{H}^3$ . Then the thin part (i.e. the complement of the thick part) is the disjoint union of regular neighbourhoods of both the cusps and the closed geodesics of length  $< 2\epsilon$ . It is crucial that the estimates in Theorem 5.10 do not depend on manifolds.

**Theorem 5.10.** *For any  $J > 1$ , there is a constant  $K \geq 4\sqrt{2}\pi$  satisfying the following condition. Suppose that  $M$  is obtained by a Dehn filling on a cusp of a finite volume hyperbolic 3-manifold  $M_0$  along a slope of normalized length  $L$  at least  $K$ . Then*

- (i) *the filled core loop (i.e. the core loop in the filled solid torus of the Dehn filling) is isotopic in  $M$  to a closed geodesic of length  $\leq 2\pi/(L^2 - 16\pi^2)$ , and*
- (ii) *there is a  $J$ -bilipschitz diffeomorphism  $\varphi: (M_0)_{[\epsilon, \infty)} \rightarrow M_{[\epsilon, \infty)}$  isotopic to the restriction of the natural inclusion  $M_0 \hookrightarrow M$ .*

The part (i) follows from the work of Hodgson and Kerckhoff [16]. The part (ii) follows from the drilling theorem due to Brock and Bromberg [7], which requires that the filled core loop is short. Magid [23, Section 4] unified their arguments and gave the explicit bound in (i).



**Lemma 5.11.** *Suppose that an orientable finite volume hyperbolic 3-manifold  $M$  contains 3-punctured spheres  $\Sigma_1, \dots, \Sigma_n$  of the type  $A_n$ . Then there is a finite volume hyperbolic 3-manifold  $M_0$  satisfying the following properties. The manifold  $M_0$  contains 3-punctured spheres of the type  $B_{2n}$ . The manifold  $M$  is obtained by a Dehn filling on a cusp of  $M_0$  along a slope of normalized length at least  $\sqrt{n+1}/2$ . The 3-punctured spheres  $\Sigma_1, \dots, \Sigma_n$  come from the ones contained in the 3-punctured spheres of  $B_{2n}$  in  $M_0$ .*

*Proof.* Let  $\gamma$  be a loop in  $M$  such that  $\gamma$  and two meridians of an adjacent cusp bound a 2-punctured disk  $\Sigma$  as shown in Figure 30. Let  $N(\gamma)$  be an open regular neighborhood of  $\gamma$ . Assume that  $M \setminus N(\gamma)$  contains an essential sphere  $S$ . Since  $M$  is irreducible, the sphere  $S$  bound a ball in  $M$ . Note that the cusps of  $M$  are incompressible. We apply the standard argument to reduce the intersection of surfaces in a 3-manifold by considering innermost intersection. Then by isotoping  $S$  in  $M \setminus N(\gamma)$ , we may assume that  $S$  is disjoint from  $\Sigma_1, \dots, \Sigma_n$ , and  $S \cap \Sigma$  consists of (possibly empty) loops parallel to  $\gamma$ . If  $S \cap \Sigma = \emptyset$ , then  $S$  bounds a ball in  $M \setminus N(\gamma)$ . Otherwise  $\gamma$  bounds a disk  $D$  in  $M$ . Then  $\Sigma \cup D$  is an essential annulus, which contradicts the fact that  $M$  is hyperbolic. Hence  $M \setminus N(\gamma)$  is irreducible.

If  $M \setminus N(\gamma)$  is hyperbolic, then it is sufficient to let  $M_0 = M \setminus N(\gamma)$ . Otherwise the hyperbolicity of  $M$  implies that the JSJ decomposition of  $M \setminus N(\gamma)$  gives a hyperbolic piece  $M_0$  containing  $\Sigma_1, \dots, \Sigma_n$ . Since the frontier of  $M_0$  is compressible in  $M$ , the manifold  $M$  is obtained by a Dehn filling of  $M_0$ . We can take  $M_0$  by isotopy so that  $\Sigma \cap M_0$  is a 3-punctured sphere in  $M_0$ . Hence  $M_0$  contains 3-punctured spheres of the type  $B_{2n}$ .

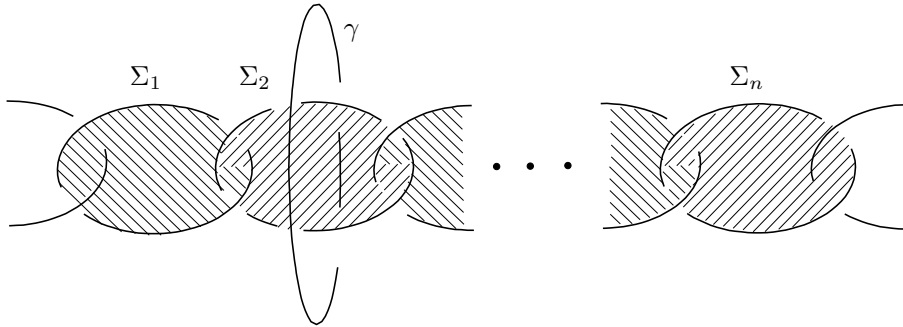

Figure 30: A drilled loop  $\gamma$  in  $M$

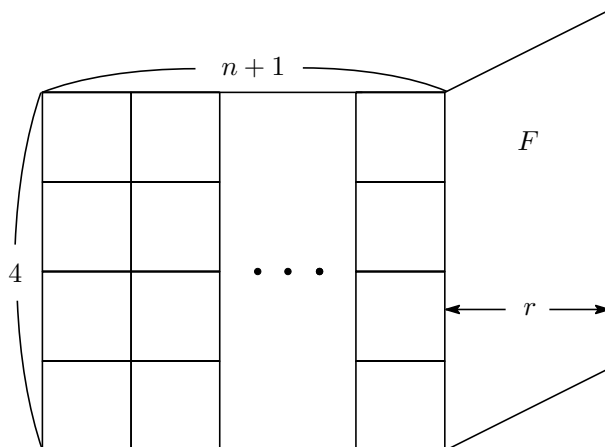

Figure 31: A fundamental domain of the cusp  $C$

The manifold  $M_0$  can be decomposed along two 3-punctured spheres into the manifold  $\mathbb{B}_{n+1}$  and a (possibly empty) manifold  $M'_0$ . We consider the cusp  $C$  of  $M_0$  on which we perform a Dehn filling. Let a meridian of  $C$  be homotopic to  $\gamma$  in  $M$ . Then the outer boundary component of a blue 3-punctured sphere of  $\mathbb{B}_{n+1}$  in Figure 3 is a meridian. We can construct a fundamental domain of the annular cusp  $C' = C \cap \mathbb{B}_{n+1}$  by  $4(n+1)$  Euclidean unit squares. This is obtained from the decomposition of  $\mathbb{B}_1$  into a regular ideal octahedron shown in Figure 9. By adding a fundamental domain  $F$  of  $C \setminus C'$ , we obtain a fundamental domain of  $C$  as shown in Figure 31. Let  $r \geq 0$  denote the height of  $F$  with respect to the meridian as the base of  $F$ . Note that  $M_0$  is  $\mathbb{W}_{n+1}$  or  $\mathbb{W}'_{n+1}$  if  $r = 0$ . When we normalize  $C$  to have unit area, the length of the meridian is  $2/\sqrt{n+1+r}$ . Since  $M$  is hyperbolic, the slope of the Dehn filling of  $M_0$  is not the meridian. Hence the length of this slope is at least  $\sqrt{n+1+r}/2$ .  $\square$

## Acknowledgements

The author would like to thank Hidetoshi Masai for his several helpful comments. This work was supported by JSPS KAKENHI Grant Numbers 24224002, 15H05739.

## References

- [1] C. C. ADAMS, *Thrice-punctured spheres in hyperbolic 3-manifolds*, Trans. Amer. Math. Soc., 287 (1985), pp. 645–656.
- [2] C. C. ADAMS AND W. SHERMAN, *Minimum ideal triangulations of hyperbolic 3-manifolds*, Discrete Comput. Geom., 6 (1991), pp. 135–153.

- [3] I. AGOL, *Pants immersed in hyperbolic 3-manifolds*, Pacific J. Math., 241 (2009), pp. 201–214.
- [4] ———, *The minimal volume orientable hyperbolic 2-cusped 3-manifolds*, Proc. Amer. Math. Soc., 138 (2010), pp. 3723–3732.
- [5] M. D. BAKER, *All links are sublinks of arithmetic links*, Pacific J. Math., 203 (2002), pp. 257–263.
- [6] F. BONAHON AND L. C. SIEBENMANN, *New geometric splittings of classical knots and the classification and symmetries of arborescent knots*, preprint, (1979–2010). available at <http://www-bcf.usc.edu/~fbonahon>.
- [7] J. F. BROCK AND K. W. BROMBERG, *On the density of geometrically finite Kleinian groups*, Acta Math., 192 (2004), pp. 33–93.
- [8] R. BROOKS, *Circle packings and co-compact extensions of Kleinian groups*, Invent. Math., 86 (1986), pp. 461–469.
- [9] P. J. CALLAHAN, M. V. HILDEBRAND, AND J. R. WEEKS, *A census of cusped hyperbolic 3-manifolds*, Math. Comp., 68 (1999), pp. 321–332.
- [10] N. M. DUNFIELD AND W. P. THURSTON, *The virtual Haken conjecture: Experiments and examples*, Geom. Topol., 7 (2003), pp. 399–441.
- [11] D. B. A. EPSTEIN AND R. C. PENNER, *Euclidean decompositions of non-compact hyperbolic manifolds*, J. Differential Geom., 27 (1988), pp. 67–80.
- [12] D. FUTER AND F. GUÉRITAUD, *Angled decompositions of arborescent link complements*, Proc. Lond. Math. Soc. (3), 98 (2009), pp. 325–364.
- [13] M. GOERNER, *A census of hyperbolic Platonic manifolds and augmented knotted trivalent graphs*, New York J. Math, 23 (2017), pp. 527–553.
- [14] C. M. GORDON AND Y.-Q. WU, *Toroidal and annular Dehn fillings*, Proc. Lond. Math. Soc. (3), 78 (1999), pp. 662–700.
- [15] A. HATCHER, *Hyperbolic structures of arithmetic type on some link complements*, J. Lond. Math. Soc. (2), 27 (1983), pp. 345–355.
- [16] C. D. HODGSON AND S. P. KERCKHOFF, *Universal bounds for hyperbolic Dehn surgery*, Ann. of Math. (2), 162 (2005), pp. 367–421.
- [17] T. JØRGENSEN, *On discrete groups of Möbius transformations*, Amer. J. Math., 98 (1976), pp. 739–749.
- [18] J. KAISER, J. S. PURCELL, AND C. ROLLINS, *Volumes of chain links*, J. Knot Theory Ramifications, 21 (2012). 1250115.
- [19] E. KIN AND D. ROLFSEN, *Braids, orderings and minimal volume cusped hyperbolic 3-manifolds*, arXiv preprint, (2016). <http://arxiv.org/abs/1610.03241>.

- [20] E. KIN AND M. TAKASAWA, *Pseudo-anosov braids with small entropy and the magic 3-manifold*, *Comm. Anal. Geom.*, 19 (2011), pp. 705–758.
- [21] A. KOLPAKOV AND B. MARTELLI, *Hyperbolic four-manifolds with one cusp*, *Geom. Funct. Anal.*, 23 (2013), pp. 1903–1933.
- [22] C. MACLACHLAN AND A. W. REID, *The Arithmetic of Hyperbolic 3-Manifolds*, vol. 219 of Graduate Texts in Mathematics, Springer-Verlag, 2003.
- [23] A. D. MAGID, *Deformation spaces of Kleinian surface groups are not locally connected*, *Geom. Topol.*, 16 (2012), pp. 1247–1320.
- [24] B. MARTELLI, C. PETRONIO, AND F. ROUKEMA, *Exceptional Dehn surgery on the minimally twisted five-chain link*, *Comm. Anal. Geom.*, 22 (2014), pp. 689–735.
- [25] Y. N. MINSKY, *The classification of punctured-torus groups*, *Ann. of Math.* (2), 149 (1999), pp. 559–626.
- [26] Y. MIYAMOTO, *Volumes of hyperbolic manifolds with geodesic boundary*, *Topology*, 33 (1994), pp. 613–629.
- [27] M. SAKUMA AND J. WEEKS, *Examples of canonical decompositions of hyperbolic link complements*, *Jpn. J. Math.*, 21 (1995), pp. 393–439.
- [28] H. SHIMIZU, *On discontinuous groups operating on the product of the upper half planes*, *Ann. of Math.* (2), 77 (1963), pp. 33–71.
- [29] W. P. THURSTON, *The Geometry and Topology of Three-Manifolds*, Lecture Notes from Princeton University, 1978–80. available at <http://library.msri.org/books/gt3m/>.
- [30] ———, *A norm for the homology of 3-manifolds*, *Mem. Amer. Math. Soc.*, 59 (1986), pp. 99–130.
- [31] K. YOSHIDA, *The minimal volume orientable hyperbolic 3-manifold with 4 cusps*, *Pacific J. Math.*, 266 (2013), pp. 457–476.

DEPARTMENT OF MATHEMATICS, KYOTO UNIVERSITY, KITASHIRAKAWA  
 OIWAKE-CHO, SAKYO-KU, KYOTO 606-8502, JAPAN.  
*E-mail address:* k.yoshida@math.kyoto-u.ac.jp