

SITE-SPECIFIC GORDIAN DISTANCES OF SPATIAL GRAPHS

KOUKI TANIYAMA

ABSTRACT. A site-specific Gordian distance between two spatial embeddings of an abstract graph is the minimal number of crossing changes from one to another where each crossing change is performed between two previously specified abstract edges of the graph. It is infinite in some cases. We determine the site-specific Gordian distance between two spatial embeddings of an abstract graph in certain cases. It has an application to puzzle ring problem. The site-specific Gordian distances between Milnor links and trivial links are determined. We use covering space theory for the proofs.

1. INTRODUCTION

Throughout this paper we work in the piecewise linear category. Let G be a finite graph. We denote the set of all vertices of G by $V(G)$ and the set of all edges of G by $E(G)$. Let $\mathcal{E} = (E(G) \times E(G))/\sim$ be the quotient set of $E(G) \times E(G)$ under the equivalence relation \sim defined by $(x, y) \sim (x, y)$ and $(x, y) \sim (y, x)$ for every $(x, y) \in E(G) \times E(G)$. We denote the equivalence class of (x, y) by $[x, y]$. Let $f : G \rightarrow \mathbb{S}^3$ be an embedding of G into the 3-sphere \mathbb{S}^3 . The embedding f is said to be a *spatial embedding* of G . Let x and y be two edges of G . By an *x - y crossing change on f* we mean a crossing change between a part of $f(x)$ and a part of $f(y)$. When $x = y$, an *x - y crossing change* is said to be a *self-crossing change on x* . Let \mathcal{F} be a subset of \mathcal{E} . We say that a crossing change C belongs to \mathcal{F} if C is an *x - y crossing change* and $[x, y]$ is an element of \mathcal{F} . Let $f : G \rightarrow \mathbb{S}^3$ and $g : G \rightarrow \mathbb{S}^3$ be two spatial embeddings of G . We consider these embeddings up to ambient isotopy in \mathbb{S}^3 . The *\mathcal{F} -Gordian distance between f and g* is defined to be the minimal number of crossing changes each of which belongs to \mathcal{F} that deforms f into g . We denote it by $d_{\mathcal{F}}(f, g)$. In case that f and g are not transformed into each other by such crossing changes, $d_{\mathcal{F}}(f, g) = \infty$.

Let G be a planar graph. An embedding $t : G \rightarrow \mathbb{S}^3$ is said to be *trivial* if $t(G)$ is contained in a 2-sphere in \mathbb{S}^3 . Note that trivial embeddings are unique up to ambient isotopy [4]. The image of a trivial embedding is also said to be *trivial*. Let $f : G \rightarrow \mathbb{S}^3$ be a spatial embedding. The *\mathcal{F} -unknotting number of f* , denoted by $u_{\mathcal{F}}(f)$, is defined to be the \mathcal{F} -Gordian distance between f and t . Namely $u_{\mathcal{F}}(f) = d_{\mathcal{F}}(f, t)$.

In this paper we mainly concern with the case that \mathcal{F} is a singleton. Namely $\mathcal{F} = \{[x, y]\}$ for some edges x and y of G . When $E(G) = \{e_1, \dots, e_n\}$ we denote

2010 *Mathematics Subject Classification*. Primary 57M25; Secondly 57M15.

Key words and phrases. knot, link, spatial graph, puzzle ring, site-specific Gordian distance, Milnor link, covering space.

The author was partially supported by Grant-in-Aid for Challenging Exploratory Research (No. 15K13439) and Grant-in-Aid for Scientific Research(A) (No. 16H02145), Japan Society for the Promotion of Science.

e_i - e_j crossing change by i - j crossing change and $d_{\{[e_i, e_j]\}}(f, g)$ by $d_{i,j}(f, g)$ for the simplicity. When G is planar $u_{\{[e_i, e_j]\}}(f)$ is denoted by $u_{i,j}(f)$.

Let μ be a natural number and L_μ a graph with μ vertices v_1, \dots, v_μ and μ loops ℓ_1, \dots, ℓ_μ such that v_i and ℓ_i are incident for each $i \in \{1, \dots, \mu\}$. Then a spatial embedding of L_μ can be regarded as an ordered oriented link in \mathbb{S}^3 . In this paper we ignore a vertex of a graph incident to exactly one edge that is a loop so long as no confusion occurs.

Example 1.1. Let $t : L_2 \rightarrow \mathbb{S}^3$, $f : L_2 \rightarrow \mathbb{S}^3$ and $g : L_2 \rightarrow \mathbb{S}^3$ be spatial embeddings as illustrated in Figure 1.1. The orders and orientations are arbitrary. Then we have $u_{1,1}(f) = d_{1,1}(f, t) = u_{2,2}(f) = d_{2,2}(f, t) = 1$, $u_{1,2}(f) = d_{1,2}(f, t) = 2$, $u_{1,1}(g) = d_{1,1}(g, t) = u_{2,2}(g) = d_{2,2}(g, t) = \infty$, $u_{1,2}(g) = d_{1,2}(g, t) = 1$, $d_{1,1}(f, g) = d_{2,2}(f, g) = \infty$ and $d_{1,2}(f, g) = 1$.

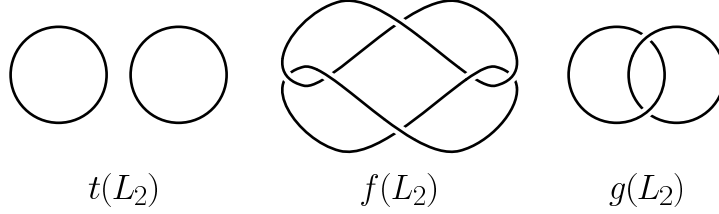

FIGURE 1.1.

Let n be a natural number. Let G_n be an abstract graph, e_1 and e_2 abstract loops of G_n , and $f_n : G_n \rightarrow \mathbb{S}^3$ and $g_n : G_n \rightarrow \mathbb{S}^3$ spatial embeddings of G_n as illustrated in Figure 1.2. Here f_n and g_n differ only on e_1 . In Figure 1.2 only the cases $n = 1, 2, 3$ are illustrated. The general case n is an obvious generalization of these cases.

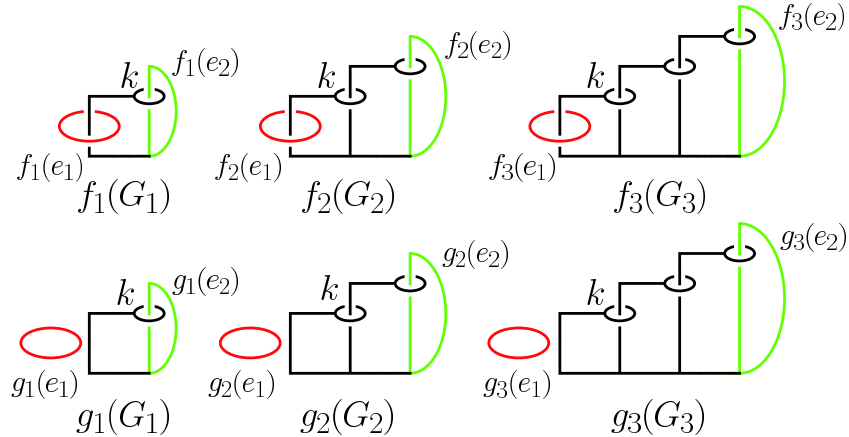

FIGURE 1.2.

Then the following theorem is shown in [6].

Theorem 1.2. [6] *Let n be a natural number. Let $f_n : G_n \rightarrow \mathbb{S}^3$ and $g_n : G_n \rightarrow \mathbb{S}^3$ be spatial embeddings of G_n as illustrated in Figure 1.2. Then $d_{1,2}(f_n, g_n) = 2^n$.*

Note that Theorem 1.2 is originally an answer to a question on puzzle ring raised by Kauffman in [3]. Suppose that $f_n(e_1)$ is a rubber band, the right half of $f_n(e_2)$ is not real but imaginary, and the rest of the image of $f_n(G_n)$ is made of metal. Here we think that the rubber band is topological and the metal part is rigid. Then it follows by Theorem 1.2 that the rubber band must go across the imaginary part 2^n times before it comes away from the metal part. See Figure 1.3 where the case $n = 3$ is illustrated. See [6] for more detail.

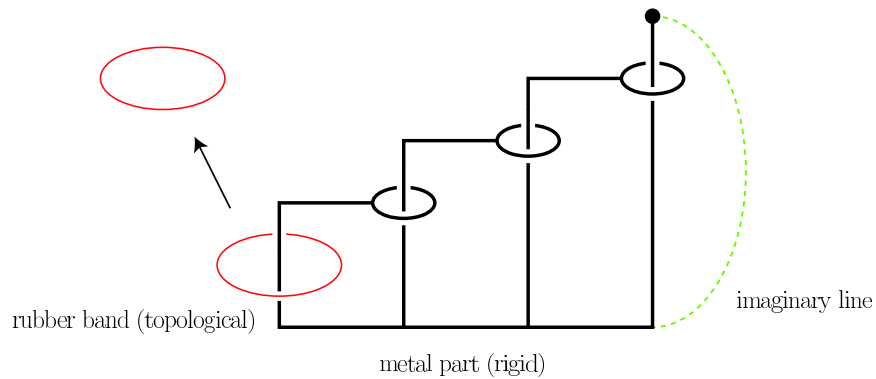

FIGURE 1.3.

The proof of Theorem 1.2 in [6] is based on a group-theoretical argument. In this paper we give a new proof of Theorem 1.2 based on covering space theory. The method of proof is applicable to other similar problems. As examples we show Theorem 1.3 and Theorem 1.5 below. So far as the author's understanding the argument in [6] does not work for the proof of Theorem 1.3.

Let n be a natural number with $n \geq 2$. Let H_n be an abstract graph, e_1 and e_2 abstract loops of H_n , and $\alpha_n : H_n \rightarrow \mathbb{S}^3$ and $\beta_n : H_n \rightarrow \mathbb{S}^3$ spatial embeddings of H_n as illustrated in Figure 1.4. Here α_n and β_n differ only on e_1 . In Figure 1.4 only the cases $n = 2, 3, 4$ are illustrated. The general case n is an obvious generalization of these cases. Then we have the following theorem.

Theorem 1.3. *Let n be a natural number with $n \geq 2$. Let $\alpha_n : H_n \rightarrow \mathbb{S}^3$ and $\beta_n : H_n \rightarrow \mathbb{S}^3$ be spatial embeddings of H_n as illustrated in Figure 1.4. Then $d_{1,2}(\alpha_n, \beta_n) = 2^n - 2$.*

Let J_n be the connected component of H_n containing e_2 . Then $\alpha_n(J_n)$ is nontrivial [8]. Since every proper subgraph of $\alpha_n(J_n)$ is trivial we see that the fundamental group of the complement $\mathbb{S}^3 \setminus \alpha_n(J_n)$ is not a free group [7]. Therefore the argument in [6] regarding $\alpha_n(e_1)$ as an element of the fundamental group will not work here. On the other hand it is not hard to see, for example by repeated use of the replacement of crossing changes illustrated in Figure 2.1 and Figure 2.6, that $\alpha_n(H_n)$ is deformed into a trivial spatial graph by self-crossing changes on the edge e_2 . Therefore the argument in [6] regarding $\alpha_n(e_2)$ as an element of the fundamental

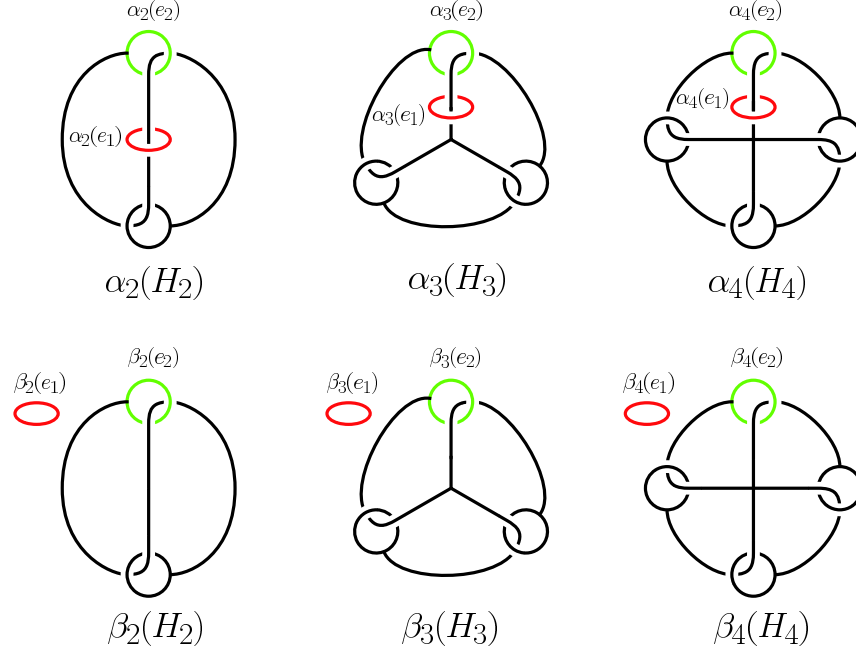

FIGURE 1.4.

group will not work, too. Therefore Theorem 1.3 is an entirely new result to the best of the author's understanding.

Let T be a uni-trivalent tree. Namely T is a finite connected graph without cycles and $V(T) = V_1(T) \cup V_3(T)$ where $V_i(G)$ denotes the set of all degree i vertices of a graph G . Let e be an edge of T . Let Y_1 be the minimal subgraph of T containing the edge e . Let Y_2 be the minimal subgraph of T containing Y_1 and all edges of T adjacent to e . Suppose that Y_k is defined. Then Y_{k+1} is defined to be the minimal subgraph of T containing Y_k and all edges of T adjacent to some edge of Y_k . Then there are a natural number n and a sequence of subgraphs Y_1, Y_2, \dots, Y_n of T such that $Y_1 \subset Y_2 \subset \dots \subset Y_n = T$ and Y_{n-1} is a proper subgraph of T if $n \geq 2$. For each Y_i we assign an unoriented link $l_i \subset \mathbb{S}^3$ and a bijection from $V_1(Y_i)$ to the set of the components of l_i , denoted by $C(l_i)$, as follows. For Y_1 we assign a Hopf link l_1 . We assign an arbitrary bijection from $V_1(Y_1)$ to $C(l_1)$. Now suppose that for Y_k a link l_k and a bijection from $V_1(Y_k)$ to $C(l_k)$ are assigned. For each vertex $v \in V_1(Y_k) \cap V_3(Y_{k+1})$ we replace the component of l_k corresponding to v by a pair of components forming a Bing double [1]. The two vertices in $V(Y_{k+1}) \setminus V(Y_k)$ adjacent to v correspond to the pair of components forming the Bing double. Other correspondences are inherited from that of Y_k and l_k . See for example Figure 1.5 where the sequences of numbers describe the correspondence between $V_1(Y_k)$ and the components of l_k . We call $L_T = l_n$ the unoriented link associated with T and e the defining edge of L_T . Let v and w be two vertices of T . Let $P(v, w)$ be the path in T with $\partial P(v, w) = \{v, w\}$. Let $d(v, w)$ be the number of the edges of $P(v, w)$. Let a and b be mutually distinct components of L_T . Let v and w be the corresponding vertices in $V_1(T)$. Set $d(a, b) = d(v, w)$.

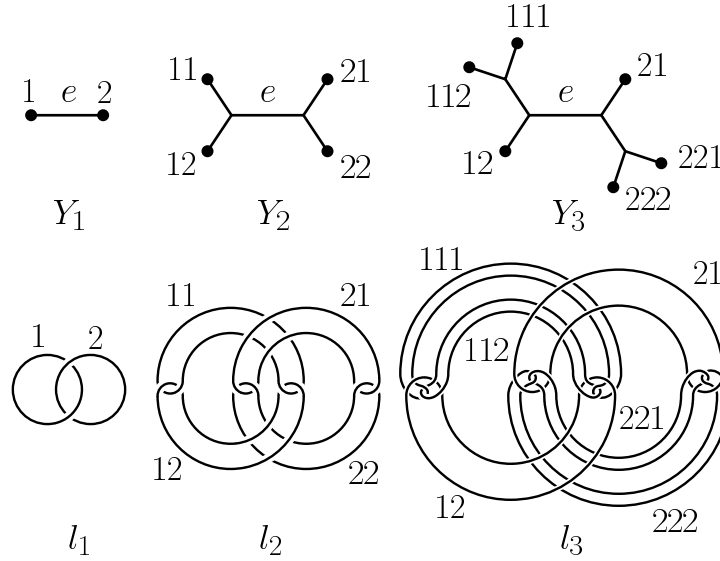

FIGURE 1.5.

Remark 1.4. (1) We will see in Proposition 2.2 that the link type of l_n is independent of the choice of the defining edge e of T . We also note that l_n is obtained from a trivial link by applying a C_m -move along a simple tree clasper whose underlying tree is T [2]. In this sense the well-definedness is already known.

(2) Let T be a uni-trivalent tree such that every element of $V_3(T)$ is adjacent to an element of $V_1(T)$. Then L_T is a Milnor link first appeared in [5].

(3) For an unoriented link L and a subset \mathcal{F} of \mathcal{E} , the \mathcal{F} -unknotting number $u_{\mathcal{F}}(L)$ of L is well-defined since any two oriented trivial links of the same number of components are mutually ambient isotopic.

Theorem 1.5. *Let T be a uni-trivalent tree. Let L_T be the unoriented link associated with T . Let a and b be mutually distinct components of L_T and $\mathcal{F} = \{[a, b]\}$. Then $u_{\mathcal{F}}(L_T) = 2^{d(a,b)-1}$.*

2. PROOFS

Proof of Theorem 1.2. First we give a proof of $d_{1,2}(f_n, g_n) \leq 2^n$. The proof is essentially the same as that in [6] or [9]. We repeatedly use the technic of replacing crossing changes as illustrated in Figure 2.1. In Figure 2.2 the number attached to an edge describes the number of crossing changes with $f_n(e_2)$ that realize a crossing change with the edge. Then we see $d_{1,2}(f_n, g_n) \leq 2^n$.

Next we give a new proof of $d_{1,2}(f_n, g_n) \geq 2^n$ by an induction on n . Let $k \subset f_n(G_n) \cap g_n(G_n)$ be the trivial knot illustrated in Figure 1.2. Let $N(k)$ be a regular neighbourhood of k in \mathbb{S}^3 . We may suppose that $f_n(G_n) \cap N(k) = g_n(G_n) \cap N(k)$ is a simple arc. Since k is trivial $W = \mathbb{S}^3 \setminus \text{int}N(k)$ is a solid torus. Let $\varphi : U \rightarrow W$ be the universal covering projection. Then we have the preimage $\varphi^{-1}(f_n(G_n) \cap W)$ in U . See Figure 2.3 where the case $n = 3$ is illustrated. Since U is homeomorphic to $\mathbb{D}^2 \times \mathbb{R}$, $\mathbb{D}^2 \times \mathbb{R}$ is a subset of \mathbb{R}^3 and \mathbb{R}^3 is a subset of its one-point compactification

\mathbb{S}^3 , we may suppose that U is a subset of \mathbb{S}^3 . Let J be a connected component of $\varphi^{-1}(f_n(e_1))$ illustrated in Figure 2.3. Let $l \subset \partial N(k)$ be a meridian of $N(k)$ containing the point $f_n(G_n) \cap \partial N(k) = g_n(G_n) \cap \partial N(k)$. Then l is a longitude of W . In U we find two copies of $f_{n-1}(G_{n-1})$ in $\varphi^{-1}(f_n(G_n) \cup l)$ containing J as illustrated in Figure 2.3. In case $n = 1$ we have two copies of a Hopf link. Suppose that there is a sequence of crossing changes between $f_n(e_1)$ and $f_n(e_2)$ that deforms $f_n(G_n)$ to $g_n(G_n)$. Each of crossing change lifts to crossing changes in U . In particular a crossing change in W lifts to a crossing change between J and one of the connected components of $\varphi^{-1}(f_n(e_2))$. Since each connected component of $\varphi^{-1}(g_n(e_1))$ bounds a disk in $U \setminus \varphi^{-1}(g_n(G_n \setminus e_1))$ we see that each copy of $f_{n-1}(G_{n-1})$ should be deformed into a copy of $g_{n-1}(G_{n-1})$ by these crossing changes in U . Therefore the number of crossing changes should be greater than or equal to the twice of $d_{1,2}(f_{n-1}, g_{n-1})$. See for example Figure 2.4 where the case $n = 2$ is illustrated. Then we inductively have $d_{1,2}(f_n, g_n) \geq 2^n$. \square

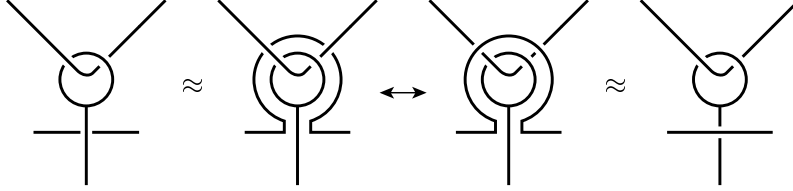

FIGURE 2.1.

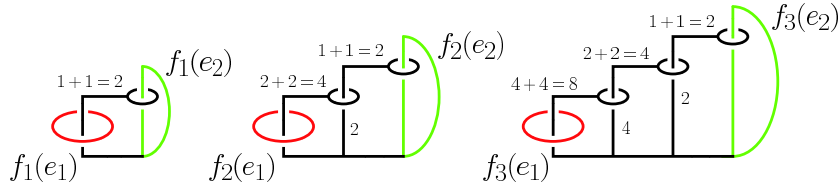

FIGURE 2.2.

Lemma 2.1. *Let p and q be positive integers with $p \leq q$. Let $G_{p,q}$ be a finite graph and $f_{p,q} : G_{p,q} \rightarrow \mathbb{S}^3$ a spatial embedding of $G_{p,q}$ as illustrated in Figure 2.5. Let $g_{p,q} : G_{p,q} \rightarrow \mathbb{S}^3$ be a spatial embedding of $G_{p,q}$ that is different from $f_{p,q}$ only on e_1 such that $g_{p,q}(e_1)$ bounds a disk whose interior is disjoint from $g_{p,q}(G_{p,q})$. Then $d_{\{[e_1, e_2], [e_1, e_3]\}}(f_{p,q}, g_{p,q}) = 2^p$.*

Proof. First we show $d_{\{[e_1, e_2], [e_1, e_3]\}}(f_{p,q}, g_{p,q}) \leq 2^p$. We repeatedly use the technic of replacing crossing changes as illustrated in Figure 2.1 and Figure 2.6. In Figure 2.5 the number attached to an edge describes the number of crossing changes with $f_{p,q}(e_2)$ that realize a crossing change with the edge. Then we see $d_{\{[e_1, e_2], [e_1, e_3]\}}(f_{p,q}, g_{p,q}) \leq 2^p$.

Next we show $d_{\{[e_1, e_2], [e_1, e_3]\}}(f_{p,q}, g_{p,q}) \geq 2^p$ by an induction on p . The outline of the proof is similar to that of Theorem 1.2. Suppose that $p = 1$. Since

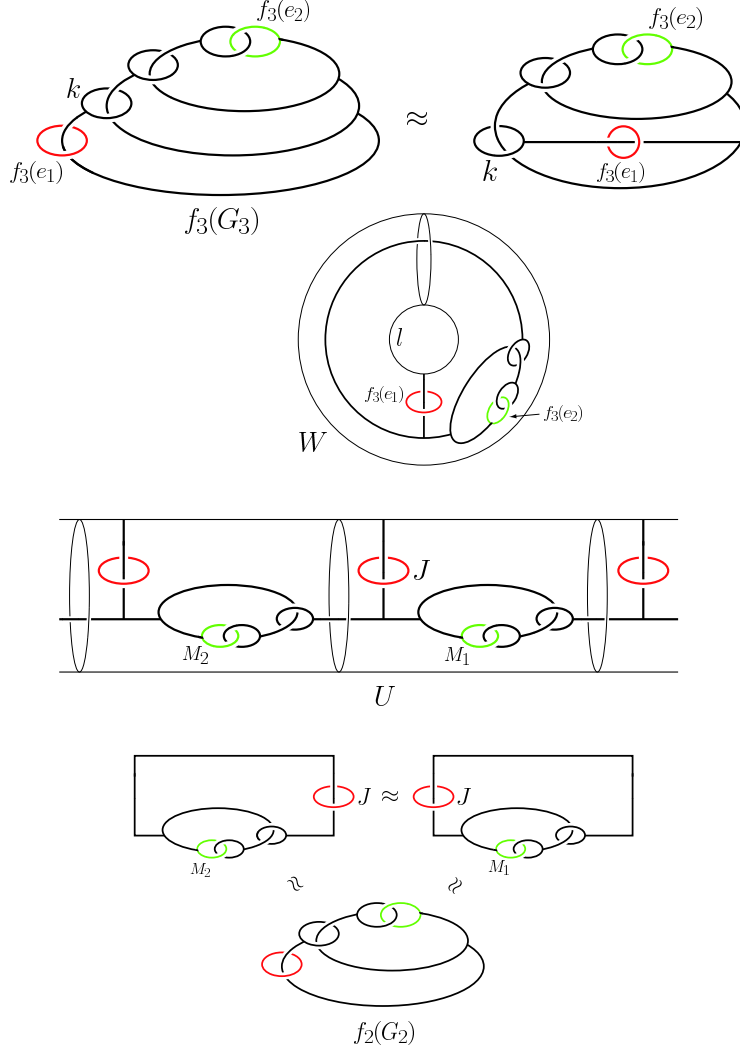

FIGURE 2.3.

$f_{p,q}(G_{p,q})$ is non-splittable [8] we have $d_{\{[e_1, e_2], [e_1, e_3]\}}(f_{p,q}, g_{p,q}) > 0$. Then by considering the changes of the linking number of $f_{p,q}(e_1)$ and $f_{p,q}(e_2)$ or $f_{p,q}(e_3)$ we have $d_{\{[e_1, e_2], [e_1, e_3]\}}(f_{p,q}, g_{p,q}) \geq 2$. Suppose that $p \geq 2$. Let k be a trivial knot illustrated in Figure 2.7. Let $N(k)$ be a regular neighbourhood of k in \mathbb{S}^3 . We may suppose that $f_{p,q}(G_{p,q}) \cap N(k) = g_{p,q}(G_{p,q}) \cap N(k)$ is a simple arc. Since k is trivial $W = \mathbb{S}^3 \setminus \text{int}N(k)$ is a solid torus. Let $\varphi : U \rightarrow W$ be the universal covering projection. Then we have the preimage $\varphi^{-1}(f_{p,q}(G_{p,q}) \cap W)$ in U . See Figure 2.7. As in the proof of Theorem 1.2 we may suppose that U is a subset of \mathbb{S}^3 . Let J be a connected component of $\varphi^{-1}(f_{p,q}(e_1))$ illustrated in Figure 2.7. Let $l \subset \partial N(k)$ be a meridian of $N(k)$ containing the point $f_{p,q}(G_{p,q}) \cap \partial N(k) = g_{p,q}(G_{p,q}) \cap \partial N(k)$. Then l is a longitude of W . In U we find two copies of $f_{p-1,q}(G_{p-1,q})$ in $\varphi^{-1}(f_{p,q}(G_{p,q}) \cup l)$ containing J as illustrated in Figure 2.7. Therefore as in the proof of Theorem

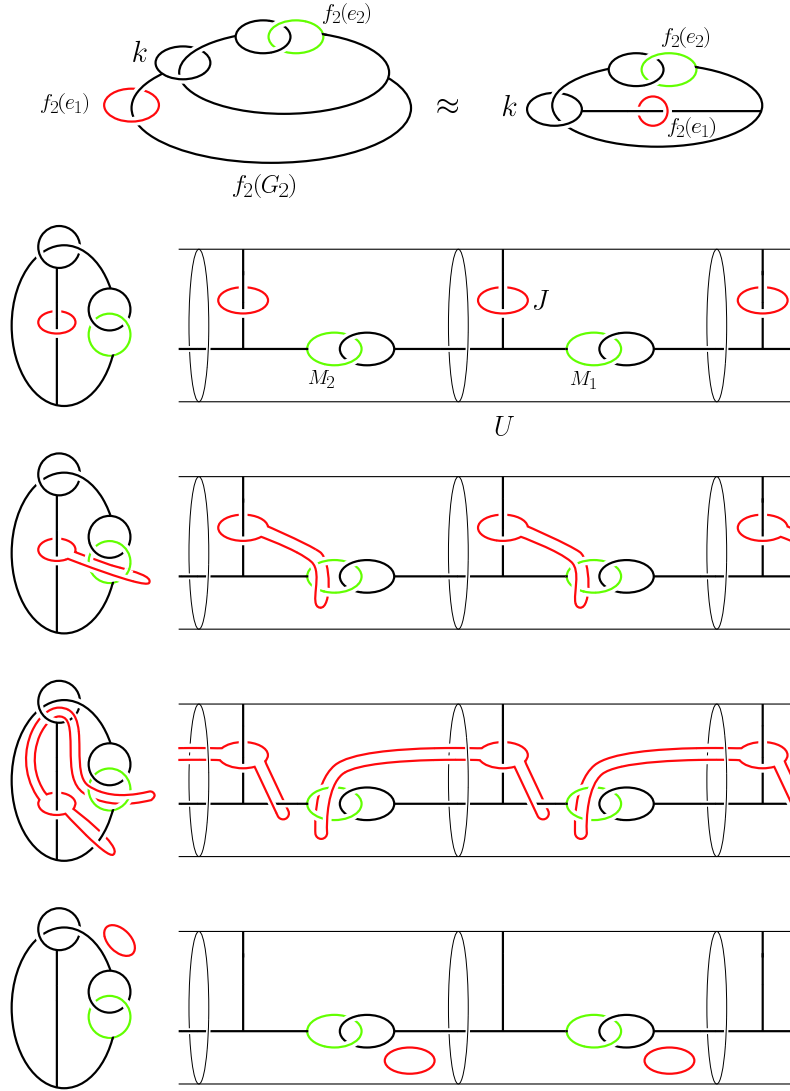

FIGURE 2.4.

1.2 we see that $d_{\{[e_1, e_2], [e_1, e_3]\}}(f_{p,q}, g_{p,q})$ is greater than or equal to the twice of $d_{\{[e_1, e_2], [e_1, e_3]\}}(f_{p-1,q}, g_{p-1,q})$. Then we inductively have $d_{\{[e_1, e_2], [e_1, e_3]\}}(f_{p,q}, g_{p,q}) \geq 2^p$. \square

Proof of Theorem 1.3. First we show $d_{1,2}(\alpha_n, \beta_n) \leq 2^n - 2$. We repeatedly use the technic illustrated in Figure 2.1 and Figure 2.6. In Figure 2.8 the number attached to an edge describes the number of crossing changes with $\alpha_n(e_2)$ that realize a crossing change with the edge. Then we see $d_{1,2}(\alpha_n, \beta_n) \leq 2 + 4 + 8 + \dots + 2^{n-1} = 2^n - 2$.

Next we show $d_{1,2}(\alpha_n, \beta_n) \geq 2^n - 2$. The outline of the proof is similar to that of Theorem 1.2.

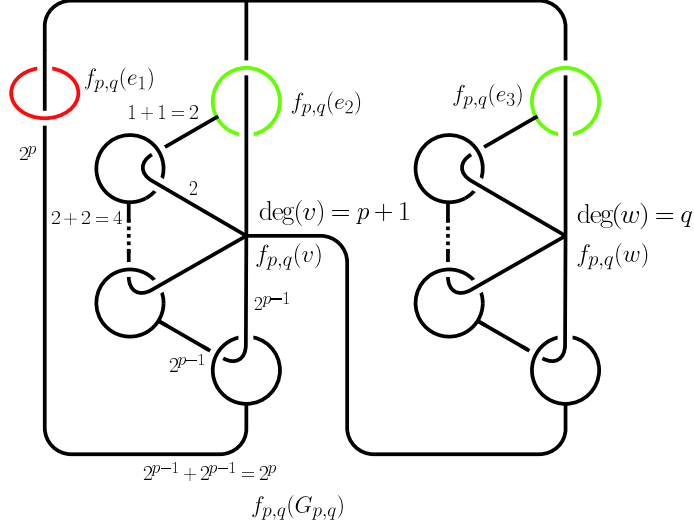

FIGURE 2.5.

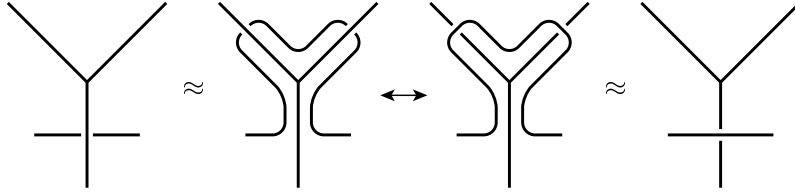

FIGURE 2.6.

Suppose that $n = 2$. Since $\alpha_2(H_2)$ is non-splittable [8] we have $d_{1,2}(\alpha_2, \beta_2) > 0$. Then by considering the changes of the linking number of $\alpha_2(e_1)$ and $\alpha_2(e_2)$ we have $d_{1,2}(\alpha_2, \beta_2) \geq 2$. Suppose that $n \geq 3$. Let k be a trivial knot illustrated in Figure 2.9 and $N(k)$ a regular neighbourhood of k in \mathbb{S}^3 such that $\alpha_n(H_n) \cap N(k) = \beta_n(H_n) \cap N(k)$ is a simple arc. Let $W = \mathbb{S}^3 \setminus \text{int}N(k)$ be a solid torus. Let $\varphi : U \rightarrow W$ be the universal covering projection. Then we have the preimage $\varphi^{-1}(\alpha_n(H_n) \cap W)$ in U . See Figure 2.9. As in the proof of Theorem 1.2 we may suppose that U is a subset of \mathbb{S}^3 . Let J be a connected component of $\varphi^{-1}(\alpha_n(e_1))$ illustrated in Figure 2.9. Let $l \subset \partial N(k)$ be a meridian of $N(k)$ containing the point $\alpha_n(H_n) \cap \partial N(k) = \beta_n(H_n) \cap \partial N(k)$. Then l is a longitude of W . In $\varphi^{-1}(\alpha_n(H_n) \cup l)$ in U we find a copy of $\alpha_{n-1}(H_{n-1})$ and a copy of $f_{n-1,n-1}(G_{n-1,n-1})$ both containing J as illustrated in Figure 2.9. Therefore as in the proof of Theorem 1.2 we see that $d_{1,2}(\alpha_n, \beta_n)$ is greater than or equal to the sum of $d_{1,2}(\alpha_{n-1}, \beta_{n-1})$ and $d_{\{[e_1, e_2], [e_1, e_3]\}}(f_{n-1,n-1}, g_{n-1,n-1})$. Since $(2^{n-1} - 2) + 2^{n-1} = 2^n - 2$ we inductively have $d_{1,2}(\alpha_n, \beta_n) \geq 2^n - 2$. \square

Proposition 2.2. *The link type of l_n is independent of the choice of the defining edge e of T .*

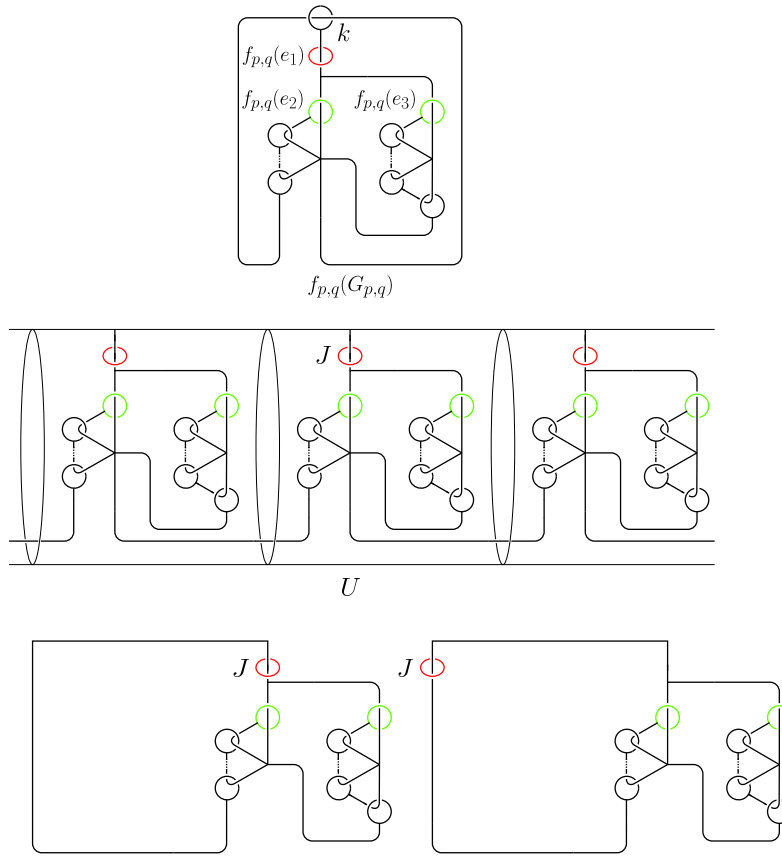

FIGURE 2.7.

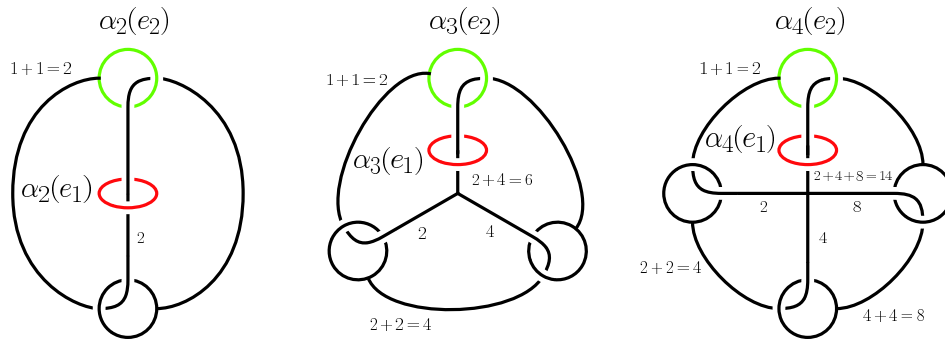

FIGURE 2.8.

Proof. It is sufficient to show that the link type of l_n is unchanged when we replace e by an edge e' adjacent to e . This follows from the fact that the Borromean rings is a Bing double of a Hopf link and the Borromean rings has 3-symmetry with respect to the components. See Figure 2.10. \square

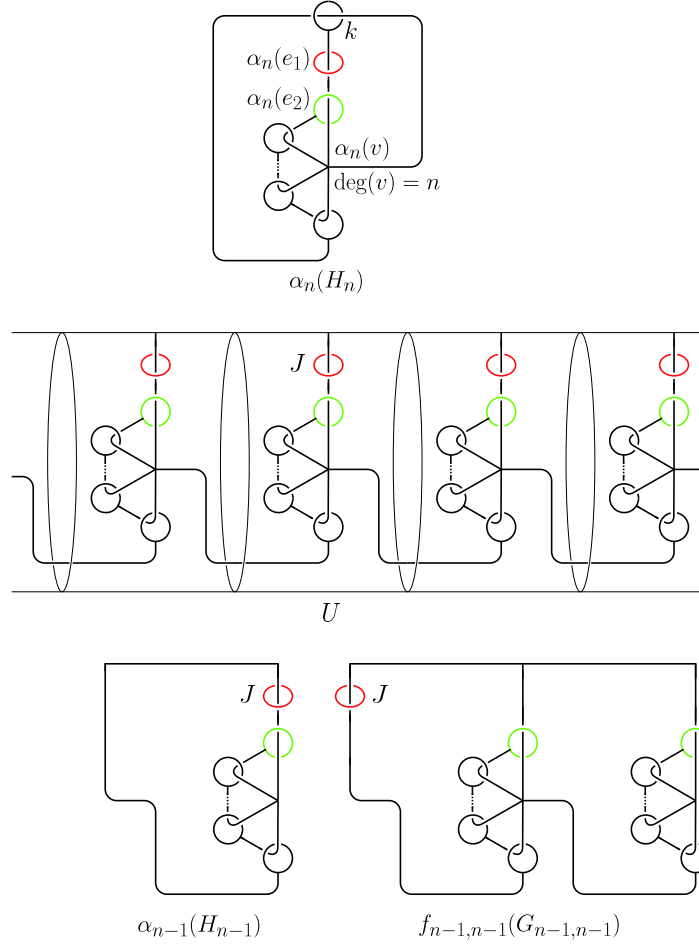

FIGURE 2.9.

Lemma 2.3. *Let T be a uni-trivalent tree and v, w, x mutually distinct vertices in $V_1(T)$. Let $P(v, w)$ be the path in T with $\partial P(v, w) = \{v, w\}$. Let y be the vertex of T adjacent to x . Let s and t be the other vertices of T adjacent to y . Let T' be a uni-trivalent tree obtained from T by deleting x, y and the edges incident to y and by joining s and t by a new edge e' . Let a and b (resp. a' and b') be the components of L_T (resp. $L_{T'}$) corresponding to v and w respectively. Let $\mathcal{F} = \{[a, b]\}$ and $\mathcal{F}' = \{[a', b']\}$. If y is not a vertex of $P(v, w)$, then $u_{\mathcal{F}}(L_T) \geq u_{\mathcal{F}'}(L_{T'})$. If y is a vertex of $P(v, w)$, then $u_{\mathcal{F}}(L_T) \geq 2u_{\mathcal{F}'}(L_{T'})$.*

Proof. Let c_0 be a component of L_T corresponding to x . Let e be the edge of T joining x and y . By Proposition 2.2 we may suppose that e is the defining edge of L_T . Let $M = c_0 \cup c_1 \cup c_2$ be Borromean Rings and $N(c_0), N(c_1)$ and $N(c_2)$ mutually disjoint regular neighbourhoods of c_0, c_1 and c_2 respectively such that L_T is contained in $c_0 \cup N(c_1) \cup N(c_2)$ and obtained from M by repeatedly taking Bing doubles. If y is not a vertex of $P(v, w)$ then $a \cup b$ is contained in $N(c_1)$ or

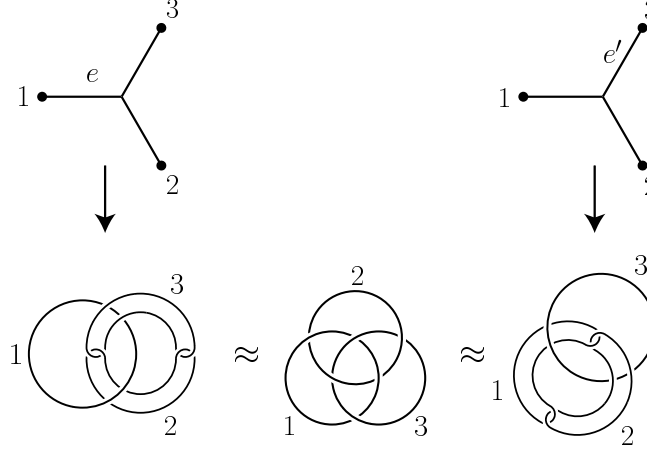

FIGURE 2.10.

$N(c_2)$. If y is a vertex of $P(v, w)$ then $a \cup b$ is not contained in $N(c_1)$ nor $N(c_2)$. We note that $W = \mathbb{S}^3 \setminus \text{int}N(c_0)$ is a solid torus containing $N(c_1) \cup N(c_2)$. Let $\varphi : U \rightarrow W$ be the universal covering projection. Then we have the preimage $\varphi^{-1}(N(c_1) \cup N(c_2))$ in U and $\varphi^{-1}(L_T \setminus c_0)$ in $\varphi^{-1}(N(c_1) \cup N(c_2))$. By Proposition 2.2 we may suppose that e' is the defining edge of $L_{T'}$. Then there is a Hopf link $H = c_1' \cup c_2'$ and mutually disjoint regular neighbourhoods $N(c_1')$ and $N(c_2')$ of c_1' and c_2' respectively such that $L_{T'}$ is contained in $N(c_1') \cup N(c_2')$ and obtained from H by repeatedly taking Bing doubles. We may also suppose that the pair $(N(c_1), L_T \cap N(c_1))$ is homeomorphic to the pair $(N(c_1'), L_{T'} \cap N(c_1'))$ and the pair $(N(c_2), L_T \cap N(c_2))$ is homeomorphic to the pair $(N(c_2'), L_{T'} \cap N(c_2'))$. Therefore there exist countably many copies of $L_{T'}$ in $\varphi^{-1}(L_T \setminus c_0)$. See Figure 2.11. Then we have $u_{\mathcal{F}}(L_T) \geq u_{\mathcal{F}'}(L_{T'})$. If y is a vertex of $P(u, v)$, then $a \cup b$ is not contained in $N(c_1)$ nor $N(c_2)$ and the situation is lifted to U . Then by the same reason as in the proofs of Theorem 1.2 and Theorem 1.3 we have $u_{\mathcal{F}}(L_T) \geq 2u_{\mathcal{F}'}(L_{T'})$. \square

Proof of Theorem 1.5. Let v and w be the vertices in $V_1(T)$ corresponding to a and b respectively. Let $P(v, w)$ be the path in T with $\partial P(v, w) = \{v, w\}$.

First we show $u_{\mathcal{F}}(L_T) \leq 2^{d(a,b)-1}$. Let e be an edge of $P(v, w)$. By Proposition 2.2 we may suppose that e is the defining edge of L_T . In the process of taking a Bing double involving a component corresponding a vertex of $P(v, w)$ we may suppose that the other component is small enough so that it has only four crossings in a diagram. Thus we have a diagram of L_T and $2^{d(a,b)-1}$ crossings of it such that changing all of them will turn L_T into a trivial link. See for example Figure 2.12.

Next we show $u_{\mathcal{F}}(L_T) \geq 2^{d(a,b)-1}$ by an induction on the number of the edges of T . If T has exactly one edge, then L_T is a Hopf link and $d(a, b) = 1$. Then we have $u_{\mathcal{F}}(L_T) = 1 = 2^{d(a,b)-1}$. Suppose that T has three or more edges. Assume that the claim is true for all trees of fewer edges. Let x be a vertex in $V_1(T) \setminus \{v, w\}$. Let y be the vertex of T adjacent to x . Let T' be the graph obtained from T as described in Lemma 2.3. Let a' and b' be the components of $L_{T'}$ corresponding to v and w respectively. Let $\mathcal{F}' = \{[a', b']\}$. Let $P'(v, w)$ be the path in T' with $\partial P'(v, w) = \{v, w\}$. If y is not a vertex of $P(v, w)$, then $P(v, w) = P'(v, w)$

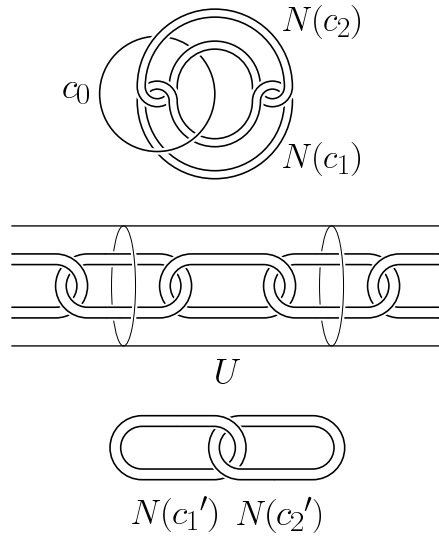

FIGURE 2.11.

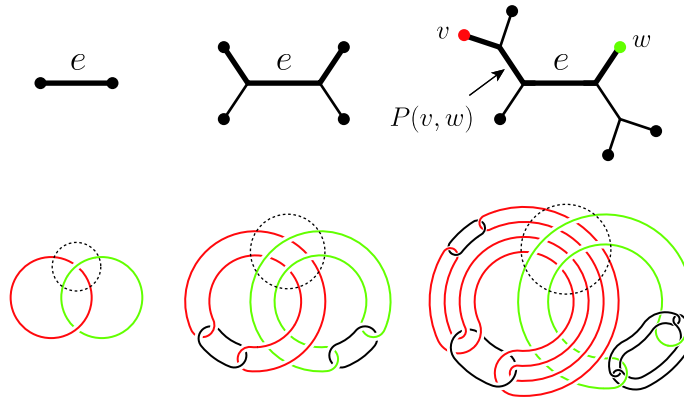

FIGURE 2.12.

and the number of the edges of $P'(v, w)$ is equal to that of $P(v, w)$. Therefore $d(a, b) = d(a', b')$. By Lemma 2.3 we have $u_{\mathcal{F}}(L_T) \geq u_{\mathcal{F}'}(L_{T'})$. By the assumption $u_{\mathcal{F}'}(L_{T'}) \geq 2^{d(a', b')-1}$. Thus we have $u_{\mathcal{F}}(L_T) \geq 2^{d(a, b)-1}$. If y is a vertex of $P(v, w)$, then the number of the edges of $P'(v, w)$ is one less than that of $P(v, w)$. Therefore $d(a, b) = d(a', b') + 1$. By Lemma 2.3 we have $u_{\mathcal{F}}(L_T) \geq 2u_{\mathcal{F}'}(L_{T'})$. By the assumption $u_{\mathcal{F}'}(L_{T'}) \geq 2^{d(a', b')-1}$. Thus we have $u_{\mathcal{F}}(L_T) \geq 2^{d(a, b)-1}$. \square

ACKNOWLEDGMENTS

In 2012 a Japanese company East Entertainment Inc. asked the author to provide a problem in knot theory for a TV program of Fuji Television Network, Inc. entitled Takeshi-no-Komadai-Sugakuka. It was an entertainment program based on mathematics. Then the author considered puzzle ring problem and he have found

a new proof of Theorem 1.2. The author is grateful to East Entertainment Inc. for giving him such an opportunity.

REFERENCES

- [1] R. Bing, A homeomorphism between the 3-sphere and the sum of two solid horned spheres, *Ann. of Math.*, **56** (1952), 354-362.
- [2] K. Habiro, Claspers and finite type invariants of links, *Geom. Topol.*, **4** (2000), 1-83.
- [3] L. Kauffman, Tangle complexity and the topology of the Chinese rings, Mathematical approaches to biomolecular structure and dynamics, IMA Vol. 82, Springer, New York, 1996, 1-10.
- [4] W. Mason, Homeomorphic continuous curves in 2-space are isotopic in 3-space, *Trans. Amer. Math. Soc.*, **142** (1969), 269-290.
- [5] J. Milnor, Link groups, *Ann. of Math.*, **59** (1954), 177-195.
- [6] J. Przytycki and A. Sikora, Topological insights from the Chinese rings, *Proc. Amer. Math. Soc.*, **130** (2002), 893-902.
- [7] M. Scharlemann and A. Thompson, Detecting unknotted graphs in 3-space, *J. Differential Geom.*, **34** (1991), 539-560.
- [8] K. Taniyama, Irreducibility of spatial graphs, *J. Knot Theory Ramifications*, **11** (2002), 121-124.
- [9] K. Taniyama, Topology of puzzle rings, *Asia Pac. Math. Newsl.*, **5** (2015), 6-8.

DEPARTMENT OF MATHEMATICS, SCHOOL OF EDUCATION, WASEDA UNIVERSITY, NISHI-WASEDA
1-6-1, SHINJUKU-KU, TOKYO, 169-8050, JAPAN
E-mail address: `taniyama@waseda.jp`