

SPECTRAL PROPERTIES OF SCHRÖDINGER OPERATORS ON PERTURBED LATTICES

KAZUNORI ANDO, HIROSHI ISOZAKI, AND HISASHI MORIOKA

ABSTRACT. We study the spectral properties of Schrödinger operators on perturbed lattices. We shall prove the non-existence or the discreteness of embedded eigenvalues, the limiting absorption principle for the resolvent, construct a spectral representation, and define the S-matrix. Our theory covers the square, triangular, diamond, Kagome lattices, as well as the ladder, the graphite and the subdivision of square lattice.

1. INTRODUCTION

In this and the forthcoming articles, we shall investigate the spectral properties of Schrödinger operators on perturbed periodic lattices of dimension $d \geq 2$. The physical background is the scattering phenomenon. Sending waves from the infinity of a perturbed periodic structure, we observe the behavior of scattered waves at infinity. The mapping from the free wave in the remote past to the scattered wave in the remote future is the scattering matrix (S-matrix). Our goal is the inverse scattering, in particular, we aim at the reconstruction of the perturbed periodic structure from the S-matrix of a fixed energy. In the present paper, we devote ourselves to the forward problem, i.e. that of the continuous spectrum of the Schrödinger operator describing the scattering process, more precisely, the limiting absorption principle for the resolvent, construction of spectral representations and S-matrix are the main ingredients. The inverse problem will be discussed in the 2nd part [5].

We start from the Laplacian \widehat{H}_0 on a lattice in \mathbf{R}^d , which is a matrix whose entries are shift operators. Passing to the Fourier series, it is transformed to an operator of multiplication by an hermitian matrix $H_0(x)$ acting on a vector bundle on the flat torus $\mathbf{T}^d = \mathbf{R}^d / (2\pi\mathbf{Z})^d$. Then its spectral properties boil down to the characteristic polynomial $p(x, \lambda) = \det(H_0(x) - \lambda)$.

A lot of remarkable methods have been found in the long history of scattering theory, e.g. [28], [12], [1], [29], [32], [22], [11], [39], [9], [50], [37], [38], ranging over a variety of areas of mathematical analysis. It is worthwhile to recall here the role of Fourier transform in the study of the continuous spectrum of a self-adjoint differential operator $H = P(D_x) + V(x, D_x)$ on \mathbf{R}^d . The first important step is the Rellich type theorem, or Rellich-Vekua theorem, which gives the minimal growth rate for solutions to the equation $(P(D_x) + V(x, D_x) - \lambda)u = 0$ as $|x| \rightarrow \infty$ (see [42], [49]). When $V(x, D_x) = 0$, by passing to the Fourier transform, this is reduced to the algebraic properties of the polynomial $P(\xi)$ and the Paley-Wiener

Date: April, 3, 2015.

2000 Mathematics Subject Classification. Primary 81U40, Secondary 47A40.

Key words and phrases. Schrödinger operator, lattice, scattering theory.

Theorem (see [35], [36], [18], [40]). To see the continuous spectrum of H , Agmon [2] derived a theorem of division by $P(\xi)$ in some weighted $L^2(\mathbf{R}^d)$ -space and proved the existence of the limit $\lim_{\epsilon \rightarrow 0}(H - \lambda \mp i\epsilon)^{-1}$. This is the limiting absorption principle, the key step to clarify the detailed spectral structure. Agmon-Hörmander [3], [19], [20] supplemented this approach by introducing Besov spaces $\mathcal{B}, \mathcal{B}^*$, which are optimal for the existence of the limit $(H - \lambda \mp i0)^{-1}$, and introduced the radiation condition in the form of pseudo-differential operators (Ψ DO) to guarantee the uniqueness of the solution. Our strategy is to extend this Agmon-Hörmander's approach to discrete problems.

Inverse potential scattering for discrete Schrödinger operators have already been considered in [24] on the square lattice (see also [13]) and in [4] on the hexagonal lattice, where knowledge of the S-matrix for all energies is used for the reconstruction of the potential by the method of complex Born approximation. In [27], inverse potential scattering on the square lattice from the S-matrix of one fixed energy is studied. The main idea of [27] is to reduce the issue to an inverse boundary value problem on a bounded domain, and the reconstruction is done through the Dirichlet-Neumann map. To relate the scattering matrix with the D-N map for the bounded domain, the discrete analogue of the Rellich type uniqueness theorem plays an important role ([26]). The radiation condition is closely related to the asymptotic behavior of the Green function as space variables tend to infinity. It requires the strict convexity of the Fermi surface $M_\lambda = \{x \in \mathbf{T}^d; p(x, \lambda) = 0\}$ for the Laplacian on the unperturbed periodic lattice, hence restricts the energy region for the reconstruction procedure to be valid. In the present work, we introduce the radiation condition in the form of wavefront set as in [3], and instead of the behavior of the resolvent near infinity of the lattice space, we consider the singularity expansion of the resolvent on the torus. This change of view point makes it possible to remove the above mentioned assumption of strict convexity and the restriction for the energy level. We also mention that [26] relies on [43] which gives basic ideas from the theory of functions of several complex variables and algebraic geometry in the proof of Rellich type theorem.

The plan of the paper is as follows. Our final result in this paper is Theorem 7.15 in §7 on the characterization of the solution space of the Helmholtz equation.

- §2. Basic properties of graph
- §3. Examples of periodic lattices
- §4. Distributions on the torus
- §5. Rellich type theorem on the torus
- §6. Spectral properties of the free Hamiltonian
- §7. Hamiltonians on the perturbed lattice

In §2, we introduce the Laplacian on the lattice. Passing to the Fourier series, it is transferred to a matrix on the torus, whose characteristic polynomial is crucial for the spectral properties, and we pick up two typical cases. §3 is devoted to the exposition of various examples of lattices, and basic properties of their Laplacians. The main analytical tool to study the spectrum is a division theorem for distributions on the torus, which we discuss in §4. The main aim of §5 is to prove the Rellich type theorem for the discrete Laplacian on the lattice by using Hilbert Nullstellensatz. In §6, we study the spectral properties for the unperturbed lattice. Based on these preparations, we develop in §7 the spectral and scattering theory

for the Laplacian on the perturbed lattice. The main results are the resolvent estimates, spectral representations, unitarity of the S-matrix and the structure of the solution space for the Helmholtz equation.

The spectral properties for discrete Schrödinger operators, more generally perturbed Laplacians on non-compact graphs, have been discussed a long time with an abundance of references, and are nowadays becoming more active issues. We cite here rather recent articles, [31], [46], [15], [16], [17], [47], [6], [8], [30], [41], which are directly related to this paper.

Let us give some remarks on the notation. $\mathbf{T}_{\mathbf{C}}^d$ denotes the complex torus

$$(1.1) \quad \mathbf{T}_{\mathbf{C}}^d = \mathbf{C}^d / (2\pi\mathbf{Z})^d.$$

For $f \in \mathcal{S}'(\mathbf{R}^d)$, $\tilde{f}(\xi)$ denotes its Fourier transform

$$(1.2) \quad \tilde{f}(\xi) = (2\pi)^{-d/2} \int_{\mathbf{R}^d} e^{-ix \cdot \xi} f(x) dx.$$

On the other hand, for $f(x) \in \mathcal{S}'(\mathbf{T}^d)$, $\hat{f}(n)$ denotes its Fourier coefficients

$$(1.3) \quad \hat{f}(n) = (2\pi)^{-d/2} \int_{\mathbf{T}^d} e^{-ix \cdot n} f(x) dx.$$

We also use $\hat{f} = (\hat{f}(n))_{n \in \mathbf{Z}^d}$ to denote a function on \mathbf{Z}^d , and by \mathcal{U} the mapping

$$(1.4) \quad \mathcal{U} : \mathcal{S}'(\mathbf{Z}^d) \ni (\hat{f}(n))_{n \in \mathbf{Z}^d} \rightarrow f(x) = (2\pi)^{-d/2} \sum_{n \in \mathbf{Z}^d} \hat{f}(n) e^{in \cdot x} \in \mathcal{S}'(\mathbf{T}^d).$$

For Banach spaces X and Y , $\mathbf{B}(X; Y)$ denotes the set of all bounded operators from X to Y . For a self-adjoint operator A , $\sigma(A)$, $\sigma_p(A)$, $\sigma_d(A)$, $\sigma_e(A)$ denote its spectrum, point spectrum, discrete spectrum and essential spectrum, respectively. $\mathcal{H}_{ac}(A)$ is the absolutely continuous subspace for A , and $\mathcal{H}_p(A)$ is the closure of the linear hull of eigenvectors of A . For an interval $I \subset \mathbf{R}$ and a Hilbert space \mathbf{h} , $L^2(I, \mathbf{h}, d\lambda)$ denotes the set of all \mathbf{h} -valued L^2 -functions on I with respect to the measure $d\lambda$. $S_{1,0}^m$ denotes the standard Hörmander class of symbols for pseudo-differential operators (Ψ DO), i.e. $|\partial_x^\alpha \partial_\xi^\beta p(x, \xi)| \leq C_{\alpha\beta} (1 + |\xi|)^{m-\beta}$ (see e.g. [21]).

2. BASIC PROPERTIES OF GRAPH

2.1. Vertices and edges. We consider an infinite, connected graph $\{\mathcal{V}, \mathcal{E}\}$, where \mathcal{V} is a vertex set and \mathcal{E} an edge set. We assume that the graph is simple, i.e. there are neither self-loop, which is an edge connecting a vertex to itself, nor multiple edges, which are two or more edges connecting the same vertices. For an edge $e = (v, w) \in \mathcal{E}$, we denote

$$o(e) = v, \quad t(e) = w, \quad \bar{e} = (w, v), \quad v \sim w.$$

In the following, we assume that $e \in \mathcal{E} \implies \bar{e} \in \mathcal{E}$. We put

$$(2.1) \quad \mathcal{N}_v = \{w \in \mathcal{V}; v \sim w\},$$

which will be called the set of points *adjacent* to v . The *degree* of $v \in \mathcal{V}$ is then defined by

$$\deg(v) = \#\mathcal{N}_v = \#\{e \in \mathcal{E}; o(e) = v\},$$

which is assumed to be finite for all $v \in \mathcal{V}$. A function $f : \mathcal{V} \rightarrow \mathbf{C}$ is denoted as $f = (f(v))_{v \in \mathcal{V}}$. Let $\ell^2(\mathcal{V})$ be the set of \mathbf{C} -valued functions f on \mathcal{V} satisfying

$$\|f\|_{\text{deg}}^2 := \sum_{v \in \mathcal{V}} |f(v)|^2 \deg(v) < \infty.$$

Equipped with the inner product

$$(f, g)_{\text{deg}} = \sum_{v \in \mathcal{V}} f(v) \overline{g(v)} \deg(v),$$

$\ell^2(\mathcal{V})$ is a Hilbert space.

2.2. Laplacian on the periodic graph. A periodic graph in \mathbf{R}^d is a triple $\Gamma_0 = \{\mathcal{L}_0, \mathcal{V}_0, \mathcal{E}_0\}$, where \mathcal{L}_0 is a lattice of rank $d \geq 2$ in \mathbf{R}^d with basis $\mathbf{v}_j, j = 1, \dots, d$, i.e.

$$\mathcal{L}_0 = \{\mathbf{v}(n); n \in \mathbf{Z}^d\}, \quad \mathbf{v}(n) = \sum_{j=1}^d n_j \mathbf{v}_j, \quad n = (n_1, \dots, n_d) \in \mathbf{Z}^d,$$

and the vertex set is defined by

$$\mathcal{V}_0 = \bigcup_{j=1}^s (p_j + \mathcal{L}_0),$$

and where $p_j, j = 1, \dots, s$, are the points in \mathbf{R}^d satisfying

$$(2.2) \quad p_i - p_j \notin \mathcal{L}_0, \quad \text{if } i \neq j.$$

By (2.2), there exists a bijection $\mathcal{V}_0 \ni a \rightarrow (j(a), n(a)) \in \{1, \dots, s\} \times \mathbf{Z}^d$ such that

$$a = p_{j(a)} + \mathbf{v}(n(a)).$$

The group \mathbf{Z}^d acts on \mathcal{V}_0 as follows :

$$\mathbf{Z}^d \times \mathcal{V}_0 \ni (m, a) \rightarrow m \cdot a := p_{j(a)} + \mathbf{v}(m + n(a)) \in \mathcal{V}_0.$$

The edge set $\mathcal{E}_0 \subset \mathcal{V}_0 \times \mathcal{V}_0$ is assumed to satisfy

$$\mathcal{E}_0 \ni (a, b) \implies (m \cdot a, m \cdot b) \in \mathcal{E}_0, \quad \forall m \in \mathbf{Z}^d.$$

Then $\deg(p_j + \mathbf{v}(n))$ depends only on j , and is denoted by $\deg_0(j)$:

$$(2.3) \quad \deg_0(j) = \deg(p_j + \mathbf{v}(n)).$$

Any function \widehat{f} on \mathcal{V}_0 is written as $\widehat{f}(n) = (\widehat{f}_1(n), \dots, \widehat{f}_s(n))$, $n \in \mathbf{Z}^d$, where $\widehat{f}_j(n)$ is identified with a function on $p_j + \mathcal{L}_0$. Hence $\ell^2(\mathcal{V}_0)$ is the Hilbert space equipped with the inner product

$$(\widehat{f}, \widehat{g})_{\ell^2(\mathcal{V}_0)} = \sum_{j=1}^s (\widehat{f}_j, \widehat{g}_j)_{\deg_0(j)}.$$

We then define a unitary operator $\mathcal{U}_{\mathcal{L}_0} : \ell^2(\mathcal{V}_0) \rightarrow L^2(\mathbf{T}^d)^s$

$$(2.4) \quad (\mathcal{U}_{\mathcal{L}_0} \widehat{f})_j = (2\pi)^{-d/2} \sqrt{\deg_0(j)} \sum_{n \in \mathbf{Z}^d} \widehat{f}_j(n) e^{in \cdot x},$$

where $L^2(\mathbf{T}^d)^s$ is equipped with the inner product

$$(2.5) \quad (f, g)_{L^2(\mathbf{T}^d)^s} = \sum_{j=1}^s \int_{\mathbf{T}^d} f_j(x) \overline{g_j(x)} dx.$$

Recall that the shift operator \widehat{S}_j acts on a sequence $(a(n))_{n \in \mathbf{Z}^d}$ as follows :

$$(\widehat{S}_j a)(n) = a(n + \mathbf{e}_j),$$

where $\mathbf{e}_1 = (1, 0, \dots, 0), \dots, \mathbf{e}_d = (0, \dots, 0, 1)$. Then we have

$$(2.6) \quad \mathcal{U} \widehat{S}_j = e^{-ix_j} \mathcal{U}.$$

The Laplacian $\widehat{\Delta}_{\Gamma_0}$ on the graph $\Gamma_0 = \{\mathcal{L}_0, \mathcal{V}_0, \mathcal{E}_0\}$ is defined by the following formula

$$(2.7) \quad \begin{aligned} (\widehat{\Delta}_{\Gamma_0} \widehat{f})(n) &= (\widehat{g}_1(n), \dots, \widehat{g}_s(n)), \\ \widehat{g}_i(n) &= \frac{1}{\deg_0(i)} \sum_{b \sim p_i + \mathbf{v}(n)} \widehat{f}_{j(b)}(n(b)), \end{aligned}$$

where $b = p_j(b) + \mathbf{v}(n(b))$. Passing to the Fourier series, we rewrite it into the following form :

$$\mathcal{U}_{\mathcal{L}_0}(-\widehat{\Delta}_{\Gamma_0})(\mathcal{U}_{\mathcal{L}_0})^{-1} f = H_0(x) f(x), \quad f \in L^2(\mathbf{T}^d)^s,$$

where $H_0(x)$ is an $s \times s$ Hermitian matrix whose entries are trigonometric functions. Let D be the $s \times s$ diagonal matrix whose (j, j) entry is $\sqrt{\deg_0(j)}$. Then $\mathcal{U}_{\mathcal{L}_0} = D\mathcal{U}$, hence

$$(2.8) \quad H_0(x) = DH_0^0(x)D^{-1}, \quad H_0^0(x) = \mathcal{U}(-\widehat{\Delta}_{\Gamma_0})\mathcal{U}^{-1},$$

and $H_0^0(x)$ is computed by (2.6).

2.3. Preliminary facts. In this subsection, we consider geometric and algebraic properties of the following functions $a_d(z)$ and $b_d(z)$:

$$(2.9) \quad a_d(z) = \sum_{j=1}^d \cos z_j,$$

$$(2.10) \quad b_d(z) = \sum_{j=1}^d \cos z_j + \sum_{1 \leq j < k \leq d} \cos(z_j - z_k),$$

since all the characteristic polynomials of the examples of lattices to be presented in the next section are reduced to them.

For an analytic function f on $\mathbf{T}_{\mathbf{C}}^d$, we put

$$\begin{aligned} S_a^{\mathbf{C}}(f) &= \{z \in \mathbf{T}_{\mathbf{C}}^d; f(z) = a\}, \\ S_{a,reg}^{\mathbf{C}}(f) &= \{z \in S_a^{\mathbf{C}}(f); \nabla_z f(z) \neq 0\}, \\ S_{a,sneg}^{\mathbf{C}}(f) &= \{z \in S_a^{\mathbf{C}}(f); \nabla_z f(z) = 0\}, \\ SV(f) &= \left\{ f(z); z \in \bigcup_{a \in \mathbf{C}} S_{a,sneg}^{\mathbf{C}}(f) \right\}, \\ f(\mathbf{T}^d) &= \{f(x); x \in \mathbf{T}^d\}. \end{aligned}$$

Lemma 2.1. (1) $\bigcup_{a \in \mathbf{C}} S_{a,sneg}^{\mathbf{C}}(a_d) = (\pi \mathbf{Z})^d \cap \mathbf{T}_{\mathbf{C}}^d$.

(2) $SV(a_d) = \{-d, -d+2, \dots, d-2, d\}$.

(3) $a_d(\mathbf{T}^d) = [-d, d]$.

(4) For $-d < a < d$, each connected component of $S_{a,reg}^{\mathbf{C}}(a_d)$ intersects with \mathbf{T}^d , and the intersection is a $(d-1)$ -dimensional real analytic submanifold of \mathbf{T}^d .

Proof. Since $\partial a_d / \partial z_j = -\sin z_j$, the assertions (1), (2) and (3) are easy to prove. Let $\mathbf{C}^* = \mathbf{C} \setminus \{(-\infty, -1] \cup [1, \infty)\}$, and recall that $\cos \zeta$ maps $\{0 < \operatorname{Re} \zeta < \pi\}$ conformally to \mathbf{C}^* . To prove (4), we take $z^{(0)} = (z_1^{(0)}, \dots, z_d^{(0)}) \in S_{a, \text{reg}}^{\mathbf{C}}(a_d)$ arbitrarily. Then, we can construct continuous curves $c_j^*(t)$, $(0 \leq t \leq 1)$, $j = 1, \dots, d-1$, such that $c_j^*(0) = \cos z_j^{(0)}$, $c_j^*(t) \in \mathbf{C}^*$ for $0 < t < 1$, and $c_j^*(1) \in (0, 1)$, moreover

$$c_d^*(t) := a - \sum_{j=1}^{d-1} c_j^*(t) \in \mathbf{C}^*, \quad 0 < t < 1.$$

Putting $c_j(t) = \arccos c_j^*(t)$ and $c(t) = (c_1(t), \dots, c_d(t))$ for $0 \leq t \leq 1$, we have $c(t) \in S_{a, \text{reg}}^{\mathbf{C}}(a_d)$ and $c(1) \in S_{a, \text{reg}}^{\mathbf{C}}(a_d) \cap \mathbf{T}^d$. This proves that $c(t)$ is the desired curve. \square

Lemma 2.2. (1) For $d = \text{even}$,

$$SV(b_d) = \left\{ \frac{(\ell+1)^2}{2} - \frac{d+1}{2}; \ell = -d, -d+2, \dots, d-2, d \right\} \cup \left\{ -\frac{d+1}{2} \right\},$$

and for $d = \text{odd}$,

$$SV(b_d) = \left\{ \frac{(\ell+1)^2}{2} - \frac{d+1}{2}; \ell = -d, -d+2, \dots, d-2, d \right\}.$$

(2) For $a \neq -(d+1)/2$, $S_{a, \text{sneg}}^{\mathbf{C}}(b_d) \subset (\pi \mathbf{Z})^d \cap \mathbf{T}^d$.

(3) For $a = -(d+1)/2$, $S_a^{\mathbf{C}}(b_d)$ is a union of analytic submanifolds of complex dimension $d-1$, $d-2$ and a discrete set. If the discrete set appears, it is in \mathbf{T}^d . In particular, $S_{-(d+1)/2}^{\mathbf{C}}(b_d) \cap \mathbf{T}^d$ is a union of real analytic submanifolds of real dimension $\leq d-2$.

(4) $b_d(\mathbf{T}^d) = [-(d+1)/2, d(d+1)/2]$.

(5) Assume that $-(d+1)/2 < a \leq d(d+1)/2$, and let

$$\begin{aligned} \tilde{S}_{a,j}(b_d) &= \{z \in S_a^{\mathbf{C}}(b_d); 1 + \sum_{k \neq j} e^{-iz_k} \neq 0\}, \quad 1 \leq j \leq d, \\ \tilde{S}_{a,0}(b_d) &= \{z \in S_a^{\mathbf{C}}(b_d); 1 + \sum_{k \neq j} e^{-iz_k} = 0, \quad \forall j\}. \end{aligned}$$

(i) For any $z^{(0)} \in \tilde{S}_{a,0}(b_d)$, there exist $j \neq 0$, $z^{(j)} \in \tilde{S}_{a,j}(b_d)$ and an $S_{a, \text{reg}}^{\mathbf{C}}(b_d)$ -valued continuous curve $c(t)$, $0 \leq t \leq 1$, such that $c(0) = z^{(0)}$ and $c(1) = z^{(j)}$.

(ii) For any $j \neq 0$, $\tilde{S}_{a,j}(b_d)$ is arcwise connected and $\tilde{S}_{a,j}(b_d) \cap \mathbf{T}^d \neq \emptyset$.

(6) For $-(d+1)/2 < a < d(d+1)/2$, each connected component of $S_{a, \text{reg}}^{\mathbf{C}}(b_d)$ intersects with \mathbf{T}^d , and the intersection is a $(d-1)$ -dimensional real analytic submanifold of \mathbf{T}^d .

Proof. Letting $f_d(z) = 1 + e^{iz_1} + \dots + e^{iz_d}$, we have the following factorization

$$(2.11) \quad b_d(z) + \frac{d+1}{2} = \frac{1}{2} f_d(z) f_d(-z).$$

Let us compute $S_{a, \text{sneg}}^{\mathbf{C}}(b_d)$. The above equation implies

$$\nabla_z b_d(z) = 0 \iff e^{iz_j} f_d(-z) = e^{-iz_j} f_d(z), \quad 1 \leq j \leq d.$$

Case 1 : $f_d(z) \neq 0$. In this case, $e^{2iz_1} = \dots = e^{2iz_d}$. Letting this value to be w^2 , we have $e^{iz_j} = \pm w$. Using $e^{2iz_j} f_d(-z) = f_d(z)$, we then have

$$w^2 \left(1 + \frac{\ell}{w}\right) = 1 + \ell w,$$

where ℓ is an integer satisfying $-d \leq \ell \leq d$. Therefore, $w = \pm 1 = \pm e^{iz_j}$, hence $z_j = 0$ or π . Since $1 + \sum_{j=1}^d e^{iz_j} \neq 0$, we have the restriction that $\#\{j; z_j = \pi\} \neq (d+1)/2$ when d is odd. Therefore, when d is even,

$$(2.12) \quad \begin{aligned} \cos z_1 + \dots + \cos z_d &= \ell, & \ell &= d, d-2, \dots, -d, \\ \sin z_1 + \dots + \sin z_d &= 0. \end{aligned}$$

Taking the square and adding them, we have $\sum_{i < j} \cos(z_i - z_j) = (\ell^2 - d)/2$. Hence,

$$\sum_{i=1}^d \cos z_i + \sum_{i < j} \cos(z_i - z_j) = \frac{(\ell+1)^2}{2} - \frac{d+1}{2}.$$

When d is odd, (2.12) also holds, however, $\ell \neq d - 2\frac{(d+1)}{2} = -1$.

Case 2 : $f_d(z) = 0$. In this case, in view of (2.11), $b_d(z) = -(d+1)/2$.

The assertions (1) and (2) now follow from the above observation.

When $a = -(d+1)/2$, by (2.11), $S_a^{\mathbf{C}}(b_d)$ is a union of two analytic manifolds $\{f_d(z) = 0\}$ and $\{f_d(-z) = 0\}$. If they intersect, we can assume without loss of generality that $f_{d-1}(-z') \neq 0$, $z' = (z_1, \dots, z_{d-1})$, at the intersection point. In fact, if $f_{d-1}(-z') = 0$ for all $d-1$ variables z' , adding them, we have $\sum_{j=1}^d e^{-iz_j} = d/(1-d)$, which is a contradiction.

Then we have $e^{-iz_d} = -f_{d-1}(-z')$, hence $f_{d-1}(z') - 1/f_{d-1}(-z') = 0$, which implies $b_{d-1}(z') = -d/2 + \frac{1}{2}f_{d-1}(z')f_{d-1}(-z') = -(d-1)/2$. By (2), z' is on an analytic submanifold of dimension $d-2$ or a discrete set. Therefore (z', z_d) form an analytic submanifold of dimension $d-2$ or a discrete set. This proves the assertion for $S_a^{\mathbf{C}}(b_d)$ of (3). The assertion for $S_a^{\mathbf{C}}(b_d) \cap \mathbf{T}^d$ is obtained by applying the implicit function theorem for $1 + \sum_{j=1}^d \cos x_j = -1$, $\sum_{j=1}^d \sin x_j = 0$.

By (1), the minimum of $b_d(x)$ on \mathbf{T}^d is $-(d+1)/2$. The maximum is easily seen to be $d(d+1)/2$. This proves (4).

Let us prove (i) of (5). Take $z^{(0)} = (z_1^{(0)}, \dots, z_d^{(0)}) \in \tilde{S}_{a,0}(b_d)$. Adding $1 + \sum_{k \neq j} e^{-iz_k^{(0)}} = 0$, we obtain $d + (d-1) \sum_{j=1}^d e^{-iz_j^{(0)}} = 0$, hence

$$e^{-iz_1^{(0)}} = \dots = e^{-iz_d^{(0)}} = \frac{1}{1-d}.$$

This implies $\cos z_j^{(0)} = (d^2 - 2d + 2)/(2(1-d))$, $\cos(z_i^{(0)} - z_j^{(0)}) = 1$. Therefore $b_d(z^{(0)}) = d/(2(1-d))$. Since the elements of $SV(b_d)$ are half-integers, we have $b_d(z^{(0)}) \notin SV(b_d)$, which implies $\nabla_z b_d(z^{(0)}) \neq 0$. Near $z^{(0)}$, $S_a^{\mathbf{C}}(b_d)$ is represented as, say, $z_d = g(z_1, \dots, z_{d-1})$, where g is analytic. Then one can find $z^{(d)} \in \tilde{S}_{a,d}(b_d)$ and a continuous curve in $S_{a,reg}^{\mathbf{C}}(b_d)$ with end points $z^{(0)}$ and $z^{(d)}$.

To prove (ii) for the case $j = d$, we let $w = e^{iz_d}$, and rewrite the equation $b_d(z) = a$ as

$$(2.13) \quad \left(1 + \sum_{j=1}^{d-1} e^{-iz_j}\right)w^2 + 2(A-a)w + \left(1 + \sum_{j=1}^{d-1} e^{iz_j}\right) = 0,$$

where $A = \sum_{j=1}^{d-1} \cos z_j + \sum_{1 \leq j < k \leq d-1} \cos(z_j - z_k) = b_{d-1}(z_1, \dots, z_{d-1})$. The discriminant D of (2.13) is given by

$$D/4 = A^2 - 2(a+1)A + a^2 - d.$$

Then $D = 0$ when $A = a + 1 \pm \sqrt{2a + d + 1}$.

A simple computation yields

$$\begin{aligned} -\frac{d-1}{2} < a + 1 + \sqrt{2a + d + 1} \leq -\frac{d}{2} + 2 & \text{ for } -\frac{d+1}{2} < a \leq -\frac{d}{2}, \\ -\frac{d}{2} < a + 1 - \sqrt{2a + d + 1} < \frac{d(d-1)}{2} & \text{ for } -\frac{d}{2} < a < \frac{d(d+1)}{2}. \end{aligned}$$

By (4), $b_{d-1}(x')$ ($x' \in \mathbf{T}^{d-1}$) varies over the interval $[-d/2, d(d-1)/2]$. Hence if $-(d+1)/2 < a \leq -d/2$, there exists $x' = (x_1, \dots, x_{d-1}) \in \mathbf{T}^{d-1}$ such that

$$b_{d-1}(x') = a + 1 + \sqrt{2a + d + 1},$$

and if $-d/2 < a < (d+1)d/2$, there exists $x' = (x_1, \dots, x_{d-1}) \in \mathbf{T}^{d-1}$ such that

$$b_{d-1}(x') = a + 1 - \sqrt{2a + d + 1}.$$

For such $x' = (x_1, \dots, x_{d-1})$, $1 + e^{-ix_1} + \dots + e^{-ix_{d-1}} \neq 0$. Otherwise, by (2.11) with d replaced by $d-1$, we have $b_{d-1}(x') = -d/2$. Therefore, we have either $a + 1 + \sqrt{2a + d + 1} = -d/2$ (for the case $-(d+1)/2 < a \leq -d/2$), or $a + 1 - \sqrt{2a + d + 1} = -d/2$ (for the case $-d/2 < a < d(d+1)/2$). Then we have $a + 1 + d/2 = \pm\sqrt{2a + d + 1}$. Hence $a + d/2 = 0$, which leads to a contradiction.

Then, the equation (2.13) has a double root $w \in \mathbf{C}$ such that $|w| = 1$. Therefore, $w = e^{ix_d}$ for some $x_d \in \mathbf{T}^1$, hence $x = (x_1, \dots, x_d) \in S_a^{\mathbf{C}}(b_d) \cap \mathbf{T}^d$.

Now, take $\zeta = (\zeta_1, \dots, \zeta_d) \in \tilde{S}_{a,d}(b_d)$ so that $1 + e^{-i\zeta_1} + \dots + e^{-i\zeta_{d-1}} \neq 0$. Construct continuous curves $c_j(t)$, $0 \leq t \leq 1$, $j = 1, \dots, d-1$, such that $c_j(t) \neq 0$, $1 + e^{-ic_1(t)} + \dots + e^{-ic_{d-1}(t)} \neq 0$ and $c_j(0) = e^{-i\zeta_j}$, $c_j(1) = e^{-ix_j}$. We can then construct a solution $w(t)$ of the equation (2.13) with z_j replaced by $c_j(t)$, continuous with respect to $t \in [0, 1]$, such that $w(0) = e^{i\zeta_d}$, $w(1) = e^{ix_d}$. Here, we use the fact that (2.13) has a double root for $t = 1$. This proves that there is a continuous curve in $\tilde{S}_{a,d}(b_d)$ with end points ζ and x , hence the assertion (ii).

We prove (6). Note that each connected component of $S_a^{\mathbf{C}}(b_d)$ is a union of $\tilde{S}_{a,j}(b_d)$, $j \neq 0$, and possibly a part of $\tilde{S}_{a,0}(b_d)$. Take $z^{(0)} \in S_a^{\mathbf{C}}(b_d)$. If $z^{(0)} \in \tilde{S}_{a,j}(b_d)$ for some $j \neq 0$, by (5 - ii), there is a continuous curve $c(t)$ such that $c(0) = z^{(0)}$ and $c(1) \in \tilde{S}_{a,j}(b_d) \cap \mathbf{T}^d$. If $z^{(0)} \in \tilde{S}_{a,0}(b_d)$, by (5 - i), one can find $\zeta \in \tilde{S}_{a,j}(b_d)$ and a continuous curve with end points $z^{(0)}$ and ζ . Then we can apply (5 - ii) again. Here, let us note that since $a \neq -(d+1)/2$, we can avoid the singular points by (2). \square

3. EXAMPLES OF PERIODIC LATTICES

We list up examples of periodic graphs, and study the algebraic properties of the matrix $H_0(x)$ associated with their Laplacians. We denote by $\sigma_p(H_0(x))$ the set of all eigenvalues of $H_0(x)$, including the case of $s = 1$, and let

$$(3.1) \quad \sigma(H_0) = \bigcup_{x \in \mathbf{T}^d} \sigma_p(H_0(x)),$$

$$(3.2) \quad p(x, \lambda) = \det(H_0(x) - \lambda),$$

$$(3.3) \quad M_\lambda = \{x \in \mathbf{T}^d; p(x, \lambda) = 0\},$$

$$(3.4) \quad M_\lambda^{\mathbf{C}} = \{z \in \mathbf{T}_{\mathbf{C}}^d; p(z, \lambda) = 0\}.$$

$$(3.5) \quad M_{\lambda, reg}^{\mathbf{C}} = \{z \in M_\lambda^{\mathbf{C}}; \nabla_z p(z, \lambda) \neq 0\}.$$

$$(3.6) \quad M_{\lambda, sing}^{\mathbf{C}} = \{z \in M_\lambda^{\mathbf{C}}; \nabla_z p(z, \lambda) = 0\}.$$

$$(3.7) \quad \tilde{\mathcal{T}} = \{\lambda \in \sigma(H_0); M_{\lambda, sing}^{\mathbf{C}} \cap \mathbf{T}^d \neq \emptyset\}.$$

In this section, we drop the subscript 0 from \mathcal{V}_0 and \mathcal{L}_0 for the notational convenience.

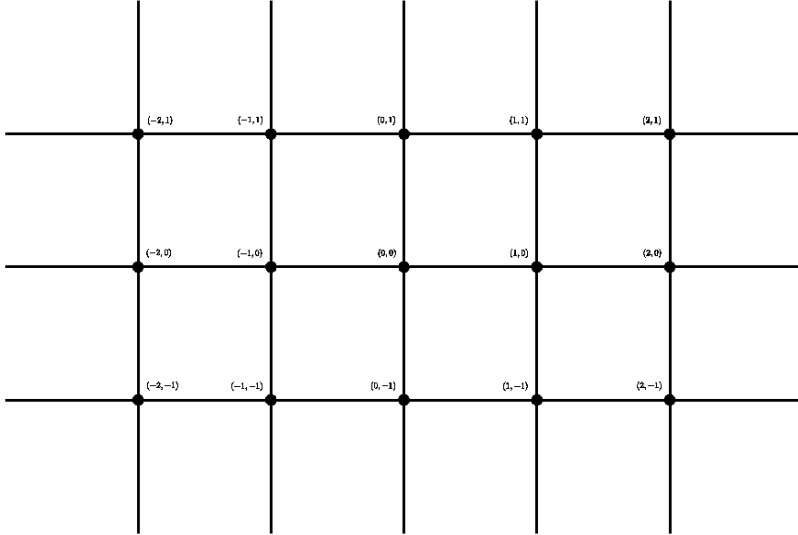

FIGURE 1. Square lattice

3.1. Square lattice. Let

$$\mathcal{V} = \{\mathbf{v}(n); n \in \mathbf{Z}^d\}, \quad \mathbf{v}_1 = (1, 0, \dots, 0), \dots, \mathbf{v}_d = (0, \dots, 0, 1).$$

$$\mathcal{N}_a = \{b \in \mathcal{V}; |b - a| = 1\} = \{a \pm \mathbf{v}_1, \dots, a \pm \mathbf{v}_d\}, \quad a \in \mathcal{V}.$$

Then, the Laplacian is defined by

$$(3.8) \quad (\widehat{\Delta}_\Gamma \widehat{f})(n) = \frac{1}{2d} \left(\sum_{i=1}^d \widehat{f}(n + \mathbf{v}_i) + \widehat{f}(n - \mathbf{v}_i) \right).$$

Passing to the Fourier series, this Laplacian is transformed into

$$(3.9) \quad H_0(x)f(x) = -\frac{1}{d} \left(\sum_{i=1}^d \cos x_i \right) f(x).$$

Therefore, $p(x, \lambda) = -\frac{1}{d} \sum_{j=1}^d \cos x_j - \lambda$, and Lemma 2.1 is rewritten as follows.

Lemma 3.1. (1) $\sigma(H_0) = [-1, 1]$.

(2) $\tilde{\mathcal{T}} = \{n/d; n = -d, -d+2, \dots, d-2, d\}$.

(3) For $\lambda \in (-1, 1) \setminus \tilde{\mathcal{T}}$, M_λ is a real analytic submanifold of \mathbf{T}^d , and $M_\lambda^{\mathbf{C}}$ is an analytic submanifold of $\mathbf{T}_{\mathbf{C}}^d$.

(4) For $-1 < \lambda < 1$, $M_{\lambda, \text{sneg}}^{\mathbf{C}} \subset (\pi\mathbf{Z})^d \cap \mathbf{T}_{\mathbf{C}}^d$.

(5) For $-1 < \lambda < 1$, each connected component of $M_{\lambda, \text{reg}}^{\mathbf{C}}$ intersects with \mathbf{T}^d and the intersection is a $(d-1)$ -dimensional real analytic submanifold of \mathbf{T}^d .

3.2. Triangular lattice. Let

$$\mathcal{V} = \{\mathbf{v}(n); n \in \mathbf{Z}^2\}, \quad \mathbf{v}_1 = (1, 0), \quad \mathbf{v}_2 = \left(\frac{1}{2}, \frac{\sqrt{3}}{2}\right),$$

$$\mathcal{N}_a = \{b \in \mathcal{V}; |b - a| = 1\} = \{a \pm \mathbf{v}_1, a \pm \mathbf{v}_2, a \pm (\mathbf{v}_1 - \mathbf{v}_2)\}, \quad a \in \mathcal{V}.$$

The Laplacian is defined by

$$(3.10) \quad \begin{aligned} (\widehat{\Delta}_\Gamma \widehat{f})(n) &= \frac{1}{6} (\widehat{f}(n_1 + 1, n_2) + \widehat{f}(n_1 - 1, n_2) + \widehat{f}(n_1, n_2 + 1) \\ &\quad + \widehat{f}(n_1, n_2 - 1) + \widehat{f}(n_1 + 1, n_2 - 1) + \widehat{f}(n_1 - 1, n_2 + 1)). \end{aligned}$$

Passing to the Fourier series, $-\widehat{\Delta}_\Gamma$ is rewritten as

$$(3.11) \quad H_0(x)f(x) = -\frac{1}{3} (\cos x_1 + \cos x_2 + \cos(x_1 - x_2))f(x).$$

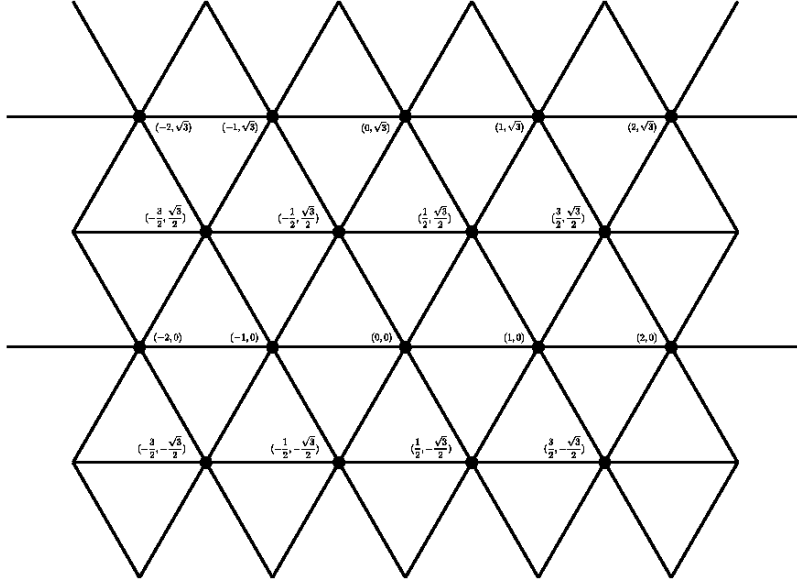

FIGURE 2. Triangular lattice

Then $p(x, \lambda) = -\frac{1}{3} (\cos x_1 + \cos x_2 + \cos(x_1 - x_2)) - \lambda$, and by Lemma 2.2, we have the following

Lemma 3.2. (1) $\sigma(H_0) = [-1, 1/2]$.

(2) $\tilde{\mathcal{T}} = \{-1, 1/3, 1/2\}$.

(3) For $\lambda \in (-1, 1/2) \setminus \tilde{\mathcal{T}}$, M_λ is a real analytic submanifold of \mathbf{T}^2 , and $M_\lambda^{\mathbf{C}}$ is an analytic submanifold of $\mathbf{T}_{\mathbf{C}}^2$.

(4) For $-1 < \lambda < 1/2$, $M_{\lambda, \text{sneg}}^{\mathbf{C}} \subset (\pi\mathbf{Z})^2 \cap \mathbf{T}_{\mathbf{C}}^2$.

(5) For $-1 < \lambda < 1/2$, each connected components of $M_{\lambda, \text{reg}}^{\mathbf{C}}$ intersects with \mathbf{T}^2 and the intersection is a 1-dimensional real analytic submanifold of \mathbf{T}^2 .

3.3. Hexagonal lattice. We put

$$(3.12) \quad \mathcal{L} = \{\mathbf{v}(n); n \in \mathbf{Z}^2\}, \quad \mathbf{v}_1 = \left(\frac{3}{2}, \frac{\sqrt{3}}{2}\right), \quad \mathbf{v}_2 = (0, \sqrt{3}),$$

$$(3.13) \quad p_1 = \left(\frac{1}{2}, -\frac{\sqrt{3}}{2}\right), \quad p_2 = (1, 0),$$

and define the vertex set \mathcal{V} by

$$(3.14) \quad \mathcal{V} = \mathcal{V}_1 \cup \mathcal{V}_2, \quad \mathcal{V}_i = p_i + \mathcal{L}.$$

Note that $\mathcal{V}_1 \cap \mathcal{V}_2 = \emptyset$. The adjacent points of $a_1 \in \mathcal{V}_1$ and $a_2 \in \mathcal{V}_2$ are defined by

$$(3.15) \quad \begin{aligned} \mathcal{N}_{a_1} &= \{y \in \mathbf{R}^2; |a_1 - y| = 1\} \cap \mathcal{V}_2 \\ &= \left\{ a_1 + \frac{\mathbf{v}_1 + \mathbf{v}_2}{3}, a_1 + \frac{\mathbf{v}_1 - 2\mathbf{v}_2}{3}, a_1 - \frac{2\mathbf{v}_1 - \mathbf{v}_2}{3} \right\}, \end{aligned}$$

$$(3.16) \quad \begin{aligned} \mathcal{N}_{a_2} &= \{y \in \mathbf{R}^2; |a_2 - y| = 1\} \cap \mathcal{V}_1 \\ &= \left\{ a_2 + \frac{2\mathbf{v}_1 - \mathbf{v}_2}{3}, a_2 - \frac{\mathbf{v}_1 - 2\mathbf{v}_2}{3}, a_2 - \frac{\mathbf{v}_1 + \mathbf{v}_2}{3} \right\}. \end{aligned}$$

For a function $\hat{f}(n) = (\hat{f}_1(n), \hat{f}_2(n))$, the Laplacian is defined by

$$(3.17) \quad (\hat{\Delta}_\Gamma \hat{f})(n) = \frac{1}{3} \begin{pmatrix} \hat{f}_2(n_1, n_2) + \hat{f}_2(n_1 - 1, n_2) + \hat{f}_2(n_1, n_2 - 1) \\ \hat{f}_1(n_1, n_2) + \hat{f}_1(n_1 + 1, n_2) + \hat{f}_1(n_1, n_2 + 1) \end{pmatrix}$$

Passing to the Fourier series, $-\hat{\Delta}_\Gamma$ is transformed to

$$(3.18) \quad H_0(x) = -\frac{1}{3} \begin{pmatrix} 0 & 1 + e^{ix_1} + e^{ix_2} \\ 1 + e^{-ix_1} + e^{-ix_2} & 0 \end{pmatrix}.$$

A direct computation yields

$$(3.19) \quad p(x, \lambda) = \det(H_0(x) - \lambda) = \lambda^2 - \frac{\alpha(x)}{9}.$$

$$(3.20) \quad \alpha(x) = 3 + 2(\cos x_1 + \cos x_2 + \cos(x_1 - x_2)).$$

Lemma 2.2 implies the following

Lemma 3.3. (1) $\sigma(H_0) = [-1, 1]$.

(2) $\tilde{\mathcal{T}} = \{-1, -1/3, 0, 1/3, 1\}$.

(3) For $\lambda \in (-1, 1) \setminus \tilde{\mathcal{T}}$, M_λ is a real analytic submanifold of \mathbf{T}^2 and $M_\lambda^{\mathbf{C}}$ is an analytic submanifold of $\mathbf{T}_{\mathbf{C}}^2$.

(4) For $-1 < \lambda < 0$ and $0 < \lambda < 1$, $M_{\lambda, \text{sneg}}^{\mathbf{C}} \subset (\pi\mathbf{Z})^2 \cap \mathbf{T}_{\mathbf{C}}^2$.

(5) For $-1 < \lambda < 0$ and $0 < \lambda < 1$, each connected component of $M_\lambda^{\mathbf{C}}$ intersects with \mathbf{T}^2 and the intersection is a 1-dimensional real analytic submanifold of \mathbf{T}^2 .

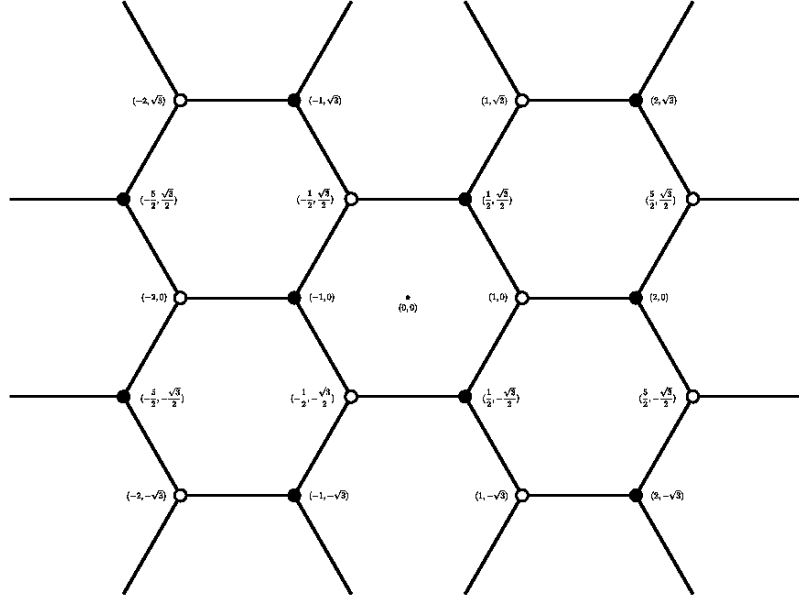

FIGURE 3. Hexagonal lattice

3.4. **Kagome lattice.** Let

$$\mathcal{L} = \{\mathbf{v}(n); n \in \mathbf{Z}^2\}, \quad \mathbf{v}_1 = \left(\frac{1}{2}, \frac{\sqrt{3}}{2}\right), \quad \mathbf{v}_2 = \left(-\frac{1}{2}, \frac{\sqrt{3}}{2}\right),$$

$$p_1 = (0, 0), \quad p_2 = \left(\frac{1}{2}, 0\right), \quad p_3 = \left(\frac{1}{4}, \frac{\sqrt{3}}{4}\right).$$

$$\mathcal{V} = \mathcal{V}_1 \cup \mathcal{V}_2 \cup \mathcal{V}_3, \quad \mathcal{V}_j = p_j + \mathcal{L}.$$

For $a_j \in \mathcal{V}_j$, the adjacent points are

$$\mathcal{N}_{a_j} = \{y \in \mathcal{V}; |a_j - y| = 1/2, y \notin \mathcal{V}_j\},$$

i.e.

$$(3.21) \quad \begin{aligned} \mathcal{N}_{a_1} &= \left\{a_1 \pm \frac{\mathbf{v}_1}{2}, a_1 \pm \frac{\mathbf{v}_1 - \mathbf{v}_2}{2}\right\}, \\ \mathcal{N}_{a_2} &= \left\{a_2 \pm \frac{\mathbf{v}_2}{2}, a_2 \pm \frac{\mathbf{v}_1 - \mathbf{v}_2}{2}\right\}, \\ \mathcal{N}_{a_3} &= \left\{a_3 \pm \frac{\mathbf{v}_1}{2}, a_3 \pm \frac{\mathbf{v}_2}{2}\right\}. \end{aligned}$$

For a function $\widehat{f}(n) = (\widehat{f}_1(n), \widehat{f}_2(n), \widehat{f}_3(n))$, the Laplacian is defined by

$$(3.22) \quad \begin{aligned} (\widehat{\Delta}_\Gamma \widehat{f})(n) &= \frac{1}{4}(\widehat{g}_1(n), \widehat{g}_2(n), \widehat{g}_3(n)), \\ \widehat{g}_1(n) &= \widehat{f}_2(n) + \widehat{f}_2(n_1 - 1, n_2 + 1) + \widehat{f}_3(n) + \widehat{f}_3(n_1 - 1, n_2), \\ \widehat{g}_2(n) &= \widehat{f}_1(n) + \widehat{f}_1(n_1 + 1, n_2 - 1) + \widehat{f}_3(n) + \widehat{f}_3(n_1, n_2 - 1), \\ \widehat{g}_3(n) &= \widehat{f}_1(n) + \widehat{f}_1(n_1 + 1, n_2) + \widehat{f}_2(n) + \widehat{f}_2(n_1, n_2 + 1). \end{aligned}$$

Passing to the Fourier series, $-\widehat{\Delta}_\Gamma$ becomes

$$(3.23) \quad H_0(x) = -\frac{1}{4} \begin{pmatrix} 0 & 1 + e^{ix_1} e^{-ix_2} & 1 + e^{ix_1} \\ 1 + e^{-ix_1} e^{ix_2} & 0 & 1 + e^{ix_2} \\ 1 + e^{-ix_1} & 1 + e^{-ix_2} & 0 \end{pmatrix}.$$

A direct computation gives

$$(3.24) \quad p(x, \lambda) = \det(H_0(x) - \lambda) = -\left(\lambda - \frac{1}{2}\right) \left(\lambda^2 + \frac{\lambda}{2} - \frac{\beta(x)}{8}\right),$$

$$(3.25) \quad \beta(x) = 1 + \cos x_1 + \cos x_2 + \cos(x_1 - x_2).$$

Note that the case $\lambda = 1/2$ is exceptional in that $p(x, 1/2) = 0$. Lemma 2.2 and a direct computation imply the following

Lemma 3.4. (1) $\sigma(H_0) = [-1, 1/2]$.

(2) $\widetilde{\mathcal{T}} = \{-1, -1/2, -1/4, 0, 1/2\}$.

(3) For $(-1, 1/2) \setminus \widetilde{\mathcal{T}}$, M_λ is a real analytic submanifold of \mathbf{T}^2 and $M_\lambda^{\mathbf{C}}$ is an analytic submanifold of $\mathbf{T}_{\mathbf{C}}^2$.

(4) For $-1 < \lambda < -1/4$ and $-1/4 < \lambda < 1/2$, $M_{\lambda, \text{sing}}^{\mathbf{C}} \subset (\pi\mathbf{Z})^2 \cap \mathbf{T}_{\mathbf{C}}^2$.

(5) For $-1 < \lambda < -1/4$ and $-1/4 < \lambda < 1/2$, each connected component of $M_\lambda^{\mathbf{C}}$ intersects with \mathbf{T}^2 and the intersection is a 1-dimensional real analytic submanifold of \mathbf{T}^2 .

(6) $H_0(x)$ has an eigenvalue $1/2$ with eigenvector $s(x)v(x)$, where $s(x)$ is an arbitrarily scalar function on \mathbf{T}^2 and

$$v(x) = \left(-\frac{1}{2}(1 - e^{ix_1})(1 - e^{-ix_2}), 1 - \cos x_1, -\frac{1}{2}(1 - e^{ix_1})(1 + e^{-ix_2})\right).$$

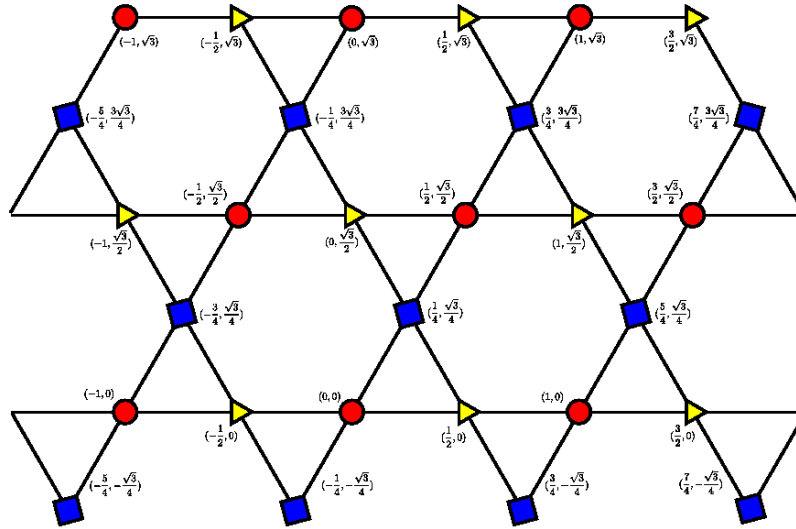

FIGURE 4. Kagome lattice

3.5. Diamond lattice. We put

$$(3.26) \quad \mathcal{V}_1 = \{\ell = (\ell_1, \ell_2, \ell_3) \in \mathbf{Z}^3; \ell_1 + \ell_2 + \ell_3 \in 2\mathbf{Z}\},$$

$$(3.27) \quad \mathcal{V}_2 = p + \mathcal{V}_1, \quad p = \left(\frac{1}{2}, \frac{1}{2}, \frac{1}{2}\right).$$

$$(3.28) \quad \mathcal{V} = \mathcal{V}_1 \cup \mathcal{V}_2.$$

We want to define the adjacent points of $a \in \mathcal{V}$ as the nearest neighboring points. For this purpose, we prepare the following lemma.

Lemma 3.5. *For $\ell \in \mathcal{V}_1, p + \ell' \in \mathcal{V}_2$, we have $|\ell - \ell'| \geq \sqrt{3}/2$ and $|\ell - (\ell' + p)| = \sqrt{3}/2$ if and only if*

$$\ell - \ell' = (0, 0, 0), \text{ or } (0, 1, 1), \text{ or } (1, 0, 1), \text{ or } (1, 1, 0).$$

Proof. Let $a = \ell - \ell'$ and ρ be the distance of \mathcal{V}_1 and \mathcal{V}_2 . Then we have

$$(3.29) \quad a_1^2 - a_1 + a_2^2 - a_2 + a_3^2 - a_3 \geq \rho^2 - 3/4.$$

For $m \in \mathbf{Z}$, $m^2 \geq m$, and $m^2 = m$ if and only if $m = 0, 1$. Therefore, the left-hand side of (3.29) is non-negative, and vanishes for $a_1, a_2, a_3 = 0$ or 1 . The solutions $(1, 0, 0), (0, 1, 0), (0, 0, 1), (1, 1, 1)$ do not satisfy the condition $a_1 + a_2 + a_3 \in 2\mathbf{Z}$. On the other hand, $a = (0, 0, 0), (0, 1, 1), (1, 0, 1), (1, 1, 0)$ meet the condition. This means that $\rho = \sqrt{3}/2$, and the equality of (3.29) is attained by these values. \square

By this lemma, the adjacent points of $a \in \mathcal{V}_1$ are

$$p + a, \quad p + (a_1, a_2 - 1, a_3 - 1), \quad p + (a_1 - 1, a_2, a_3 - 1), \quad p + (a_1 - 1, a_2 - 1, a_3),$$

and the adjacent points of $a' + p \in \mathcal{V}_2$ are

$$a', \quad (a'_1, a'_2 + 1, a'_3 + 1), \quad (a'_1 + 1, a'_2, a'_3 + 1), \quad (a'_1 + 1, a'_2 + 1, a'_3).$$

Lemma 3.6. *The vectors $\mathbf{v}_1 = (0, 1, 1)$, $\mathbf{v}_2 = (1, 0, 1)$, $\mathbf{v}_3 = (1, 1, 0)$ form a basis of the lattice \mathcal{V}_1 .*

Proof. We put

$$(3.30) \quad n_1 = \frac{-\ell_1 + \ell_2 + \ell_3}{2}, \quad n_2 = \frac{\ell_1 - \ell_2 + \ell_3}{2}, \quad n_3 = \frac{\ell_1 + \ell_2 - \ell_3}{2}.$$

Then, one can see that

$$\ell \in \mathbf{Z}^3, \ell_1 + \ell_2 + \ell_3 \in 2\mathbf{Z} \iff n \in \mathbf{Z}^3.$$

We also have $n_1\mathbf{v}_1 + n_2\mathbf{v}_2 + n_3\mathbf{v}_3 = \ell$. Therefore $\mathcal{V}_1 = \{n_1\mathbf{v}_1 + n_2\mathbf{v}_2 + n_3\mathbf{v}_3; n \in \mathbf{Z}^3\}$. \square

In view of Lemma 3.6, we have, letting $\mathcal{L} = \{\mathbf{v}(n); n \in \mathbf{Z}^3\}$,

$$\mathcal{V}_1 = \mathcal{L}, \quad \mathcal{V}_2 = p + \mathcal{L}, \quad p = \frac{\mathbf{v}_1 + \mathbf{v}_2 + \mathbf{v}_3}{4}.$$

The edge set is rewritten as follows : \mathcal{N} is the set of points $(\mathbf{v}(n), p + \mathbf{v}(n'))$, $(p + \mathbf{v}(n'), \mathbf{v}(n))$ with n, n' satisfying

$$n - n' = (0, 0, 0), (1, 0, 0), (0, 1, 0), (0, 0, 1).$$

The Laplacian is defined by

$$(3.31) \quad (\widehat{\Delta}_\Gamma \widehat{f})(n) = \frac{1}{4}(\widehat{g}_1, \widehat{g}_2),$$

$$\begin{aligned}
 \widehat{g}_1(n) &= \widehat{f}_2(n) + \widehat{f}_2(n_1 - 1, n_2, n_3) \\
 &\quad + \widehat{f}_2(n_1, n_2 - 1, n_3) + \widehat{f}_2(n_1, n_2, n_3 - 1), \\
 \widehat{g}_2(n) &= \widehat{f}_1(n) + \widehat{f}_1(n_1 + 1, n_2, n_3) \\
 &\quad + \widehat{f}_1(n_1, n_2 + 1, n_3) + \widehat{f}_1(n_1, n_2, n_3 + 1).
 \end{aligned}
 \tag{3.32}$$

Passing to the Fourier series, $-\widehat{\Delta}_\Gamma$ becomes

$$H_0(x) = -\frac{1}{4} \begin{pmatrix} 0 & 1 + e^{ix_1} + e^{ix_2} + e^{ix_3} \\ 1 + e^{-ix_1} + e^{-ix_2} + e^{-ix_3} & 0 \end{pmatrix}.
 \tag{3.33}$$

We then have

$$p(x, \lambda) = \det(H_0(x) - \lambda) = \lambda^2 - \gamma_3(x),
 \tag{3.34}$$

$$\begin{aligned}
 \gamma_3(x) &= \frac{1}{4} + \frac{1}{8} (\cos x_1 + \cos x_2 + \cos x_3 \\
 &\quad + \cos(x_1 - x_2) + \cos(x_2 - x_3) + \cos(x_3 - x_1)).
 \end{aligned}
 \tag{3.35}$$

Lemma 2.2 implies the following

Lemma 3.7. (1) $\sigma(H_0) = [-1, 1]$.

(2) $\widetilde{\mathcal{T}} = \{-1, -1/2, 0, 1/2, 1\}$.

(3) For $\lambda \in (-1, 1) \setminus \widetilde{\mathcal{T}}$, M_λ is a real analytic submanifold of \mathbf{T}^3 and $M_\lambda^{\mathbf{C}}$ is an analytic submanifold of $\mathbf{T}_{\mathbf{C}}^3$.

(4) For $-1 < \lambda < 0$ and $0 < \lambda < 1$, $M_{\lambda, \text{sn}g}^{\mathbf{C}} \subset (\pi\mathbf{Z})^3 \cap \mathbf{T}_{\mathbf{C}}^3$.

(5) For $-1 < \lambda < 0$ and $0 < \lambda < 1$, each connected component of $M_\lambda^{\mathbf{C}}$ intersects with \mathbf{T}^3 and the intersection is a 2-dimensional analytic submanifold of \mathbf{T}^3 .

3.6. Higher-dimensional diamond lattice. There is a higher-dimensional analogue of diamond lattice. In fact, the hexagonal lattice and the 3-dimensional diamond lattice are just the cases for $d = 2$ and $d = 3$ of the lattice A_d defined as follows.

$$A_d = \left\{ x = (x_1, \dots, x_{d+1}) \in \mathbf{Z}^{d+1}; \sum_{i=1}^{d+1} x_i = 0 \right\}.
 \tag{3.36}$$

Let $e_1 = (1, 0, \dots, 0), \dots, e_{d+1} = (0, \dots, 0, 1)$ be the standard basis of \mathbf{R}^{d+1} , and put

$$\mathbf{v}_i = e_{d+1} - e_i, \quad i = 1, \dots, d.$$

They satisfy

$$\begin{aligned}
 |\mathbf{v}_i|^2 &= 2, \quad i = 1, \dots, d, \\
 \mathbf{v}_i \cdot \mathbf{v}_j &= 1, \quad |\mathbf{v}_i - \mathbf{v}_j|^2 = 2, \quad \text{if } i \neq j.
 \end{aligned}
 \tag{3.37}$$

Lemma 3.8. Let $\mathbf{v}(n) = \sum_{i=1}^d n_i \mathbf{v}_i$, $n \in \mathbf{Z}^d$. Then $A_d = \{\mathbf{v}(n); n \in \mathbf{Z}^d\}$, and $\{\mathbf{v}_i\}_{i=1}^d$ is a basis of A_d .

Proof. We have an equivalent relation

$$(x_1, \dots, x_{d+1}) = \sum_{i=1}^d y_i \mathbf{v}_i \iff x_i = -y_i, \quad i = 1, \dots, d, \quad x_{d+1} = \sum_{i=1}^d y_i.
 \tag{3.38}$$

From this, the lemma follows immediately. \square

We put

$$(3.39) \quad \mathcal{V} = A_d \cup (p + A_d), \quad p = \frac{1}{d+1}(\mathbf{v}_1 + \cdots + \mathbf{v}_d).$$

This is the vertex set of d -dim. diamond lattice.

Lemma 3.9. *For $\mathbf{v}(n), \mathbf{v}(n') \in A_d$, $|\mathbf{v}(n) - (\mathbf{v}(n') + p)| \geq \sqrt{d/(d+1)}$, and the equality occurs if and only if*

$$n - n' = (0, \dots, 0), (1, 0, \dots, 0), \dots, (0, \dots, 0, 1).$$

Proof. We put $a = \mathbf{v}(n) - \mathbf{v}(n')$. Then

$$a - p = \left(a_1 + \frac{1}{d+1}, \dots, a_d + \frac{1}{d+1}, -\sum_{i=1}^d a_i - \frac{d}{d+1} \right).$$

Then we have

$$|a - p|^2 = \sum_{i=1}^d a_i^2 - 1 + \left(\sum_{i=1}^d a_i + 1 \right)^2 + \frac{d}{d+1}.$$

This is always greater than or equal to $d/(d+1)$, and the equality occurs if and only if all $a_i = 0$, or one of $a_i = -1$ and the others vanish. Taking into account of (3.38), we obtain the lemma. \square

Therefore, for $\mathbf{v}(n) \in A_d$, we define its adjacent points by

$$\mathcal{N}_{\mathbf{v}(n)} = \left\{ p + \mathbf{v}(n'); n - n' = (0, \dots, 0), \right. \\ \left. (1, 0, \dots, 0), \dots, (0, \dots, 0, 1) \right\},$$

and for $p + \mathbf{v}(n') \in p + A_d$,

$$\mathcal{N}_{p+\mathbf{v}(n')} = \left\{ \mathbf{v}(n); n - n' = (0, \dots, 0), \right. \\ \left. (1, 0, \dots, 0), \dots, (0, \dots, 0, 1) \right\}.$$

The Laplacian is defined by

$$(3.40) \quad (\widehat{\Delta}_\Gamma \widehat{f})(n) = \frac{1}{d+1}(\widehat{g}_1(n), \widehat{g}_2(n)),$$

$$(3.41) \quad \widehat{g}_1(n) = \widehat{f}_2(n) + \widehat{f}_2(n - \mathbf{e}_1) + \cdots + \widehat{f}_2(n - \mathbf{e}_d),$$

$$(3.42) \quad \widehat{g}_2(n) = \widehat{f}_1(n) + \widehat{f}_1(n + \mathbf{e}_1) + \cdots + \widehat{f}_1(n + \mathbf{e}_d),$$

where $\{\mathbf{e}_i\}_{i=1}^d$ is the standard basis of \mathbf{R}^d . Passing to the Fourier series, $-\widehat{\Delta}_\Gamma$ is transformed to

$$(3.43) \quad H_0(x) = -\frac{1}{d+1} \begin{pmatrix} 0 & 1 + e^{ix_1} + \cdots + e^{ix_d} \\ 1 + e^{-ix_1} + \cdots + e^{-ix_d} & 0 \end{pmatrix}.$$

We have

$$(3.44) \quad p(x, \lambda) = \det(H_0(x) - \lambda) = \lambda^2 - \gamma_d(x),$$

$$(3.45) \quad \gamma_d(x) = \frac{1}{d+1} + \frac{2}{(d+1)^2} \left(\sum_{i=1}^d \cos x_i + \sum_{i < j} \cos(x_i - x_j) \right).$$

Lemma 2.2 implies the following

Lemma 3.10. (1) $\sigma(H_0) = [-1, 1]$.

(2)

$$\tilde{\mathcal{T}} = \begin{cases} \left\{ \pm \frac{\ell+1}{d+1}; \ell = d, d-2, \dots, -d \right\} \cup \{0\}, & \text{if } d = \text{even}, \\ \left\{ \pm \frac{\ell+1}{d+1}; \ell = d, d-2, \dots, -d \right\}, & \text{if } d = \text{odd}. \end{cases}$$

(3) For $(-1, 1) \setminus \tilde{\mathcal{T}}$, M_λ is a real analytic submanifold of \mathbf{T}^d and $M_\lambda^{\mathbf{C}}$ is an analytic submanifold of $\mathbf{T}_{\mathbf{C}}^d$.

(4) For $-1 < \lambda < 0$ and $0 < \lambda < 1$, $M_{\lambda, \text{sneg}}^{\mathbf{C}} \subset (\pi\mathbf{Z})^d \cap \mathbf{T}_{\mathbf{C}}^d$.

(5) For $-1 < \lambda < 0$ and $0 < \lambda < 1$, each connected component of $M_\lambda^{\mathbf{C}}$ intersects with \mathbf{T}^d and the intersection is a $(d-1)$ -dimensional real analytic submanifold of \mathbf{T}^d .

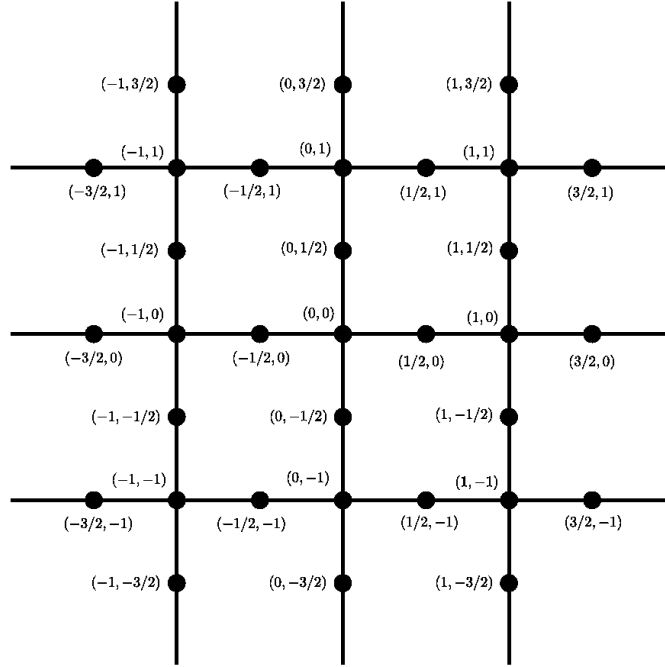

FIGURE 5. Subdivision of 2-dimensional square lattice

3.7. Subdivision of d -dimensional Square Lattice \mathbf{Z}^d , $d \geq 2$. The next example is obtained by adding new vertices in the middle points of the edges of the square lattice \mathbf{Z}^d . Let us put

$$(3.46) \quad \mathbf{v}_1 = (1, 0, \dots, 0), \dots, \mathbf{v}_d = (0, \dots, 0, 1),$$

$$(3.47) \quad p_1 = (0, \dots, 0), p_2 = (1/2, 0, \dots, 0), \dots, p_{d+1} = (0, \dots, 0, 1/2),$$

$$(3.48) \quad \mathcal{L} = \{\mathbf{v}(n); n \in \mathbf{Z}^d\},$$

$$(3.49) \quad \mathcal{V} = \bigcup_{j=1}^{d+1} \mathcal{V}_j, \quad \mathcal{V}_j = p_j + \mathcal{L}.$$

The edge relations are defined by

$$(3.50) \quad \mathcal{N}_{a_j} = \{y \in \mathcal{V}; |y - a_j| = 1/2\}, \quad a_j \in \mathcal{V}_j.$$

Then $a_1 \in \mathcal{V}_1$ has $2d$ adjacent points, while $a_j \in \mathcal{V}_j$, $j = 2, \dots, d+1$, have 2 adjacent points. The Laplacian is then defined by

$$(3.51) \quad (\widehat{\Delta}_\Gamma \widehat{f})(n) = \frac{1}{2} \begin{pmatrix} \frac{1}{d} \sum_{j=1}^d (\widehat{f}_{j+1}(n) + \widehat{f}_{j+1}(n - \mathbf{e}_j)) \\ \widehat{f}_1(n) + \widehat{f}_1(n + \mathbf{e}_1) \\ \vdots \\ \widehat{f}_1(n) + \widehat{f}_1(n + \mathbf{e}_d) \end{pmatrix}.$$

Passing to the Fourier series, $-\widehat{\Delta}_\Gamma$ becomes the following matrix

$$(3.52) \quad H_0(x) = -\frac{1}{2\sqrt{d}} \begin{pmatrix} 0 & 1 + e^{ix_1} & \dots & 1 + e^{ix_d} \\ 1 + e^{-ix_1} & 0 & \dots & 0 \\ \vdots & \vdots & \ddots & \vdots \\ 1 + e^{-ix_d} & 0 & \dots & 0 \end{pmatrix},$$

whose determinant is computed as

$$(3.53) \quad p(x, \lambda) = \det(H_0(x) - \lambda) = (-\lambda)^{d-1} \left(\lambda^2 - \frac{1}{2d} \left(d + \sum_{j=1}^d \cos x_j \right) \right).$$

Similarly to the case of Kagome lattice, the case $\lambda = 0$ is exceptional since $p(x, 0) = 0$. Lemma 2.1 and a direct computation imply the following

Lemma 3.11. (1) $\sigma(H_0) = [-1, 1]$.

(2) $\widetilde{\mathcal{T}} = \{0, \pm\sqrt{n/2d}; n = 1, 2, \dots, 2d\}$.

(3) For $\lambda \in (-1, 1) \setminus \widetilde{\mathcal{T}}$, M_λ is a real analytic submanifold of \mathbf{T}^d and $M_\lambda^{\mathbf{C}}$ is an analytic submanifold of $\mathbf{T}_{\mathbf{C}}^d$.

(4) For $-1 < \lambda < 0$, $0 < \lambda < 1$, $M_{\lambda, \text{sing}}^{\mathbf{C}} \subset (\pi\mathbf{Z})^d \cap \mathbf{T}_{\mathbf{C}}^d$.

(5) For $-1 < \lambda < 0$, $0 < \lambda < 1$, $M_{\lambda, \text{reg}}^{\mathbf{C}}$ intersects with \mathbf{T}^d and the intersection is a $d-1$ -dimensional real analytic submanifold of \mathbf{T}^d .

(5) $H_0(x)$ has an eigenvalue 0, whose eigenvector is written as

$$\sum_{j=1}^{d-1} s_j(x) v_j(x),$$

where $s_1(x), \dots, s_{d-1}(x)$ are arbitrary scalar functions and

$$\begin{aligned} v_1(x) &= (0, -(1 + e^{ix_2}), 1 + e^{ix_1}, 0, \dots, 0), \\ v_2(x) &= (0, -(1 + e^{ix_3}), 0, 1 + e^{ix_1}, \dots, 0), \\ &\dots \\ v_{d-1}(x) &= (0, -(1 + e^{ix_d}), 0, 0, \dots, 1 + e^{ix_1}). \end{aligned}$$

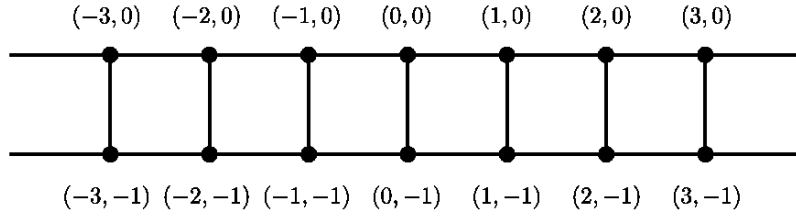

FIGURE 6. 2-dim. ladder

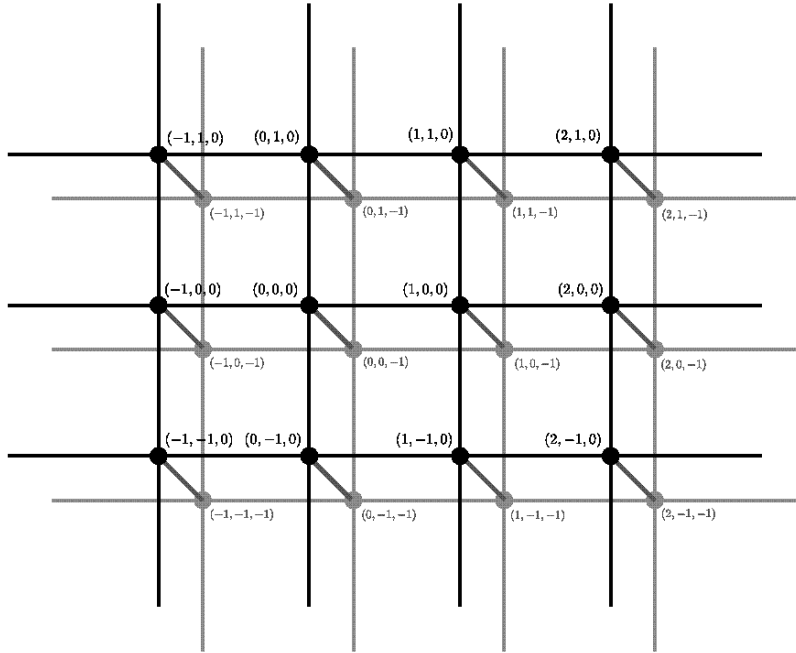

FIGURE 7. 3-dim. ladder

3.8. Ladder of d -dimensional Square Lattice in \mathbf{R}^{d+1} . The term “ladder” is named after the shape of the following graph ($d = 1$):

The d -dimensional ladder is defined as follows. Let \mathcal{L}_d be the standard d -dim. square lattice realized in \mathbf{R}^{d+1} , i.e. $\mathcal{L}_d = \{(n_1, \dots, n_d, 0); n_i \in \mathbf{Z}\}$, and put

$$(3.54) \quad \begin{aligned} \mathcal{V}_1 &= \mathcal{L}_d, & \mathcal{V}_2 &= (0, \dots, 0, -1) + \mathcal{L}_d, \\ p_0 &= (0, \dots, 0), & p_1 &= (0, \dots, 0, -1), \end{aligned}$$

$$(3.55) \quad \mathcal{V} = \mathcal{V}_1 \cup \mathcal{V}_2, \quad \mathcal{V}_i = p_i + \mathcal{L}_d.$$

The adjacent relation is defined by

$$(3.56) \quad \mathcal{N}_a = \{y \in \mathcal{V}; |y - a| = 1\}, \quad a \in \mathcal{V}.$$

Then the Laplacian is

$$(3.57) \quad (\widehat{\Delta}_\Gamma \widehat{f})(n) = \frac{1}{2d+1} \begin{pmatrix} \widehat{f}_2(n) + \sum_{j=1}^d (\widehat{f}_1(n + \mathbf{e}_j) + \widehat{f}_1(n - \mathbf{e}_j)) \\ \widehat{f}_1(n) + \sum_{j=1}^d (\widehat{f}_2(n + \mathbf{e}_j) + \widehat{f}_2(n - \mathbf{e}_j)) \end{pmatrix}.$$

Passing to the Fourier series, $-\widehat{\Delta}_\Gamma$ is transformed to

$$(3.58) \quad H_0(x) = -\frac{1}{2d+1} \begin{pmatrix} 2 \sum_{j=1}^d \cos x_j & 1 \\ 1 & 2 \sum_{j=1}^d \cos x_j \end{pmatrix}.$$

Then we have

$$p(x, \lambda) = \det(H_0(x) - \lambda) = p_+(x, \lambda)p_-(x, \lambda),$$

$$p_\pm(x, \lambda) = \lambda + \frac{1}{2d+1} \left(2 \sum_{j=1}^d \cos x_j \pm 1 \right).$$

Then, $H_0(x)$ has two distinct eigenvalues $\lambda_\pm(x) = (-2 \sum_{j=1}^d \cos x_j \pm 1)/(2d+1)$ with values

$$-1 \leq \lambda_-(x) \leq \frac{2d-1}{2d+1}, \quad \frac{-2d+1}{2d+1} \leq \lambda_+(x) \leq 1.$$

Accordingly, $M_\lambda^{\mathbf{C}}$ is split into 2 parts :

$$M_\lambda^{\mathbf{C}} = M_{\lambda,+}^{\mathbf{C}} \cup M_{\lambda,-}^{\mathbf{C}}, \quad M_{\lambda,\pm}^{\mathbf{C}} = \{z \in \mathbf{T}_{\mathbf{C}}^d; p_\pm(z, \lambda) = 0\}.$$

We put

$$(3.59) \quad \mathcal{T}_\pm = \{\lambda; p_\pm(x, \lambda) = 0, \nabla p_\pm(x, \lambda) = 0 \text{ for some } x \in \mathbf{T}^d\},$$

which is equal to

$$\begin{aligned} \widetilde{\mathcal{T}}_+ &= \left\{ \frac{-2d+1}{2d+1}, \frac{-2d+5}{2d+1}, \dots, 1 \right\}, \\ \widetilde{\mathcal{T}}_- &= \left\{ -1, \frac{-2d+3}{2d+1}, \dots, \frac{2d-1}{2d+1} \right\}. \end{aligned}$$

In view of Lemma 2.1, we have the following

Lemma 3.12. (1) $\sigma(H_0) = [-1, 1]$.

(2) For $\lambda \in (-1, \frac{2d-1}{2d+1}) \setminus \widetilde{\mathcal{T}}_-$, $M_{\lambda,-}^{\mathbf{C}}$ is a real analytic submanifold of \mathbf{T}^d and $M_{\lambda,-}^{\mathbf{C}}$ is an analytic submanifold of $\mathbf{T}_{\mathbf{C}}^d$.

(3) For $\lambda \in (\frac{-2d+1}{2d+1}, 1) \setminus \widetilde{\mathcal{T}}_+$, $M_{\lambda,+}^{\mathbf{C}}$ is a real analytic submanifold of \mathbf{T}^d and $M_{\lambda,+}^{\mathbf{C}}$ is an analytic submanifold of $\mathbf{T}_{\mathbf{C}}^d$.

(4) For $-1 < \lambda < \frac{2d-1}{2d+1}$, each connected component of $M_{\lambda,-}^{\mathbf{C}}$ intersects with \mathbf{T}^d and the intersection is a $(d-1)$ -dimensional real analytic submanifold of \mathbf{T}^d .

(5) For $\frac{-2d+1}{2d+1} < \lambda < 1$, each connected component of $M_{\lambda,+}^{\mathbf{C}}$ intersects with \mathbf{T}^d and the intersection is a $(d-1)$ -dimensional real analytic submanifold of \mathbf{T}^d .

(6) For $-1 < \lambda < \frac{-2d+1}{2d+1}$, $M_{\lambda,+}^{\mathbf{C}} \cap \mathbf{T}^d = \emptyset$.

(7) For $\frac{2d-1}{2d+1} < \lambda < 1$, $M_{\lambda,-}^{\mathbf{C}} \cap \mathbf{T}^d = \emptyset$.

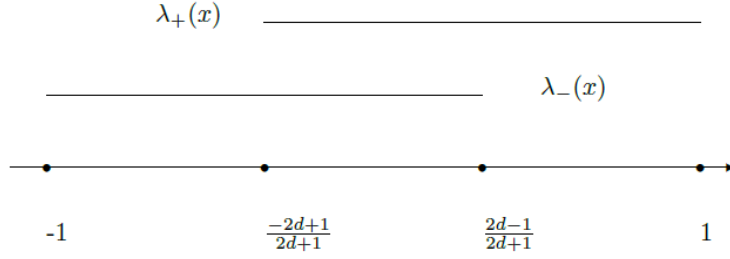

FIGURE 8. Eigenvalues for the Ladder

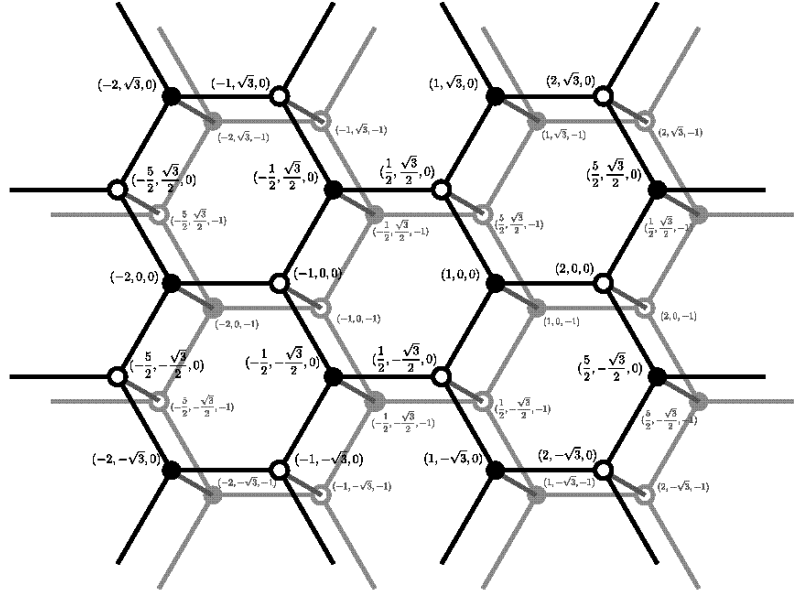

FIGURE 9. Graphite

3.9. **Graphite in \mathbf{R}^3 .** The graphite has the same structure as above with the square lattice replaced by the hexagonal lattice. We put

$$(3.60) \quad \mathcal{L}_2 = \{ \mathbf{v}(n) = n_1 \mathbf{v}_1 + n_2 \mathbf{v}_2 ; n \in \mathbf{Z}^2 \},$$

$$(3.61) \quad \mathbf{v}_1 = \left(\frac{3}{2}, \frac{\sqrt{3}}{2}, 0 \right), \quad \mathbf{v}_2 = (0, \sqrt{3}, 0),$$

$$(3.62) \quad p_1 = \left(\frac{1}{2}, -\frac{\sqrt{3}}{2}, 0 \right), \quad p_2 = (1, 0, 0),$$

$$(3.63) \quad p_3 = p_1 + (0, 0, -1), \quad p_4 = p_2 + (0, 0, -1),$$

and define the vertex set \mathcal{V} by

$$(3.64) \quad \mathcal{V} = \bigcup_{i=1}^4 \mathcal{V}_i, \quad \mathcal{V}_i = p_i + \mathcal{L}_2.$$

The adjacent relation is defined by

$$(3.65) \quad \mathcal{N}_a = \{y \in \mathcal{V}; |y - a| = 1\}, \quad a \in \mathcal{V}.$$

For a function $\widehat{f}(n) = (\widehat{f}_1(n), \widehat{f}_2(n), \widehat{f}_3(n), \widehat{f}_4(n))$, the Laplacian is defined by

$$(\widehat{\Delta}_\Gamma \widehat{f})(n) = \frac{1}{4} \begin{pmatrix} \widehat{f}_3(n) + \widehat{f}_2(n) + \widehat{f}_2(n_1 - 1, n_2) + \widehat{f}_2(n_1, n_2 - 1) \\ \widehat{f}_4(n) + \widehat{f}_1(n) + \widehat{f}_1(n_1 + 1, n_2) + \widehat{f}_1(n_1, n_2 + 1) \\ \widehat{f}_1(n) + \widehat{f}_4(n) + \widehat{f}_4(n_1 - 1, n_2) + \widehat{f}_4(n_1, n_2 - 1) \\ \widehat{f}_2(n) + \widehat{f}_3(n) + \widehat{f}_3(n_1 + 1, n_2) + \widehat{f}_3(n_1, n_2 + 1) \end{pmatrix}.$$

Passing to the Fourier series, $-\widehat{\Delta}_\Gamma$ is written as $H_0(x)$, where

$$(3.66) \quad H_0(x) = -\frac{1}{4} \begin{pmatrix} 0 & \overline{c(x)} & 1 & 0 \\ c(x) & 0 & 0 & 1 \\ 1 & 0 & 0 & \overline{c(x)} \\ 0 & 1 & c(x) & 0 \end{pmatrix},$$

$$(3.67) \quad c(x) = 1 + e^{-ix_1} + e^{-ix_2}.$$

Then we have, letting $|c|^2 = \alpha(x) = 3 + 2(\cos x_1 + \cos x_2 + \cos(x_1 - x_2))$,

$$(3.68) \quad p(x, \lambda) = \det(H_0(x) - \lambda) = \lambda^4 - \frac{\alpha + 1}{8} \lambda^2 + \frac{(\alpha - 1)^2}{4^4}.$$

Therefore, $H_0(x)$ has 4 eigenvalues $\pm(\sqrt{\alpha(x)} \pm 1)/4$. We label them as

$$(3.69) \quad \begin{aligned} \lambda_1(x) &= -\frac{1}{4} - \frac{\sqrt{\alpha(x)}}{4}, \\ \lambda_2(x) &= \begin{cases} -\frac{1}{4} + \frac{\sqrt{\alpha(x)}}{4}, & \text{if } \alpha(x) \leq 1 \\ \frac{1}{4} - \frac{\sqrt{\alpha(x)}}{4}, & \text{if } \alpha(x) \geq 1, \end{cases} \\ \lambda_3(x) &= \begin{cases} \frac{1}{4} - \frac{\sqrt{\alpha(x)}}{4}, & \text{if } \alpha(x) \leq 1 \\ -\frac{1}{4} + \frac{\sqrt{\alpha(x)}}{4}, & \text{if } \alpha(x) \geq 1, \end{cases} \\ \lambda_4(x) &= \frac{1}{4} + \frac{\sqrt{\alpha(x)}}{4}. \end{aligned}$$

Then we have

$$\lambda_1(x) \leq \lambda_2(x) \leq \lambda_3(x) \leq \lambda_4(x),$$

and they are distinct if $\alpha(x) \neq 0, 1$. Furthermore, $\nabla \lambda_j(x) \neq 0$ if $0 < \alpha(x) < 1$, $1 < \alpha(x) < 9$. Note that

$$(3.70) \quad \alpha = 0, 1 \quad \text{on} \quad M_\lambda \iff \lambda = 0, \pm \frac{1}{4}, \pm \frac{1}{2}.$$

Letting

$$(3.71) \quad M_\lambda^{(j)} = \{x \in \mathbf{T}^2; \lambda_j(x) = \lambda\},$$

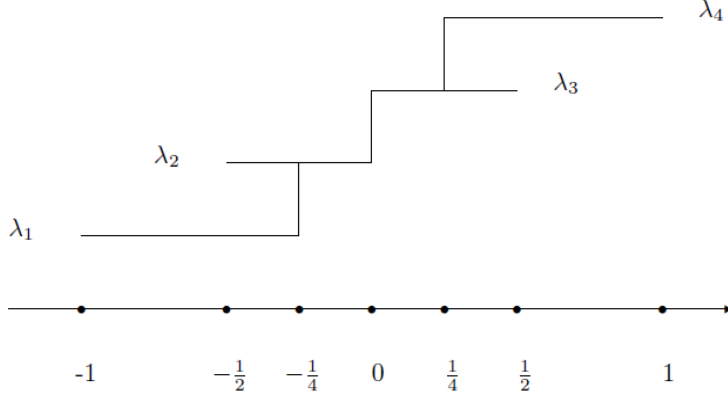

FIGURE 10. Eigenvalues for the Graphite

we have

$$M_\lambda = \bigcup_{j=1}^4 M_\lambda^{(j)}.$$

We need another splitting of M_λ . Let

$$(3.72) \quad M_{\lambda,\pm}^{\mathbf{C}} = \{z \in \mathbf{T}_{\mathbf{C}}^2; \cos z_1 + \cos z_2 + \cos(z_1 - z_2) = 8\lambda^2 \pm 4\lambda - 1\},$$

$$(3.73) \quad M_{\lambda,\pm} = M_{\lambda,\pm}^{\mathbf{C}} \cap \mathbf{T}^2.$$

Then $p = 0 \iff 16\lambda^2 = (\sqrt{\alpha} \pm 1)^2 \iff \alpha = 16\lambda^2 \pm 8\lambda + 1$. This yields

$$(3.74) \quad M_\lambda = M_{\lambda,+} \cup M_{\lambda,-}, \quad M_\lambda^{\mathbf{C}} = M_{\lambda,+}^{\mathbf{C}} \cup M_{\lambda,-}^{\mathbf{C}}.$$

Lemma 3.13. (1) $\sigma(H_0) = [-1, 1]$.

(2) $\tilde{\mathcal{T}} = \{0, \pm 1/4, \pm 1/2, \pm 1\}$.

(3) For $\lambda \in (-1, 1) \setminus \tilde{\mathcal{T}}$ and $1 \leq j \leq 4$, $M_\lambda^{(j)}$ is a real analytic submanifold of \mathbf{T}^2 .

(4) For $-1 < \lambda < -1/4$, $-1/4 < \lambda < 1/4$ and $1/4 < \lambda < 1$, $M_{\lambda, \text{sneg}}^{\mathbf{C}} \subset (\pi\mathbf{Z})^2 \cap \mathbf{T}_{\mathbf{C}}^2$.

(5) For $-1 < \lambda < -1/4$ and $-1/4 < \lambda < 1/2$, each connected component of $M_{\lambda,+}^{\mathbf{C}}$ intersects with \mathbf{T}^2 and the intersection is a 1-dimensional real analytic submanifold of \mathbf{T}^2 .

(6) For $-1/2 < \lambda < 1/4$ and $1/4 < \lambda < 1$, each connected component of $M_{\lambda,-}^{\mathbf{C}}$ intersects with \mathbf{T}^2 and the intersection is a 1-dimensional real analytic submanifold of \mathbf{T}^2 .

(7) For $-1 < \lambda < -1/2$, $M_{\lambda,-}^{\mathbf{C}} \cap \mathbf{T}^2 = \emptyset$.

(8) For $1/2 < \lambda < 1$, $M_{\lambda,+}^{\mathbf{C}} \cap \mathbf{T}^2 = \emptyset$.

Proof. The assertion (1) follows from Lemma 2.2 (3). To prove (2), let

$$a_i = \frac{\partial}{\partial x_i} \alpha = -2 \sin x_i - 2 \sin(x_i - x_j), \quad i \neq j.$$

Then we have

$$\frac{\partial}{\partial x_i} p = a_i \left(-\frac{\lambda^2}{8} + \frac{2}{4^2} (\alpha - 1) \right).$$

A simple computation shows that

$$-\frac{\lambda^2}{8} + \frac{2}{4^4}(\alpha - 1)^2 = 0, \quad \lambda^4 - \frac{\alpha + 1}{8}\lambda^2 + \frac{(\alpha - 1)^2}{4^4} = 0$$

if and only if

$$\alpha = 1, \quad \lambda = 0.$$

Therefore, if $p(x, \lambda) = 0$, $\nabla_x p(x, \lambda) = 0$, $\lambda \neq 0$, we have $a_1 = a_2 = 0$, which implies $(x_1, x_2) = (0, 0), (0, \pi), (\pi, 0), (\pi, \pi), (2\pi/3, 4\pi/3), (4\pi/3, 2\pi/3)$. For these values, $\alpha = 0, 1, 9$ and $\lambda^2 = 0, 1/16, 1/4, 1$. This proves (2).

The assertion (3) follows from (3.70).

The assertion (4) follows from Lemma 2.2 (2).

In view of Lemma 2.2 (4) and (5), we have (5), (6), (7), and (8). \square

3.10. Graph-operation and characteristic polynomials. Let us observe the above examples from a view point of graph-operation, which is a method of creating new graphs from the given one. It is worthwhile to note the general relations (3.75), (3.76), (3.79) between the characteristic polynomial of the Laplacian for the resulting graph and that of the original graph. We omit the proof of these formulas, although they follow from straightforward computation, since we do not use them in this paper. The arguments in the following sub-subsections 3.10.1, 3.10.2 are based on [46] and [15].

We recall some notions in the graph theory.

A graph Γ is said to be k -regular if $\deg(v) = k$ for any $v \in \mathcal{V}(\Gamma)$.

A (k_1, k_2) -semiregular graph Γ is, by definition, a bipartite graph with two partite sets \mathcal{V}_1 and \mathcal{V}_2 , i.e. $\mathcal{V}(\Gamma) = \mathcal{V}_1 \cup \mathcal{V}_2$, $\mathcal{V}_1 \cap \mathcal{V}_2 = \emptyset$, and $\mathcal{N}_{v_1} \subset \mathcal{V}_2$ for any $v_1 \in \mathcal{V}_1$, $\mathcal{N}_{v_2} \subset \mathcal{V}_1$ for any $v_2 \in \mathcal{V}_2$. Furthermore, $\deg(v_j) = k_j$ for any $v_j \in \mathcal{V}_j$, $j = 1, 2$.

Any periodic graph Γ can be viewed as an abelian covering graph of a finite graph Γ_0 , which is called the *fundamental graph* of Γ .

3.10.1. Line graph. Given a graph $\Gamma = \{\mathcal{V}(\Gamma), \mathcal{E}(\Gamma)\}$, its *line graph* $L(\Gamma) = \{\mathcal{V}(L(\Gamma)), \mathcal{E}(L(\Gamma))\}$ is defined as follows : (1) The vertex set $\mathcal{V}(L(\Gamma))$ is $\mathcal{E}(\Gamma)$. (2) $\mathcal{E}(L(\Gamma)) \ni (e_1, e_2)$, where $e_1, e_2 \in \mathcal{E}(\Gamma)$, if and only if $o(e_1) = o(e_2)$.

The characteristic polynomials of Γ and $L(\Gamma)$ are then related each other. In fact, let Γ be a k -regular abelian covering graph of a finite graph Γ_0 , $k \geq 3$; μ and ν the numbers of the vertices and edges of Γ_0 , respectively. Let $\kappa = \nu - \mu$, which is a positive integer, and $p_\Gamma(x, \lambda)$ be the characteristic polynomial of $-\hat{\Delta}_\Gamma$ on Γ . Then $L(\Gamma)$ is a $2(k-1)$ -regular abelian covering graph of $L(\Gamma_0)$ whose transformation group is also that of Γ , and the characteristic polynomial $p_{L(\Gamma)}(x, \lambda)$ of $-\hat{\Delta}_{L(\Gamma)}$ is

$$(3.75) \quad p_{L(\Gamma)}(x, \lambda) = \left(\frac{1}{k-1} - \lambda \right)^\kappa \left(\frac{k}{2k-2} \right)^\mu p_\Gamma \left(x, \frac{2k-2}{k} \left(\lambda + \frac{k-2}{2k-2} \right) \right).$$

For instance, the Kagome lattice is a line graph of the hexagonal lattice.

We can also compute the characteristic polynomial of the line graph of a (k_1, k_2) -semiregular periodic graph, where $k_1 \geq k_2 \geq 3$ or $k_1 > k_2 = 2$. See [46] and [15] for the details, where they study the spectrum of the discrete Laplacian on the line graph of k -regular or (k_1, k_2) -semiregular infinite graphs, which are not necessarily periodic.

3.10.2. Subdivision. We can define the subdivisions of the triangular lattice, the hexagonal lattice, the Kagome lattice and the diamond lattice, and derive similar spectral properties for their Hamiltonians in the same way as in Subsection 3.7. As in the case of line graph, the characteristic polynomials of a regular periodic graph and its subdivision are mutually related. In fact, for a k -regular abelian covering graph Γ of a finite graph Γ_0 , $k \geq 3$, put μ , ν , and κ in the same way as above, and let $p_\Gamma(x, \lambda)$ be the characteristic polynomial of $-\widehat{\Delta}_\Gamma$. Then the subdivision $S(\Gamma)$ of Γ is a $(k, 2)$ -semiregular abelian covering graph of $S(\Gamma_0)$ whose transformation group is also that of Γ , and the characteristic polynomial $p_{S(\Gamma)}(x, \lambda)$ of $-\widehat{\Delta}_{S(\Gamma)}$ is

$$(3.76) \quad p_{S(\Gamma)}(x, \lambda) = (-\lambda)^\kappa \left(-\frac{1}{2}\right)^\mu p_\Gamma(x, 1 - 2\lambda^2).$$

In [46] and [15], they also study the spectrum for the Laplacian on the subdivision of k -regular, $k \geq 3$, infinite graphs, which are not necessarily periodic.

3.10.3. Ladder. The ladder structure is defined for any periodic graphs. Let Γ be a k -regular periodic graph, μ the number of vertices in the fundamental graph Γ_0 , and $p_\Gamma(x, \lambda)$ the characteristic polynomial of $\widehat{H}_\Gamma = -\widehat{\Delta}_\Gamma$ on Γ . The ladder $Lad(\Gamma)$ of Γ is defined as a union of two copies of Γ with additional edges joining the corresponding vertices, which is a $(k + 1)$ -regular periodic graph. Then $\widehat{H}_{Lad(\Gamma)} = -\widehat{\Delta}_{Lad(\Gamma)}$ has the following structure:

$$(3.77) \quad \widehat{H}_{Lad(\Gamma)} = \frac{k}{k+1} \begin{pmatrix} \widehat{H}_\Gamma & \frac{1}{k}I \\ \frac{1}{k}I & \widehat{H}_\Gamma \end{pmatrix} : l^2(\Gamma) \oplus l^2(\Gamma) \rightarrow l^2(\Gamma) \oplus l^2(\Gamma).$$

Passing $\widehat{H}_{Lad(\Gamma)}$ to the Fourier transform, we have a multiplication operator by a $2\mu \times 2\mu$ symmetric matrix-valued function

$$(3.78) \quad H_{Lad(\Gamma)}(x) = \frac{k}{k+1} \begin{pmatrix} H_\Gamma(x) & \frac{1}{k}I \\ \frac{1}{k}I & H_\Gamma(x) \end{pmatrix} \text{ on } L^2(\mathbb{T}^d) \oplus L^2(\mathbb{T}^d),$$

where $H_\Gamma(x)$ is a $\mu \times \mu$ symmetric matrix-valued function which is obtained by passing \widehat{H}_Γ to the Fourier transform. The characteristic polynomial $p_{Lad(\Gamma)}(x, \lambda)$ of $\widehat{H}_{Lad(\Gamma)}$ is then computed as

$$(3.79) \quad p_{Lad(\Gamma)}(x, \lambda) = \left(\frac{k}{k+1}\right)^{2\mu} p_\Gamma\left(x, \frac{k+1}{k}\lambda + \frac{1}{k}\right) p_\Gamma\left(x, \frac{k+1}{k}\lambda - \frac{1}{k}\right).$$

4. DISTRIBUTIONS ON THE TORUS

4.1. Sobolev and Besov spaces on \mathbf{R}^d , lattice and torus. Let $r_{-1} = 0$, $r_j = 2^j$, ($j \geq 0$), and on \mathbf{R}^d , define the Besov space $\mathcal{B}(\mathbf{R}^d)$ to be the set of all functions f having the following norm :

$$(4.1) \quad \|f\|_{\mathcal{B}(\mathbf{R}^d)} = \sum_{j=0}^{\infty} r_j^{1/2} \left(\int_{\Xi_j} |\tilde{f}(\xi)|^2 d\xi \right)^{1/2},$$

where $\Xi_j = \{\xi \in \mathbf{R}^d; r_{j-1} \leq |\xi| < r_j\}$, and \tilde{f} denotes the Fourier transform. The (equivalent) norm of the dual space $\mathcal{B}^*(\mathbf{R}^d)$ is

$$(4.2) \quad \|u\|_{\mathcal{B}^*(\mathbf{R}^d)} = \left(\sup_{R>1} \frac{1}{R} \int_{|\xi|<R} |\tilde{u}(\xi)|^2 d\xi \right)^{1/2}.$$

The space $\mathcal{B}_0^*(\mathbf{R}^d)$ is defined as follows:

$$(4.3) \quad \mathcal{B}_0^*(\mathbf{R}^d) = \left\{ u \in \mathcal{B}^*(\mathbf{R}^d); \lim_{R \rightarrow \infty} \frac{1}{R} \int_{|\xi|<R} |\tilde{u}(\xi)|^2 d\xi = 0 \right\}.$$

The Sobolev space $H^\sigma(\mathbf{R}^d)$ is defined as usual :

$$(4.4) \quad H^\sigma(\mathbf{R}^d) = \left\{ u \in \mathcal{S}'(\mathbf{R}^d); \|(1 + |\xi|^2)^{\sigma/2} \tilde{u}(\xi)\|_{L^2(\mathbf{R}^d)} < \infty \right\}, \quad \sigma \in \mathbf{R}.$$

The Besov spaces \mathcal{B} , \mathcal{B}^* are also defined on \mathbf{T}^d . Take a C^∞ -partition of unity $\{\chi_\ell\}_{\ell=1}^N$ on \mathbf{T}^d where the support of χ_ℓ is sufficiently small, and define

$$(4.5) \quad \|f\|_{\mathcal{B}(\mathbf{T}^d)} = \sum_{\ell=1}^N \|\chi_\ell f\|_{\mathcal{B}(\mathbf{R}^d)},$$

$$(4.6) \quad \|u\|_{\mathcal{B}^*(\mathbf{T}^d)} = \sum_{\ell=1}^N \|\chi_\ell u\|_{\mathcal{B}^*(\mathbf{R}^d)}.$$

The space $\mathcal{B}_0^*(\mathbf{T}^d)$ is defined to be the set of $u \in \mathcal{B}^*(\mathbf{T}^d)$ such that

$$(4.7) \quad \chi_\ell u \in \mathcal{B}_0^*(\mathbf{R}^d), \quad 1 \leq \ell \leq N.$$

The Sobolev space $H^\sigma(\mathbf{T}^d)$ is defined similarly.

The analogues of \mathcal{B} and \mathcal{B}^* on the lattice \mathbf{Z}^d are defined to be the Banach spaces endowed with norms

$$(4.8) \quad \|\hat{f}\|_{\widehat{\mathcal{B}}(\mathbf{Z}^d)} = \sum_{j=0}^{\infty} r_j^{1/2} \left(\sum_{r_{j-1} \leq |n| < r_j} |\hat{f}(n)|^2 \right)^{1/2},$$

$$(4.9) \quad \|\hat{u}\|_{\widehat{\mathcal{B}}^*(\mathbf{Z}^d)} = \left(\sup_{R>1} \frac{1}{R} \sum_{|n|<R} |\hat{u}(n)|^2 \right)^{1/2}.$$

The space $\widehat{\mathcal{B}}_0^*(\mathbf{Z}^d)$ is then defined by

$$(4.10) \quad \widehat{\mathcal{B}}_0^*(\mathbf{Z}^d) = \left\{ \hat{u} \in \widehat{\mathcal{B}}^*(\mathbf{Z}^d); \lim_{R \rightarrow \infty} \frac{1}{R} \sum_{|n|<R} |\hat{u}(n)|^2 = 0 \right\}.$$

For $\sigma \in \mathbf{R}$, the weighted space $\ell^{2,\sigma}$ is the set of all \hat{u} satisfying

$$\|\hat{u}\|_{\ell^{2,\sigma}}^2 = \sum_{n \in \mathbf{Z}^d} (1 + |n|^2)^\sigma |\hat{u}(n)|^2 < \infty.$$

These Besov spaces $\mathcal{B}(\mathbf{T}^d)$, $\widehat{\mathcal{B}}(\mathbf{Z}^d)$, $\mathcal{B}^*(\mathbf{T}^d)$, $\widehat{\mathcal{B}}^*(\mathbf{Z}^d)$ are related by the Fourier series. For $\hat{f} \in \mathcal{S}'(\mathbf{Z}^d)$, let $f = \mathcal{U}\hat{f}$, where \mathcal{U} is defined by (1.4). We define operators \widehat{N}_j on the lattice \mathbf{Z}^d and N_j on the torus \mathbf{T}^d by

$$(\widehat{N}_j \hat{f})(n) = n_j \hat{f}(n), \quad N_j = \mathcal{U} \widehat{N}_j \mathcal{U}^* = i \frac{\partial}{\partial x_j}.$$

We put $N = (N_1, \dots, N_d)$, and let N^2 be the self-adjoint operator defined by

$$N^2 = \sum_{j=1}^d N_j^2 = -\Delta, \quad \text{on } \mathbf{T}^d,$$

where Δ is the Laplacian on \mathbf{T}^d with periodic boundary condition. We put

$$(4.11) \quad |N| = \sqrt{N^2} = \sqrt{-\Delta}.$$

For $\sigma \in \mathbf{R}$, $H^\sigma(\mathbf{T}^d)$ coincides with the completion of $D(|N|^\sigma)$ with respect to the norm $\|u\|_\sigma = \|(1 + N^2)^{\sigma/2}u\|$ i.e.

$$H^\sigma(\mathbf{T}^d) = \{u \in \mathcal{S}'(\mathbf{T}^d); \|u\|_\sigma = \|(1 - \Delta)^{\sigma/2}u\| < \infty\}.$$

For a self-adjoint operator T , let $\chi(a \leq T < b)$ denote the operator $\chi_I(T)$, where $\chi_I(\lambda)$ is the characteristic function of the interval $I = [a, b)$. The operators $\chi(T < a)$ and $\chi(T \geq b)$ are defined similarly. Then the Besov spaces $\mathcal{B}(\mathbf{T}^d)$, $\mathcal{B}^*(\mathbf{T}^d)$ are rewritten by the equivalent norms :

$$(4.12) \quad \mathcal{B}(\mathbf{T}^d) = \left\{ f \in L^2(\mathbf{T}^d); \|f\|_{\mathcal{B}(\mathbf{T}^d)} = \sum_{j=0}^{\infty} r_j^{1/2} \|\chi(r_{j-1} \leq |N| < r_j) f\| < \infty \right\},$$

$$(4.13) \quad \mathcal{B}^*(\mathbf{T}^d) = \left\{ u \in \mathcal{S}'(\mathbf{T}^d); \|u\|_{\mathcal{B}^*(\mathbf{T}^d)} = \left(\sup_{R>1} \frac{1}{R} \|\chi(|N| < R) u\|^2 \right)^{1/2} < \infty \right\},$$

and $\mathcal{B}_0^*(\mathbf{T}^d)$ is rewritten as

$$(4.14) \quad \mathcal{B}_0^*(\mathbf{T}^d) = \left\{ u \in \mathcal{B}^*(\mathbf{T}^d); \lim_{R \rightarrow \infty} \frac{1}{R} \|\chi(|N| < R) u\|^2 = 0 \right\}.$$

In fact, the equivalence of (4.6) and (4.13), and that of (4.7) and (4.14) are proved in [26], Lemmas 3.1 and 3.2. The equivalence of (4.5) and (4.12) follows from this by duality.

Note also the following equivalence:

$$\begin{aligned} f \in \mathcal{B}(\mathbf{T}^d) &\iff \widehat{f} \in \widehat{\mathcal{B}}(\mathbf{Z}^d), \\ u \in \mathcal{B}^*(\mathbf{T}^d) &\iff \widehat{u} \in \widehat{\mathcal{B}}^*(\mathbf{Z}^d), \\ u \in \mathcal{B}_0^*(\mathbf{T}^d) &\iff \widehat{u} \in \widehat{\mathcal{B}}_0^*(\mathbf{Z}^d). \end{aligned}$$

In the sequel, we often write \mathcal{B} , $\widehat{\mathcal{B}}$, \mathcal{B}^* , $\widehat{\mathcal{B}}^*$, \mathcal{B}_0^* and $\widehat{\mathcal{B}}_0^*$, omitting \mathbf{R}^d , \mathbf{T}^d , \mathbf{Z}^d .

4.2. Basic Lemmas. We use the following properties of Besov spaces. Let $S_{1,0}^m$ be the standard Hörmander class of Ψ DO on \mathbf{R}^d .

Lemma 4.1. (1) If $f \in \mathcal{B}(\mathbf{R}^d)$, we have

$$\int_{-\infty}^{\infty} \|f(x_1, \cdot)\|_{L^2(\mathbf{R}^{d-1})} dx_1 \leq \sqrt{2} \|f\|_{\mathcal{B}(\mathbf{R}^d)}.$$

(2) If $P \in S_{1,0}^0$, we have

$$P \in \mathbf{B}(\mathcal{B}; \mathcal{B}) \cap \mathbf{B}(\mathcal{B}^*; \mathcal{B}^*) \cap \mathbf{B}(\mathcal{B}_0^*; \mathcal{B}_0^*).$$

Proof. The assertion (1) is proven in [20], Theorem 14.1.2. For $\chi \in C_0^\infty(\mathbf{R}^d)$, let χ_R be the Ψ DO with symbol $\chi(\xi/R)$. Then we have

$$u \in \mathcal{B}^* \iff \sup_{R>1} \frac{1}{\sqrt{R}} \|\chi_R u\|_{L^2(\mathbf{R}^d)} < \infty, \quad \forall \chi \in C_0^\infty(\mathbf{R}^d).$$

This and the symbolic calculus of Ψ DO imply $P \in \mathbf{B}(\mathcal{B}^*; \mathcal{B}^*)$. Taking the adjoint, we have $P \in \mathbf{B}(\mathcal{B}; \mathcal{B})$. The fact $P \in \mathbf{B}(\mathcal{B}_0^*; \mathcal{B}_0^*)$ is proven similarly. \square

Lemma 4.2. *Suppose $u \in \mathcal{S}'(\mathbf{R}^d)$ satisfies $\tilde{u} \in L_{loc}^2(\mathbf{R}^d)$ and*

$$\limsup_{R \rightarrow \infty} \frac{1}{R} \int_{|\xi| < R} |\tilde{u}(\xi)|^2 d\xi < \infty.$$

If there is a submanifold M of codimension 1 in \mathbf{R}^d such that $\text{supp } u \subset M$, then there exists $u_0 \in L^2(M)$ such that

$$(4.15) \quad \langle u, \varphi \rangle = \int_M u_0 \varphi dM, \quad \forall \varphi \in \mathcal{S}(\mathbf{R}^d),$$

$$(4.16) \quad \int_M |u_0|^2 dM \leq C \limsup_{R \rightarrow \infty} \frac{1}{R} \int_{|\xi| < R} |\tilde{u}(\xi)|^2 d\xi < \infty.$$

For the proof, see [19], Theorem 7.1.27.

4.3. Distribution $(x_1 \mp i0)^{-1}$ and its wavefront set. We need a division theorem and its micro-local consequences. Let us begin with the case of \mathbf{R}^d .

Lemma 4.3. *For $f \in \mathcal{B}(\mathbf{R}^d)$ and $\epsilon > 0$, let $u_\epsilon(x) = f(x)/(x_1 - i\epsilon)$. Then, $\lim_{\epsilon \rightarrow 0} u_\epsilon = f(x)/(x_1 - i0) =: u_+$ exists in the weak $*$ sense, i.e.*

$$(4.17) \quad (u_\epsilon, g) \rightarrow (u_+, g), \quad \forall g \in \mathcal{B}(\mathbf{R}^d),$$

with the following estimate

$$(4.18) \quad \|u_+\|_{\mathcal{B}^*(\mathbf{R}^d)} \leq 2\|f\|_{\mathcal{B}(\mathbf{R}^d)}.$$

Moreover, $\tilde{u}_+(\xi)$ is an $L^2(\mathbf{R}^{d-1})$ -valued bounded function of ξ_1 and

$$(4.19) \quad \|\tilde{u}_+(\xi_1, \cdot)\|_{L^2(\mathbf{R}^{d-1})} \rightarrow 0, \quad \text{as } \xi_1 \rightarrow \infty,$$

$$(4.20) \quad \left\| \tilde{u}_+(\xi_1, \cdot) - i \int_{-\infty}^{\infty} \tilde{f}(\eta_1, \cdot) d\eta_1 \right\|_{L^2(\mathbf{R}^{d-1})} \rightarrow 0, \quad \text{as } \xi_1 \rightarrow -\infty.$$

Proof. Letting θ be the Heaviside function, we have

$$(4.21) \quad (u_\epsilon, g) = i \int_{\mathbf{R}^{d+1}} \theta(\eta_1 - \xi_1) e^{\epsilon(\xi_1 - \eta_1)} \tilde{f}(\eta_1, \xi') \overline{\tilde{g}(\xi)} d\eta_1 d\xi.$$

By the Schwarz inequality,

$$\int_{\mathbf{R}^{d-1}} |\tilde{f}(\eta_1, \xi') \overline{\tilde{g}(\xi_1, \xi')}| d\xi' \leq \|\tilde{f}(\eta_1, \cdot)\|_{L^2(\mathbf{R}^{d-1})} \|\tilde{g}(\xi_1, \cdot)\|_{L^2(\mathbf{R}^{d-1})}.$$

Using Lemma 4.1 (1), we have

$$(4.22) \quad |(u_\epsilon, g)| \leq 2\|f\|_{\mathcal{B}} \|g\|_{\mathcal{B}},$$

which implies $\|u_\epsilon\|_{\mathcal{B}^*} \leq 2\|f\|_{\mathcal{B}}$. If $f, g \in C_0^\infty(\mathbf{R}^d)$, $u_\epsilon \rightarrow u_+$ pointwise, and $(u_\epsilon, g) \rightarrow (u_+, g)$. By (4.22), we have $|(u_+, g)| \leq 2\|f\|_{\mathcal{B}} \|g\|_{\mathcal{B}}$, hence $u_+ \in \mathcal{B}^*$. Approximating

f and g by elements of $C_0^\infty(\mathbf{R}^d)$, we see that (4.17) and (4.18) hold for $f, g \in \mathcal{B}$. The equality (4.21) shows

$$(4.23) \quad \tilde{u}_+(\xi) = i \int_{\xi_1}^{\infty} \tilde{f}(\eta_1, \xi') d\eta_1.$$

Lemma 4.1 (1) then implies that $\tilde{u}_+(\xi)$ is an $L^2(\mathbf{R}^{d-1})$ -valued bounded function of ξ_1 , and (4.19). Moreover, we have

$$\|\tilde{u}_+(\xi_1, \cdot) - i \int_{-\infty}^{\infty} \tilde{f}(\eta_1, \cdot) d\eta_1\|_{L^2(\mathbf{R}^{d-1})} \leq \int_{-\infty}^{\xi_1} \|\tilde{f}(\eta_1, \cdot)\|_{L^2(\mathbf{R}^{d-1})} d\eta_1,$$

which yields (4.20). \square

Definition 4.4. For $u \in \mathcal{S}'(\mathbf{R}^d)$, the *wave front set* $WF^*(u)$ is defined as follows. For $(x_0, \omega) \in \mathbf{R}^d \times S^{d-1}$, $(x_0, \omega) \notin WF^*(u)$, if there exist $0 < \delta < 1$ and $\chi \in C_0^\infty(\mathbf{R}^d)$ satisfying $\chi(x_0) = 1$ such that

$$(4.24) \quad \lim_{R \rightarrow \infty} \frac{1}{R} \int_{|\xi| < R} |C_{\omega, \delta}(\xi) (\widetilde{\chi u})(\xi)|^2 d\xi = 0,$$

where $C_{\omega, \delta}(\xi)$ is the characteristic function of the cone $\{\xi \in \mathbf{R}^d; \omega \cdot \xi > \delta|\xi|\}$.

Lemma 4.5. For u_+ in Lemma 4.3, we have

$$(4.25) \quad WF^*(u_+) \subset \{(0, x'), (-1, 0)\}; x' \in \mathbf{R}^{d-1}\}.$$

$$(4.26) \quad u_+(x) - \frac{1}{x_1 - i0} \otimes f(0, x') \in \mathcal{B}_0^*(\mathbf{R}^d).$$

Proof. Take $h \in C_0^\infty(\mathbf{R}^d)$ and put $w(x) = h(x)/(x_1 - i0)^{-1}$. Then by (4.18),

$$\frac{1}{R} \int_{|\xi| < R} |C_{\omega, \delta}(\xi) \widetilde{\chi u_+}(\xi)|^2 d\xi \leq \frac{1}{R} \int_{|\xi| < R} |C_{\omega, \delta}(\xi) \widetilde{\chi w}(\xi)|^2 d\xi + C\|f - h\|_{\mathcal{B}}^2,$$

where the constant C is independent of $R > 1$. Therefore, we have only to prove the lemma when $f \in C_0^\infty(\mathbf{R}^d)$. Obviously, $((y_1, y'), \omega) \notin WF^*(u_+)$ if $y_1 \neq 0$. Take $((0, y'), \omega)$ such that $(-1, 0) \neq \omega \in S^{d-1}$. Take $\chi(x) \in C_0^\infty(\mathbf{R}^d)$ such that $\chi((0, y')) = 1$, and put $v(x) = \chi(x)u_+(x)$, $g(x) = \chi(x)f(x)$. Then $v(x) = g(x)/(x_1 - i0)$, hence by passing to the Fourier transform,

$$\tilde{v}(\xi_1, \xi') = i \int_{\xi_1}^{\infty} \tilde{g}(\eta_1, \xi') d\eta_1.$$

This implies

$$|\tilde{v}(\xi)| \leq C_N \int_{\xi_1}^{\infty} (1 + |\eta_1| + |\xi'|)^{-N} d\eta_1, \quad \forall N > 0.$$

Since $\omega \neq (-1, 0, \dots, 0)$, by taking $0 < \delta < 1$ sufficiently close to 1, on the region $\{\omega \cdot \xi > \delta|\xi|\}$, we have either $C|\xi_1| \leq |\xi'|$, or $\xi_1 > 0$, $C|\xi'| \leq \xi_1$, where $C > 0$. In both case, we obtain $|\tilde{v}(\xi)| \leq C_N(1 + |\xi|)^{-N}$, which proves (4.25).

Passing to the Fourier transform, $u_+(x) = f(x)/(x_1 - i0)$ becomes $\tilde{u}_+(\xi) = i \int_{\xi_1}^{\infty} \tilde{f}(\eta_1, \xi') d\eta_1$. Letting $\theta(t)$ be the Heaviside function, we then have

$$\tilde{u}_+(\xi) - i\theta(-\xi_1) \int_{-\infty}^{\infty} \tilde{f}(\eta_1, \xi') d\eta_1 = \begin{cases} i \int_{\xi_1}^{\infty} \tilde{f}(\eta_1, \xi') d\eta_1 & \text{if } \xi_1 > 0, \\ -i \int_{-\infty}^{\xi_1} \tilde{f}(\eta_1, \xi') d\eta_1 & \text{if } \xi_1 < 0. \end{cases}$$

We then have

$$\|\tilde{u}_+(\xi) - i\theta(-\xi_1) \int_{-\infty}^{\infty} \tilde{f}(\eta_1, \xi') d\eta_1\|_{L^2(\mathbf{R}^{d-1})} \rightarrow 0, \quad \text{as } |\xi_1| \rightarrow \infty.$$

This and the inequality

$$\begin{aligned} & \frac{1}{R} \int_{|\xi_1| < R} |\tilde{u}_+(\xi) - i\theta(-\xi_1) \int_{-\infty}^{\infty} \tilde{f}(\eta_1, \xi') d\eta_1|^2 d\xi \\ & \leq \frac{1}{R} \int_{|\xi_1| < R} \|\tilde{u}_+(\xi_1, \cdot) - i\theta(-\xi_1) \int_{-\infty}^{\infty} \tilde{f}(\eta_1, \cdot) d\eta_1\|_{L^2(\mathbf{R}^{d-1})}^2 d\xi_1 \end{aligned}$$

yield (4.26). \square

Consider the equation

$$(4.27) \quad x_1 u = f, \quad f \in \mathcal{B}.$$

A solution $u_+ \in \mathcal{B}^*$ ($u_- \in \mathcal{B}^*$, respectively), of the equation (4.27) is said to be *outgoing* (*incoming*) if it satisfies

$$(4.28) \quad WF^*(u_+) \subset \{((0, x'), (-1, 0)); x' \in \mathbf{R}^{d-1}\},$$

$$(4.29) \quad WF^*(u_-) \subset \{((0, x'), (1, 0)); x' \in \mathbf{R}^{d-1}\}.$$

Lemma 4.6. *Let $u \in \mathcal{B}^*$ be a solution to the equation (4.27). Then u is outgoing (incoming) if and only if*

$$u = \frac{f(x)}{x_1 - i0}, \quad \left(u = \frac{f(x)}{x_1 + i0} \right).$$

For outgoing (incoming) solution u_+ (u_-), we have

$$(4.30) \quad \text{Im}(u_{\pm}, f) = \pm \pi \|f(0, \cdot)\|_{L^2(\mathbf{R}^{d-1})}^2.$$

Proof. The "if" part is proven in Lemma 4.5. To prove the "only if" part, let u be an outgoing solution and $v = u - f(x)/(x_1 - i0)$. Then $v \in \mathcal{B}^*$ is an outgoing solution to $x_1 v = 0$. Passing to the Fourier transform, this implies that $\tilde{v}(\xi)$ depends only on $\xi' : \tilde{v}(\xi) = w(\xi')$. Integrating over the region $\Omega_R = \{(\xi_1, \xi') \mid 0 < \xi_1 < R, |\xi'| < R/2\}$, we have

$$\int_{|\xi'| < R/2} |w(\xi')|^2 d\xi \leq \frac{1}{R} \int_{\Omega_R} |\tilde{v}(\xi)|^2 d\xi.$$

Letting $R \rightarrow \infty$, we have $v = 0$, which shows that $u = f(x)/(x_1 - i0)$. The well-known formula

$$\frac{1}{t \mp i0} = \pm i\pi \delta(t) + \text{p.v.} \frac{1}{t}$$

implies (4.30). \square

4.4. Distribution $(h(x) \mp i0)^{-1}$ on \mathbf{T}^d . We now consider the equation

$$(4.31) \quad (h(x) - z)u(x) = f(x), \quad \text{on } \mathbf{T}^d,$$

where $h(x)$ is a real-valued C^∞ -function on \mathbf{T}^d . We put

$$M = \{x \in \mathbf{T}^d; h(x) = 0\},$$

and assume that

$$(C-1) \quad \nabla h(x) \neq 0 \text{ on } M.$$

Take $x_0 \in M$, $\chi \in C^\infty(\mathbf{T}^d)$ such that $\chi(x_0) = 1$ and the support of χ is sufficiently small. We make a change of variable $x \rightarrow y$ around x_0 , where $y_1 = h(x)$. Letting $v(y) = \chi(x)u(x)$, $F(y) = \chi(x)f(x)$, we then have

$$(y_1 - z)v(y) = F(y), \quad z \notin \mathbf{R}.$$

By $T_{x_0}(M)^\perp$, we mean the orthogonal complement of $T_{x_0}(M)$ in $T_{x_0}(\mathbf{R}^d)$. Applying Lemmas 4.3, 4.5, we obtain the following lemma.

Lemma 4.7. *Let $u_z = f(x)/(h(x) - z)$, $z \notin \mathbf{R}$. Then, there exists a limit $\lim_{\epsilon \rightarrow 0} u_{\pm i\epsilon} =: u_\pm$ in the weak * sense, i.e.*

$$(4.32) \quad (u_{\pm i\epsilon}, g) \rightarrow (u_\pm, g), \quad \forall g \in \mathcal{B}.$$

Moreover,

$$(4.33) \quad \|u_\pm\|_{\mathcal{B}^*} \leq C\|f\|_{\mathcal{B}},$$

$$(4.34) \quad WF^*(u_\pm) \subset \{(x, \pm\omega_x); x \in M\},$$

where $\omega_x \in S^{d-1} \cap T_x(M)^\perp$, and $\omega \cdot \nabla h(x) < 0$,

$$(4.35) \quad u_\pm(x) - \frac{1}{h(x) \mp i0} \otimes (f|_M) \in \mathcal{B}_0^*,$$

where $f|_M$ means the restriction of f to M .

A solution $u \in \mathcal{B}^*$ of the equation

$$(4.36) \quad h(x)u = f(x) \in \mathcal{B}$$

is said to be outgoing (incoming) if it satisfies

$$(4.37) \quad WF^*(u) \subset \{(x, \omega_x); x \in M\}, \quad \left(WF^*(u) \subset \{(x, -\omega_x); x \in M\} \right),$$

ω_x being as above. The following lemma is a direct consequence of Lemma 4.6.

Lemma 4.8. *Let $u \in \mathcal{B}^*$ be a solution to the equation (4.36). Then u is outgoing (incoming) if and only if*

$$u = \frac{f(x)}{h(x) - i0}, \quad \left(u = \frac{f(x)}{h(x) + i0} \right).$$

For outgoing (incoming) solution u_+ (u_-), we have

$$\operatorname{Im}(u_\pm, f) = \pm\pi \|f|_M\|_{L^2(M)}^2.$$

In particular, we have

$$\frac{1}{2\pi i}(u_+ - u_-, f) = \|f|_M\|_{L^2(M)}^2.$$

5. RELICH TYPE THEOREM ON THE TORUS

5.1. Rellich type theorem. Let $\mathcal{H}_0 = L^2(\mathbf{T}^d)^s$ equipped with the inner product (2.5), and $H_0(x)$ an $s \times s$ hermitian matrix whose entries are polynomials of $e^{\pm ix_1}, \dots, e^{\pm ix_d}$. Then, the operator of multiplication by $H_0(x)$ is a bounded self-adjoint operator on \mathcal{H}_0 , which is denoted by H_0 . The spectrum of H_0 is given by (3.1).

We are going to study the following theorem for the Hamiltonian on the lattice (see [26]) We define $\widehat{H}_0 = \mathcal{U}_{\mathcal{L}_0}^* H_0 \mathcal{U}_{\mathcal{L}_0} = -\widehat{\Delta}_{\Gamma_0}$, and suppose \widehat{u} satisfies for some $R_0 > 0$ and $\lambda \in \sigma(\widehat{H}_0)$ *except for some exceptional points* to be defined below

$$(\widehat{H}_0 - \lambda)\widehat{u} = 0 \quad \text{for } |n| > R_0, \quad \lim_{R \rightarrow \infty} \frac{1}{R} \sum_{R_0 < |n| < R} |\widehat{u}(n)|^2 = 0.$$

Then, there exists $R > R_0$ such that $\widehat{u}(n) = 0$ for $|n| > R$.

This theorem is proven by passing to the torus \mathbf{T}^d , and requires the following property on the regular part of the *complex Fermi surface* $M_\lambda^{\mathbf{C}} = \{z \in \mathbf{T}_{\mathbf{C}}^d; p(z, \lambda) = 0\}$. Recall the notation (3.5), (3.6). We assume

(A-1) *There exists a subset $\mathcal{T}_1 \subset \sigma(H_0)$ such that for $\lambda \in \sigma(H_0) \setminus \mathcal{T}_1$:*

(A-1-1) $M_{\lambda, \text{sing}}^{\mathbf{C}}$ *is discrete.*

(A-1-2) *Each connected component of $M_{\lambda, \text{reg}}^{\mathbf{C}}$ intersects with \mathbf{T}^d and the intersection is a $(d-1)$ -dimensional real analytic submanifold of \mathbf{T}^d .*

We reformulate the Rellich type theorem in the following way. A *trigonometric polynomial* is a vector function, each component of which has the form $\sum_{|\alpha| \leq N} c_\alpha e^{i\alpha \cdot x}$, c_α being a constant.

Theorem 5.1. *Assume (A-1), and let $\lambda \in \sigma(H_0) \setminus \mathcal{T}_1$. Then if $u \in \mathcal{B}_0^*(\mathbf{T}^d)$ satisfies*

$$(5.1) \quad (H_0 - \lambda)u = f(x) \quad \text{on } \mathbf{T}^d,$$

for some trigonometric polynomial $f(x)$, $u(x)$ is also a trigonometric polynomial.

The 1st step of the proof of Theorem 5.1 is to multiply the equation (5.1) by the cofactor matrix of $H_0(x) - \lambda$ and transform it as

$$(5.2) \quad p(x, \lambda)u(x) = g(x),$$

where $g(x)$ is a trigonometric polynomial. In the following, we pick up one of the components of u and g , and denote them by u and g again.

Lemma 5.2. *Let λ and u be as in Theorem 5.1. Then $u \in C^\infty(\mathbf{T}^d \setminus M_{\lambda, \text{sing}}^{\mathbf{C}})$. In particular, we have*

$$(5.3) \quad g(x) = 0 \quad \text{on } M_{\lambda, \text{reg}}^{\mathbf{C}} \cap \mathbf{T}^d.$$

Proof. Take $x^{(0)} \in M_{\lambda, \text{reg}}^{\mathbf{C}} \cap \mathbf{T}^d$, and let U be a sufficiently small neighborhood of $x^{(0)}$ in \mathbf{T}^d such that $U \cap M_{\lambda, \text{sing}}^{\mathbf{C}} = \emptyset$. Take $\chi \in C^\infty(\mathbf{T}^d)$ satisfying $\text{supp } \chi \subset U$ and $\chi(x^{(0)}) = 1$. Since $\nabla p(x_0, \lambda) \neq 0$, we can make the change of variables on U : $x \rightarrow y = (y_1, y')$ so that $y_1 = p(x, \lambda)$. Let $v = \chi(x)u(x)$, $h = \chi(x)g(x)$, Since $u \in \mathcal{B}_0^*$, passing to the Fourier transform,

$$(5.4) \quad \lim_{R \rightarrow \infty} \frac{1}{R} \int_{|\eta| < R} |\widetilde{v}(\eta)|^2 d\eta = 0.$$

By (5.2), $\frac{\partial}{\partial \eta_1} \tilde{v}(\eta) = i\tilde{h}(\eta)$. Integrating this equation, we have

$$\tilde{v}(\eta) = i \int_0^{\eta_1} \tilde{h}(s, \eta') ds + \tilde{v}(0, \eta').$$

Since $\tilde{h}(\eta)$ is rapidly decreasing, there exists the limit

$$\lim_{\eta_1 \rightarrow \infty} \tilde{v}(\eta) = i \int_0^{\infty} \tilde{h}(s, \eta') ds + \tilde{v}(0, \eta').$$

We show that this limit vanishes. Let D_R be the slab such that

$$D_R = \left\{ \eta ; |\eta'| < \delta R, \frac{R}{3} < \eta_1 < \frac{2R}{3} \right\}.$$

Then we have $D_R \subset \{|\eta| < R\}$ for a sufficiently small $\delta > 0$. We then see that

$$\frac{1}{R} \int_{D_R} |\tilde{v}(\eta)|^2 d\eta = \frac{1}{R} \int_{|\eta'| < \delta R} \int_{R/3}^{2R/3} |\tilde{v}(\eta_1, \eta')|^2 d\eta_1 d\eta' \leq \frac{1}{R} \int_{|\eta| < R} |\tilde{v}(\eta)|^2 d\eta.$$

As $R \rightarrow \infty$, the right-hand side tends to zero by (5.4), hence so does the left-hand side, which proves that $\lim_{\eta_1 \rightarrow \infty} \tilde{v}(\eta) = 0$. We have, therefore,

$$\tilde{v}(\eta) = -i \int_{\eta_1}^{\infty} \tilde{h}(s, \eta') ds.$$

Then $\tilde{v}(\eta)$ is rapidly decreasing as $\eta_1 \rightarrow \infty$. Similarly, $\tilde{v}(\eta)$ is rapidly decreasing as $\eta_1 \rightarrow -\infty$. Therefore, $v = \chi u \in C^\infty(\mathbf{T}^d)$.

It is easy to see that χu is smooth outside M_λ . We have thus proven $u \in C^\infty(M_{\lambda, reg}^{\mathbf{C}} \cap \mathbf{T}^d)$. In particular, $g(x) = 0$ on $M_{\lambda, reg}^{\mathbf{C}} \cap \mathbf{T}^d$. \square

Lemma 5.3. $g(z) = 0$ on $M_{\lambda, reg}^{\mathbf{C}}$.

Proof. Near any point in $M_{\lambda, reg}^{\mathbf{C}} \cap \mathbf{T}^d$, one can take local coordinates $(\zeta_1, \dots, \zeta_d)$ so that $M_{\lambda, reg}^{\mathbf{C}}$ is represented as $\zeta_d = 0$. Let $\zeta_j = s_j + it_j$. We expand $g|_{M_{\lambda, reg}^{\mathbf{C}}}$ into a Taylor series:

$$g|_{M_{\lambda, reg}^{\mathbf{C}}} = \sum c_{n_1 \dots n_{d-1}} \zeta_1^{n_1} \dots \zeta_{d-1}^{n_{d-1}},$$

which vanishes for $t_1 = \dots = t_{d-1} = 0$. We then have $c_{n_1 \dots n_{d-1}} = 0$, hence $g(z)$ vanishes in a neighborhood of $M_{\lambda, reg}^{\mathbf{C}} \cap \mathbf{T}^d$. By virtue of **(A-1-2)** and the analytic continuation, $g(z)$ vanishes on $M_{\lambda, reg}^{\mathbf{C}}$ (see e.g. Corollary 7 of [34]). \square

Lemma 5.4. *The meromorphic function $g(z)/p(z, \lambda)$ is analytic on $\mathbf{T}_{\mathbf{C}}^d$.*

Proof. By Lemma 5.3, $g(z)/p(z, \lambda)$ is analytic near $M_{\lambda, reg}^{\mathbf{C}}$. This can be proven by taking $\zeta_d = p(z, \lambda)$ as one of local coordinates, and expand $g(z)$ into a power series. Then the singularities of $g(z)/p(z, \lambda)$ are on $M_{\lambda, sing}^{\mathbf{C}}$. However, since we have assumed $d \geq 2$ and **(A-1-1)**, the singularities are removable (for the proof, see e.g. Corollary 7.3.2 of [33]). \square

We pass to the variables $w_j = e^{iz_j}$, $j = 1, \dots, d$, and let $\mathbf{C}[w_1, \dots, w_d]$ be the ring of polynomials of w_1, \dots, w_d with coefficients in \mathbf{C} . The map

$$\mathbf{T}_{\mathbf{C}}^d \ni z \rightarrow w \in \mathbf{C}^d \setminus \bigcup_{j=1}^d A_j, \quad A_j = \{w \in \mathbf{C}^d ; w_j = 0\}$$

is biholomorphic, i.e. both of the mappings $z \rightarrow w$, $w \rightarrow z$ are holomorphic. Let us note that $p(z, \lambda)$ has the form

$$p(z, \lambda) = \sum_{\alpha \in \mathbf{Z}^d, |\alpha| \leq N} c_\alpha(\lambda) e^{i\alpha \cdot z}, \quad \overline{c_\alpha(\lambda)} = c_{-\alpha}(\lambda).$$

Letting $\gamma_j = \max_{|\alpha| \leq N} \alpha_j$, we factorize $p(z, \lambda)$ as

$$(5.5) \quad p(z, \lambda) = P(w, \lambda) \prod_{j=1}^d w_j^{-\gamma_j},$$

where $P(w, \lambda) \in \mathbf{C}[w_1, \dots, w_d]$. Note that $\gamma_j \geq 0$, and this is the minimum choice of γ_j for which the factorization (5.5) is possible. Similarly, we factorize $g(z)$ as

$$g(z) = G(w) \prod_{j=1}^d w_j^{-\beta_j},$$

where β_j is a non-negative integer and $G(w) \in \mathbf{C}[w_1, \dots, w_d]$.

Let us recall some basic facts for *analytic set* (see e.g. [34], or Chapter 1 of [7]). A subset $E \subset \mathbf{C}^d$ is called an analytic set if E is, in a neighborhood of each point $\in E$, the set of common zeros of a certain finite family of holomorphic functions. An analytic set $E = \cap_{1 \leq j \leq N} f_j^{-1}(0)$, f_j being analytic, splits into several parts : the set of regular points, which is an analytic submanifold with complex dimension $p =: \dim_{\mathbf{C}} E \leq d - 1$, and the singular locus, which is a union of the set of singular points and submanifolds with complex dimension $< p$. Note that the set of regular points of E is dense in E , and the singular locus of E is nowhere dense in E (see Lemma 6 of [34]).

Lemma 5.5. *Let $Z_\lambda = \{w \in \mathbf{C}^d; P(w, \lambda) = 0\}$. For $1 \leq j \leq d$, $\dim_{\mathbf{C}} A_j \cap Z_\lambda \leq d - 2$.*

Proof. Assume $j = 1$, and let $w' = (w_2, \dots, w_d)$. We rewrite $P(w, \lambda)$ as

$$P(w, \lambda) = P_0(w', \lambda) + P_1(w', \lambda)w_1 + \dots + P_m(w', \lambda)w_1^m,$$

where $P_\ell(w', \lambda) \in \mathbf{C}[w_2, \dots, w_d]$. If $\dim_{\mathbf{C}} A_1 \cap Z_\lambda = d - 1$, $P_0(w', \lambda) = 0$ on an open set in A_1 , hence it vanishes identically. Therefore, $P(w, \lambda) = w_1 Q(w, \lambda)$ with $Q(w, \lambda) \in \mathbf{C}[w_1, \dots, w_d]$. This implies

$$p(z, \lambda) = w_1 Q(w, \lambda) \prod_{j=1}^d w_j^{-\gamma_j} = Q(w, \lambda) \left(w_1^{-(\gamma_1-1)} \prod_{j=2}^d w_j^{-\gamma_j} \right).$$

This contradicts the minimum choice of γ_1 in (5.5). \square

We now observe

$$(5.6) \quad \frac{g(z)}{p(z, \lambda)} = \frac{G(w)}{P(w, \lambda)} \prod_{j=1}^d w_j^{\gamma_j - \beta_j}.$$

Since $g(z)/p(z, \lambda)$ is analytic, $G(w)/P(w, \lambda)$ is analytic except possibly on hyperplanes, A_j , $j = 1, \dots, d$. In view of Lemma 5.5, we then see that $G(w)/P(w, \lambda)$ is analytic except on some set of complex dimension at most $d - 2$, which are removable singularities. For the proof, see e.g. Corollary 7.3.2 of [33]. We have, therefore,

- $G(w)/P(w, \lambda)$ is an entire function.

In particular,

- $G(w) = 0$ on the set $\{w \in \mathbf{C}^d; P(w, \lambda) = 0\}$.

We factorize $P(w, \lambda)$ so that

$$P(w, \lambda) = P^{(1)}(w, \lambda) \cdots P^{(N)}(w, \lambda),$$

where each $P^{(j)}(w, \lambda)$ is an irreducible polynomial. We prove inductively that

$$G(w)/(P^{(1)}(w, \lambda) \cdots P^{(n)}(w, \lambda)) \text{ is a polynomial for } 1 \leq n \leq N.$$

Note that, since we know already that $G(w)/P(w, \lambda)$ is entire,

- $G(w)/P^{(1)}(w, \lambda) \cdots P^{(n)}(w, \lambda)$ is also entire,
- $G(w) = 0$ on the zeros of $P^{(1)}(w, \lambda) \cdots P^{(n)}(w, \lambda)$.

We make us of the Hilbert Nullstellensatz (see e.g [44]).

Lemma 5.6. *Suppose $f, g \in \mathbf{C}[w_1, \dots, w_d]$ and f is irreducible. If $g = 0$ on all zeros of f , there exists $h \in \mathbf{C}[w_1, \dots, w_d]$ such that $g = fh$.*

Consider the case $n = 1$. Since $G(w) = 0$ on the zeros of $P^{(1)}(w, \lambda)$, Lemma 5.6 implies that $G(w)/P^{(1)}(w, \lambda)$ is a polynomial.

Assuming the case $n \leq \ell - 1$, we consider the case $n = \ell$. By the induction hypothesis, there exists a polynomial $P_{\ell-1}(w, \lambda)$ such that

$$\frac{G(w)}{P^{(1)}(w, \lambda) \cdots P^{(\ell-1)}(w, \lambda)} = P_{\ell-1}(w, \lambda).$$

Then we have $G(w)/(P^{(1)}(w, \lambda) \cdots P^{(\ell)}(w, \lambda)) = P_{\ell-1}(w, \lambda)/P^{(\ell)}(w, \lambda)$. This is entire. Therefore, $P_{\ell-1}(w, \lambda) = 0$ on the zeros of $P^{(\ell)}(w, \lambda)$. By Lemma 5.6, there exists a polynomial $Q^{(\ell)}(w, \lambda)$ such that

$$\frac{P_{\ell-1}(w, \lambda)}{P^{(\ell)}(w, \lambda)} = Q^{(\ell)}(w, \lambda).$$

Therefore, $G(w)/(P^{(1)}(w, \lambda) \cdots P^{(n)}(w, \lambda))$ is a polynomial for $1 \leq n \leq N$. Taking $n = N$, we have that $G(w)/P(w, \lambda)$ is a polynomial of w , hence $g(z)/p(z, \lambda)$ is a polynomial of e^{iz_j} by (5.6). This implies that $u(z)$ is a trigonometric polynomial. We have thus completed the proof of Theorem 5.1. \square

5.2. Thresholds. Let $\lambda_1(x) \leq \lambda_2(x) \leq \dots \leq \lambda_s(x)$ be the eigenvalues of $H_0(x)$, and

$$(5.7) \quad M_{\lambda, j} = \{x \in \mathbf{T}^d; \lambda_j(x) = \lambda\}.$$

Then we have

$$(5.8) \quad p(x, \lambda) = \prod_{j=1}^s (\lambda_j(x) - \lambda),$$

$$(5.9) \quad M_\lambda = \bigcup_{j=1}^s M_{\lambda, j}.$$

To study the spectral properties of H_0 , we need another series of assumptions :

There is a finite set $\mathcal{T}_0 \subset \sigma(H_0)$ such that

$$(A-2) \quad M_{\lambda, i} \cap M_{\lambda, j} = \emptyset, \quad \text{if } i \neq j, \quad \lambda \in \sigma(H_0) \setminus \mathcal{T}_0.$$

$$(A-3) \quad \nabla_x p(x, \lambda) \neq 0, \quad \text{on } M_\lambda, \quad \lambda \in \sigma(H_0) \setminus \mathcal{T}_0.$$

The assumption (A-2) implies that the eigenvalues are distinct in a neighborhood of M_λ if $\lambda \in \sigma(H_0) \setminus \mathcal{T}_0$, moreover $H_0(x)$ is smoothly diagonalizable. By (A-2), (5.8) and (5.9), the assumption (A-3) is equivalent to

$$\nabla_x \lambda_j(x) \neq 0, \quad \text{on } M_{\lambda,j}, \quad \lambda \in \sigma(H_0) \setminus \mathcal{T}_0.$$

We use (A-2) and (A-3) in the proof of limiting absorption principle for the resolvent (see §6).

Let us examine the assumptions (A-1), (A-2), (A-3) for the examples in §3. Let $a_d(x)$, $b_d(x)$ be defined by (2.9) and (2.10). In view of Lemma 2.1, for $H_0(x) = a_d(x)$, we can take

$$\mathcal{T}_0 = SV(a_d), \quad \mathcal{T}_1 = \{-d, d\}.$$

By Lemma 2.2, for $H_0(x) = b_d(x)$, we can take

$$\mathcal{T}_0 = SV(b_d), \quad \mathcal{T}_1 = \{-(d+1)/2, d(d+1)/2\}.$$

Therefore, we have

- for the d -dim. square lattice

$$\mathcal{T}_0 = \{n/d; -d \leq n \leq d\}, \quad \mathcal{T}_1 = \{-1, 1\},$$

- for the triangular lattice

$$\mathcal{T}_0 = \{-1, 1/3, 1/2\}, \quad \mathcal{T}_1 = \{-1, 1/2\},$$

- for the hexagonal lattice

$$\mathcal{T}_0 = \{-1, -1/3, 0, 1/3, 1\}, \quad \mathcal{T}_1 = \{-1, 0, 1\},$$

- for the Kagome lattice

$$\mathcal{T}_0 = \{-1, -1/4, -1/2, 0, 1/2\}, \quad \mathcal{T}_1 = \{-1, -1/4, 1/2\},$$

- for the d -dim. diamond lattice,

$$\mathcal{T}_0 = \begin{cases} \{\pm(\ell+1)/(d+1); \ell = d, d-2, \dots, -d\} \cup \{0\}, & \text{if } d = \text{even}, \\ \{\pm(\ell+1)/(d+1); \ell = d, d-2, \dots, -d\}, & \text{if } d = \text{odd}, \end{cases}$$

$$\mathcal{T}_1 = \{-1, 0, 1\},$$

- for the subdivision of d -dim. square lattice \mathbf{Z}^d ,

$$\mathcal{T}_0 = \{0, \pm n/d; n = 1, 2, \dots, d\}, \quad \mathcal{T}_1 = \{0, \pm 1\}.$$

Attention must be paid to the ladder of the square lattice \mathbf{Z}^d in \mathbf{R}^{d+1} and the graphite. For both the cases, some connected component of $M_\lambda^{\mathbf{C}}$ has no intersection with \mathbf{T}^d . We have

- for the ladder of the square lattice \mathbf{Z}^d in \mathbf{R}^{d+1} ,

$$\mathcal{T}_0 = \left\{ -1, \frac{-2d+1}{2d+1}, \frac{-2d+3}{2d+1}, \dots, \frac{2d-1}{2d+1}, 1 \right\}, \quad \mathcal{T}_1 = \left\{ \frac{2d-1}{2d+1} \leq |\lambda| \leq 1 \right\},$$

- for the graphite

$$\mathcal{T}_0 = \{0, \pm 1/4, \pm 1/2, \pm 1\}, \quad \mathcal{T}_1 = \{1/2 \leq |\lambda| \leq 1\}.$$

5.3. Unique continuation property. As in the case of differential operators, the unique continuation property is a delicate issue for Laplacians on periodic lattices. In this paper, we do not pursue the general condition for it, but assume it in the following form.

(A-4) Suppose \widehat{u} satisfies $(\widehat{H}_0 - \lambda)\widehat{u} = 0$ on \mathcal{V}_0 for some constant $\lambda \in \mathbf{C}$. If there exists $R_0 > 0$ such that $\widehat{u} = 0$ for $|n| > R_0$, then $\widehat{u} = 0$ on \mathcal{V}_0 .

Theorem 5.1 then implies the following theorem.

Theorem 5.7. *Assume (A-1) and (A-4). Suppose $\widehat{u}(n)$ satisfies $(\widehat{H}_0 - \lambda)\widehat{u} = 0$ on \mathcal{V}_0 for some $\lambda \in \sigma(\widehat{H}_0) \setminus \mathcal{T}_1$. If*

$$\lim_{R \rightarrow \infty} \frac{1}{R} \sum_{|n| < R} |\widehat{u}(n)|^2 = 0,$$

then, $\widehat{u} = 0$ identically on \mathcal{V}_0 . In particular, \widehat{H}_0 has no eigenvalue in $\sigma(\widehat{H}_0) \setminus \mathcal{T}_1$.

The validity of the unique continuation property (A-4) depends largely on the geometry of the lattice. We give here an algebraic condition to guarantee (A-4).

Lemma 5.8. *Suppose there exists a polynomial $f(z, \lambda)$ such that $p(x, \lambda)$ is written as $p(x, \lambda) = f(a_d(x), \lambda)$ or $p(x, \lambda) = f(b_d(x), \lambda)$. If $p(x, \lambda)$ is a non-zero polynomial, $\widehat{H}_0 - \lambda$ has the unique continuation property (A-4).*

Proof. Passing to the torus, and multiplying the cofactor matrix of $H_0(x) - \lambda$, we obtain the equation $p(x, \lambda)u = 0$. Returning to the lattice, \widehat{u} satisfies

$$(5.10) \quad \widehat{P}(\lambda)\widehat{u} = 0,$$

where $\widehat{P}(\lambda)$ is defined by $p(x, \lambda)$ with e^{-ix_j} , e^{ix_j} replaced by shift operators \widehat{S}_j , \widehat{S}_j^* , respectively.

We let

$$\widehat{S} = \sum_{j=1}^d (\widehat{S}_j + \widehat{S}_j^*), \quad \widehat{T} = \sum_{1 \leq j < k \leq d} (\widehat{S}_j \widehat{S}_k^* + \widehat{S}_k \widehat{S}_j^*).$$

Then $2a_d(x)$ and $2b_d(x)$ correspond to \widehat{S} and $-d - 1 + \widehat{S} + \widehat{T}$, respectively. By the assumption of Lemma 5.8, the equation (5.10) is rewritten as either

$$(5.11) \quad \sum_{p=0}^N c_p \widehat{S}^p \widehat{u} = 0,$$

or

$$(5.12) \quad \sum_{p=0}^N c_p (\widehat{S} + \widehat{T})^p \widehat{u} = 0,$$

where c_p is a constant and $c_N = 1$.

The case (5.11). For $n \in \mathbf{Z}^d$, we put

$$(5.13) \quad \begin{aligned} D_n &= \{n - \mathbf{e}_1, \widehat{S}_j(n - \mathbf{e}_1), \widehat{S}_j^*(n - \mathbf{e}_1); j = 1, \dots, d\} \\ &= \{n - \mathbf{e}_1 \pm \mathbf{e}_j; j = 1, \dots, d\}, \end{aligned}$$

$$(5.14) \quad \Omega_n = \{\ell \in \mathbf{Z}^d; \sum_{j=2}^d |n_j - \ell_j| \leq n_1 - \ell_1\}.$$

Geometrically, Ω_n is a cone with vertex n , and related with D_n as follows. We define

$$D_k \prec D_\ell \iff \ell \in D_k \setminus \{k\}.$$

Then starting from D_n , one can construct a chain of D_k 's satisfying

$$D_n \prec D_k \prec D_{k'} \prec \cdots .$$

Ω_n is the union of such chains.

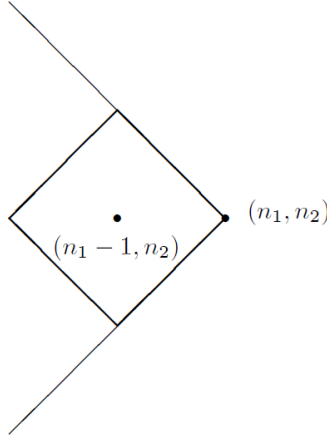

FIGURE 11. D_n and Ω_n

Note that, although $\hat{u}(n)$ is defined on the multiple lattice \mathcal{V}_0 , each component $\hat{u}_i(n)$ is a function on a single lattice \mathbf{Z}^d . Evaluating the equation (5.11) at $k \in \mathbf{Z}^d$, we see that $\hat{u}_i(k + N\mathbf{e}_1)$ is written by a linear combination of $\hat{u}_i(\ell)$ for $\ell \in \Omega_{k+N\mathbf{e}_1}$, and $\hat{u}_i(\ell)$ is written as a linear combination of $\hat{u}_i(m)$, where $m \in \Omega_\ell$. This procedure can be repeated as long as possible. Now suppose $\hat{u}_i(k) = 0$ near infinity. By the above procedure, we then see that $\hat{u}_i(n) = 0$. Hence $\hat{u} = 0$ identically.

The case (5.12). We define

$$D_n = \{\hat{S}_j(n - \mathbf{e}_1), \hat{S}_j^*(n - \mathbf{e}_1), \hat{S}_i \hat{S}_j^*(n - \mathbf{e}_1), \hat{S}_i^* \hat{S}_j(n - \mathbf{e}_1); 1 \leq i, j \leq d\},$$

$$\Omega_n = \{\ell \in \mathbf{Z}^d; \ell_1 \leq n_1, \ell_i + \ell_j \leq n_i + n_j, 1 \leq i, j \leq d\}.$$

Then, the same argument works also for this case. \square

As has been computed in §3, all of our examples satisfy the assumption of Lemma 5.8, hence have the unique continuation property. Note that $p(x, 1/2) = 0$ for the Kagome lattice by (3.24), and $p(x, 0) = 0$ for the subdivision by (3.53). Later, we show that $\sigma_p(\hat{H}_0) = \{1/2\}$ for the Kagome lattice, and $\sigma_p(\hat{H}_0) = \{0\}$ for the subdivision. See (5.17) and (5.18).

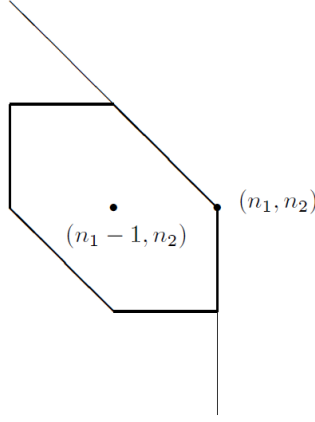
 FIGURE 12. D_n and Ω_n

We can also add perturbations by scalar potentials. Here, by a scalar potential on a graph $\Gamma = \{\mathcal{V}, \mathcal{E}\}$, we mean an operator \widehat{V} such that

$$(\widehat{V}f)(v) = \widehat{V}(v)f(v), \quad \forall v \in \mathcal{V},$$

where $\widehat{V}(v) \in \mathbf{C}$. First let us consider the diamond lattice.

Lemma 5.9. *Let \widehat{H}_0 be the Laplacian on the d -dimensional diamond lattice, where $d \geq 2$, and \widehat{V} a compactly supported scalar potential. Then $\widehat{H} = \widehat{H}_0 + \widehat{V}$ has the unique continuation property (A-4).*

Proof. Suppose $(\widehat{H}_0 - \lambda)\widehat{u} = -\widehat{V}\widehat{u}$. Taking account of (3.44) and multiplying this equation by the matrix

$$\widehat{C}_0 = \begin{pmatrix} 0 & 1 + \widehat{S}_1^* + \cdots + \widehat{S}_d^* \\ 1 + \widehat{S}_1 + \cdots + \widehat{S}_d & 0 \end{pmatrix},$$

we have

$$(5.15) \quad \sum_i (\widehat{u}(n + \mathbf{e}_i) + \widehat{u}(n - \mathbf{e}_i)) + \sum_{i < j} (\widehat{u}(n + \mathbf{e}_i - \mathbf{e}_j) + \widehat{u}(n + \mathbf{e}_j - \mathbf{e}_i)) \\ = c_1 \widehat{u}(n) + c_2 \left(\widehat{C}_0 \widehat{V} \widehat{u} \right) (n),$$

where c_i is a constant. The right-hand side is rewritten as

$$(5.16) \quad c_1 \begin{pmatrix} \widehat{u}_1(n) \\ \widehat{u}_2(n) \end{pmatrix} + c_2 \begin{pmatrix} \widehat{u}_2(n) + \sum_{j=1}^d b(n + \mathbf{e}_j) \widehat{u}_2(n + \mathbf{e}_j) \\ \widehat{u}_1(n) + \sum_{j=1}^d a(n - \mathbf{e}_j) \widehat{u}_1(n - \mathbf{e}_j) \end{pmatrix},$$

where $a(n), b(n) \in \mathbf{C}$. To prove the lemma, we have only to show that if $\widehat{u}(n) = 0$ for all $n = (n_1, n')$ such that $n_1 < k_1$, then $\widehat{u}(k_1, n') = 0$ for all $n' \in \mathbf{Z}^{d-1}$. Let

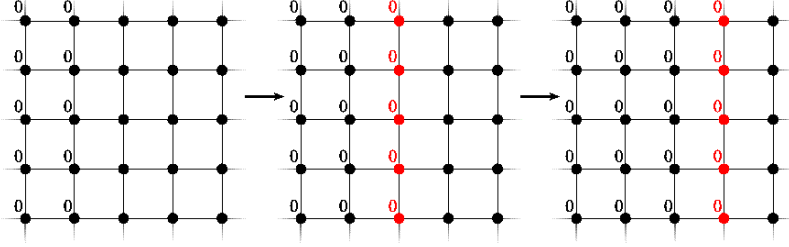

FIGURE 13. The unique continuation on the square lattice.

$n_1 = k_1 - 1$ in (5.15), and take the lower component. Since the right-hand side vanishes, we have

$$\widehat{u}_2(k_1, n') + \sum_{j=2}^d \widehat{u}_2(k_1, n' - \mathbf{e}_j) = 0, \quad \forall n'.$$

In \mathbf{Z}^{d-1} , consider a cone with vertex n' :

$$C(n') = \{m' = (m'_2, \dots, m'_d); m'_i \leq n'_i, 2 \leq i \leq d\}.$$

Since $\widehat{u}_2(k_1, m') = 0$ near infinity of $C(n')$, one can show inductively that $\widehat{u}_2(k_1, n') = 0$. Taking the upper component, we then have

$$\widehat{u}_1(k_1, n') + \sum_{j=2}^d \widehat{u}_1(k_1, n' - \mathbf{e}_j) = 0, \quad \forall n'.$$

Arguing as above, we have $\widehat{u}_1(k_1, n') = 0$. This proves the lemma. \square

We consider the other examples.

Theorem 5.10. *Let \widehat{H}_0 be the Laplacian of one of the following lattices: square lattice, triangular lattice, d -dimensional diamond lattice ($d \geq 2$), ladder of d -dimensional square lattice, graphite in \mathbf{R}^3 . Let \widehat{V} be a complex-valued compactly supported scalar potential. Then $\widehat{H} = \widehat{H}_0 + \widehat{V}$ has the unique continuation property (A-4). In particular, \widehat{H} has no eigenvalue in $\sigma(\widehat{H}_0) \setminus \mathcal{T}_1$.*

This theorem is proven by observing the figure of the graph, and the idea of the proof is similar to the case of square lattice given in [26]. (See the Figure 13.) We enlarge the region on which $\widehat{u} = 0$ step by step by using the equation $(\widehat{H} - \lambda)\widehat{u} = 0$. Let us illustrate it for the hexagonal lattice, although this is the case of $d = 2$ in Lemma 5.9. From the equation $-\widehat{\Delta}_\Gamma \widehat{u} + (\widehat{V} - \lambda)\widehat{u} = 0$, one obtains

$$\widehat{u}_2(n_1, n_2 - 1) = -\widehat{u}_2(n_1 - 1, n_2) - \widehat{u}_2(n_1, n_2) + 3 \left(\widehat{V}(n_1, n_2) - \lambda \right) \widehat{u}_1(n_1, n_2),$$

$$\widehat{u}_1(n_1 + 1, n_2) = -\widehat{u}_1(n_1, n_2 + 1) - \widehat{u}_1(n_1, n_2) + 3 \left(\widehat{V}(n_1, n_2) - \lambda \right) \widehat{u}_2(n_1, n_2).$$

The left-hand side vanishes, if so does each term of the right-hand side, and this occurs by the assumption that $\widehat{u}(n) = 0$ near infinity and the induction procedure. (See the Figure 14.)

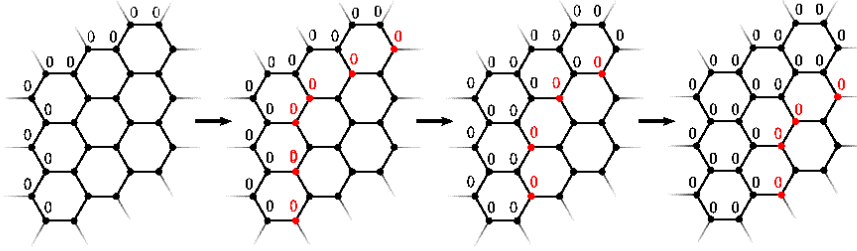

FIGURE 14. The unique continuation on the hexagonal lattice.

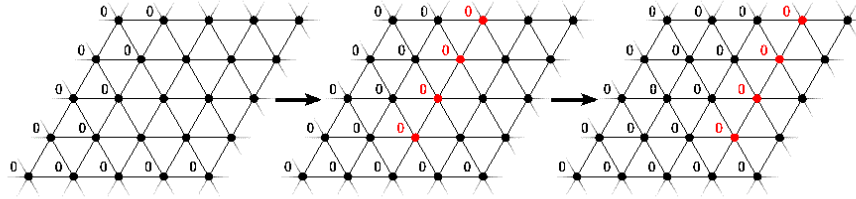

FIGURE 15. The unique continuation on the triangular lattice.

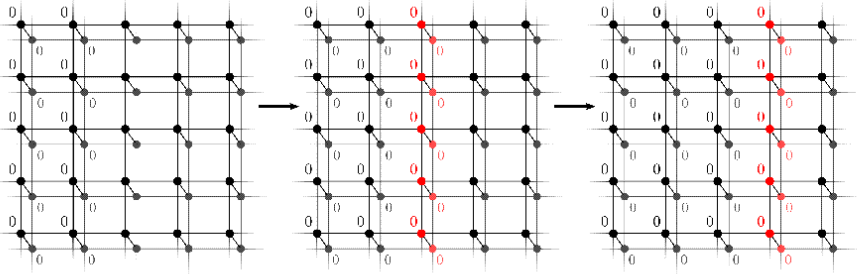

FIGURE 16. The unique continuation on the square ladder.

In the case of the triangular lattice and the square ladder, the unique continuation procedure is illustrated in Figures 15 and 16, respectively. We omit the proof for the graphite, which can be easily imagined by comparing Figures 14 and 9.

The Figure 17 shows the reason why this procedure does not work for the case of the Kagome lattice. In fact, for the potential

$$\widehat{V}(n) = \begin{cases} v, & \text{if } n = x_j, \quad j = 1, 2, \dots, 6, \\ 0, & \text{otherwise,} \end{cases}$$

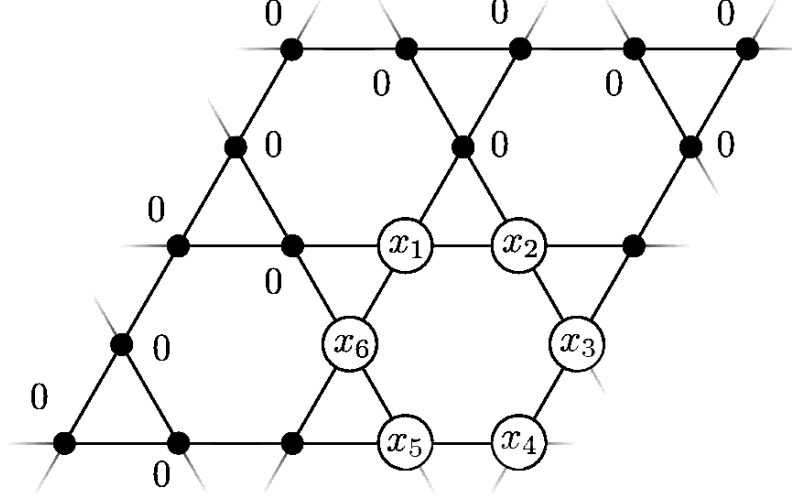

FIGURE 17. The unique continuation fails on the Kagome lattice.

v being an arbitrary constant, we have an eigenvalue $\lambda_v = v + 1/2$ with the compactly supported eigenvector

$$\widehat{u}(n) = \begin{cases} (-1)^j, & \text{if } n = x_j, \quad j = 1, 2, \dots, 6 \\ 0, & \text{otherwise.} \end{cases}$$

Letting $v = 0$, we get that

$$(5.17) \quad \sigma_p(\widehat{H}_0) = \{1/2\}$$

for the Kagome lattice. Note that if $-3/2 < v < 0$, $\lambda_v = v + 1/2$ is an embedded eigenvalue for the non-zero potential \widehat{V} . See [46] for the case of $\widehat{V} \equiv 0$.

The unique continuation also fails for the subdivision, which is illustrated in the Figure 18 for the 2-dimensional square lattice case. In fact, the potential

$$\widehat{V}(n) = \begin{cases} v, & \text{if } n = x_j, \quad j = 1, 2, 3, 4, \\ 0, & \text{otherwise,} \end{cases}$$

v being an arbitrary constant, has an eigenvalue $\lambda_v = v$ with the compactly supported eigenvector

$$\widehat{u}(n) = \begin{cases} (-1)^j, & \text{if } n = x_j, \quad j = 1, 2, 3, 4, \\ 0, & \text{otherwise.} \end{cases}$$

Letting $v = 0$, we have

$$(5.18) \quad \sigma_p(\widehat{H}_0) = \{0\}$$

for the subdivision.

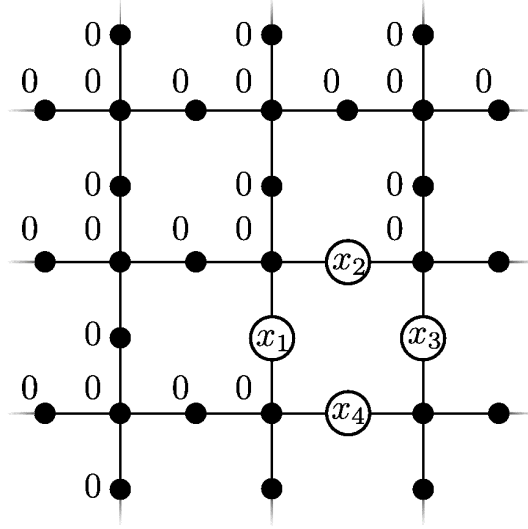

FIGURE 18. The unique continuation fails on the subdivision of 2-dimensional square lattice.

5.4. **A counter example.** The assumption **(A-1-2)** is characteristic in its topological feature. For the case of differential operators, Hörmander [18] imposed a similar assumption and also proved that it is necessary for the Rellich type theorem. In the discrete case, we can construct examples showing the necessity of excluding the set \mathcal{T}_1 .

Consider the Hamiltonian \widehat{H}_0 for the ladder of the square lattice in \mathbf{R}^{d+1} (Subsection 3.8). We add a scalar potential \widehat{V} to \widehat{H}_0 , where $\widehat{V}(0) = c$, $\widehat{V}(n) = 0$ for $n \neq 0$, c being a real constant yet to be determined. Then the eigenvalue problem is rewritten as $(\widehat{H}_0(n) - \lambda)\widehat{u}(n) = -c\widehat{u}(0)\delta_{n0}$, where $\delta_{n0} = 1$ for $n = 0$, $\delta_{n0} = 0$ for $n \neq 0$, i.e.

$$\left(-\frac{2}{2d+1} \sum_{j=1}^d \cos x_j - \lambda\right)u_1(x) - \frac{1}{2d+1}u_2(x) = -\frac{c}{2\pi}\widehat{u}_1(0),$$

$$\left(-\frac{2}{2d+1} \sum_{j=1}^d \cos x_j - \lambda\right)u_2(x) - \frac{1}{2d+1}u_1(x) = -\frac{c}{2\pi}\widehat{u}_2(0).$$

We seek the solution in the form $u_1(x) = \pm u_2(x) =: v_{\pm}(x)$, and obtain

$$v_{\pm}(x) = c \frac{\widehat{v}_{\pm}(0)}{2\pi} \frac{1}{\frac{1}{2d+1}(\pm 1 + 2 \sum_{j=1}^d \cos x_j) + \lambda}.$$

If $\pm\lambda > (2d-1)/(2d+1)$, we take $v_{\pm}(x) = \left(\frac{1}{2d+1}(\pm 1 + 2 \sum_{j=1}^d \cos x_j) + \lambda\right)^{-1}$, and $c = 2\pi/\widehat{v}_{\pm}(0)$ to get the desired potential and eigenvector. Note that the associated eigenvector $\widehat{v}_{\pm}(n)$ is not compactly supported.

In the case of graphite, we consider the eigenvalue problem $(\widehat{H}_0 + \widehat{V})\widehat{u} = \lambda\widehat{u}$, where the scalar potential is $\widehat{V}(0) = (c_1, c_2, c_1, c_2)$, $\widehat{V}(n) = 0$ for $n \neq 0$. We rewrite it as

$$\begin{cases} -\frac{1}{4} \begin{pmatrix} 0 & \overline{c(x)} \\ c(x) & 0 \end{pmatrix} - \lambda \end{cases} \begin{pmatrix} u_1(x) \\ u_2(x) \end{pmatrix} - \frac{1}{4} \begin{pmatrix} u_3(x) \\ u_4(x) \end{pmatrix} = \frac{1}{2\pi} \begin{pmatrix} c_1 \widehat{u}_1(0) \\ c_2 \widehat{u}_2(0) \end{pmatrix}, \\ \begin{cases} -\frac{1}{4} \begin{pmatrix} 0 & \overline{c(x)} \\ c(x) & 0 \end{pmatrix} - \lambda \end{cases} \begin{pmatrix} u_3(x) \\ u_4(x) \end{pmatrix} - \frac{1}{4} \begin{pmatrix} u_1(x) \\ u_2(x) \end{pmatrix} = \frac{1}{2\pi} \begin{pmatrix} c_1 \widehat{u}_3(0) \\ c_2 \widehat{u}_4(0) \end{pmatrix}, \end{cases}$$

where $c(x)$ is defined by (3.67). Putting $u_1(x) = \pm u_3(x) = v_{\pm,1}(x)$ and $u_2(x) = \pm u_4(x) = v_{\pm,2}(x)$, we obtain

$$-\frac{1}{4} \begin{pmatrix} 4\lambda \pm 1 & \overline{c(x)} \\ c(x) & 4\lambda \pm 1 \end{pmatrix} \begin{pmatrix} v_{\pm,1}(x) \\ v_{\pm,2}(x) \end{pmatrix} = \frac{1}{2\pi} \begin{pmatrix} c_1 v_{\pm,1}(0) \\ c_2 v_{\pm,2}(0) \end{pmatrix},$$

which is solved as

$$\begin{pmatrix} v_{\pm,1}(x) \\ v_{\pm,2}(x) \end{pmatrix} = \frac{1}{\left(\frac{3}{4}\right)^2 \left\{ \left(\frac{4}{3}\lambda \pm \frac{1}{3}\right)^2 - \frac{\alpha(x)}{9} \right\}} \left(-\frac{1}{8\pi}\right) \begin{pmatrix} 4\lambda \pm 1 & -\overline{c(x)} \\ -c(x) & 4\lambda \pm 1 \end{pmatrix} \begin{pmatrix} c_1 v_{\pm,1}(0) \\ c_2 v_{\pm,2}(0) \end{pmatrix},$$

where $\alpha(x)$ is defined by (3.20). Note that the characteristic polynomial of the Hamiltonian on the hexagonal lattice (3.19) appears in the dominator with λ replaced by $4\lambda/3 \pm 1/3$. If $\pm\lambda > 1/2$, choosing $c_j = -8\pi/v_{\pm,j}(0)$, $j = 1, 2$, we have the desired potential and eigenvectors which are not compactly supported.

Due to the formula (3.78), the same argument as above works for the ladder $Lad(\Gamma)$ of k -regular periodic graph Γ . The characteristic polynomial of the associated Hamiltonian is given by (3.79) using that on Γ .

Summing up the arguments in this subsection, we have

Theorem 5.11. *Let Γ be a k -regular periodic graph, and $Lad(\Gamma)$ the ladder of Γ . Then we have*

- (1) *For any $\lambda \in (-1, -\frac{k-1}{k+1}) \cap \sigma(\widehat{H}_0)$, there exists $0 \neq \widehat{v} \in L^2(\mathbf{T}^d) \subset \mathcal{B}_0^*$ satisfying $(\widehat{H}_0 - \lambda)\widehat{v} = 0$ in $|n| > R_0$ for sufficiently large R_0 .*
- (2) *For any $\lambda \in (-1, -\frac{k-1}{k+1}) \cap \sigma(\widehat{H}_0)$, there exists a compactly supported potential \widehat{V} such that λ is an eigenvalue of $\widehat{H}_0 + \widehat{V}$.*
- (3) *Let $\sigma_{max} := \max(\sigma(\widehat{H}_0) \setminus \sigma_p(\widehat{H}_0))$. Then, the assertions (1) and (2) hold with $(-1, -\frac{k-1}{k+1})$ replaced by $(\frac{k\sigma_{max}-1}{k+1}, \sigma_{max})$.*

Remark 5.12. Let $\lambda_1(x) \leq \lambda_2(x) \leq \dots \leq \lambda_s(x)$ be the eigenvalues of $H_0(x)$ as in Subsection 5.2. Then $\lambda_1(x)$ attains its minimum at $x = 0 \in \mathbf{T}^d$ and $\lambda_1(0) = -1$, which is a simple eigenvalue of $H_0(0)$ with a constant eigenfunction. Moreover, the Hessian of $\lambda_1(x)$ at $x = 0 \in \mathbf{T}^d$ is positive definite. Therefore, $\inf \sigma(\widehat{H}_0) = -1$ and $[-1, -1 + \epsilon] \subset \sigma(\widehat{H}_0)$ for some $\epsilon > 0$. See e.g. [31].

Remark 5.13. We cannot take σ_{max} as $\max \sigma(\widehat{H}_0)$, since it could be an isolated eigenvalue with ∞ -multiplicity and the interval in (3) might be empty. Such an example of periodic graph is $L(L(\Gamma))$, i.e. the line graph of the line graph of a k -regular periodic graph Γ with $k \geq 3$. See [46].

Let us further remark here that [45] obtains the eigenfunctions for embedded eigenvalues with unbounded support in a way very similar to above on periodic combinatorial graphs. Note also the construction of eigenfunctions with such properties on periodic metric graphs given there.

6. SPECTRAL PROPERTIES OF THE FREE HAMILTONIAN

6.1. Resolvent estimates. We now study H_0 in $(L^2(\mathbf{T}^d))^s$ under the assumptions (A-1), (A-2), (A-3). The eigenvalues of $H_0(x)$ are arranged so that $\lambda_1(x) \leq \dots \leq \lambda_s(x)$, and assumed to be distinct on M_λ . Let $P_j(x)$ be the eigenprojection associated with $\lambda_j(x)$. Take a compact interval $J \subset \sigma(H_0) \setminus \mathcal{T}_0$ and let U^{ϵ_0} be an ϵ_0 -neighborhood of $\cup_{\lambda \in J} M_\lambda$. Then $P_j(x) \in C^\infty(U^{\epsilon_0})$ for a sufficiently small $\epsilon_0 > 0$. We fix $\lambda \in J$, and take $x_0 \in M_\lambda$. Let $\chi \in C_0^\infty(U^{\epsilon_0})$ such that $\chi(x) = 1$ on a small neighborhood of x_0 . Then, letting $u = R_0(z)f$, we have

$$(\lambda_j(x) - z)\chi(x)P_j u(x) = \chi(x)P_j f(x).$$

We can then apply Lemma 4.7 to obtain the following theorem.

Theorem 6.1. (1) For $f \in \mathcal{B}$ and $\lambda \in \sigma(H_0) \setminus \mathcal{T}_0$, there exists a weak $*$ limit, $\lim_{\epsilon \rightarrow 0} R_0(\lambda \pm i\epsilon)f =: R_0(\lambda \pm i0)f$, i.e.

$$(R_0(\lambda \pm i\epsilon)f, g) \rightarrow (R_0(\lambda \pm i0)f, g), \quad \forall g \in \mathcal{B}.$$

(2) Moreover,

$$\|R_0(\lambda \pm i0)f\|_{\mathcal{B}^*} \leq C\|f\|_{\mathcal{B}},$$

where the constant C is independent of λ when λ varies over a compact set in $\sigma(H_0) \setminus \mathcal{T}_0$.

(3) $R_0(\lambda \pm i0)f$ is weakly $*$ continuous in the sense that

$$\sigma(H_0) \setminus \mathcal{T}_0 \ni \lambda \rightarrow (R_0(\lambda \pm i0)f, g)$$

is continuous for $f, g \in \mathcal{B}$.

(4) Letting $u_\pm = R_0(\lambda \pm i0)f$, we have

$$WF^*(P_j u_\pm) \subset \{(x, \pm\omega_x); x \in M_{\lambda,j}\},$$

where $\omega_x \in S^{d-1} \cap T_x(M_{\lambda,j})^\perp$, and $\omega_x \cdot \nabla \lambda_j(x) < 0$,

$$P_j u_\pm \mp \frac{1}{\lambda_j(x) - \lambda \mp i0} \otimes \left((P_j f)|_{M_{\lambda,j}} \right) \in \mathcal{B}_0^*.$$

Proof. We take $h(x) = \lambda_j(x) - \lambda$ in Lemma 4.7. The independence of the constant C in (2) can be seen by examining the proof. The local uniformity of the convergence with respect to λ as $\epsilon \rightarrow 0$ implies the continuity in (3). The other assertions are direct consequences of Lemma 4.7. \square

A solution $u \in \mathcal{B}^*$ of the equation

$$(6.1) \quad (H_0(x) - \lambda)u = f \in \mathcal{B}$$

is outgoing (incoming) if it satisfies

$$(6.2) \quad \begin{aligned} &WF^*(P_j u) \subset \{(x, \omega_x); x \in M_{\lambda,j}\}, \\ &\left(WF^*(P_j u) \subset \{(x, -\omega_x); x \in M_{\lambda,j}\} \right) \end{aligned}$$

with ω_x satisfying $\omega_x \in S^{d-1} \cap T_x(M_{\lambda,j})^\perp$, and $\omega_x \cdot \nabla \lambda_j(x) < 0$.

The next lemma follows from Lemma 4.8.

Lemma 6.2. *Let $u \in \mathcal{B}^*$ be a solution to (6.1). Then u is outgoing (incoming) if and only if*

$$(6.3) \quad P_j(x)u(x) = \frac{P_j(x)f(x)}{\lambda_j(x) - \lambda - i0}, \quad \left(P_j(x)u(x) = \frac{P_j(x)f(x)}{\lambda_j(x) - \lambda + i0} \right).$$

For the outgoing (incoming) solution u_+ (u_-), we have

$$\operatorname{Im}(u_{\pm}, f) = \pm \pi \|f|_{M_{\lambda}}\|_{L^2(M_{\lambda})}^2.$$

Lemma 6.3. *Suppose $u \in \mathcal{B}^*$ satisfies $(H_0 - \lambda)u = f \in \mathcal{B}$ and one of the radiation conditions. If $\operatorname{Im}(u, f) = 0$, then $u \in \mathcal{B}_0^*$.*

This lemma follows from Theorem 6.1 (4) and Lemma 6.2. The following lemma is a direct consequence of Theorem 5.1 and Lemma 6.3.

Lemma 6.4. *Let $\lambda \in \sigma(H_0) \setminus \mathcal{T}_1$, and suppose $u \in \mathcal{B}^*$ satisfies $(H_0 - \lambda)u = 0$ in \mathbf{T}^d . Then, $u = 0$ if u satisfies the outgoing or incoming radiation condition.*

6.2. Spectral representation. We define a spectral representation of H_0 , which is essentially a diagonalization of H_0 . Let

$$\mathbf{h}_{\lambda,j} = L^2(M_{\lambda,j}, \mathbf{C}, dM_{\lambda,j}/|\nabla\lambda_j(x)|)$$

be the Hilbert space of \mathbf{C} -valued functions on $M_{\lambda,j}$ equipped with the inner product

$$(\phi, \psi) = \int_{M_{\lambda,j}} \phi(x)\overline{\psi(x)} \frac{dM_{\lambda,j}}{|\nabla\lambda_j(x)|}.$$

We let

$$\tilde{\mathbf{H}}_j = \{P_j(x)f(x); f(x) \in L^2(\mathbf{T}^d, \mathbf{C}^s, dx)\}.$$

By using an eigenvector $a_j(x) \in \mathbf{C}^s$ satisfying $H_0(x)a_j(x) = \lambda_j(x)a_j(x)$, $|a_j(x)| = 1$, we can rewrite

$$P_j(x)f(x) = (f(x) \cdot \overline{a_j(x)})a_j(x),$$

hence $\tilde{\mathbf{H}}_j = \{\alpha(x)a_j(x); \alpha(x) \in L^2(\mathbf{T}^d, \mathbf{C}, dx)\}$. One must note, however, that the eigenvector cannot be chosen uniquely. Therefore, we introduce an equivalent relation \sim for $(\alpha(x), a_j(x)), (\beta(x), b_j(x))$, where $\alpha(x), \beta(x) \in L^2(\mathbf{T}^d, \mathbf{C}, dx)$ and $a_j(x), b_j(x)$ are normalized eigenvectors for $H_0(x)$ associated with eigenvalue $\lambda_j(x)$,

$$(\alpha(x), a_j(x)) \sim (\beta(x), b_j(x)) \iff (\alpha(x) \cdot \overline{a_j(x)})a_j(x) = (\beta(x) \cdot \overline{b_j(x)})b_j(x).$$

Then $\tilde{\mathbf{H}}_j$ is the resulting equivalence class. Noting that

$$dx = \frac{dM_{\lambda,j}d\lambda}{|\nabla\lambda_j(x)|},$$

we identify $\tilde{\mathbf{H}}_j$ with

$$(6.4) \quad \mathbf{H}_j^{(0)} = L^2(I_j^{(0)}, \mathbf{h}_{\lambda,j}a_j, d\lambda),$$

$$I_j^{(0)} = \lambda_j(\mathbf{T}^d) \setminus \mathcal{T}_0,$$

where $\mathbf{h}_{\lambda,j}a_j = \{\alpha a_j|_{M_{\lambda,j}}; \alpha \in \mathbf{h}_{\lambda,j}\}$, $a_j(x)$ being the normalized eigenvector of $H_0(x)$. Finally, letting

$$I^{(0)} = \bigcup_{j=1}^s I_j^{(0)} = \sigma(H_0) \setminus \mathcal{T}_0,$$

we define $\mathbf{h}_{\lambda,j}$ and $\mathbf{H}_j^{(0)}$ to be $\{0\}$ for $\lambda \in I^{(0)} \setminus I_j^{(0)}$, and put

$$(6.5) \quad \mathbf{h}_\lambda = \mathbf{h}_{\lambda,1} a_1 \oplus \cdots \oplus \mathbf{h}_{\lambda,s} a_s,$$

$$(6.6) \quad \mathbf{H}^{(0)} = \mathbf{H}_1^{(0)} \oplus \cdots \oplus \mathbf{H}_s^{(0)} = L^2(I^{(0)}, \mathbf{h}_\lambda, d\lambda).$$

In the above definition of $\mathbf{H}_j^{(0)}$, $\mathbf{h}_{\lambda,j}$ depends also on λ . Since $M_{\lambda,j}$ is defined by $\lambda_j(x) = \lambda$, by splitting the interval $I_j^{(0)}$ into subintervals $I_{j,\ell}^{(0)}$ so that on each $I_{j,\ell}^{(0)}$, $M_{\lambda,j}$ is diffeomorphic to a fixed manifold $\mathcal{N}_{j,\ell}$, then $\mathbf{H}_j^{(0)}$ should be written as a direct sum $\oplus_\ell L^2(I_{j,\ell}^{(0)}, L^2(\mathcal{N}_{j,\ell}), d\mu_{j,\ell}(\lambda))$ for a suitable measure $d\mu_{j,\ell}(\lambda)$. For the sake of simplicity, however, we use the definition (6.4).

By Lemma 6.2, we have

$$P_j(R_0(\lambda + i0) - R_0(\lambda - i0)) = ((\lambda_j(x) - \lambda - i0)^{-1} - (\lambda_j(x) - \lambda + i0)^{-1})P_j.$$

In particular, we have the following Parseval formula :

$$(6.7) \quad \frac{1}{2\pi i} ((R_0(\lambda + i0) - R_0(\lambda - i0))f, g) = \sum_{j=1}^s \int_{M_{\lambda,j}} (P_j f)(x) \cdot \overline{(P_j g)(x)} \frac{dM_{\lambda,j}}{|\nabla \lambda_j(x)|}.$$

Using the distribution

$$(6.8) \quad \mathcal{E}'(\mathbf{R}^d) \ni \delta_{M_{\lambda,j}} : \varphi \rightarrow \langle \delta_{M_{\lambda,j}}, \varphi \rangle = \int_{M_{\lambda,j}} \varphi(x) \frac{dM_{\lambda,j}}{|\nabla \lambda_j(x)|},$$

we can rewrite (6.7) as

$$(6.9) \quad \frac{1}{2\pi i} (R_0(\lambda + i0) - R_0(\lambda - i0)) = \sum_{j=1}^s \delta_{M_{\lambda,j}} P_j.$$

With the above formulas in mind, we define

$$(6.10) \quad \mathcal{F}_0 : \mathcal{H}_0 \ni f \rightarrow (P_1 f, \dots, P_s f) \in \mathbf{H}^{(0)}.$$

Theorem 6.5. (1) \mathcal{F}_0 is a unitary operator from $(L^2(\mathbf{T}^d))^s$ to $\mathbf{H}^{(0)}$.

(2) For any $f \in \mathcal{H}_0$, $(\mathcal{F}_0 H_0 f)(\lambda) = \lambda(\mathcal{F}_0 f)(\lambda)$.

Let us further study

$$(6.11) \quad \mathcal{F}_0(\lambda)f = (\mathcal{F}_0 f)(\lambda) = (\mathcal{F}_{0,1}(\lambda)f, \dots, \mathcal{F}_{0,s}(\lambda)f) \in \mathbf{h}_\lambda.$$

More precisely,

$$(6.12) \quad \mathcal{F}_{0,j}(\lambda)f = \begin{cases} P_j(x)f(x) \Big|_{M_{\lambda,j}}, & \text{if } \lambda \in I_j^{(0)}, \\ 0, & \text{otherwise,} \end{cases}$$

$$(6.13) \quad \mathcal{F}_{0,j}(\lambda)^* \phi = \begin{cases} P_j(x)\phi(x) \otimes \delta_{M_{\lambda,j}}, & \text{if } \lambda \in I_j^{(0)}, \\ 0, & \text{otherwise.} \end{cases}$$

Then, by (6.7)

$$(6.14) \quad \frac{1}{2\pi i} ((R_0(\lambda + i0) - R_0(\lambda - i0))f, g) = (\mathcal{F}_0(\lambda)f, \mathcal{F}_0(\lambda)g)_{\mathbf{h}_\lambda}.$$

This implies

$$(6.15) \quad \|\mathcal{F}_0(\lambda)f\|_{\mathbf{h}_\lambda}^2 = \|f\|_{L^2(M_\lambda)}^2 = \sum_{j=1}^s \|P_j f\|_{L^2(M_{\lambda,j})}^2.$$

Lemma 6.6. *For any compact set $J \subset \sigma(H_0) \setminus \mathcal{T}_0$, there exists a constant $C > 0$ such that*

$$\|\mathcal{F}_0(\lambda)f\|_{\mathbf{h}_\lambda} \leq C\|f\|_{\mathcal{B}}, \quad \lambda \in J.$$

Proof. This follows from (6.7) and Theorem 6.1. \square

As a direct consequence of this lemma, we have

$$\mathcal{F}_0(\lambda)^* \in \mathbf{B}(\mathbf{h}_\lambda; \mathcal{B}^*).$$

By Theorem 6.5 (2), we have $\mathcal{F}_0(\lambda)(H_0 - \lambda)f = 0$, $\forall f \in \mathcal{B}$. Therefore

$$(6.16) \quad (H_0 - \lambda)\mathcal{F}_0(\lambda)^* = 0.$$

Multiplying the cofactor matrix from the left, we then obtain

$$p(x, \lambda)\mathcal{F}_0(\lambda)^* = 0,$$

which implies that $\text{supp } \mathcal{F}_0(\lambda)^*\phi \subset M_\lambda$ for any $\phi \in \mathbf{h}_\lambda$.

Lemma 6.7. *For any compact set $J \subset \sigma(H_0) \setminus \mathcal{T}_0$, there exists a constant $C > 0$ such that*

$$C^{-1}\|\phi\|_{\mathbf{h}_\lambda} \leq \|\mathcal{F}_0(\lambda)^*\phi\|_{\mathcal{B}^*} \leq C\|\phi\|_{\mathbf{h}_\lambda}, \quad \lambda \in J.$$

Proof. The estimate from above follows from Lemma 6.6. To prove the estimate from below, we have only to take ϕ in a dense set of \mathbf{h}_λ . Therefore, without loss of generality, we can assume that $T(x)^{-1}\phi$ is continuous where $T(x) := \bigoplus_{j=1}^s |\nabla \lambda_j(x)|$. We take a partition of unity $\{\chi_j\}$ on M_λ so that $\phi_j = \chi_j\phi$ has a small support. Let $u_j = \mathcal{F}_0(\lambda)^*\phi_j$ on the fundamental domain, and extend it to be 0 outside. Then, $u_j \in \mathcal{B}^*(\mathbf{R}^d)$ and one can apply Lemma 4.2 to get the estimate

$$\|\phi_j\|_{\mathbf{h}_\lambda} \leq C\|\mathcal{F}_0(\lambda)^*\phi_j\|_{\mathcal{B}^*}.$$

We can take a smooth extension $\tilde{\chi}_j \in C_0^\infty(\mathbf{R}^d)$ of χ_j so that $\mathcal{F}_0(\lambda)^*\phi_j = \tilde{\chi}_j\mathcal{F}_0(\lambda)^*\phi$. Then we have

$$\|\tilde{\chi}_j\mathcal{F}_0(\lambda)^*\phi\|_{\mathcal{B}^*} \leq C\|\mathcal{F}_0(\lambda)^*\phi\|_{\mathcal{B}^*},$$

hence

$$\|\phi\|_{\mathbf{h}_\lambda} \leq \sum_j \|\phi_j\|_{\mathbf{h}_\lambda} \leq \sum_j C\|\tilde{\chi}_j\mathcal{F}_0(\lambda)^*\phi\|_{\mathcal{B}^*} \leq C\|\mathcal{F}_0(\lambda)^*\phi\|_{\mathcal{B}^*},$$

which completes the proof of the lemma. \square

Lemma 6.8. *For $\lambda \in \sigma(H_0) \setminus \mathcal{T}_0$, $\mathcal{F}_0(\lambda)\mathcal{B} = \mathbf{h}_\lambda$.*

Proof. We use the following Banach's closed range theorem (see [51], p. 205).

Theorem 6.9. *Let X, Y be Banach spaces, and T a bounded operator from X to Y . Let $R(T) = \{Rx; x \in X\}$, $N(T) = \{x \in X; Tx = 0\}$, and denote the pairing between X and its dual space X^* by $\langle \cdot, \cdot \rangle$. Then the following 4 assertions are equivalent.*

- (1) $R(T)$ is closed.
- (2) $R(T^*)$ is closed.
- (3) $R(T) = N(T^*)^\perp = \{y \in Y; \langle y, y^* \rangle = 0, \forall y^* \in N(T^*)\}$.
- (4) $R(T^*) = N(T)^\perp = \{x^* \in X^*; \langle x, x^* \rangle = 0, \forall x \in N(T)\}$.

We take $X = \mathcal{B}, Y = \mathbf{h}_\lambda$ and $T = \mathcal{F}_0(\lambda)$. Then by Lemma 6.7, T^* is 1 to 1, and $R(T^*)$ is closed. Theorem 6.9 then implies that $R(T)$ is dense and closed. \square

Lemma 6.10. *For $\lambda \in \sigma(H_0) \setminus \mathcal{T}_0$, $\{u \in \mathcal{B}^*; (H_0 - \lambda)u = 0\} = \mathcal{F}_0(\lambda)^* \mathbf{h}_\lambda$.*

Proof. The inclusion relation $\{u \in \mathcal{B}^*; (H_0 - \lambda)u = 0\} \supset \mathcal{F}_0(\lambda)^* \mathbf{h}_\lambda$ is proven in (6.16). To prove the converse relation, in view of (4) of Theorem 6.9, we have only to prove

$$u \in \mathcal{B}^*, f \in \mathcal{B}, (H_0 - \lambda)u = 0, \mathcal{F}_0(\lambda)f = 0 \implies (u, f) = 0.$$

However, as has been seen before Lemma 6.7, $(H_0 - \lambda)u = 0$ implies $\text{supp } u \subset M_\lambda$. By Lemma 4.2, u is an L^2 -density on M_λ . Then (u, f) is an integral of $u(x)\overline{f(x)}$ on M_λ . However, the restriction of $f(x)$ to M_λ is 0. This proves the lemma. \square

Let us also mention the singularity expansion of the solution of the Helmholtz equation $(H_0 - \lambda)u = 0$. Let

$$(6.17) \quad A_\pm(\lambda) = \frac{1}{2\pi i} \sum_{j=1}^s \frac{1}{\lambda_j(x) - \lambda \mp i0} \otimes P_j(x) \Big|_{x \in M_{\lambda,j}}.$$

Then by (6.13),

$$(6.18) \quad \mathcal{F}_0(\lambda)^* = A_+(\lambda) - A_-(\lambda).$$

In view of Lemma 6.10, we obtain the following lemma.

Lemma 6.11. *Let $\lambda \in \sigma(H_0) \setminus \mathcal{T}_0$. Then for any solution $u \in \mathcal{B}^*$ of the equation $(H_0 - \lambda)u = 0$, there exists $\phi \in \mathbf{h}_\lambda$ such that*

$$u = A_+(\lambda)\phi - A_-(\lambda)\phi.$$

7. HAMILTONIAN ON THE PERTURBED LATTICE

7.1. Perturbed lattice. Let $\Gamma_0 = \{\mathcal{L}_0, \mathcal{V}_0, \mathcal{E}_0\}$ be the periodic graph given in Subsection 2.2. To *remove an edge e* from Γ_0 , we mean to remove e from the edge set \mathcal{E}_0 , but not to remove end points $o(e)$ and $t(e)$ of e from the vertex set \mathcal{V}_0 . To *remove a vertex v* from \mathcal{V}_0 , we mean to remove v from \mathcal{V}_0 as well as all edges having v as an end point. We can also perturb a lattice by adding vertexes and edges.

Now let us perturb a finite part of Γ_0 , and denote the resulting graph by $\Gamma = \{\mathcal{V}, \mathcal{E}\}$. Take a large **integer** $a > 0$, and put

$$(7.1) \quad \mathbf{Z}_{ext}^d = \mathbf{Z}^d \setminus \{n; |n_i| \leq a, 1 \leq i \leq d\},$$

$$(7.2) \quad \partial \mathbf{Z}_{ext}^d = \bigcup_{i=1}^d \{n \in \mathbf{Z}_{ext}^d; |n_i| = a\},$$

$$(7.3) \quad \mathcal{V}_{ext} = \bigcup_{j=1}^s \{p_j + \mathbf{v}(n); n \in \mathbf{Z}_{ext}^d\},$$

$$(7.4) \quad \partial \mathcal{V}_{ext} = \bigcup_{j=1}^s \{p_j + \mathbf{v}(n); n \in \partial \mathbf{Z}_{ext}^d\},$$

$$(7.5) \quad \mathcal{V}_{ext}^\circ = \mathcal{V}_{ext} \setminus \partial \mathcal{V}_{ext},$$

$$(7.6) \quad \mathcal{V}_{int} = \mathcal{V} \setminus \mathcal{V}_{ext}^\circ,$$

$$(7.7) \quad \partial \mathcal{V}_{int} = \partial \mathcal{V}_{ext},$$

$$(7.8) \quad \mathcal{V}_{int}^\circ = \mathcal{V}_{int} \setminus \partial \mathcal{V}_{int}.$$

Then, \mathcal{V} consists of a disjoint union of two parts :

$$\mathcal{V} = \mathcal{V}_{ext}^\circ \cup \mathcal{V}_{int}, \quad \#\mathcal{V}_{int} < \infty.$$

Accordingly, the Hilbert space $\ell^2(\mathcal{V})$ admits an orthogonal decomposition

$$\ell^2(\mathcal{V}) = \ell^2(\mathcal{V}_{ext}^\circ) \oplus \ell^2(\mathcal{V}_{int}).$$

The elements \hat{u} of $\ell^2(\mathcal{V}_{ext}^\circ)$ are written as vectors of s -components : $\hat{u}(n) = (\hat{u}_1(n), \dots, \hat{u}_s(n))$, $\hat{u}_i(n) \in \ell^2(\mathbf{Z}_{ext}^d)$, while $\hat{w} \in \ell^2(\mathcal{V}_{int})$ is simply a finite dimensional vector.

Let

$$\hat{P}_{ext} : \ell^2(\mathcal{V}) \rightarrow \ell^2(\mathcal{V}_{ext}^\circ), \quad \hat{P}_{int} : \ell^2(\mathcal{V}) \rightarrow \ell^2(\mathcal{V}_{int})$$

be the associated orthogonal projections, which are naturally extended to $\ell_{loc}^2(\mathcal{V})$.

Let $\hat{\Delta}_\Gamma$ be the Laplacian on the graph Γ , which is self-adjoint on $\ell^2(\mathcal{V})$.

7.2. Spectral properties for \hat{H} . We put

$$(7.9) \quad \hat{H} = -\hat{\Delta}_\Gamma + \hat{V},$$

and study its spectral properties. Let us repeat our assumptions (A-1) \sim (A-4) on the unperturbed lattice and add new assumptions (A-5), (A-6) on perturbations.

(A-1) *There exists a subset $\mathcal{T}_1 \subset \sigma(H_0)$ such that for $\lambda \in \sigma(H_0) \setminus \mathcal{T}_1$:*

(A-1-1) *$M_{\lambda, sng}^C$ is discrete.*

(A-1-2) *Each connected component of $M_{\lambda, reg}^C$ intersects with \mathbf{T}^d and the intersection is a $(d-1)$ -dimensional real analytic submanifold of \mathbf{T}^d .*

(A-2) *There exists a finite set $\mathcal{T}_0 \subset \sigma(H_0)$ such that*

$$M_{\lambda, i} \cap M_{\lambda, j} = \emptyset, \quad \text{if } i \neq j, \quad \lambda \in \sigma(H_0) \setminus \mathcal{T}_0.$$

(A-3) *$\nabla_x p(x, \lambda) \neq 0$, on M_λ , $\lambda \in \sigma(H_0) \setminus \mathcal{T}_0$.*

(A-4) *The unique continuation property holds for \hat{H}_0 in \mathcal{V}_0 .*

(A-5) *\hat{V} is bounded self-adjoint on $\ell^2(\mathcal{V})$ and has support in \mathcal{V}_{int} , i.e. $\hat{V}\hat{u} = 0$ on \mathcal{V}_{ext} , $\forall \hat{u} \in \ell^2(\mathcal{V})$.*

(A-6) *The unique continuation property holds for \hat{H}_0 in \mathcal{V}_{ext} .*

Here, (A-6) is defined in the same way as in (A-4) with \mathcal{V}_0 replaced by \mathcal{V}_{ext} .

The spaces $\hat{\mathcal{B}}, \hat{\mathcal{B}}^*, \hat{\mathcal{B}}_0^*, \ell^{2,t}$ are naturally defined on \mathcal{V} . For $z \notin \mathbf{R}$, let

$$(7.10) \quad \hat{R}(z) = (\hat{H} - z)^{-1},$$

$$(7.11) \quad \hat{R}_0(z) = (\hat{H}_0 - z)^{-1},$$

where \hat{H}_0 is the Hamiltonian on \mathcal{V}_0 defined in Section 4. Given a subset $S \subset \mathbf{Z}^d$ and its characteristic function $\hat{\chi}_S$, we use $\hat{\chi}_S$ to denote either the operator of restriction to S : $\ell_{loc}^2(\mathbf{Z}^d) \ni \hat{u} \rightarrow \hat{u}|_S \in \ell_{loc}^2(S)$, or the operator of extension : $\ell_{loc}^2(S) \ni \hat{u} \rightarrow \hat{v} \in \ell_{loc}^2(\mathbf{Z}^d)$, where $\hat{v} = \hat{u}$ on S , $\hat{v} = 0$ on $\mathbf{Z}^d \setminus S$. This will not confuse our arguments. The spaces $\ell^2(\mathcal{V})$ and $\ell^2(\mathcal{V}_0)$, on which \hat{H} and \hat{H}_0 live, differ only by a finite dimensional space. Therefore by the well-known theorem on the compact perturbation of self-adjoint operators, we have the following theorem.

Theorem 7.1. $\sigma_e(\widehat{H}) = \sigma(\widehat{H}_0)$.

Lemma 7.2. (1) *The eigenvalues of \widehat{H} in $\sigma_e(\widehat{H}) \setminus \mathcal{T}_1$ is finite with finite multiplicities.*

(2) *There is no eigenvalue in $\sigma_e(\widehat{H}) \setminus \mathcal{T}_1$, provided \mathcal{V}_{int} has the unique continuation property.*

Here, the unique continuation property on \mathcal{V}_{int} is the following assertion. *Suppose for some $\lambda \in \mathbf{C}$, $(-\widehat{\Delta}_\Gamma + \widehat{V} - \lambda)\widehat{u} = 0$ holds on \mathcal{V} and $\widehat{u}(n) = 0$ on \mathcal{V}_{ext}° . Then $\widehat{u} = 0$ on whole \mathcal{V} .*

Proof. Let \widehat{u} be the eigenvector of \widehat{H} with eigenvalue in $\sigma(\widehat{H}_0) \setminus \mathcal{T}_1$. Then, by Theorem 5.1, it vanishes near infinity. By (A-6), we then have $\widehat{u} = 0$ on \mathcal{V}_{ext} . Therefore, all eigenvectors are supported in \mathcal{V}_{int} , hence are finite-dimensional. The assertion (2) is obvious. \square

So far, we have studied the operator \widehat{H} under the assumptions (A-1) \sim (A-6). It is because we are interested in the Rellich-Vekua theorem and the absence of embedded eigenvalues, both of which play important roles in the application to the inverse problem. However, by adopting the already established perturbation method in scattering theory, we can study the spectral properties of \widehat{H} , including \mathcal{T}_1 , under the assumptions (A-2), (A-3) and (A-5) only. The trade-off is the weaker result for embedded eigenvalues.

For $\widehat{u} \in \widehat{\mathcal{B}}^*$, its wave front set is defined by

$$WF^*(\widehat{u}) = WF^*(\mathcal{U}\widehat{P}_{ext}\widehat{u}).$$

A solution $\widehat{u} \in \widehat{\mathcal{B}}^*$ of the equation

$$(\widehat{H} - \lambda)\widehat{u} = \widehat{f} \in \mathcal{B}$$

is said to be outgoing (or incoming), if $\mathcal{U}\widehat{P}_{ext}\widehat{u}$ satisfies the condition (6.2).

Recall the following lemma.

Lemma 7.3. *For $f(x) \in L^1(0, \infty)$, put*

$$u(x) = \int_x^\infty f(t)dt.$$

Then, for any $s > 1/2$, we have

$$\int_0^\infty x^{2(s-1)}|u(x)|^2 dx \leq \frac{4}{(2s-1)^2} \int_0^\infty x^{2s}|f(x)|^2 dx.$$

This is well-known, and can be proven by using Hardy's inequality. For the proof see e.g. [25], Chapter 3, Lemma 3.3.

Lemma 7.4. *Assume (A-2), (A-3), (A-5). Then, for any compact interval $I \subset \sigma(\widehat{H}_0) \setminus \mathcal{T}_0$ and $s > 0$, there exists a constant $C_{s,I} > 0$ such that if $\widehat{u} \in \widehat{\mathcal{B}}^*$ satisfies $(\widehat{H} - \lambda)\widehat{u} = 0$ on \mathcal{V} and the outgoing (or incoming) radiation condition,*

$$\|\widehat{u}\|_{\ell^{2,s}} \leq C_{s,I} \|\widehat{u}\|_{\mathcal{B}^*}, \quad \forall \lambda \in I.$$

Proof. We put $\widehat{u}_e = \widehat{P}_{ext}\widehat{u}$, $\widehat{u}_i = \widehat{P}_{int}\widehat{u}$. First we show that

$$(7.12) \quad \text{Im}((\widehat{H} - \lambda)\widehat{u}_e, \widehat{u}_e) = 0.$$

In fact, using the equation, we have

$$\begin{aligned} & ((\widehat{H} - \lambda)\widehat{u}_e, \widehat{u}_e) \\ &= -((\widehat{H} - \lambda)\widehat{P}_{int}\widehat{u}, \widehat{P}_{int}\widehat{u}) - ((\widehat{H} - \lambda)\widehat{P}_{ext}\widehat{u}, \widehat{P}_{int}\widehat{u}) - ((\widehat{H} - \lambda)\widehat{P}_{int}\widehat{u}, \widehat{P}_{ext}\widehat{u}). \end{aligned}$$

By the computation

$$\begin{aligned} & ((\widehat{H} - \lambda)\widehat{P}_{int}\widehat{u}, \widehat{P}_{ext}\widehat{u}) - (\widehat{P}_{ext}\widehat{u}, (\widehat{H} - \lambda)\widehat{P}_{int}\widehat{u}) \\ &= ((\widehat{H} - \lambda)\widehat{P}_{int}\widehat{u}, \widehat{u} - \widehat{P}_{int}\widehat{u}) - (\widehat{u} - \widehat{P}_{int}\widehat{u}, (\widehat{H} - \lambda)\widehat{P}_{int}\widehat{u}) \\ &= ((\widehat{H} - \lambda)\widehat{P}_{int}\widehat{u}, \widehat{P}_{int}\widehat{u}) - (\widehat{P}_{int}\widehat{u}, (\widehat{H} - \lambda)\widehat{P}_{int}\widehat{u}) \\ &= (\widehat{P}_{int}(\widehat{H} - \lambda)\widehat{P}_{int}\widehat{u}, \widehat{P}_{int}\widehat{u}) - (\widehat{P}_{int}\widehat{u}, \widehat{P}_{int}(\widehat{H} - \lambda)\widehat{P}_{int}\widehat{u}) \\ &= 0, \end{aligned}$$

we prove (7.12).

We put $\widehat{f}_e = (\widehat{H} - \lambda)\widehat{u}_e = [\widehat{H}, \widehat{P}_{ext}]\widehat{u}$, which is compactly supported. Letting $\mathcal{U}\widehat{u}_e = u_e$ and $\mathcal{U}\widehat{f}_e = f_e$, we then have $(H_0 - \lambda)u_e = f_e$, and (7.12) implies $\text{Im}(u_e, f_e) = 0$. Lemma 6.2 then yields $f_e|_{M_\lambda} = 0$. By Lemma 6.3, it follows that $u_e \in \mathcal{B}_0^*$.

Now, we argue as in the proof of Lemma 4.3. We take $y_1 = p(x, \lambda)$ as a new variable and pass to the Fourier transform. Then taking account of (4.23), since u_e satisfies the outgoing radiation condition, we have

$$\|\widetilde{u}_e(\xi_1, \cdot)\|_t \leq C_t \int_{\xi_1}^{\infty} \|\widetilde{f}_e(\eta_1, \cdot)\|_t d\eta_1, \quad \forall t > 0.$$

Here, $\|\cdot\|_t$ denotes the $L^2(\mathbf{R}^{d-1})$ -norm with weight $(1 + |\xi'|^2)^{t/2}$. By Lemma 7.3, we have

$$\int_0^{\infty} \xi_1^{2(s-1)} \|\widetilde{u}_e(\xi_1, \cdot)\|_t^2 d\xi_1 \leq C_s \int_0^{\infty} \xi_1^{2s} \|\widetilde{f}_e(\xi_1, \cdot)\|_t^2 d\xi_1, \quad \forall s > 1/2, \forall t > 0.$$

Since $u_e \in \mathcal{B}_0^*$, \widetilde{u}_e also satisfies the incoming radiation condition. Therefore we have, similarly

$$\int_{-\infty}^0 |\xi_1|^{2(s-1)} \|\widetilde{u}_e(\xi_1, \cdot)\|_t^2 d\xi_1 \leq C_s \int_{-\infty}^0 |\xi_1|^{2s} \|\widetilde{f}_e(\xi_1, \cdot)\|_t^2 d\xi_1, \quad \forall s > 1/2, \forall t > 0.$$

Define the norm $\|\cdot\|_{s,t}$ by

$$\|u\|_{s,t} = \|(1 + |\xi_1|^2)^{s/2} (1 + |\xi'|^2)^{t/2} \widetilde{u}(\xi_1, \xi')\|_{L^2}.$$

Then, the above two inequalities imply

$$\|u_e\|_{s-1,t} \leq C_{s,t} \|f_e\|_{s,t}, \quad \forall s > 1/2, \forall t > 0.$$

Since \widehat{f}_e is compactly supported, we have

$$\|f_e\|_{s,t} \leq C_{s,t} \|u\|_{\mathcal{B}^*},$$

and the lemma follows. \square

Let $\sigma_{rad}(\widehat{H})$ be the set of $\lambda \in \sigma(\widehat{H}_0) \setminus \mathcal{T}_0$ for which there exists $0 \neq \widehat{u} \in \widehat{\mathcal{B}}^*$ satisfying $(\widehat{H} - \lambda)\widehat{u} = 0$ on \mathcal{V} and the outgoing radiation condition or incoming radiation condition.

Lemma 7.5. *Assume (A-2), (A-3), (A-5).*

(1) $\sigma_{rad}(\widehat{H}) = \sigma_p(\widehat{H}) \cap (\sigma(\widehat{H}_0) \setminus \mathcal{T}_0)$.

(2) $\sigma_p(\widehat{H}) \cap (\sigma(\widehat{H}_0) \setminus \mathcal{T}_0)$ is discrete in $\sigma(\widehat{H}_0) \setminus \mathcal{T}_0$ with possible accumulation points in \mathcal{T}_0 , and the multiplicity of each eigenvalue in $\sigma_p(\widehat{H}) \cap (\sigma(\widehat{H}_0) \setminus \mathcal{T}_0)$ is finite. Moreover, the associated eigenvector belongs to $\ell^{2,s}$, $\forall s > 0$.

Proof. The assertion (1) follows from Lemma 7.4. If (2) is not true, there exists an infinite number of eigenvalues $\lambda_n \in \sigma(\widehat{H}_0) \setminus \mathcal{T}_0$, counting multiplicity, converging to an interior point $\lambda \in \sigma(\widehat{H}_0) \setminus \mathcal{T}_0$. Let $\{\widehat{u}_n\}_{n=1}^\infty$ be the associated orthonormal system of eigenvectors. Lemma 7.4 then implies that $\sup_n \|\widehat{u}_n\|_s < \infty$ for all $s > 0$. One can then select a subsequence $\{\widehat{u}'_n\}$ converging strongly in $L^2(\mathcal{V})$, which leads to a contradiction. The last assertion is proven in Lemma 7.4. \square

As a consequence, we have obtained the following uniqueness theorem.

Lemma 7.6. *Let $\lambda \in \sigma_e(\widehat{H}) \setminus (\mathcal{T}_0 \cup \sigma_p(\widehat{H}))$, and suppose $\widehat{u} \in \widehat{\mathcal{B}}^*$ satisfies $(\widehat{H} - \lambda)\widehat{u} = 0$. Then $\widehat{u} = 0$, if \widehat{u} satisfies the outgoing or incoming radiation condition. In particular, if we assume (A-1) and $\lambda \notin \mathcal{T}_0 \cup \mathcal{T}_1$, the solution of $(\widehat{H} - \lambda)\widehat{u} = \widehat{f}$ satisfying the outgoing or incoming radiation condition is unique provided \widehat{H} has the unique continuation property..*

Proof. The 1st assertion follows from Lemma 7.5 (1). To prove the 2nd assertion, we assume that $\widehat{f} = 0$. Then, $\lambda \in \sigma_{rad}(\widehat{H})$, hence $\lambda \in \sigma_p(\widehat{H})$, and $\widehat{u} \in \ell^2$. By Theorem 5.1, \widehat{u} vanishes near infinity, hence in \mathcal{V} by the unique continuation property. \square

We put

$$(7.13) \quad \mathcal{T} = \mathcal{T}_0 \cup \sigma_p(\widehat{H}).$$

Let us introduce

$$(7.14) \quad \widehat{Q}_1(z) = (\widehat{H}_0 - z)\widehat{P}_{ext}\widehat{R}(z) = \widehat{P}_{ext} + \widehat{K}_1\widehat{R}(z),$$

$$(7.15) \quad \widehat{K}_1 = \widehat{H}_0\widehat{P}_{ext} - \widehat{P}_{ext}\widehat{H},$$

$$(7.16) \quad \widehat{Q}_2(z) = (\widehat{H} - z)\widehat{P}_{ext}\widehat{R}_0(z) = \widehat{P}_{ext} + \widehat{K}_2\widehat{R}_0(z),$$

$$(7.17) \quad \widehat{K}_2 = \widehat{H}\widehat{P}_{ext} - \widehat{P}_{ext}\widehat{H}_0,$$

Then, we have

$$(7.18) \quad \widehat{P}_{ext}\widehat{R}(z) = \widehat{R}_0(z)\widehat{Q}_1(z),$$

$$(7.19) \quad \widehat{P}_{ext}\widehat{R}_0(z) = \widehat{R}(z)\widehat{Q}_2(z).$$

We shall now derive the limiting absorption principle for \widehat{H} .

Theorem 7.7. *Assume (A-2), (A-3) and (A-5).*

(1) *For any compact set $J \subset \sigma_e(\widehat{H}) \setminus \mathcal{T}$, there is a constant $C > 0$ such that*

$$\|\widehat{R}(z)\widehat{f}\|_{\widehat{\mathcal{B}}^*} \leq C\|\widehat{f}\|_{\widehat{\mathcal{B}}}, \quad \text{Re } z \in J, \quad \text{Im } z \neq 0.$$

(2) For any $t > 1/2$, there exists a strong limit $\lim_{\epsilon \rightarrow 0} \widehat{R}(\lambda \pm i\epsilon)\widehat{f} \in \ell^{2,-t}$ for $\widehat{f} \in \widehat{\mathcal{B}}$ and $\lambda \in J$. Moreover, $\widehat{R}(\lambda \pm i0)\widehat{f} \in \widehat{\mathcal{B}}^*$, $\lim_{\epsilon \rightarrow 0} (\widehat{R}(\lambda \pm i\epsilon)\widehat{f}, \widehat{g}) = (\widehat{R}(\lambda \pm i0)\widehat{f}, \widehat{g})$ for any $\widehat{f}, \widehat{g} \in \widehat{\mathcal{B}}$, and the inequality

$$\|\widehat{R}(\lambda \pm i0)\widehat{f}\|_{\widehat{\mathcal{B}}^*} \leq C\|\widehat{f}\|_{\widehat{\mathcal{B}}}, \quad \lambda \in J$$

holds.

(3) For any $\widehat{f}, \widehat{g} \in \widehat{\mathcal{B}}$,

$$\begin{aligned} \sigma_e(\widehat{H}) \setminus \mathcal{T} \ni \lambda &\rightarrow \widehat{R}(\lambda \pm i0)\widehat{f} \in \ell^{2,-t}, \quad t > 1/2, \\ \sigma_e(\widehat{H}) \setminus \mathcal{T} \ni \lambda &\rightarrow (\widehat{R}(\lambda \pm i0)\widehat{f}, \widehat{g}) \end{aligned}$$

is continuous.

(4) For $\widehat{f} \in \widehat{\mathcal{B}}$, $\widehat{R}(\lambda \pm i0)\widehat{f}$ satisfies the radiation condition. Moreover, letting $u_{\pm} = \mathcal{U}\widehat{P}_{ext}\widehat{R}(\lambda \pm i0)\widehat{f}$, and

$$(7.20) \quad Q_1(\lambda \pm i0) = \mathcal{U}\widehat{Q}_1(\lambda \pm i0),$$

we have

$$(7.21) \quad P_j u_{\pm} \mp \frac{1}{\lambda_j(x) - \lambda \mp i0} \otimes (P_j Q_1(\lambda \pm i0)\widehat{f}) \Big|_{M_{\lambda,j}} \in \mathcal{B}_0^*,$$

where $P_j = P_j(x)$ is the eigenprojection associated with the eigenvalue $\lambda_j(x)$ of $H_0(x)$.

Proof. Letting $\widehat{u}(z) = \widehat{R}(z)\widehat{f}$, we have the following inequality

$$(7.22) \quad \|\widehat{u}(z)\|_{\widehat{\mathcal{B}}^*} \leq C \left(\|\widehat{P}_{ext}\widehat{f}\|_{\widehat{\mathcal{B}}} + \|\widehat{K}_1\widehat{u}(z)\|_{\widehat{\mathcal{B}}} + \|\widehat{P}_{int}\widehat{u}(z)\|_{\widehat{\mathcal{B}}} \right).$$

Note that \widehat{K}_1 and \widehat{P}_{int} are finite rank operators. Moreover, we have

$$(7.23) \quad \widehat{R}(z) = \widehat{P}_{ext}\widehat{R}_0(z)\widehat{P}_{ext} + \widehat{P}_{ext}\widehat{R}_0(z)\widehat{K}_1\widehat{R}(z) + \widehat{P}_{int}\widehat{R}(z).$$

Suppose (1) does not hold. Then, there exist $\widehat{f}_j \in \widehat{\mathcal{B}}$, z_j such that, letting $\widehat{u}_j = \widehat{R}(z_j)\widehat{f}_j$, we have, $\text{Re } z_j \in J$,

$$\|\widehat{f}_j\|_{\widehat{\mathcal{B}}} \rightarrow 0, \quad \|\widehat{u}_j\|_{\widehat{\mathcal{B}}^*} = 1.$$

We can assume without loss of generality that $z_j \rightarrow \lambda + i0 \in J$. Take $t > 1/2$. Then the embedding $\widehat{\mathcal{B}}^* \subset \ell^{2,-t}$ is compact. Therefore, there exists a subsequence of $\{\widehat{u}_j\}$, which is again denoted by $\{\widehat{u}_j\}$, such that $\widehat{u}_j \rightarrow \widehat{u}$ in $\ell^{2,-t}$. In view of (7.22), we have $\widehat{u}_j \rightarrow \widehat{u}$ in $\widehat{\mathcal{B}}^*$, hence $\|\widehat{u}\|_{\widehat{\mathcal{B}}^*} = 1$. Since $(\widehat{H} - z_j)\widehat{u}_j = \widehat{f}_j$, we have $(\widehat{H} - \lambda)\widehat{u} = 0$. Moreover, by (7.23),

$$\widehat{u} = \widehat{P}_{ext}\widehat{R}_0(\lambda + i0)\widehat{K}_1\widehat{u} + \widehat{P}_{int}\widehat{u}.$$

Therefore, \widehat{u} is outgoing. By Lemma 7.6, we have $\widehat{u} = 0$, which is a contradiction.

Next, let $\epsilon_j \rightarrow 0$ and $\widehat{f} \in \widehat{\mathcal{B}}$. Then (1) and the compact embedding $\widehat{\mathcal{B}}^* \subset \ell^{2,-t}$ imply that there exists a subsequence $\epsilon_{j_p} \rightarrow 0$ and $\widehat{v} \in \ell^{2,-t}$ such that $\widehat{v}_p := \widehat{R}(\lambda + i\epsilon_{j_p})\widehat{f} \rightarrow \widehat{v}$ in $\ell^{2,-t}$ as $p \rightarrow \infty$. Therefore, \widehat{v} satisfies $(\widehat{H}_0 + \widehat{V} - \lambda)\widehat{v} = \widehat{f}$. In view of (7.22), we have

$$(7.24) \quad \widehat{v} = \widehat{P}_{ext}\widehat{R}_0(\lambda + i0)\widehat{P}_{ext}\widehat{f} + \widehat{P}_{ext}\widehat{R}_0(\lambda + i0)\widehat{K}_1\widehat{v} + \widehat{P}_{int}\widehat{v}.$$

The third term on the right hand side is in $\widehat{\mathcal{B}}^*$, since \widehat{P}_{int} is a finite rank operator. \widehat{K}_1 is also a finite rank operator, which implies $\widehat{K}_1\widehat{v} \in \widehat{\mathcal{B}}$; $\widehat{f} \in \widehat{\mathcal{B}}$ by the hypothesis.

Therefore, the first and the second terms in the right-hand side are also in $\widehat{\mathcal{B}}^*$, which means that the left hand side $\widehat{v} \in \widehat{\mathcal{B}}^*$.

Let us show the sequence $\{\widehat{R}(\lambda \pm i\epsilon_j)\widehat{f}\}_{j=1}^\infty$ itself converges to \widehat{v} in $\ell^{2,-t}$. Assuming the contrary, we have another subsequence $\widehat{v}_{j_q} := \widehat{R}(\lambda + i\epsilon_{j_q})\widehat{f}$ which satisfies

$$\|\widehat{v} - \widehat{v}_{j_q}\|_{\ell^{2,-t}} \geq \gamma, \quad (q = 1, 2, \dots),$$

for some $\gamma > 0$. Then we can find a subsequence which is again denoted by $\{\widehat{v}_{j_q}\}_{q=1}^\infty$ and $\widehat{v}' \in \ell^{2,-t}$ such that $\widehat{v}_{j_q} \rightarrow \widehat{v}'$ in $\ell^{2,-t}$ as $q \rightarrow \infty$, $(\widehat{H}_0 + \widehat{V} - \lambda)\widehat{v}' = \widehat{f}$, and

$$(7.25) \quad \|\widehat{v} - \widehat{v}'\|_{\ell^{2,-t}} \geq \gamma > 0.$$

In the same way as above, we have

$$(7.26) \quad \widehat{v}' = \widehat{P}_{ext}\widehat{R}_0(\lambda + i0)\widehat{P}_{ext}\widehat{f} + \widehat{P}_{ext}\widehat{R}_0(\lambda + i0)\widehat{K}_1\widehat{v}' + \widehat{P}_{int}\widehat{v}',$$

and $\widehat{v}' \in \widehat{\mathcal{B}}^*$.

Subtracting (7.26) from (7.24), we have

$$\widehat{v} - \widehat{v}' = \widehat{P}_{ext}\widehat{R}_0(\lambda + i0)\widehat{K}_1(\widehat{v} - \widehat{v}') + \widehat{P}_{int}(\widehat{v} - \widehat{v}'),$$

which means $\widehat{v} - \widehat{v}'$ is outgoing, and $(\widehat{H} - \lambda)(\widehat{v} - \widehat{v}') = 0$. By Lemma 7.6, $\widehat{v} = \widehat{v}'$, which contradicts (7.25).

We define $\widehat{R}(\lambda + i0)\widehat{f} := \widehat{v}$. Let $\widehat{f}, \widehat{g} \in \ell^{2,t} \subset \widehat{\mathcal{B}}$. Then $\widehat{R}(\lambda + i\epsilon)\widehat{f} \rightarrow \widehat{R}(\lambda + i0)\widehat{f}$ in $\ell^{2,-t}$ implies $(\widehat{R}(\lambda + i\epsilon)\widehat{f}, \widehat{g}) \rightarrow (\widehat{R}(\lambda + i0)\widehat{f}, \widehat{g})$ as $\epsilon \rightarrow 0$, and

$$|(\widehat{R}(\lambda + i0)\widehat{f}, \widehat{g})| = \lim_{\epsilon \rightarrow 0} |(\widehat{R}(\lambda + i\epsilon)\widehat{f}, \widehat{g})| \leq C\|\widehat{f}\|_{\mathcal{B}}\|\widehat{g}\|_{\mathcal{B}}$$

where $C > 0$ is a constant in (1). Such a weak $*$ limit also exists for any $\widehat{f}, \widehat{g} \in \widehat{\mathcal{B}}$ and the inequality in (2) holds, since $\ell^{2,t}$ is dense in $\widehat{\mathcal{B}}$. We have thus proven (2).

As for (3), we can show the continuity of both mappings using the inequality in (2) instead of that in (1), the compact embedding $\widehat{\mathcal{B}}^* \subset \ell^{2,-t}$, and the denseness of $\ell^{2,t}$ in $\widehat{\mathcal{B}}$ in the same way as in (2).

By (7.18), we have for $\widehat{f} \in \widehat{\mathcal{B}}$

$$\mathcal{U}\widehat{P}_{ext}\widehat{R}(\lambda \pm i0)\widehat{f} = \mathcal{U}\widehat{R}_0(\lambda \pm i0)\widehat{Q}_1(\lambda \pm i0)\widehat{f}.$$

Applying Theorem 6.1 (4), we have the assertion (4). \square

7.3. Spectral representation. We keep assuming (A-2), (A-3), (A-5). It is convenient to put for $\lambda \in \sigma_e(\widehat{H}) \setminus \mathcal{T}$

$$(7.27) \quad \widehat{E}'(\lambda) = \frac{1}{2\pi i} \left(\widehat{R}(\lambda + i0) - \widehat{R}(\lambda - i0) \right),$$

$$(7.28) \quad \widehat{E}'_0(\lambda) = \frac{1}{2\pi i} \left(\widehat{R}_0(\lambda + i0) - \widehat{R}_0(\lambda - i0) \right).$$

Lemma 7.8. *We have for $\lambda \in \sigma_e(\widehat{H}) \setminus \mathcal{T}$*

$$(7.29) \quad (\widehat{E}'_0(\lambda)\widehat{Q}_1(\lambda \pm i0)\widehat{f}, \widehat{Q}_1(\lambda \pm i0)\widehat{f}) = (\widehat{E}'(\lambda)\widehat{f}, \widehat{f}),$$

$$(7.30) \quad (\widehat{E}'(\lambda)\widehat{Q}_2(\lambda \pm i0)\widehat{f}, \widehat{Q}_2(\lambda \pm i0)\widehat{f}) = (\widehat{E}'_0(\lambda)\widehat{f}, \widehat{f}).$$

Proof. Recalling (7.14) and letting $z = \lambda + i\epsilon$, we have

$$\begin{aligned}
\left((\widehat{R}_0(z) - \widehat{R}_0(\bar{z}))\widehat{Q}_1(z)\widehat{f}, \widehat{Q}_1(z)\widehat{f} \right) &= 2i\epsilon \left(\widehat{R}_0(z)\widehat{Q}_1(z)\widehat{f}, \widehat{R}_0(z)\widehat{Q}_1(z)\widehat{f} \right) \\
&= 2i\epsilon \left(\widehat{P}_{ext}\widehat{R}(z)\widehat{f}, \widehat{P}_{ext}\widehat{R}(z)\widehat{f} \right) \\
&= 2i\epsilon \left(\widehat{R}(z)\widehat{f}, \widehat{R}(z)\widehat{f} \right) - 2i\epsilon \left(\widehat{P}_{int}\widehat{R}(z)\widehat{f}, \widehat{R}(z)\widehat{f} \right) \\
&= \left((\widehat{R}(z) - \widehat{R}(\bar{z}))\widehat{f}, \widehat{f} \right) - 2i\epsilon \left(\widehat{P}_{int}\widehat{R}(z)\widehat{f}, \widehat{R}(z)\widehat{f} \right).
\end{aligned}$$

Letting $\epsilon \rightarrow 0$, we obtain

$$(\widehat{E}'_0(\lambda)\widehat{Q}_1(\lambda \pm i0)\widehat{f}, \widehat{Q}_1(\lambda \pm i0)\widehat{f}) = (\widehat{E}'(\lambda)\widehat{f}, \widehat{f}).$$

Similarly, we obtain (7.30). \square

We define

$$(7.31) \quad \widehat{\mathcal{F}}_0(\lambda) = \mathcal{F}_0(\lambda)\mathcal{U},$$

$$(7.32) \quad \widehat{\mathcal{F}}_{\pm}(\lambda) = \widehat{\mathcal{F}}_0(\lambda)\widehat{Q}_1(\lambda \pm i0).$$

The formula (6.14) implies $E'_0(\lambda) = \mathcal{F}_0(\lambda)^*\mathcal{F}_0(\lambda)$. Then in view of (7.29) and (7.32), we have the following lemma.

Lemma 7.9. *For $\lambda \in \sigma_e(\widehat{H}) \setminus \mathcal{T}$, and $\widehat{f}, \widehat{g} \in \widehat{\mathcal{B}}$,*

$$(7.29') \quad (\widehat{E}'(\lambda)\widehat{f}, \widehat{g}) = (\widehat{\mathcal{F}}_{\pm}(\lambda)\widehat{f}, \widehat{\mathcal{F}}_{\pm}(\lambda)\widehat{g})_{\mathbf{h}_{\lambda}}.$$

Theorem 7.7 (2) then yields

Lemma 7.10. *For any compact set $J \subset \sigma_e(\widehat{H}) \setminus \mathcal{T}$, there exists a constant $C > 0$ such that*

$$\|\widehat{\mathcal{F}}_{\pm}(\lambda)\widehat{f}\|_{\mathbf{h}_{\lambda}} \leq C\|\widehat{f}\|_{\widehat{\mathcal{B}}}, \quad \lambda \in J.$$

We are now in a position to apply the stationary scattering theory for Schrödinger operators (see e.g. [23], and also the recent articles [25], [50]). By following this abstract framework, one can derive the spectral representation (Theorem 7.11), the asymptotic completeness of wave operators (Theorem 7.12) and the unitarity of the S-matrix (Theorem 7.13). Since this is a well-known already established argument, we only give the outline of the proof. Let

$$(7.33) \quad I = \sigma_e(H) \setminus \mathcal{T}.$$

Take any borel set $e \in I$, and integrate (7.29') on e . Then letting $\widehat{E}(\lambda)$ be the spectral decomposition of \widehat{H} , we have

$$(7.34) \quad (\widehat{E}(e)\widehat{f}, \widehat{g}) = \int_e (\widehat{\mathcal{F}}_{\pm}(\lambda)\widehat{f}, \widehat{\mathcal{F}}_{\pm}(\lambda)\widehat{g})_{\mathbf{h}_{\lambda}} d\lambda.$$

We put

$$\begin{aligned} I_j &= \lambda_j(\mathbf{T}^d) \setminus \mathcal{T}, \\ I &= \bigcup_{j=1}^s I_j = \sigma(H_0) \setminus \mathcal{T}, \\ \mathbf{H}_j &= L^2(I_j, \mathbf{h}_{\lambda,j} a_j, d\lambda), \\ \mathbf{H} &= \mathbf{H}_1 \oplus \cdots \oplus \mathbf{H}_s = L^2(I, \mathbf{h}_\lambda, d\lambda). \end{aligned}$$

Note that $\mathbf{H} = \mathbf{H}^{(0)}$, since H is absolutely continuous on I by virtue of Theorem 7.7. We define $\widehat{\mathcal{F}}_\pm \widehat{f} \in \mathbf{H}$ by

$$(\widehat{\mathcal{F}}_\pm \widehat{f})(\lambda) = \widehat{\mathcal{F}}_\pm(\lambda) \widehat{f}.$$

Then, by (7.34), $\widehat{\mathcal{F}}_\pm$ is uniquely extended to an isometry from initial set $\widehat{E}(I)\ell^2(\mathcal{V})$ and the final set contained in \mathbf{H} . Theorem 7.7 implies $\widehat{E}(I)\ell^2(\mathcal{V}) = \mathcal{H}_{ac}(\widehat{H})$. By (7.30), one derives

$$(\widehat{\mathcal{F}}_\pm(\lambda) \widehat{Q}_2(\lambda \pm i0) \widehat{f}, \widehat{\mathcal{F}}_\pm(\lambda) \widehat{Q}_2(\lambda \pm i0) \widehat{g}) = (\widehat{E}'_0(\lambda) \widehat{f}, \widehat{g}).$$

Making use of this formula, one can construct a similar partial isometry $\widehat{\mathcal{A}}_\pm$ satisfying $\widehat{\mathcal{F}}_\pm \widehat{\mathcal{A}}_\pm = \widehat{\mathcal{F}}_0$. Therefore, the final set of $\widehat{\mathcal{F}}_\pm$ is equal to \mathbf{H} . By (7.14) and (7.32), one can show

$$\widehat{\mathcal{F}}_\pm(\lambda)(\widehat{H} - \lambda) \widehat{f} = 0, \quad \widehat{f} \in \widehat{\mathcal{B}},$$

which implies $\widehat{\mathcal{F}}_\pm \widehat{H} = \lambda \widehat{\mathcal{F}}_\pm$. In summary, one has

Theorem 7.11. (1) $\widehat{\mathcal{F}}_\pm$ is a partial isometry with initial set $\widehat{E}(I)\ell^2(\mathcal{V})$ and final set \mathbf{H} .

(2) $(\widehat{\mathcal{F}}_\pm \widehat{H} \widehat{f})(\lambda) = \lambda(\widehat{\mathcal{F}}_\pm \widehat{f})(\lambda)$, $\lambda \in \sigma_e(\widehat{H}) \setminus \mathcal{T}$, $\widehat{f} \in \mathcal{H}$.

(3) For $\lambda \in \sigma_e(\widehat{H}) \setminus \mathcal{T}$ and $\phi \in \mathbf{h}_\lambda$, $(\widehat{H} - \lambda) \widehat{\mathcal{F}}_\pm(\lambda)^* \phi = 0$.

Let us consider the time-dependent wave operators. The following theorem is well-known. See e.g. [29] and [32].

Theorem 7.12. (1) There exists a strong limit

$$s\text{-}\lim_{t \rightarrow \pm\infty} e^{it\widehat{H}} \widehat{P}_{ext} e^{-it\widehat{H}_0} \widehat{P}_{ac}(\widehat{H}_0) := \widehat{W}_\pm,$$

where $\widehat{P}_{ac}(\widehat{H}_0)$ is the projection onto the absolutely continuous subspace for \widehat{H}_0 .

(2) For any bounded Borel function ψ on \mathbf{R} , we have

$$\psi(\widehat{H}) \widehat{W}_\pm = \widehat{W}_\pm \psi(\widehat{H}_0).$$

(3) \widehat{W}_\pm is a partial isometry with initial set $\mathcal{H}_{ac}(\widehat{H}_0)$ and final set $\mathcal{H}_{ac}(\widehat{H})$.

The scattering operator \widehat{S} is defined by

$$(7.35) \quad \widehat{S} = (\widehat{W}_+)^* \widehat{W}_-.$$

By Theorem 7.12 (3), \widehat{S} is unitary on \mathbf{H} . We derive an expression of $S = \widehat{\mathcal{F}}_0 \widehat{S} (\widehat{\mathcal{F}}_0)^*$, where $\widehat{\mathcal{F}}_0 = \mathcal{F}_0 \mathcal{U}$. Since this is a well-known fact, we explain the procedure formally.

Assume that $\widehat{f}, \widehat{g} \in E_0(I)(L^2(\mathbf{T}^d))^s$. Then, we have

$$\begin{aligned}
((\widehat{S} - 1)\widehat{f}, \widehat{g}) &= ((\widehat{W}_- - \widehat{W}_+)\widehat{f}, \widehat{W}_+\widehat{g}) \\
&= -i \int_{-\infty}^{\infty} (e^{it\widehat{H}} \widehat{K}_2 e^{-it\widehat{H}_0} \widehat{f}, \widehat{W}_+\widehat{g}) dt \\
(7.36) \quad &= -i \int_{-\infty}^{\infty} (\widehat{K}_2 e^{-it\widehat{H}_0} \widehat{f}, e^{-it\widehat{H}} \widehat{W}_+\widehat{g}) dt \\
&= -i \int_{-\infty}^{\infty} (\widehat{K}_2 e^{-it\widehat{H}_0} \widehat{f}, \widehat{P}_{ext} e^{-it\widehat{H}_0} \widehat{g}) dt \\
&\quad - \int_0^{\infty} ds \int_{-\infty}^{\infty} (\widehat{K}_2 e^{-it\widehat{H}_0} \widehat{f}, e^{is\widehat{H}} \widehat{K}_2 e^{-i(s+t)\widehat{H}_0} \widehat{g}) dt,
\end{aligned}$$

where in the 3rd line, we have used $e^{-it\widehat{H}} \widehat{W}_+ = \widehat{W}_+ e^{-it\widehat{H}_0}$ which follows from Theorem 7.12 (2), and also

$$\widehat{W}_+ = \widehat{P}_{ext} \widehat{P}_{ac}(\widehat{H}_0) + i \int_0^{\infty} e^{is\widehat{H}_0} \widehat{K}_2 e^{-is\widehat{H}_0} ds \widehat{P}_{ac}(\widehat{H}_0).$$

Letting $I = \sigma(\widehat{H}_0)$, and passing to the spectral representation, we have

$$\begin{aligned}
(7.37) \quad &\int_{-\infty}^{\infty} (\widehat{K}_2 e^{-it\widehat{H}_0} \widehat{f}, e^{is\widehat{H}} \widehat{K}_2 e^{-i(s+t)\widehat{H}_0} \widehat{g}) dt \\
&= \int_{-\infty}^{\infty} \int_I (\widehat{\mathcal{F}}_0(\lambda) \widehat{K}_2^* e^{-is\widehat{H}} \widehat{K}_2 e^{-it\widehat{H}_0} \widehat{f}, e^{-i(s+t)\lambda} \widehat{\mathcal{F}}_0(\lambda) \widehat{g}) d\lambda dt.
\end{aligned}$$

using Theorem 7.12 (2), Inserting $e^{-\epsilon|t|}$ and letting $\epsilon \rightarrow 0$, we see that this is equal to

$$\begin{aligned}
(7.38) \quad &2\pi \int_I (\widehat{\mathcal{F}}_0(\lambda) \widehat{K}_2^* e^{-i(\widehat{H}-\lambda)s} \widehat{K}_2 \widehat{E}'_0(\lambda) \widehat{f}, \widehat{\mathcal{F}}_0(\lambda) \widehat{g}) d\lambda \\
&= 2\pi \int_I (\widehat{\mathcal{F}}_0(\lambda) \widehat{K}_2^* e^{-i(\widehat{H}-\lambda)s} \widehat{K}_2 \widehat{\mathcal{F}}_0(\lambda)^* \widehat{\mathcal{F}}_0(\lambda) \widehat{f}, \widehat{\mathcal{F}}_0(\lambda) \widehat{g}) d\lambda.
\end{aligned}$$

Therefore, the 2nd term of the most right-hand side of (7.36) is equal to

$$-2\pi \int_0^{\infty} ds \int_I (\widehat{\mathcal{F}}_0(\lambda) \widehat{K}_2^* e^{-i(\widehat{H}-\lambda)s} \widehat{K}_2 \widehat{\mathcal{F}}_0(\lambda)^* \widehat{\mathcal{F}}_0(\lambda) \widehat{f}, \widehat{\mathcal{F}}_0(\lambda) \widehat{g}) d\lambda.$$

Inserting $e^{-\epsilon s}$, and letting $\epsilon \rightarrow 0$, this is equal to

$$(7.39) \quad 2\pi i \int_I (\widehat{\mathcal{F}}_0(\lambda) \widehat{K}_2^* \widehat{R}(\lambda + i0) \widehat{K}_2 \widehat{\mathcal{F}}_0(\lambda)^* \widehat{\mathcal{F}}_0(\lambda) \widehat{f}, \widehat{\mathcal{F}}_0(\lambda) \widehat{g}) d\lambda.$$

Similarly, the 1st term of the most right-hand side of (7.36) is equal to

$$(7.40) \quad -2\pi i \int_I (\widehat{\mathcal{F}}_0(\lambda) \widehat{P}_{ext} \widehat{K}_2 \widehat{\mathcal{F}}_0(\lambda)^* \widehat{\mathcal{F}}_0(\lambda) \widehat{f}, \widehat{\mathcal{F}}_0(\lambda) \widehat{g}) d\lambda.$$

Summing up, we obtain

$$((\widehat{S} - 1)\widehat{f}, \widehat{g}) = -2\pi i \int_I (A(\lambda) \widehat{\mathcal{F}}_0(\lambda) \widehat{f}, \widehat{\mathcal{F}}_0(\lambda) \widehat{g}) d\lambda,$$

where

$$A(\lambda) = \widehat{\mathcal{F}}_0(\lambda) \widehat{P}_{ext} \widehat{K}_2 \widehat{\mathcal{F}}_0(\lambda)^* - \widehat{\mathcal{F}}_0(\lambda) \widehat{K}_2^* \widehat{R}(\lambda + i0) \widehat{K}_2 \widehat{\mathcal{F}}_0(\lambda)^*.$$

Using (7.14), (7.17) and (7.32), we arrive at

$$(7.41) \quad A(\lambda) = \widehat{\mathcal{F}}_0(\lambda)\widehat{Q}_1(\lambda + i0)\widehat{K}_2\widehat{\mathcal{F}}_0(\lambda)^* = \widehat{\mathcal{F}}_+(\lambda)\widehat{K}_2\widehat{\mathcal{F}}_0(\lambda)^*.$$

The S-matrix is now defined by

$$(7.42) \quad S(\lambda) = 1 - 2\pi i A(\lambda), \quad \lambda \in \sigma_e(\widehat{H}) \setminus \mathcal{T},$$

Theorem 7.13. (1) For $f \in \mathbf{H}$, we have

$$(7.43) \quad (Sf)(\lambda) = S(\lambda)f(\lambda), \quad \lambda \in \sigma_e(\widehat{H}) \setminus \mathcal{T},$$

(2) $S(\lambda)$ is unitary on \mathbf{h}_λ , $\lambda \in \sigma(\widehat{H}_0) \setminus \mathcal{T}$.

Proof. The assertion (1) is proven above. Since S is unitary on \mathbf{H} , $S(\lambda)$ is unitary for a.e. $\lambda \in \sigma_e(\widehat{H}) \setminus \mathcal{T}$. However, $S(\lambda)$ is strongly continuous for $\lambda \in \sigma_e(\widehat{H}) \setminus \mathcal{T}$. Hence $S(\lambda)$ unitary for $\lambda \in \sigma_e(\widehat{H}) \setminus \mathcal{T}$. \square

7.4. Helmholtz equation. The last topic is the characterization of the solution space of the Helmholtz equation $\{\widehat{u} \in \widehat{\mathcal{B}}^*; (\widehat{H} - \lambda)\widehat{u} = 0\}$ in terms of spectral representation. Letting

$$(7.44) \quad \varphi_j = (P_j\phi)|_{M_{\lambda,j}},$$

we have using (7.32) and (6.13),

$$(7.45) \quad \widehat{\mathcal{F}}_-(\lambda)^*\phi = \widehat{P}_{ext}\mathcal{U}^* \sum_{j=1}^s \delta_{M_{\lambda,j}} \otimes \varphi_j + \widehat{R}(\lambda + i0)\widehat{K}_1^*\widehat{\mathcal{F}}_0(\lambda)^*\phi.$$

Noting that

$$\widehat{R}(\lambda + i0) \equiv \widehat{P}_{ext}\widehat{R}_0(\lambda + i0)\widehat{Q}_1(\lambda + i0)$$

modulo a regular term, and also

$$\delta_{M_{\lambda,j}} = \frac{1}{2\pi i} \left(\frac{1}{\lambda_j(x) - \lambda - i0} - \frac{1}{\lambda_j(x) - \lambda + i0} \right),$$

we then have

$$(7.46) \quad \begin{aligned} \mathcal{U}\widehat{P}_{ext}\widehat{\mathcal{F}}_-(\lambda)^*\phi &\equiv \sum_{j=1}^s \frac{1}{2\pi i} \left(\frac{1}{\lambda_j(x) - \lambda - i0} - \frac{1}{\lambda_j(x) - \lambda + i0} \right) \otimes \varphi_j \\ &+ \sum_{j=1}^s \frac{1}{\lambda_j(x) - \lambda - i0} P_j \mathcal{U}\widehat{Q}_1(\lambda + i0) \widehat{K}_1^*\widehat{\mathcal{F}}_0(\lambda)^*\phi. \end{aligned}$$

This is rewritten as

$$(7.47) \quad \begin{aligned} &\mathcal{U}\widehat{P}_{ext}\widehat{\mathcal{F}}_-(\lambda)^*\phi \\ &\equiv -\frac{1}{2\pi i} \sum_{j=1}^s \left(\frac{1}{\lambda_j(x) - \lambda + i0} \otimes \varphi_j - \frac{1}{\lambda_j(x) - \lambda - i0} \otimes \varphi_j^{out} \right), \\ &\varphi_j^{out} = P_j\phi + P_j\mathcal{U}\widehat{Q}_1(\lambda + i0)\widehat{K}_1^*\widehat{\mathcal{F}}_0(\lambda)^*\phi. \end{aligned}$$

We let

$$(7.48) \quad \varphi^{in} = \phi, \quad \varphi^{out} = \phi + \mathcal{U}\widehat{Q}_1(\lambda + i0)\widehat{K}_1^*\widehat{\mathcal{F}}_0(\lambda)^*\phi.$$

A direct computation using (7.32), (7.15), (7.16) and (7.48) entails

$$(7.49) \quad \varphi^{out} = S(\lambda)\varphi^{in}.$$

Lemma 7.14. *For $\lambda \in \sigma_e(\widehat{H}) \setminus \mathcal{T}$, $\widehat{\mathcal{F}}_{\pm}(\lambda)\widehat{\mathcal{B}} = \mathbf{h}_{\lambda}$.*

Proof. We prove this lemma for $\widehat{\mathcal{F}}_{-}(\lambda)$. Let $u = \mathcal{U}\widehat{P}_{ext}\widehat{\mathcal{F}}_{-}(\lambda)^*\phi$ and $u_j = P_j u$. Take $x^0 \in M_{\lambda,j}$. Without loss of generality we can make a change of variables $x \rightarrow y = (y_1, y')$ around x^0 such that $y_1 = \lambda_j(x) - \lambda$. Let $\chi \in C^{\infty}(\mathbf{T}^d)$ of the form $\chi(y) = \chi_1(y_1)\chi_2(y')$ such that $\chi = 1$ on a small neighborhood of x^0 and the support of χ is sufficiently small. Then the Fourier transform of $\chi(y)u_j(y)$ becomes

$$(2\pi)^{-d/2}\widehat{\chi u_j}(\xi) \equiv \int_{\xi_1}^{\infty} \tilde{\chi}_1(\eta_1)d\eta_1 a(\xi') - \int_{-\infty}^{\xi_1} \tilde{\chi}_1(\eta_1)d\eta_1 b(\xi')$$

modulo a sufficiently regular term, where $a(\xi'), b(\xi')$ are Fourier transforms of $\chi_2(y')\varphi_j^{out}(y')$, $\chi_2(y')\varphi_j(y')$, respectively. Then, we have

$$\lim_{R \rightarrow \infty} \frac{1}{R} \int_{|\xi| < R} |\widehat{\chi u_j}(\xi)|^2 d\xi \geq C(\|\chi_2(y')\varphi_j^{out}(y')\|_{L^2}^2 + \|\chi_2(y')\varphi_j(y')\|_{L^2}^2).$$

We take a finite number of such x^0 and sum up the above inequality. Then, the right-hand side is estimated from below by $C(\|\varphi_j^{out}\|^2 + \|\varphi_j\|^2) = C\|\phi\|_{M_{\lambda,j}}^2$. On the other hand, the left-hand side is estimated from above by $C\|\widehat{\mathcal{F}}_{-}(\lambda)^*\phi\|_{\widehat{\mathcal{B}}^*}^2$. We have thus proven

$$\|\phi\|_{M_{\lambda}} \leq C\|\widehat{\mathcal{F}}_{-}(\lambda)^*\phi\|_{\widehat{\mathcal{B}}^*},$$

hence the range of $\widehat{\mathcal{F}}_{-}(\lambda)^*$ is closed. We can then argue as in Lemma 6.8 to complete the proof. \square

We have now arrived at the main theorem of this paper. Recall the definition of $A_{\pm}(\lambda)$ in (6.17).

Theorem 7.15. *Assume (A-2), (A-3) and (A-5). Let $\lambda \in \sigma_e(\widehat{H}) \setminus \mathcal{T}$.*

(1) $\{\widehat{u} \in \widehat{\mathcal{B}}^*; (\widehat{H} - \lambda)\widehat{u} = 0\} = \widehat{\mathcal{F}}_{-}(\lambda)^*\mathbf{h}_{\lambda}$.

(2) For any $\phi^{in} \in \mathbf{h}_{\lambda}$, there exist unique $\phi^{out} \in \mathbf{h}_{\lambda}$ and $\widehat{u} \in \widehat{\mathcal{B}}^*$ satisfying

$$(7.50) \quad (\widehat{H} - \lambda)\widehat{u} = 0,$$

$$(7.51) \quad \mathcal{U}\widehat{P}_{ext}\widehat{u} + A_{-}(\lambda)\phi^{in} - A_{+}(\lambda)\phi^{out} \in \mathcal{B}_0^*.$$

Moreover, $S(\lambda)\phi^{in} = \phi^{out}$.

Proof. To prove (1), as in Lemma 6.10, we have only to show

$$\widehat{u} \in \widehat{\mathcal{B}}^*, \widehat{f} \in \widehat{\mathcal{B}}, (\widehat{H} - \lambda)\widehat{u} = 0, \widehat{\mathcal{F}}_{-}(\lambda)\widehat{f} = 0 \implies (\widehat{u}, \widehat{f}) = 0.$$

Let $\widehat{v} = \widehat{R}(\lambda - i0)\widehat{f}$. Then $(\widehat{H} - \lambda)\widehat{v} = \widehat{f}$, hence $(\widehat{u}, \widehat{f}) = (\widehat{u}, (\widehat{H} - \lambda)\widehat{v})$.

Take $\chi_{\infty} \in C^{\infty}(\mathbf{R}^1)$ such that $\chi_{\infty}(t) = 1$ for $t > R_0$, where $R_0 > 0$ is sufficiently large, and $\chi_{\infty}(t) = 0$ for $t < R_0 - 1$. We put for large $r > 0$

$$\widehat{P}_{\infty,r} = \mathcal{U}^{-1}\chi_{\infty}(|N|/r)\mathcal{U}\widehat{P}_{ext}, \quad \widehat{P}_{0,r} = (1 - \mathcal{U}^{-1}\chi_{\infty}(|N|/r)\mathcal{U})\widehat{P}_{ext} + \widehat{P}_{int},$$

where $|N|$ is defined by (4.11).

First note

$$(7.52) \quad (\widehat{u}, (\widehat{H} - \lambda)\widehat{P}_{0,r}\widehat{v}) = ((\widehat{H} - \lambda)\widehat{u}, \widehat{P}_{0,r}\widehat{v}) = 0.$$

Take $\chi \in C_0^{\infty}(\mathbf{R})$ such that $\chi(t) = 1$ for $t = 1$. Then using $(\widehat{H} - \lambda)\widehat{u} = 0$, we have

$$(7.53) \quad (\widehat{u}, \mathcal{U}^{-1}\chi(|N|/R)\mathcal{U}(\widehat{H} - \lambda)\widehat{P}_{\infty,r}\widehat{v}) = ([\widehat{H}, (\mathcal{U}^{-1}\chi(|N|/R)\mathcal{U})^*]\widehat{u}, \widehat{P}_{\infty,r}\widehat{v}).$$

Now, let $u = \mathcal{U}\hat{u}$, $v = \mathcal{U}\hat{v}$. By virtue of Theorem 7.7 (4) and the assumption that $\widehat{\mathcal{F}}_-(\lambda)\hat{f} = 0$, we have $v \in \mathcal{B}_0^*$. Moreover, as is well-known, one can apply the standard micro-local calculus, or semi-classical calculus using R^{-1} as Plank's constant, for the commutator $[\widehat{H}, (\mathcal{U}^{-1}\chi(|N|/R)\mathcal{U})^*]$ (see e.g. Chap. 14 of [52]). Therefore, the right-hand side of (7.53) is dominated from above by

$$\frac{C}{R} \left(\int_{|\xi| < CR} |\tilde{u}(\xi)|^2 d\xi \right)^{1/2} \left(\int_{|\xi| < CR} |\tilde{v}(\xi)|^2 d\xi \right)^{1/2},$$

which tends to 0 as $R \rightarrow \infty$. Therefore, we have

$$(7.54) \quad (\hat{u}, (\widehat{H} - \lambda)\widehat{P}_{\infty, r}\hat{v}) = 0.$$

The equalities (7.52), (7.54) prove (1).

The uniqueness assertion of (2) follows from Theorem 7.4. Because if \hat{u}_1, \hat{u}_2 are such solutions, $\hat{u}_1 - \hat{u}_2$ satisfies the outgoing radiation condition.

To show the existence, let

$$\hat{u}^{in} = \widehat{P}_{exi}\mathcal{U}^{-1}\mathcal{F}_0(\lambda)^*\phi^{in}, \quad \hat{v} = -\widehat{R}(\lambda + i0)(\widehat{H} - \lambda)\hat{u}^{in}.$$

Since $(H_0 - \lambda)\mathcal{F}_0(\lambda)^*\phi^{in} = 0$, we have

$$\hat{v} = -\widehat{R}(\lambda + i0)\widehat{K}_2\mathcal{U}^{-1}\mathcal{F}_0(\lambda)^*\phi^{in}.$$

Then we have by Theorem 7.7 (4)

$$(7.55) \quad P_j\mathcal{U}\hat{v} \simeq -\frac{1}{\lambda_j(x) - \lambda - i0} \otimes (P_jQ_1(\lambda + i0)\widehat{K}_2\mathcal{U}^{-1}\mathcal{F}_0(\lambda)^*\phi^{in}|_{M_{\lambda, j}}).$$

We now let $\hat{u} = \hat{u}^{in} + \hat{v}$. It is easy to see that $\hat{u} \in \widehat{B}^*$ and $(\widehat{H} - \lambda)\hat{u} = 0$. Moreover,

$$\begin{aligned} & P_j\mathcal{U}\hat{u} \\ & \simeq \frac{1}{2\pi i} \left(\frac{1}{\lambda_j(x) - \lambda - i0} \otimes (P_j\phi^{in}|_{M_{\lambda, j}}) - \frac{1}{\lambda_j(x) - \lambda + i0} \otimes (P_j\phi^{in}|_{M_{\lambda, j}}) \right) \\ & \quad - \frac{1}{\lambda_j(x) - \lambda + i0} \otimes \left(P_jQ_1(\lambda + i0)\widehat{K}_2\mathcal{U}^{-1}\mathcal{F}_0(\lambda)^*\phi^{in}|_{M_{\lambda, j}} \right) \\ & = -\frac{1}{2\pi i} \frac{1}{\lambda_j(x) - \lambda + i0} \otimes (P_j\phi^{in}|_{M_{\lambda, j}}) \\ & \quad + \frac{1}{2\pi i} \frac{1}{\lambda_j(x) - \lambda - i0} \otimes \left(P_j\phi^{in}|_{M_{\lambda, j}} - 2\pi i P_jQ_1(\lambda + i0)\widehat{K}_2\mathcal{U}^{-1}\mathcal{F}_0(\lambda)^*\phi^{in}|_{M_{\lambda, j}} \right). \end{aligned}$$

The assertion (2) then follows from this formula and (7.41), (7.14), (7.16). \square

REFERENCES

- [1] S. Agmon, *Lower bounds for solutions of Schrödinger equations*, J. d'Anal. Math. **23** (1970), 1-25.
- [2] S. Agmon, *Spectral properties of Schrödinger operators and scattering theory*, Ann. Scuola Norm. Sup. Pisa **2** (1975), 151-218.
- [3] S. Agmon and L. Hörmander, *Asymptotic properties of solutions of differential equations with simple characteristics*, J. d'Anal. Math. **30** (1976), 1-38.
- [4] K. Ando, *Inverse scattering theory for discrete Schrödinger operators on the hexagonal lattice*, Ann. Henri Poincaré, **14** (2013), 347-383.
- [5] K. Ando, H. Isozaki and H. Morioka, *Inverse scattering for Schrödinger operators on perturbed lattices*, in preparation.

- [6] D. Burago, S. Ivanov and Y. Kurylev, *A graph discretization of the Laplace-Beltrami operator*, arXiv:1301.2222.
- [7] E. M. Chirka, "Complex Analytic Sets", Mathematics and Its applications, Kluwer Academic Publishers, Dordrecht, 1989.
- [8] Y. Colin de Verdière and T. Françoise, *Scattering theory for graphs isomorphic to a regular tree at infinity*, J. Math. Phys. **54** (2013), 063502.
- [9] J. Dereziński and C. Gérard, *Scattering Theory of Classical and Quantum N-Particle Systems*, Springer Verlag, Berlin-Heidelberg- New York (1997),
- [10] J. Dodziuk, *Difference equations, isoperimetric inequality and transience of certain random walks*, Trans. Amer. Math. Soc., **284** (1984), 787-794.
- [11] V. Enss, *Asymptotic completeness for quantum-mechanical potential scattering, I Short range potentials*, Commun. Math. Phys. **61** (1978), 285-291.
- [12] D. M. Eidus, *The principle of limit amplitude*, Russian Math. Survey, **24** (1969), 97-167.
- [13] M. S. Eskina, *The direct and the inverse scattering problem for a partial difference equation*, Soviet Math. Doklady, **7** (1966), 193-197.
- [14] C. Gérard and F. Nier, *The Mourre theory for analytically fibred operators*, J. Funct. Anal. **152** (1989), 202-219.
- [15] Y. Higuchi and T. Shirai, *Some spectral and geometric properties for infinite graphs*, Contemp. Math. **347** (2004), 29-56.
- [16] Y. Higuchi and Y. Nomura, *Spectral structure of the Laplacian on a covering graph*, Euro. J. of Combinatorics, **30** (2009), 570-585.
- [17] F. Hiroshima, I. Sakai, T. Shirai and A. Suzuki, *Note on the spectrum of discrete Schrödinger operators*, J. Math-for-Industry **4** (2012), 105-108.
- [18] L. Hörmander, *Lower bounds at infinity for solutions of differential equations with constant coefficients*, Israel J. Math. **16** (1973), 103-116.
- [19] L. Hörmander, *The Analysis of Linear Partial Differential Operators I, Distribution Theory and Fourier Analysis*, Springer Verlag, Berlin-Heidelberg-New York Tokyo (1980).
- [20] L. Hörmander, *The Analysis of Linear Partial Differential Operators II, Differential Operators of Constant Coefficients*, Springer Verlag, Berlin-Heidelberg-New York Tokyo (1983).
- [21] L. Hörmander, *The Analysis of Linear Partial Differential Operators III, Pseudodifferential operators*, Springer Verlag, Berlin-Heidelberg-New York Tokyo (1985).
- [22] T. Ikebe and Y. Saito, *Limiting absorption method and absolute continuity for Schrödinger operators*, J. Math. Kyoto Univ. **12** (1972), 513-542.
- [23] H. Isozaki, *On the long-range stationary wave operator*, Publ. RIMS Kyoto Univ. **13** (1977), 589-626.
- [24] H. Isozaki and E. Korotyaev, *Inverse problems, trace formulae for discrete Schrödinger operators*, Ann. Henri Poincaré, **13** (2012), 751-788.
- [25] H. Isozaki and Y. Kurylev, *Introduction to spectral theory and inverse problems on asymptotically hyperbolic manifolds*, MSJ Memoire 32, Math. Soc. Japan, World Scientific (2014).
- [26] H. Isozaki and H. Morioka, *A Rellich type theorem for discrete Schrödinger operators*, Inverse Problems and Imaging, **8** (2014), 475-489.
- [27] H. Isozaki and H. Morioka, *Inverse scattering at a fixed energy for discrete Schrödinger operators on the square lattice*, to appear in Ann. l'Inst. Fourier.
- [28] T. Kato, *Growth properties of solutions of the reduced wave equation with a variable coefficient*, CPAM, **12** (1959), 403-425.
- [29] T.Kato and S. T. Kuroda, *The abstract theory of scattering*, Rocky Mt. J. Math. **1** (1971), 127-171.
- [30] E. Korotyaev and N. Saburova, *Schrödinger operators on periodic graphs*, arXiv:1307.1841.
- [31] M. Kotani, T. Shirai, and T. Sunada, *Asymptotic behavior of the transition probability of a random walk on an infinite graph*, J. Funct. Anal. **159** (1998), 664-689.
- [32] S. T. Kuroda, *Scattering theory for differential operators, I, II*, J. Math. Soc. Japan, (1973), 75-104, 222-234.
- [33] S. G. Krantz, *Function Theory of Several Complex Variables*, John Wiley and Sons Inc., 1982.
- [34] P. Kuchment and B. Vainberg, *On absence of embedded eigenvalues for Schrödinger operators with perturbed periodic potentials*, Comm. PDE, **25** (2000), 1809-1826.
- [35] W. Littman, *Decay at infinity of solutions to partial differential equations with constant coefficients*, Trans. Amer. Math. Soc., **123** (1966), 449-459.

- [36] W. Littman, *Decay at infinity of solutions to partial differential equations*, Israel J. Math., **8** (1970), 403-407.
- [37] R. Mazzeo and R. Melrose, *Meromorphic extension of the resolvent on complete spaces with asymptotically constant negative curvatures*, J. Funct. Anal. **75** (1987), 260-310.
- [38] R. Melrose, *Geometric Scattering Theory*, Cambridge University Press (1995).
- [39] E. Mourre, *Absence of singular continuous spectrum for certain self-adjoint operators*, Commun. Math. Phys. **78** (1981), 391-408.
- [40] M. Murata, *Asymptotic behaviors at infinity of solutions to certain partial differential equations*, J. Fac. Sci. Univ. Tokyo Sec. IA, **23** (1976), 107-148.
- [41] S. Nakamura, *Modified wave operators for discrete Schrödinger operators with long-range perturbations*, arXiv:1403.2795
- [42] F. Rellich, *Über das asymptotische Verhalten der Lösungen von $\Delta u + \lambda u = 0$ in unendlichen Gebieten*, Jahresber. Deitch. Math. Verein., **53** (1943), 57-65.
- [43] W. Shaban and B. Vainberg, *Radiation conditions for the difference Schrödinger operators*, Applicable Analysis, **80** (2001), 525-556.
- [44] I. R. Shafarevich, *Basic Algebraic Geometry 1*, 2nd edition, Springer-Verlag, Heidelberg, 1977.
- [45] S. P. Shipman, *Eigenfunctions of unbounded support for embedded eigenvalues of locally perturbed periodic graph operators*, arXiv:1307.6838v2.
- [46] T. Shirai, *The spectrum of infinite regular line graphs*, Trans. Amer. Math. Soc., **352** (1999), 115-132.
- [47] A. Suzuki, *Spectrum of the Laplacian on a covering graph with pendant edges : The one-dimensional lattice and beyond*, Lin. Alg. and its Appl. **439** (2013), 3464-3489.
- [48] F. Trèves, *Differential polynomials and decay at infinity*, Bull. Amer. Math. Soc. **66** (1960), 184-186.
- [49] E. Vekua, *On metaharmonic functions*, Trudy Tbiliss. Mat. Inst. **12** (1943), 105-174.
- [50] D. Yafaev, *Mathematical Scattering Theory*, Amer. Math. Soc., Providence, Rhode Island, (2009).
- [51] K. Yosida, *Functional Analysis*, Springer-Verlag, Berlin (1966).
- [52] M. Zworski, *Semiclassical Analysis*, Graduate Studies in Mathematics, **138**, Amer. Math. Soc., Providence, Rhode Island, (2012).

DEPARTMENT OF MATHEMATICS, INHA UNIVERSITY, INCHEON, 402-751, REPUBLIC OF KOREA

INSTITUTE OF MATHEMATICS, UNIVERSITY OF TSUKUBA, TSUKUBA, 305-8571, JAPAN

CENTER FOR PROMOTION OF EDUCATIONAL INNOVATION, SHIBAURA INSTITUTE OF TECHNOLOGY, 307 FUKASAKU, MINUMA, SAITAMA-SHI, SAITAMA, 337-8570, JAPAN

ANDO@INHA.AC.KR, ISOZAKIH@MATH.TSUKUBA.AC.JP, HISASHIMORIOKA@GMAIL.COM