

The DUNE-ALUGRID Module

Andreas Dedner^a, Robert Klöfkorn^b, and Martin Nolte^c

^aUniversity of Warwick

^bInternational Research Institute of Stavanger

^cUniversity of Freiburg

July, 2014

Abstract

In this paper we present the new DUNE-ALUGRID module. This module contains a major overhaul of the sources from the ALUGRID library and the binding to the DUNE software framework. The main improvements concern the parallel feature set of the library, including now user defined load balancing and parallel grid construction. In addition many improvements have been introduced into the code to increase the parallel efficiency and to decrease the memory footprint.

The original ALUGRID library is widely used within the DUNE community due to its good parallel performance for problems requiring local adaptivity and dynamic load balancing. Therefore this new model will benefit a number of DUNE users. In addition we have added features to increase the range of problems for which the grid manager can be used, for example, introducing a 3d tetrahedral grid using a parallel newest vertex bisection algorithm for conforming grid refinement. In this paper we will discuss the new features, extensions to the DUNE interface, and explain for various examples how the code is used in parallel environments.

Keywords: Numerical software, Adaptive-parallel grid, Load Balancing, DUNE

1 Introduction

The origin of the ALUGRID package dates back to the late 20th century as part of the PhD thesis of Bernhard Schupp [31]. Back then the task was to develop a software that could solve the compressible Euler equations of gas dynamics with a Finite Volume scheme on a parallel computer in 3D including local grid adaptivity. To achieve this task Schupp implemented a 3D hexahedral adaptive mesh including dynamic load balancing based on METIS graph partitioning [20]. Later, support for tetrahedral elements was added¹ to the grid manager

¹Tetrahedral element support was implemented by M. Ohlberger.

and the code was successfully used to simulate solar eruption phenomena based on the MHD equations [14]. Shortly after this, the library was used to implement the DUNE grid interface [10]. The ALUGRID bindings were the first grid implementation providing the full interface for an adaptive, distributed grid including dynamic load balancing. It has been shown that ALUGRID is a very efficient implementation of the DUNE grid interface. For an explicit Finite Volume scheme, the performance loss is roughly 10% compared to the original ALUGRID implementation [4, 10, 21]. At that time also a serial 2D simplex grid was added to the code basis. The following releases of the software saw only maintenance work with no substantial increase in the feature set.

In this paper the first major overhaul of the ALUGRID code basis is described. Originally, ALUGRID was available as a stand alone library with a quite complex user API. Consequently, ALUGRID was used exclusively through the bindings available in the DUNE-GRID module. To reduce maintenance and improve usability we integrated both, the original ALUGRID library and its bindings to DUNE, into the new DUNE-ALUGRID module. In addition a number of new features have been added and the efficiency of the code has been increased while the memory footprint has been substantially reduced.

ALUGRID is a capable and reliable grid manager and has been used in codes based on DUNE, for example, in life science applications [2, 6], in the simulation of nanotechnology [26, 16], in simulations related to numerical weather and climate prediction [8, 27], simulation of reactive flow in a moving domain [23], or in subsurface simulations [15] and other works.

For a successful and satisfactory reading of this paper it is recommended to be familiar with the DUNE papers [4, 5] and the terminology used therein.

1.1 Summary of the New Methods

A number of new features have been added to the code over the past years. These make the ALUGRID implementation a lot more flexible and make it possible to use it through DUNE for a wider range of problems:

- **extension to implement a wider range of methods:**
the main extension is conform grid refinement implemented in the parallel 3d code. An interface for sub-entity twists were added to support conforming Finite Element implementations. In addition the support for quadrilateral and surface grids in 2d and periodic boundary treatment in 3d for parallel computations has been improved.
- **increasing usability and efficiency:**
the memory footprint is considerably reduced (Section 3.1), a cleaner interface for callback adaptation, which was partially available before, is discussed in Section 2.6.
- **increasing usability and efficiency for parallel computation:**
new features include: parallel grid construction (discussed in Section 2.3), backup and restore (discussed in Section 2.4), overlapping communication

and computation, (discussed in Sections 2.5 and 3.4), wider range of load balancing algorithms (including internal implementations), and user defined partitioning algorithms (these are discussed in Sections 2.7, 2.8, and 3.3). The summary DUNE-ALUGRID now provides

- intrinsic partitioning based on space filling curves, making DUNE-ALUGRID independent of other packages,
- bindings for the library ZOLTAN [7],
- interface for user defined partitioning.

The new load balancing capabilities are perhaps the major new feature set available in the DUNE-ALUGRID module and will be the major focus of this paper.

1.2 Method of Testing

The aim of [31] was to develop an efficient parallel implementation of an adaptive explicit Finite Volume scheme. These schemes are widely used for solving conservation laws. The appearance of steep gradients or shocks in the solution make grid adaptivity a good choice to increase the efficiency of a scheme. These shocks move in time requiring the refinement zones to move with the shocks and coarsening to take place behind them. In combination with a domain decomposition approach for parallel computation, this means that the load is difficult to balance between processors and dynamic load balancing is essential. So in each time step the grid needs to be locally refined or coarsened and the grid has to re-partitioned quite often. What makes this problem extremely challenging is the fact that evolving the solution from one time step to the next is very cheap since the update is explicit and no expensive linear systems have to be solved. So adaptivity and load balancing will dominate the computational cost of the solver. Both of these steps require global communication steps and the communication of possibly a significant amount of data and are therefore difficult to implement even with a moderate amount of parallel efficiency (see for example [11]).

Since this is a very demanding problem for a parallel code, we have decided to continue using explicit Finite Volume schemes to measure the performance of the DUNE-ALUGRID module. Grid performance plays a role in matrix-free methods where frequent grid iteration occurs in order to evaluate differential operators even if the used discrete function space is of higher order. In contrast, the performance of implicit matrix-based methods will have a stronger dependency on the efficiency of the parallel solver package than on the grid implementation. Therefore, testing implicit methods would not provide as much information on the grid module itself.

We very briefly recall the definition of a standard first order explicit adaptive Finite Volume method in Algorithm 1 to solve a conservation law of the form

$$\partial_t u + \nabla \cdot f(u) = 0, \quad u(0, \cdot) = U_0(\cdot), \quad \text{and boundary conditions.}$$

A simplest Finite Volume discretization takes the form

$$U_K^{n+1} = U_K^n - \sum_{\text{neighbor } N} G_{K,N}(U_K, U_N) \quad \forall \text{ element } K$$

For further reading on Finite Volume schemes we refer to [24].

Algorithm 1 A standard explicit Finite Volume scheme with a suitable flux function G and local time step sizes denoted with $\Delta t_{K,N}$. Note that $G_{N,K}(U_N, U_K) = -G_{K,N}(U_K, U_N)$.

```

1: Read macro grid
2: Set initial conditions  $U = U_0$ 
3: for  $l=0, \dots, L$  do
4:   Mark elements for refinement
5:   Set initial conditions  $U = U_0$ 
6: end for
7: while  $t \leq T$  do
8:    $F = 0, \Delta t = \infty$ 
9:   for all Elements  $K$  do
10:    for all neighbors  $N$  of  $K$  do
11:     if  $N$  not done then
12:      Compute update  $F_{K-} = G_{K,N}(U_K, U_N), F_{N+} = G_{K,N}(U_K, U_N)$ 
13:       $\Delta t = \min\{\Delta t, \Delta t_{K,N}\}$ 
14:     end if
15:     mark  $K$  as done
16:    end for
17:   end for
18:   Communicate update vector  $F$  from interior to ghost elements
19:   Compute global minima of all  $\Delta t$ 
20:    $U = U + \Delta t F, t = t + \Delta t$ 
21:   Mark elements for refinement and coarsening
22:   Adapt and load balance grid
23: end while

```

We mark the elements based on the modulus of the jump of some quantity across edges. For scalar problems this means that an element K is refined if $|U_K^n - U_N^n| > \text{TOL}_{\text{ref}}$ for at least one neighbor N . An element is coarsened if this quantity is smaller than some second tolerance.

As an example, we implemented a scalar transport problem with

$$f(u) = (1.25, 1.25, 0)^T u$$

using a simple upwind numerical flux (see `examples/problem-transport.hh`).

We also implemented the Euler equations of gas dynamics with a HLLC numerical flux [32] as a more demanding example. Here, the conservative variables

are $\mathbf{u} = (\rho, \rho\vec{v}, \epsilon)^T \in \mathbb{R} \times \mathbb{R}^d \times \mathbb{R}$ with the flux given by:

$$\mathbf{f}(\mathbf{u}) = \begin{pmatrix} \rho\vec{v} \\ \rho\vec{v} \otimes \vec{v} + p(u)\mathbb{I} \\ (\epsilon + p(u))\vec{v} \end{pmatrix}$$

where $I \in \mathbb{R}^{d \times d}$ denotes the identity matrix. The pressure p is given by $p(u) = (\gamma - 1)(\epsilon - \frac{1}{2}\rho|\vec{v}|^2)$ with an adiabatic constant $\gamma = 1.4$. Adaptation is in this case based on the relative jumps in the density ρ . Two typical test problems found in the literature, the Forward Facing Step and the interaction between a shock and a bubble (see [12] and references therein) are implemented. All the details of the implementation can be found in `examples/problem-euler.hh`.

To benchmark adaptation and load balancing, we implemented a third, even more demanding test case. Instead of using the solution to a partial differential equation to determine the zones for grid refinement and coarsening, a simple boolean function $E \mapsto \eta_E$ is used (see `examples/problem-ball.hh`). We refine all elements located near the surface of a ball rotating around the center of the 3d unit cube:

$$\begin{aligned} \mathbf{y}(t) &:= \left(\frac{1}{2} + \frac{1}{3} \cos(2\pi t), \frac{1}{2} + \frac{1}{3} \sin(2\pi t), \frac{1}{2} \right)^T, \\ \eta_E &:= \begin{cases} 1 & \text{if } 0.15 < |\mathbf{x}_E - \mathbf{y}(t)| < 0.25, \\ 0 & \text{otherwise,} \end{cases} \end{aligned} \tag{1}$$

where \mathbf{x}_E denotes the barycenter of the element E . A cell E is marked for refinement, if $\eta_E = 1$ and for coarsening otherwise. This sort of problem was also studied in [31]. Since the center of the ball is rotating, frequent refinement and coarsening occurs, making this an excellent test for the implemented adaptation and load balancing strategies.

1.3 Scaling results

In Figure 1 we present the results a the shock-bubble interaction problem taken from [12] using a small size computer cluster consisting of 20 Intel Core-i3 2100 (Sandy-Bridge) desktop computers connected via standard gigabit ethernet. For the dynamic load balancing we use the space filling curve approach newly implemented in DUNE-ALUGRID. The grid load balancing is checked every 25th time step and is performed when the number of elements between the largest and smallest partition differs by 20% or more. As we can see the Finite Volume part of the code scales very well up to 64 cores. The overall scaling is still acceptable. Note that we are using hyperthreading to execture four processes per node although these are dualcore machines. Parallel efficiency increases by about 10% when only two proceses are put on one node but the runtime using a given number of nodes is quite a bit higher. The curves represent different parts of the code (*solve*: computation and synchronization of the update vector, *comm*: global synchronization of time step, *adapt*: grid adaptation, and *lb*: load balancing). Finally we show the *total* runtime. Note that there are some small parts of the time loop not seperately shown so that the total runtime is

not exactly the sum of the four parts shown. In Figure 2 we present results for the same computation but this time on the *Yellowstone* supercomputer [1]. We made two changes to the settings described above which increase performance on large core counts with a strong interconnect: we use the space filling curve approach with linkage storage (see Section 3.3) and instead of rebalancing when the partitions differ by 20%, the grid is repartitioned already when the imbalance is more than 5%. Efficiency is quite good up to 2048 processors but after that the problem size is too small to adequately distribute among 4096 cores and no noticeable performance increase is achieved. At this point the communication cost becomes comparable to the actual evolution step. The grid adaptation stage is still scaling well at 1000 cores while the loadbalancing starts becoming less efficient earlier. But the computational costs of these two parts of the algorithm is still quite small compared to the evolution step. Note that in the previous cluster case with its slow interconnect the loadbalancing step was not scaling at all.

The computations reported on above were strong scaling tests, keeping the problem the same and only increasing the number of cores used. Thus the computational cost is reduced while increasing the parallelization overhead at the same time. In addition parallel efficiency is difficult to achieve since obtaining a good load distribution becomes challenging when the problem size is fixed. Therefore, we also include a weak scaling test in Figure 3. Since with adaptive simulations it is difficult to increase the problem size in the systematic way necessary for weak scaling experiments, we have performed a fixed grid computation here. As can be seen the computational cost only slowly increases leading to high parallel efficiency of 88% going from 16 to 8192 cores.

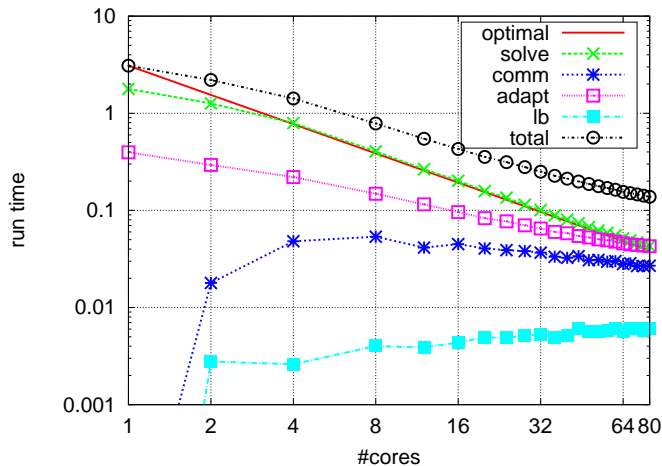

Figure 1: Strong scaling results for Euler shock-interaction problem on a small size computer cluster. The macro grid contains 4096 hexahedrons which is also the coarsest grid and the maximal refinement level is set to 4 (parameter 2204).

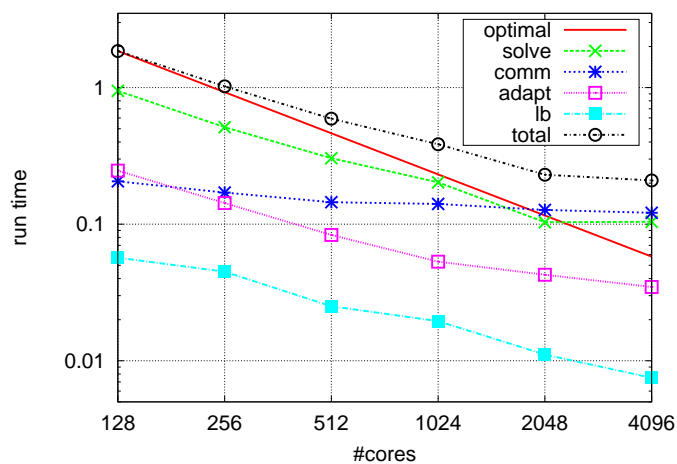

Figure 2: Strong scaling results for Euler shock-interaction problem on the peta scale supercomputer Yellowstone [1]. The macro grid contains 32 768 hexahedrons which is also the coarsest grid and the maximal refinement level is set to 6 (parameter 23 0 6).

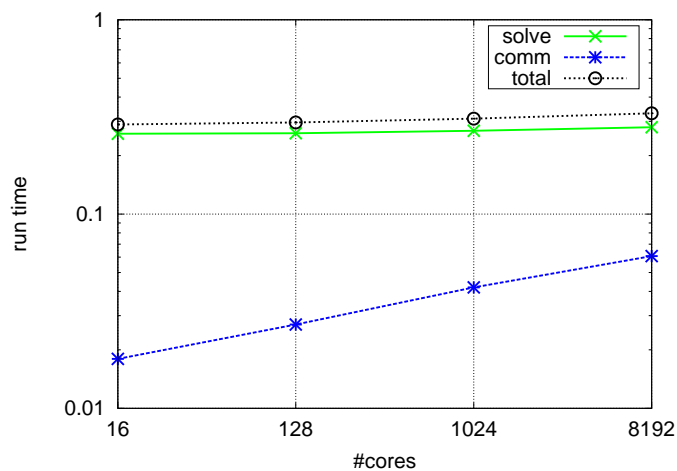

Figure 3: Weak scaling results for Euler shock-interaction problem on the peta scale supercomputer Yellowstone [1]. The number of elements is kept constant per core at 131 072 hexahedrons (parameter 25 2 0).

2 Using the DUNE-ALUGrid Module

This section discusses the features of DUNE-ALUGRID from a user perspective. Special emphasis will be put on extensions to the DUNE grid interface.

2.1 Structure of the Module

The structure of the new module is as follows: the main code for the grid implementation and the DUNE bindings are in the `dune` folder of the DUNE-ALUGRID module. A program to read in a macro grid on a single processor and to write a partitioned version in a binary format to a file is provided in the `utility` folder. Finally the `examples` folder contains the main executables for testing the DUNE-ALUGRID modules. All the test problems can be used with any grid manager implementing the DUNE-GRID interface. This makes it not only possible to test the ALUGRID implementation but also to compare with other realizations of the DUNE grid interface. The code is very similar to the example provided in the DUNE-FEM-HOWTO and comparable with the tutorial found in the DUNE-GRID-HOWTO.

The code is mainly distributed across four files;

main.cc contains the initial grid construction and the time loop.

fvscheme.hh contains the computation of the update vector $(F_K)_K$ and the code for the marking strategy.

adaptation.hh contains the code for carrying out the grid modification.

piecewisefunction.hh contains all classes used to handle the degrees of freedom including storage, restriction and prolongation, and communication.

Switching between the three different test cases is done via pre-processors flags or by making one of the three executables `main_ball`, `main_transport`, or `main_euler`. Each program takes three command line parameters:

```
./main [problem-nr] [startLevel] [maxLevel]
```

The first one determines the test case to use (including initial data and macro grid); `startLevel` and `maxLevel` determine the coarsest and finest grid level, respectively.

Extensions of the DUNE grid interface discussed in this paper can be tested in different sub-folders of `examples`. The basic code is always the same with the necessary changes described in detail in the following chapters. There are three sub-folders, each containing a script, to compare the original and the modified implementation. Again, pre-processor defines are used to provide different implementations in the same code:

callback compare dof storage and callback adaptation in serial.

Script: `check-adaptation.sh`

Pre-processor flags: `CALLBACK` and `USE_VECTOR_FOR_PWF`.

communication test asynchronous communication with callback adaptation and persistent container (best from before)

Script: `check-communication.sh`

Pre-processor flags: `NON_BLOCKING`.

testEfficiency test on one computer using multi-core, e.g. $1 \rightarrow 2 \rightarrow 4 \rightarrow 8$, and test on cluster with N computers and P cores, e.g., $P \rightarrow 2P \rightarrow 4P \rightarrow 8P$. By changing the pre-processor flags in the script different version can be tested.

Script: `check-efficiency.sh`

Pre-processor flags: `CALLBACK, USE_VECTOR_FOR_PWF, NON_BLOCKING`.

Note that by default the cube version of DUNE-ALUGRID is used. This can be changed in `Makefile.am`.

2.2 Configuration

The new DUNE-ALUGRID module is available via the module home page <http://users.dune-project.org/projects/dune-alugrid>. The repository can be accessed using the git repository from <https://users.dune-project.org/repositories/projects/dune-alugrid.git>.

The DUNE-ALUGRID module depends on DUNE-GRID and can be easily configured using the DUNE build system. Using DUNE-ALUGRID in a user module then only requires adding a dependency (or suggestion) in the `dune` module file, including `dune/alugrid/grid.hh`, and using

```
Dune::ALUGrid< dimgrid, dimworld, eltype, refinetype , communicator >
```

with $2 \leq \text{dimgrid} \leq \text{dimworld} \leq 3$ for grid and world dimension, `eltype = Dune::simplex, Dune::cube`, and `refinetype = Dune::conforming, Dune::nonconforming`. In this version, the only restriction is that conforming refinement is not a valid choice for cube grids. Contrary to previous versions, conforming refinement for a 3d simplex grid is now available. For the communicator, either `ALUGridMPIComm` for a parallel grid or `ALUGRIDNoComm` for serial grid can be used. By default, MPI communication is used, if available. Note that if DUNE-ALUGRID was compiled in parallel mode then MPI has to be initialized before constructing a grid object even in a serial computation.

There are a number of packages which can be used to increase the flexibility and performance of the DUNE-ALUGRID module. Paths to the installed versions of these packages have to be provided during the configuration of the module, i.e., within the configuration file used in the call of the `dunecontrol` script:

```
--with-dlmalloc=PATH: path to Doug Lea's malloc library (required version  
>= 2.8.6). If this library is available the memory management for DUNE-  
ALUGRID will use DLMALLOC package [25]. This can improve perform-  
ance as shown in Section 3.1.
```

- `--with-metis=PATH`: path to the METIS library [20]. If available, METIS can be used for load balancing.
- `--with-metis-lib=NAME`: name of the metis libraries (default is `metis`).
- `--with-zoltan=PATH`: path to the ZOLTAN package. This package provides a wide range of additional load balancing methods including those provided by METIS and PARMETIS. Details on how to use different load balancing methods are provided in Section 2.7 and a comparison of different algorithms can be found in Section 3.3.
- `--with-zlib=PATH`: path to ZLIB [18]. If available, ZLIB compression can be used for backup and restore of a full DUNE-ALUGRID grid object. More details on data I/O are provided in Section 2.4.

2.3 Parallel Grid Construction

Any grid-based numerical simulation must at some time construct a grid of the computational domain. The general DUNE grid interface assists this step by providing three basic construction mechanisms:

GridFactory is a general interface for the construction of unstructured grids. Basically, it constructs the grid from a list of vertex coordinates and a list of elements.

StructuredGridFactory can be used to construct a grid of an axis-aligned cube domain. For unstructured grids, a default implementation based on the **GridFactory** is provided.

GridReaders can be used to read files given in a special format. These readers will generally use the **GridFactory** to construct the grid. A DUNE specific format is available through the DGF reader. An extension of this format to partitioned grids is discussed in Section 2.3.3.

Additionally, DUNE-ALUGRID provides a native file format for pre-distributed macro grids.

At the time of this writing, the **GridFactory** interface does not support the construction of unstructured grids in parallel. The entire grid must first be constructed on one process and then distributed to all processes using the load balancing algorithm. For large macro grids, this method is at least inefficient if not impossible as the macro grid might not even fit into the memory of one computational node. Without specialization, this restriction also holds for the **StructuredGridFactory** and the DGF parser. DUNE-ALUGRID overcomes this difficulty by providing specializations of all three grid construction mechanisms. In addition the DUNE-ALUGRID module contains utility tools to perform the distribution off line, writing native distributed ALUGRID files for use in the actual computation. These will be described at the end of this section.

2.3.1 The GridFactory

In DUNE, the construction of unstructured grids is handled by the `GridFactory` class, which has to be specialized for each grid implementation supporting them. The most important interface methods are

```
void insertVertex ( const Dune::FieldVector<ctype, dimensionworld> &coord );
void insertElement( const Dune::GeometryType &type,
                   const std::vector<unsigned int> &vertices );
void insertBoundarySegment( const std::vector<unsigned int> &vertices );
```

The main difficulty when constructing a predistributed grid is the identification of the process boundaries. Using a large amount of global communication and coordinate comparison this could be achieved using the interface provided by the `DUNE-GRID` module. Since this is neither efficient nor very reliable, we extend the interface requiring the user to provide a globally unique number for each vertex in the macro grid using the method:

```
void insertVertex ( const Dune::FieldVector<ctype, dimensionworld> &coord,
                   VertexId globalId );
```

This unique numbering is sufficient to use the grid factory concept in parallel. Notice that elements and boundaries are inserted using a local vertex number corresponding to the insertion order. `VertexId` in the current implementation is an unsigned integer.

To further increase efficiency, faces on process boundaries can also be inserted, reducing the need for global communication during grid construction. Similar to the `insertBoundarySegment` method, the grid factory in `DUNE-ALUGRID` allows the insertion of process borders through the method

```
void insertProcessBorder ( const std::vector<unsigned int> &vertices );
```

While it is not necessary to insert process borders, we strongly recommend doing so, because the construction of this information within the grid factory requires an expensive global communication. Note that this method will not work accurately, if it is called for some process borders only.

In some cases it is easier to simply insert into the factory that a certain face of an element is on the border or on the boundary (see the example in Section 2.3.2). The grid factory in `DUNE-ALUGRID` allows this through the following methods:

```
void insertBoundary ( int element, int faceInElement );
void insertProcessBorder ( int element, int faceInElement );
```

2.3.2 StructuredGridFactory

An example of how to use the new methods on the grid factory to construct a distributed grid is provided in the specialization of the `StructuredGridFactory` in `dune/alugrid/common/structuredgridfactory.hh`.

Given an interval $[a, b] \subset \mathbb{R}^3$ and a subdivision vector $N \in \mathbb{N}^3$, a distributed Cartesian grid is constructed. Each process first uses `SGrid` to setup a Cartesian

grid. A space filling curve is then used to partition this grid and the distributed grid is then constructed using the extended grid factory of DUNE-ALUGRID on each process. Note that the resulting partition on each process does not consist of a product of intervals, since the distribution is done using a space filling curve. An example is shown in Figure 8.

The following code snippet shows the idea in a very general setting. The `gridView` object is the leaf grid view of a given grid (e.g. of a `SGrid`), `indexSet` denotes its index set, and the `partitioner` object provides a method `rank(const Entity &)` returning the MPI rank, the entity shall be assigned to (e.g. based on a space filling curve).

```

// create ALUGrid GridFactory
GridFactory< Grid > factory;

// map global vertex ids to local ones
std::map< IndexType , unsigned int > vtxMap;

const int numVertices = (1 << dim);
std::vector< unsigned int > vertices( numVertices );

int nextElementIndex = 0;
const auto end = gridView.template end< 0 >();
for( auto it = gridView.template begin< 0 >(); it != end; ++it )
{
    const Entity &entity = *it;
    if( partitioner.rank( entity ) != myrank )
        continue;

    // insert vertices and element
    const typename Entity::Geometry geo = entity.geometry();
    for( int i = 0; i < numVertices; ++i )
    {
        const IndexType vtxId = indexSet.subIndex( entity , i , dim );
        auto result = vtxMap.insert( std::make_pair( vtxId , vtxMap.size() ) );
        if( result.second )
            factory.insertVertex( geo.corner( i ) , vtxId );
        vertices[ i ] = result.first->second;
    }
    factory.insertElement( entity.type(), vertices );
    const int elementIndex = nextElementIndex++;

    const auto iend = gridView.iend( entity );
    for( auto iit = gridView.ibegin( entity ); iit != iend; ++iit )
    {
        const Intersection &isec = *iit;
        const int faceNumber = isec.indexInInside();
        // insert boundary face in case of domain boundary
        if( isec.boundary() )
            factory.insertBoundary( elementIndex , faceNumber );
        // insert process boundary if the neighboring element has a different rank
        if( isec.neighbor() && (partitioner.rank( *isec.outside() ) != myrank) )
            factory.insertProcessBorder( elementIndex , faceNumber );
    }
}

```

2.3.3 Dune Grid Format (DGF)

The `DGFParser` has also been extended to make use of the parallel grid construction available in DUNE-ALUGRID. For each process a `dgf` file (e.g., `grid.dgf.P.1`, ..., `grid.dgf.P.P`) is used containing only one part of the grid. As in the serial case

the blocks with the information on the elements uses a process local numbering of the vertices. A new block `GlobalVertexIndex` has to be added, where a globally unique integer for each vertex in this partition is provided in the same order used for the coordinates in the `Vertex` block. The file passed to the `GridPtr` class (e.g. `grid.dgf.P`) contains only the block `ALUParallel` listing the file names of the individual partitions for each process.

The following shows an example for the domain $[0, 1]^3$ divided into 4 elements and distributed over two processors:

cube.dgf.2	cube.dgf.2.1	cube.dgf.2.2
DGF	DGF	DGF
ALUPARALLEL	VERTEX	VERTEX
cube.dgf.2.1	0 0 0	0.5 0 0
cube.dgf.2.2	0.5 0 0	1 0 0
#	0 0.5 0	0.5 0.5 0
	0.5 0.5 0	1 0.5 0
	0 0 1	0.5 0 1
	0.5 0 1	1 0 1
	0 0.5 1	0.5 0.5 1
	0.5 0.5 1	1 0.5 1
	0 1 0	0.5 1 0
	0.5 1 0	1 1 0
	0 1 1	0.5 1 1
	0.5 1 1	1 1 1
	#	#
	CUBE	CUBE
	0 1 2 3 4 5 6 7	0 1 2 3 4 5 6 7
	2 3 8 9 6 7 10 11	2 3 8 9 6 7 10 11
	#	GLOBALVERTEXINDEX
	GLOBALVERTEXINDEX	1
	0	8
	1	3
	2	9
	3	5
	4	10
	5	7
	6	11
	7	13
	12	16
	13	15
	14	17
	15	#
	#	

These files were generated by using the utility `ParallelDGFWriter` class (in `dune/alugrid/common/writeparalleldgf.hh`) to provide distributed dgf files from a given input dgf file.

2.3.4 Utility programs

The DUNE-ALUGRID module also provides an utility program `utils/convert-macrogrid/convert` to convert a normal DGF file or a legacy ALUGRID macro grid file into DUNE-ALUGRID's new binary or compressed binary macro grid file format. This tool can also decompose the macro grid into several partitions. DUNE-ALUGRID is able to read decomposed macro grids if the number of partitions of the macro grid is smaller or equal to the used number of cores. This is especially useful for very large macro grids which will not fit into the

memory of a single core. In addition the compressed binary format reduces storage requirements and decreases storage access times.

2.4 Backup and Restore

For backup and restore as it is needed for checkpointing and postprocessing a new interface was recently introduced into DUNE-GRID. To our knowledge DUNE-ALUGRID is the first grid manager implementing this interface so we will go into a bit more detail in the following. The interface is given by

```

template< int dim, int dimworld,
          ALUGridElementType elType,
          ALUGridRefinementType refineType, class Comm >
struct BackupRestoreFacility<
    ALUGrid< dim, dimworld, elType, refineType, Comm > >
{
    /** perform backup of grid to given std::ostream */
    static void backup ( const Grid &grid, std::ostream &stream ) ;

    /** restore grid from std::istream and return pointer to
        newly created grid object */
    static Grid* restore ( std::istream &stream ) ;
};

```

The BackupRestoreFacility provides two further backup and restore methods where a filename is the argument instead of a stream. These methods have been added for legacy codes like ALBERTA [30] that might not support the read and write via streams. For DUNE-ALUGRID these are simply implemented using a file stream and the calling the above mentioned methods.

For data I/O on large parallel machines we provide two mechanisms. The conventional approach is to use standard file streams to create a binary file for each process containing the macro grid cells, refinement tree, and index information for the corresponding partition. This becomes very cumbersome when the code is used with many cores. Therefore, the second approach is to use a `std::stringstream` to write all information into a buffer of type `char*` and then use a library like SIONLIB [17] to write the data to the storage unit. This approach has the advantage that libraries like SIONLIB provide the maximal I/O performance but do not limit DUNE-ALUGRID to be used only with this library. For libraries that require the size of data to be written, like SIONLIB, the intermediate storage in a `char` buffer is necessary since for the adaptive grid the number elements is not known a priori. How SIONLIB is used is shown in the examples presented in `examples/backuprestore`. This example explains how backup/restore is done using different ways to write data to the storage device.

Note that DUNE-ALUGRID will only backup/restore its `LocalIdSet`. The `GlobalIdSet` is generated from the unique macro element id (built from the unique vertex ids) and the position in the refinement tree and therefore does not need to be stored explicitly. Furthermore, the persistent order of the macro grid automatically induces the same traversal order for the hierarchical grid. Since both, the `LevelIndexSet` and the `LeafIndexSet` are generated by grid traversal and *insert on first visit* strategy, both index set variants preserve their indices over a backup and restore process.

2.5 Overlapping Communication and Computation

In a numerical algorithm, degrees of freedom are typically attached to grid entities. Now, a single grid entity can be visible to multiple processes and any data attached to it needs to be synchronized between these processes. The DUNE grid interface, therefore, requires each grid view to support this synchronization through a `communicate` method:

```
template< class DataHandle >
void communicate ( DataHandle &, InterfaceType,
                  CommunicationDirection ) const;
```

The interface type and communication direction specify the set of entities on which data has to be sent or received. On the sending side, the data handle is responsible for packing entity data into a buffer; on the receiving side it unpacks the data again. The actual data transfer is done transparently by the grid implementation.

After all data has been sent, the grid implementation has to wait until incoming data is received. This is a waste of valuable computation time. Indeed, many numerical algorithms can be split into work that depends on the shared data and work that does not. The latter part can actually be done while communication is in progress simply by splitting sending and receiving in two parts and is supported even by the oldest MPI implementations.

To make use of the valuable communication time, DUNE-ALUGRID allows to delay the receiving process to a convenient point in the algorithm. The actual communication initiated by `communicate` becomes an object:

```
template< class DataHandle >
Communication< DataHandle > communicate ( DataHandle &, InterfaceType,
                                          CommunicationDirection ) const;
```

Such a `Communication` object satisfies the following interface:

```
struct Communication
{
    // wait for communication to finish if not already done
    ~Communication () { if( pending() ) wait(); }

    // is this communication still pending?
    bool pending () const;

    // wait for communication to finish
    void wait ();
};
```

While the communication is pending, i.e., while `wait` has not been called, the reference to the data handle must remain valid. As `wait` is automatically called in the destructor, ignoring the return value will result in a blocking communication. Thus no change is required to existing code if blocking communication is to be used.

If `gridView` is a grid view of an `ALUGrid`, overlapping communication and computation is rather simple:

```
// construct data handle for the communication
auto comm = gridView.impl().communicate ( dataHandle, interface, dir );
// do some computation not depending on the remote data
```

```

comm.wait();
// do computation depending on the remote data

```

Note that the method `impl` is only available if DUNE has been configured with the flag `--enable-experimental-grid-extensions` and will no longer be required once the new interface is added into DUNE-GRID.

In Algorithm 2 we demonstrate a possible version of our Finite-Volume scheme which makes use of the possibility to overlap communication and computation.

Algorithm 2 Adding nonblocking communication to the Finite-Volume algorithm 1.

```

1: for all interior elements  $K$  on border do
2:   for all neighbors  $N$  of  $K$  do
3:     if  $N$  not done then
4:       Compute update  $F_{K-} = G_{K,N}(U_K, U_N)$ ,  $F_{N+} = G_{K,N}(U_K, U_N)$ 
5:        $\Delta t = \min\{\Delta t, \Delta t_{K,N}\}$ 
6:     end if
7:     mark  $K$  as done
8:   end for
9: end for
10: Start communication of update vector  $F$  from interior to ghost elements
11: for all Elements  $K$ ,  $K$  not done do
12:   for all neighbors  $N$  of  $T$  do
13:     if  $N$  not done then
14:       Compute update  $F_{K-} = G_{K,N}(U_K, U_N)$ ,  $F_{N+} = G_{K,N}(U_K, U_N)$ 
15:        $\Delta t = \min\{\Delta t, \Delta t_{K,N}\}$ 
16:     end if
17:     mark  $K$  as done
18:   end for
19: end for
20: Wait for communication to complete

```

The method is implemented in `examples/communication` where the main change in the time loop is quite simple:

```

// original non-blocking code: dt = scheme( time, solution, update );
{
  dt = scheme.border( time, solution, update );
  auto commObject = grid.communicate( handle, interface, direction );
  dt = std::min(dt, scheme( time, solution, update ) );
}

```

2.6 Adaptation Using Call-Backs

Grid modification in DUNE is performed in three steps. First `grid.preadapt()` is called to start the modification phase. After this method has been called the index sets are no longer valid and data has to be accessed based either

on one of the `IdSets` or using a `PersistentContainer`. Both allow storage of data persistently during grid modification and on the whole hierarchy of the grid making it possible for data to be restricted and prolonged from one level to another. Next `grid.adapt()` is called which refines or coarsens grid elements according to markers set by the user. Finally `grid.postadapt()` is called, ending the modification phase and reinitializing the DUNE consecutive, zero starting index sets allowing to store user data in consecutive memory locations

The main steps for the user consist in making data persistent during the modification stage of the grid, prolongation of data if elements are refined, and restriction of data if elements are coarsened. A common approach is to store the data in a vector-like structure in the computation phase for efficient memory access. The necessary copying of the data into a `PersistentContainer` during the modification phase makes this step computationally more expensive. Alternatively, the user can store data directly in a `PersistentContainer` which means that the storage does not have to be modified during grid changes but sacrificing efficiency during the computation phase due to more expensive data access. In DUNE the `PersistentContainer` can be specialized for each grid implementation. A default implementation uses a `std::map` to store the data using the `LocalIdSet` of the grid as key. DUNE-ALUGRID uses a speciallization of this class based on a `std::vector` to store the data. Each entity stores an integer which is unique within the grid hierarchy and which can be used to access the data within the vector. In contrast to a DUNE `IndexSet` this index is not necessarily zero starting and consecutive, resulting in holes within the `PersistentContainer` but allowing for a constant retrieval time of the data. In our example adaptive Finite-Volume scheme both storage strategies are available for testing. By default the `PersistentContainer` is used but by defining `USE_VECTOR_FOR_PWF` the degrees of freedom will be stored in a vector-like structure and moved into a `PersistentContainer` only during the grid modification stage. In all our tests the storage of data in the `PersistentContainer` was significantly more efficient. Some results are shown in Table 1.

In addition to the approach described above, DUNE-ALUGRID provides an adaptation mechanism using a callback approach, similar to the DUNE communication and loadbalancing interface (see Section 2.7). Instead of the `grid.preAdapt()`, `grid.adapt()`, `grid.postAdapt()` algorithm, a single call to `grid.adapt(dataHandle)` is required. The `dataHandle` has to be derived from

```
template< class Grid, class Impl >
struct AdaptDataHandle
{
    typedef typename Grid::template Codim< 0 >::Entity Element;

    void preCoarsening ( const Element &father );
    void postRefinement ( const Element &father );
};
```

The method `preCoarsening` is called on the element `father` before all its descendants are removed. Accordingly, the method `postRefinement` is called immediately after descendants for an entity `father` are created. Since these methods are called during grid modification the `IndexSets` on the grid are not available and data has

to be stored in some persistent manner, e.g., using the `PersistentContainer`. There is no need to call `preAdapt()`,`postAdapt()` on the grid.

This variant of the adaptation cycle is implemented in `examples/callback/adaptation.hh`. Assuming that the degrees of freedom are stored in a `PersistentContainer` one simply needs to call

```
grid_.adapt( *this );
```

and implement the two callback methods

```
void preCoarsening ( const Entity &father )
{
    Container &container_ = getSolution().container();
    // average the data from all children and copy onto the father entity
    Vector::restrictLocal( father, container_ );
}

// called when children of father where newly created
void postRefinement ( const Entity &father )
{
    Container &container_ = getSolution().container();
    container_.resize();
    // copy the data from the father onto all its children
    Vector::prolongLocal( father, container_ );
}
```

Some tests are summarized in Table 1. In summary, our tests indicate a gain of up to 10% using callback adaptation. In addition the overall implementation is simpler since the hierarchic restriction and prolong methods do not have to be implemented. To run the test described here go to the `examples/callback` directory and run the `check-adaptation.sh` script. The implementation with a `PersistentContainer` is also compared here with the version based on vector-like structure. The advantage of using a `PersistentContainer` for the degrees of freedom in the Finite-Volume scheme is significant (more than 20%).

Table 1: Results for callback adaptation and dof storage strategy obtained on a single core from our small cluster. See script `examples/callback/check-adaptation.sh`. **T** stands for transport problem and **E** for Euler problem, followed by the three program parameters used.

	storage	vector	vector	PersistentContainer	PersistentContainer
		DUNE	callback	DUNE	callback
T	2 0 2	251s	227s	194s	173s
T	2 0 3	2411s	1820s	2222s	1647s
E	21 0 3	106s	83s	99s	77s
E	21 0 4	1070s	1037s	833s	766s

2.7 Internal Load Balancing

There are two stages in a computation where load balancing is essential in a simulation. During the start up phase of the computation where the grid has to be distributed over the available number of processes and after the grid has been locally refined. Even if the grid has been partitioned beforehand and DUNE-ALUGRID's parallel grid factory is used, it is still sometimes of practical interest to repartition the grid after creation, e.g., if a larger number of processes are available for the computation. To this end the DUNE-GRID interface provides the method

```
bool loadBalance();
```

Even if the initial grid is optimally distributed, the load can become unbalanced during the computation for example if local adaptivity is used. In this case the method mentioned above is not sufficient as it does not allow to migrate user data together with elements from one process to another. To manage data migration the DUNE-GRID interface provides a second method

```
template< class DataHandleImpl, class Data >  
bool loadBalance( CommDataHandleF< DataHandleImpl, Data > &dataHandle );
```

The handling of user data is achieved by a callback mechanism using the same interface used for communication during the computation. Basically, for each element to be removed on the given process a method `gather` is called (to collect data to be shipped with the element) and when a new element is added to the grid on the process then a method `scatter` is called (to deliver the data that was shipped with the element) on the `dataHandle` instance.

The main problem with these two methods is that there is no mechanism for the user to intervene with the details of partitioning computed by the grid manager. This new module provides two mechanisms for the user to improve the internal load balancing to suite the need of the application in hand. First, we need to give a brief description of how DUNE-ALUGRID's internal load balancing strategy works.

DUNE-ALUGRID only allows for horizontal load balancing, i.e., partitioning of the elements on the macro level, migrating the whole tree below a given macro element from one process to another. Each macro element E is assigned a weight equal to the number of leaf elements below E . Using these weights either a space filling curve approach is used or a graph partitioning algorithm is used. In ALUGRID 1.52 only serial graph partitioning using the METIS library [20] could be used. The serial graph partitioning requires the communication of the whole assembled graph to all processes which does not scale in terms of memory and communication time. While this method can still be used in DUNE-ALUGRID, additional bindings to ZOLTAN [7] have been added (providing space filling curve and graph partitioning methods). Via the ZOLTAN interface PARMETIS [29] is available as well. The graph is constructed using the weighted macro elements as nodes and connecting neighboring macro elements E_1, E_2 with an edge in the graph. These edges are assigned weights according

Table 2: Internal partitioning methods and numbering. More details on the internal implementations of a space filling curve approach can be found in Section 3.3.

NONE	0	COLLECT (to rank 0)	1
Space Filling Curve (linkage)	4	Space Filling Curve (serial, linkage)	5
Space Filling Curve	9	Space Filling Curve (serial)	10
METIS (PartGraphKway)	11	METIS (PartGraphRecursive)	12
ZOLTAN (HSFC)	13	ZOLTAN (GRAPH)	14
ZOLTAN (PARMETIS)	15		

to the number of leafs below E_1, E_2 which are neighbors. The node weights are to represent the computational cost, while the edge weights represent the communication size in the case that these elements come to be on different processors. The newly implemented partition algorithm for space filling curves makes DUNE-ALUGRID more self contained. As a default we are using the Hilbert space filling curve (see for example [3]) provided by ZOLTAN [7]. The element weights described above are used to determine the optimal partitioning of the space filling curve.

The simplest way to tweak the internal load balancing algorithm are three parameters read from a file called `alugrid.cfg`, which is searched for in the current working directory. This file has to contain three values. The first two numbers (`lbUnder`, `lbOver`) in the `alugrid.cfg` file allow to specify a certain amount of load imbalance which has to be exceeded before the partitioning is adjusted. A new partitioning is computed only if the maximum number of leaf elements in a partition exceeds `lbOver` times the mean number of elements or the minimum number is smaller than `lbUnder` times the mean number of elements in all partitions. The third value is an integer between 0 and 15 determining the partitioning method to use. Table 2 gives an overview of available methods and their numbering.

A second option to influence the outcome of the load balancing algorithm is to provide other weights for the elements (i.e., the graph nodes). This can improve the overall efficiency of a scheme if the number of leaves does not directly represent the computational cost associated with a given macro element. An example for this are reactive flow problems where substepping in time is used to resolve stiff sources locally on each element [19]. Further examples are the solution of PDEs in a moving domain [23] or a multi-domain approach where partial differential equations with different complexity are solved in different domains represented on the same underlying grid [28]. The corresponding additional method is

```
template< class LBWeights, class DataHandleImpl, class Data >
bool loadBalance ( LBWeights &weights,
                  CommDataHandleIF< DataHandleImpl, Data > &dataHandle);
```

`LBWeights` must implement `int operator()(const Grid::Codim<0>::Entity &)` which will be called for each macro element to provide the weight, here an integer value.

2.8 User Defined Partitioning

A more general approach is provided by the methods

```
template< class LBDestinations >
bool repartition ( LBDestinations &destinations );
template< class LBDestinations, class DataHandleImpl, class Data >
bool repartition ( LBDestinations &destinations,
                  CommDataHandleIF< DataHandleImpl, Data > &dataHandle);
```

performing load balancing either without or with migrating user data using callback on the `dataHandle` instance. Otherwise, the whole load balancing is taken care of by the user. The class `LBDestinations` has to fulfill the following interface

```
struct LBDestinations
{
    // Return process number the given macro element should be assigned to.
    int operator()(const Grid::Codim<0>::Entity &);
    // Fill set of ranks the current process will receive elements from and return true
    // in this case. If false is returned, then ALUGrid will compute this information
    // via a global communication.
    bool importRanks( std::set<int>& ranks ) const;
};
```

where the `int operator()(const Grid::Codim<0>::Entity &)` returns the process number an element is to be moved to. In DUNE-ALUGRID this method will be called for each macro element on the given rank and that macro element together with all its children will be moved to the desired partition. The method `importRanks` can simply return `false` and then does not need to fill the `ranks` vector. However, this decreases performance due to the global communication required to find out from which ranks to expect data. Some partitioning tools like ZOLTAN provide this information, so that the user only needs to copy it to `ranks` vector and return true to improve parallel efficiency.

An example usage is shown in `examples/loadbalancing/loadbalance_simple.hh`. The partitioning is computed by keeping the center on process zero and distributing the rest of the grid in equal slices to the other processors. The only changes required to the algorithm are in `main.cc` and `adaptation.hh` where the calls of the `loadbalance (...)` method on the grid are replaced with the new `partition (...)` methods. In each step of the scheme before calling `grid.partition (...)` the method `repartition ()` is called on the `loadbalance` handle. This causes an internal variable to be increased, leading each time to a new partitioning:

```
template< class Grid >
struct SimpleLoadBalanceHandle
{
    typedef SimpleLoadBalanceHandle This;
    typedef typename Grid::Traits::template Codim<0>::Entity Element;
    SimpleLoadBalanceHandle ( const Grid &grid )
    : angle_( 0 )
    , maxRank_( grid.comm().size() )
    {}

    /** this method is called before invoking the re-partition
        method on the grid, to check if the user defined
        partitioning needs to be readjusted */
    bool repartition ()
    {
```

```

    angle_ += 2.*M_PI/50.;
    return true;
}

/** This is the method, called from the grid for each macro element.
    It returns the rank to which the element is to be moved. */
int operator()( const Element &element ) const
{
    typedef typename Element::Geometry::GlobalCoordinate Coordinate;
    Coordinate w = element.geometry().center();
    w -= Coordinate(0.5);
    if (w[0]*w[0]+w[1]*w[1] > 0.1 && maxRank_>0)
    { // distribute everything away from the center in equal slices
        double phi=arg(std::complex<double>(w[0],w[1]));
        if (w[1]<0) phi+=2.*M_PI;
        phi += angle_;
        phi *= double(maxRank_-1)/(2.*M_PI);
        int p = int(phi) % (maxRank_-1);
        return p+1;
    }
    else // keep the center on proc 0
        return 0;
}

/** This method can simply return false, in which case ALUGrid
    will internally compute the required information through
    some global communication. To avoid this overhead the user
    can provide the ranks of partitions from which elements will
    be moved to the calling partition. */
bool importRanks( std::set<int> &ranks) const { return false; }
private:
    double angle_;
    int maxRank_;
};

```

A more useful example is given in `examples/loadbalancing/loadbalance_zoltan.hh`, where the algorithm in DUNE-ALUGRID relying on the ZOLTAN's graph partitioner is replicated using the DUNE interface. Note that the results will not be identical since the order of the edges within the graph will differ slightly when using the DUNE interface to build it. Nevertheless, the algorithm and parameter settings for ZOLTAN are identical. Based on this implementation it is easy to experiment with the wide range of options ZOLTAN provides to optimize the partitioning algorithm for a given application. Note also that the class again contains a `repartitioning` method using the same `lbOver`, `lbUnder` values provided in the `alugrid.cfg` file.

Constructing the graph relying only on the available DUNE interface would be quite cumbersome and involve quite a bit of overhead. There is no direct way to compute the edge weights and the master rank for each ghost element has to be passed on to ZOLTAN, information requiring an extra communication step within DUNE. To simplify constructing the graph DUNE-ALUGRID provides a new method on the grid.

```

template<PartitionIteratorType pitype>
typename Partition<pitype>::MacroGridView macroView() const {
    typedef typename Traits::template Partition<pitype>::MacroGridView View;
    return View(*this);
}

```

This method returns of view of the macro grid level of the grid. The `MacroGridView` contains the usual method to iterate over the macro grid and obtain an index set but in addition includes some useful methods to construct the dual weighted graph:

```

// return the master process of the given element
int master ( const typename Codim< 0 > :: Entity &entity ) const;
// return a globally unique integer id for this element
int macroid ( const typename Codim< 0 > :: Entity &entity ) const;
// return the weight (number of leaf elements) for the given elements
int weight ( const typename Codim< 0 > :: Entity &entity ) const;
// return the weight for this intersection
int weight ( const Intersection &intersection ) const;

```

The ZOLTAN example demonstrates a practical usage of the new load balancing interface and also an extension not directly available using the internal bindings: The hypergraph algorithm of ZOLTAN can be used to fix a set of elements to a given processor. By changing the variable `fix_bnd_` to `true` the partitioning is computed such that all elements adjacent to left boundary face are kept on process zero throughout the simulation. A practical example of this possibility is discussed in [6].

Note: as pointed out above, DUNE-ALUGRID only allows to partition the macro level of the grid. Depending on the problem the macro grid might not contain enough elements or the adaptivity might be too localized to allow for a balanced load if only macro elements are distributed. On manycore systems a possible solution is to use fewer processes to distribute the macro grid and use threading to partition directly on the leaf level. This approach has been evaluated in [22].

3 Implementational details

While the previous section discussed the usage of the code from the user’s point of view, this section discusses the implementation details and behavior of the internal structures of DUNE-ALUGRID, such as memory consumption, linkage between different processes, load balancing, or DUNE-ALUGRID’s native macro grid format. This might provide users with helpful inside views that, for example, help with the choice of load balancing algorithms to use.

3.1 Memory Consumption

Memory consumption has become more and more critical for any numerical software since the overall memory available per core has declined lately. To understand the memory consumption in DUNE-ALUGRID we present the logical storage of a hexahedron in Figure 4. A vertex stores its coordinates, an edge stores pointers to the two vertices, a quadrilateral face stores pointers to the four edges and a hexahedron stores pointers to the six faces it consists of. For example, the memory consumption of a vertex on a 64bit architecture is 56 bytes due to the storage of coordinates (3 `double` result in 24 bytes), 8 bytes for the vtable (all interfaces in ALUGRID use virtual methods), 8 bytes for flags

and index storage, 8 bytes for a pointer to the grid class, and another byte for the level information which is stored as **unsigned char** but due to padding this adds up to 56 bytes.

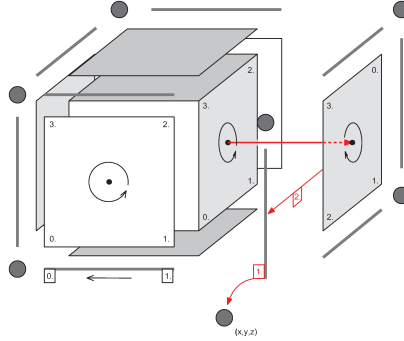

Figure 4: Structure of a hexahedron in ALUGrid.

Table 3: Memory consumption by ALUGrid’s entities in bytes (in braces we put the memory consumption in ALUGrid’s 1.52 version).

type	tetra	hexa	macro tetra	macro hexa
vertex	56 (64)	56 (64)	80 (80)	80 (80)
edge	56 (136)	56 (136)	64 (144)	64 (144)
face	88 (160)	96 (174)	96 (168)	104 (184)
element	96 (160)	112 (184)	104 (168)	120 (192)

Depending on the size of the macro grid and the face/edge to element ratio a hexahedral grid consumes between 700 and 800 bytes per element. The tetrahedral version of the grid consumes between 350 and 400 bytes per element. Note that these numbers strongly depend on the macro grid chosen and might vary for other macro grids. For the old version 1.52 storing a hexahedral element needed between 1300 and 1500 bytes. For a tetrahedral element version 1.52 needed between 650 and 750 bytes. In Figure 5 we show the memory consumption for the old and the new version for the ball test case with adaptation using the refinement from (1). In summary the memory consumption has been reduced by about a factor of 2.

In an adaptive grid, entities are frequently created during refinement and destroyed during coarsening. As ALUGRID allocates memory for each grid entity separately, efficient memory allocation and deallocation play an important part in this process. To allow for customization, ALUGRID derives all entities

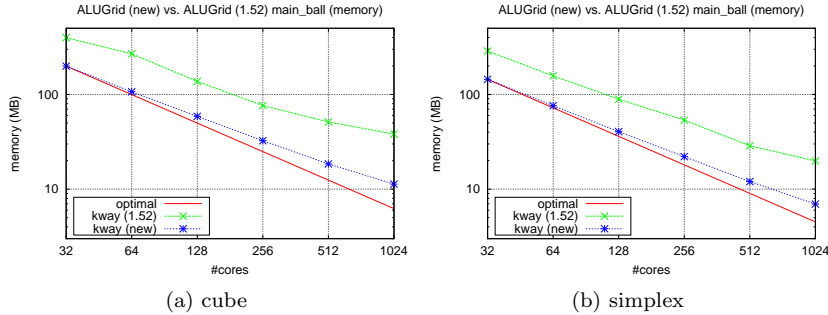

Figure 5: Comparison of memory usage for the old and the new version. Both version use `dmalloc` as memory allocator. The 1.52 version has been patched for this purpose.

from an object called `MyAlloc`, which contains overloaded operators `new` and `delete`. Two such objects are shipped with `DUNE-ALUGRID`.

`default` does not overload the operators `new` and `delete`, so that standard C++ memory allocation is used. This is the default memory allocation used.

`dmalloc` makes use of Doug Lea’s memory allocator (`dmalloc`) [25], which can be downloaded from <http://g.oswego.edu/dl/html/malloc.html>. If the configure option `--with-dmalloc=PATH` is provided specifying a path to the `dmalloc` installation, `dmalloc` will be used for allocation of grid entities.

In Figure 6 we present a comparison of runtimes between the different memory allocation strategies. The former internal `ALUGRID` implementation based on `std::map` and `std::stack` has been removed since it did not lead to better performance anymore. For the adaptation with the ball refinement from equation (1) using `dmalloc` around 10% less CPU time is consumed in comparison to the standard C++ memory allocation on Yellowstone [1].

3.2 Linkage Patterns and Global Communication

Every software package dealing with parallel grid managers has to provide the connectivity for grid entities located at process borders. There are many ways to implement this efficiently. Since most packages do not deal with adaptive grids this relatively expensive setup of the connectivity structure has to be done only once. For this reason most approaches contain relatively expensive structures since this is considered to be initial setup time.

However, in an adaptive grid where dynamic load balancing is a must this computation of connectivity has to be repeated after every load balancing step. In `DUNE-ALUGRID` the linkage between entities at the process border is basically derived from the linkage that all vertices of the considered entity have.

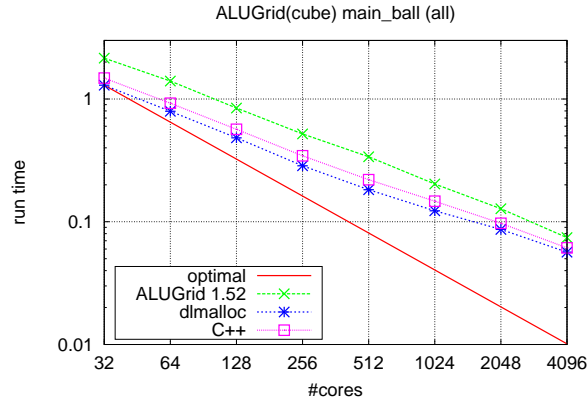

Figure 6: Comparison of run times for the different memory allocation strategies. The memory allocation using Doug Lea’s memory allocator [25] performs best, the strategy used in ALUGRID 1.52 performs worst and will be removed. For load balancing we used the internal space filling curve approach with locally computed linkage (indenture number 4).

The single linkage pattern² of a vertex is stored in a `std::map`. Each vertex just holds an iterator pointing to the appropriate linkage pattern. This way each vertex of the macro grid only stores additional 8 bytes. To compute the linkage of an edge we simply have to compute the intersection of the linkage patterns of both adjacent vertices. The same holds true for a face. Note that the linkage is stored in DUNE-ALUGRID in a non-symmetric fashion [31]. This means that only master vertices and master edges know all its corresponding slaves but the slaves vertices and edges only know the master. This is enough to provide the correct linkage between faces on different processes but requires two communications to transmit vertex or edge data, e.g. slave \rightarrow master, master \rightarrow other slaves. This is not a major drawback since the user can build his own communication on top of the DUNE grid interface as demonstrated in DUNE-FEM [13].

The problem with adaptive grids is that this linkage has to be recomputed after every load balancing step. In principle this could be done by several point-to-point communications. However, this is very complicated to implement. For this reason a global communication of `MPI_Allgather_v` type is performed to obtain the information which process holds which border vertices. By design the `MPI_Allgather_v` method does not scale memory wise since every process has to hold an array of size P where every entry is an array itself. Therefore, DUNE-ALUGRID contains an alternative variant based on `MPI_Bcast`. Here, memory consumption is not a problem but the communication time complexity is

²A sorted list of rank numbers that hold a copy of the vertex including the globally unique id.

$\mathcal{O}(P \log P)$ with P being the number of cores. The `MPI_Bcast` approach is used if the core count is larger than some given bound which the user can set to `Pmax` by adding

```
ALUGrid :: ALUGridExternalParameters :: allGatherMaxSize() = Pmax;
```

to the main program. On Yellowstone we set this value to 4096. Otherwise we rely on the `MPI_Allgatherv` variant.

This method of recomputing the linkage has to be done for all partitioning methods with indenture number > 5 such as `METIS` or `ZOLTAN` as well as user defined partitioning. This is perfectly fine for process counts below < 4096 . For higher process numbers this becomes very expensive in terms of memory and communication times. As a reason the `DUNE-ALUGRID` internal backup/restore format also stores this linkage information to avoid re-computation after restore (see Section 3.5). Using this feature grids can be setup for production runs once and then stored using the native format.

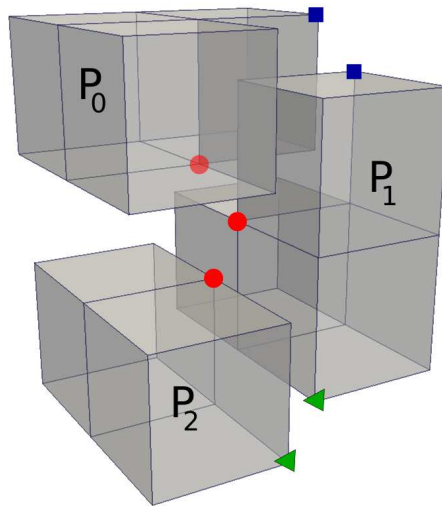

Figure 7: Example of vertex linkages in a grid with 3 partitions. On process 0 the circled vertex has the linkage $\{1, 2\}$ and the square vertex has the linkage $\{1\}$. On process 1 the circled vertex has the linkage $\{0, 2\}$, the squared vertex has the linkage $\{0\}$, and the triangle vertex has the linkage $\{2\}$.

To overcome the global communication problem when computing the vertex linkage we implemented an additional approach based on space filling curves. The type of space filling curve can be chosen by the user. By default `DUNE-ALUGRID` uses the Hilbert space filling curve implementation (see Figure 8) from the `ZOLTAN` package [7] if the package was found. `DUNE-ALUGRID` simply assumes that the macro grid is ordered following a space filling curve and assigns a unique consecutive id for each element in the macro mesh which also corre-

sponds to the iteration order of the macro mesh. This id is kept for each element throughout the computation. With this approach the partition of the macro mesh boils down to the balancing of a 1d graph with different weights. The partition algorithm is described in Algorithm 3. When the DUNE-ALUGRID internal space filling curve partitioning is used the element cuts are available on every process, see Algorithm 3. This can be used to compute the vertex linkage locally by the storing element ids each vertex in the macro grid is connected to. Since the macro grid topology does not change these element ids stay the same throughout the computation. Using the element cuts (see Algorithm 3) for every vertex we can now determine the ranks of each of the elements it is connected to. This is exactly the information needed to compute the process linkage. Therefore, no extra communication is needed in this case.

This is a major advantage when using the DUNE-ALUGRID code on a large number of cores.

3.3 Internal Load Balancing Methods

As mentioned in the previous section DUNE-ALUGRID provides, among other methods, a load balancing based on a space filling curve approach. This simply requires the macro grid to be sorted by the order of a space filling curve. This can be done either by the user beforehand, or DUNE-ALUGRID provides a default ordering based on the Hilbert curve. This default option is only available if the ZOLTAN package [7] is available. In the following we use the default Hilbert curve implemented in ZOLTAN for ordering the macro elements. The barycenters of all macro elements are mapped to the unit cube and then the function `Zoltan_HSFC_InvHilbert3d` is used to map onto the interval $[0, 1]$. This allows to sort all elements and assign a unique number between $0, \dots, N - 1$ where N is the overall number of macro elements. In Figure 8 we present the generated Hilbert curve for a Cartesian hexahedral and a tetrahedral macro meshed, as well as a unstructured simplex macro grid.

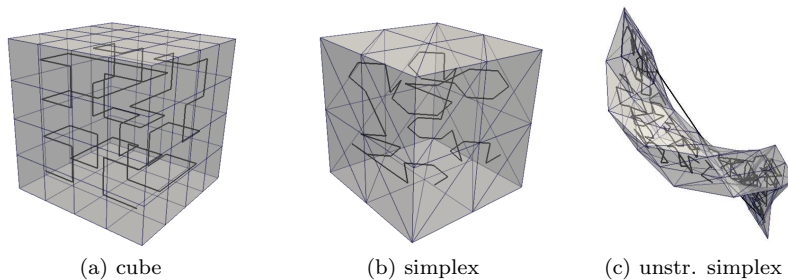

Figure 8: Macro grids and corresponding Hilbert curve generated by `Zoltan_HSFC_InvHilbert3d`.

Once the sorting of the macro grid is done, partitioning in DUNE-ALUGRID boils down to balancing a 1d graph with weights. There are two algorithm

implemented in DUNE-ALUGRID. The serial algorithm requires the 1d graph and weights to be present on each process. This requires one `Allgather` communication. The balancing is then done using the Bresenham line drawing algorithm [9]. Since the complete graph is then available on each process no further communication is needed to determine element cuts and destinations. For a distributed memory environment the drawback of this method is that it does not scale in terms of memory and communication requirements but it is still very useful for local partitioning, e.g. when used to obtain a decomposition in a shared memory or hybrid parallel approach. For a distributed memory environment with a high core count we adopted the `Partition` algorithm described in [11]. We present this algorithm here again, since the version in [11] contains a small mistake. In addition, we alter the algorithm such that empty partitions are avoided. This can happen when the imbalance of each 1d interval varies drastically and the element/core ratio is small.

The communicated data for this algorithm does only depend on the number of partitions which usually corresponds to the number of processes P . For the partitioning of the 1d graph for each process $p \in \{0, \dots, P - 1\}$ we need to compute the globally accumulated weights W_p . Then the element cuts can be obtained by

$$S_p := \left\{ q \mid W_p < \left\lfloor \frac{qW_P}{P} \right\rfloor \leq W_{p+1} \right\}, \quad p_{low} := \min_q S_p, \quad p_{high} := \max_q S_p. \quad (2)$$

Note that W_P/P denotes the average work load. Algorithm 3 describes how the balancing of the 1d graph is obtained. Here, two global communications are required, one of `Allgather` type and one of `Allreduce` type.

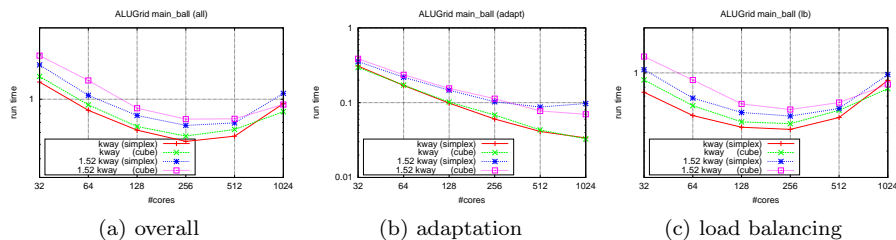

Figure 9: Comparison of the 1.52 version and DUNE-ALUGRID using the ball example with parameter 314 for non-conforming simplex and cube grids. Here, we only use the METIS PartGraphKway (indenture number 11) method for domain decomposition.

In Figure 9, 10, 11, and 12 we present a comparison of the different load balancing algorithms available in DUNE-ALUGRID. The results show a strong scaling study using the ball example with refinement as described in (1). For these computations the macro mesh contains 32 768 hexahedra (resulting in 196 608 tetrahedra). The scaling study has been carried out on Yellowstone [1].

Algorithm 3 Partition ($w[1, \dots, m], C[0, \dots, P - 1], p, P, N$)

```
1: for all  $k \in \{1, \dots, m\}$  do
2:    $w[k] \leftarrow w[k] + w[k - 1]$ 
3: end for
4:  $W[0] \leftarrow 0; W[p] \leftarrow w[m]$  {store local accumulated weights }
5: Allgather( $W[1, \dots, P]$ ) { gather accumulated weights on all processes }
6: for all  $q \in \{1, \dots, P\}$  do
7:    $W[q] \leftarrow W[q] + W[q - 1]$  { compute global accumulated weights }
8: end for
9: for all  $k \in \{1, \dots, m\}$  do
10:   $w[k] \leftarrow w[k] + W[p]$  { add global accumulated weights to local weights }
11: end for
12: Determine cuts  $p_{low}$  and  $p_{high}$  as in (2)
13:  $C^*[0, \dots, P - 1] \leftarrow 0$  { new element cuts }
14: for all  $q \in \{p_{low}, \dots, p_{high}\}$  do
15:   if  $q < P$  then
16:      $C^*[q] \leftarrow \min_k \{w[k] \geq \lfloor qW_P/P \rfloor\}$ 
17:   end if
18: end for
19: Allreduce( max,  $C[0, \dots, P - 1]$  ) { Determine cuts on all processes }
20: if  $P < N$  then
21:   while empty partitions do
22:     for all  $q \in \{1, \dots, P - 1\}$  do
23:       if  $C^*[q] = C^*[q - 1]$  then
24:         Shift cuts by +1 or -1 { Make sure that there are no empty
           partitions }
25:       end if
26:     end for
27:   end while
28: end if
29: Send and receive elements according to old and new element cuts
30:  $C \leftarrow C^*$  { Store new element cuts }
```

In Figure 9 we present a comparison of run times for the 1.52 version and the new DUNE-ALUGRID module. Since in version 1.52 only METIS was available for partitioning we only compare the run times using the METIS partitioning. We discover that both, the tetrahedral and the hexahedral version performs better in the new DUNE-ALUGRID implementation.

For the comparison of load balancing methods in Figure 10, 11, and 12 we can see that the space filling curve approaches, either DUNE-ALUGRID's internal methods or the HSFC method from ZOLTAN, perform best even if the macro grid does not allow a good partitioning anymore because the average element per core ratio is very small. The graph partitioning methods are in general more expensive even though the created partitions seem to be more

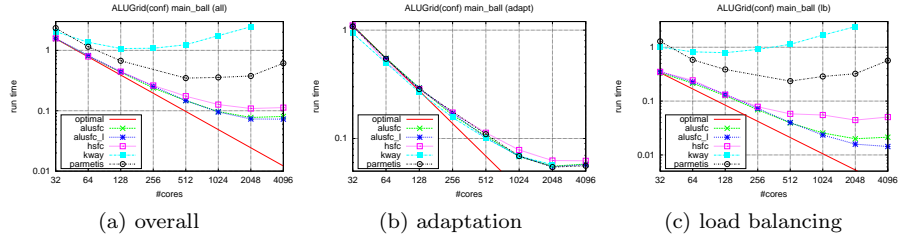

Figure 10: Strong scaling of the ball example for parameter 314 using a conforming simplex grids: average run time per time step.

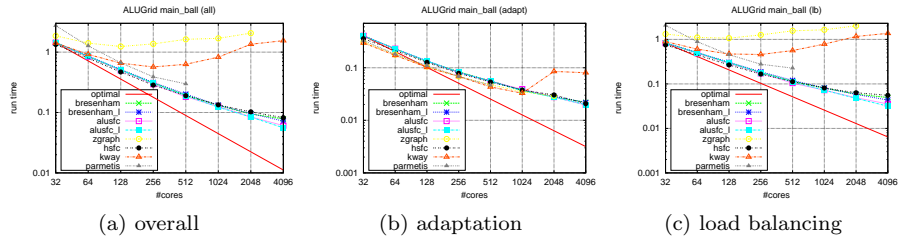

Figure 11: Strong scaling of the ball example for parameter 314 using a non-conforming cube grids: average run time per time step.

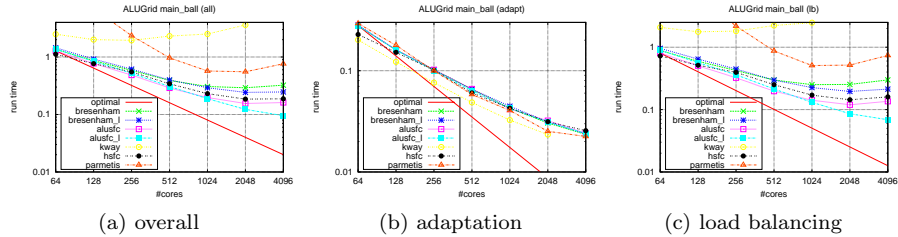

Figure 12: Strong scaling of the ball example for parameter 403 using a non-conforming cube grids: average run time per time step.

efficient in terms of communications effort resulting in faster run times for the adaptation step (see Figure 10b, 11b, and 12b). As a drawback all tested graph partitioning methods fail when the number of elements per core becomes very small. We have to point out that this example is heavily communication based and especially the load balancing step, which is done in every time step, is very communication intensive. So it seems even more impressive that the run times still drop when using 2048 or 4096 cores. As a conclusion the space filling curve approaches seem more suitable for problems with frequent redistribution

of the mesh whereas the graph partitioning methods seem more favorable for production runs on a fixed non-adaptive grid.

3.4 Internal Asynchronous Communication

The linkage of one process with other processes is stored in the `MpAccessLocal` object. The class is responsible for point-to-point communication between a given set of processes. The send and receive implementation is very general, i.e. the sizes of messages to be received is not a priori known. This is necessary because of the mesh adaptation which changes these sizes very frequently. The presented send and receive calls can deal with varying sizes of the message buffers. In order to overlap the communication with the packing and unpacking of data to and from the MPI message buffers the following simple object interface can be passed to `MpAccessLocal` exchange method.

```
class DataHandleIF {
public:
    // method to pack data for given link to MPI message buffer
    virtual void pack( const int link , ObjectStream& os );
    // method to unpack data from MPI message buffer for given link
    virtual void unpack( const int link , ObjectStream& os );
    // should contain work that could be done between send and receive
    virtual void localComputation ();
};
```

The class `ObjectStream` is an implementation of a stream class mainly providing a read and write method. Internally, a `char*` buffer is filled which is later passed to the corresponding MPI routines as message buffer. Note that `ObjectStream` is also the message buffer passed to the `DataHandleIF` when using the DUNE grid communication interface.

```
class ObjectStream {
public:
    // write object T to buffer (T is required to implement the operator= correctly)
    template <class T> void write( const T& value );

    // read object T from buffer (T is required to implement the operator= correctly)
    template <class T> void read( T& value );
};
```

The implementation of the exchange method of the `MpAccessLocal` class looks like this

```
void MpAccessLocal :: exchange( DataHandleIF& data )
{
    // pack data to MPI buffers and post MPI_Isend
    packAndSend( data );

    // do some local work between send and receive if possible
    data.localComputation ();

    // receive message, unpack, and wait for the above posted send messages
    receiveAndUnpack( data );
}
```

The `MpAccessLocal` objects holds two sets, the set of ranks \mathcal{L}_p^s messages are sent to and the set of ranks \mathcal{L}_p^r messages are received from. We call the communi-

ation symmetric if $\mathcal{L}_p^s = \mathcal{L}_p^r$. Asymmetric communication occurs, for example, during the load balancing, where the list of send and receive ranks can differ. Using these set the corresponding methods `packAndSend` and `receiveAndUnpack` are briefly explained in Algorithm 4 and 5, respectively. In the following \mathcal{E}_q denotes the local set of entities with linkage to rank q .

Algorithm 4 `packAndSend`

```

1: for  $q \in \mathcal{L}_p^s$  do
2:   for  $e \in \mathcal{E}_q$  do
3:     packData(  $e, q$  ) { pack data to MPI message buffer }
4:   end for
5:   MPI_Isend(  $q$  ) { send data in message buffer to rank  $q$  }
6: end for

```

Algorithm 5 `receiveAndUnpack`

```

1: for  $q \in \mathcal{L}_p^r$  do
2:    $r_q \leftarrow 0$ 
3: end for
4:  $n_r \leftarrow 0$ 
5: while  $n_r < |\mathcal{L}_p^r|$  do
6:   for  $q \in \mathcal{L}_p^r$  do
7:     if  $r_q = 0$  then
8:        $r_q \leftarrow \text{MPI_Iprobe}( q )$  { check if message is available }
9:       if  $r_q = 1$  then
10:        MPI_Getcount(  $q$  ) { resize buffer for given received size, note
        that by using MPI_Recv only one receive message buffer at the
        time is needed }
11:        MPI_Recv(  $q$  ) { receive message from rank  $q$  }
12:        for  $e \in \mathcal{E}_q$  do
13:          unpackData(  $e, q$  ) { unpack data from MPI message buffer }
14:        end for
15:         $n_r \leftarrow n_r + 1$  { increase received counter }
16:       end if
17:     end if
18:   end for
19: end while
20: MPI_Waitall(  $\mathcal{L}_p^s$  ) { wait for all posted Isend to be finished }

```

The implementation of this point-to-point communication allows the overlap of communication with computation in two ways. The pack and send as well as the receive and unpack is done message by message where the packing and unpacking is directly done before or after the corresponding MPI call. If available, between the send and receive process, more computational work can be done via the `localComputation` callback. In DUNE-ALUGRID this is, for example,

used during the load balancing step where the local macro mesh is prepared for insertion of new element during the `packAndSend` and the `receiveAndUnpack` step. Note that the implementation of Algorithm 5 could also be done using a combination of `MPI_Probe`, `MPI_Irecv` and `MPI_Test_Any`. In our examples we did not see any significant difference on Yellowstone [1]. The advantage of the current implementation is that only one message buffer is required during the `receiveAndUnpack` step. Nevertheless, the implementation of the `packAndSend` and `receiveAndUnpack` can be changed very easily without invasive changes in the DUNE-ALUGRID code base and therefore allows flexible adaptation to future hardware and message passing implementations.

We also want to point out that the performance and benefit of asynchronous communication varies from system to system and from MPI implementation to MPI implementation as investigated in [33].

3.5 The Native Macro-Grid File Format

As a standalone library, ALUGRID has always had a native file format for distributed macro grids. However, this format has been changed for DUNE-ALUGRID to better reflect the internal structure of the ALUGRID code. This section documents the new file format.

Macro grid files for ALUGRID 1.52 can be converted to the new format using the `convert` utility in `utils/convert-macrogrid`. This program can also convert between different versions of the new format as well as files in the DUNE grid format (DGF).

For its native format, DUNE-ALUGRID expects one macro grid file per process, each containing a description of a partition of the macro grid without ghost elements. To make the data encoding as flexible as possible, each file starts with a single ASCII line, terminated by a carriage return, in the following format:

!ALU *key*₁=*value*₁ ... *key*_{*n*}=*value*_{*n*}

The case-sensitive (key,value) pairs describe the representation of the macro grid. Currently, the following keys are supported:

Key	Possible Values	Description
<code>version</code>	Positive Integers	format version (currently 1)
<code>type</code>	<code>hexahedra</code> , <code>tetrahedra</code>	type of grid elements
<code>format</code>	<code>ascii</code> , <code>binary</code> , <code>zbinary</code>	format of data encoding
<code>byteorder</code>	<code>bigendian</code> , <code>littleendian</code>	byte order in binary format
<code>size</code>	Non-negative integers	number of bytes following

Currently, the `version` of the file format is 1; all further information applies solely to this version. The fields `version`, `type`, and `format` are mandatory for all macro grids. If `format` is `binary` or `zbinary`, also the `size` must be specified. If `byteorder` is not specified, the machine's native byte order is assumed.

For all three formats, the structure of the macro grid is shown in Table 4. In `ascii` format, white space is used to separate the fields. If the format is `zbinary`, the binary data is compressed using `zlib` [18].

Table 4: Structure of Macro Grid Representation in Native File Format

Data Type	Description
int	number <i>nv</i> of vertices known to the partition
pair < int , double [3]>[<i>nv</i>]	vertices (global id, position)
int	number <i>ne</i> of elements
int [<i>ce</i>][<i>ne</i>]	elements
int	number <i>np</i> of periodic boundaries
int	number <i>nb</i> of non-periodic boundaries
pair < int [<i>cf</i>], int [<i>cf</i>]>[<i>np</i>]	periodic boundary segments (face, face)
pair < int , int [<i>cf</i>]>[<i>nb</i>]	non-periodic boundary segments (-id, face) if id is missing then -211 (interior) is assumed
int	number <i>p</i> of linkage patterns (connections to other processes) 0 if no linkage pattern is stored
int [<i>links</i>][<i>p</i>]	vector of length <i>links</i> holding rank info for linkage pattern
int	flag <i>el</i> $\in \{0, 1\}$ if vertex-element linkage is stored
pair < int , int , <i>el</i> [...]>	vertex index and position of linkage pattern and if <i>el</i> = 1 then also the vertex-element linkage of this vertex
-1	termination of vertex list

ce: number of corners per element (4 for tetrahedra, 8 for hexahedra)
cf: number of corners per face (3 for tetrahedra, 4 for hexahedra)

The `convert` is also able to pre-distribute a macro grid into a given number of partitions. This might be very helpful when using macro grids with a large number of elements that might not fit into the memory of a single core. All the serial partitioning methods described in Section 2.7 are available.

4 Conclusions

In this paper we briefly described the main new features available in the overhaul of DUNE-ALUGRID. The main improvements concern the parallel feature set of the library, including now user defined load balancing and parallel grid construction as well as decreased the memory footprint. Since ALUGRID is and was widely used within the DUNE community we expect that numerous DUNE users will benefit from work presented here. We also presented a number of extensions to the DUNE grid interface that prove useful and will hopefully be integrated into the DUNE grid interface in the future.

The increased feature set also includes newest vertex bisection for tetrahedral grids in 3d, making it the only parallel grid manager within DUNE with this

feature. This will enable the usage of conforming adaptive discretization methods, such as conforming adaptive Finite Elements, in parallel. Nevertheless, there are some shortcomings that still have to be resolved in the future.

4.1 Shortcomings and Outlook

A major drawback of the current implementation is that load balancing is performed solely based on the macro grid. This works fine for many problems where the refinement zones are not too restricted to one area of the domain, but will completely fail for very local refinement regions. As already mentioned, the situation can be improved by using a hybrid parallelization approach. But the next major improvement will be the implementation of a more flexible partitioning of elements allowing for partitioning of various sets of elements. Furthermore, the current implementation lacks the support for ghost elements when bisection refinement is used. This is hopefully fixed in the near future. An ongoing effort is the parallelization of the 2d version of DUNE-ALUGRID.

Acknowledgements

We would like to acknowledge high-performance computing support from Yellowstone [1] provided by NCAR's Computational and Information Systems Laboratory, sponsored by the National Science Foundation. Robert Klöfkorn acknowledges the DOE BER Program under the award DE-SC0006959.

References

- [1] Computational and Information Systems Laboratory. 2012. Yellowstone: IBM iDataPlex System (Climate Simulation Laboratory). Boulder, CO: National Center for Atmospheric Research. <http://n2t.net/ark:/85065/d7wd3xhc>.
- [2] Th. Albrecht, A. Dedner, M. Lüthi, and Th. Vetter. Finite Element Surface Registration Incorporating Curvature, Volume Preservation, and Statistical Model Information. *Comp. Math. Methods in Medicine*, 2013, 2013.
- [3] M. Bader. *Space-Filling Curves - An Introduction with Applications in Scientific Computing*, volume 9 of *Texts in Computational Science and Engineering*. Springer-Verlag, 2013.
- [4] P. Bastian, M. Blatt, A. Dedner, C. Engwer, R. Klöfkorn, R. Kornhuber, M. Ohlberger, and O. Sander. A Generic Grid Interface for Parallel and Adaptive Scientific Computing. Part II: Implementation and Tests in DUNE. *Computing*, 82(2–3):121–138, 2008. <http://www.dune-project.org>.

- [5] P. Bastian, M. Blatt, A. Dedner, C. Engwer, R. Klöfkorn, M. Ohlberger, and O. Sander. A Generic Grid Interface for Parallel and Adaptive Scientific Computing. Part I: Abstract Framework. *Computing*, 82(2–3):103–119, 2008. <http://www.dune-project.org>.
- [6] T. Betcke, A. Dedner, D. Holder, M. Jehl, and R. Klöfkorn. A Fast Parallel Solver for the Forward Problem in Electrical Impedance Tomography. *Trans. Bio. Med. Eng.*, 2014. (accepted).
- [7] E. G. Boman, U. V. Catalyurek, C. Chevalier, and K. D. Devine. The Zoltan and Isorropia parallel toolkits for combinatorial scientific computing: Partitioning, ordering, and coloring. *Scientific Programming*, 20(2), 2012. <http://www.cs.sandia.gov/zoltan/>.
- [8] S. Brdar, M. Baldauf, A. Dedner, and R. Klöfkorn. Comparison of dynamical cores for NWP models: comparison of COSMO and DUNE. *Theoretical and Computational Fluid Dynamics*, 27(3-4):453–472, 2013.
- [9] J. Bresenham. A Linear Algorithm for Incremental Digital Display of Circular Arcs. *Commun. ACM*, 20(2):100–106, 1977.
- [10] A. Burri, A. Dedner, R. Klöfkorn, and M. Ohlberger. An efficient implementation of an adaptive and parallel grid in dune. In E. Krause et al., editor, *Computational Science and High Performance Computing II*, volume 91, pages 67–82. Springer, 2006.
- [11] C. Burstedde, L.C. Wilcox, and O. Ghattas. **p4est**: Scalable algorithms for parallel adaptive mesh refinement on forests of octrees. *SIAM Journal on Scientific Computing*, 33(3):1103–1133, 2011. <http://www.p4est.org/>.
- [12] A. Dedner and R. Klöfkorn. A Generic Stabilization Approach for Higher Order Discontinuous Galerkin Methods for Convection Dominated Problems. *J. Sci. Comput.*, 47(3):365–388, 2011.
- [13] A. Dedner, R. Klöfkorn, M. Nolte, and M. Ohlberger. A Generic Interface for Parallel and Adaptive Scientific Computing: Abstraction Principles and the DUNE-FEM Module. *Computing*, 90(3–4):165–196, 2010. <http://www.dune-project.org/fem/index.html>.
- [14] A. Dedner, C. Rohde, B. Schupp, and M. Wesenberg. A parallel, load balanced MHD code on locally adapted, unstructured grids in 3D. *Comput. Vis. Sci.*, 7(2):79–96, 2004.
- [15] B. Faigle. *Adaptive modelling of compositional multi-phase flow with capillary pressure*. PhD thesis, Universität Stuttgart, 2014. <http://elib.uni-stuttgart.de/opus/volltexte/2014/9068/>.
- [16] A. Fallahi and B. Oswald. The element level time domain (eltd) method for the analysis of nano-optical systems: Ii. dispersive media. *Photonics and Nanostructures - Fundamentals and Applications*, 10(2):223 – 235, 2012.

- [17] W. Frings, F. Wolf, and V. Petkov. Scalable massively parallel I/O to task-local files. In *Proceedings of the Conference on High Performance Computing Networking, Storage and Analysis*, SC '09, pages 17:1–17:11, New York, NY, USA, 2009. ACM. http://www.fz-juelich.de/ias/jsc/EN/Expertise/Support/Software/SIONlib/_node.html.
- [18] J.-L. Gailly and M. Adler. zlib – A Massively Spiffy Yet Delicately Unobtrusive Compression Library. <http://www.zlib.net/>.
- [19] Th. Geßner and D. Kröner. Dynamic mesh adaption for supersonic reactive flow. In H. Freisthler and G. Warnecke, editors, *Hyperbolic Problems: Theory, Numerics, Applications*, volume 140 of *International Series of Numerical Mathematics*, pages 415–424. Birkhuser Basel, 2001.
- [20] G. Karypis and V. Kumar. A fast and highly quality multilevel scheme for partitioning irregular graphs. *SIAM J. Sci. Comput.*, 20(1):359–392, 1999. <http://glaros.dtc.umn.edu/gkhome/metis/metis/overview>.
- [21] R. Klöforn. *Numerics for Evolution Equations — A General Interface Based Design Concept*. PhD thesis, Albert-Ludwigs-Universität Freiburg, 2009. <http://www.freidok.uni-freiburg.de/volltexte/7175/>.
- [22] R. Klöforn. Efficient Matrix-Free Implementation of Discontinuous Galerkin Methods for Compressible Flow Problems. In A. Handlovicova et al., editor, *Proceedings of the ALGORITMY 2012*, pages 11–21, 2012.
- [23] R. Klöforn and M. Nolte. Solving the Reactive Compressible Navier-Stokes Equations in a Moving Domain. In K. Binder, G. Münster, and M. Kremer, editors, *NIC Symposium 2014 - Proceedings*, volume 47. John von Neumann Institute for Computing Jülich, 2014.
- [24] D. Kröner. *Numerical Schemes for Conservation Laws*. Wiley-Teubner, 1997.
- [25] D. Lea. A memory allocator. *Unix/Mail*, 1996. <http://g.oswego.edu/dl/html/malloc.html>.
- [26] C.P. May. *Realistic simulation of semiconductor nanostructures*. PhD thesis, Eidgenössische Technische Hochschule ETH Zürich, 2009. <http://dx.doi.org/10.3929/ethz-a-006092601>.
- [27] E.H. Müller and R. Scheichl. Massively parallel solvers for elliptic partial differential equations in numerical weather and climate prediction. *Q.J.R. Meteorol. Soc.*, 2014.
- [28] S. Müthing and P. Bastian. Dune-Multidomaingrid: A Metagrid Approach to Subdomain Modeling. In A. Dedner, B. Flemisch, and R. Klöforn, editors, *Advances in DUNE*, pages 59–73. Springer Berlin Heidelberg, 2012.

- [29] K. Schloegel, G. Karypis, and V. Kumar. Parallel static and dynamic multi-constraint graph partitioning. *Concurrency and Computation: Practice and Experience*, 14(3):219 – 240, 2002. <http://glaros.dtc.umn.edu/gkhome/metis/parmetis/overview>.
- [30] A. Schmidt and K. G. Siebert. *Design of Adaptive Finite Element Software – The Finite Element Toolbox ALBERTA*. Springer, 2005.
- [31] B. Schupp. *Entwicklung eines effizienten Verfahrens zur Simulation kompressibler Strömungen in 3D auf Parallelrechnern*. Doctoral Dissertation (in German), Albert-Ludwigs-Universität Freiburg, 1999. <http://www.freidok.uni-freiburg.de/volltexte/68/>.
- [32] E. Toro. *Riemann Solvers and Numerical Methods for Fluid Dynamics*. Springer, 2009.
- [33] M. Wittmann, G. Hager, Th. Zeiser, and G. Wellein. Asynchronous MPI for the Masses. *CoRR*, abs/1302.4280, 2013.